

Partial FCC Test Report

(PART 90)

Report No.: RF190326C26A

FCC ID: B94HNC04PK

Test Model: HSN-C04C

Received Date: Apr. 09, 2019

Test Date: Apr. 13, 2019 ~ Apr. 22, 2019

Issued Date: May 09, 2019

Applicant: HP Inc.

Address: 3390 East Harmony Road, Fort Collins Colorado, 80528 United States

Issued By: Bureau Veritas Consumer Products Services (H.K.) Ltd., Taoyuan Branch

Lab Address: No. 47-2, 14th Ling, Chia Pau Vil., Lin Kou Dist., New Taipei City, Taiwan
(R.O.C)

Test Location : B2F., No.215, Sec. 3, Beixin Rd., Xindian Dist., New Taipei City 231,
Taiwan, R.O.C

**FCC Registration /
Designation Number:** 427177 / TW0011



This report is for your exclusive use. Any copying or replication of this report to or for any other person or entity, or use of our name or trademark, is permitted only with our prior written permission. This report sets forth our findings solely with respect to the test samples identified herein. The results set forth in this report are not indicative or representative of the quality or characteristics of the lot from which a test sample was taken or any similar or identical product unless specifically and expressly noted. Our report includes all of the tests requested by you and the results thereof based upon the information that you provided to us. You have 60 days from date of issuance of this report to notify us of any material error or omission caused by our negligence, provided, however, that such notice shall be in writing and shall specifically address the issue you wish to raise. A failure to raise such issue within the prescribed time shall constitute your unqualified acceptance of the completeness of this report, the tests conducted and the correctness of the report contents. Unless specific mention, the uncertainty of measurement has been explicitly taken into account to declare the compliance or non-compliance to the specification. The report must not be used by the client to claim product certification, approval, or endorsement by TAF or any government agencies

Table of Contents

Release Control Record	3
1 Certificate of Conformity	4
2 Summary of Test Results	5
2.1 Measurement Uncertainty	6
2.2 Test Site and Instruments	7
3 General Information	9
3.1 General Description of EUT	9
3.2 Configuration of System under Test	11
3.2.1 Description of Support Units	11
3.3 Test Mode Applicability and Tested Channel Detail	11
3.4 EUT Operating Conditions	13
3.5 General Description of Applied Standards	13
4 Test Types and Results	14
4.1 Output Power Measurement	14
4.1.1 Limits of Output Power Measurement	14
4.1.2 Test Procedures	14
4.1.3 Test Setup	15
4.1.4 Test Results	16
4.2 Radiated Emission Measurement	21
4.2.1 Limits of Radiated Emission Measurement	21
4.2.2 Test Procedure	21
4.2.3 Deviation from Test Standard	21
4.2.4 Test Setup	22
4.2.5 Test Results	23
5 Pictures of Test Arrangements	45
Appendix – Information of the Testing Laboratories	46

Release Control Record

Issue No.	Description	Date Issued
RF190326C26A	Original Release	May 09, 2019

1 Certificate of Conformity

Product: Tablet
Brand: HP
Test Model: HSN-C04C
Sample Status: Engineering Sample
Applicant: HP Inc.
Test Date: Apr. 13, 2019 ~ Apr. 22, 2019
Standards: FCC Part 90, Subpart S, R
FCC Part 2

The above equipment has been tested by **Bureau Veritas Consumer Products Services (H.K.) Ltd., Taoyuan Branch**, and found compliance with the requirement of the above standards. The test record, data evaluation & Equipment Under Test (EUT) configurations represented herein are true and accurate accounts of the measurements of the sample's RF characteristics under the conditions specified in this report.

Prepared by : Rona Chen, **Date:** May 09, 2019
Rona Chen / Specialist

Approved by : Dylan Chiou, **Date:** May 09, 2019
Dylan Chiou / Project Engineer

2 Summary of Test Results

Applied Standard: FCC Part 90 & Part 2 (LTE 14)			
FCC Clause	Test Item	Result	Remarks
2.1046 90.542 (a)(7)	Effective Radiated Power	Pass	Meet the requirement of limit.
2.1047	Modulation Characteristics	N/A	Refer to Note
2.1055 90.539 (e)	Frequency Stability	N/A	Refer to Note
2.1049	Occupied Bandwidth	N/A	Refer to Note
90.210 (n)	Emission Masks	N/A	Refer to Note
2.1053 90.543 (e)(2)(3)	Band Edge Measurements	N/A	Refer to Note
2.1051 90.543 (e)(3)	Conducted Spurious Emissions	N/A	Refer to Note
2.1053 90.543 (e)(f)	Radiated Spurious Emissions	Pass	Meet the requirement of limit. Minimum passing margin is -18.43 dB at 1586.00 MHz.

Applied Standard: FCC Part 90 & Part 2 (LTE 26)			
FCC Clause	Test Item	Result	Remarks
2.1046 90.635 (b)	Effective Radiated Power	Pass	Meet the requirement of limit.
2.1047	Modulation Characteristics	N/A	Refer to Note
2.1055 90.213	Frequency Stability	N/A	Refer to Note
2.1049 90.209	Occupied Bandwidth	N/A	Refer to Note
2.1051 90.210	Emission Masks	N/A	Refer to Note
2.1051 90.691	Conducted Spurious Emissions	N/A	Refer to Note
2.1053 90.691	Radiated Spurious Emissions	Pass	Meet the requirement of limit. Minimum passing margin is -36.29 dB at 2457.00 MHz.

Note:

- This report is a partial report. Therefore, only test item of Effective Radiated Power and Radiated Spurious Emissions tests were performed for this report. Other testing data please refer to SGS report no.: SZEM180500437001 for module (Brand: Fibocom, Model: L860-GL)
- Determining compliance based on the results of the compliance measurement, not taking into account measurement instrumentation uncertainty.

2.1 Measurement Uncertainty

Where relevant, the following measurement uncertainty levels have been estimated for tests performed on the EUT as specified in CISPR 16-4-2:

Measurement	Frequency	Expanded Uncertainty (k=2) (±)
Radiated Emissions up to 1 GHz	9 kHz ~ 30 MHz	3.0400 dB
	30 MHz ~ 200 MHz	2.0153 dB
	200 MHz ~ 1000 MHz	2.0224 dB
Radiated Emissions above 1 GHz	1 GHz ~ 18 GHz	1.0121 dB
	18 GHz ~ 40 GHz	1.1508 dB

2.2 Test Site and Instruments

Description & Manufacturer	Model No.	Serial No.	Date of Calibration	Due Date of Calibration
Test Receiver Agilent Technologies	N9038A	MY52260177	Aug. 20, 2018	Aug. 19, 2019
Spectrum Analyzer ROHDE & SCHWARZ	FSU43	100115	Jan. 21, 2019	Jan. 20, 2020
Spectrum Analyzer ROHDE & SCHWARZ	FSW26	102023	Oct. 11, 2018	Oct. 10, 2019
BILOG Antenna SCHWARZBECK	VULB9168	9168-616	Nov. 27, 2018	Nov. 26, 2019
HORN Antenna ETS-Lindgren	3117	00143293	Nov. 25, 2018	Nov. 24, 2019
HORN Antenna SCHWARZBECK	BBHA 9120D	9120D-969	Nov. 25, 2018	Nov. 24, 2019
Fixed Attenuator Mini-Circuits	MDCS18N-10	MDCS18N-10-01	Apr. 16, 2018	Apr. 15, 2019
			Apr. 15, 2019	Apr. 14, 2020
MXG Vector signal generator Agilent	N5182B	MY53050430	Nov. 19, 2018	Nov. 18, 2019
Preamplifier Agilent	310N	187226	Jun. 19, 2018	Jun. 18, 2019
Preamplifier Agilent	83017A	MY39501357	Jun. 19, 2018	Jun. 18, 2019
RF signal cable ETS-LINDGREN	5D-FB	Cable-CH1-01(RFC -SMS-100-SMS-12 0+RFC-SMS-100-S MS-400)	Jun. 19, 2018	Jun. 18, 2019
RF signal cable ETS-LINDGREN	8D-FB	Cable-CH1-02(RFC -SMS-100-SMS-24)	Jun. 19, 2018	Jun. 18, 2019
Boresight Antenna Fixture	FBA-01	FBA-SIP01	NA	NA
Software BV ADT	E3 8.130425b	NA	NA	NA
Antenna Tower MF	NA	NA	NA	NA
Turn Table MF	NA	NA	NA	NA
Antenna Tower & Turn Table Controller MF	MF-7802	NA	NA	NA
Communications Tester-Wireless Agilent	8960 Series 10	MY53201073	Jun. 28, 2017	Jun. 27, 2019
Radio Communication Analyzer Anritsu	MT8820C	6201300640	Aug. 16, 2017	Aug. 15, 2019
Temperature & Humidity Chamber	GTH-120-40-CP-AR	MAA1306-019	Sep. 05, 2018	Sep. 04, 2019
DC Power Supply Topward	33010D	807748	NA	NA

- Note:
1. The calibration interval of the above test instruments is 12 / 24 months and the calibrations are traceable to NML/ROC and NIST/USA.
 2. The test was performed in HsinTien Chamber 1.
 3. The horn antenna and preamplifier (model: 83017A) are used only for the measurement of emission frequency above 1 GHz if tested.
 4. The IC Site Registration No. is 7450I-1.

3 General Information

3.1 General Description of EUT

Product	Tablet	
Brand	HP	
Test Model	HSN-C04C	
Status of EUT	Engineering Sample	
Power Supply Rating	7.7 Vdc (Li-ion battery) 20 Vdc (Adapter)	
Modulation Type	LTE	QPSK, 16QAM, 64QAM
Frequency Range	LTE Band 14 (Channel Bandwidth: 5 MHz)	790.5 ~ 795.5 MHz
	LTE Band 14 (Channel Bandwidth: 10 MHz)	793 MHz
	LTE Band 26 (Channel Bandwidth: 1.4 MHz)	814.7 ~ 823.3 MHz
	LTE Band 26 (Channel Bandwidth: 3 MHz)	815.5 ~ 822.5 MHz
	LTE Band 26 (Channel Bandwidth: 5 MHz)	816.5 ~ 821.5 MHz
	LTE Band 26 (Channel Bandwidth: 10 MHz)	819 MHz
Max. ERP Power	LTE Band 14 (Channel Bandwidth: 5 MHz)	44.99 mW
	LTE Band 14 (Channel Bandwidth: 10 MHz)	45.36 mW
	LTE Band 26 (Channel Bandwidth: 1.4 MHz)	124.80 mW
	LTE Band 26 (Channel Bandwidth: 3 MHz)	125.83 mW
	LTE Band 26 (Channel Bandwidth: 5 MHz)	127.12 mW
	LTE Band 26 (Channel Bandwidth: 10 MHz)	126.47 mW
Antenna Type	PIFA Antenna	
Accessory Device	Refer to Note as below	
Data Cable Supplied	Refer to Note as below	

Note:

1. The WWAN module (Brand: Fibocom, Model: L860-GL) was installed in EUT.
2. The EUT contains following accessory devices.

Product	Brand	Model	Description
Adapter	AcBel	TPN-AA03	I/P: 100-240 Vac, 50-60 Hz, 1.7 A O/P: 20 Vdc, 3.25 A
Battery	Dynapack	HSTNN-DB9E	7.7 Vdc, 5950 mAh
Keyboard 1	Primax	HSN-P01K	--
Keyboard 2	Cosmo	HSN-C01K	--
BT/WLAN Module	Intel® Wi-Fi 6 AX200	AX200D2WL	--
LTE Module	Fibocom	L860-GL	--

3. The antenna information of End-product is listed as below.

Ant. Type	Manufacturer	Parts Number	WWAN Antenna Gain (dBi)	
			LTE 14	LTE 26
PIFA	INPAQ	Main Antenna: WA-P-LTE15-02-001 (DC330029D20)	-0.92	-1.58
		Aux. Antenna: WA-P-LTE15-02-002 (DC330029D30)		
		WA-P-LTE11-02-003 (DC330029D40)		
		WA-P-LTE11-02-004 (DC330029D50)		

4. The above EUT information is declared by manufacturer and for more detailed features description, please refers to the manufacturer's specifications or user's manual.

3.2 Configuration of System under Test

<Radiated Emission Test>

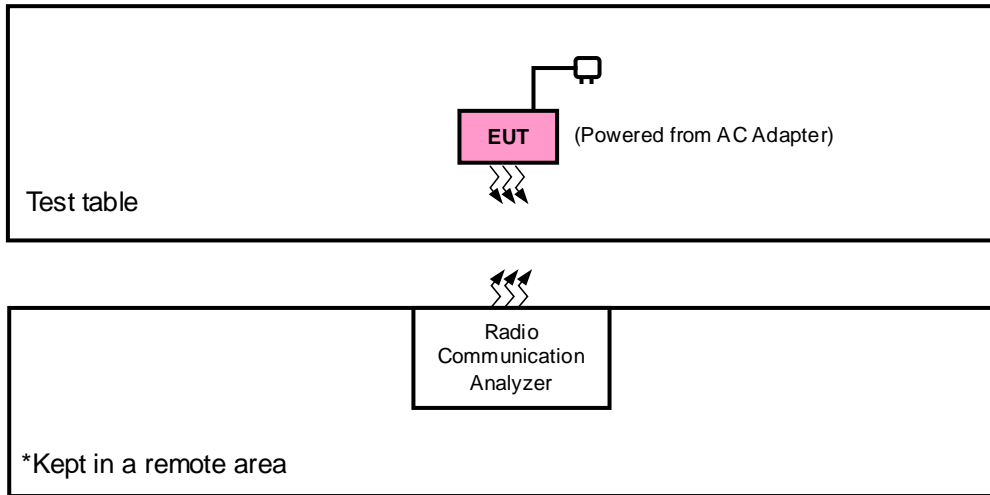

<E.R.P. Test>

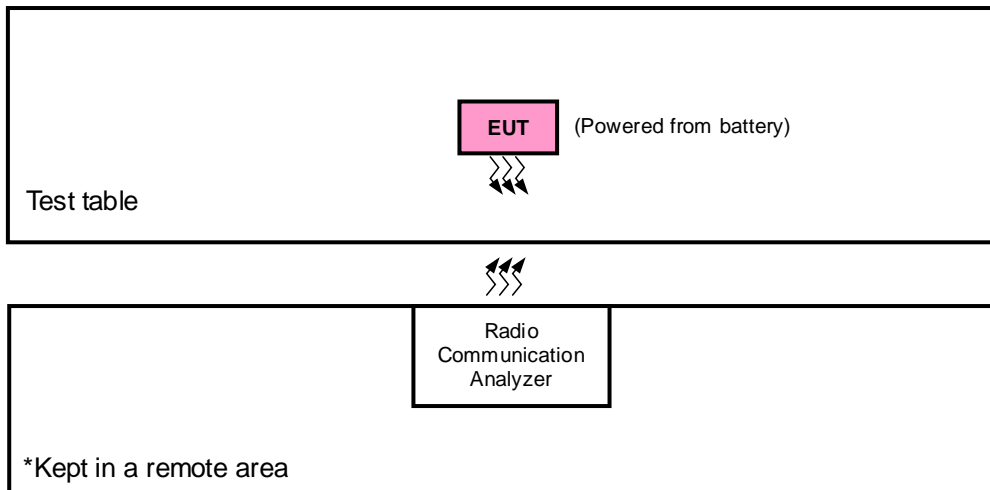

3.2.1 Description of Support Units

The EUT has been tested as an independent unit together with other necessary accessories or support units.

3.3 Test Mode Applicability and Tested Channel Detail

Pre-Scan has been conducted to determine the worst-case mode from all possible combinations between available modulations, data rates, XYZ axis & NB Mode, and antenna ports.

The worst case was found when positioned as the table below. Following channel(s) was (were) selected for the final test as listed below:

Band	ERP	Radiated Emission
LTE Band 14	X-plane	NB Mode
LTE Band 26	X-plane	NB Mode

LTE Band 14

EUT Configure Mode	Test Item	Available Channel	Tested Channel	Channel Bandwidth	Modulation	Mode
-	ERP	23305 to 23355	23305, 23330, 23355	5 MHz	QPSK, 16QAM, 64QAM	1 RB / 0 RB Offset
		23330	23330	10 MHz	QPSK, 16QAM, 64QAM	1 RB / 0 RB Offset
-	Radiated Emission	23305 to 23355	23305, 23330, 23355	5 MHz	QPSK	1 RB / 0 RB Offset
		23330	23330	10 MHz	QPSK	1 RB / 0 RB Offset

Note:

1. This device was tested under all bandwidths, RB configurations and modulations. The worst case was found in QPSK modulation.
2. For radiated emission above 1 GHz, according to 3GPP 36.521 Section 6.6.3.1.4, choose the lowest, 5 MHz & highest channel bandwidth for final test.

LTE Band 26

EUT Configure Mode	Test Item	Available Channel	Tested Channel	Channel Bandwidth	Modulation	Mode
-	ERP	26697 to 26783	26697, 26740, 26783	1.4 MHz	QPSK	1 RB / 5 RB Offset
					16QAM, 64QAM	1 RB / 0 RB Offset
		26705 to 26775	26705, 26740, 26775	3 MHz	QPSK	1 RB / 7 RB Offset
					16QAM, 64QAM	1 RB / 0 RB Offset
		26715 to 26765	26715, 26740, 26765	5 MHz	QPSK	1 RB / 24 RB Offset
					16QAM, 64QAM	1 RB / 0 RB Offset
26740	26740	10 MHz	QPSK, 16QAM	1 RB / 0 RB Offset		
			64QAM	1 RB / 24 RB Offset		
-	Radiated Emission	26697 to 26783	26697, 26740, 26783	1.4 MHz	QPSK	1 RB / 0 RB Offset
		26715 to 26765	26715, 26740, 26765	5 MHz	QPSK	1 RB / 0 RB Offset
		26740	26740	10 MHz	QPSK	1 RB / 0 RB Offset

Note:

1. This device was tested under all bandwidths, RB configurations and modulations. The worst case was found in QPSK modulation.
2. For radiated emission above 1 GHz, according to 3GPP 36.521 Section 6.6.3.1.4, choose the lowest, 5 MHz & highest channel bandwidth for final test.

Test Condition:

Test Item	Environmental Conditions	Input Power	Tested By
ERP	25 deg. C, 65 % RH	7.7 Vdc	Karl Lee
Radiated Emission	25 deg. C, 65 % RH	120 Vac, 60 Hz	Karl Lee

3.4 EUT Operating Conditions

The EUT makes a call to the communication simulator. The communication simulator station system controlled a EUT to export maximum output power under transmission mode and specific channel frequency

3.5 General Description of Applied Standards

The EUT is a RF Product. According to the specifications of the manufacturer, it must comply with the requirements of the following standards:

FCC 47 CFR Part 2

FCC 47 CFR Part 90

KDB 971168 D01 Power Meas License Digital Systems v03r01

KDB 971168 D02 Misc Rev Approv License Devices v02r01

ANSI/TIA/EIA-603-E 2016

ANSI 63.26-2015

Note: All test items have been performed and recorded as per the above standards.

4 Test Types and Results

4.1 Output Power Measurement

4.1.1 Limits of Output Power Measurement

LTE Band 14

Portable stations (hand-held devices) transmitting in the 758-768 MHz band and the 788-798 MHz band are limited to 3 watts ERP.

LTE Band 26

The maximum output power of the transmitter for mobile stations is 100 watts (20 dBw) ERP.

4.1.2 Test Procedures

EIRP / ERP Measurement:

- a. All measurements were done at low, middle and high operational frequency range. RBW and VBW is 10 MHz for LTE mode.
- b. Substitution method is used for E.I.R.P measurement. In the semi-anechoic chamber, EUT placed on the 0.8 m (below or equal 1 GHz) and/or 1.5 m (above 1 GHz) height of Turn Table, rotated the table around 360 degrees to search the maximum radiation power and receiver antenna shall be rotated vertical and horizontal polarization and moved height from 1 m to 4 m to find the maximum polar radiated power. The "Read Value" is the spectrum reading the maximum power value.
- c. The substitution horn antenna is substituted for EUT at the same position and signals generator export the CW signal to the substitution antenna via a tx cable. Rotated the Turn Table and moved receiving antenna to find the maximum radiation power. Adjust output power level of S.G to get a Value of spectrum reading equal to "Read Value" of step b. Record the power level of S.G.
- d. $EIRP = \text{Output power level of S.G} - \text{TX cable loss} + \text{Antenna gain of substitution horn}$. E.R.P power can be calculated form E.I.R.P power by subtracting the gain of dipole, $E.R.P \text{ power} = E.I.P.R \text{ power} - 2.15 \text{ dB}$.

Conducted Power Measurement:

- a. The EUT was set up for the maximum power with LTE link data modulation and link up with simulator.
- b. Set the EUT to transmit under low, middle and high channel and record the power level shown on simulator.

4.1.3 Test Setup

EIRP / ERP Measurement:

<Radiated Emission below or equal 1 GHz>

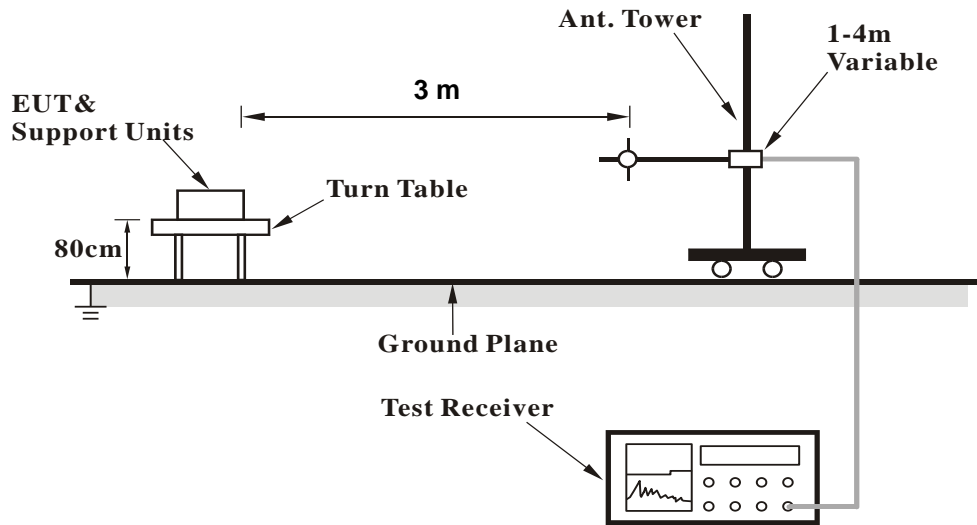

<Radiated Emission above 1 GHz>

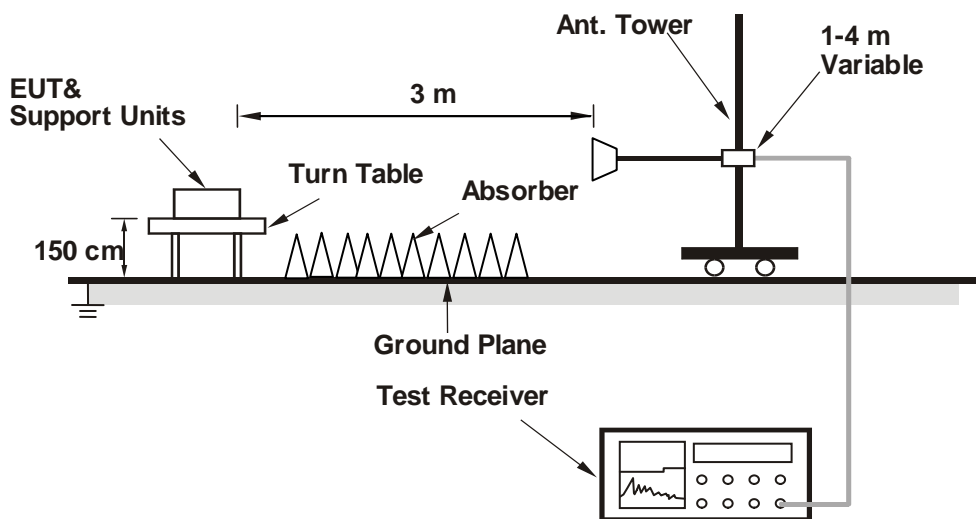

For the actual test configuration, please refer to the attached file (Test Setup Photo).

Conducted Power Measurement:

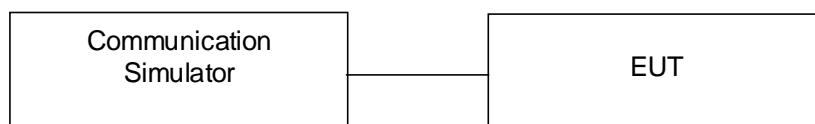

4.1.4 Test Results

Conducted Output Power (dBm)

LTE Band 14															
BW	MCS Index	RB Size	RB Offset	Mid			3GPP MPR (dB)	BW	MCS Index	RB Size	RB Offset	Low	Mid	High	3GPP MPR (dB)
				Channel								23355	23330	23355	
				Frequency (MHz)								793	793	795.5	
10M	QPSK	1	0		22.82		0	5M	QPSK	1	0	22.50	22.71	22.48	0
		1	24		22.78		0			1	12	22.60	22.67	22.58	0
		1	49		22.77		0			1	24	22.59	22.66	22.57	0
		25	0		21.77		1			12	0	21.59	21.66	21.57	1
		25	12		21.75		1			12	6	21.57	21.64	21.55	1
		25	25		21.72		1			12	13	21.54	21.61	21.52	1
	50	0		21.71		1	25		0	21.53	21.60	21.51	1		
	16QAM	1	0		21.81		1		16QAM	1	0	21.48	21.70	21.46	1
		1	24		21.77		1			1	12	21.58	21.66	21.56	1
		1	49		21.76		1			1	24	21.57	21.65	21.55	1
		25	0		20.76		2			12	0	20.57	20.65	20.55	2
		25	12		20.74		2			12	6	20.55	20.63	20.53	2
		25	25		20.71		2			12	13	20.52	20.60	20.50	2
	50	0		20.70		2	25		0	20.51	20.59	20.49	2		
	64QAM	1	0		20.82		2		64QAM	1	0	20.50	20.71	20.48	2
		1	24		20.78		2			1	12	20.60	20.67	20.58	2
		1	49		20.77		2			1	24	20.59	20.66	20.57	2
		25	0		19.77		3			12	0	19.59	19.66	19.57	3
		25	12		19.75		3			12	6	19.57	19.64	19.55	3
		25	25		19.72		3			12	13	19.54	19.61	19.52	3
	50	0		19.71		3	25		0	19.53	19.60	19.51	3		

LTE Band 26															
BW	MCS Index	RB Size	RB Offset	Mid			3GPP MPR (dB)	BW	MCS Index	RB Size	RB Offset	Low	Mid	High	3GPP MPR (dB)
				Channel								26740	26740	26765	
				Frequency (MHz)								819.0	819.0	821.5	
10M	QPSK	1	0		22.76		0	5M	QPSK	1	0	22.72	22.76	22.83	0
		1	24		22.75		0			1	12	22.65	22.75	22.80	0
		1	49		22.61		0			1	24	22.75	22.61	22.79	0
		25	0		21.84		1			12	0	21.67	21.84	21.85	1
		25	12		21.77		1			12	6	21.69	21.77	21.84	1
		25	25		21.62		1			12	13	21.70	21.62	21.80	1
	50	0		21.67		1	25		0	21.66	21.67	21.81	1		
	16QAM	1	0		21.63		1		16QAM	1	0	21.71	21.63	21.81	1
		1	24		21.75		1			1	12	21.65	21.75	21.78	1
		1	49		21.64		1			1	24	21.67	21.64	21.77	1
		25	0		20.75		2			12	0	20.64	20.75	20.83	2
		25	12		20.70		2			12	6	20.66	20.70	20.82	2
		25	25		20.74		2			12	13	20.71	20.74	20.78	2
	50	0		20.72		2	25		0	20.62	20.72	20.79	2		
	64QAM	1	0		20.69		2		64QAM	1	0	20.75	20.69	20.82	2
		1	24		20.59		2			1	12	20.70	20.59	20.79	2
		1	49		20.65		2			1	24	20.72	20.65	20.78	2
		25	0		19.69		3			12	0	19.79	19.69	19.84	3
		25	12		19.74		3			12	6	19.70	19.74	19.83	3
		25	25		19.64		3			12	13	19.59	19.64	19.79	3
	50	0		19.68		3	25		0	19.68	19.68	19.80	3		

BW	MCS Index	RB Size	RB Offset	Low	Mid	High	3GPP MPR (dB)	BW	MCS Index	RB Size	RB Offset	Low	Mid	High	3GPP MPR (dB)
				26705	26740	26775						26697	26740	26783	
				Channel								Frequency (MHz)			
3M	QPSK	1	0	22.65	22.67	22.77	0	1.4M	QPSK	1	0	22.68	22.62	22.77	0
		1	7	22.65	22.62	22.66	0			1	2	22.64	22.63	22.76	0
		1	14	22.67	22.50	22.72	0			1	5	22.60	22.54	22.67	0
		8	0	21.68	21.80	21.81	1			3	0	22.85	22.70	22.71	0
		8	3	21.68	21.62	21.70	1			3	1	22.78	22.63	22.83	0
		8	7	21.70	21.48	21.70	1			3	3	22.65	22.55	22.77	0
	15	0	21.64	21.62	21.72	1	6		0	21.72	21.65	21.79	1		
	16QAM	1	0	21.74	21.62	21.68	1		16QAM	1	0	21.70	21.51	21.79	1
		1	7	21.56	21.74	21.70	1			1	2	21.60	21.74	21.64	1
		1	14	21.64	21.53	21.73	1			1	5	21.72	21.59	21.74	1
		8	0	20.64	20.73	20.72	2			3	0	21.70	21.74	21.77	1
		8	3	20.67	20.65	20.82	2			3	1	21.61	21.63	21.71	1
		8	7	20.72	20.64	20.73	2			3	3	21.66	21.62	21.74	1
	15	0	20.71	20.62	20.72	2	6		0	20.71	20.63	20.75	2		
	64QAM	1	0	20.71	20.60	20.70	2		64QAM	1	0	20.69	20.64	20.79	2
		1	7	20.66	20.46	20.74	2			1	2	20.67	20.55	20.64	2
		1	14	20.61	20.60	20.65	2			1	5	20.69	20.60	20.68	2
		8	0	19.74	19.69	19.78	3			3	0	20.71	20.60	20.79	2
		8	3	19.69	19.64	19.76	3			3	1	20.66	20.72	20.77	2
		8	7	19.60	19.60	19.70	3			3	3	20.64	20.49	20.67	2
	15	0	19.59	19.63	19.80	3	6		0	19.62	19.63	19.65	3		

ERP Power (dBm)

LTE Band 14							
Channel Bandwidth: 5 MHz / QPSK							
Plane	Channel	Frequency (MHz)	Reading (dBm)	Correction Factor (dB)	ERP (dBm)	ERP (mW)	Polarization (H/V)
X	23305	790.5	-14.22	32.771	16.40	43.66	H
	23330	793.0	-14.06	32.741	16.53	44.99	
	23355	795.5	-14.35	32.854	16.35	43.19	
	23305	790.5	-19.02	32.5	11.33	13.58	V
	23330	793.0	-18.89	32.52	11.48	14.06	
	23355	795.5	-19.17	32.62	11.30	13.49	
Channel Bandwidth: 5 MHz / 16QAM							
X	23305	790.5	-15.23	32.771	15.39	34.60	H
	23330	793.0	-15.07	32.741	15.52	35.65	
	23355	795.5	-15.35	32.854	15.35	34.31	
	23305	790.5	-20.03	32.5	10.32	10.76	V
	23330	793.0	-19.89	32.52	10.48	11.17	
	23355	795.5	-20.17	32.62	10.30	10.72	
Channel Bandwidth: 5 MHz / 64QAM							
X	23305	790.5	-16.24	32.771	14.38	27.42	H
	23330	793.0	-16.08	32.741	14.51	28.26	
	23355	795.5	-16.35	32.854	14.35	27.25	
	23305	790.5	-21.04	32.5	9.31	8.53	V
	23330	793.0	-20.90	32.52	9.47	8.85	
	23355	795.5	-21.18	32.62	9.29	8.49	

Note: ERP (dBm) = Reading (dBm) + Correction Factor (dB) – 2.15

LTE Band 14							
Channel Bandwidth: 10 MHz / QPSK							
Plane	Channel	Frequency (MHz)	Reading (dBm)	Correction Factor (dB)	ERP (dBm)	ERP (mW)	Polarization (H/V)
X	23330	793.0	-14.02	32.737	16.57	45.36	H
	23330	793.0	-18.85	32.52	11.52	14.19	V
Channel Bandwidth: 10 MHz / 16QAM							
X	23330	793.0	-15.03	32.737	15.56	35.95	H
	23330	793.0	-19.85	32.52	10.52	11.27	V
Channel Bandwidth: 10 MHz / 64QAM							
X	23330	793.0	-16.04	32.737	14.55	28.49	H
	23330	793.0	-20.86	32.52	9.51	8.93	V

Note: ERP (dBm) = Reading (dBm) + Correction Factor (dB) – 2.15

LTE Band 26							
Channel Bandwidth: 1.4 MHz / QPSK							
Plane	Channel	Frequency (MHz)	Reading (dBm)	Correction Factor (dB)	ERP (dBm)	ERP (mW)	Polarization (H/V)
X	26697	814.7	-8.18	31.208	20.88	122.41	H
	26740	819.0	-8.25	31.3	20.90	123.03	
	26783	823.3	-8.11	31.222	20.96	124.80	
	26697	814.7	-12.53	31.504	16.82	48.13	V
	26740	819.0	-12.11	31.117	16.86	48.50	
	26783	823.3	-12.88	31.922	16.89	48.89	
Channel Bandwidth: 1.4 MHz / 16QAM							
X	26697	814.7	-9.19	31.208	19.87	97.01	H
	26740	819.0	-9.26	31.3	19.89	97.50	
	26783	823.3	-9.12	31.222	19.95	98.90	
	26697	814.7	-13.53	31.504	15.82	38.23	V
	26740	819.0	-13.12	31.117	15.85	38.43	
	26783	823.3	-13.90	31.922	15.87	38.65	
Channel Bandwidth: 1.4 MHz / 64QAM							
X	26697	814.7	-10.20	31.208	18.86	76.88	H
	26740	819.0	-10.26	31.3	18.89	77.45	
	26783	823.3	-10.12	31.222	18.95	78.56	
	26697	814.7	-14.54	31.504	14.81	30.30	V
	26740	819.0	-14.12	31.117	14.85	30.53	
	26783	823.3	-14.90	31.922	14.87	30.70	

Note: ERP (dBm) = Reading (dBm) + Correction Factor (dB) – 2.15

LTE Band 26							
Channel Bandwidth: 3 MHz / QPSK							
Plane	Channel	Frequency (MHz)	Reading (dBm)	Correction Factor (dB)	ERP (dBm)	ERP (mW)	Polarization (H/V)
X	26705	815.5	-8.14	31.208	20.92	123.54	H
	26740	819.0	-8.21	31.3	20.94	124.17	
	26775	822.5	-8.07	31.222	21.00	125.83	
	26705	815.5	-12.49	31.504	16.86	48.57	V
	26740	819.0	-12.08	31.117	16.89	48.83	
	26775	822.5	-12.84	31.922	16.93	49.34	
Channel Bandwidth: 3 MHz / 16QAM							
X	26705	815.5	-9.14	31.208	19.92	98.13	H
	26740	819.0	-9.22	31.3	19.93	98.40	
	26775	822.5	-9.07	31.222	20.00	100.05	
	26705	815.5	-13.50	31.504	15.85	38.49	V
	26740	819.0	-13.09	31.117	15.88	38.70	
	26775	822.5	-13.84	31.922	15.93	39.19	
Channel Bandwidth: 3 MHz / 64QAM							
X	26705	815.5	-10.15	31.208	18.91	77.77	H
	26740	819.0	-10.23	31.3	18.92	77.98	
	26775	822.5	-10.08	31.222	18.99	79.29	
	26705	815.5	-14.51	31.504	14.84	30.51	V
	26740	819.0	-14.10	31.117	14.87	30.67	
	26775	822.5	-14.85	31.922	14.92	31.06	

Note: ERP (dBm) = Reading (dBm) + Correction Factor (dB) – 2.15

LTE Band 26							
Channel Bandwidth: 5 MHz / QPSK							
Plane	Channel	Frequency (MHz)	Reading (dBm)	Correction Factor (dB)	ERP (dBm)	ERP (mW)	Polarization (H/V)
X	26715	816.5	-8.11	31.208	20.95	124.39	H
	26740	819.0	-8.17	31.3	20.98	125.31	
	26765	821.5	-8.03	31.222	21.04	127.12	
	26715	816.5	-12.46	31.504	16.89	48.91	V
	26740	819.0	-12.04	31.117	16.93	49.28	
	26765	821.5	-12.81	31.922	16.96	49.68	
Channel Bandwidth: 5 MHz / 16QAM							
X	26715	816.5	-9.11	31.208	19.95	98.81	H
	26740	819.0	-9.18	31.3	19.97	99.31	
	26765	821.5	-9.04	31.222	20.03	100.74	
	26715	816.5	-13.47	31.504	15.88	38.76	V
	26740	819.0	-13.05	31.117	15.92	39.06	
	26765	821.5	-13.82	31.922	15.95	39.37	
Channel Bandwidth: 5 MHz / 64QAM							
X	26715	816.5	-10.12	31.208	18.94	78.31	H
	26740	819.0	-10.18	31.3	18.97	78.89	
	26765	821.5	-10.05	31.222	19.02	79.84	
	26715	816.5	-14.48	31.504	14.87	30.72	V
	26740	819.0	-14.06	31.117	14.91	30.98	
	26765	821.5	-14.82	31.922	14.95	31.28	

Note: ERP (dBm) = Reading (dBm) + Correction Factor (dB) – 2.15

LTE Band 26							
Channel Bandwidth: 10 MHz / QPSK							
Plane	Channel	Frequency (MHz)	Reading (dBm)	Correction Factor (dB)	ERP (dBm)	ERP (mW)	Polarization (H/V)
X	26740	819.0	-8.13	31.3	21.02	126.47	H
	26740	819.0	-12.00	31.117	16.97	49.74	V
Channel Bandwidth: 10 MHz / 16QAM							
X	26740	819.0	-9.14	31.3	20.01	100.23	H
	26740	819.0	-13.01	31.117	15.96	39.42	V
Channel Bandwidth: 10 MHz / 64QAM							
X	26740	819.0	-10.14	31.3	19.01	79.62	H
	26740	819.0	-14.01	31.117	14.96	31.31	V

Note: ERP (dBm) = Reading (dBm) + Correction Factor (dB) – 2.15

4.2 Radiated Emission Measurement

4.2.1 Limits of Radiated Emission Measurement

- (1) The power of any emission outside a licensee's frequency block shall be attenuated below the transmitter power (P) by at least $43 + 10 \log (P)$ dB. The limit of emission is equal to -13 dBm.
- (2) For operations in the 758-775 MHz and 788-805 MHz bands, all emissions including harmonics in the band 1559-1610 MHz shall be limited to -70 dBW/MHz equivalent isotropically radiated power (EIRP) for wideband signals, and -80 dBW EIRP for discrete emissions of less than 700 Hz bandwidth.

4.2.2 Test Procedure

- a. Substitution method is used for E.I.R.P measurement. In the semi-anechoic chamber, EUT placed on the 0.8 m (below or equal 1 GHz) and/or 1.5 m (above 1 GHz) height of Turn Table, rotated the table around 360 degrees to search the maximum radiation power and receiver antenna shall be rotated vertical and horizontal polarization and moved height from 1 m to 4 m to find the maximum polar radiated power. The "Read Value" is the spectrum reading the maximum power value.
- b. The substitution horn antenna is substituted for EUT at the same position and signals generator export the CW signal to the substitution antenna via a TX cable. Rotated the Turn Table and moved receiving antenna to find the maximum radiation power. Adjust output power level of S.G to get a Value of spectrum reading equal to "Read Value" of step a. Record the power level of S.G.
- c. $EIRP = \text{Output power level of S.G} - \text{TX cable loss} + \text{Antenna gain of substitution horn}$.
- d. E.R.P power can be calculated form E.I.R.P power by subtracting the gain of dipole, $E.R.P \text{ power} = E.I.P.R \text{ power} - 2.15 \text{ dB}$.

Note: The resolution bandwidth of spectrum analyzer is 1 MHz and the video bandwidth is 3 MHz.

4.2.3 Deviation from Test Standard

No deviation.

4.2.4 Test Setup

<Radiated Emission below or equal 1 GHz>

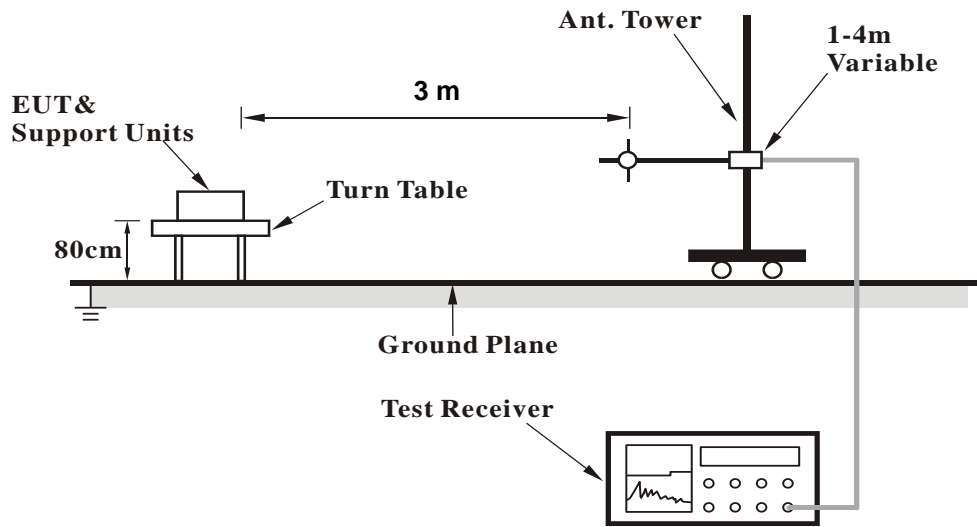

<Radiated Emission above 1 GHz>

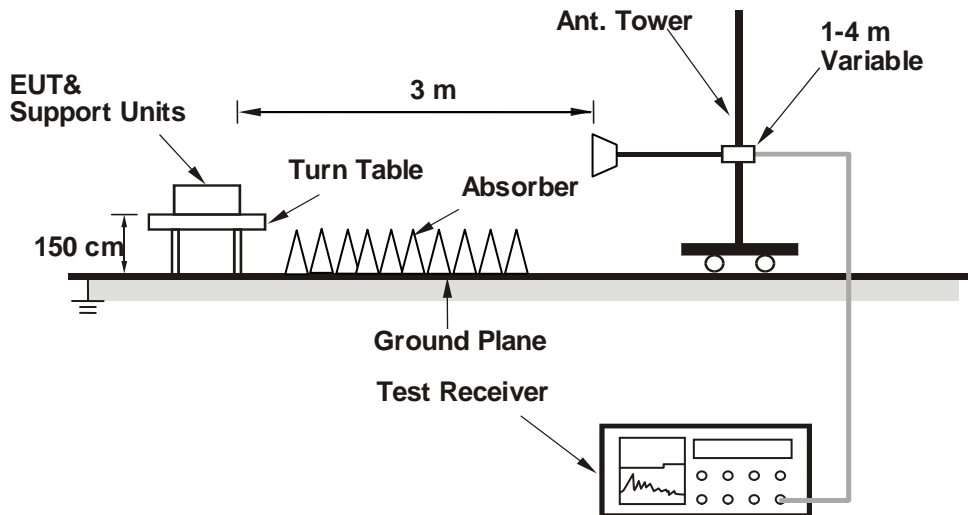

For the actual test configuration, please refer to the attached file (Test Setup Photo).

4.2.5 Test Results

LTE Band 14

Channel Bandwidth: 5 MHz / QPSK

Low Channel



Bureau Veritas Consumer Products Services Ltd., Taoyuan Branch

A D T

Data: 5

Date: 2019-04-18

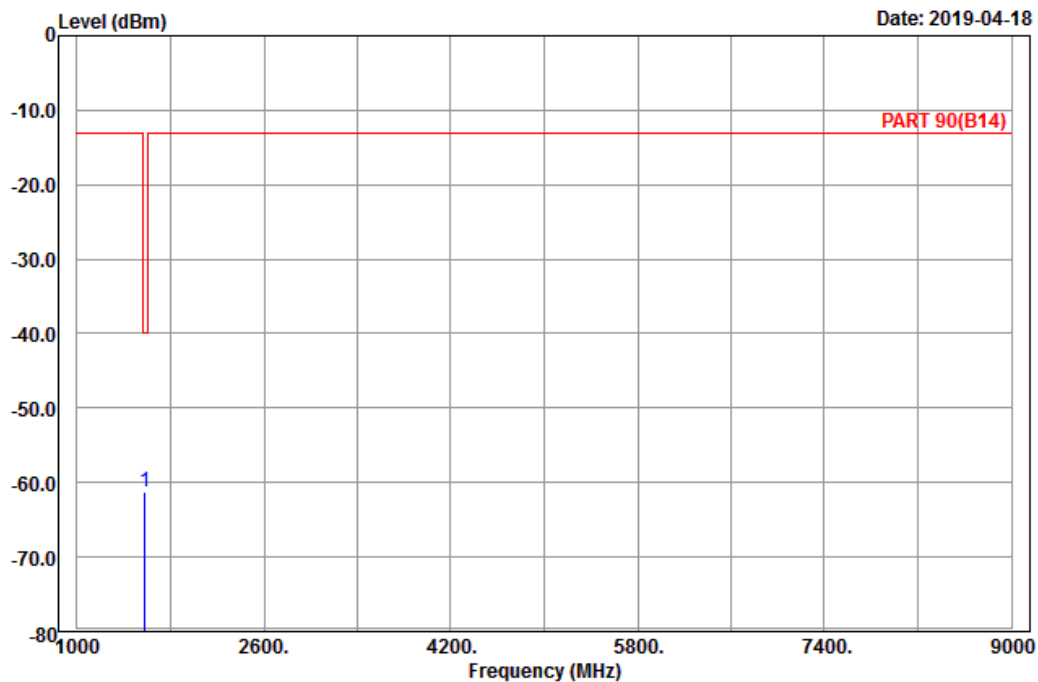

Site : 966 chamber 1
 Condition: PART 90(B14) Horizontal
 Remark : LTE_Band 14_Link_CH23305
 Tested by: Karl Lee

Freq	Level	Read Level	Limit Line	Over Limit	Factor	Remark
MHz	dBm	dBm	dBm	dB	dB	
1 pp 1581.00	-61.26	-68.30	-40.00	-21.26	7.04	Peak



A D T

Data: 6

Date: 2019-04-18

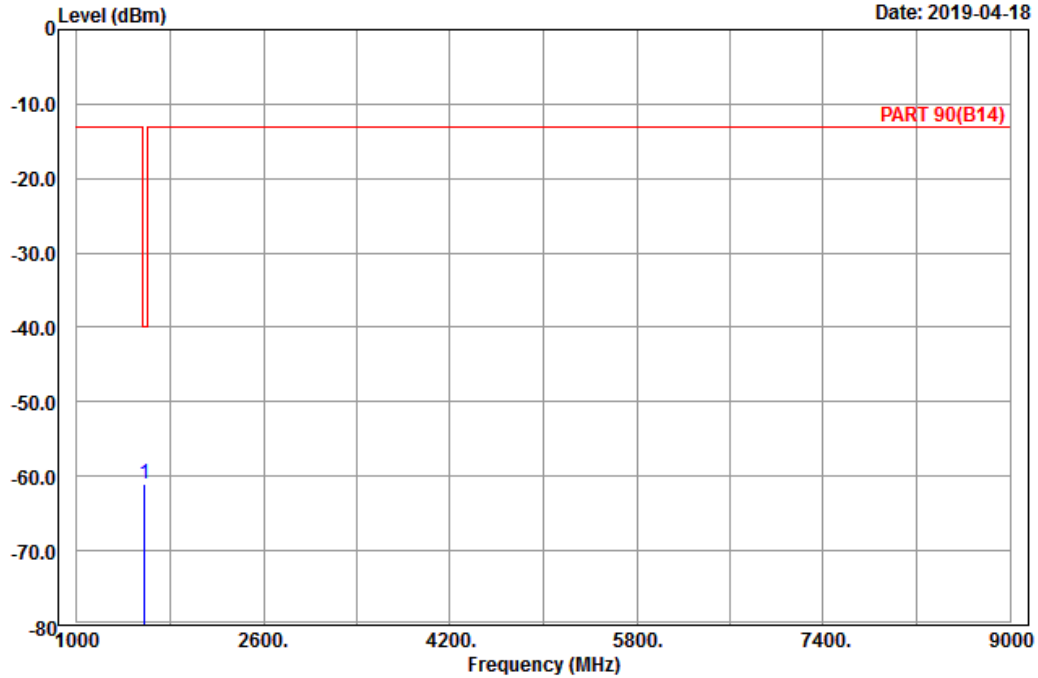

Site : 966 chamber 1
 Condition: PART 90(B14) Vertical
 Remark : LTE_Band 14_Link_CH23305
 Tested by: Karl Lee

	Freq	Level	Read Level	Limit Line	Over Limit	Factor	Remark
	MHz	dBm	dBm	dBm	dB	dB	
1	pp 1581.00	-60.93	-67.97	-40.00	-20.93	7.04	Peak

Middle Channel



Bureau Veritas Consumer Products Services Ltd., Taoyuan Branch

A D T

Data: 5

Date: 2019-04-18

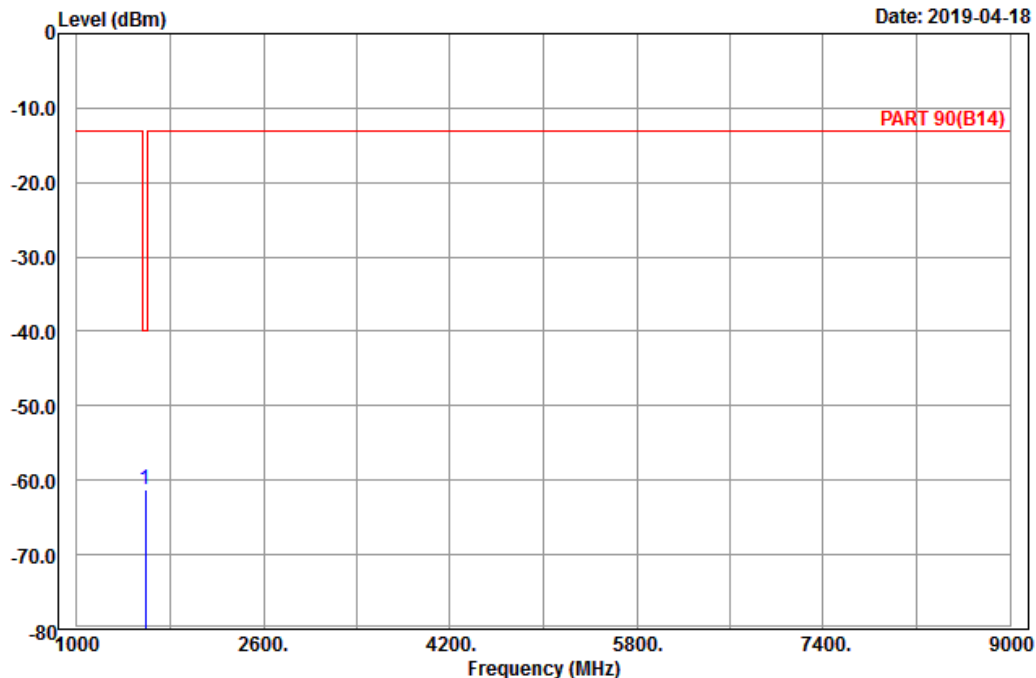

Site : 966 chamber 1
 Condition: PART 90(B14) Horizontal
 Remark : LTE_Band 14_Link_CH23330
 Tested by: Karl Lee

	Freq	Level	Read Level	Limit Line	Over Limit	Factor	Remark
	MHz	dBm	dBm	dBm	dB	dB	
1	pp 1586.00	-61.31	-68.52	-40.00	-21.31	7.21	Peak



A D T

Data: 6

Date: 2019-04-18

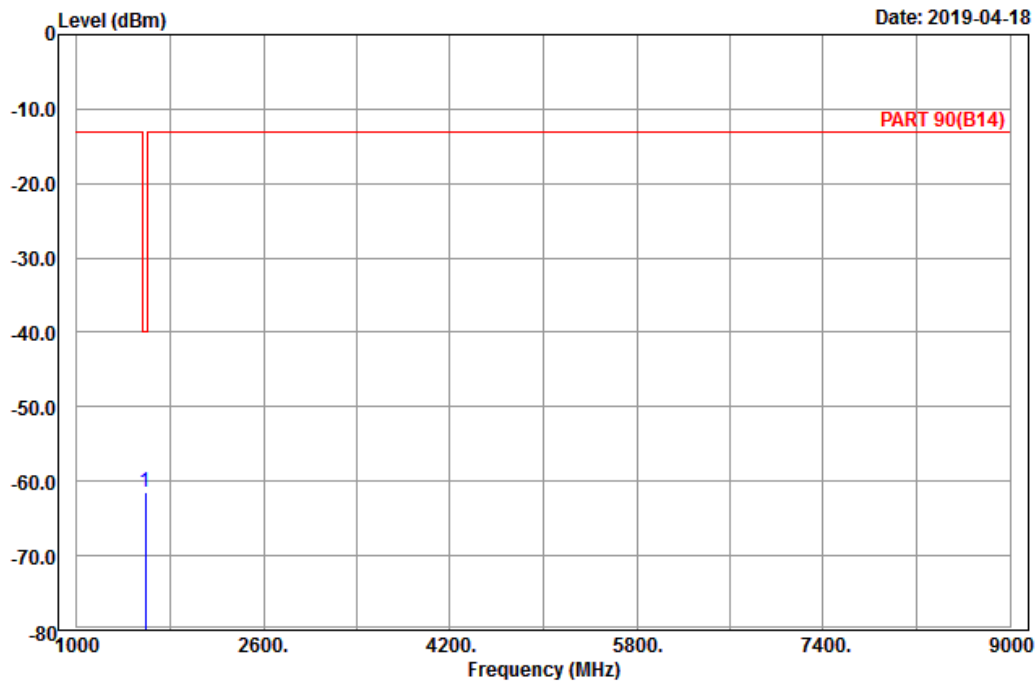

Site : 966 chamber 1
 Condition: PART 90(B14) Vertical
 Remark : LTE_Band 14_Link_CH23330
 Tested by: Karl Lee

	Freq	Level	Read Level	Limit Line	Over Limit	Factor	Remark
	MHz	dBm	dBm	dBm	dB	dB	
1	pp 1585.00	-61.53	-68.57	-40.00	-21.53	7.04	Peak

High Channel



Bureau Veritas Consumer Products Services Ltd., Taoyuan Branch

A D T

Data: 5

Date: 2019-04-18

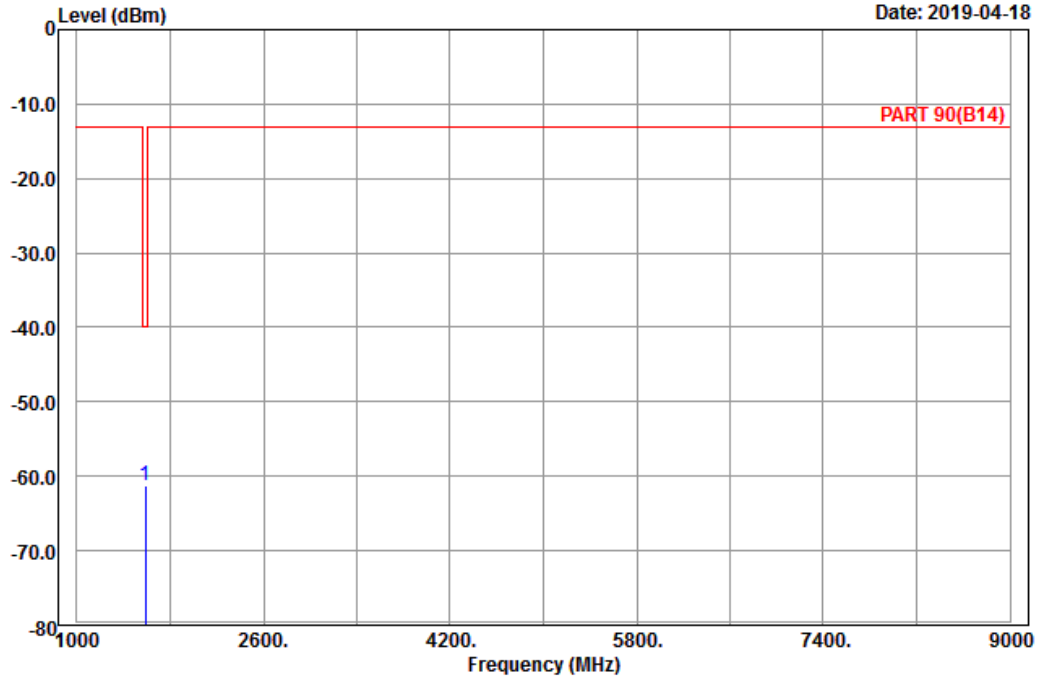

Site : 966 chamber 1
 Condition: PART 90(B14) Horizontal
 Remark : LTE_Band 14_Link_CH23355
 Tested by: Karl Lee

	Freq	Level	Read Level	Limit Line	Over Limit	Factor	Remark
	MHz	dBm	dBm	dBm	dB	dB	
1	pp 1591.00	-61.23	-68.44	-40.00	-21.23	7.21	Peak



A D T

Data: 6

Date: 2019-04-18

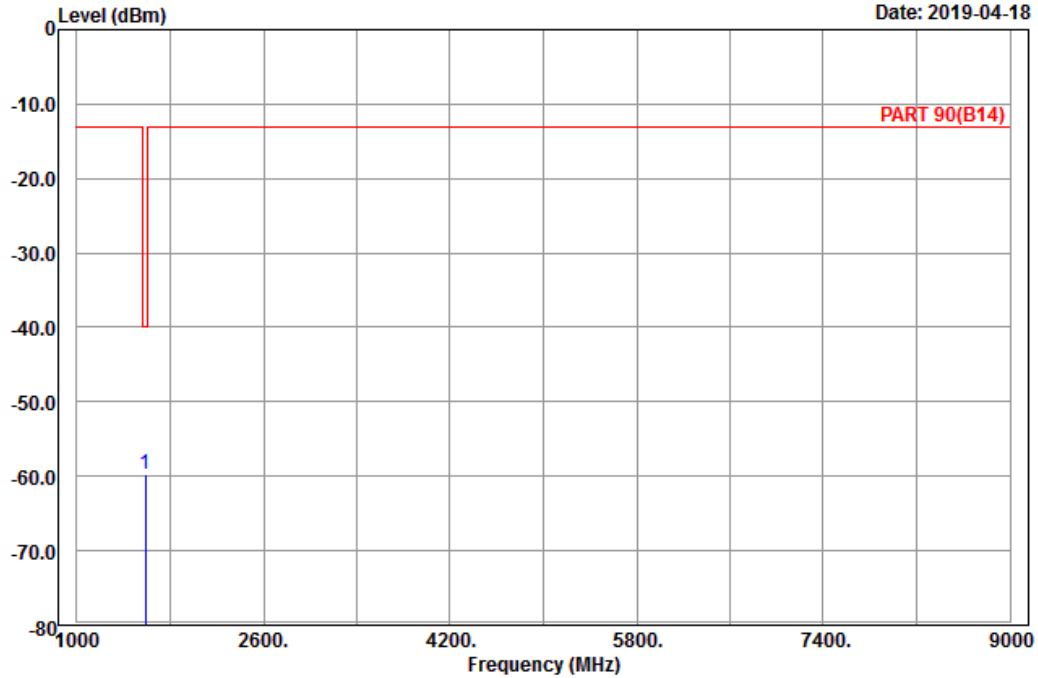

Site : 966 chamber 1
 Condition: PART 90(B14) Vertical
 Remark : LTE_Band 14_Link_CH23355
 Tested by: Karl Lee

	Freq	Level	Read Level	Limit Line	Over Limit	Factor	Remark
	MHz	dBm	dBm	dBm	dB	dB	
1	pp 1591.00	-59.76	-66.97	-40.00	-19.76	7.21	Peak

Channel Bandwidth: 10 MHz / QPSK
Middle Channel



Bureau Veritas Consumer Products Services Ltd., Taoyuan Branch

A D T

Data: 9

Date: 2019-04-18

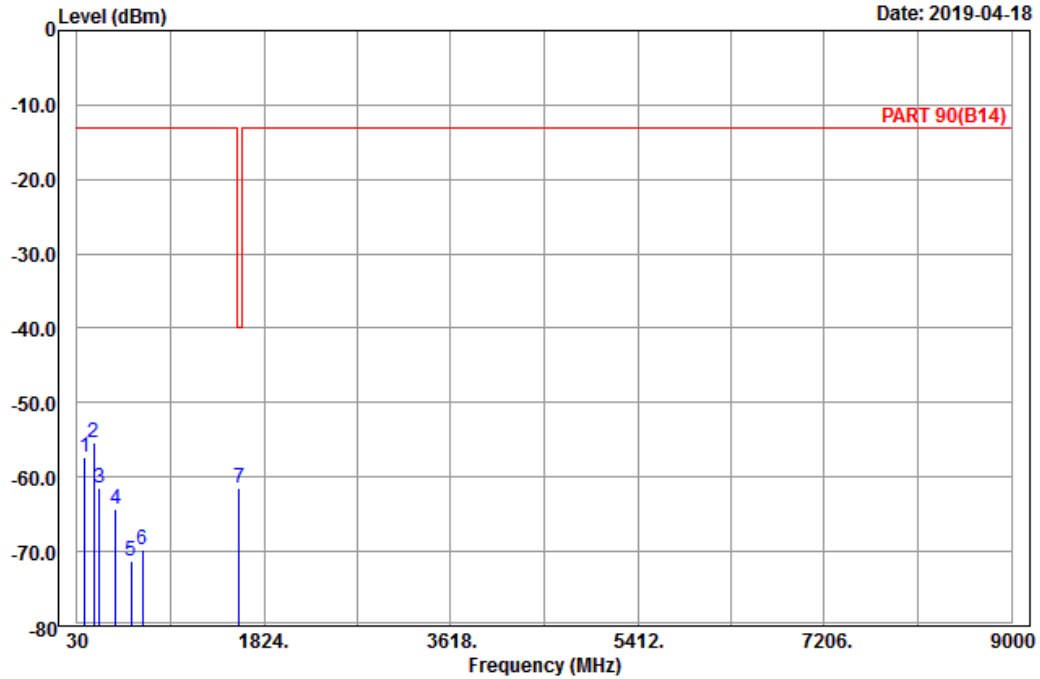

Site : 966 chamber 1
Condition: PART 90(B14) Horizontal
Remark : LTE_Band 14_Link_CH23330
Tested by: Karl Lee

	Freq	Level	Read Level	Limit Line	Over Limit	Factor	Remark
	MHz	dBm	dBm	dBm	dB	dB	
1	101.82	-57.25	-47.36	-13.00	-44.25	-9.89	Peak
2	191.19	-55.41	-49.63	-13.00	-42.41	-5.78	Peak
3	242.76	-61.43	-55.82	-13.00	-48.43	-5.61	Peak
4	398.00	-64.41	-61.57	-13.00	-51.41	-2.84	Peak
5	550.60	-71.29	-69.67	-13.00	-58.29	-1.62	Peak
6	659.80	-69.77	-69.59	-13.00	-56.77	-0.18	Peak
7 pp	1586.00	-61.46	-68.67	-40.00	-21.46	7.21	Peak



A D T

Data: 10

Date: 2019-04-18

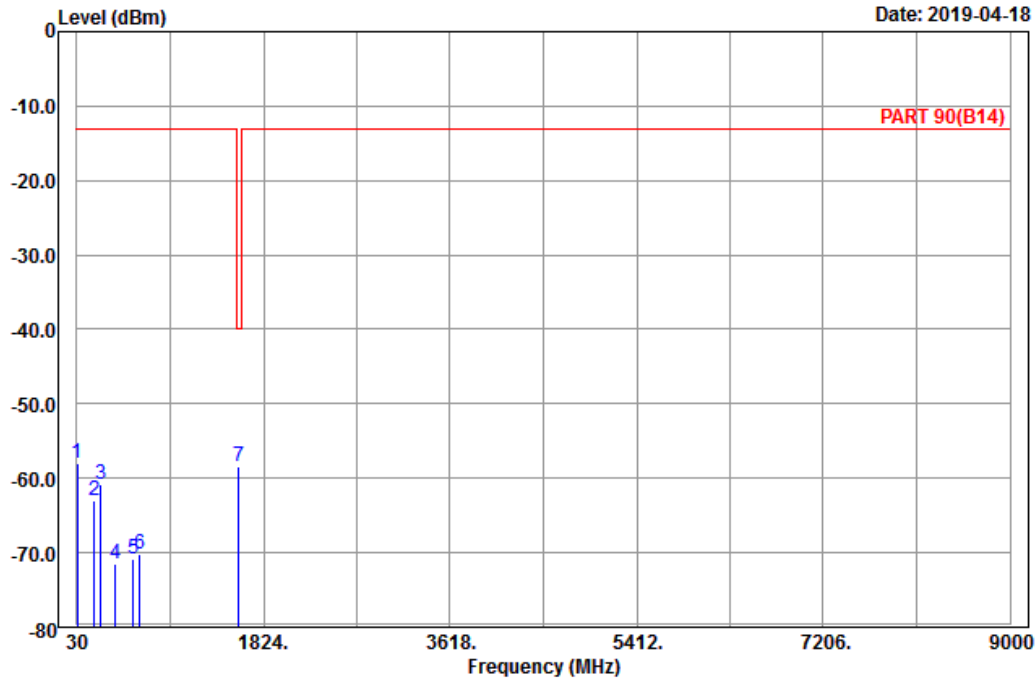

Site : 966 chamber 1
 Condition: PART 90(B14) Vertical
 Remark : LTE_Band 14_Link_CH23330
 Tested by: Karl Lee

	Freq	Level	Read Level	Limit Line	Over Limit	Factor	Remark
	MHz	dBm	dBm	dBm	dB	dB	
1	36.48	-58.07	-47.73	-13.00	-45.07	-10.34	Peak
2	200.64	-63.06	-56.89	-13.00	-50.06	-6.17	Peak
3	262.74	-60.71	-55.09	-13.00	-47.71	-5.62	Peak
4	398.00	-71.51	-68.67	-13.00	-58.51	-2.84	Peak
5	570.90	-70.81	-70.03	-13.00	-57.81	-0.78	Peak
6	637.40	-70.16	-70.17	-13.00	-57.16	0.01	Peak
7 pp	1586.00	-58.43	-65.64	-40.00	-18.43	7.21	Peak

LTE Band 26
 Channel Bandwidth: 1.4 MHz / QPSK
 Low Channel



Bureau Veritas Consumer Products Services Ltd., Taoyuan Branch

A D T

Data: 5

Date: 2019-04-13

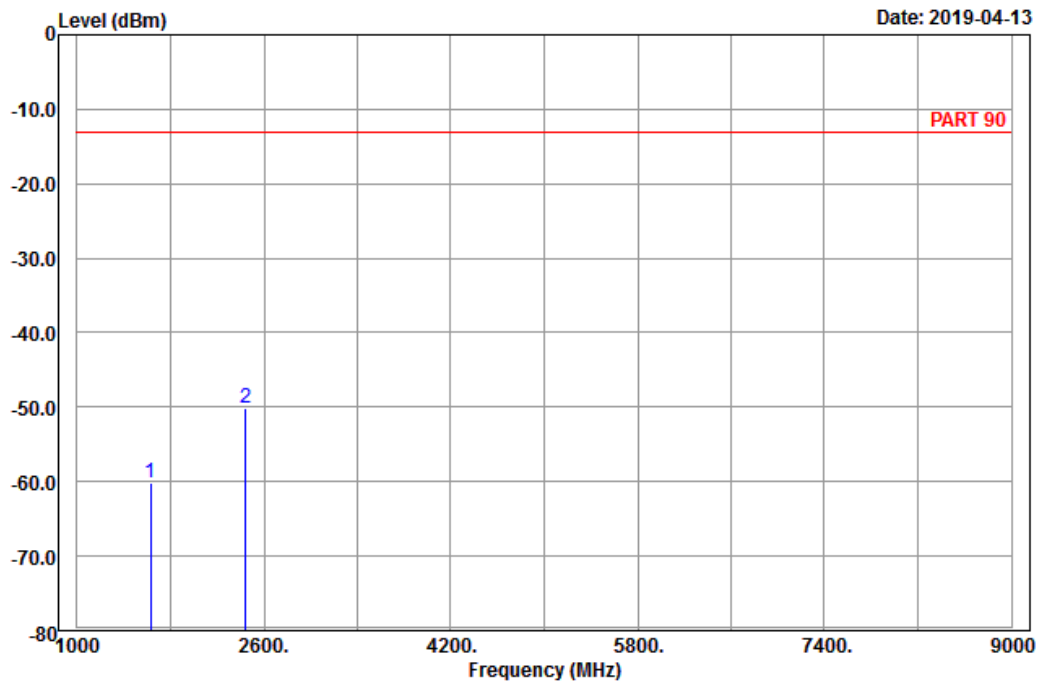

Site : 966 chamber 1
 Condition: PART 90 Horizontal
 Remark : LTE_Band 26_Link_CH26697
 Tested by: Charles Hsiao

	Read	Limit	Over				
Freq	Level	Level	Line	Limit	Factor	Remark	
MHz	dBm	dBm	dBm	dB	dB		
1	1629.40	-60.22	-67.78	-13.00	-47.22	7.56	Peak
2 pp	2444.10	-50.04	-61.04	-13.00	-37.04	11.00	Peak



A D T

Data: 6

Date: 2019-04-13

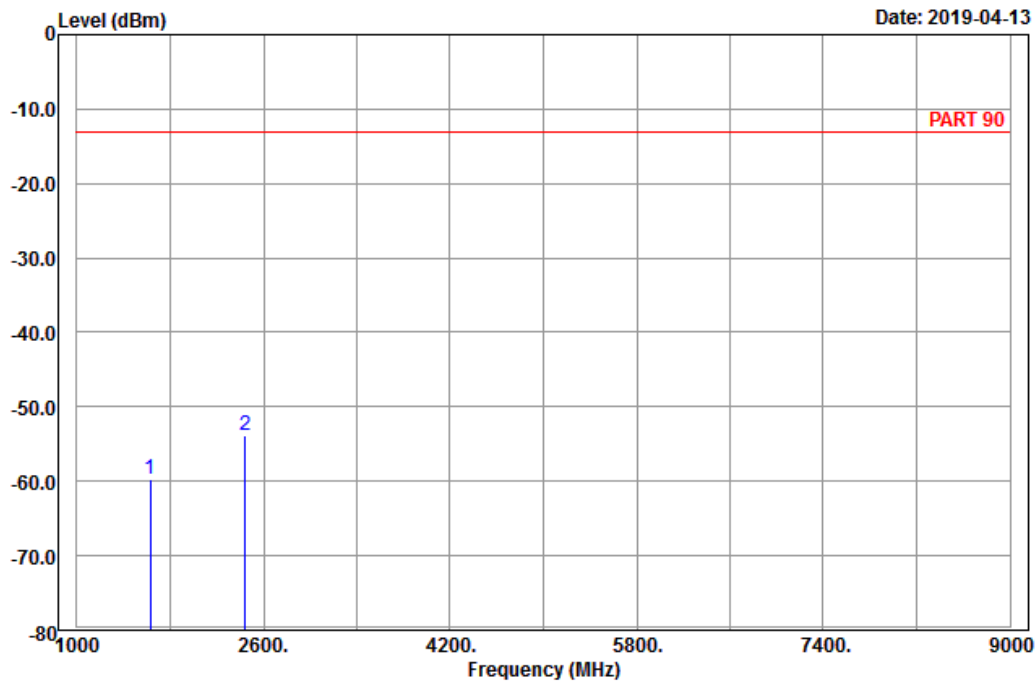

Site : 966 chamber 1
 Condition: PART 90 Vertical
 Remark : LTE_Band 26_Link_CH26697
 Tested by: Charles Hsiao

	Freq	Level	Read Level	Limit Line	Over Limit	Factor	Remark
	MHz	dBm	dBm	dBm	dB	dB	
1	1629.40	-59.82	-67.38	-13.00	-46.82	7.56	Peak
2 pp	2444.10	-53.85	-64.85	-13.00	-40.85	11.00	Peak

Middle Channel



Bureau Veritas Consumer Products Services Ltd., Taoyuan Branch

A D T

Data: 5

Date: 2019-04-13

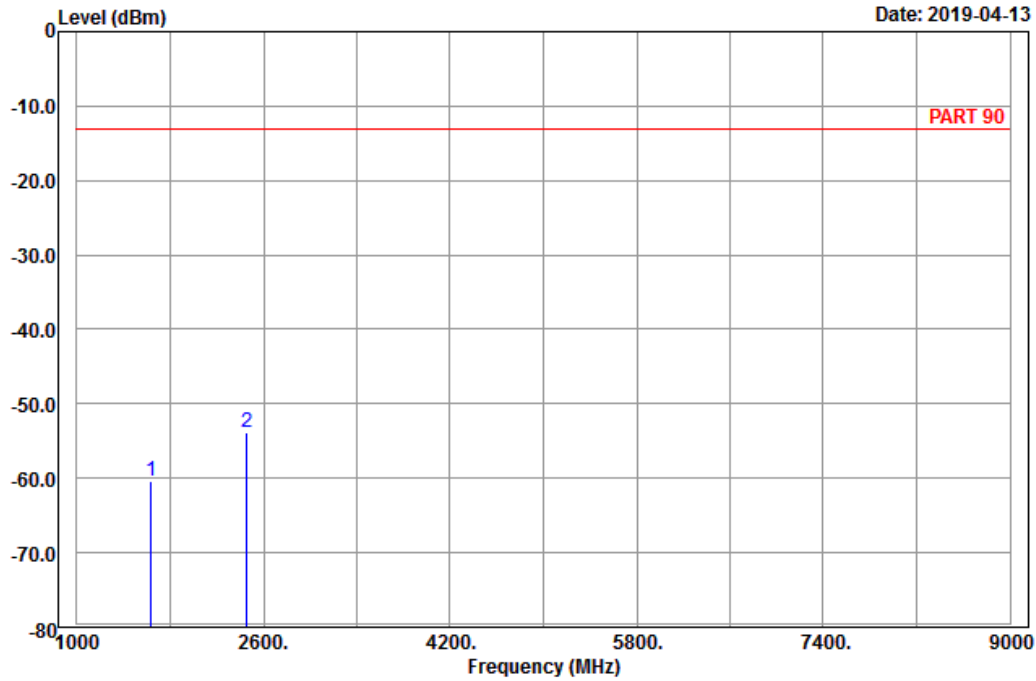

Site : 966 chamber 1
 Condition: PART 90 Horizontal
 Remark : LTE_Band 26_Link_CH26740
 Tested by: Charles Hsiao

	Read	Limit	Over				
Freq	Level	Level	Line	Limit	Factor	Remark	
MHz	dBm	dBm	dBm	dB	dB		
1	1638.00	-60.44	-68.00	-13.00	-47.44	7.56	Peak
2	pp 2457.00	-53.78	-64.80	-13.00	-40.78	11.02	Peak



A D T

Data: 6

Date: 2019-04-13

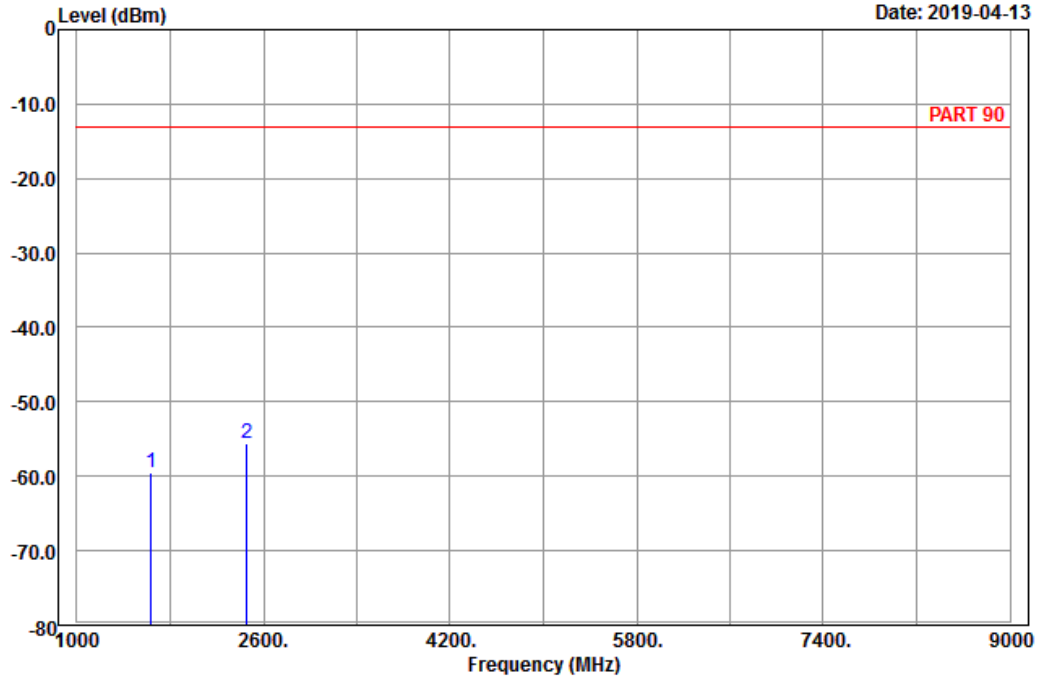

Site : 966 chamber 1
 Condition: PART 90 Vertical
 Remark : LTE_Band 26_Link_CH26740
 Tested by: Charles Hsiao

	Freq	Level	Read Level	Limit Line	Over Limit	Factor	Remark
	MHz	dBm	dBm	dBm	dB	dB	
1	1638.00	-59.61	-67.17	-13.00	-46.61	7.56	Peak
2 pp	2457.00	-55.57	-66.59	-13.00	-42.57	11.02	Peak

High Channel



Bureau Veritas Consumer Products Services Ltd., Taoyuan Branch

A D T

Data: 5

Date: 2019-04-13

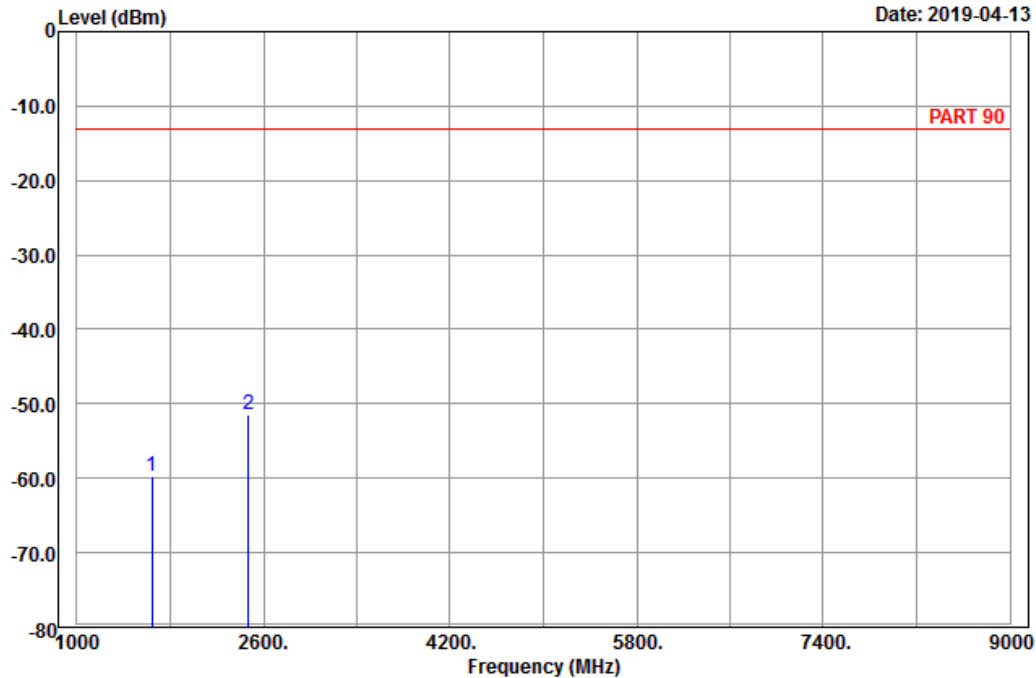

Site : 966 chamber 1
 Condition: PART 90 Horizontal
 Remark : LTE_Band 26_Link_CH26783
 Tested by: Charles Hsiao

	Freq	Level	Read Level	Limit	Over	Factor	Remark
	MHz	dBm	dBm	dBm	dB	dB	
1	1646.60	-59.66	-67.39	-13.00	-46.66	7.73	Peak
2	2469.90	-51.37	-62.40	-13.00	-38.37	11.03	Peak



A D T

Data: 6

Date: 2019-04-13

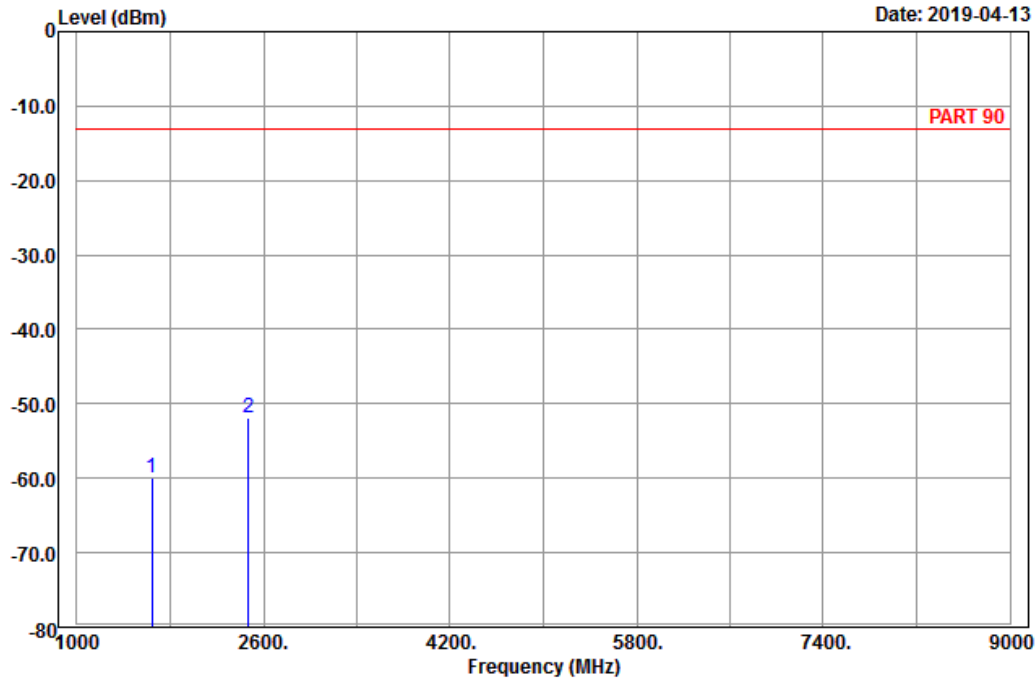

Site : 966 chamber 1
 Condition: PART 90 Vertical
 Remark : LTE_Band 26_Link_CH26783
 Tested by: Charles Hsiao

	Freq	Level	Read Level	Limit Line	Over Limit	Factor	Remark
	MHz	dBm	dBm	dBm	dB	dB	
1	1646.60	-59.97	-67.70	-13.00	-46.97	7.73	Peak
2 pp	2469.90	-51.97	-63.00	-13.00	-38.97	11.03	Peak

Channel Bandwidth: 5 MHz / QPSK
Low Channel



Bureau Veritas Consumer Products Services Ltd., Taoyuan Branch

A D T

Data: 5

Date: 2019-04-13

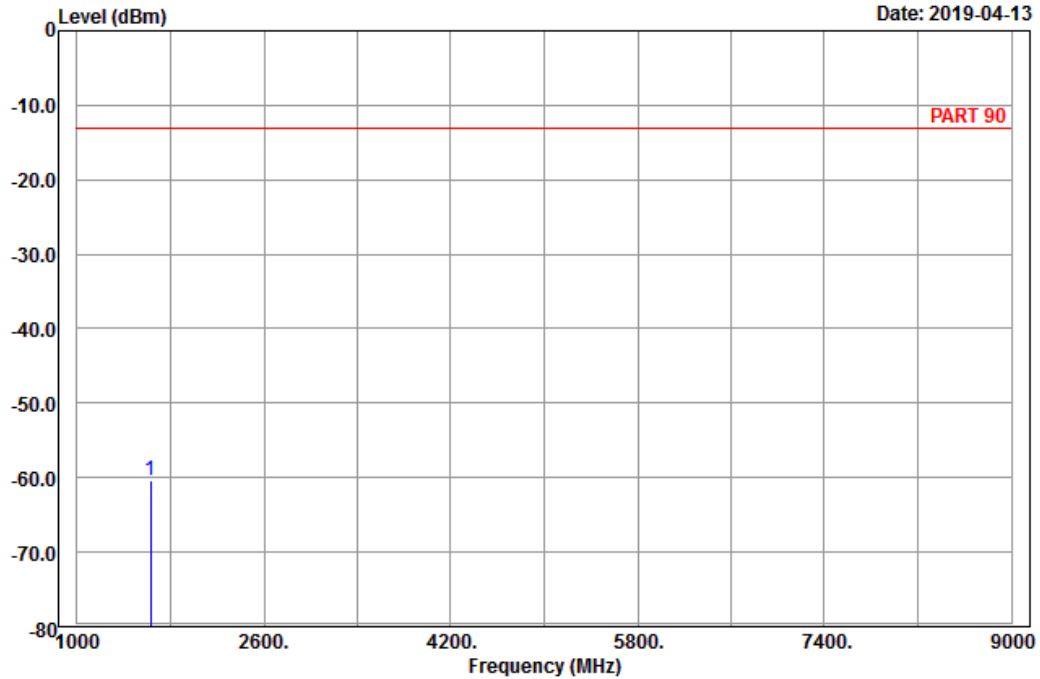

Site : 966 chamber 1
Condition: PART 90 Horizontal
Remark : LTE_Band 26_Link_CH26715
Tested by: Karl Lee

	Freq	Level	Read Level	Limit Line	Over Limit	Factor	Remark
	MHz	dBm	dBm	dBm	dB	dB	
1	pp 1633.00	-60.48	-68.04	-13.00	-47.48	7.56	Peak



A D T

Data: 6

Date: 2019-04-13

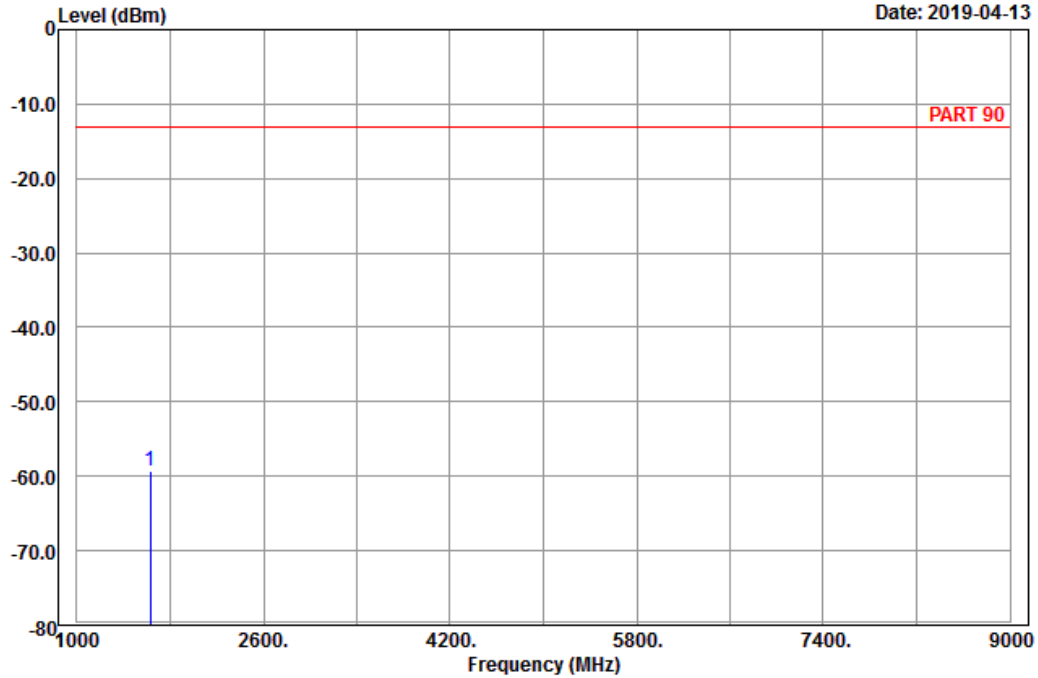

Site : 966 chamber 1
 Condition: PART 90 Vertical
 Remark : LTE_Band 26_Link_CH26715
 Tested by: Karl Lee

	Freq	Level	Read Level	Limit Line	Over Limit	Factor	Remark
	MHz	dBm	dBm	dBm	dB	dB	
1	pp 1633.00	-59.27	-66.83	-13.00	-46.27	7.56	Peak

Middle Channel



Bureau Veritas Consumer Products Services Ltd., Taoyuan Branch

A D T

Data: 5

Date: 2019-04-13

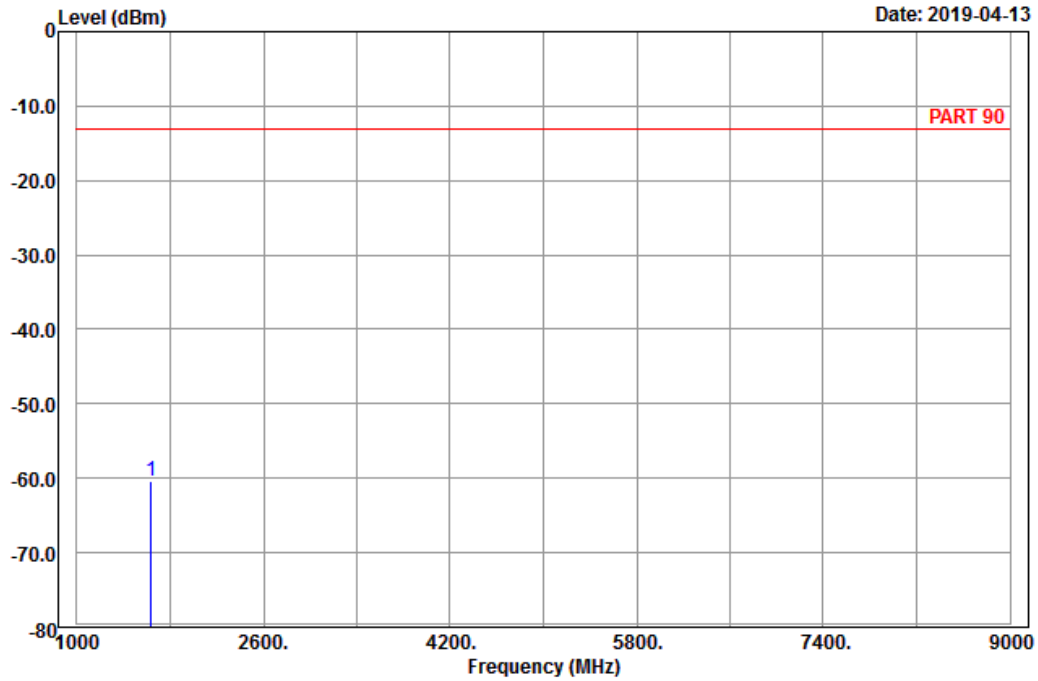

Site : 966 chamber 1
 Condition: PART 90 Horizontal
 Remark : LTE_Band 26_Link_CH26740
 Tested by: Karl Lee

	Read	Limit	Over		
Freq	Level	Level	Line	Limit	Factor Remark
MHz	dBm	dBm	dBm	dB	dB
1 pp 1638.00	-60.31	-67.87	-13.00	-47.31	7.56 Peak



A D T

Data: 6

Date: 2019-04-13

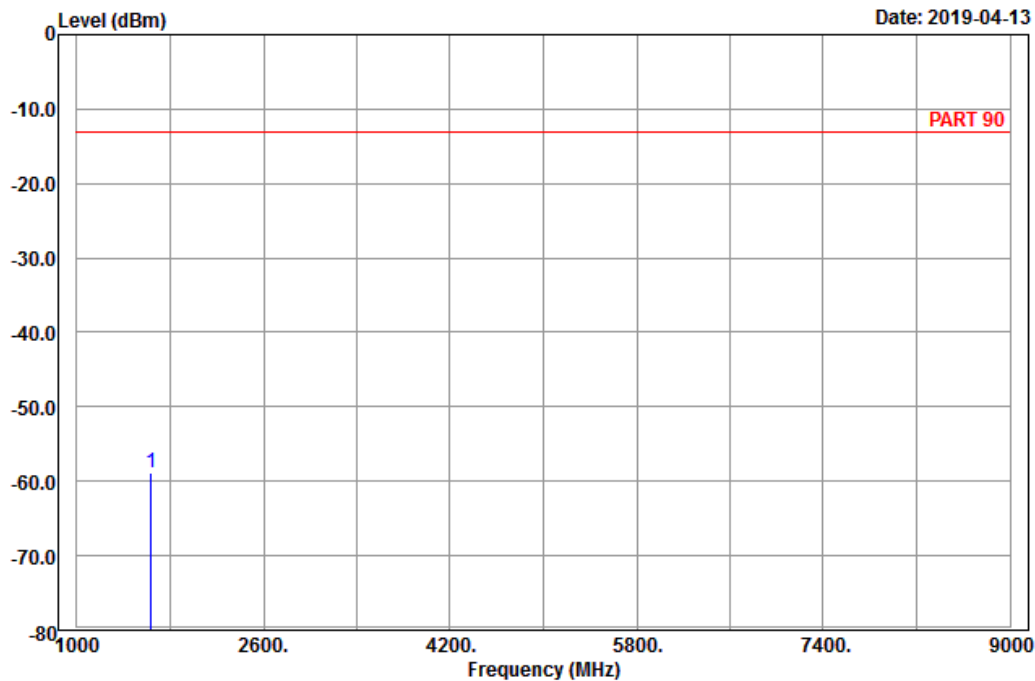

Site : 966 chamber 1
 Condition: PART 90 Vertical
 Remark : LTE_Band 26_Link_CH26740
 Tested by: Karl Lee

	Freq	Level	Read Level	Limit Line	Over Limit	Factor	Remark
	MHz	dBm	dBm	dBm	dB	dB	
1	pp 1638.00	-58.78	-66.34	-13.00	-45.78	7.56	Peak

High Channel



Bureau Veritas Consumer Products Services Ltd., Taoyuan Branch

A D T

Data: 5

Date: 2019-04-13

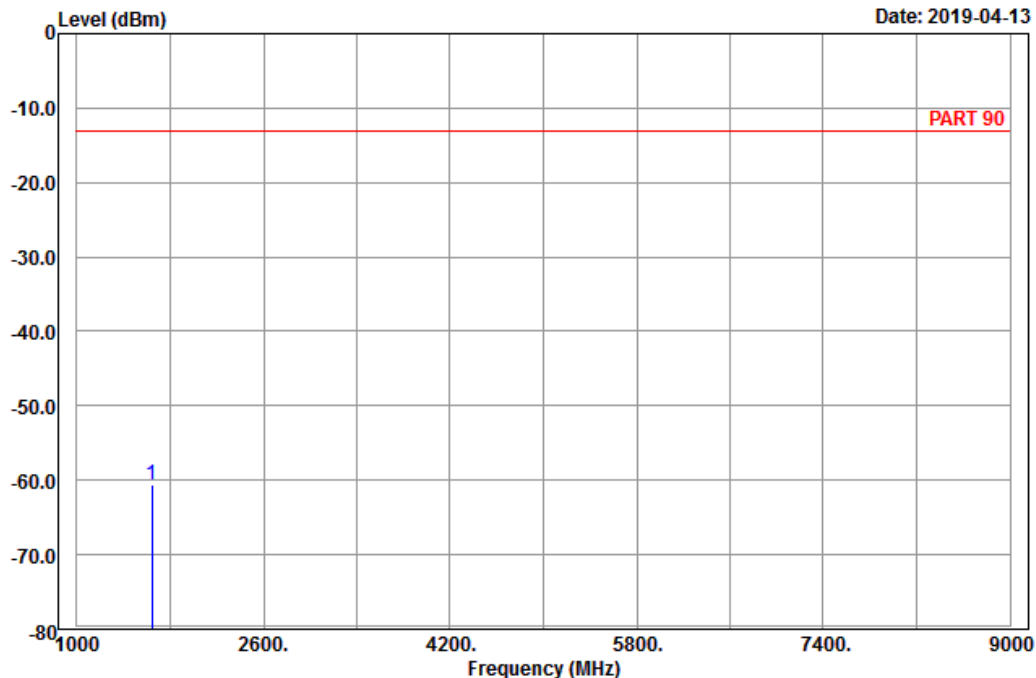

Site : 966 chamber 1
 Condition: PART 90 Horizontal
 Remark : LTE_Band 26_Link_CH26765
 Tested by: Karl Lee

	Read	Limit	Over		
Freq	Level	Level	Line	Limit	Factor Remark
MHz	dBm	dBm	dBm	dB	dB
1 pp 1643.00	-60.50	-68.23	-13.00	-47.50	7.73 Peak



A D T

Data: 6

Date: 2019-04-13

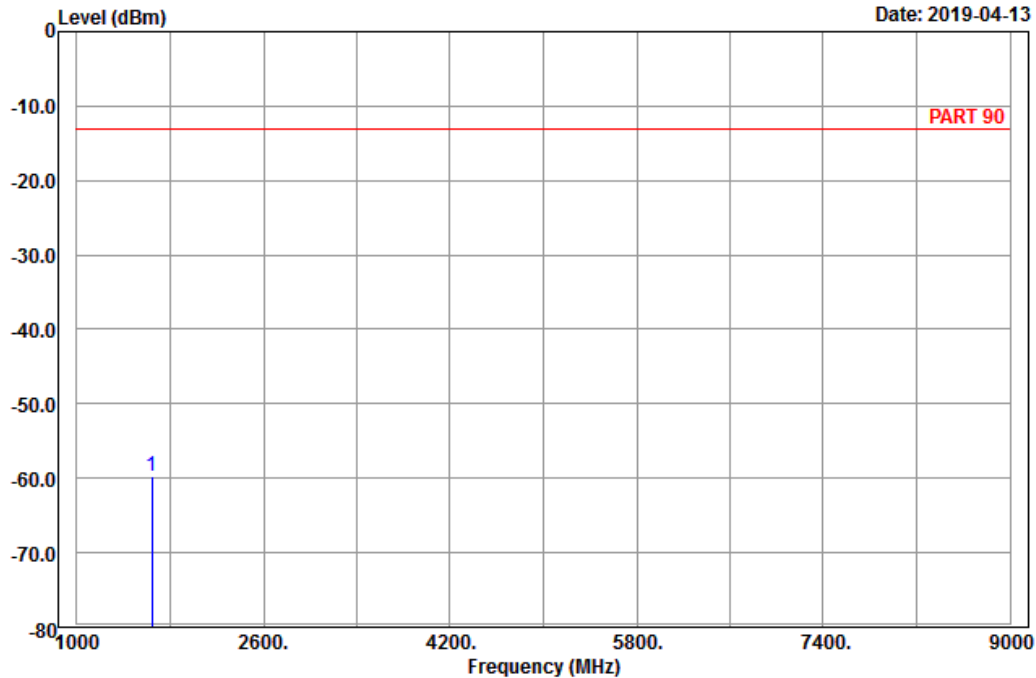

Site : 966 chamber 1
 Condition: PART 90 Vertical
 Remark : LTE_Band 26_Link_CH26765
 Tested by: Karl Lee

	Freq	Level	Read Level	Limit Line	Over Limit	Factor	Remark
	MHz	dBm	dBm	dBm	dB	dB	
1	pp 1643.00	-59.78	-67.51	-13.00	-46.78	7.73	Peak

Channel Bandwidth: 10 MHz / QPSK
Middle Channel



Bureau Veritas Consumer Products Services Ltd., Taoyuan Branch

A D T

Data: 9

Date: 2019-04-13

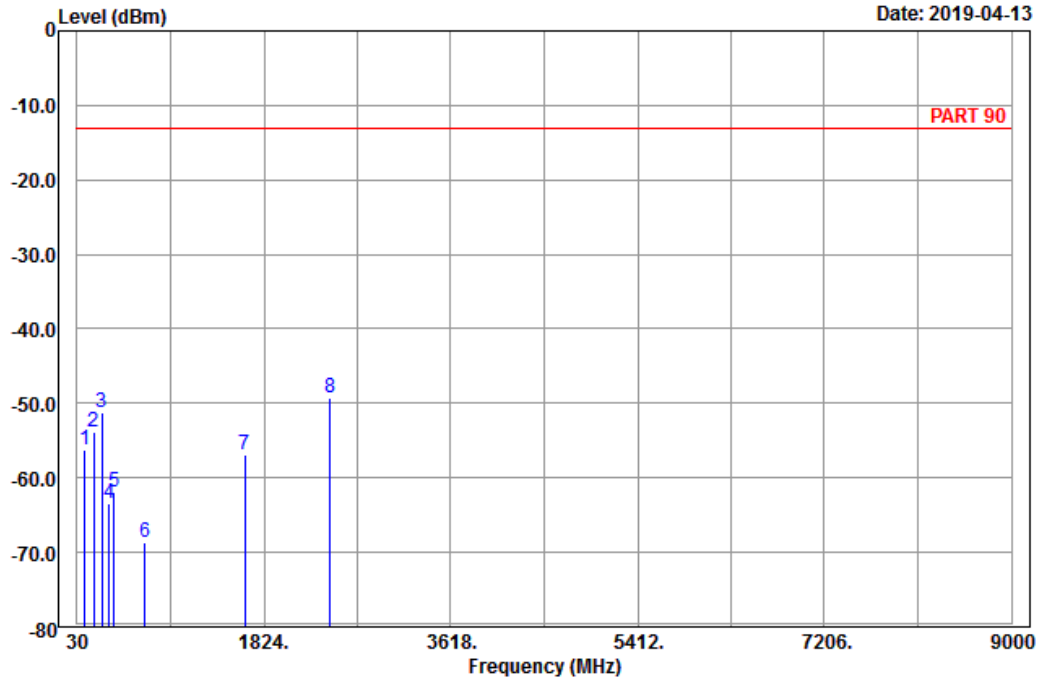

Site : 966 chamber 1
Condition: PART 90 Horizontal
Remark : LTE_Band 26_Link_CH26740
Tested by: Karl Lee

	Freq	Level	Read Level	Limit Line	Over Limit	Factor	Remark
	MHz	dBm	dBm	dBm	dB	dB	
1	100.47	-56.21	-46.21	-13.00	-43.21	-10.00	Peak
2	191.46	-53.83	-48.05	-13.00	-40.83	-5.78	Peak
3	268.14	-51.21	-45.53	-13.00	-38.21	-5.68	Peak
4	342.00	-63.42	-57.95	-13.00	-50.42	-5.47	Peak
5	381.90	-61.82	-58.15	-13.00	-48.82	-3.67	Peak
6	685.00	-68.60	-68.30	-13.00	-55.60	-0.30	Peak
7	1638.00	-56.98	-64.54	-13.00	-43.98	7.56	Peak
8 pp	2457.00	-49.29	-60.31	-13.00	-36.29	11.02	Peak



A D T

Data: 10

Date: 2019-04-13

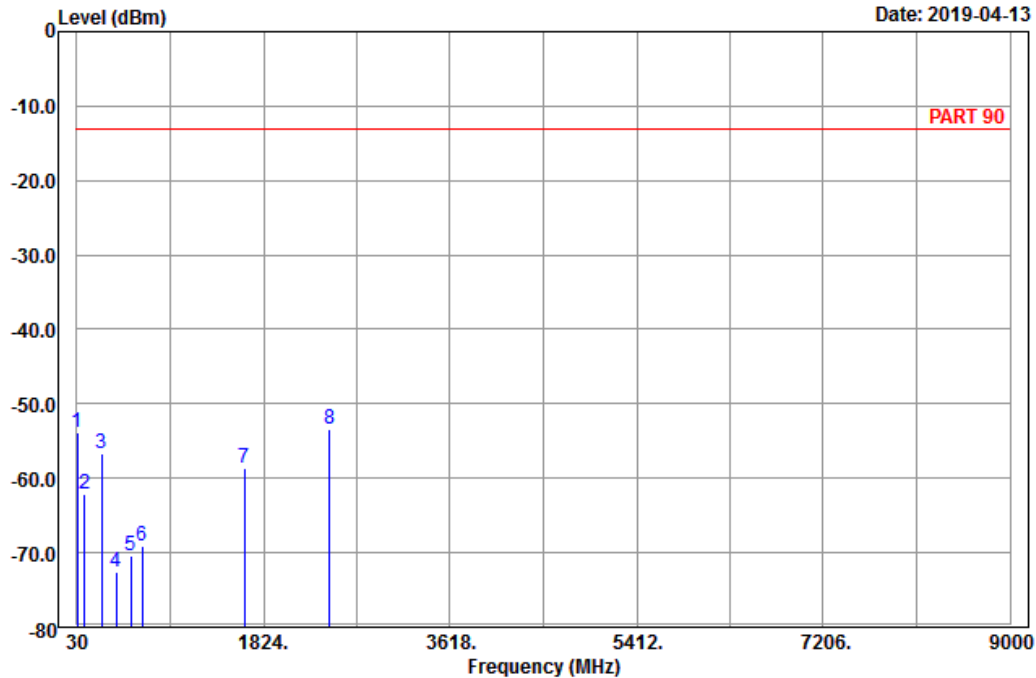

Site : 966 chamber 1
 Condition: PART 90 Vertical
 Remark : LTE_Band 26_Link_CH26740
 Tested by: Karl Lee

	Freq	Level	Read Level	Limit Line	Over Limit	Factor	Remark
	MHz	dBm	dBm	dBm	dB	dB	
1	34.59	-53.85	-42.75	-13.00	-40.85	-11.10	Peak
2	101.01	-62.02	-52.02	-13.00	-49.02	-10.00	Peak
3	267.60	-56.62	-50.95	-13.00	-43.62	-5.67	Peak
4	407.10	-72.62	-69.71	-13.00	-59.62	-2.91	Peak
5	549.20	-70.51	-68.78	-13.00	-57.51	-1.73	Peak
6	658.40	-69.07	-68.89	-13.00	-56.07	-0.18	Peak
7	1638.00	-58.72	-66.28	-13.00	-45.72	7.56	Peak
8 pp	2457.00	-53.51	-64.53	-13.00	-40.51	11.02	Peak

5 Pictures of Test Arrangements

Please refer to the attached file (Test Setup Photo).

Appendix – Information of the Testing Laboratories

We, Bureau Veritas Consumer Products Services (H.K.) Ltd., Taoyuan Branch, were founded in 1988 to provide our best service in EMC, Radio, Telecom and Safety consultation. Our laboratories are FCC recognized accredited test firms and accredited according to ISO/IEC 17025.

If you have any comments, please feel free to contact us at the following:

Lin Kou EMC/RF Lab

Tel: 886-2-26052180

Fax: 886-2-26051924

Hsin Chu EMC/RF/Telecom Lab

Tel: 886-3-6668565

Fax: 886-3-6668323

Hwa Ya EMC/RF/Safety

Tel: 886-3-3183232

Fax: 886-3-3270892

Email: service.adt@tw.bureauveritas.com

Web Site: www.bureauveritas-adt.com

The address and road map of all our labs can be found in our web site also.

--- END ---