

TEST REPORT

TAS ALGORITHM COMPLIANCE TEST REPORT

EUT Description	Notebook
Brand Name	HP
Model Name	HSC-I001R
FCC ID	ZMOL850GL
Date of Test Start/End	2021-06-22 /2021-07-07
Features	LTE, WCDMA

Applicant	HP Inc.
Address	1501 Page Mill Road, Palo Alto CA 94304, USA
Contact Person	Sam Lin
Telephone/Fax/ Email	+886 2 37896331/sam.lin2@hp.com

Test Report identification	210526-01.TR02
Revision Control	Rev. 00 This test report revision replaces any previous test report revision

TABLE OF CONTENTS

1. Test Setup Description	3
1.1. Measurement System	3
1.2. Equipments List	3
1.3. Test Samples	4
1.4. Software / Firmware	4
2. Test Results	5
2.1. Summary of Test Cases	5
2.2. TAS Parameters Range Compliance - LTE	6
2.3. TAS Parameters Range Compliance - WCDMA	14
2.4. Bands Validation - LTE	22
2.5. Bands Validation - WCDMA	35
2.6. Time Varying Test Sequence - LTE	39
2.7. Time Varying Test Sequence - WCDMA	41
2.8. Handover - LTE-LTE	43
2.9. Handover - LTE-WCDMA	44
2.10. Call Drop and Reboot - LTE	45
3. Conclusion	47

1. Test Setup Description

1.1. Measurement System

The conducted power measurement test setup is described in the following and illustrated in Figure 1

- a. The DUT which is a Fibocom M2 L850-GL module contains the XMM 7360 Cellular Modem and installed inside HP model HSC-I001R convertible notebook.
- b. The control PC is used to configure the Call Box to send power control test sequences to the XMM 7360
- c. Uplink signal power is monitored by the Spectrum Analyzer and record by the PC with a time resolution of 25 msec which is substantially less than the power adjustment interval (Avg_SAR_Check_Period) of 1 sec used for XMM 7360.
- d. The values of Avg_SAR_Power are read from the XMM 7360 by the PC at each Avg_SAR_Check_Period
- e. In additional to power results, the time sequence of power control commands and power samples are also recorded by the PC to enable results to be correlated and plotted. Uplink signal from the XMM 7360 is fed through a 3 dB Power Splitter, which delivers an equal amount of signal to the Spectrum Analyser and the Call Box. The Splitter has high isolation between the Spectrum Analyser and the Call Box. Due to different Uplink/Downlink frequencies and the zero-span time-domain measurement used, interference of Uplink and Downlink sigals is avoided.
- f. Path loss in the power measurement setup from the XMM 7360 Main Antenna port to either the Call Box or the Spectrum Analyser is taken into account

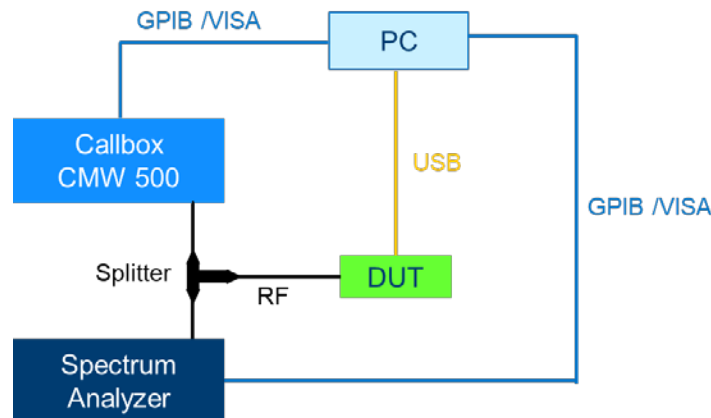

Figure 1 - Test Setup

1.2. Equipments List

The Equipments used for the conducted power measurement test setup are listed in Table below.

ID	Device	Type/Model	Serial	Manufacturer	Cal. Date	Cal. Due Date
135-000	Communication Tester	CMW500	129337	Rohde & Schwarz	2020-03-26	2022-03-26
159-000	Spectrum Analyzer	FSV40	101072	Rohde & Schwarz	2019-09-13	2021-09-13
-	Power Divider	PE2083	-	Pasternack	Attenuation and loss verified before use	

1.3. Test Samples

Sample	ID	Description	Model	Serial	Note
#1	210526-01.S03	Convertible PC with XMM7360 Module Embedded	HSC-I001R	00017602C6	Used for all test cases

1.4. Software / Firmware

Firmware	Version
Intel	M2_7360_MR4_01.2109.00
Fibocom	18500.5001.00.05.27.97 v1.0.4

2. Test Results

2.1. Summary of Test Cases

The following table lists the types of TAS algorithm validation tests performed and the corresponding Tables describing the test configurations and validation results.

Validation type	RAT	Configurations	Results	Verdict
TAS Parameters Range Compliance	LTE	Table 1	Section 2.2	Pass
TAS Parameters Range Compliance	WCDMA	Table 2	Section 2.3	Pass
Bands Compliance	LTE	Table 3	Section 2.4	Pass
Bands Compliance	WCDMA	Table 4	Section 2.5	Pass
Time Varying Test Sequence	LTE	Table 5	Section 2.6	Pass
Time Varying Test Sequence	WCDMA	Table 6	Section 2.7	Pass
Handover	LTE-LTE	Table 7	Section 2.8	Pass
Handover	LTE-WCDMA	Table 8	Section 2.9	Pass
Call Drop and Reboot	LTE	Table 9	Section 2.10	Pass

2.2. TAS Parameters Range Compliance - LTE

Table 1 - Test Cases for TAS Parameters Range Compliance of LTE bands

Case	RAT	Band	Max_Power_DP R_OFF_dBm	Roll_Period_s	Check_Period_ s	Avg_SAR_UppT hresh_dBm	Avg_SAR_Low Thresh_dBm	Max_Power_DP R_ON_dBm
1	LTE	2	23	100	1	22	21	20
2	LTE	2	23	100	1	22	21	18
3	LTE	2	23	100	1	22	19	18
4	LTE	2	23	100	1	22	19	16
5	LTE	2	23	100	1	18	17	16
6	LTE	2	23	100	1	18	17	14
7	LTE	2	23	100	1	18	15	14
8	LTE	2	23	100	1	18	15	12
9	LTE	2	23	100	1	13	12	11
10	LTE	2	23	100	1	13	12	9
11	LTE	2	23	100	1	13	10	9
12	LTE	2	23	100	1	13	10	7
13	LTE	2	23	360	1	18	17	14

Note: The Average power is calculated using the measured instantaneous power and compared to the UpperThreshold Plus Tune-Up Tolerance. This is applied for all the test cases in this report.

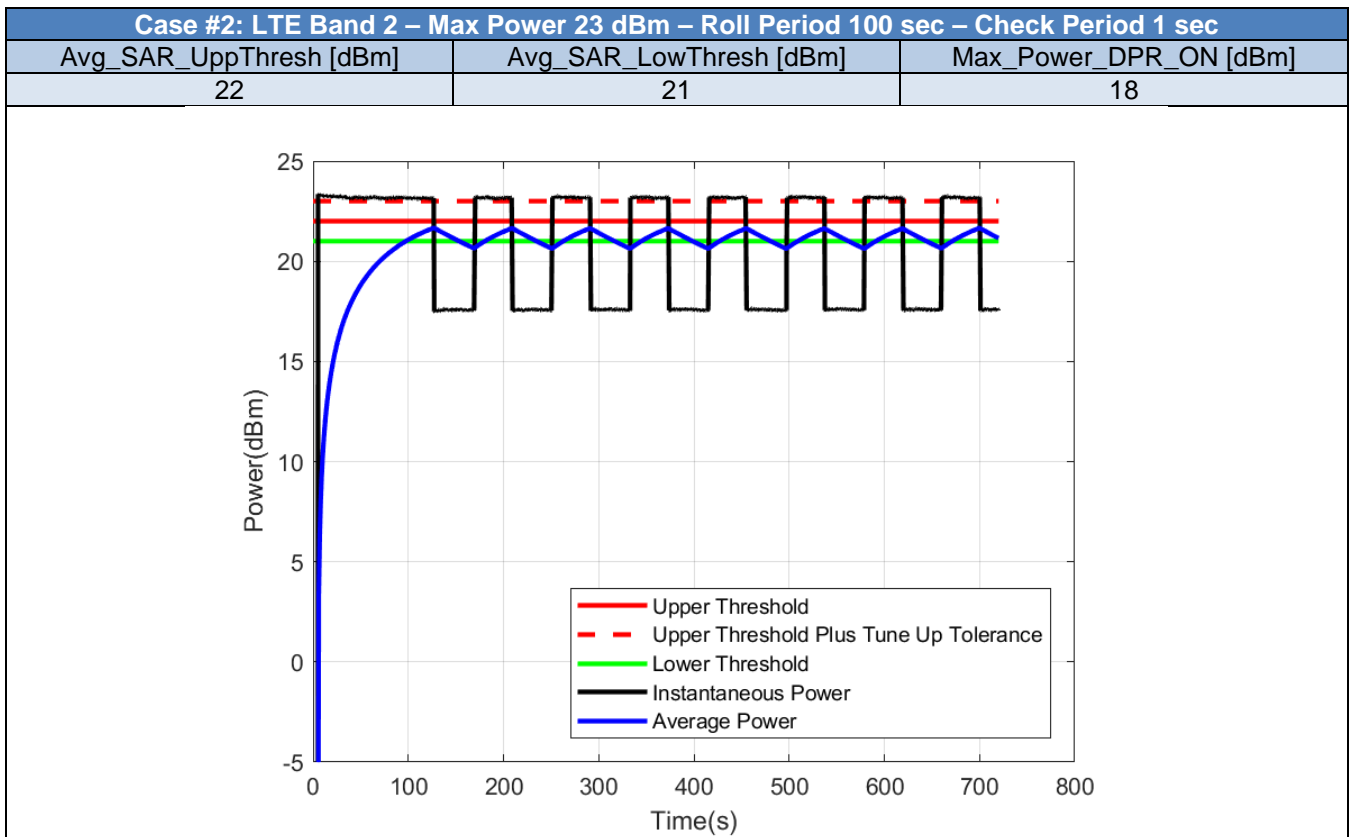
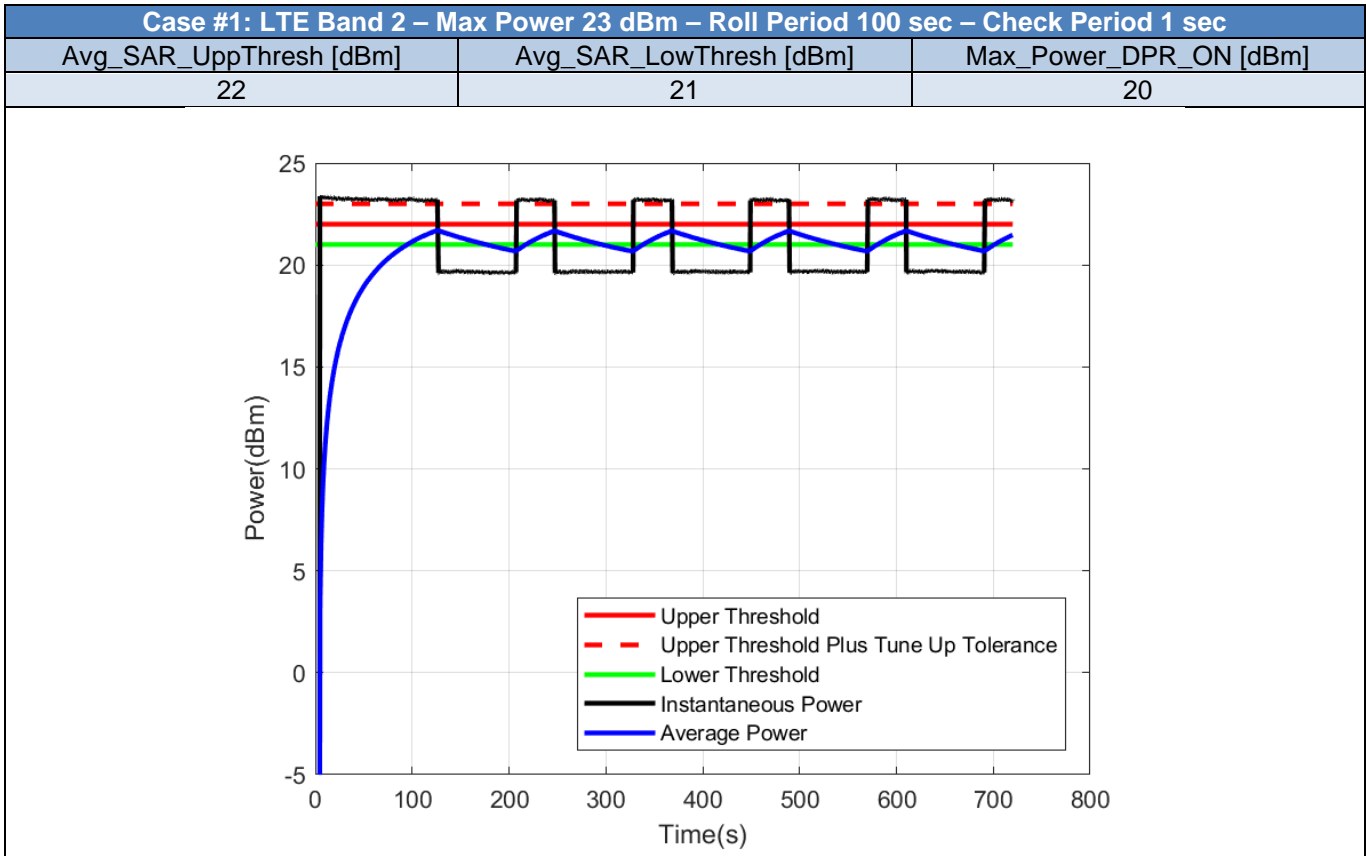

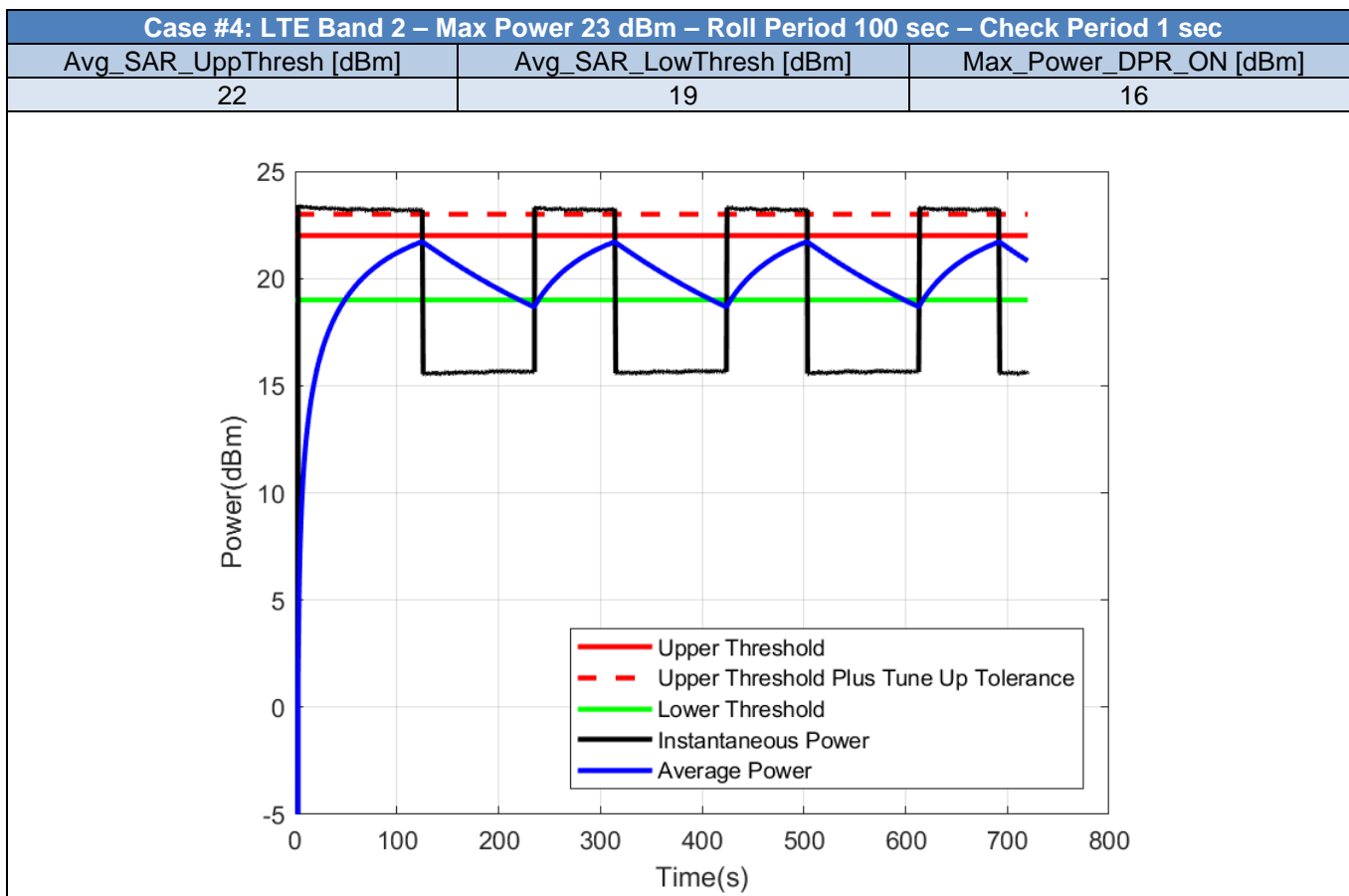
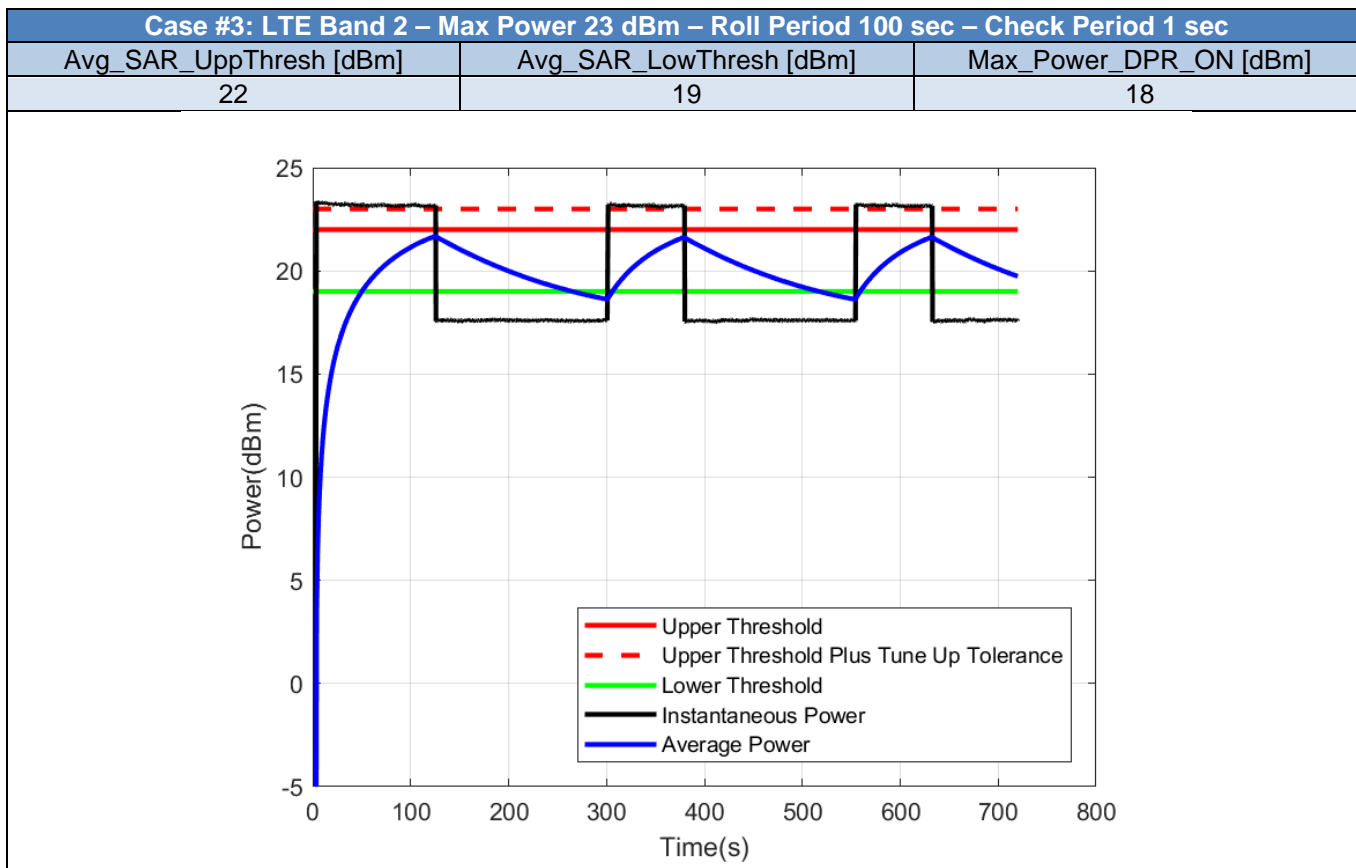

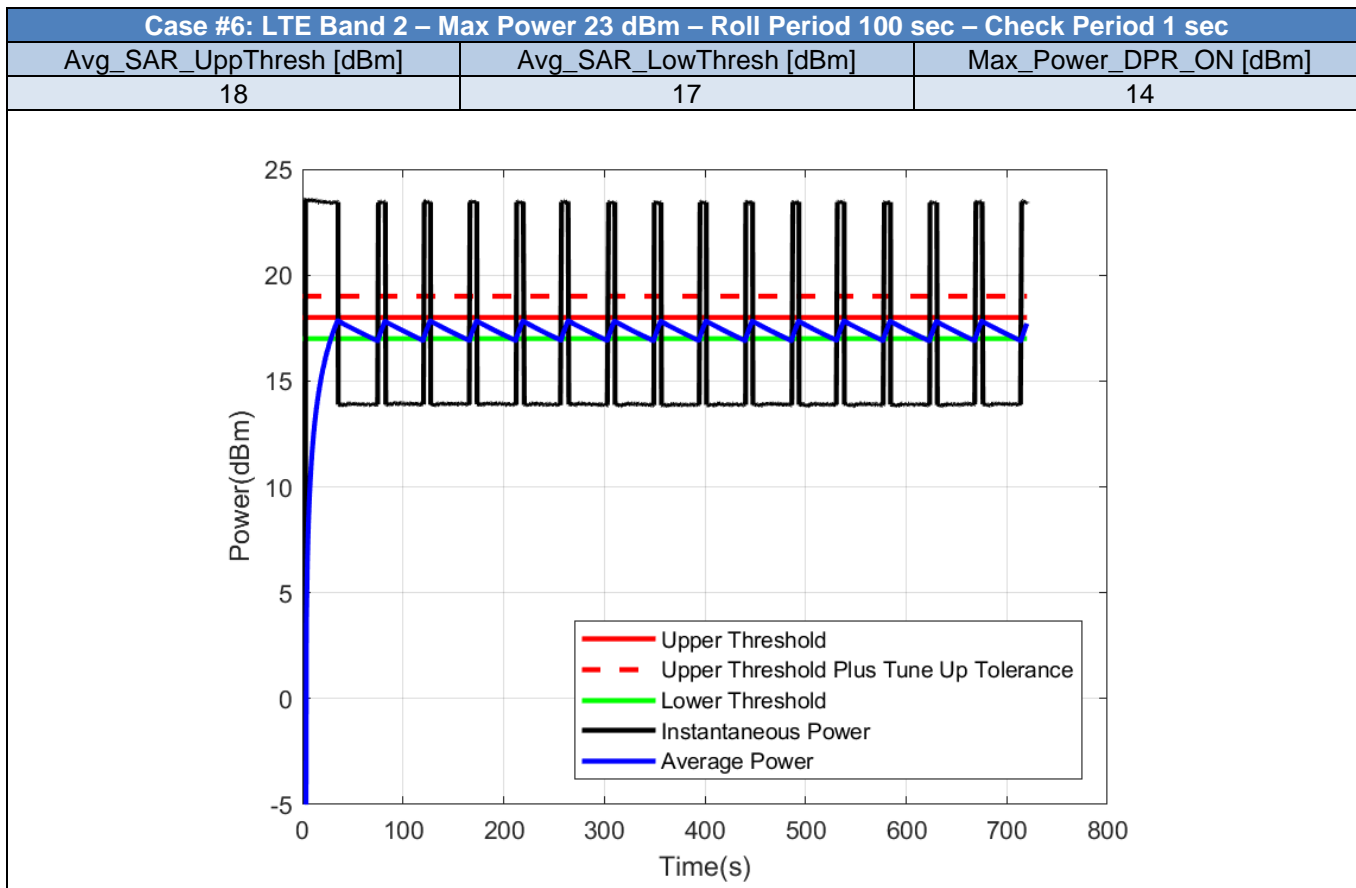
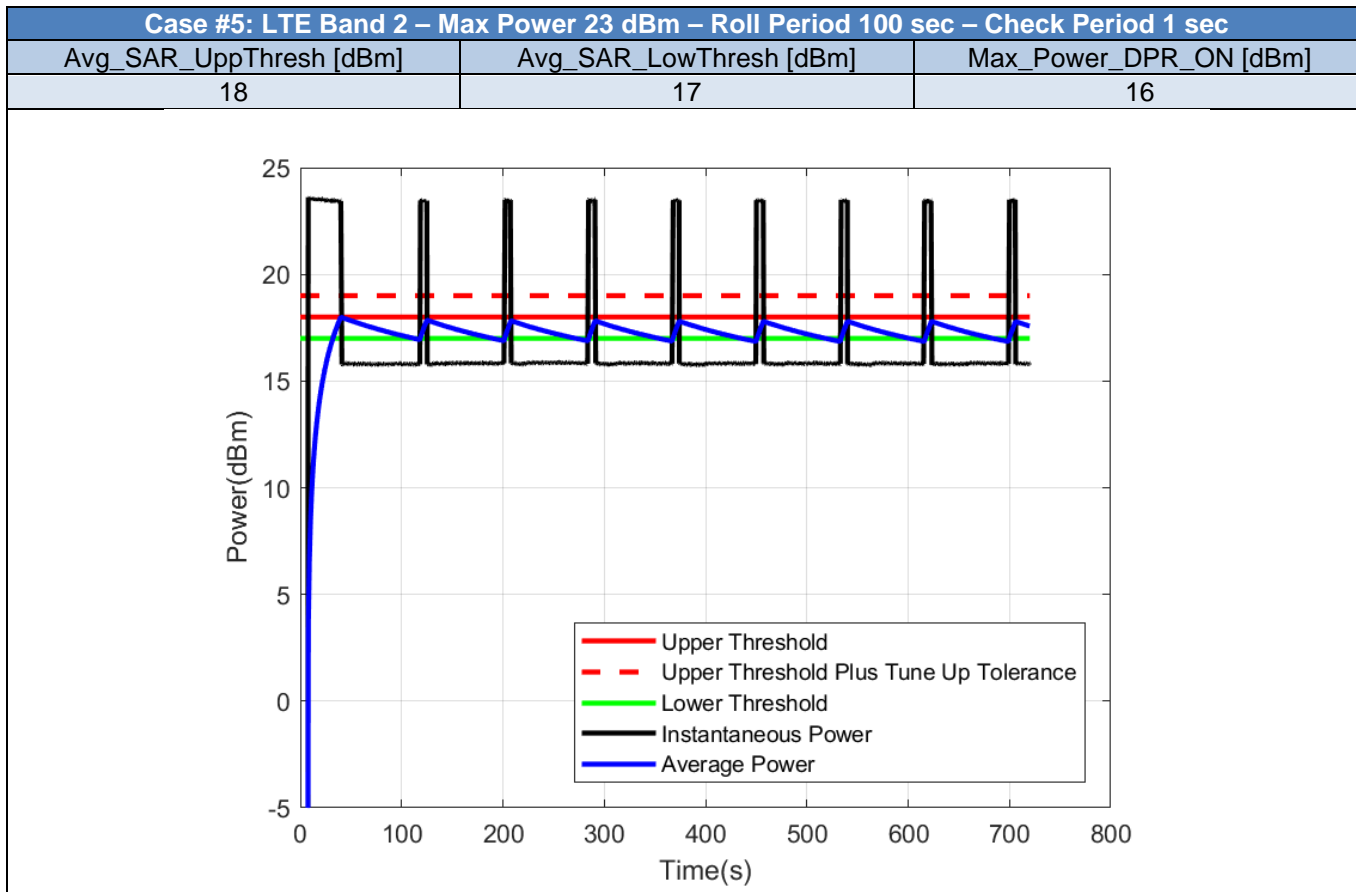

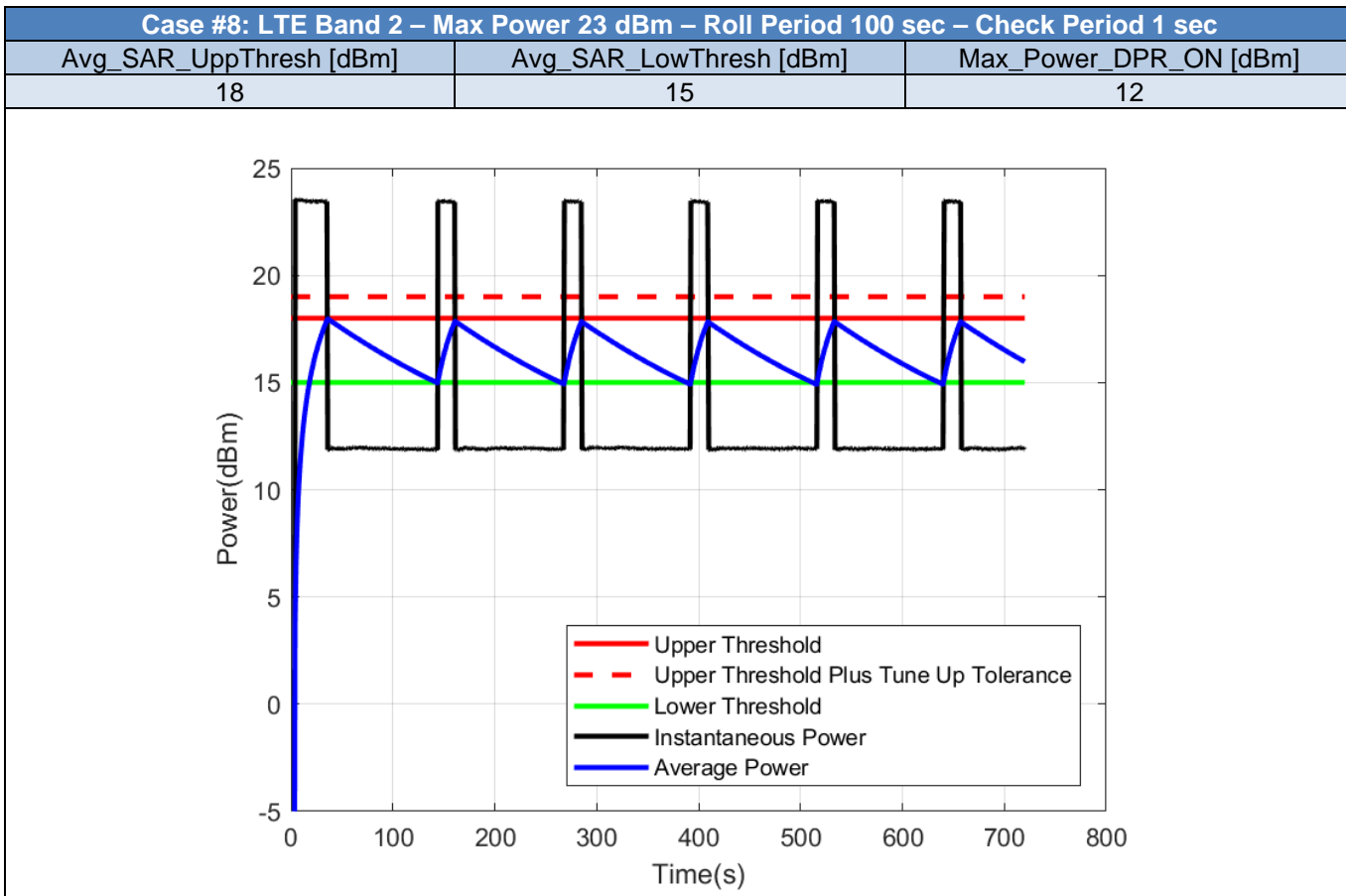
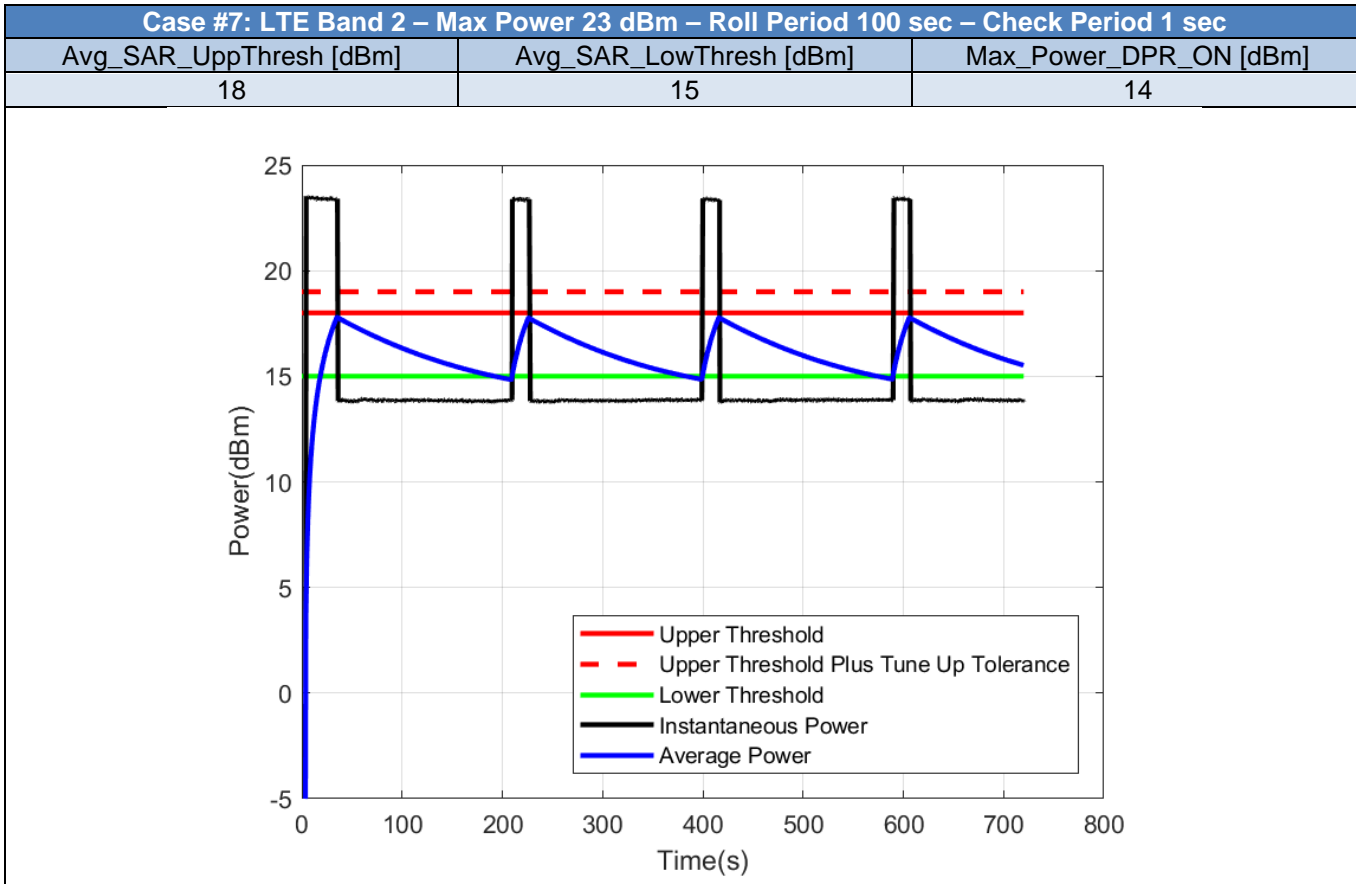

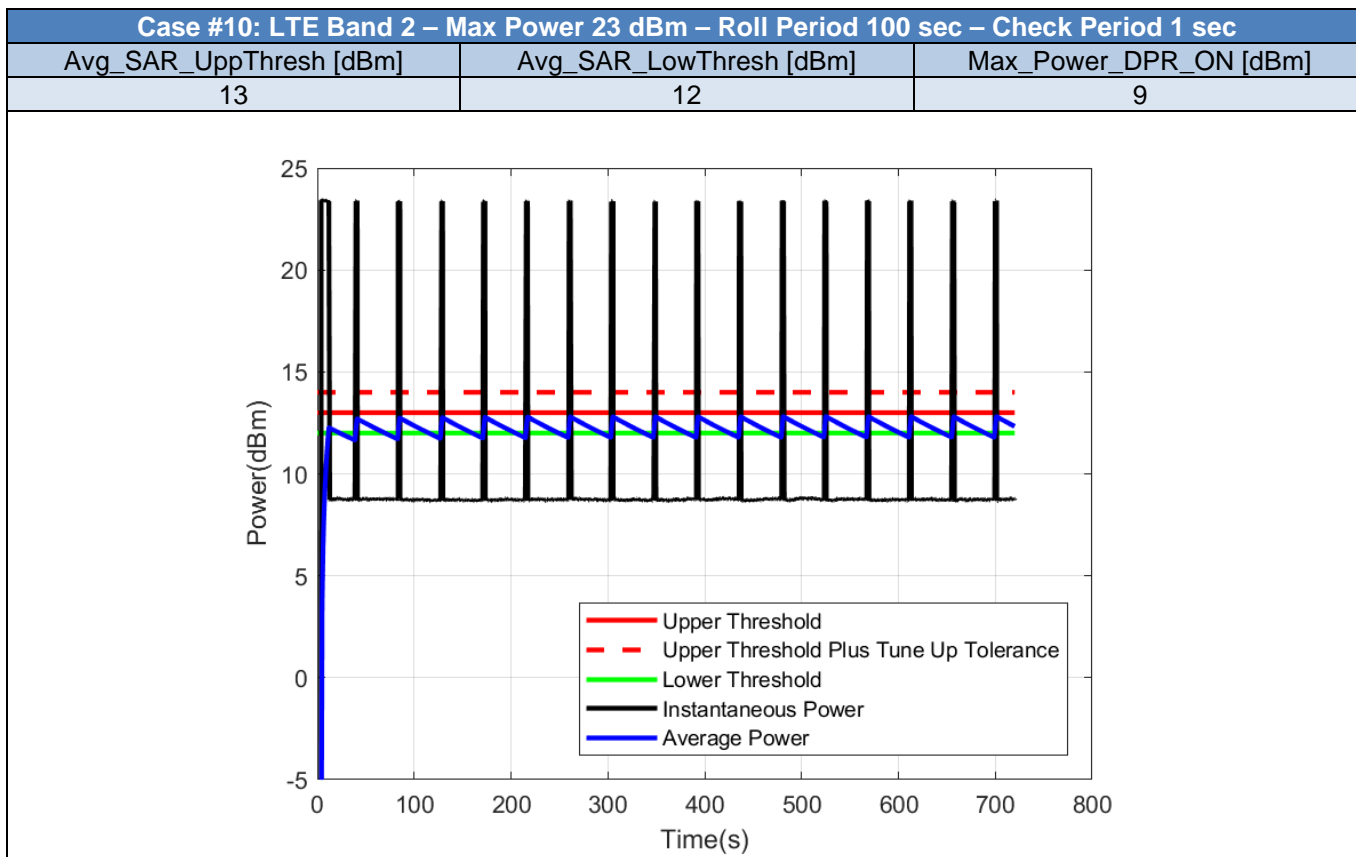
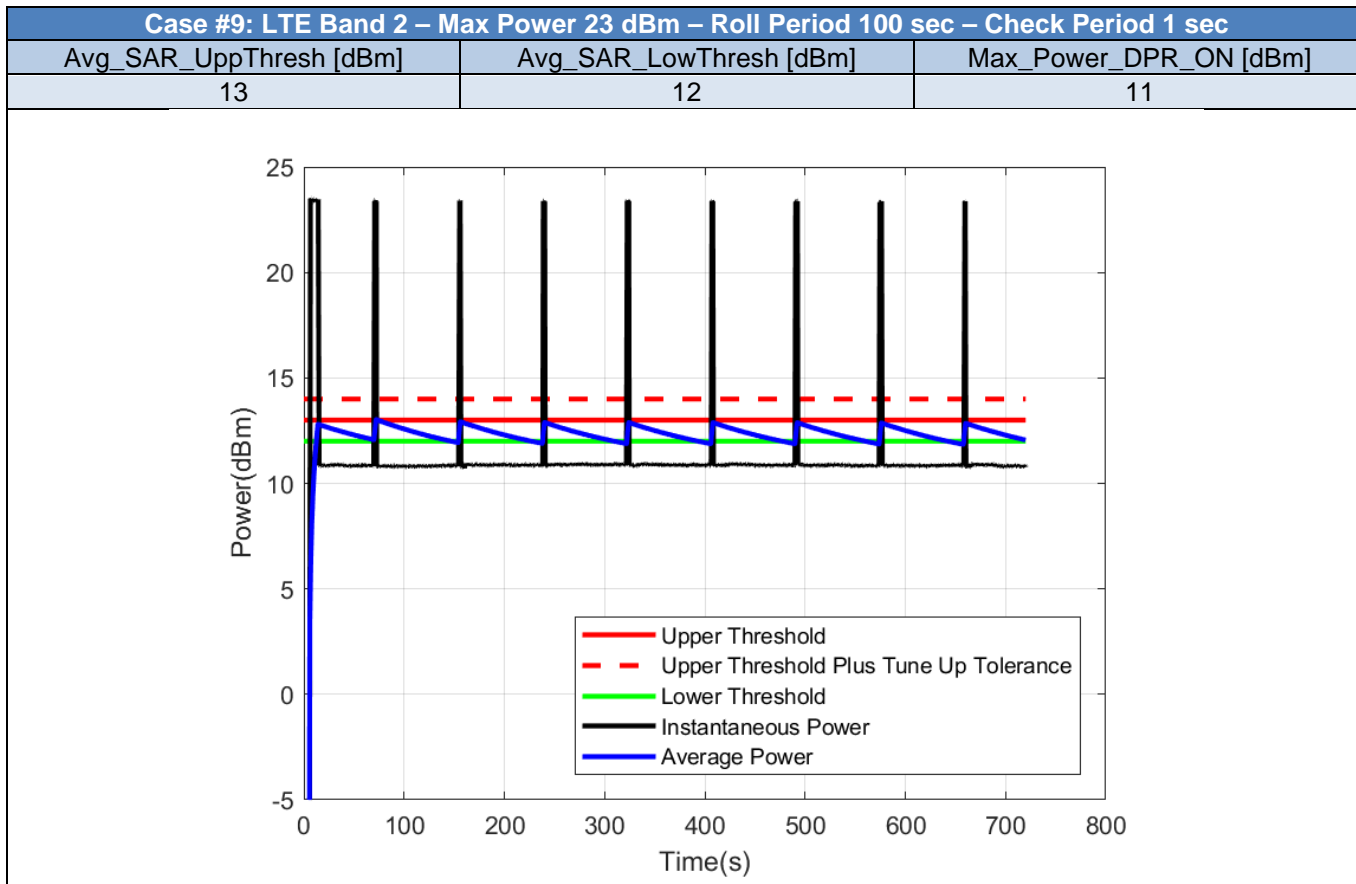

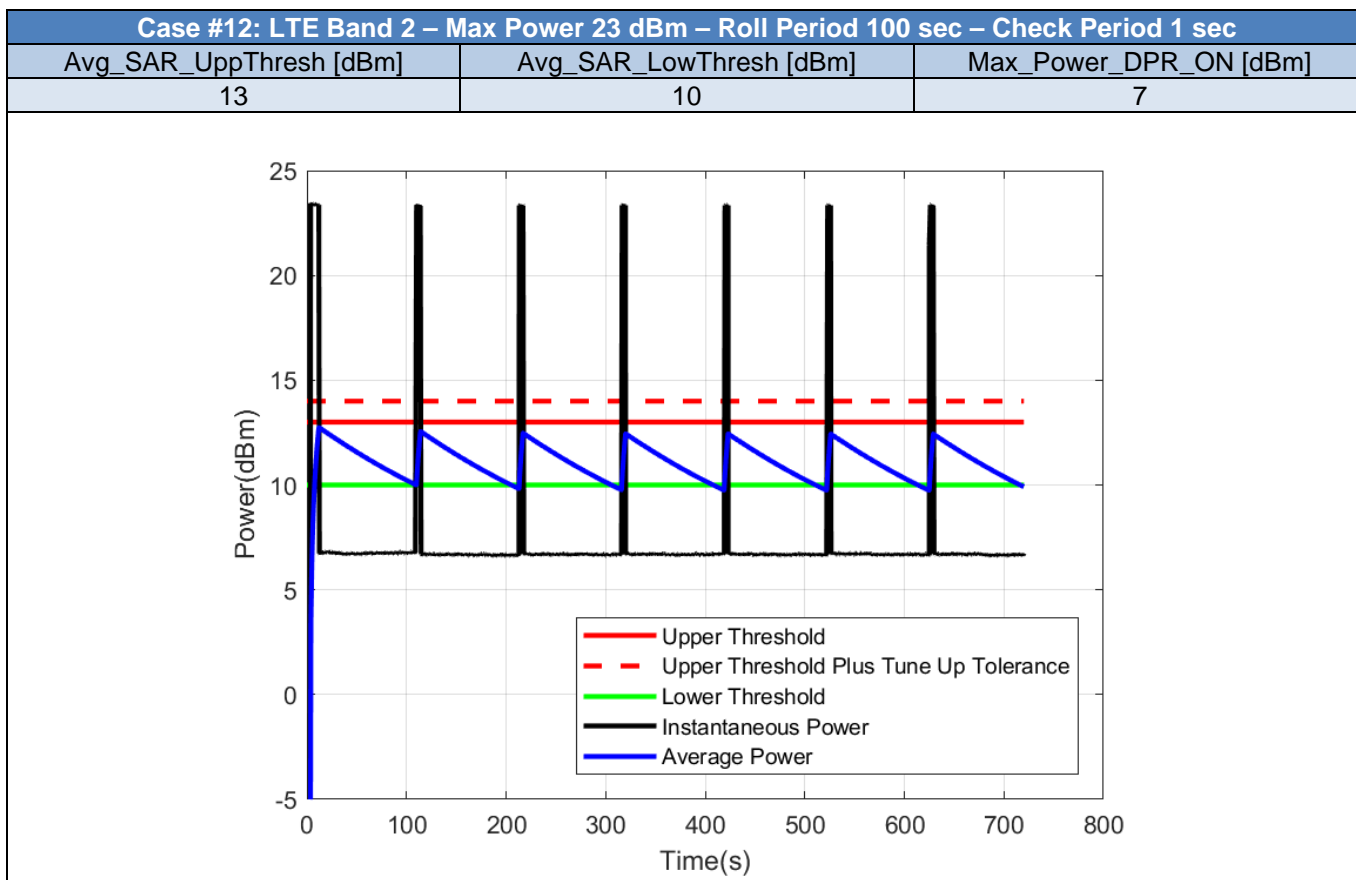
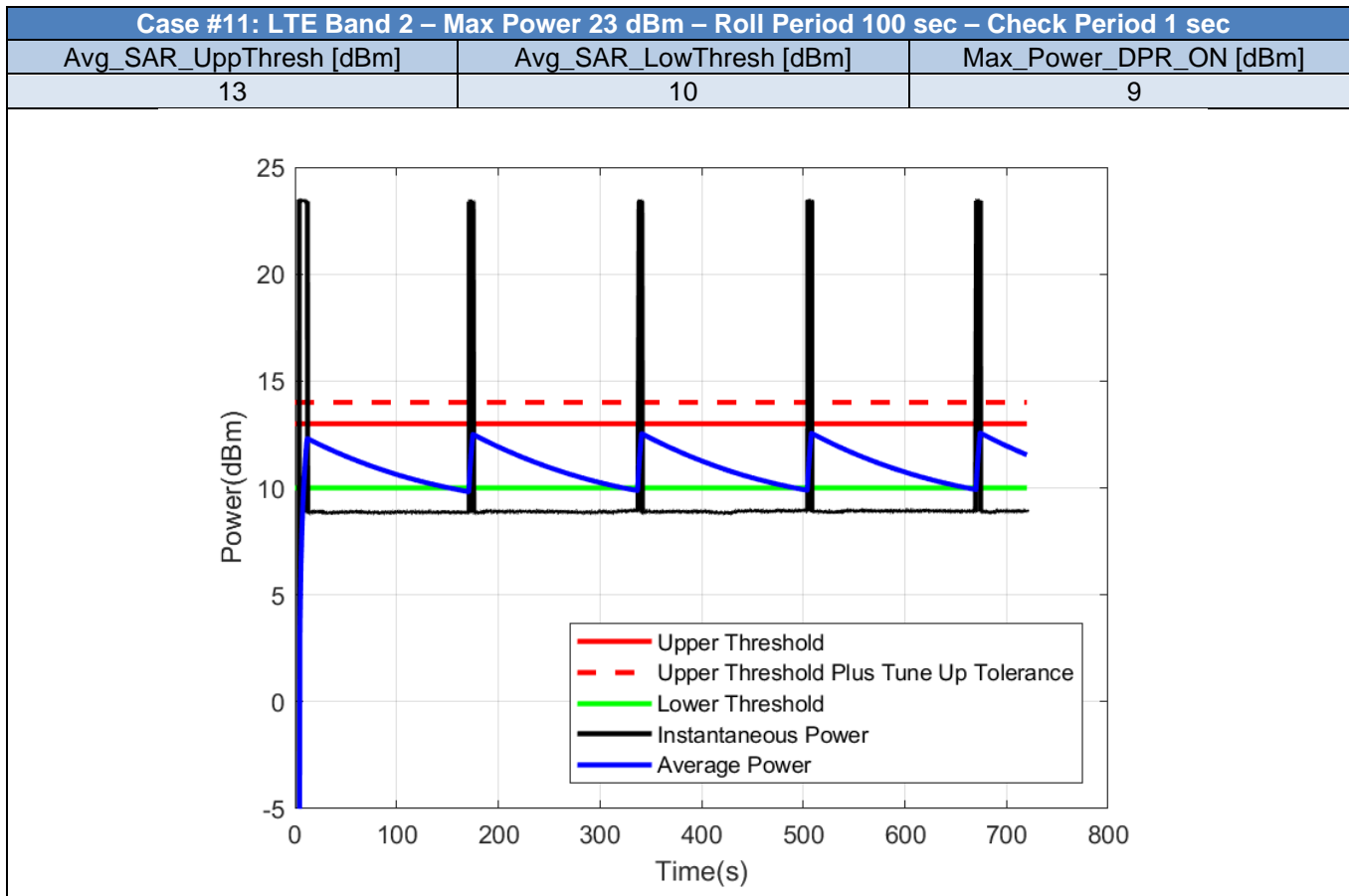

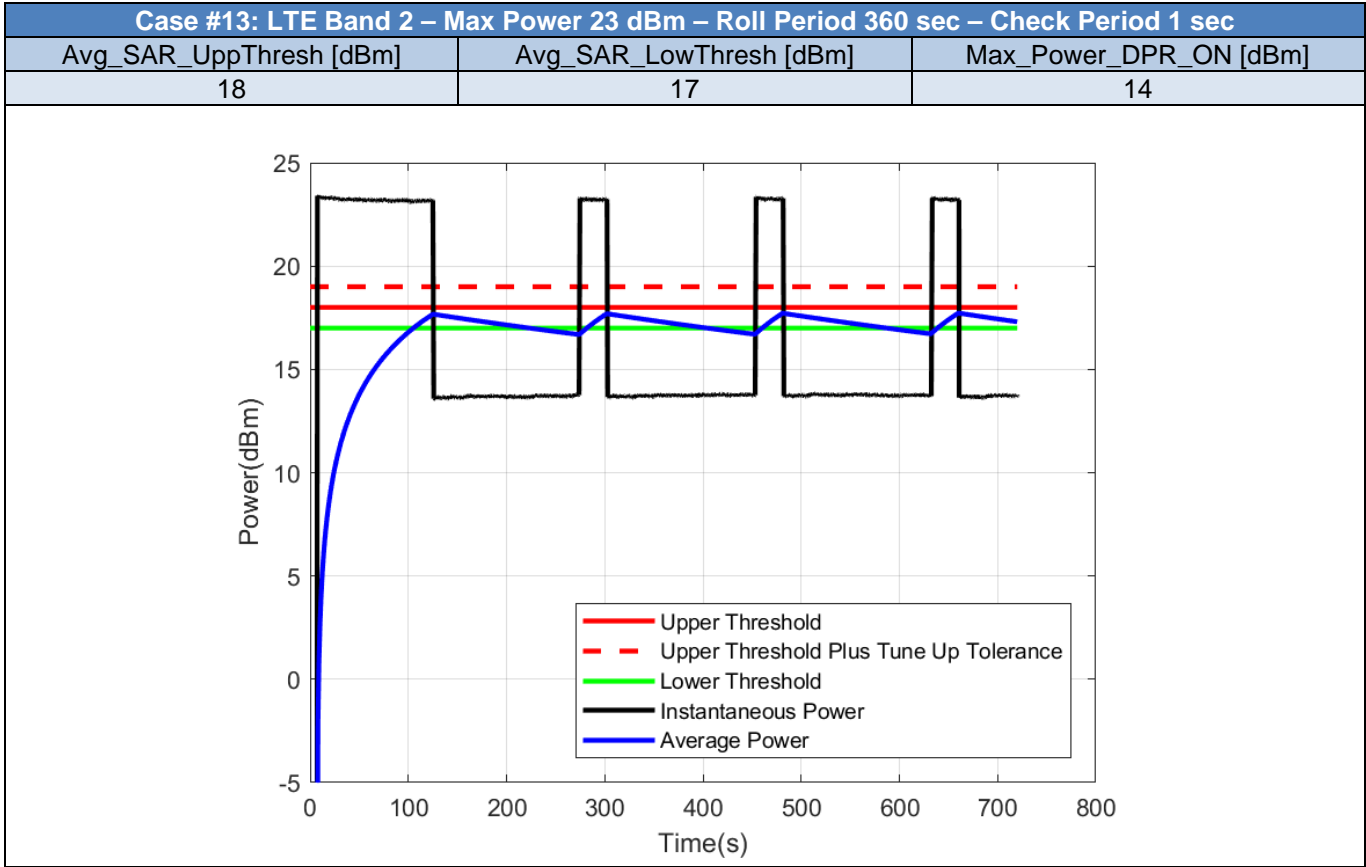

2.3. TAS Parameters Range Compliance - WCDMA

Table 2 - Test Cases for TAS Parameters Range Compliance of WCDMA bands

Case	RAT	Band	Max_Power_DPR_OFF_dBm	Roll_Period_s	Check_Period_s	Avg_SAR_Upper_Threshold_dBm	Avg_SAR_Lower_Threshold_dBm	Max_Power_DPR_ON_dBm
14	WCDMA	2	23.5	100	1	22	21	20
15	WCDMA	2	23.5	100	1	22	21	18
16	WCDMA	2	23.5	100	1	22	19	18
17	WCDMA	2	23.5	100	1	22	19	16
18	WCDMA	2	23.5	100	1	18	17	16
19	WCDMA	2	23.5	100	1	18	17	14
20	WCDMA	2	23.5	100	1	18	15	14
21	WCDMA	2	23.5	100	1	18	15	12
22	WCDMA	2	23.5	100	1	13	12	11
23	WCDMA	2	23.5	100	1	13	12	9
24	WCDMA	2	23.5	100	1	13	10	9
25	WCDMA	2	23.5	100	1	13	10	7
26	WCDMA	2	23.5	360	1	18	17	14

Note: The Average power is calculated using the measured instantaneous power and compared to the UpperThreshold Plus Tune-Up Tolerance. This is applied for all the test cases in this report.

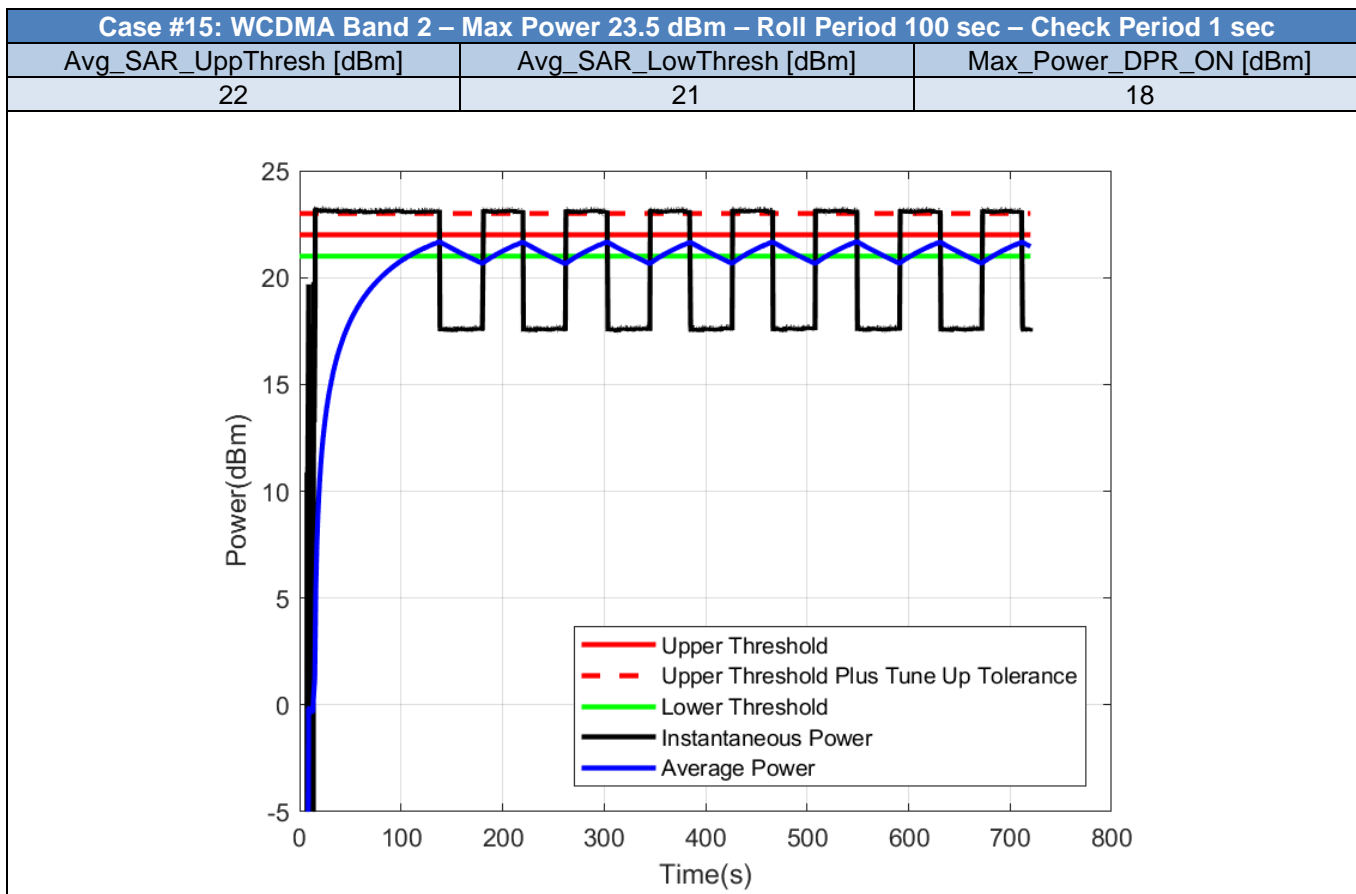
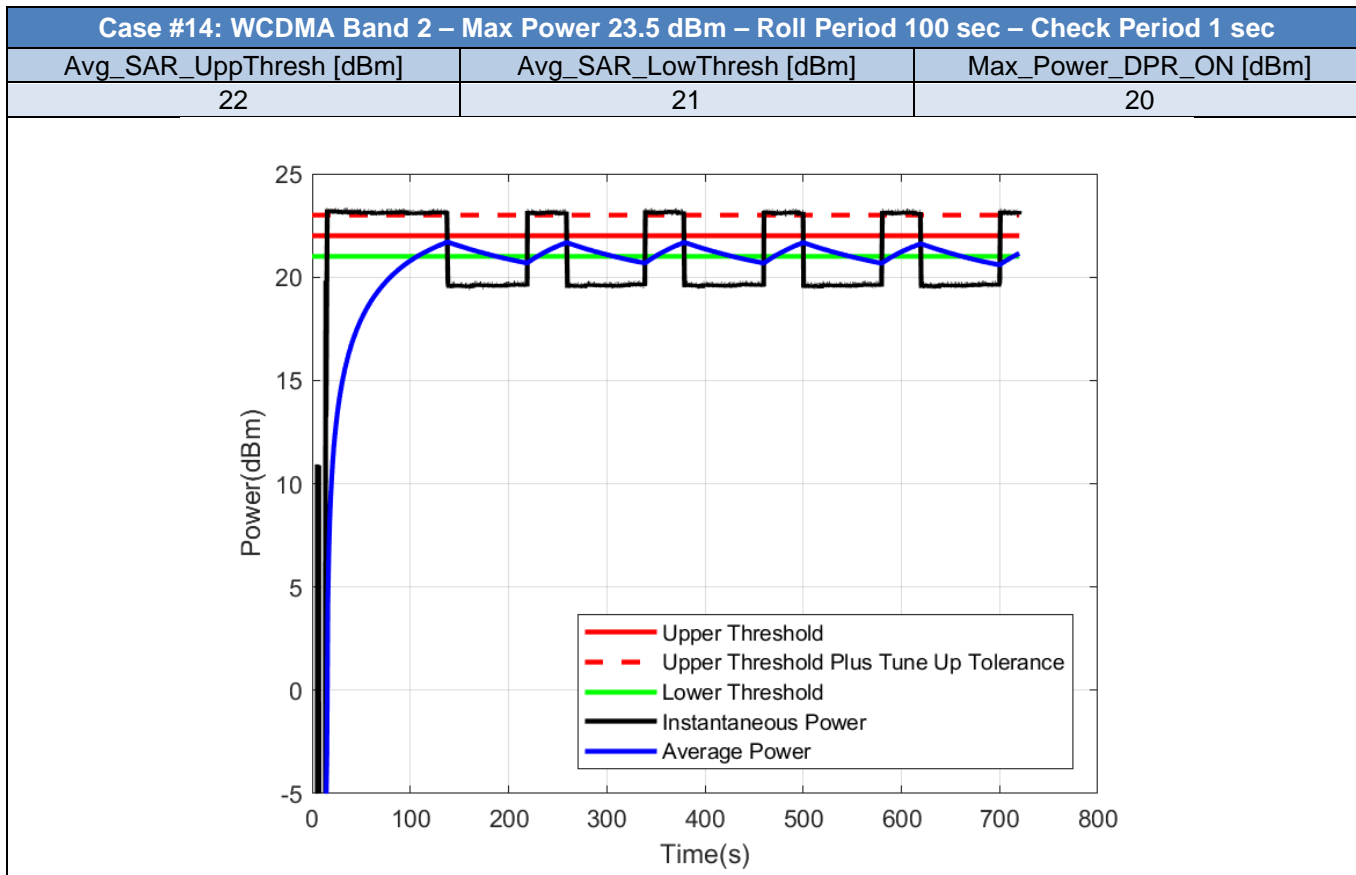

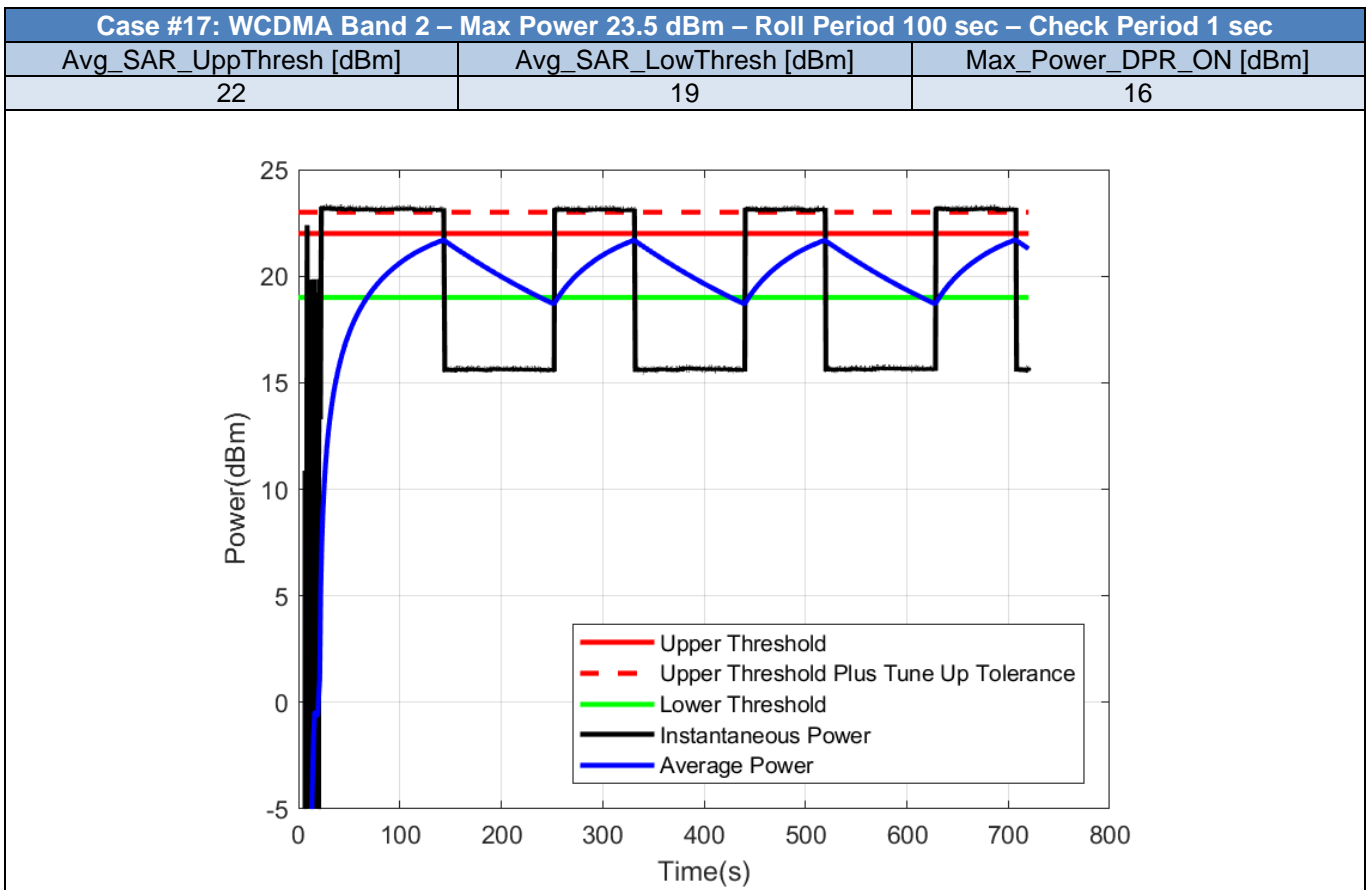
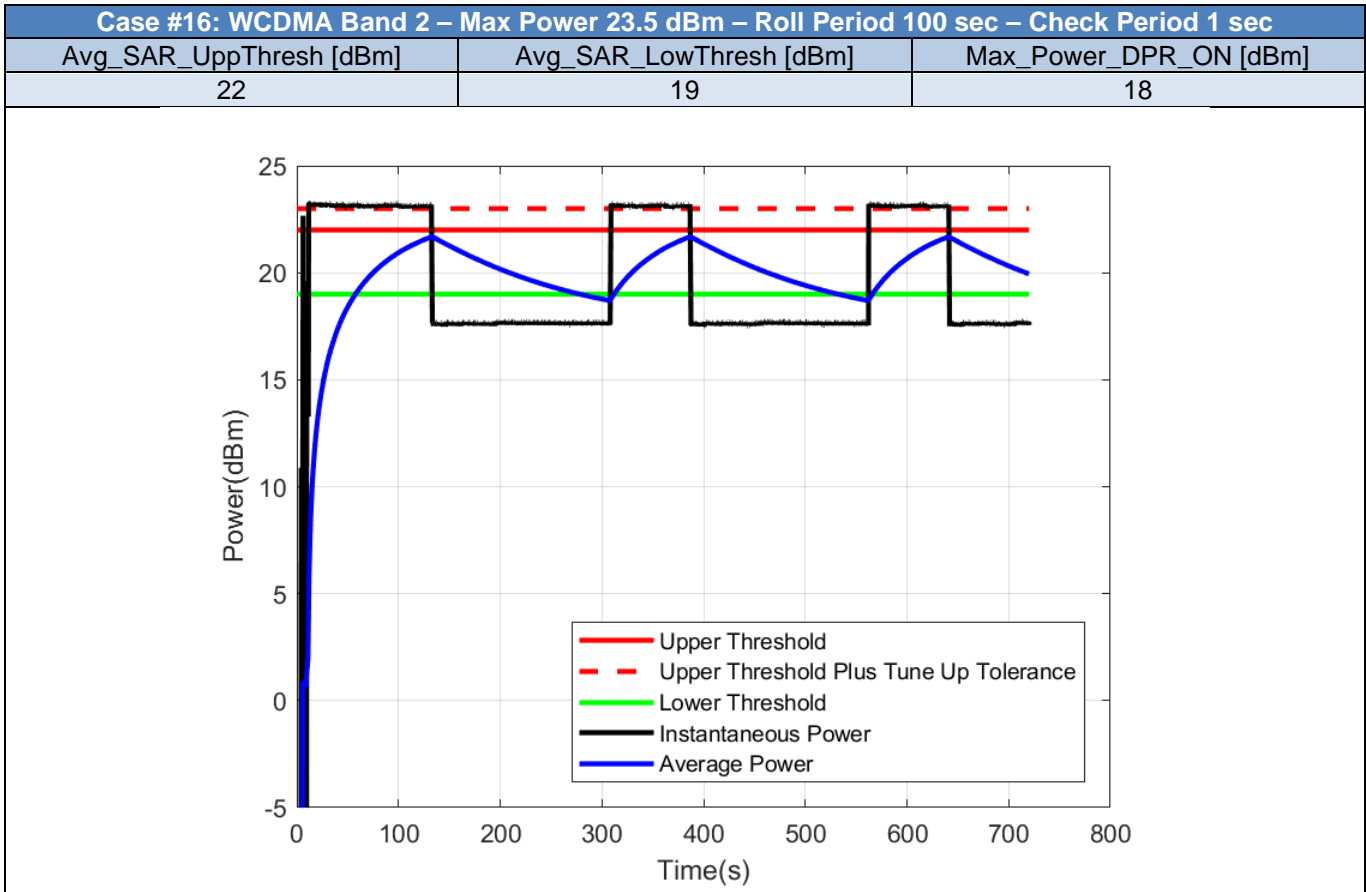

Case #18: WCDMA Band 2 – Max Power 23.5 dBm – Roll Period 100 sec – Check Period 1 sec		
Avg_SAR_UppThresh [dBm]	Avg_SAR_LowThresh [dBm]	Max_Power_DPR_ON [dBm]
18	17	16

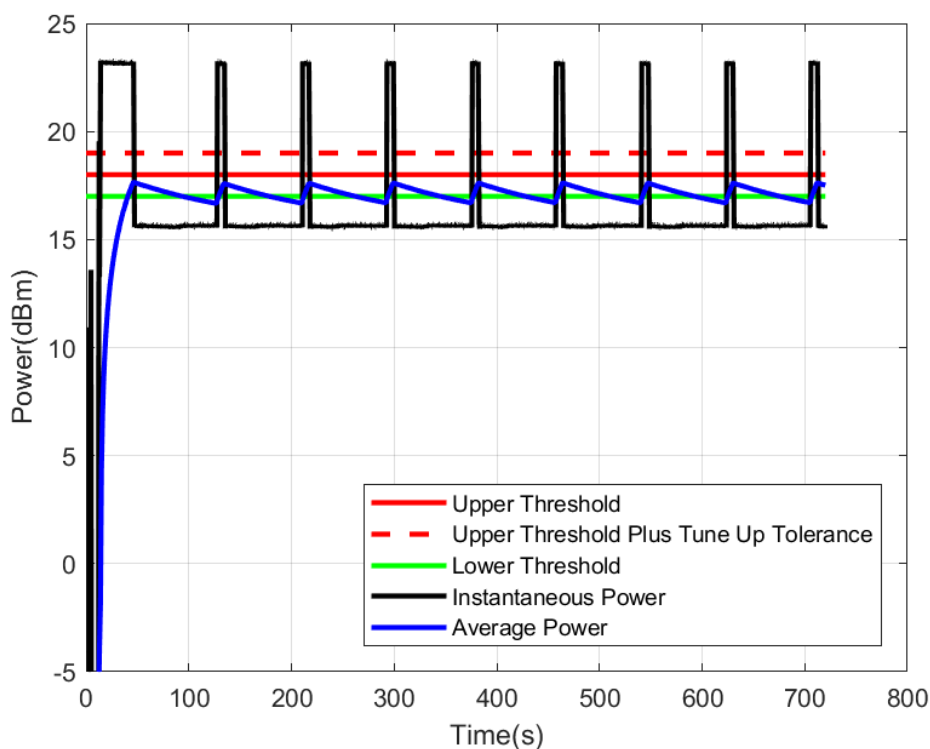

Case #19: WCDMA Band 2 – Max Power 23.5 dBm – Roll Period 100 sec – Check Period 1 sec		
Avg_SAR_UppThresh [dBm]	Avg_SAR_LowThresh [dBm]	Max_Power_DPR_ON [dBm]
18	17	14

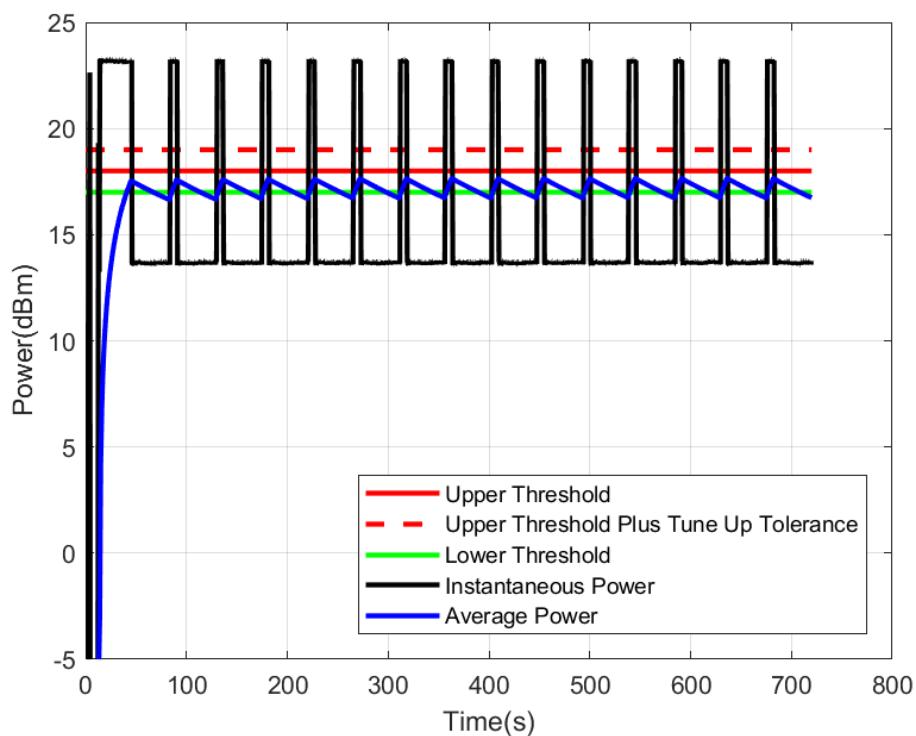

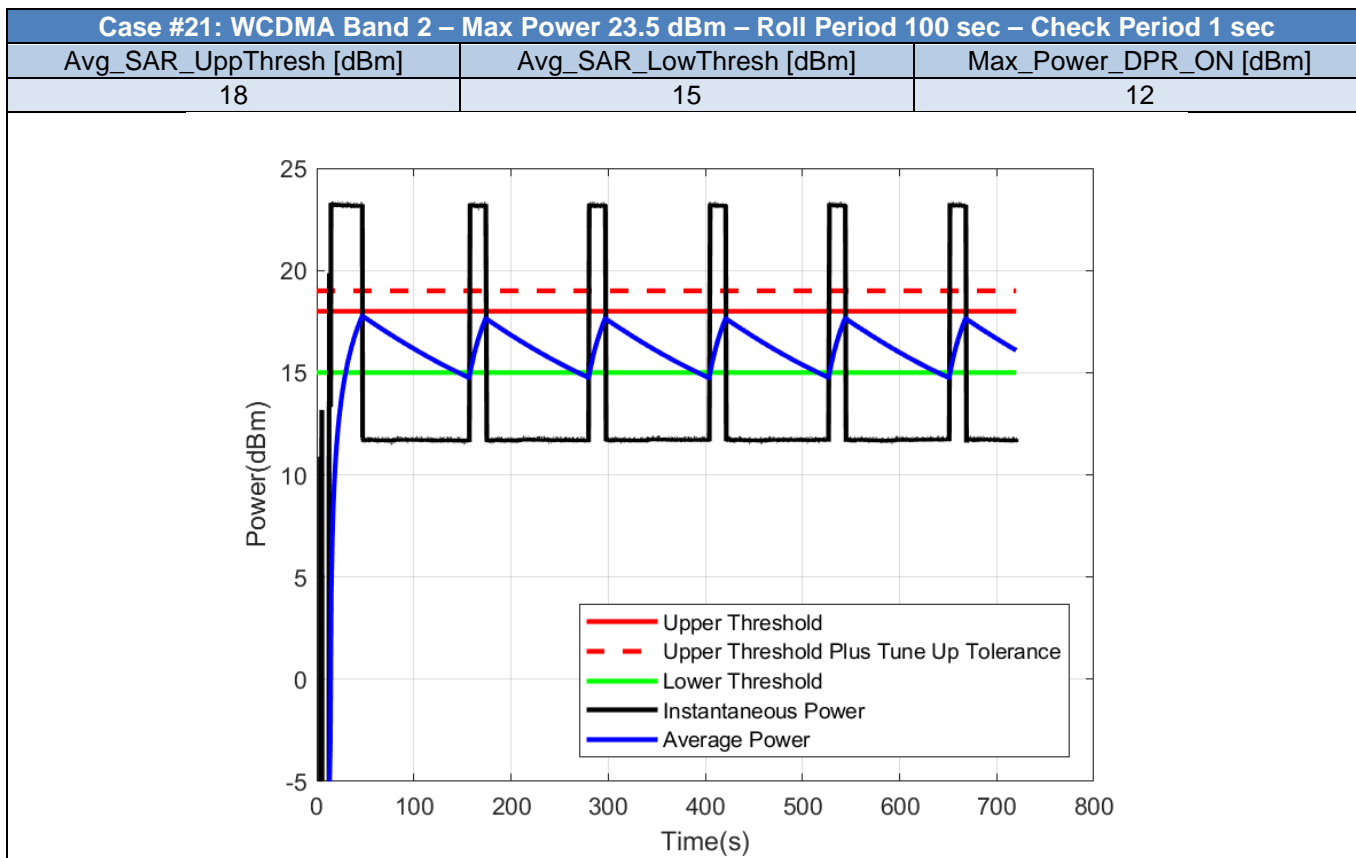
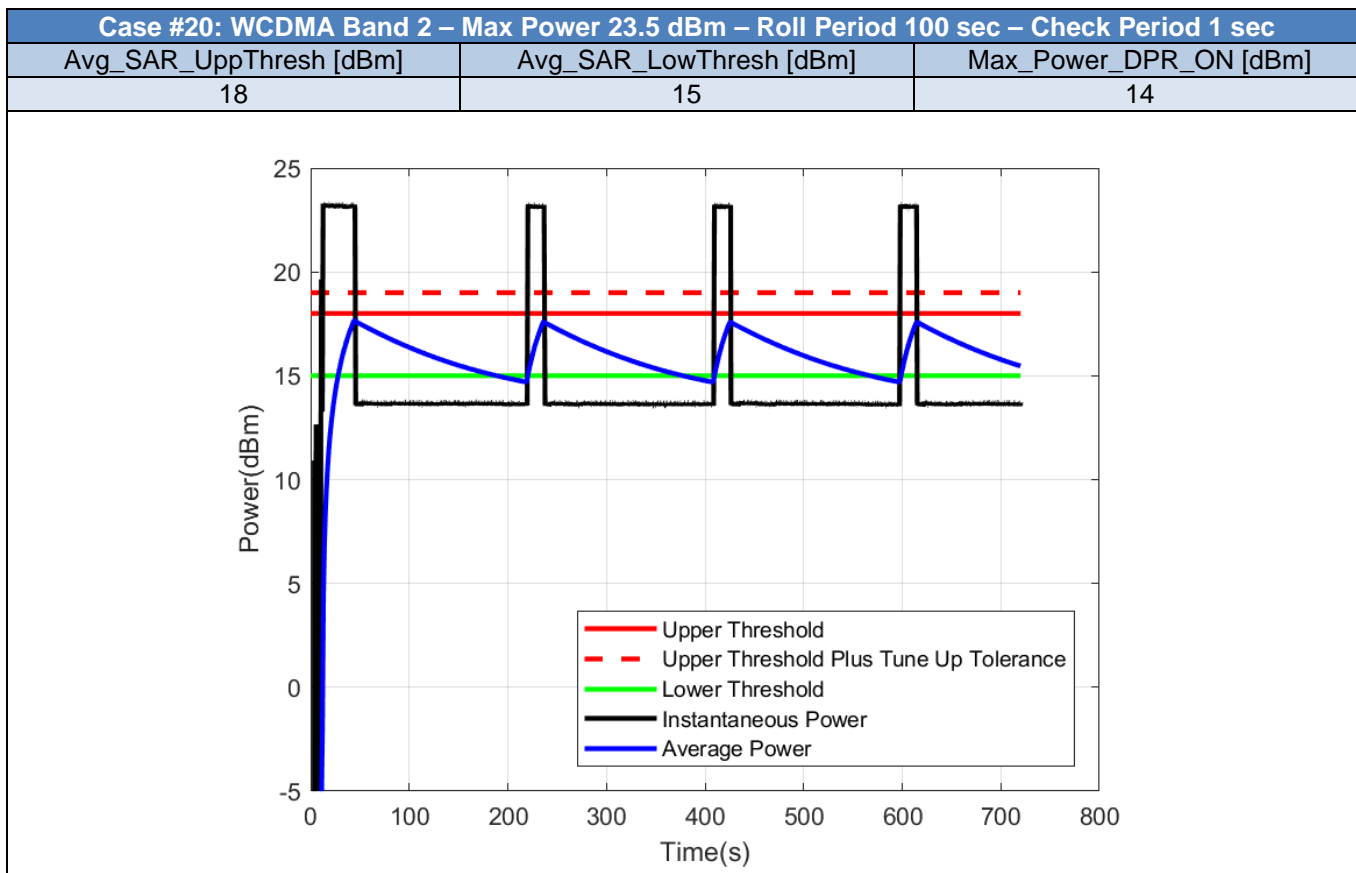

Case #22: WCDMA Band 2 – Max Power 23.5 dBm – Roll Period 100 sec – Check Period 1 sec		
Avg_SAR_UppThresh [dBm]	Avg_SAR_LowThresh [dBm]	Max_Power_DPR_ON [dBm]
13	12	11

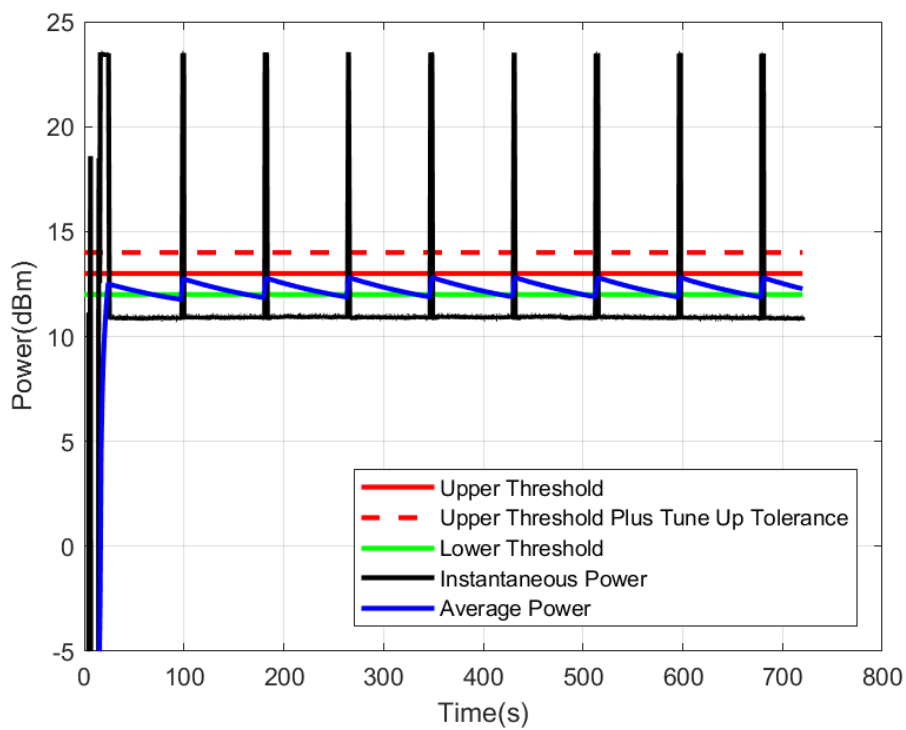

Case #23: WCDMA Band 2 – Max Power 23.5 dBm – Roll Period 100 sec – Check Period 1 sec		
Avg_SAR_UppThresh [dBm]	Avg_SAR_LowThresh [dBm]	Max_Power_DPR_ON [dBm]
13	12	9

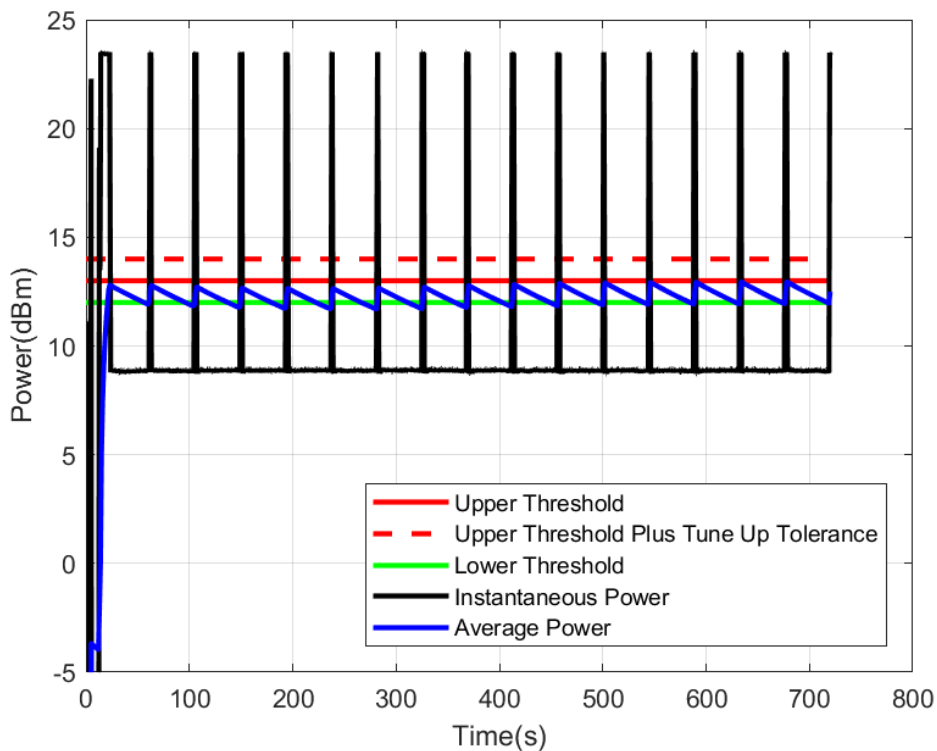

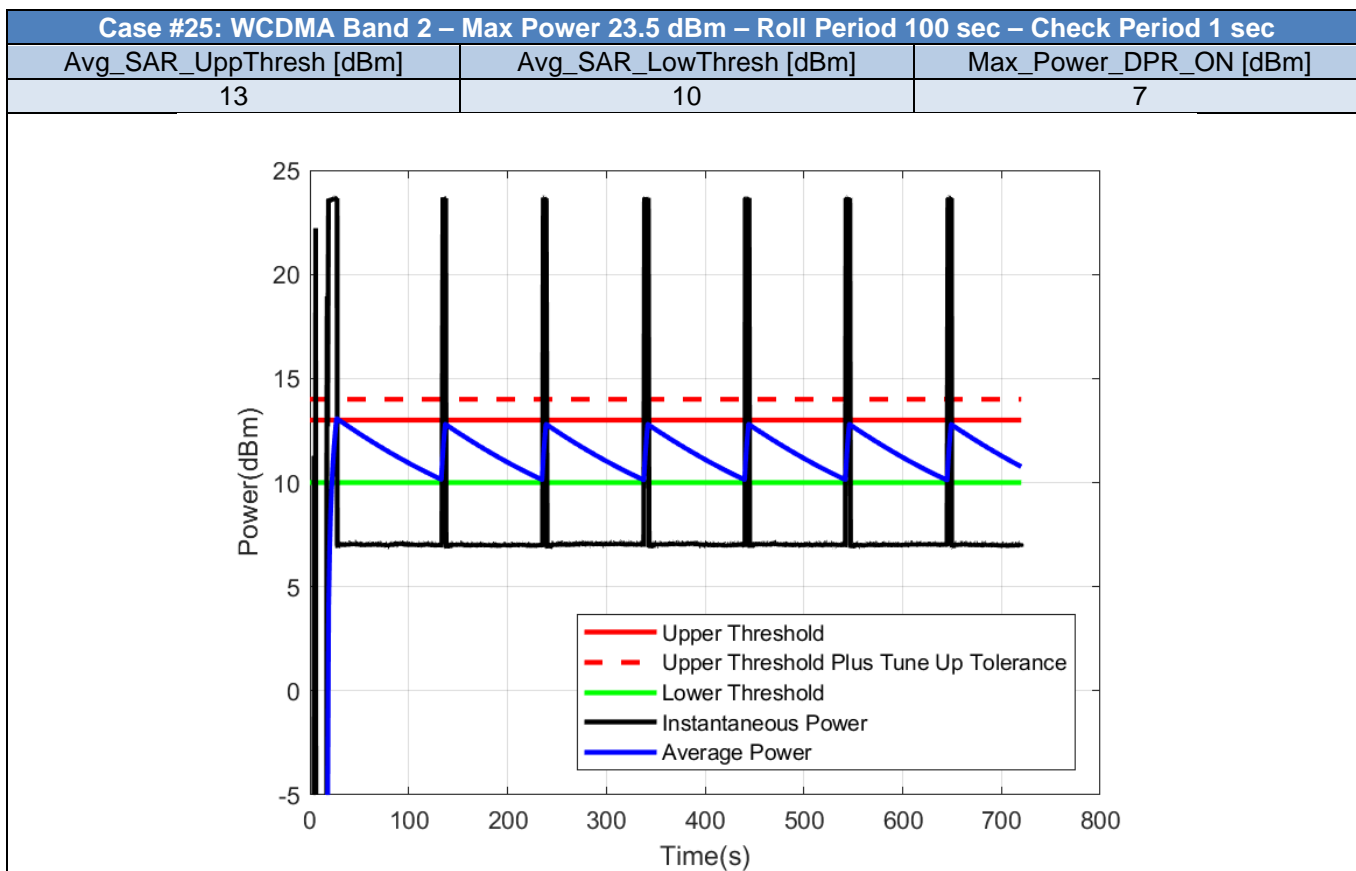
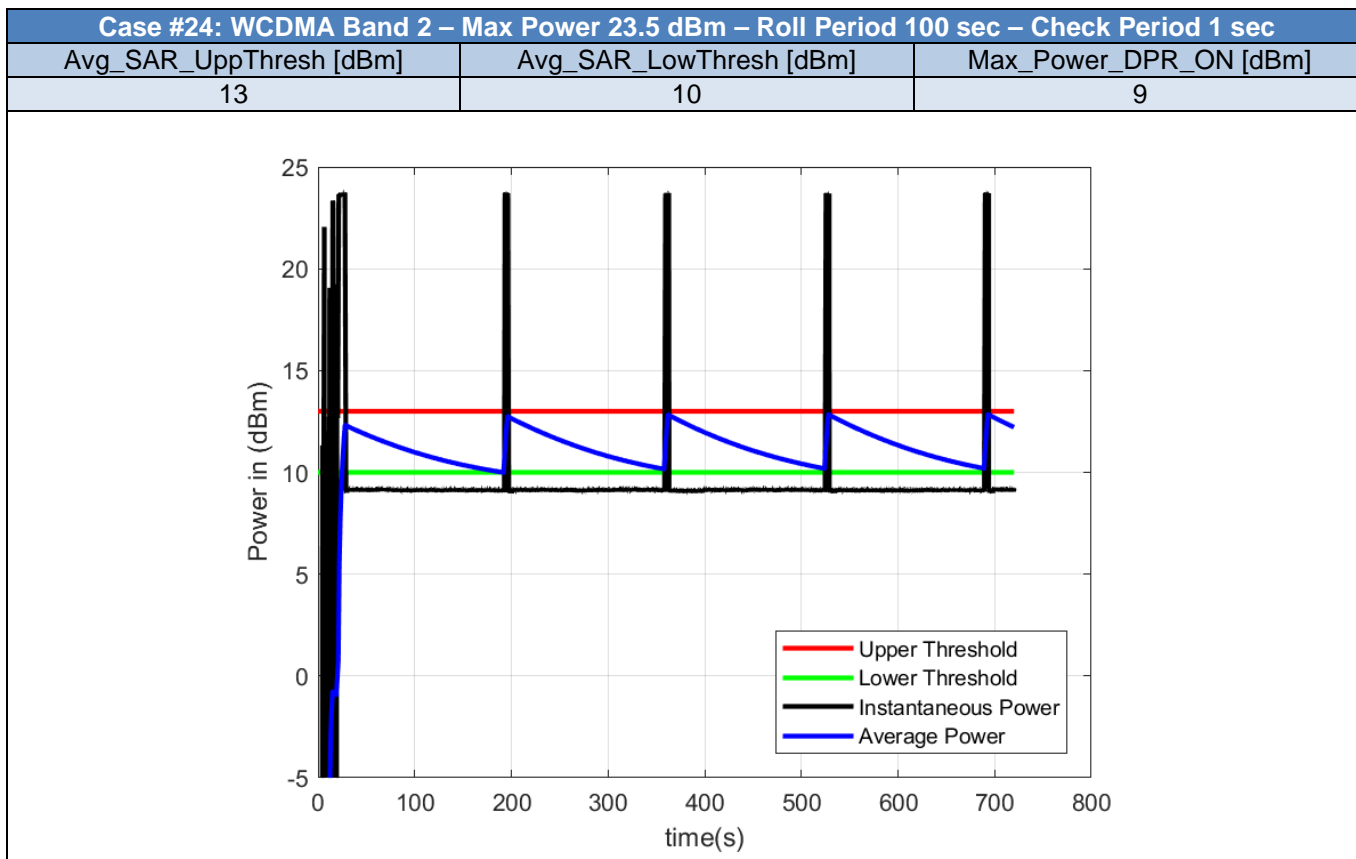

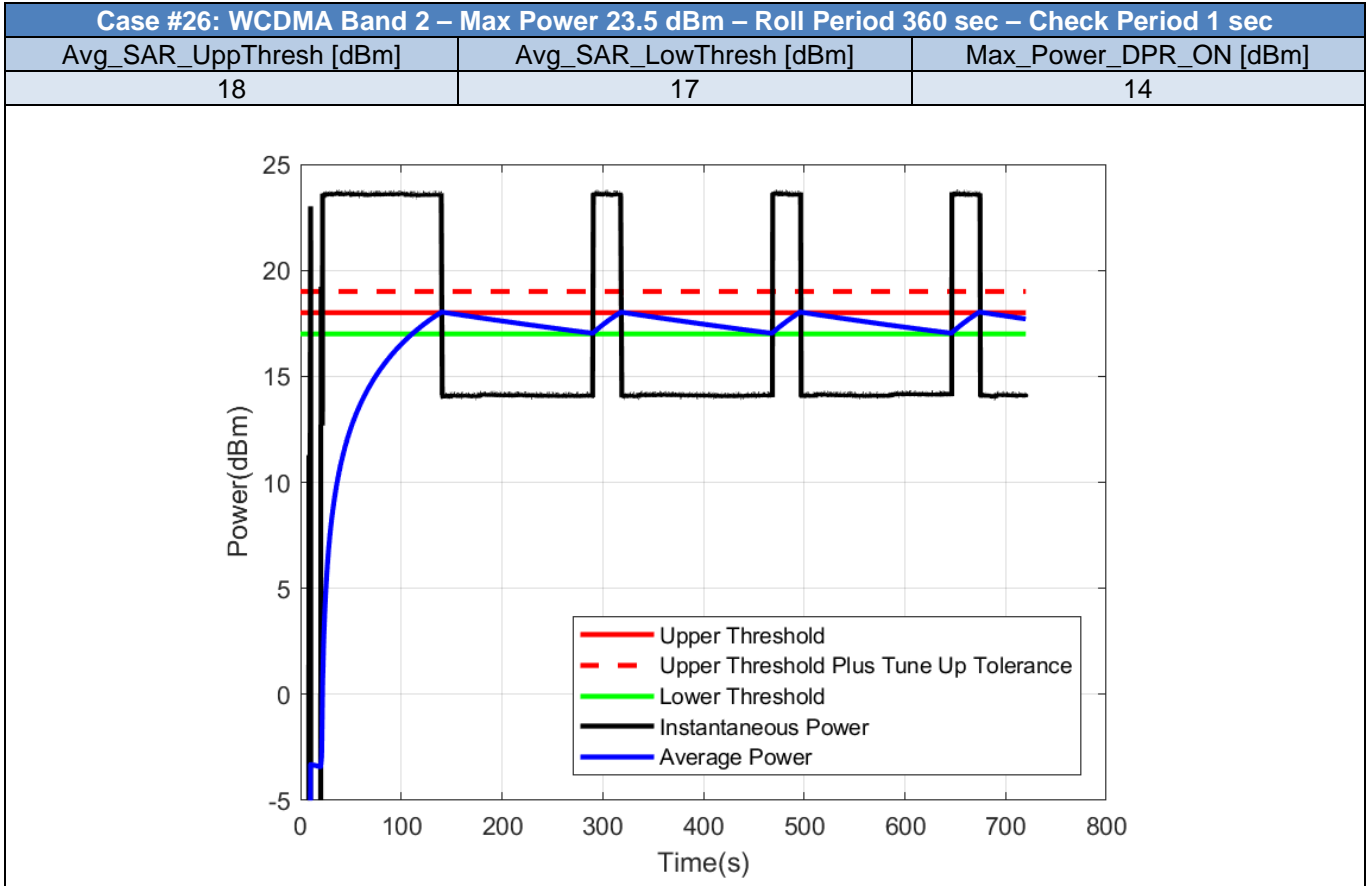

2.4. Bands Validation - LTE

Table 3 - Test Cases for Bands Compliance of LTE bands

Case	RAT	Band	Max_Power_DPR_OFF_dBm	Roll_Period_s	Check_Period_s	Avg_SAR_Upper_Threshold_dBm	Avg_SAR_Lower_Threshold_dBm	Max_Power_DPR_ON_dBm
1	LTE	1	23	100	1	20	19	18
2	LTE	2	23	100	1	20	19	18
3	LTE	3	23	100	1	20	19	18
4	LTE	4	23	100	1	20	19	18
5	LTE	5	23	100	1	20	19	18
6	LTE	7	23	100	1	20	19	18
7	LTE	8	23	100	1	20	19	18
8	LTE	11	23	100	1	20	19	18
9	LTE	12	23	100	1	20	19	18
10	LTE	13	23	100	1	20	19	18
11	LTE	17	23	100	1	20	19	18
12	LTE	18	23	100	1	20	19	18
13	LTE	19	23	100	1	20	19	18
14	LTE	20	23	100	1	20	19	18
15	LTE	21	23	100	1	20	19	18
16	LTE	26	23	100	1	20	19	18
17	LTE	28	23	100	1	20	19	18
18	LTE	30	23	100	1	20	19	18
19	LTE	38	23	100	1	16	15	14
20	LTE	39	23	100	1	16	15	14
21	LTE	40	23	100	1	16	15	14
22	LTE	41	23	100	1	16	15	14
23	LTE	66	23	100	1	20	19	18

Note: The Average power is calculated using the measured instantaneous power and compared to the UpperThreshold Plus Tune-Up Tolerance. This is applied for all the test cases in this report.

Case #1: LTE Band 1 – Max Power 23 dBm – Roll Period 100 sec – Check Period 1 sec		
Avg_SAR_UppThresh [dBm]	Avg_SAR_LowThresh [dBm]	Max_Power_DPR_ON [dBm]
20	19	18

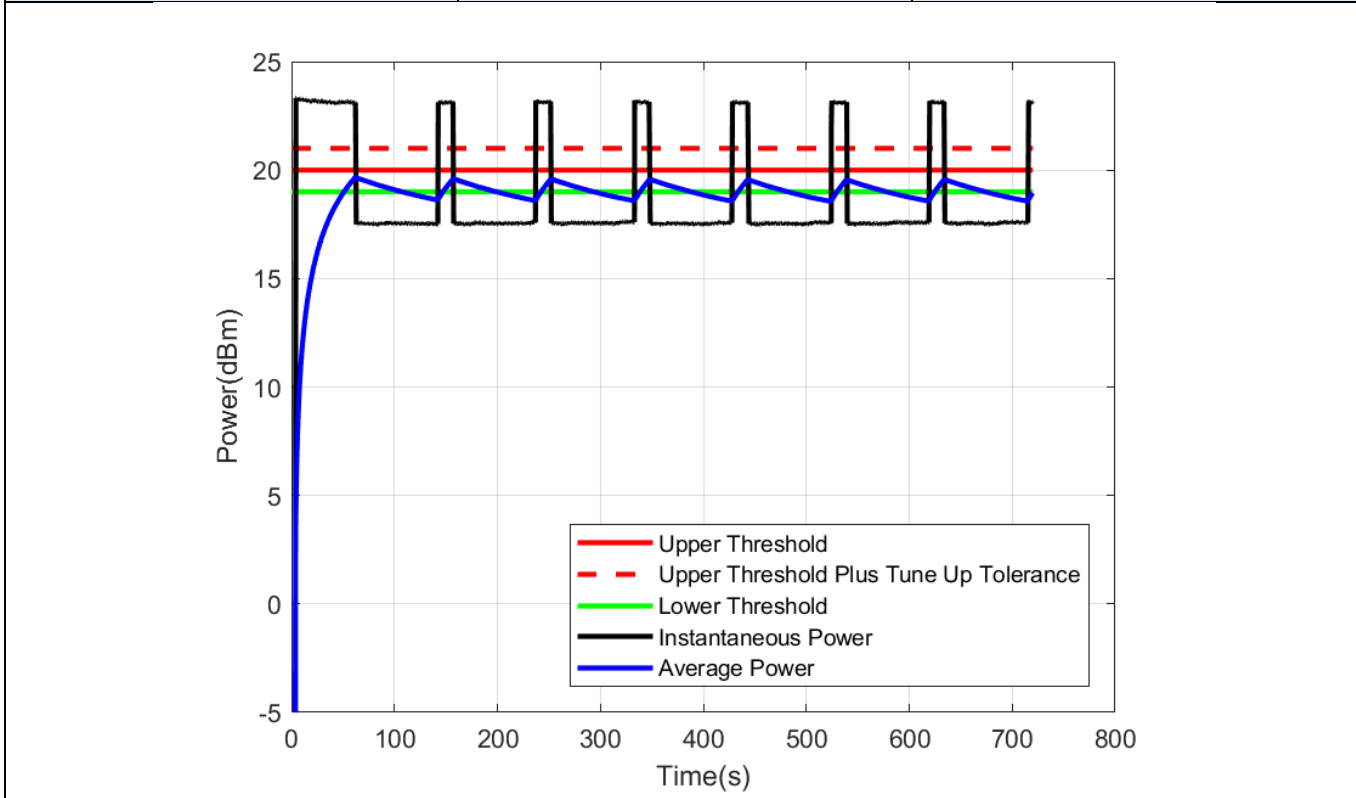

Case #2: LTE Band 2 – Max Power 23 dBm – Roll Period 100 sec – Check Period 1 sec		
Avg_SAR_UppThresh [dBm]	Avg_SAR_LowThresh [dBm]	Max_Power_DPR_ON [dBm]
20	19	18

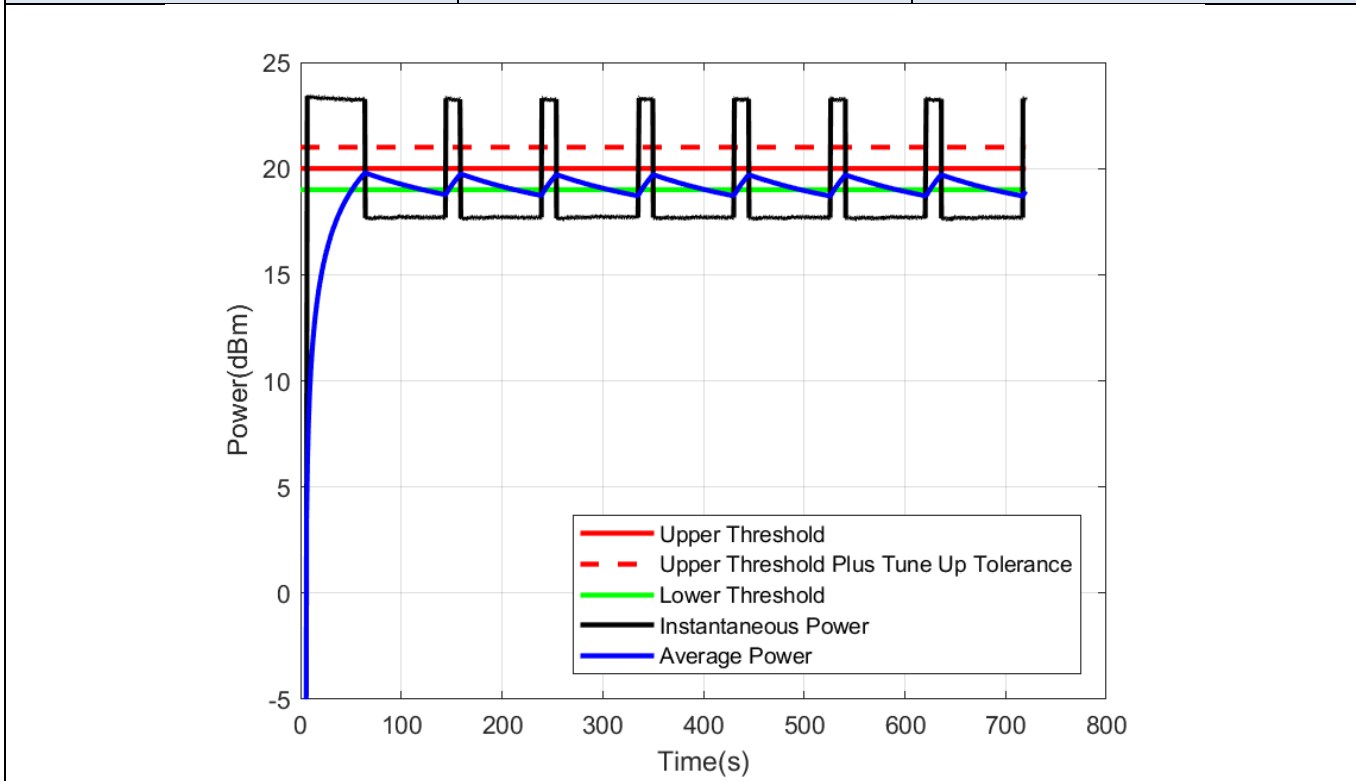

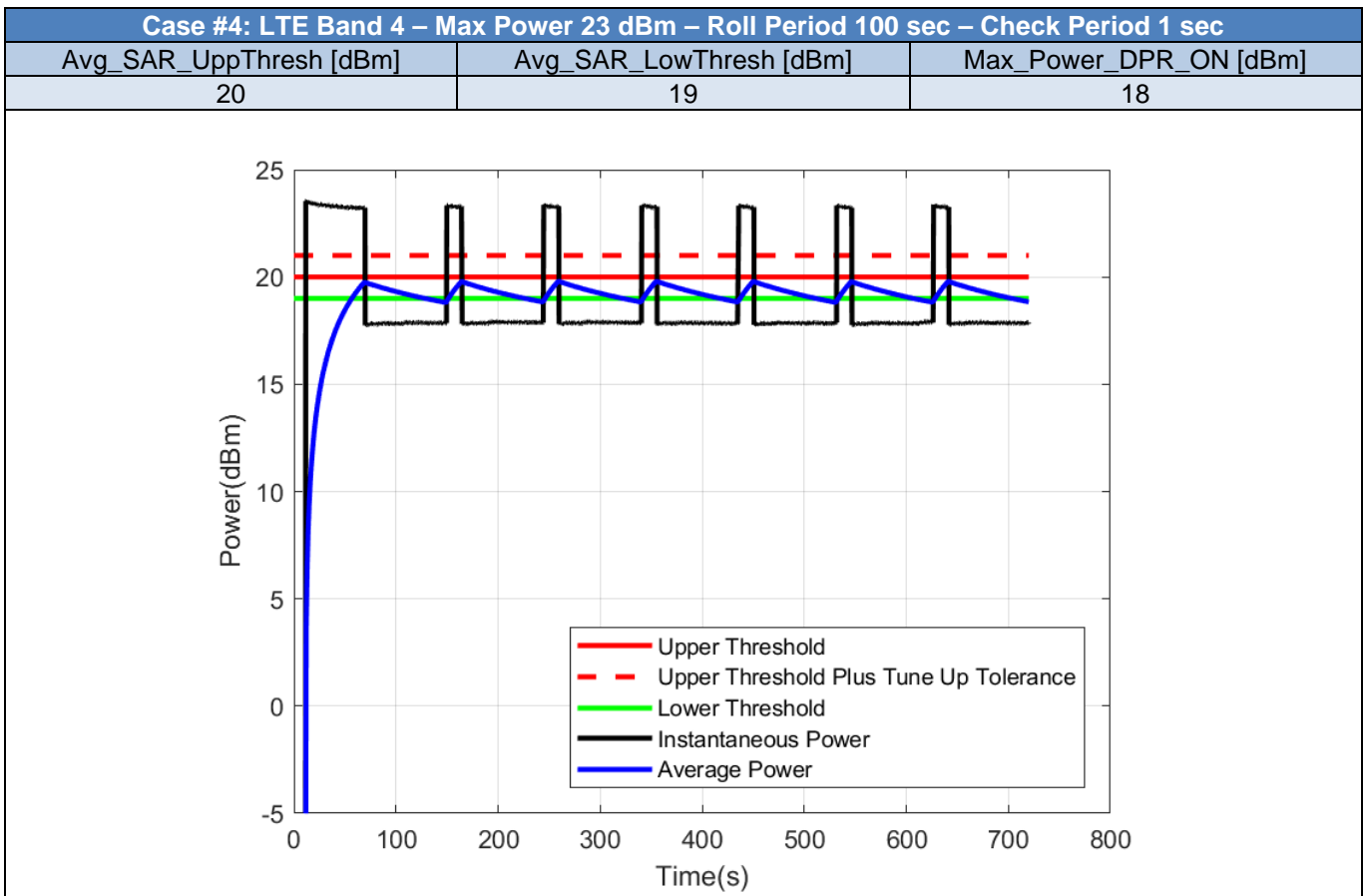
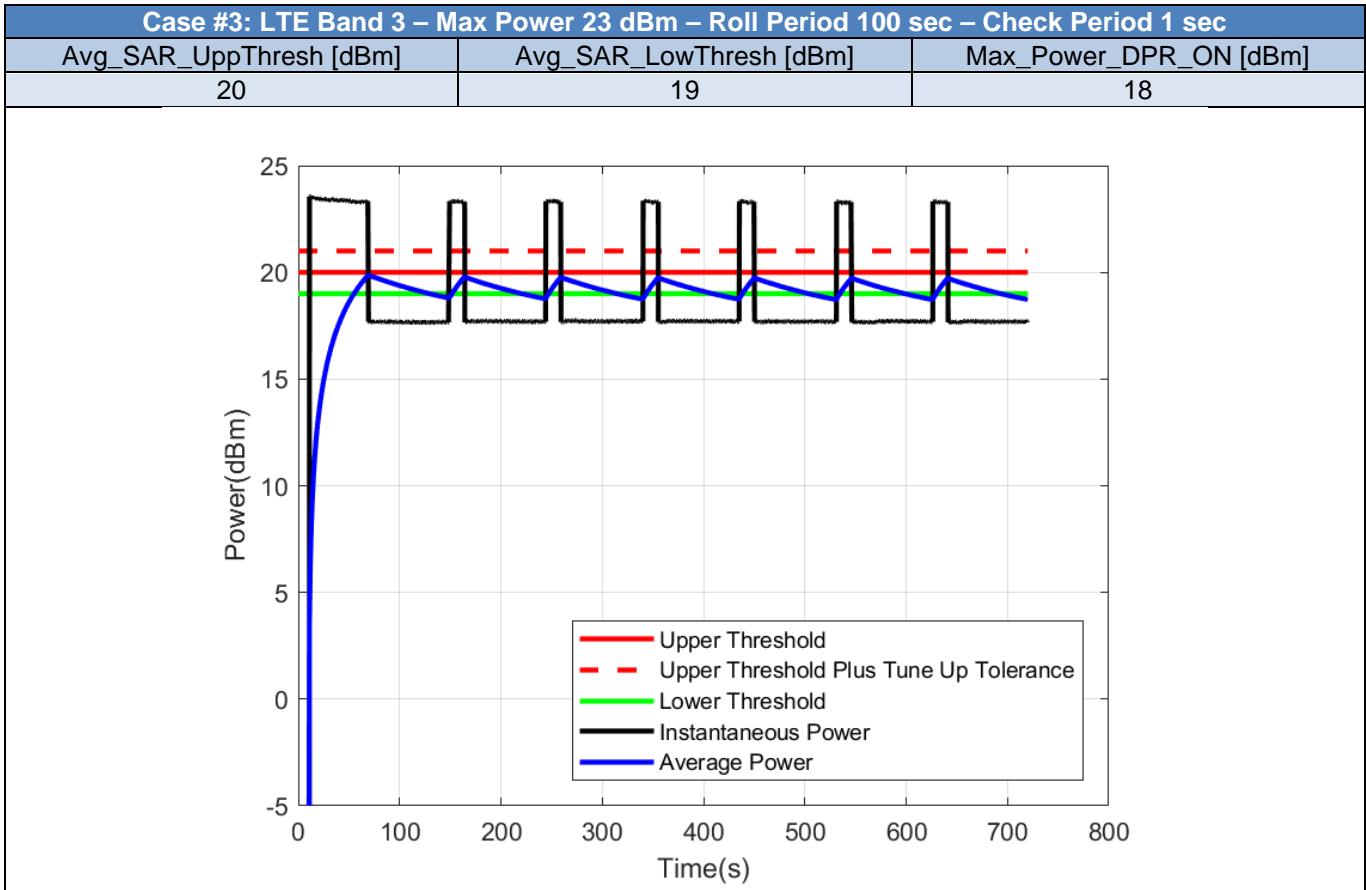

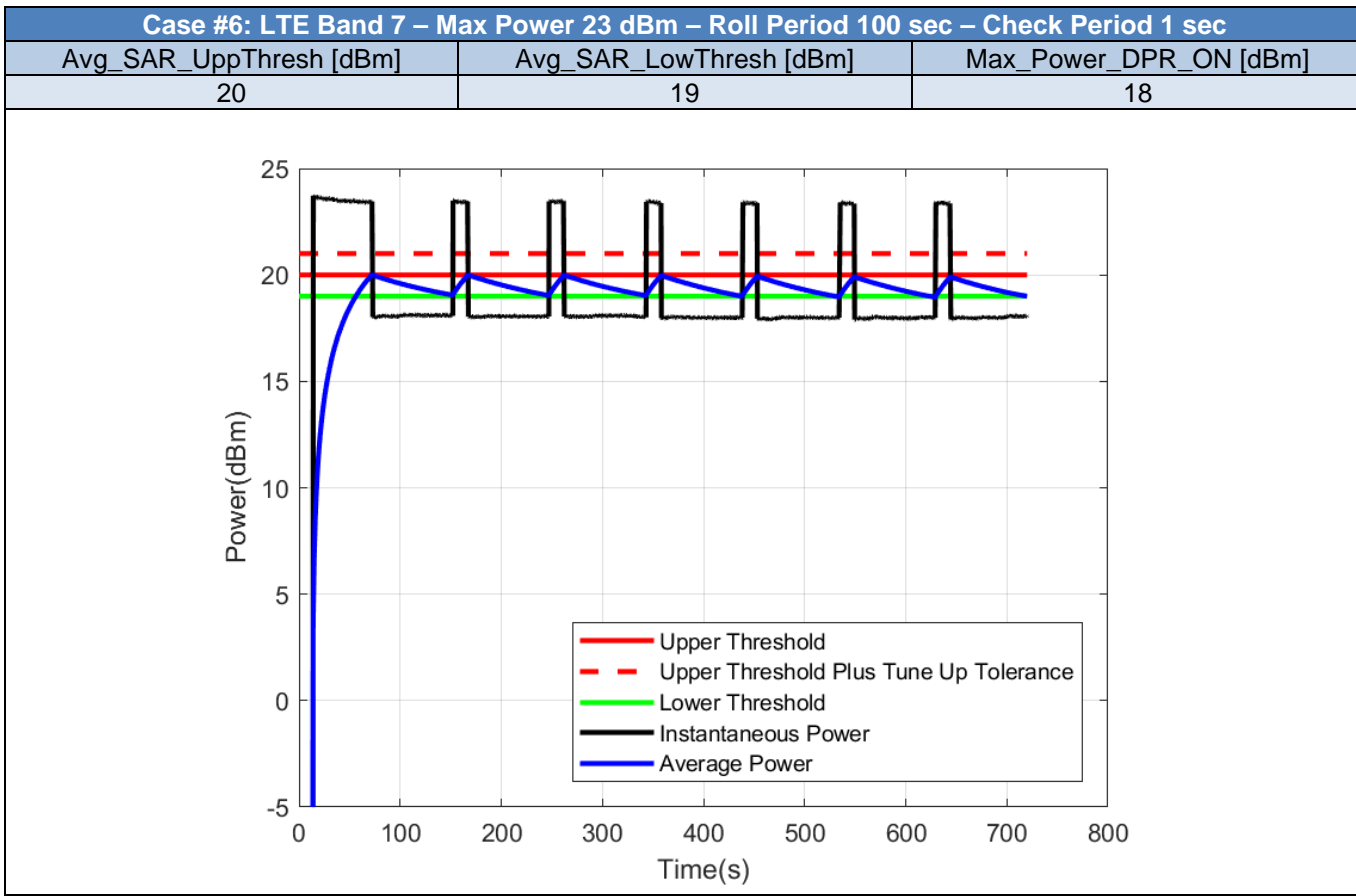
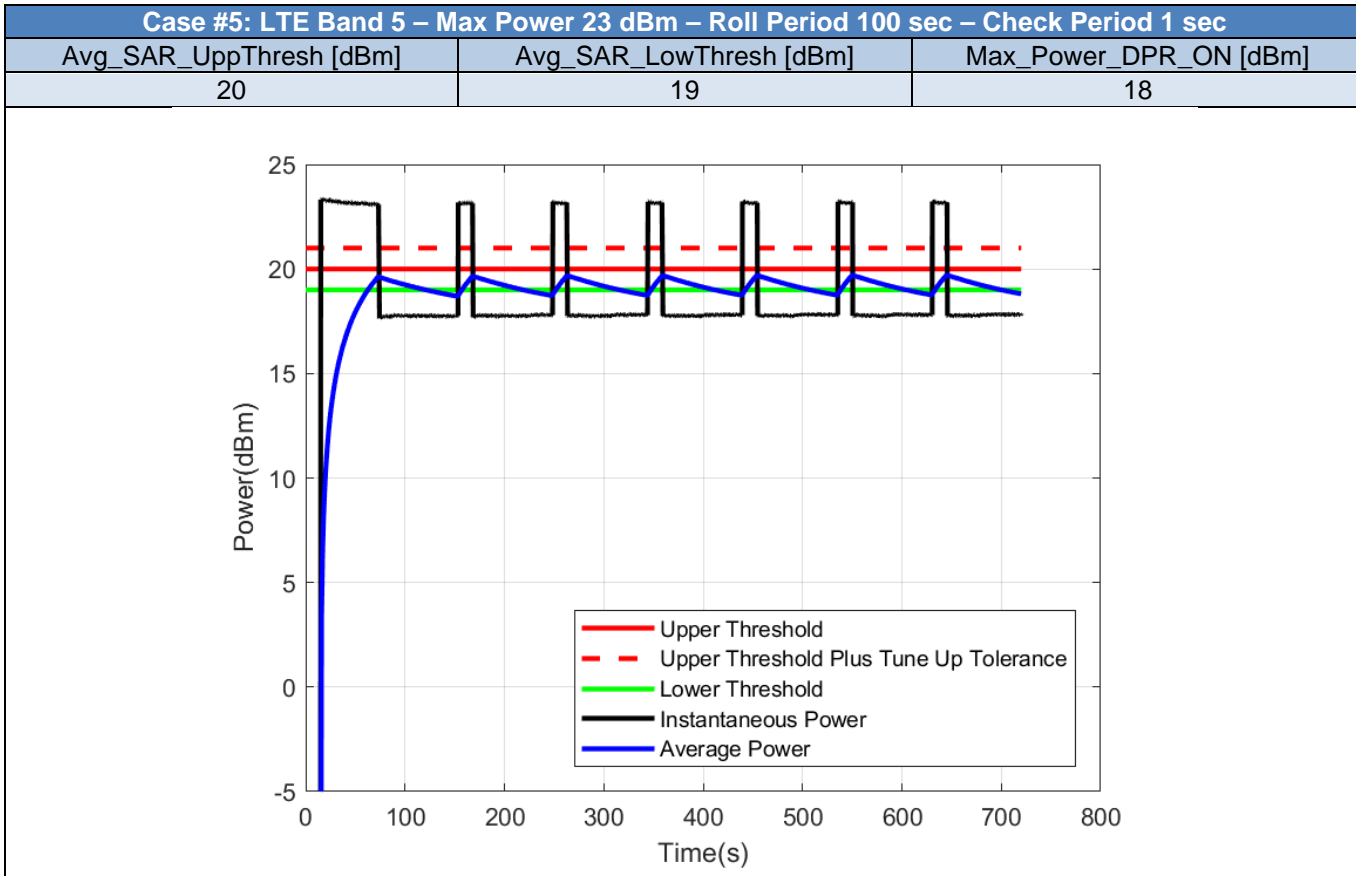

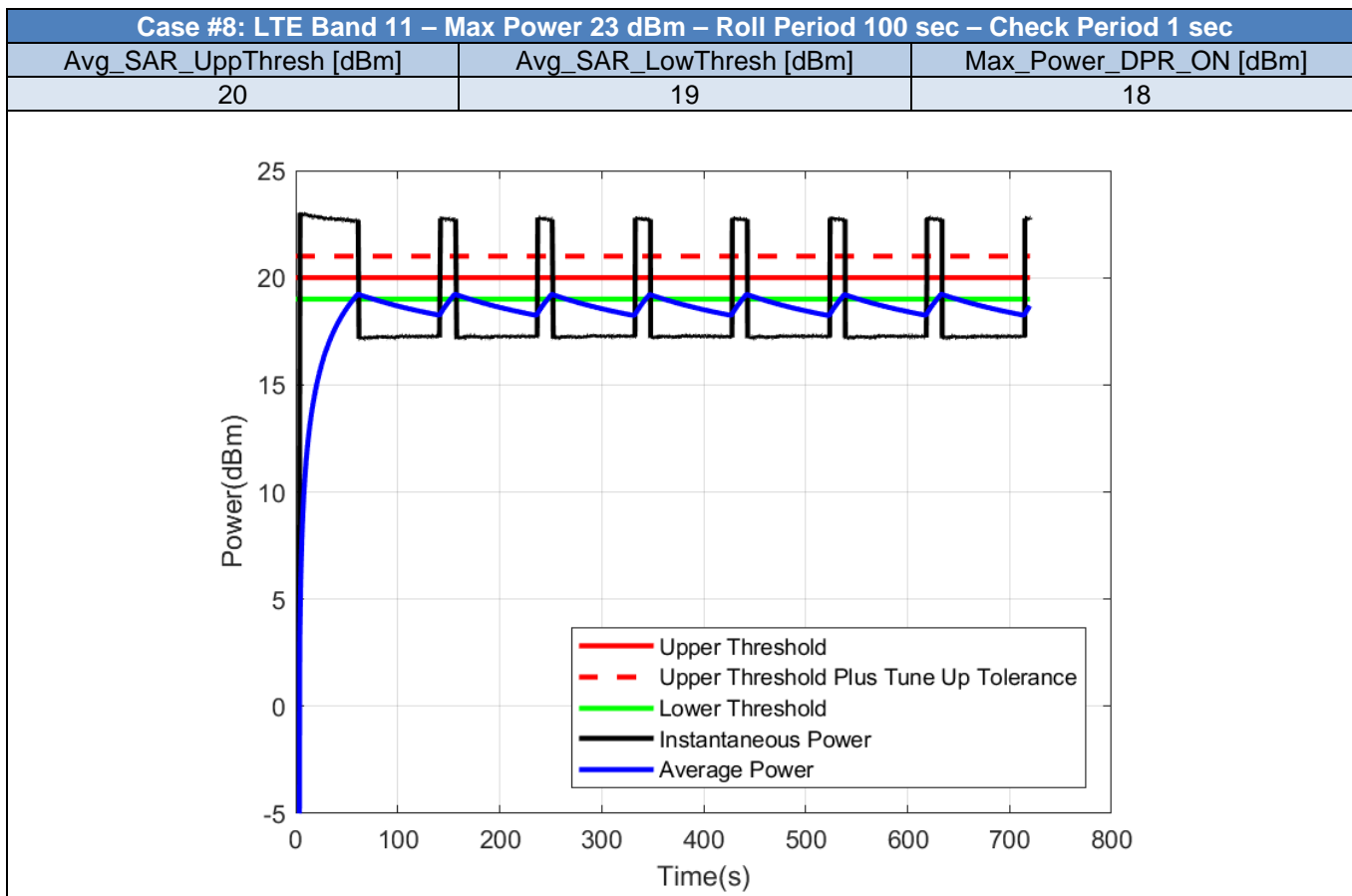
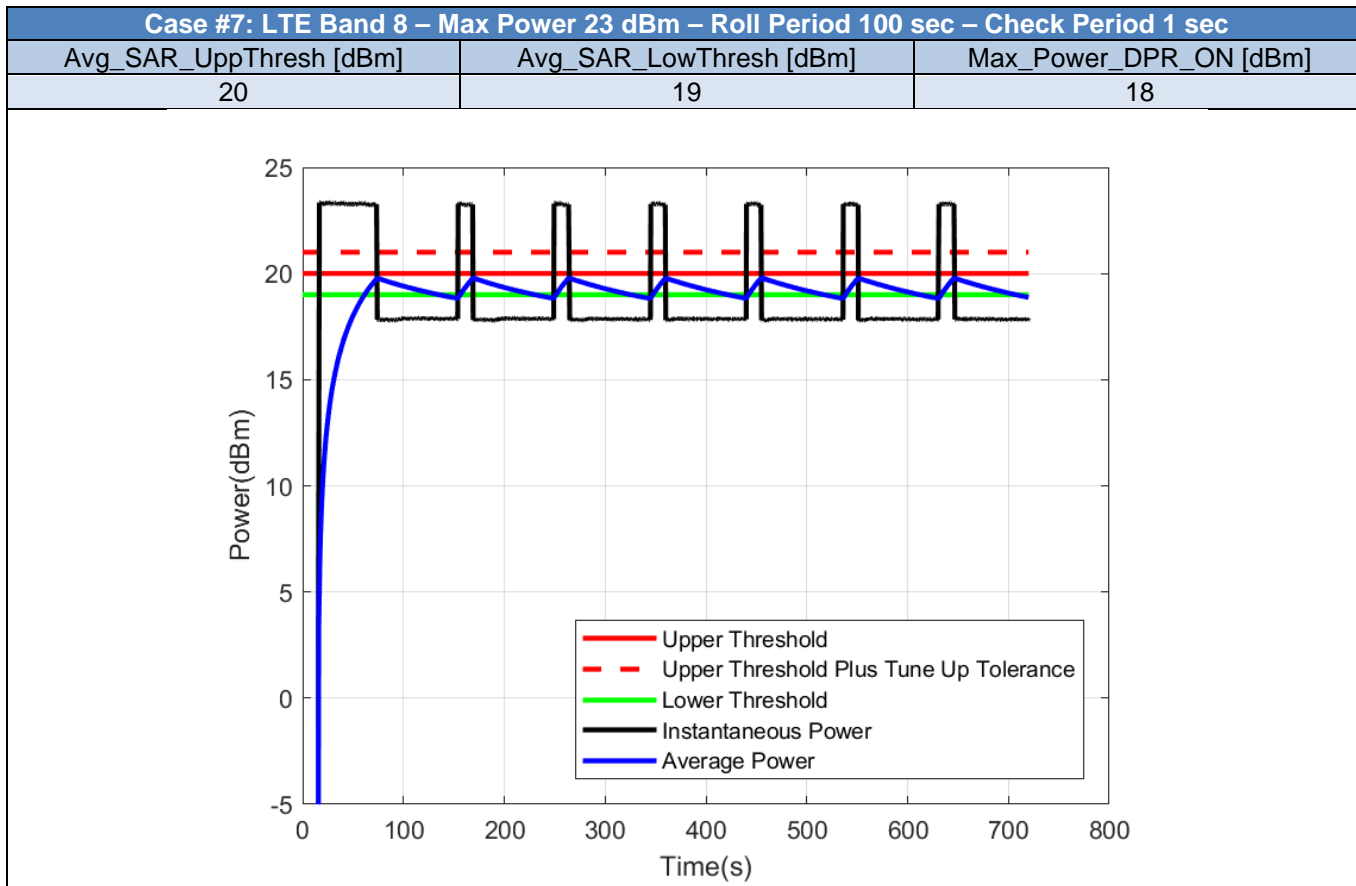

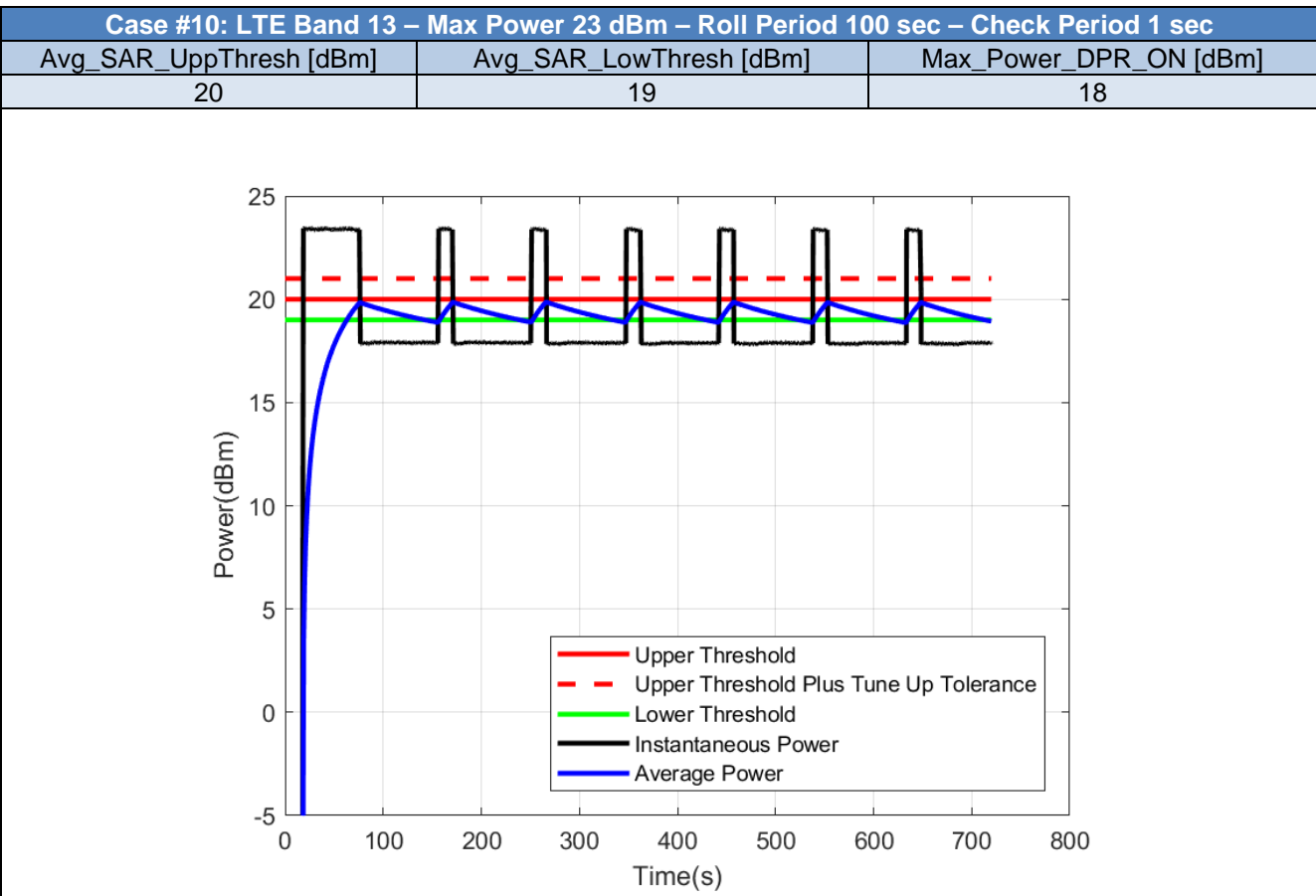
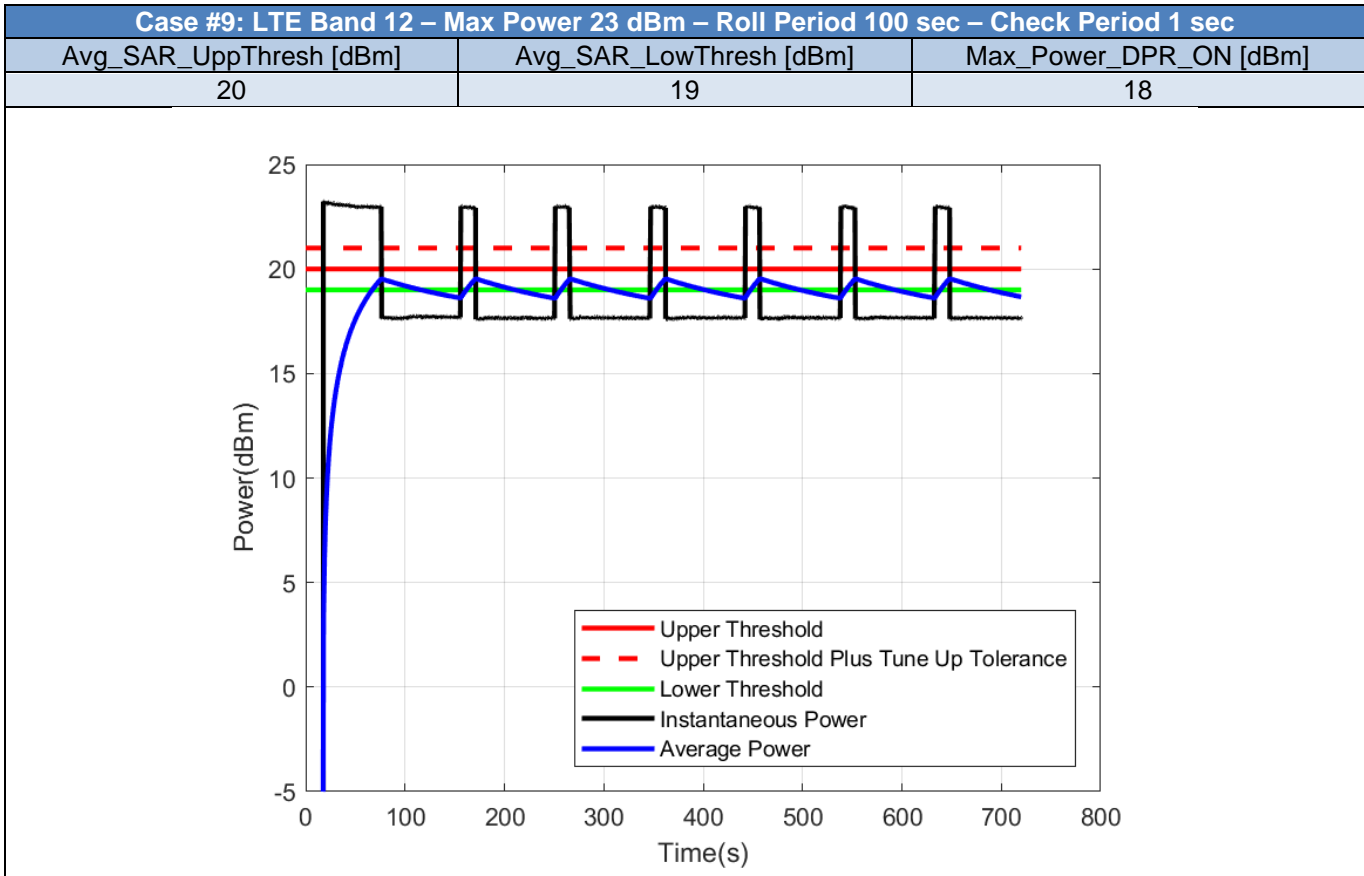

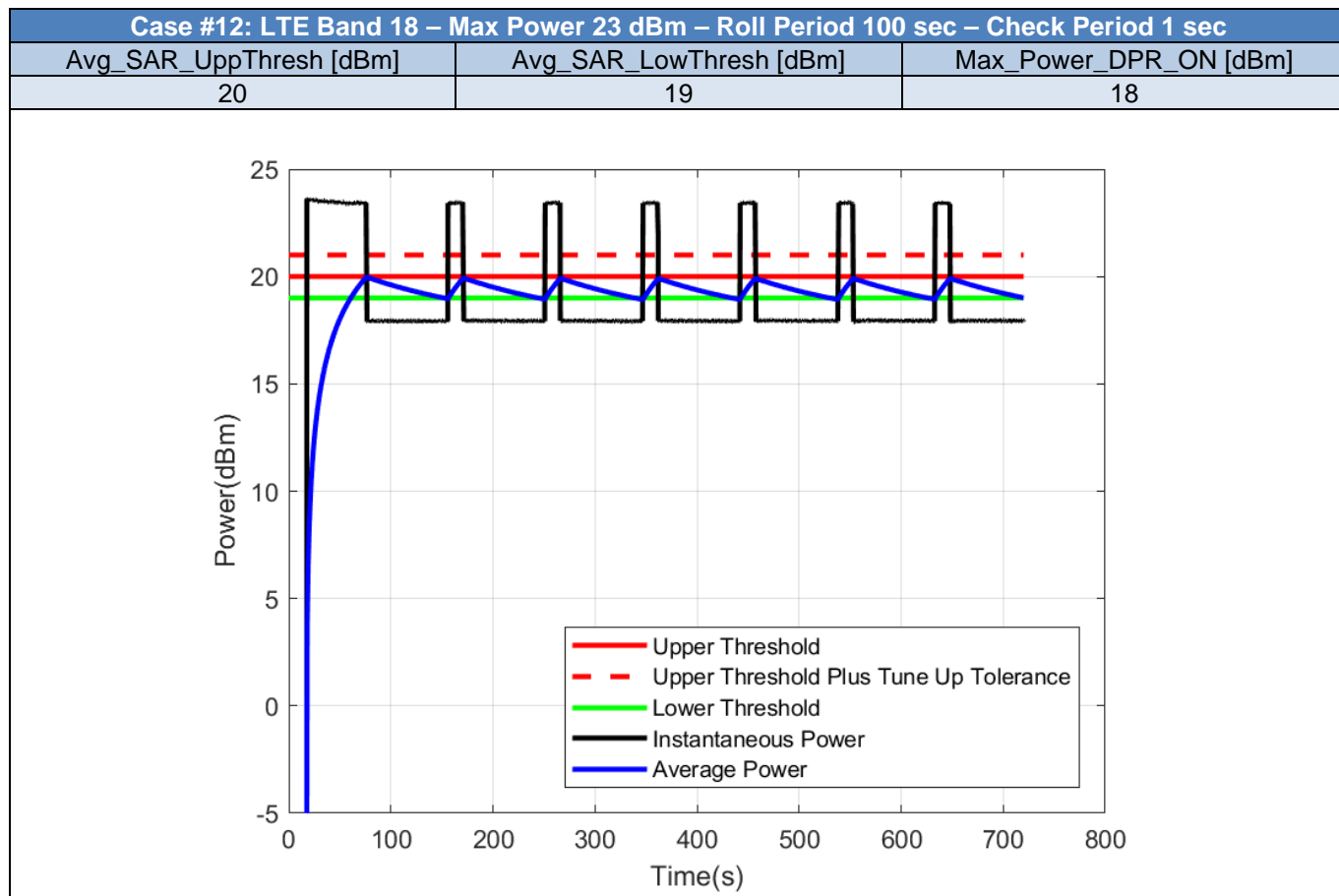
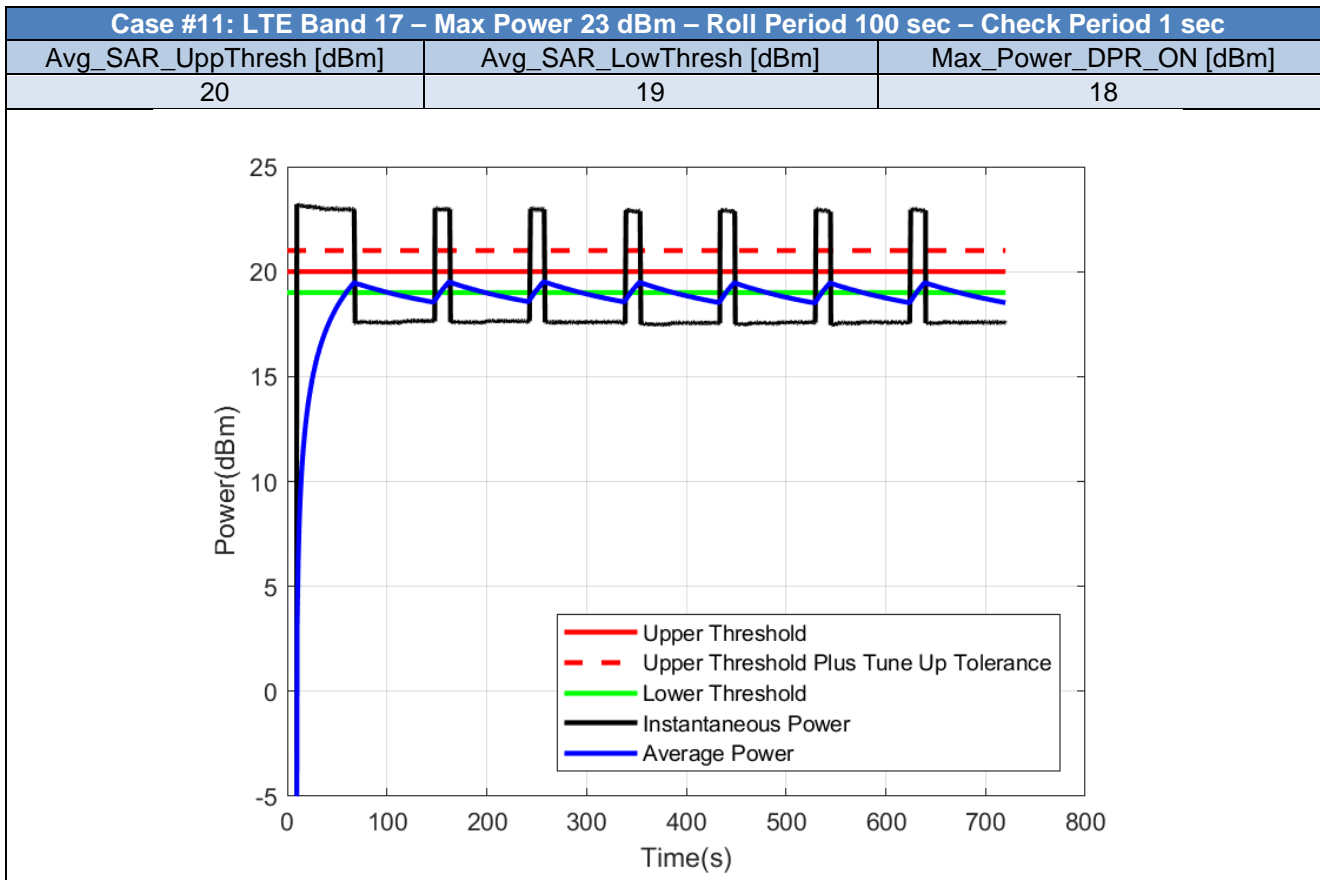

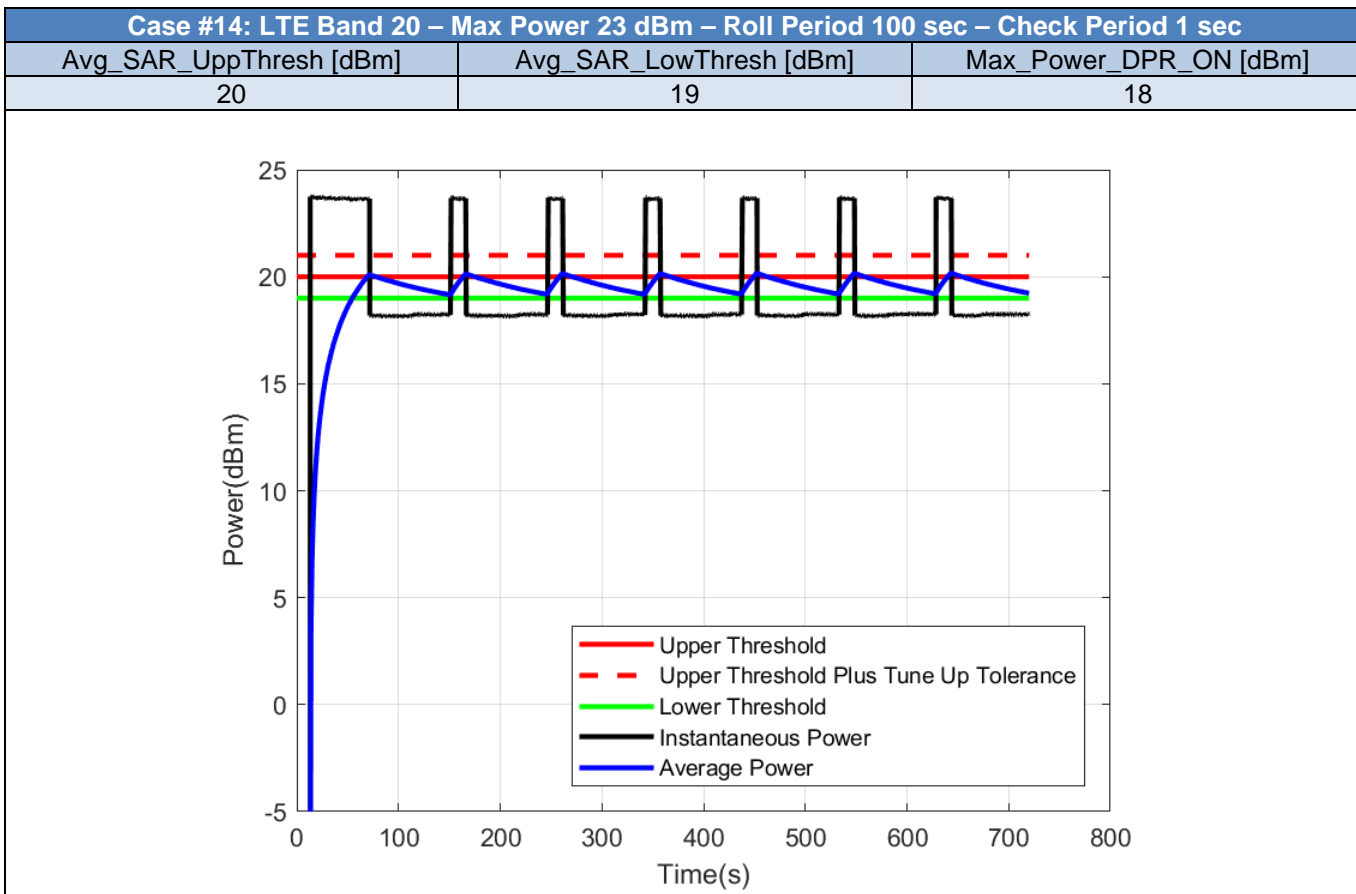
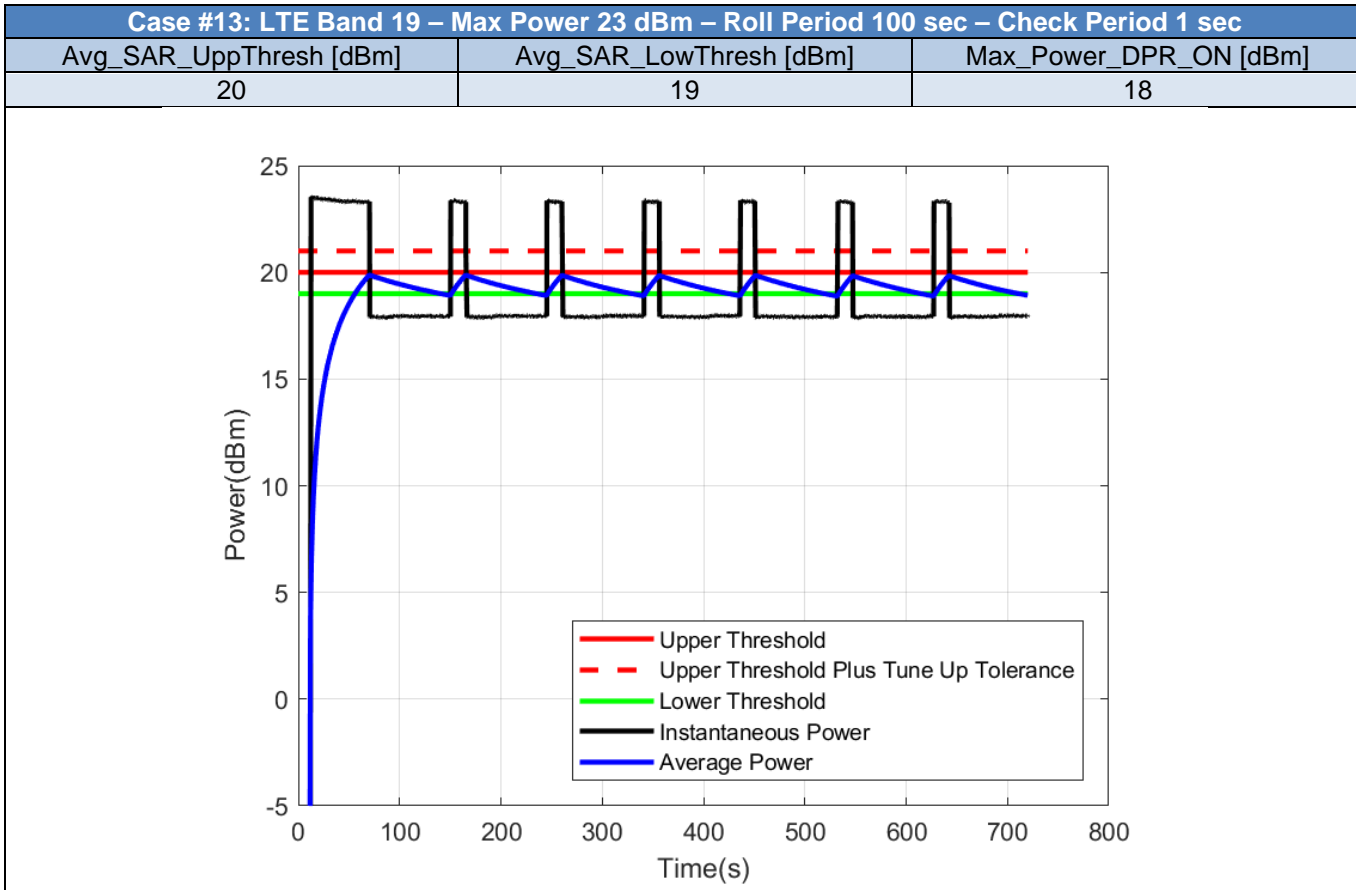

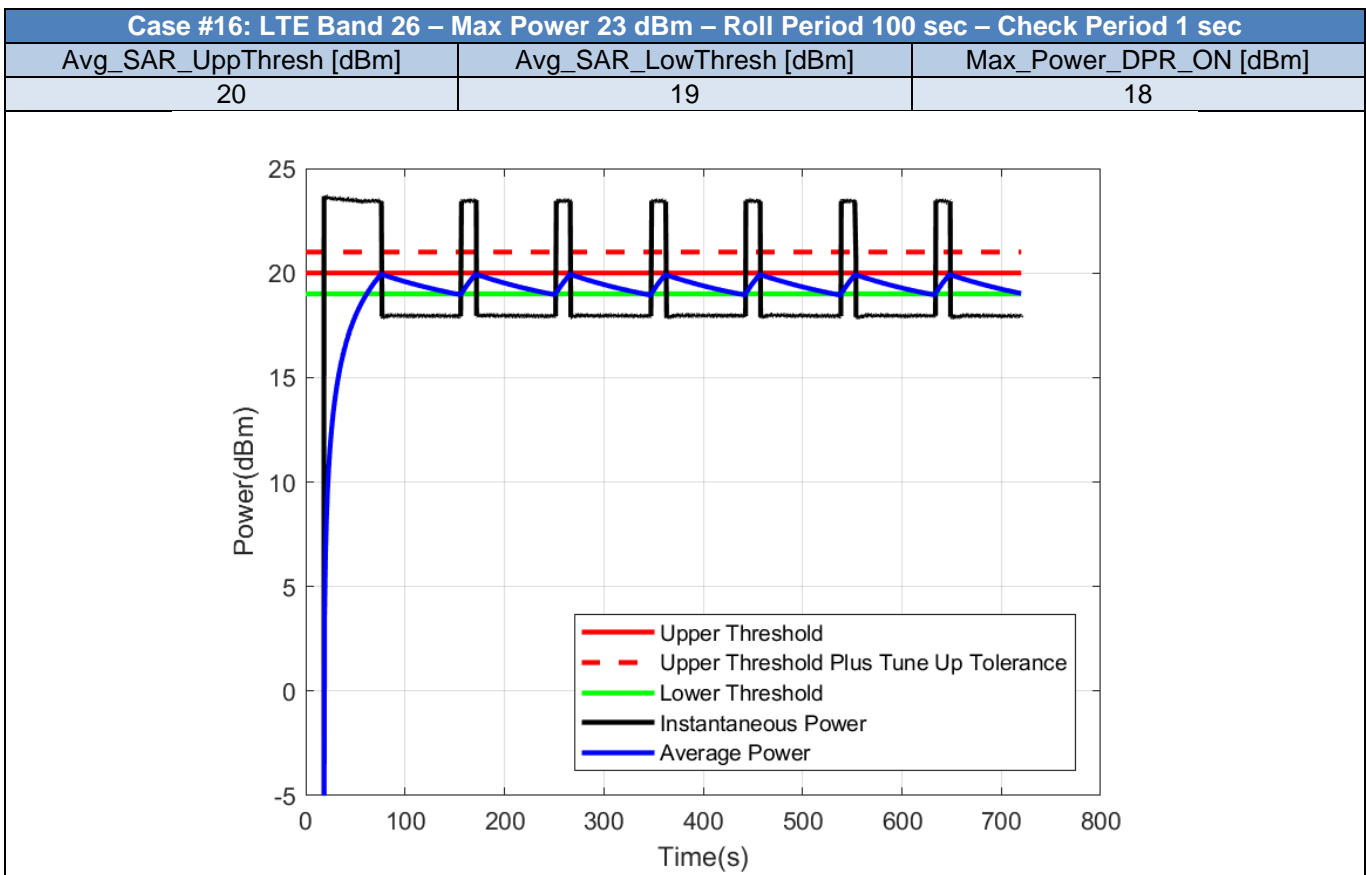
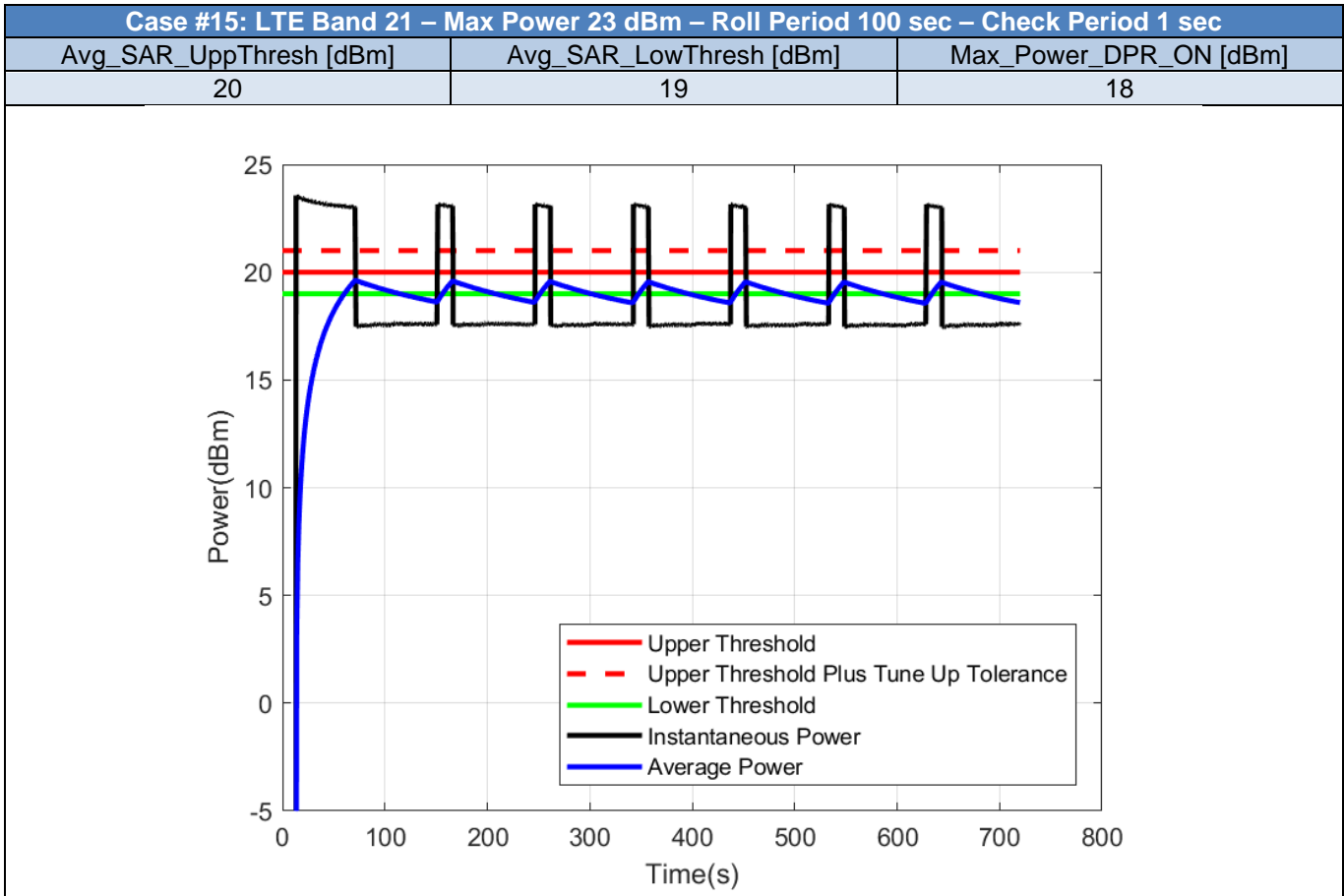

Case #17: LTE Band 28 – Max Power 23 dBm – Roll Period 100 sec – Check Period 1 sec		
Avg_SAR_UppThresh [dBm]	Avg_SAR_LowThresh [dBm]	Max_Power_DPR_ON [dBm]
20	19	18

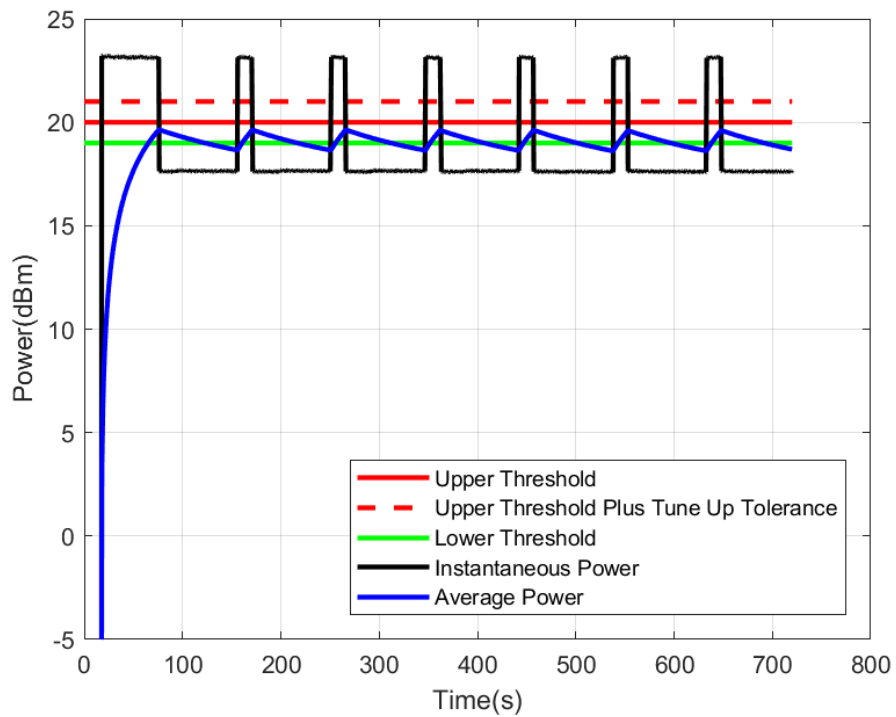

Case #18: LTE Band 30 – Max Power 23 dBm – Roll Period 100 sec – Check Period 1 sec		
Avg_SAR_UppThresh [dBm]	Avg_SAR_LowThresh [dBm]	Max_Power_DPR_ON [dBm]
20	19	18

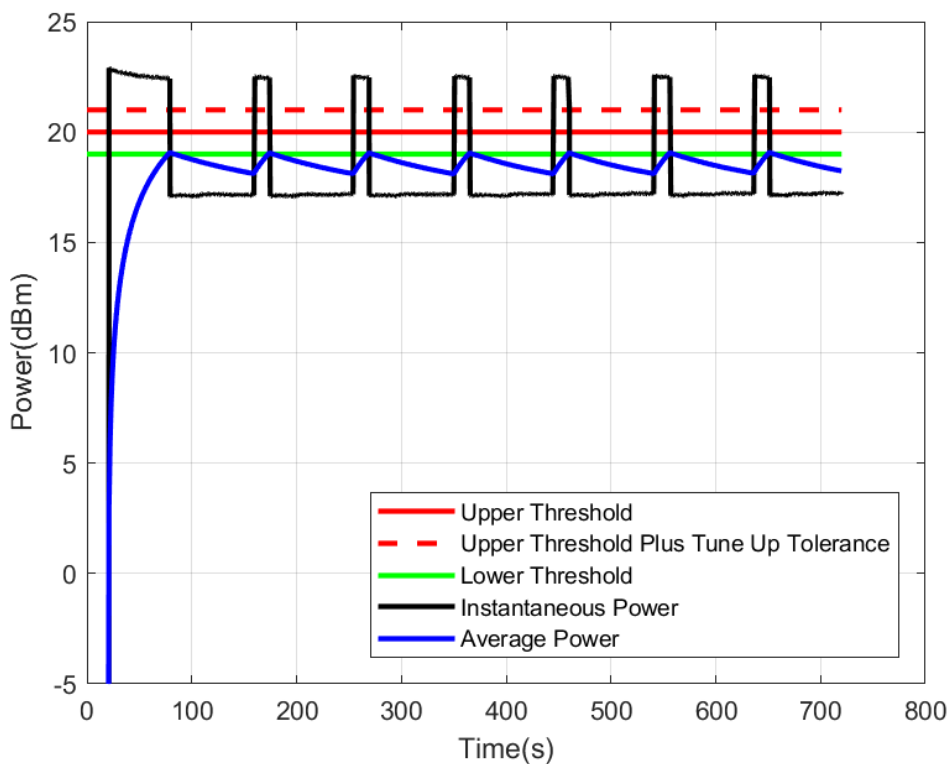

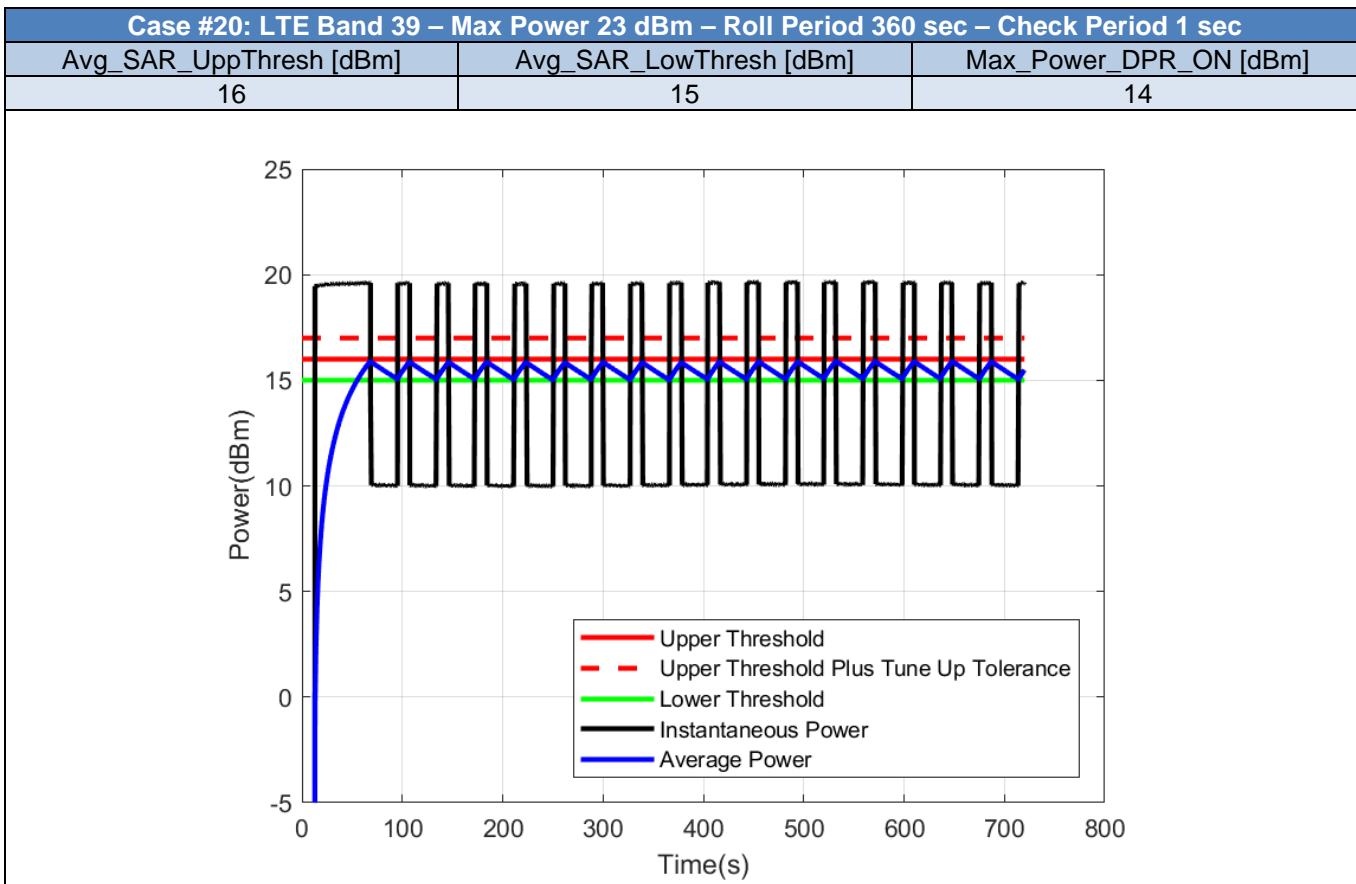
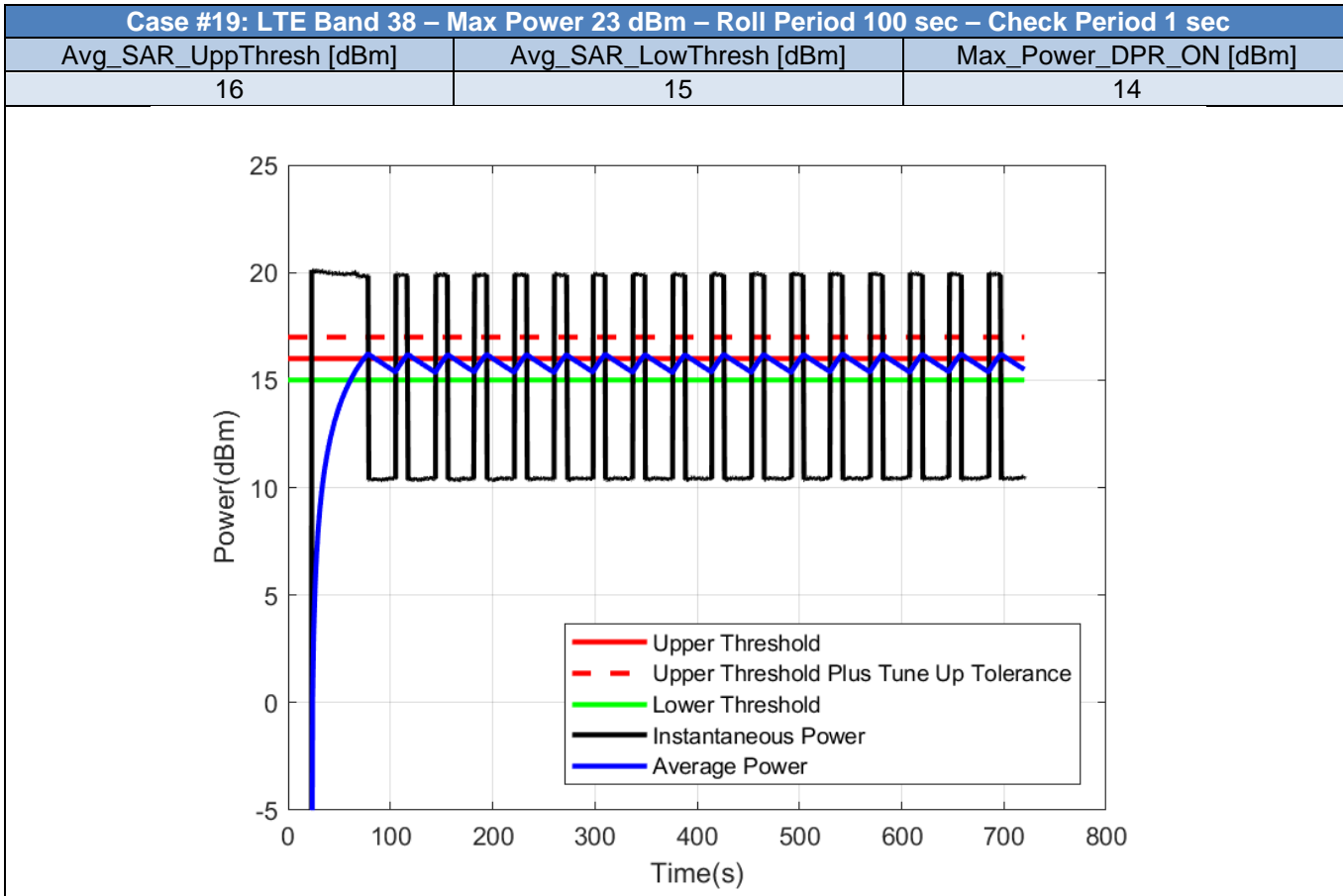

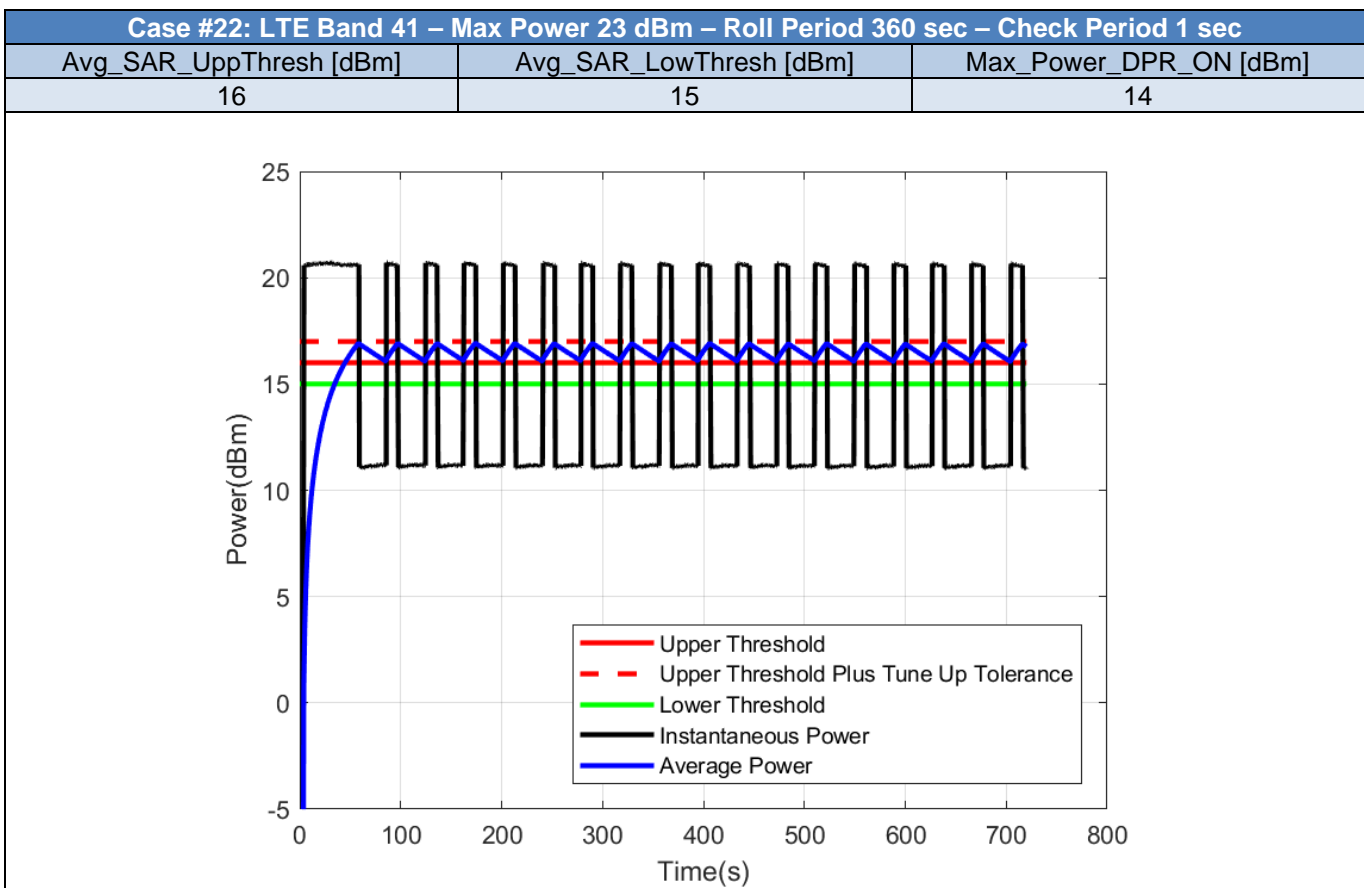
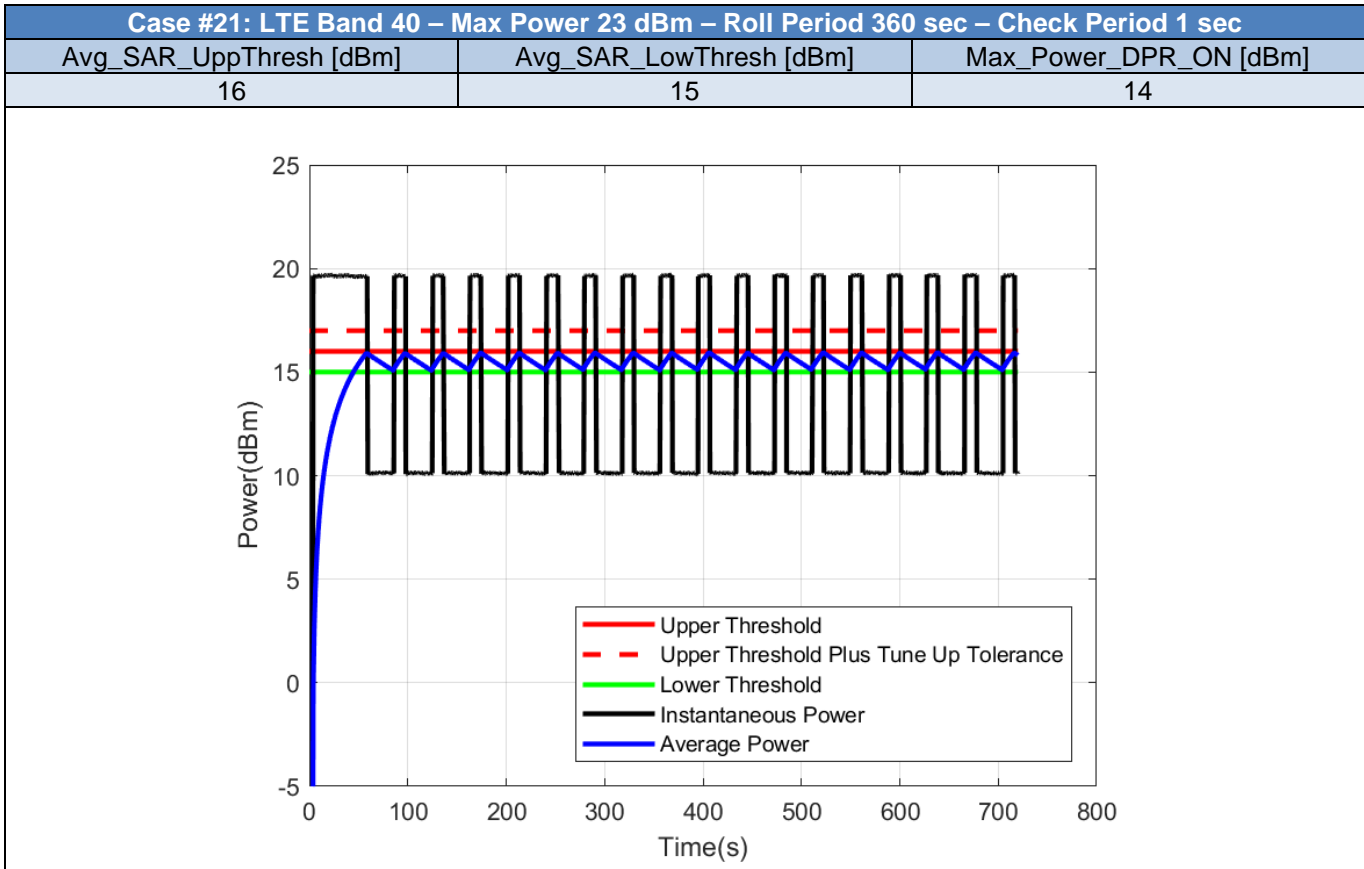

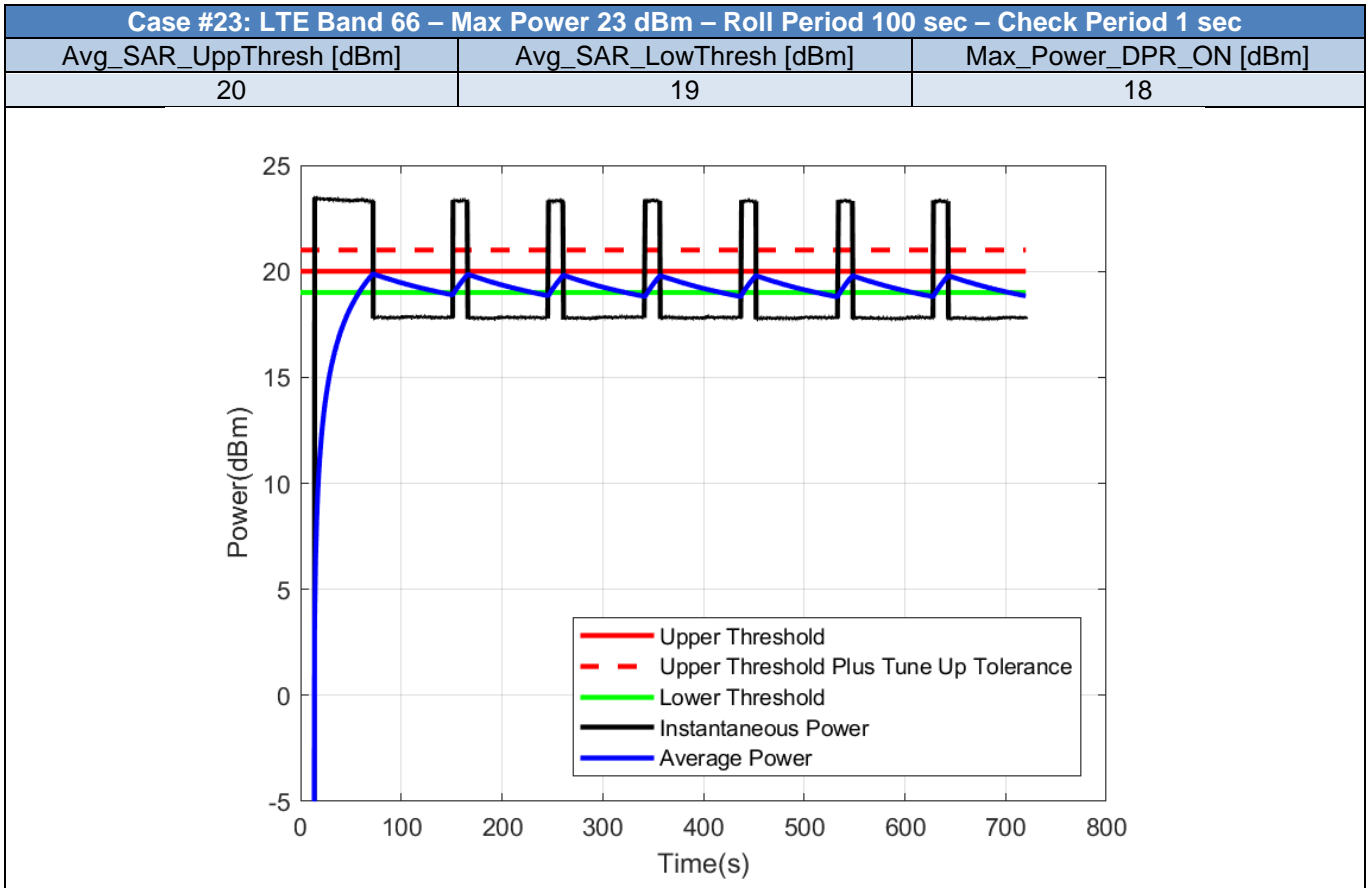

2.5. Bands Validation - WCDMA

Table 4 - Test Cases for Bands Compliance of WCDMA bands

Case	RAT	Band	Max_Power_DPR_OFF_dBm	Roll_Period_s	Check_Period_s	Avg_SAR_Upper_Threshold_dBm	Avg_SAR_Lower_Threshold_dBm	Max_Power_DPR_ON_dBm
24	WCDMA	1	23	100	1	20	19	18
25	WCDMA	2	23	100	1	20	19	18
26	WCDMA	4	23	100	1	20	19	18
27	WCDMA	5	23	100	1	20	19	18
28	WCDMA	8	23	100	1	20	19	18

Note: The Average power is calculated using the measured instantaneous power and compared to the UpperThreshold Plus Tune-Up Tolerance. This is applied for all the test cases in this report.

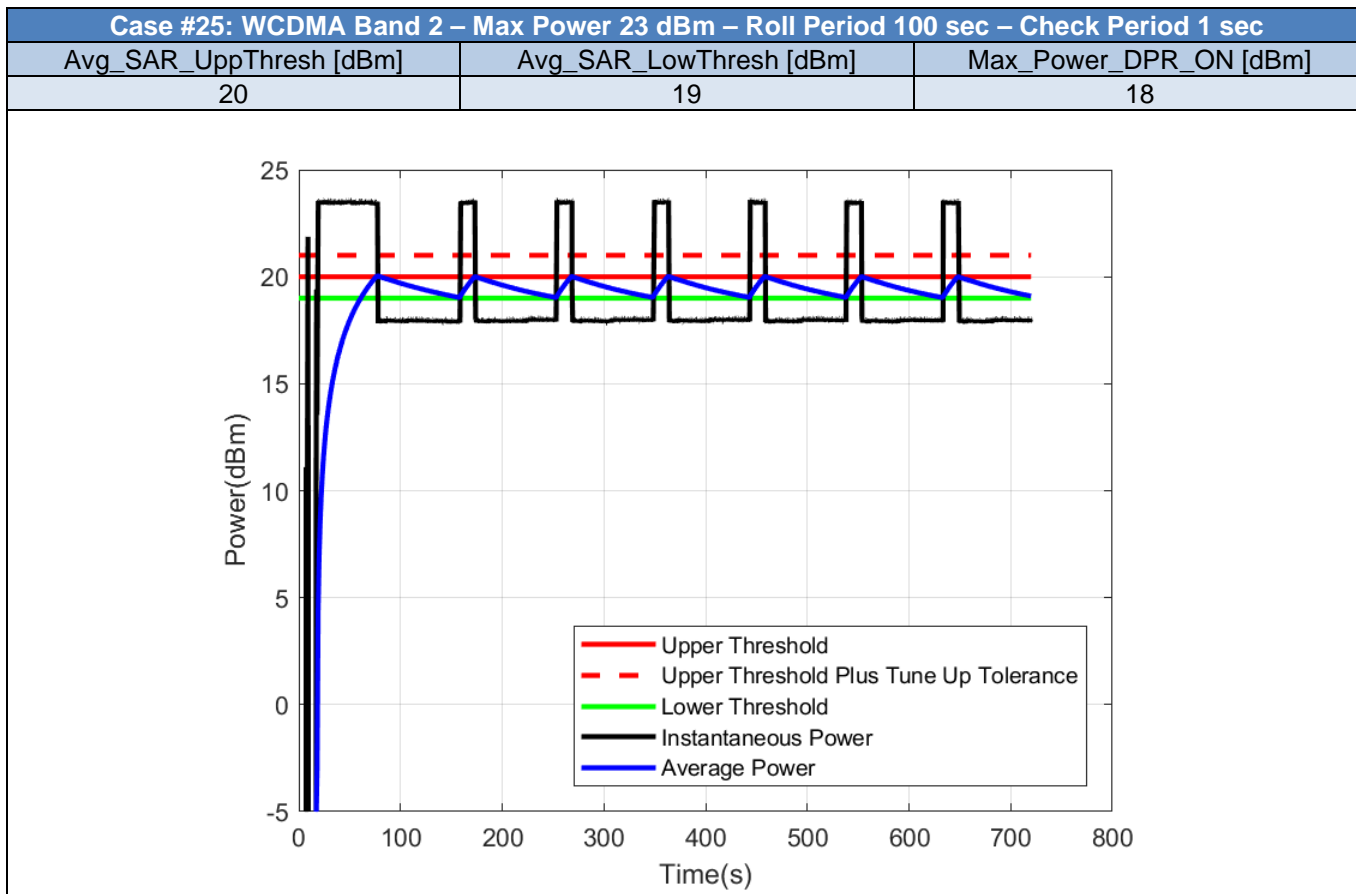
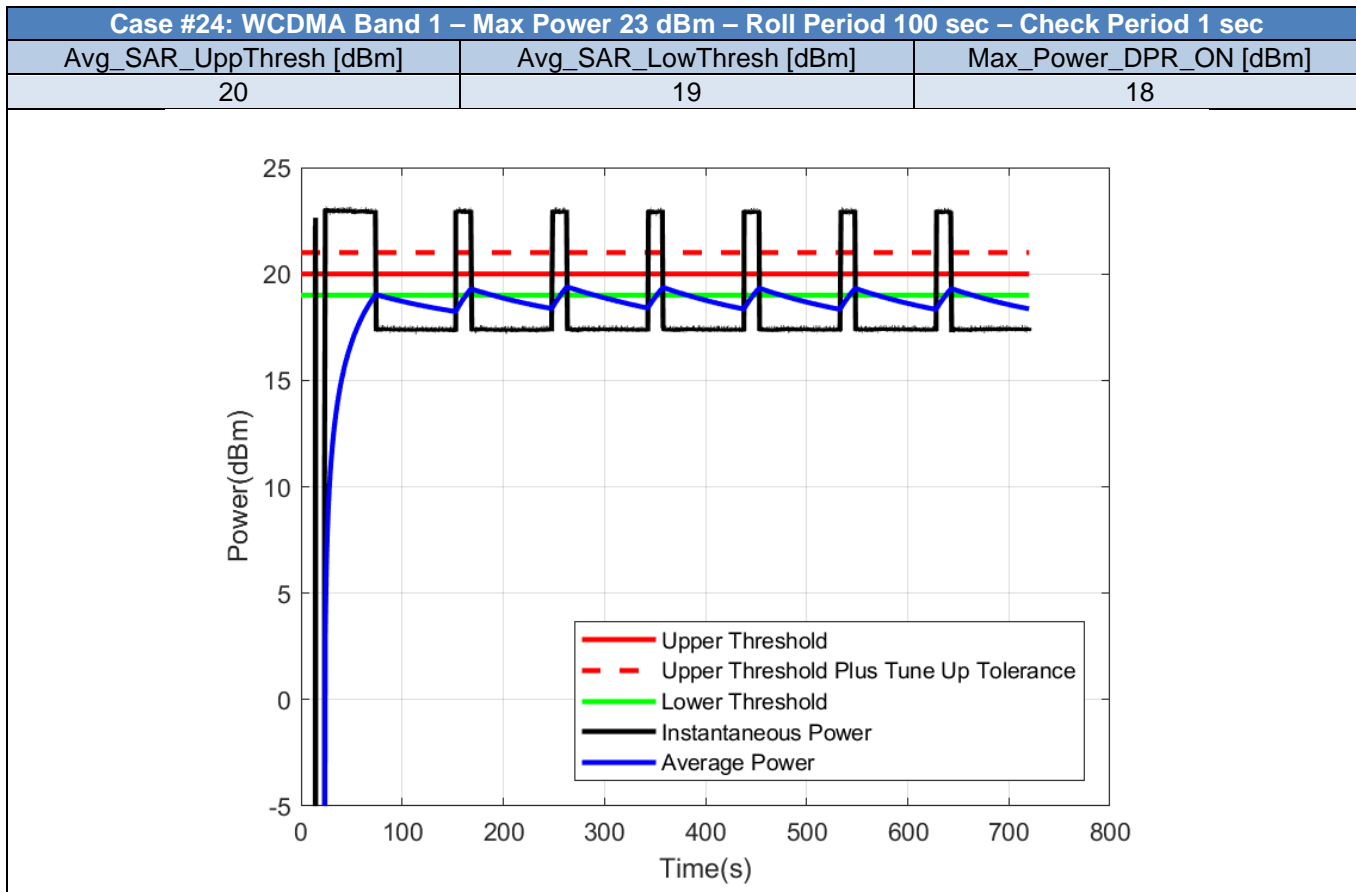

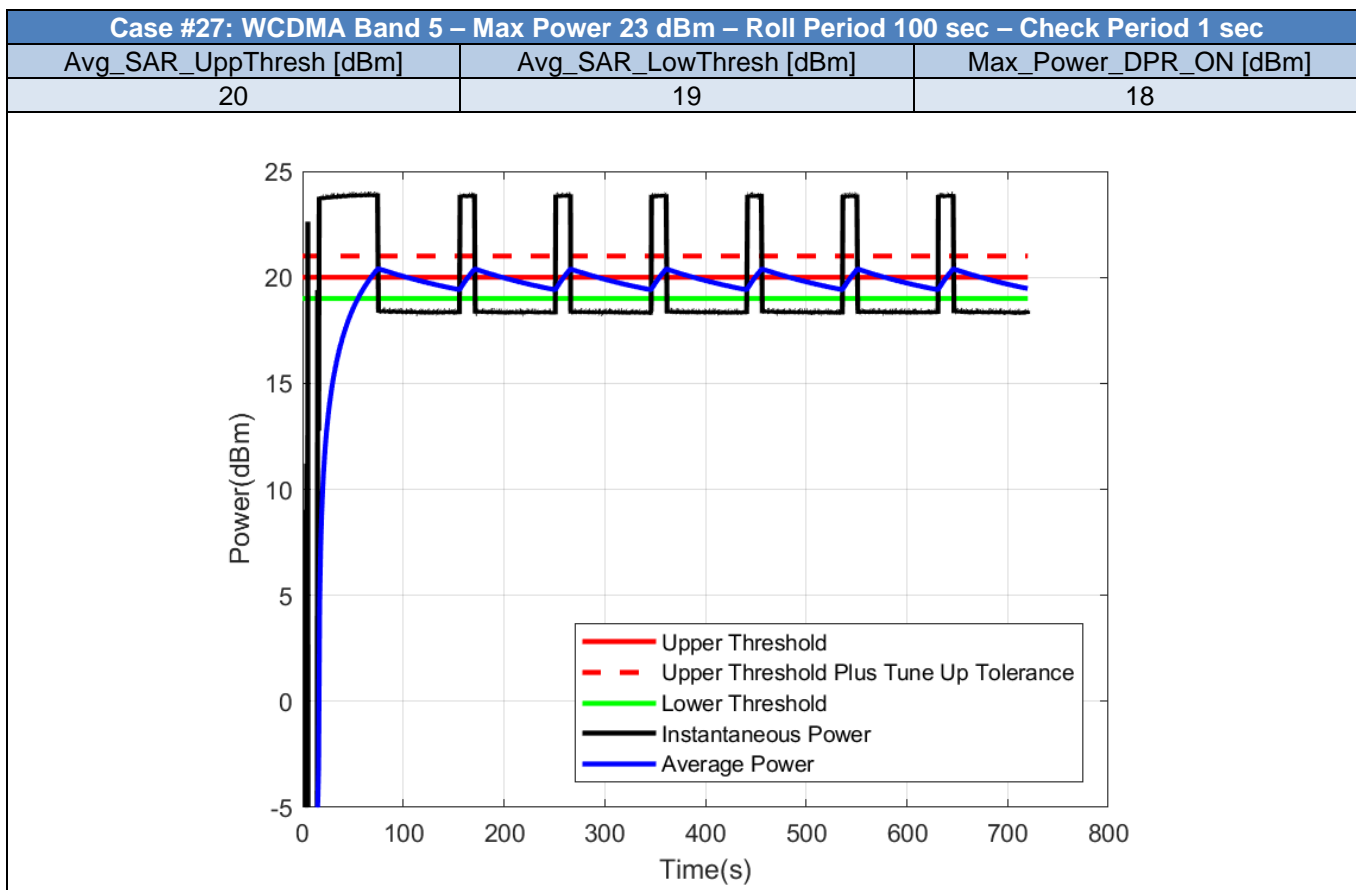
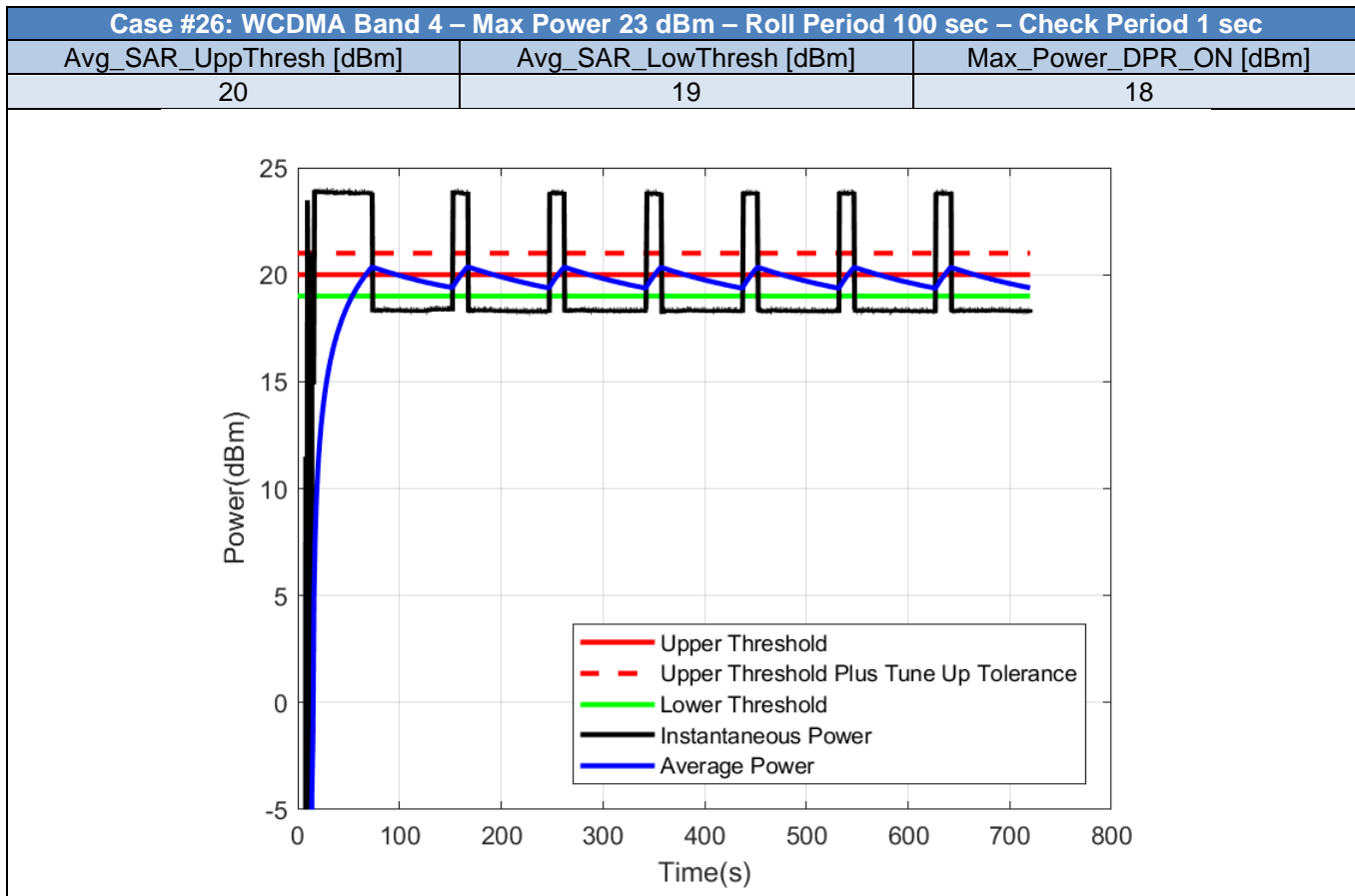

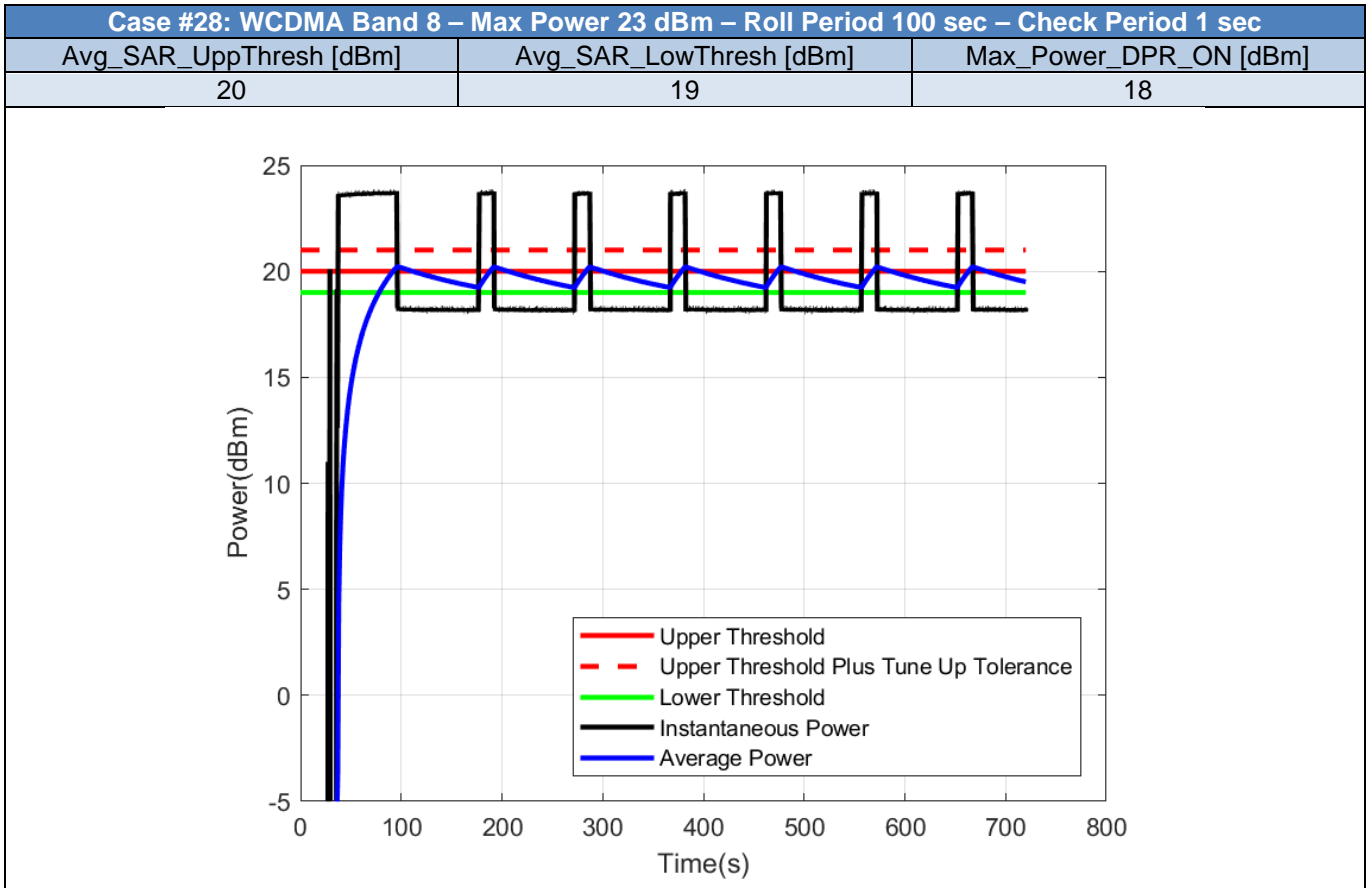

2.6. Time Varying Test Sequence - LTE

Table 5 - Test Cases for Time Varying Test Sequence of LTE bands

Case	RAT	Band	Max_Power_DPR_OFF	Roll_Period	Check_Period	Avg_SAR_UppThresh	Avg_SAR_LowThresh	Max_Power_DPR_ON
1	LTE	2	23	100	1	18	15	14
2	LTE	2	23	100	1	18	15	14

Note: The Average power is calculated using the measured instantaneous power and compared to the UpperThreshold Plus Tune-Up Tolerance. This is applied for all the test cases in this report.

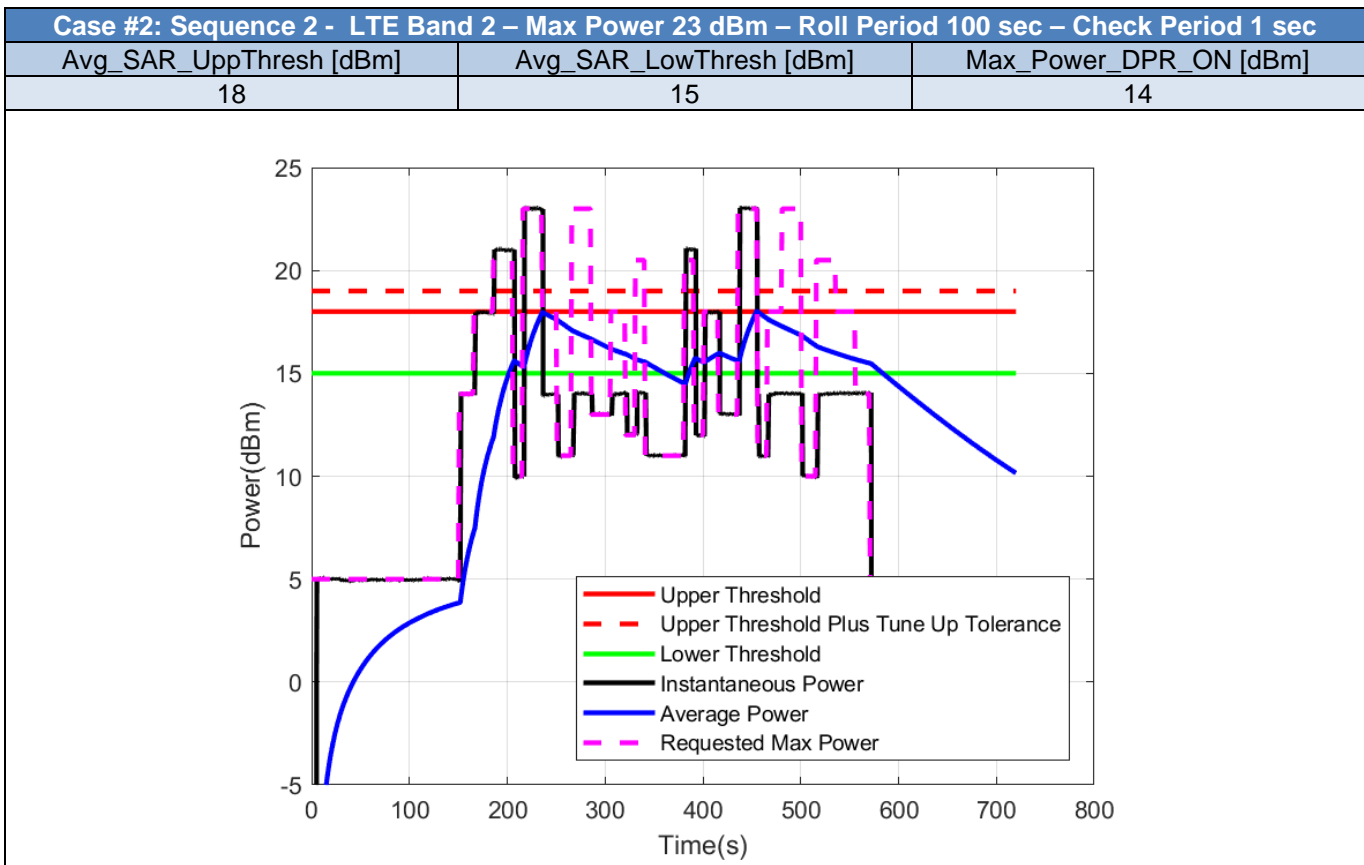
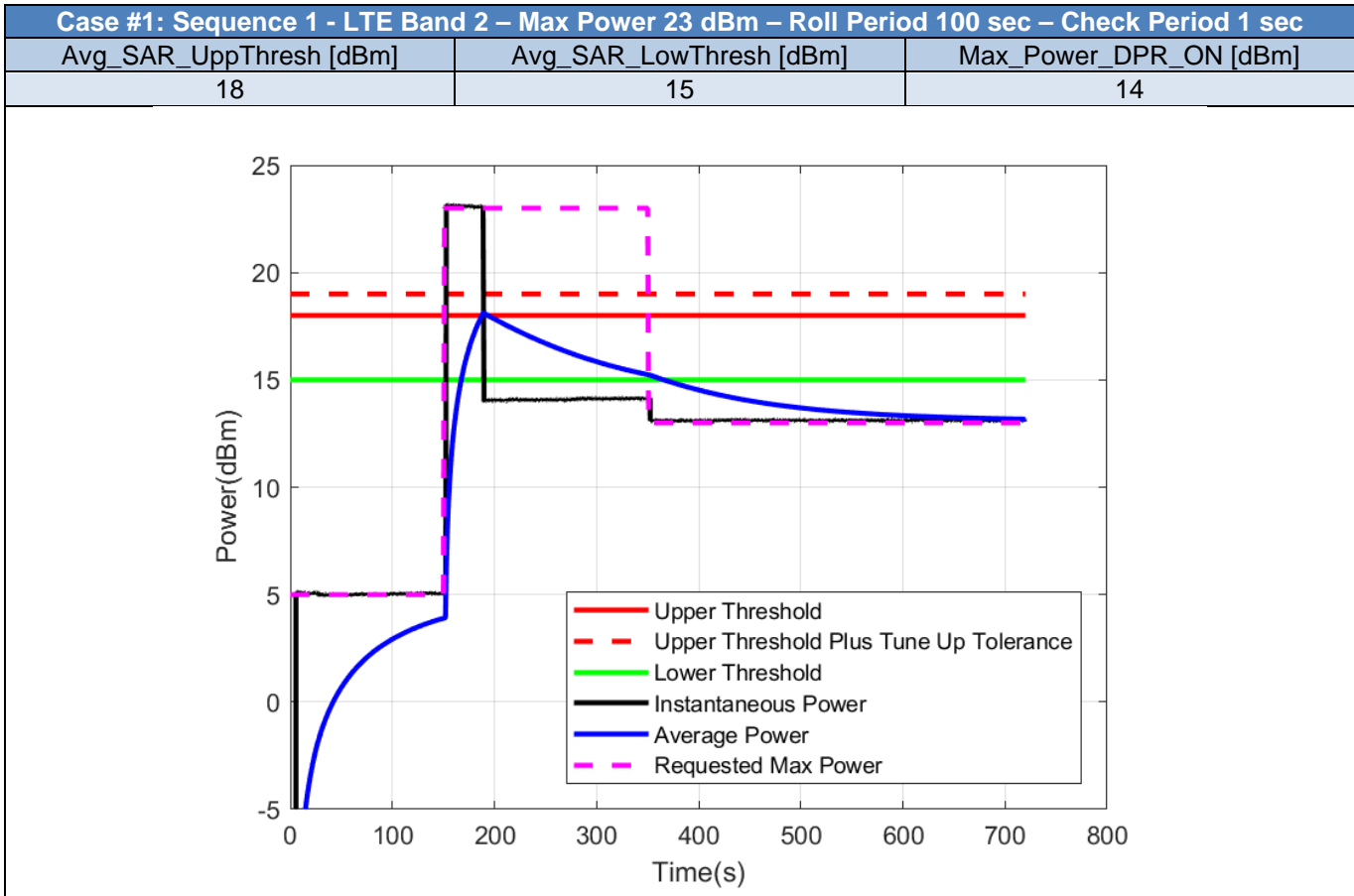

2.7. Time Varying Test Sequence - WCDMA

Table 6 - Test Cases for Time Varying Test Sequence of WCDMA bands

Case	RAT	Band	Max_Power_ DPR_OFF	Roll_Period	Check_Perio d	Avg_SAR_Up pThresh	Avg_SAR_Lo wThresh	Max_Power_ DPR_ON
1	WCDMA	2	23	100	1	18	15	14
2	WCDMA	2	23	100	1	18	15	14

Note: The Average power is calculated using the measured instantaneous power and compared to the UpperThreshold Plus Tune-Up Tolerance. This is applied for all the test cases in this report.

Case #1 : Sequence 1 - WCDMA Band 2 – Max Power 23 dBm – Roll Period 100 sec – Check Period 1 sec

Avg_SAR_UppThresh [dBm]	Avg_SAR_LowThresh [dBm]	Max_Power_DPR_ON [dBm]
18	15	14

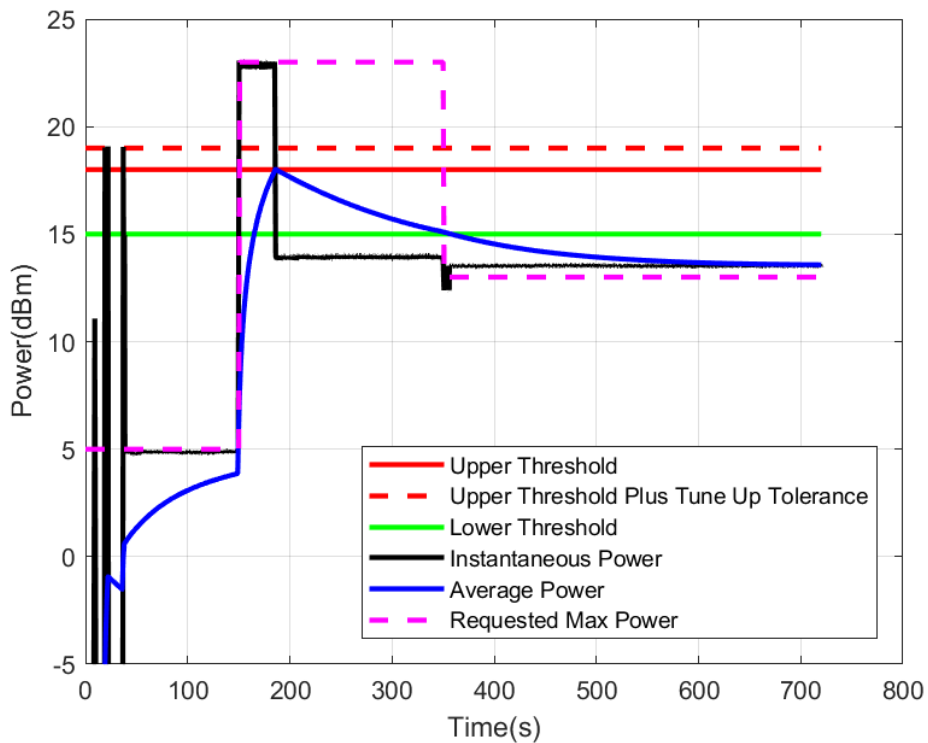

Case #2: Sequence 2 - WCDMA Band 2 – Max Power 23 dBm – Roll Period 100 sec – Check Period 1 sec

Avg_SAR_UppThresh [dBm]	Avg_SAR_LowThresh [dBm]	Max_Power_DPR_ON [dBm]
18	15	14

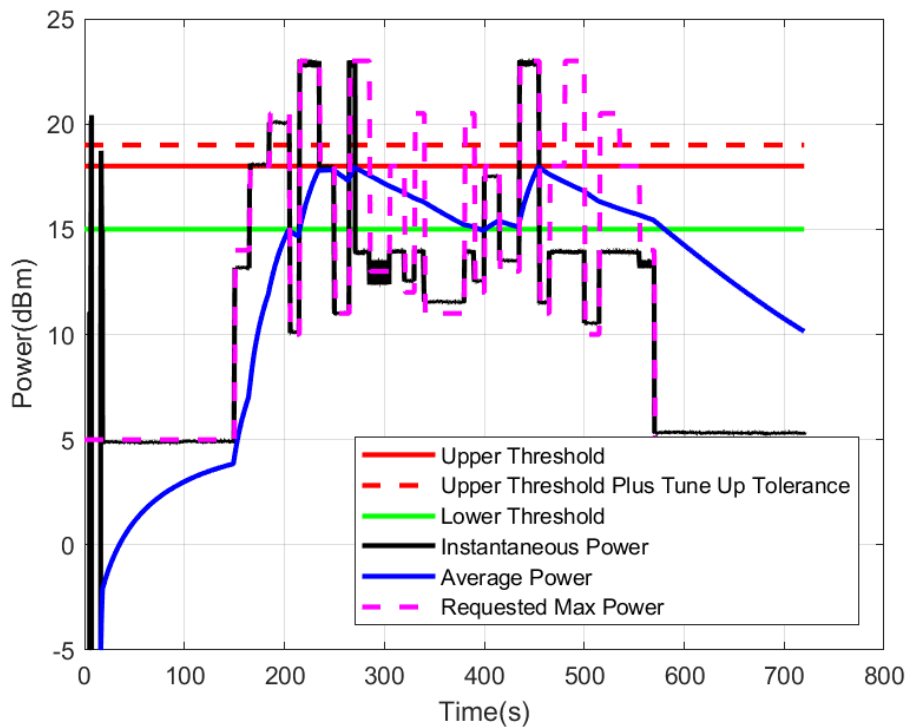

2.8. Handover - LTE-LTE

Table 7 - Test Cases for Handover of LTE-LTE bands

Case	RAT	Band	Max_Power_DPR_OFF_dBm	Roll_Period_s	Check_Period_s	Avg_SAR_UppThresh_dBm	Avg_SAR_LowThresh_dBm	Max_Power_DPR_ON_dBm
1	LTE	2	23	100	1	20	17	16
	LTE	4	23	100	1	20	17	16

Note: The Average power is calculated using the measured instantaneous power and compared to the UpperThreshold Plus Tune-Up Tolerance. This is applied for all the test cases in this report.

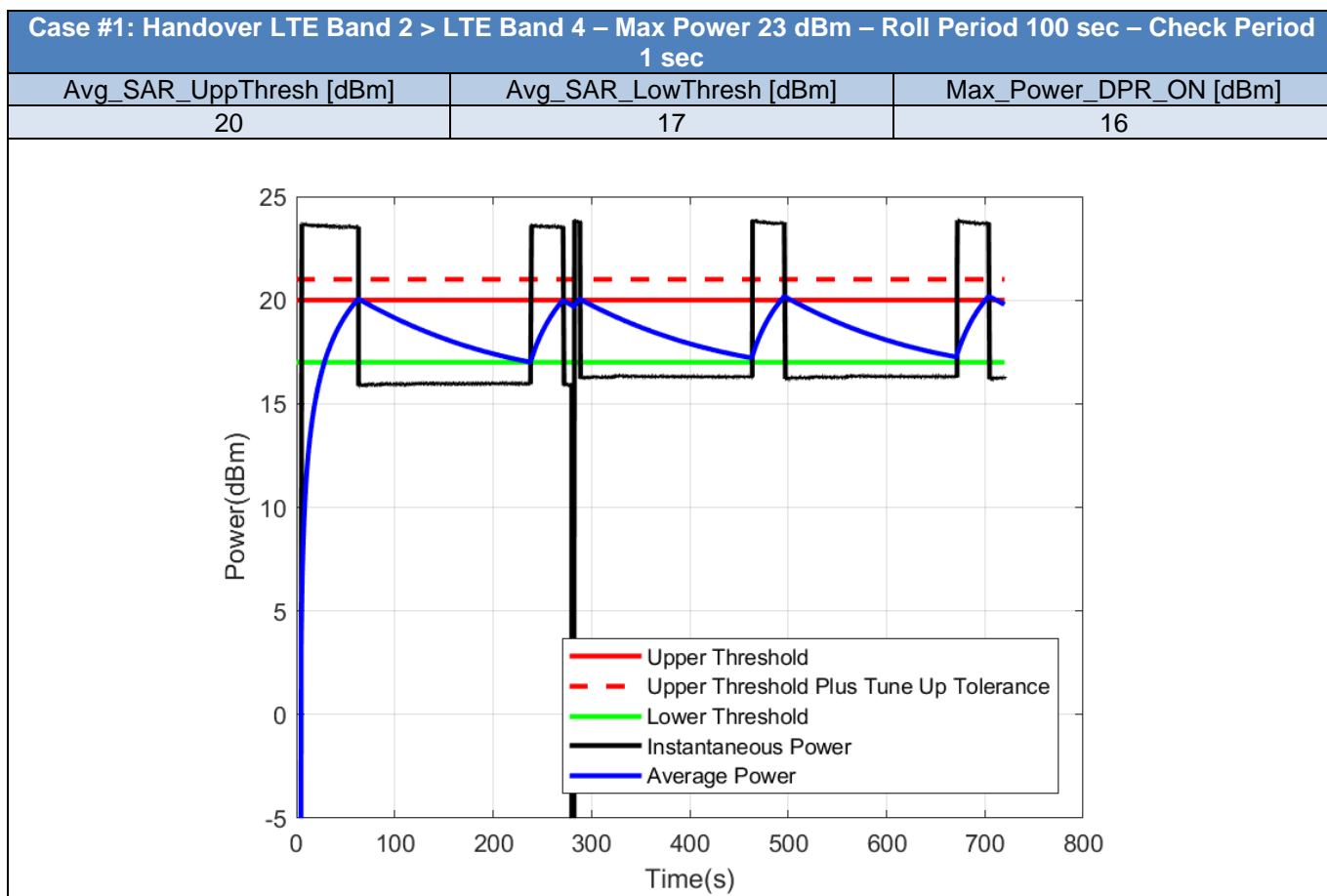

2.9. Handover - LTE-WCDMA

Table 8 - Test Cases for Handover of LTE-WCDMA bands

Case	RAT	Band	Max_Power_DPR_OFF_dBm	Roll_Period_s	Check_Period_s	Avg_SAR_UppThresh_dBm	Avg_SAR_LowThresh_dBm	Max_Power_DPR_ON_dBm
1	LTE	2	23	100	1	20	17	16
	WCDMA	4	23	100	1	18	15	14

Note: The Average power is calculated using the measured instantaneous power and compared to the UpperThreshold Plus Tune-Up Tolerance. This is applied for all the test cases in this report.

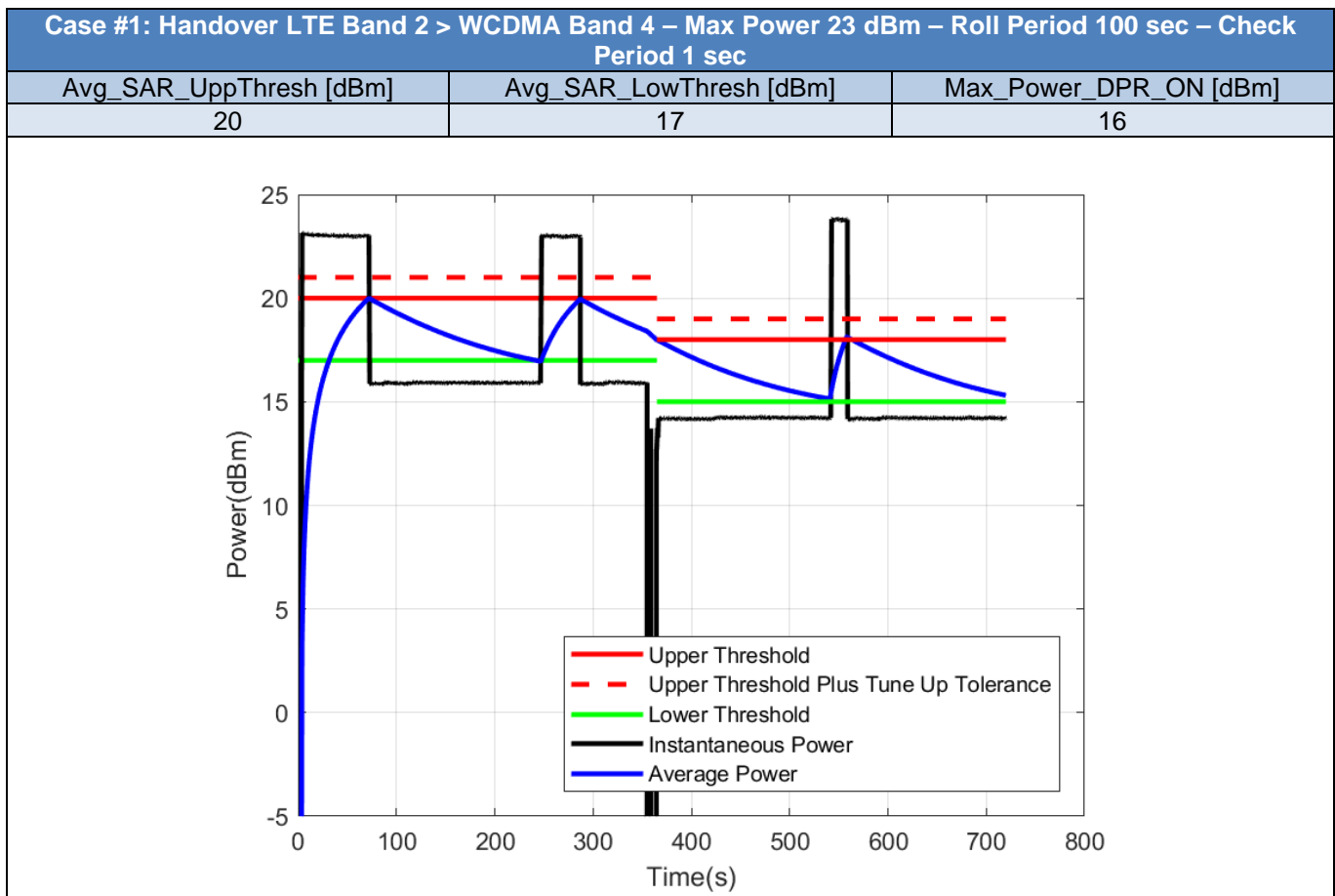

2.10. Call Drop and Reboot - LTE

Table 9 - Test Cases for Call Drop and Reboot of LTE bands

Case	RAT	Band	Max_Power_ DPR_OFF	Roll_Period	Check_Perio d	Avg_SAR_Up pThresh	Avg_SAR_Lo wThresh	Max_Power_ DPR_ON
1	LTE	2	23	100	1	18	15	14
2	LTE	2	23	100	1	18	15	14

Note: The Average power is calculated using the measured instantaneous power and compared to the UpperThreshold Plus Tune-Up Tolerance. This is applied for all the test cases in this report.

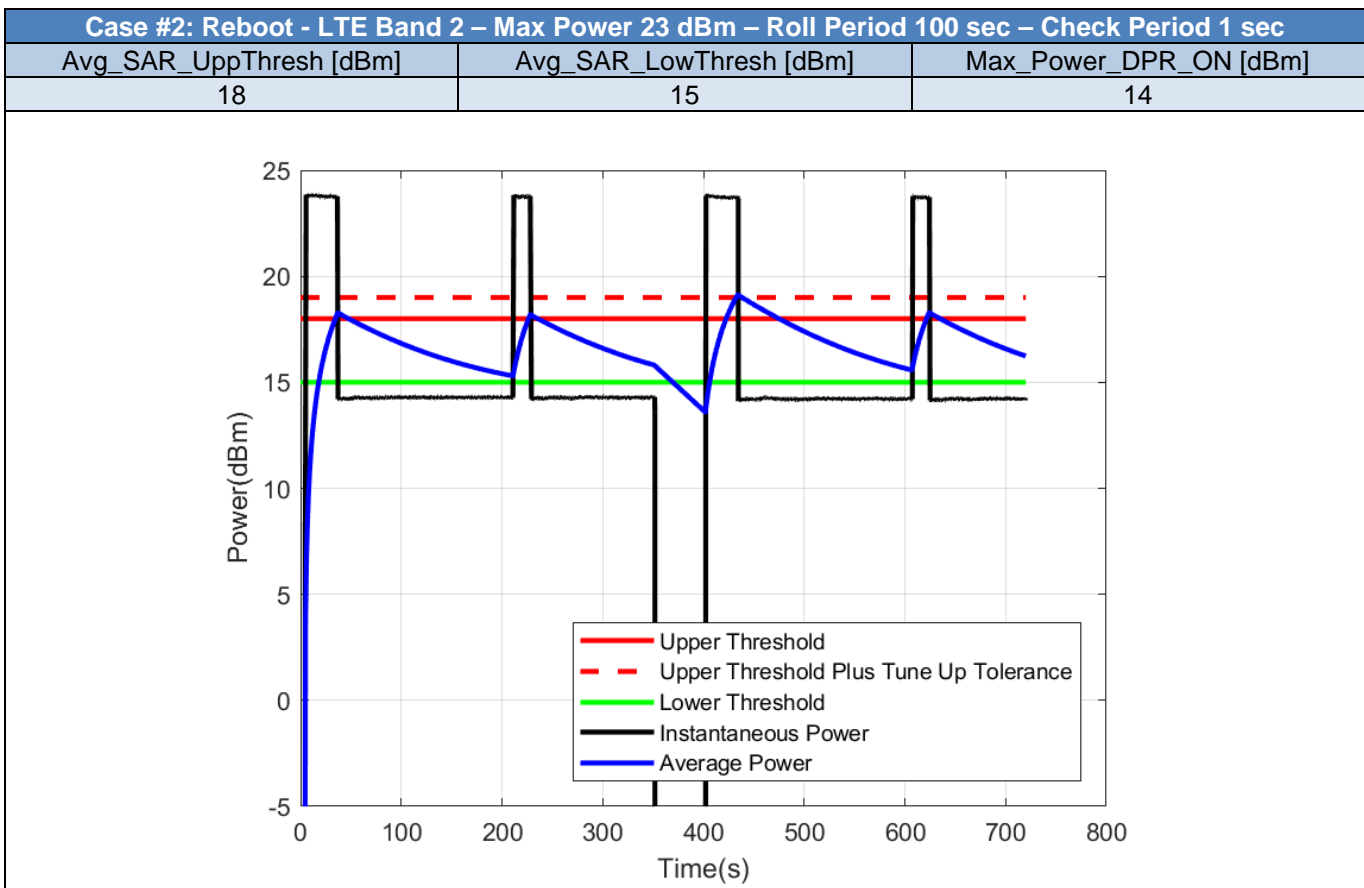
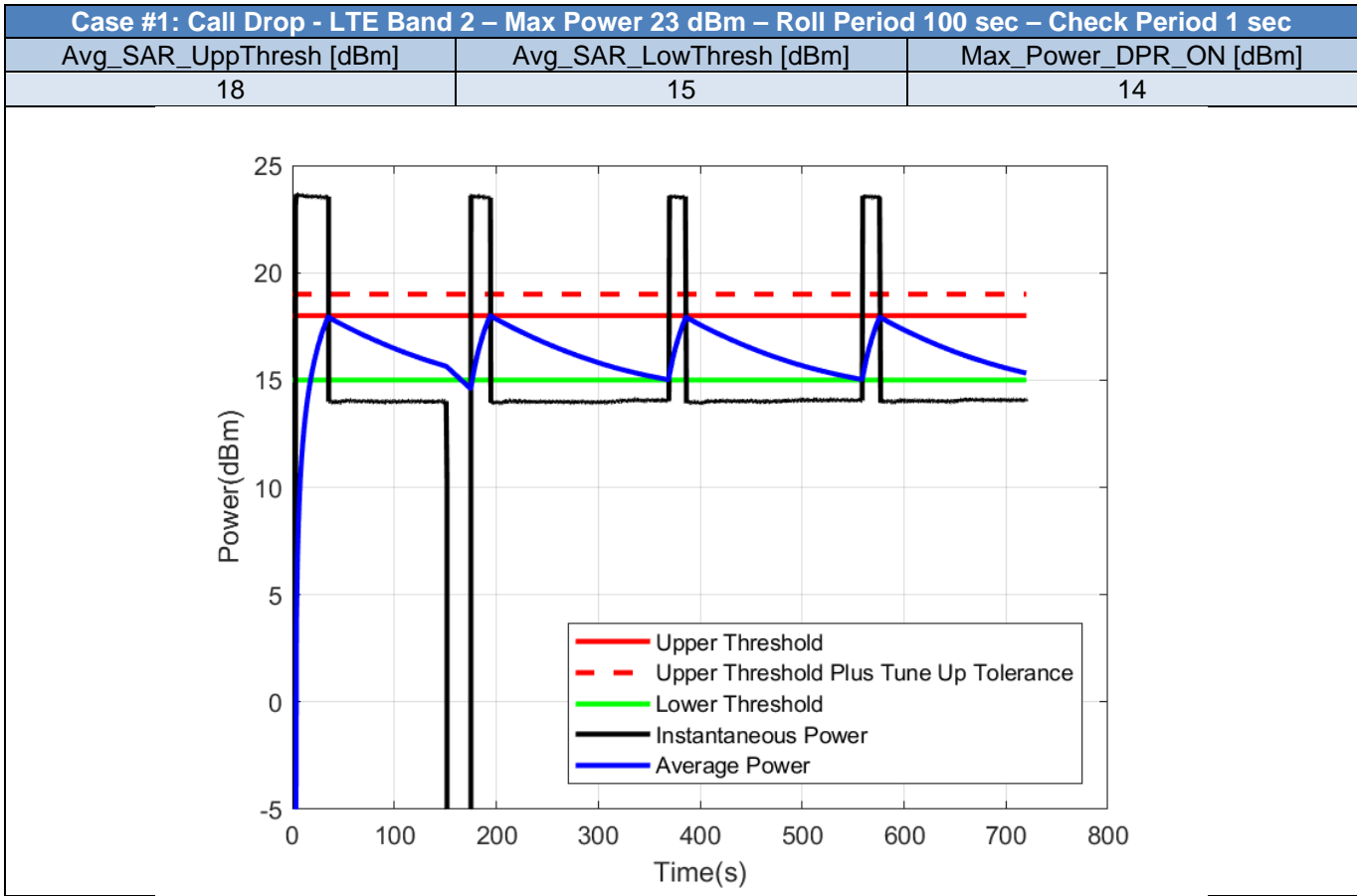

3. Conclusion

The TAS functionality of XMM7360 Module Integrated inside HP Model HSC-I001R convertible notebook is tested. All test cases and corresponding test configurations work properly.