

FCC SDoC REPORT

ICES-003 TEST REPORT

Test Report No. : T210419L03-F
Applicant : INVENTEC CORPORATION
Address : 66 Hou-Kang st., Shih-Lin District, Taipei, Taiwan, R.O.C.
Manufacturer : INVENTEC CORPORATION
Address : 66 Hou-Kang st., Shih-Lin District, Taipei, Taiwan, R.O.C.

Equipment Under Test (EUT) :
Product Name : HP Engage Go 10 Mobile System
Brand Name : HP
Model No. : HSC-I001R
Added Model(s) : N/A
Standards : 47 CFR FCC Part 15 Subpart B (Class B)
ICES-003 Issue 7: October 2020 (Class B)
Date of Sample Receipt : May 14, 2021
Date of Test : May 14 ~ 22, 2021
Date of Issue : Jun. 08, 2021

Test Result :	PASS
----------------------	-------------

In the configuration tested, the EUT complied with the standards specified above.

Remarks :

This report details the results of the testing carried out on one sample, the results contained in this test report do not relate to other samples of the same product. The manufacturer should ensure that all products in series production are in conformity with the product sample detailed in this report.

This report may only be reproduced and distributed in full. If the product in this report is used in any configuration other than that detailed in the report, the manufacturer must ensure the new system complies with all relevant standards. Any mention of Compliance Certification Services Inc. or testing done by Compliance Certification Services Inc. in connection with distribution or use of the product described in this report must be approved by Compliance Certification Services Inc. in writing.

Approved By:



Date:

Jun. 08, 2021



Hex Chiang (Supervisor)

Unless otherwise stated the results shown in this test report refer only to the sample(s) tested and such sample(s) are retained for 90 days only.

除非另有說明，此報告結果僅對測試之樣品負責，同時此樣品僅保留90天。本報告未經本公司書面許可，不可部份複製。

This document is issued by the Company subject to its General Conditions of Service printed overleaf, available on request or accessible at www.sgs.com/terms_and_conditions.htm and for electronic format documents, subject to Terms and Conditions for Electronic Documents at www.sgs.com/terms_e-document.htm. Attention is drawn to the limitation of liability, indemnification and jurisdiction issues defined therein. Any holder of this document is advised that information contained hereon reflects the Company's findings at the time of its intervention only and within the limits of Client's instructions, if any. The Company's sole responsibility is to its Client and this document does not exonerate parties to a transaction from exercising all their rights and obligations under the transaction documents. This document cannot be reproduced except in full, without prior written approval of the Company. Any unauthorized alteration, forgery or falsification of the content or appearance of this document is unlawful and offenders may be prosecuted to the fullest extent of the law.

Revision History

Revision	Report Number	Description	Issue Date
00	T210419L03-F	Original	Jun. 08, 2021

Unless otherwise stated the results shown in this test report refer only to the sample(s) tested and such sample(s) are retained for 90 days only.

除非另有說明，此報告結果僅對測試之樣品負責，同時此樣品僅保留90天。本報告未經本公司書面許可，不可部份複製。

This document is issued by the Company subject to its General Conditions of Service printed overleaf, available on request or accessible at www.sgs.com/terms_and_conditions.htm and for electronic format documents, subject to Terms and Conditions for Electronic Documents at www.sgs.com/terms_e-document.htm. Attention is drawn to the limitation of liability, indemnification and jurisdiction issues defined therein. Any holder of this document is advised that information contained hereon reflects the Company's findings at the time of its intervention only and within the limits of Client's instructions, if any. The Company's sole responsibility is to its Client and this document does not exonerate parties to a transaction from exercising all their rights and obligations under the transaction documents. This document cannot be reproduced except in full, without prior written approval of the Company. Any unauthorized alteration, forgery or falsification of the content or appearance of this document is unlawful and offenders may be prosecuted to the fullest extent of the law.

Contents

1. GENERAL INFORMATION	4
1.1 APPLICANT & MANUFACTURER INFORMATION	4
1.2 GENERAL DESCRIPTION OF EUT	4
1.3 DETAILS OF EUT	5
1.4 THE WORST CASE OF THE EUT	7
1.5 DESCRIPTION OF SUPPORT UNITS	8
1.6 OPERATION PROCEDURE	12
1.7 TEST SET-UP CONFIGURATION	14
1.8 ACCESSORIES CABLE LIST	17
1.9 MEASUREMENT PROCEDURE	18
1.10 STANDARDS APPLICABLE FOR TESTING	18
1.11 DECISION RULES OF RESULTS	19
1.12 SUMMARY OF RESULTS	19
1.13 REPORTING STATEMENTS OF CONFORMITY	19
2. EMISSION	20
2.1 TEST RESULTS	20
2.2 FREQUENCY RANGE	20
2.3 LIMITS OF CONDUCTED AND RADIATED EMISSION	21
2.3.1 LIMITS OF CONDUCTED EMISSION	21
2.3.2 LIMITS OF RADIATED EMISSIONS	22
2.4. TEST OF CONDUCTED EMISSION	24
2.4.1 TEST EQUIPMENTS	24
2.4.2 MEASUREMENT LEVEL CALCULATION	24
2.4.3 MEASUREMENT DATA:	25
2.5 TEST OF RADIATED EMISSION	33
2.5.1 TEST EQUIPMENTS	33
2.5.2 MEASUREMENT LEVEL CALCULATION	34
2.5.3 MEASUREMENT DATA	35
APPENDIX	66
PHOTOGRAPH OF TESTING GENERAL SET-UP	66
PHOTOGRAPHS OF PRODUCT	78

Unless otherwise stated the results shown in this test report refer only to the sample(s) tested and such sample(s) are retained for 90 days only.

除非另有說明，此報告結果僅對測試之樣品負責，同時此樣品僅保留90天。本報告未經本公司書面許可，不可部份複製。

This document is issued by the Company subject to its General Conditions of Service printed overleaf, available on request or accessible at www.sgs.com/terms_and_conditions.htm and for electronic format documents, subject to Terms and Conditions for Electronic Documents at www.sgs.com/terms_e-document.htm. Attention is drawn to the limitation of liability, indemnification and jurisdiction issues defined therein. Any holder of this document is advised that information contained hereon reflects the Company's findings at the time of its intervention only and within the limits of Client's instructions, if any. The Company's sole responsibility is to its Client and this document does not exonerate parties to a transaction from exercising all their rights and obligations under the transaction documents. This document cannot be reproduced except in full, without prior written approval of the Company. Any unauthorized alteration, forgery or falsification of the content or appearance of this document is unlawful and offenders may be prosecuted to the fullest extent of the law.

1. General Information

1.1 Applicant & Manufacturer Information

Applicant : INVENTEC CORPORATION
Address : 66 Hou-Kang st., Shih-Lin District, Taipei, Taiwan, R.O.C.
Manufacturer : INVENTEC CORPORATION
Address : 66 Hou-Kang st., Shih-Lin District, Taipei, Taiwan, R.O.C.

1.2 General Description of EUT

Product Name : HP Engage Go 10 Mobile System
Brand Name : HP
Model No. : HSC-I001R
Added Model(s) : N/A
Variant Description : N/A

Unless otherwise stated the results shown in this test report refer only to the sample(s) tested and such sample(s) are retained for 90 days only.

除非另有說明，此報告結果僅對測試之樣品負責，同時此樣品僅保留90天。本報告未經本公司書面許可，不可部份複製。

This document is issued by the Company subject to its General Conditions of Service printed overleaf, available on request or accessible at www.sgs.com/terms_and_conditions.htm and for electronic format documents, subject to Terms and Conditions for Electronic Documents at www.sgs.com/terms_e-document.htm. Attention is drawn to the limitation of liability, indemnification and jurisdiction issues defined therein. Any holder of this document is advised that information contained hereon reflects the Company's findings at the time of its intervention only and within the limits of Client's instructions, if any. The Company's sole responsibility is to its Client and this document does not exonerate parties to a transaction from exercising all their rights and obligations under the transaction documents. This document cannot be reproduced except in full, without prior written approval of the Company. Any unauthorized alteration, forgery or falsification of the content or appearance of this document is unlawful and offenders may be prosecuted to the fullest extent of the law.

1.3 Details of EUT

EUT Power Rating	AC 100 ~ 240V	
Highest operate description	5.8GHz	
Power Adapter	Chicony (hp)	TPN-CA21
	Delta (hp)	TPN-DA20
	Honor (hp)	TPN-HA01
Adapter Power Rating	For TPN-CA21 ; TPN-DA20 I/P: 100-240Vac, 50-60Hz, 1.7A O/P: 5Vdc, 3A / 9Vdc, 3A / 12Vdc, 5A / 15Vdc, 4.33A / 20Vdc, 3.25A	
	For TPN-HA01 I/P: 100-240Vac, 50/60Hz, 1.6A O/P: 5Vdc, 3A / 9Vdc, 3A / 12Vdc, 5A / 15Vdc, 4.33A / 20Vdc, 3.25A	
AC Power Cord Type	Shielded, 1.8m (Detachable) to Power Adaptor	
DC Power Cable Type (Type C)	Shielded, 1.8m (Non-Detachable) to Power Adapter	
Memory	DDR4 4266MHz (32GB / 64GB)	
Main Board	Inventec	6050A3269201
CPU	Intel	i3-1110G4 1.8GHz i5-1140G7 1.1GHz
10.0" LCD Panel	AUO	G100UAN01.0
	Sharp	LQ100P1JX02
Touch Screen	MUTTO	B132702Q1
	TPK	T08ALO10001HA
SSD	Kingston	OM3PDP3128B-AH (128GB)
		OM3PDP3256B-AH (256GB)
	Samsung	MZ9LQ128HBHQ-000H1 (128GB)
		MZ9LQ256HAJD-000H1 (256GB)
	Western Digital	SDAPTUW-128G-1006 (128GB)
		SDAPTUW-256G-1006 (256GB)
		SDBPTPZ-256G-1006 (256GB)
	Phison	PSEDN128GA17DC0 (128GB)
SSSTC	CL1-3D128-HP (128GB)	

Unless otherwise stated the results shown in this test report refer only to the sample(s) tested and such sample(s) are retained for 90 days only.
除非另有說明，此報告結果僅對測試之樣品負責，同時此樣品僅保留90天。本報告未經本公司書面許可，不可部份複製。

This document is issued by the Company subject to its General Conditions of Service printed overleaf, available on request or accessible at www.sgs.com/terms_and_conditions.htm and for electronic format documents, subject to Terms and Conditions for Electronic Documents at www.sgs.com/terms_e-document.htm. Attention is drawn to the limitation of liability, indemnification and jurisdiction issues defined therein. Any holder of this document is advised that information contained hereon reflects the Company's findings at the time of its intervention only and within the limits of Client's instructions, if any. The Company's sole responsibility is to its Client and this document does not exonerate parties to a transaction from exercising all their rights and obligations under the transaction documents. This document cannot be reproduced except in full, without prior written approval of the Company. Any unauthorized alteration, forgery or falsification of the content or appearance of this document is unlawful and offenders may be prosecuted to the fullest extent of the law.

CCD	Luxvisions	7BA805T2B
		8BF206T2
	TFC	YHCB
		YHCY
Battery Pack	Dynapack(hp)	TPN-DB0H
Wireless LAN+Bluetooth Combo	Intel	AX201D2W
WWAN	Fibocom	L850-GL
NFC Module	WNC	XRAV-1
HP Engage One Pro FPR	HP	HSN-FP02
HP Engage Go 10 Multi-Charger	HP	HSC-I002D
Dock (Optional)	HP	HSN-I001D
Docking Station (Optional)	HP	HSN-IX02
HP ElitePOS Retail Basic I/O Connectivity Base (Optional)	HP	TPC-I026-D
HP ElitePOS Advanced I/O Connectivity Base (Optional)	HP	TPC-I027-D
Hub (Optional)	HP	TPC-I049-D

Unless otherwise stated the results shown in this test report refer only to the sample(s) tested and such sample(s) are retained for 90 days only.

除非另有說明，此報告結果僅對測試之樣品負責，同時此樣品僅保留90天。本報告未經本公司書面許可，不可部份複製。

This document is issued by the Company subject to its General Conditions of Service printed overleaf, available on request or accessible at www.sgs.com/terms_and_conditions.htm and for electronic format documents, subject to Terms and Conditions for Electronic Documents at www.sgs.com/terms_e-document.htm. Attention is drawn to the limitation of liability, indemnification and jurisdiction issues defined therein. Any holder of this document is advised that information contained hereon reflects the Company's findings at the time of its intervention only and within the limits of Client's instructions, if any. The Company's sole responsibility is to its Client and this document does not exonerate parties to a transaction from exercising all their rights and obligations under the transaction documents. This document cannot be reproduced except in full, without prior written approval of the Company. Any unauthorized alteration, forgery or falsification of the content or appearance of this document is unlawful and offenders may be prosecuted to the fullest extent of the law.

Pre-test Mode

Mode	CPU	Memory	LCD Panel	Touch Screen	SSD	CCD	Battery Pack	Wireless LAN+Bluetooth	WWAN	NFC	Main Board	Adapter	HP Engage One Pro FPR	HP ElitePOS Retail Basic I/O Connectivity Base / HP ElitePOS Advanced I/O Connectivity Base / Hub	Dock	Docking Station	HP Engage Go 10 Multi-Charger
1	Intel i3-1110G4 1.8GHz	32GB	AUO G100UAN01.0	MUTTO B132702Q1	Kingston OM3PDP3128B-AH (128GB)	Luxvisions 7BA805T2B	Dynapack(hp) TPN-DB0H	Intel AX201D2W	Fibocom L850-GL	WNC XRAV-1	Inventec 6050A3269201	Chicony (hp) TPN-CAZ1	HP HSN-FP02	N/A	N/A	N/A	N/A
2	Intel i5-1140G7 1.1GHz	64GB	Sharp LQ100P1JX02	TPK T08ALO10001HA	Kingston OM3PDP3256B-AH (256GB)	Luxvisions 8BF206T2	Dynapack(hp) TPN-DB0H	Intel AX201D2W	Fibocom L850-GL	WNC XRAV-1	Inventec 6050A3269201	Delta (hp) TPN-DA20	HP HSN-FP02	N/A	N/A	N/A	N/A
3	Intel i5-1140G7 1.1GHz	64GB	AUO G100UAN01.0	TPK T08ALO10001HA	Samsung MZ9LQ128BHQ-000H1 (128GB)	TFC YHCB	Dynapack(hp) TPN-DB0H	Intel AX201D2W	Fibocom L850-GL	WNC XRAV-1	Inventec 6050A3269201	Honor (hp) TPN-HA01	HP HSN-FP02	N/A	N/A	N/A	N/A
4	Intel i5-1140G7 1.1GHz	64GB	AUO G100UAN01.0	TPK T08ALO10001HA	Samsung MZ9LQ256HAJD-000H1 (256GB)	TFC YHCY	Dynapack(hp) TPN-DB0H	Intel AX201D2W	Fibocom L850-GL	WNC XRAV-1	Inventec 6050A3269201	Delta (hp) TPN-DA20	HP HSN-FP02	N/A	N/A	N/A	N/A
5	Intel i5-1140G7 1.1GHz	64GB	AUO G100UAN01.0	TPK T08ALO10001HA	Western Digital SDAPTUW-128G-1006 (128GB)	Luxvisions 8BF206T2	Dynapack(hp) TPN-DB0H	Intel AX201D2W	Fibocom L850-GL	WNC XRAV-1	Inventec 6050A3269201	Delta (hp) TPN-DA20	HP HSN-FP02	N/A	N/A	N/A	N/A
6	Intel i5-1140G7 1.1GHz	64GB	AUO G100UAN01.0	TPK T08ALO10001HA	Western Digital SDAPTUW-256G-1006 (256GB)	Luxvisions 8BF206T2	Dynapack(hp) TPN-DB0H	Intel AX201D2W	Fibocom L850-GL	WNC XRAV-1	Inventec 6050A3269201	Delta (hp) TPN-DA20	HP HSN-FP02	N/A	N/A	N/A	N/A
7	Intel i5-1140G7 1.1GHz	64GB	AUO G100UAN01.0	TPK T08ALO10001HA	Western Digital SDBPTPZ-256G-1006 (256GB)	Luxvisions 8BF206T2	Dynapack(hp) TPN-DB0H	Intel AX201D2W	Fibocom L850-GL	WNC XRAV-1	Inventec 6050A3269201	Delta (hp) TPN-DA20	HP HSN-FP02	N/A	N/A	N/A	N/A
8	Intel i5-1140G7 1.1GHz	64GB	AUO G100UAN01.0	TPK T08ALO10001HA	Western Digital SDBPTPZ-256G-1006 (256GB)	Luxvisions 8BF206T2	Dynapack(hp) TPN-DB0H	Intel AX201D2W	Fibocom L850-GL	WNC XRAV-1	Inventec 6050A3269201	Delta (hp) TPN-DA20	HP HSN-FP02	N/A	N/A	N/A	N/A
9	Intel i5-1140G7 1.1GHz	64GB	AUO G100UAN01.0	TPK T08ALO10001HA	Phison PSEDN128GA17DC0 (128GB)	Luxvisions 8BF206T2	Dynapack(hp) TPN-DB0H	Intel AX201D2W	Fibocom L850-GL	WNC XRAV-1	Inventec 6050A3269201	Delta (hp) TPN-DA20	HP HSN-FP02	N/A	N/A	N/A	N/A
10	Intel i5-1140G7 1.1GHz	64GB	AUO G100UAN01.0	TPK T08ALO10001HA	SSSTC CL1-3D128-HP (128GB)	Luxvisions 8BF206T2	Dynapack(hp) TPN-DB0H	Intel AX201D2W	Fibocom L850-GL	WNC XRAV-1	Inventec 6050A3269201	Delta (hp) TPN-DA20	HP HSN-FP02	N/A	N/A	N/A	N/A
11	Intel i5-1140G7 1.1GHz	64GB	AUO G100UAN01.0	TPK T08ALO10001HA	Western Digital SDBPTPZ-256G-1006 (256GB)	Luxvisions 8BF206T2	Dynapack(hp) TPN-DB0H	Intel AX201D2W	Fibocom L850-GL	WNC XRAV-1	Inventec 6050A3269201	N/A	HP HSN-FP02	N/A	N/A	N/A	HP HSC-1002D
12	Intel i5-1140G7 1.1GHz	64GB	AUO G100UAN01.0	TPK T08ALO10001HA	Western Digital SDBPTPZ-256G-1006 (256GB)	Luxvisions 8BF206T2	Dynapack(hp) TPN-DB0H	Intel AX201D2W	Fibocom L850-GL	WNC XRAV-1	Inventec 6050A3269201	N/A	HP HSN-FP02	N/A	N/A	N/A	HP HSN-1X02
13	Intel i5-1140G7 1.1GHz	64GB	AUO G100UAN01.0	TPK T08ALO10001HA	Western Digital SDBPTPZ-256G-1006 (256GB)	Luxvisions 8BF206T2	Dynapack(hp) TPN-DB0H	Intel AX201D2W	Fibocom L850-GL	WNC XRAV-1	Inventec 6050A3269201	N/A	HP HSN-FP02	HP TPC-I026-D	HP HSN-1001D	N/A	N/A
14	Intel i5-1140G7 1.1GHz	64GB	AUO G100UAN01.0	TPK T08ALO10001HA	Western Digital SDBPTPZ-256G-1006 (256GB)	Luxvisions 8BF206T2	Dynapack(hp) TPN-DB0H	Intel AX201D2W	Fibocom L850-GL	WNC XRAV-1	Inventec 6050A3269201	N/A	HP HSN-FP02	HP TPC-I027-D	HP HSN-1001D	N/A	N/A
15	Intel i5-1140G7 1.1GHz	64GB	AUO G100UAN01.0	TPK T08ALO10001HA	Western Digital SDBPTPZ-256G-1006 (256GB)	Luxvisions 8BF206T2	Dynapack(hp) TPN-DB0H	Intel AX201D2W	Fibocom L850-GL	WNC XRAV-1	Inventec 6050A3269201	N/A	HP HSN-FP02	HP TPC-I049-D	HP HSN-1001D	N/A	N/A

1.4 The worst case of the EUT

EUT will be carried out in the worst case as followings:

Worst Case	
CE	Mode 8, 12, 13 (1800 x 1200 Resolution)
	Mode 11
Below 1GHz RE	Mode 8, 12, 13 (1800 x 1200 Resolution)
	Mode 11
Above 1GHz RE	Mode 8, 12, 13 (1800 x 1200 Resolution)
	Mode 11

Unless otherwise stated the results shown in this test report refer only to the sample(s) tested and such sample(s) are retained for 90 days only.

除非另有說明，此報告結果僅對測試之樣品負責，同時此樣品僅保留90天。本報告未經本公司書面許可，不可部份複製。

This document is issued by the Company subject to its General Conditions of Service printed overleaf, available on request or accessible at www.sgs.com/terms_and_conditions.htm and for electronic format documents, subject to Terms and Conditions for Electronic Documents at www.sgs.com/terms_e-document.htm. Attention is drawn to the limitation of liability, indemnification and jurisdiction issues defined therein. Any holder of this document is advised that information contained hereon reflects the Company's findings at the time of its intervention only and within the limits of Client's instructions, if any. The Company's sole responsibility is to its Client and this document does not exonerate parties to a transaction from exercising all their rights and obligations under the transaction documents. This document cannot be reproduced except in full, without prior written approval of the Company. Any unauthorized alteration, forgery or falsification of the content or appearance of this document is unlawful and offenders may be prosecuted to the fullest extent of the law.

1.5 Description of Support Units

Mode 8:

PRODUCT	MANUFACTURER	MODEL NO.	SERIAL NO.
LCD Monitor	ASUS	MX27U	N/A
IC Card	N/A	N/A	N/A
Notebook PC (Remote)	HP	Pavilion dv6	CNF9491GLJ
Wireless AP (Remote)	ASUS	RT-AX88U	L41THP000064
Universal Radio Communication (Remote)	R&S	CMW 500	N/A
GPS Simulator (Remote)	IFR	GPS-101	N/A

Mode 11:

PRODUCT	MANUFACTURER	MODEL NO.	SERIAL NO.
IC Card	N/A	N/A	N/A
Notebook PC (Remote)	HP	Pavilion dv6	CNF9491GLJ
Wireless AP (Remote)	ASUS	RT-AX88U	L41THP000064
Universal Radio Communication (Remote)	R&S	CMW 500	N/A
GPS Simulator (Remote)	IFR	GPS-101	N/A

Unless otherwise stated the results shown in this test report refer only to the sample(s) tested and such sample(s) are retained for 90 days only.

除非另有說明，此報告結果僅對測試之樣品負責，同時此樣品僅保留90天。本報告未經本公司書面許可，不可部份複製。

This document is issued by the Company subject to its General Conditions of Service printed overleaf, available on request or accessible at www.sgs.com/terms_and_conditions.htm and for electronic format documents, subject to Terms and Conditions for Electronic Documents at www.sgs.com/terms_e-document.htm. Attention is drawn to the limitation of liability, indemnification and jurisdiction issues defined therein. Any holder of this document is advised that information contained hereon reflects the Company's findings at the time of its intervention only and within the limits of Client's instructions, if any. The Company's sole responsibility is to its Client and this document does not exonerate parties to a transaction from exercising all their rights and obligations under the transaction documents. This document cannot be reproduced except in full, without prior written approval of the Company. Any unauthorized alteration, forgery or falsification of the content or appearance of this document is unlawful and offenders may be prosecuted to the fullest extent of the law.

Mode 12:

PRODUCT	MANUFACTURER	MODEL NO.	SERIAL NO.
LCD Monitor	ASUS	MX27U	N/A
LCD Monitor	ASUS	MX27U	N/A
LCD Monitor	ASUS	MX27U	N/A
Mouse	HP	MOAFUO	PSB1030013577
Keyboard	HP	KB2101U	PUKAA1046004690
Earphone	Lenovo	GS-4021M	57Y4488
IC Card	N/A	N/A	N/A
Type C to USB	HP	N/A	N/A
HDD	WD	My Passport	WXA1AA4DRYDJ
HDD	WD	My Passport	WXB1AA4EEJ9P
HDD	WD	My Passport	WXD1E849K9YF
Notebook PC (Remote)	HP	Pavilion dv6	CNF9491GLJ
Wireless AP (Remote)	ASUS	RT-AX88U	L41THP000064
Universal Radio Communication (Remote)	R&S	CMW 500	N/A
GPS Simulator (Remote)	IFR	GPS-101	N/A

Unless otherwise stated the results shown in this test report refer only to the sample(s) tested and such sample(s) are retained for 90 days only.

除非另有說明，此報告結果僅對測試之樣品負責，同時此樣品僅保留90天。本報告未經本公司書面許可，不可部份複製。

This document is issued by the Company subject to its General Conditions of Service printed overleaf, available on request or accessible at www.sgs.com/terms_and_conditions.htm and for electronic format documents, subject to Terms and Conditions for Electronic Documents at www.sgs.com/terms_e-document.htm. Attention is drawn to the limitation of liability, indemnification and jurisdiction issues defined therein. Any holder of this document is advised that information contained hereon reflects the Company's findings at the time of its intervention only and within the limits of Client's instructions, if any. The Company's sole responsibility is to its Client and this document does not exonerate parties to a transaction from exercising all their rights and obligations under the transaction documents. This document cannot be reproduced except in full, without prior written approval of the Company. Any unauthorized alteration, forgery or falsification of the content or appearance of this document is unlawful and offenders may be prosecuted to the fullest extent of the law.

Mode 13:

PRODUCT	MANUFACTURER	MODEL NO.	SERIAL NO.
LCD Monitor	ASUS	MX27U	N/A
LCD Monitor	ASUS	MX27U	N/A
Mouse	HP	MOAFUO	PSB1030013577
Keyboard	HP	KB2101U	PUKAA1046004690
Earphone	Lenovo	GS-4021M	57Y4488
Modem	ACEEX	DM-1414	405026749
Modem	ACEEX	DM-1414	405026749
Modem	ACEEX	DM-1414	405026749
IC Card	N/A	N/A	N/A
Micro SD 8G	Transcend	N/A	N/A
Type C to USB	HP	N/A	N/A
HDD	WD	My Passport	WXA1AA4DRYDJ
HDD	WD	My Passport	WXB1AA4EEJ9P
HDD	WD	My Passport	WXD1E849K9YF
HDD	WD	My Passport	WX21E54RD766
HDD	WD	My Passport	WX91A744F4NL
Notebook PC (Remote)	HP	Pavilion dv6	CNF9491GLJ
Wireless AP (Remote)	ASUS	RT-AX88U	L41THP000064
Universal Radio Communication (Remote)	R&S	CMW 500	N/A
GPS Simulator (Remote)	IFR	GPS-101	N/A
Standard Duty Cash Drawer	HP	VB400-BL1616	N/A

Unless otherwise stated the results shown in this test report refer only to the sample(s) tested and such sample(s) are retained for 90 days only.

除非另有說明，此報告結果僅對測試之樣品負責，同時此樣品僅保留90天。本報告未經本公司書面許可，不可部份複製。

This document is issued by the Company subject to its General Conditions of Service printed overleaf, available on request or accessible at www.sgs.com/terms_and_conditions.htm and for electronic format documents, subject to Terms and Conditions for Electronic Documents at www.sgs.com/terms_e-document.htm. Attention is drawn to the limitation of liability, indemnification and jurisdiction issues defined therein. Any holder of this document is advised that information contained hereon reflects the Company's findings at the time of its intervention only and within the limits of Client's instructions, if any. The Company's sole responsibility is to its Client and this document does not exonerate parties to a transaction from exercising all their rights and obligations under the transaction documents. This document cannot be reproduced except in full, without prior written approval of the Company. Any unauthorized alteration, forgery or falsification of the content or appearance of this document is unlawful and offenders may be prosecuted to the fullest extent of the law.

Support Equipment Used in Tested Cable

Mode 8:

Cable Type	Core	Length	Shielding/Non-shielding
DC Power Cable (Type C) (1)	N/A	1.8m	Shielding
Type C Cable (2)	N/A	1.8m	Shielding

Mode 11:

Cable Type	Core	Length	Shielding/Non-shielding
LAN Cable (1)	N/A	10.0m	Non-shielding

Mode 12:

Cable Type	Core	Length	Shielding/Non-shielding
Type C Cable (1)	N/A	0.5m	Shielding
Type C Cable (2)	N/A	1.8m	Shielding
HDMI Cable (3)	N/A	1.8m	Shielding
Display Cable (4)*2	N/A	1.8m	Shielding
Type C to USB Cable (5)	N/A	0.1m	Shielding
USB HDD Cable (6)*3	N/A	0.6m	Shielding
Earphone Cable (7)	N/A	1.8m	Non-shielding
USB Keyboard Cable (8)	N/A	1.8m	Shielding
USB Mouse Cable (9)	N/A	1.8m	Shielding
LAN Cable (10)	N/A	10.0m	Non-shielding

Mode 13:

Cable Type	Core	Length	Shielding/Non-shielding
Type C Cable (1)*2	N/A	1.8m	Shielding
RJ11 Cable (2)	N/A	1.0m	Non-shielding
Earphone Cable (3)	N/A	1.8m	Non-shielding
Type C to USB Cable (4)	N/A	0.1m	Shielding
USB HDD Cable (5)*5	N/A	0.6m	Shielding
RS232 Cable (6)*3	N/A	1.8m	Shielding
USB Keyboard Cable (7)	N/A	1.8m	Shielding
USB Mouse Cable (8)	N/A	1.8m	Shielding
LAN Cable (9)	N/A	10.0m	Non-shielding

Unless otherwise stated the results shown in this test report refer only to the sample(s) tested and such sample(s) are retained for 90 days only.

除非另有說明，此報告結果僅對測試之樣品負責，同時此樣品僅保留90天。本報告未經本公司書面許可，不可部份複製。

This document is issued by the Company subject to its General Conditions of Service printed overleaf, available on request or accessible at www.sgs.com/terms_and_conditions.htm and for electronic format documents, subject to Terms and Conditions for Electronic Documents at www.sgs.com/terms_e-document.htm. Attention is drawn to the limitation of liability, indemnification and jurisdiction issues defined therein. Any holder of this document is advised that information contained hereon reflects the Company's findings at the time of its intervention only and within the limits of Client's instructions, if any. The Company's sole responsibility is to its Client and this document does not exonerate parties to a transaction from exercising all their rights and obligations under the transaction documents. This document cannot be reproduced except in full, without prior written approval of the Company. Any unauthorized alteration, forgery or falsification of the content or appearance of this document is unlawful and offenders may be prosecuted to the fullest extent of the law.

1.6 Operation Procedure

Mode 8:

1. Turn on the power of all equipment.
2. The EUT execute the "WINEMC Test" test software to send "H" Pattern to display on the screen.
3. The EUT communicates with Notebook PC by Bluetooth radio.
4. The EUT communicates with Wireless AP by WIFI radio.
5. Executed AMCAP2 software to turn-on the Camera.
6. The EUT will receive GPS, LTE signal sources and continue to operate.
7. The EUT will receive the NFC RF signal source.
8. Setup the condition for test mode and begin the test.

Mode 11:

1. Turn on the power of all equipment.
2. The EUT communicates with Notebook PC by Bluetooth radio.
3. The EUT communicates with Wireless AP by WIFI radio.
4. Executed AMCAP2 software to turn-on the Camera.
5. The EUT will receive GPS, LTE signal sources and continue to operate.
6. The EUT will receive the NFC RF signal source.
7. ISN test, using TFGEN 1.0.exe program will push traffic to 10%, 250ms for testing.
8. Setup the condition for test mode and begin the test.

Mode 12:

1. Turn on the power of all equipment.
2. The EUT will reads/writes disk through "WINEMC Test" test software.
3. The EUT execute the "WINEMC Test" test software to send "H" Pattern to display on the screen.
4. The EUT communicates with Notebook PC by Bluetooth radio.
5. The EUT communicates with Wireless AP by WIFI radio.
6. Executed AMCAP2 software to turn-on the Camera.
7. The EUT will receive GPS, LTE signal sources and continue to operate.
8. The EUT will receive the NFC RF signal source.
9. ISN test, using TFGEN 1.0.exe program will push traffic to 10%, 250ms for testing.
10. Setup the condition for test mode and begin the test.

Unless otherwise stated the results shown in this test report refer only to the sample(s) tested and such sample(s) are retained for 90 days only.

除非另有說明，此報告結果僅對測試之樣品負責，同時此樣品僅保留90天。本報告未經本公司書面許可，不可部份複製。

This document is issued by the Company subject to its General Conditions of Service printed overleaf, available on request or accessible at www.sgs.com/terms_and_conditions.htm and for electronic format documents, subject to Terms and Conditions for Electronic Documents at www.sgs.com/terms_e-document.htm. Attention is drawn to the limitation of liability, indemnification and jurisdiction issues defined therein. Any holder of this document is advised that information contained hereon reflects the Company's findings at the time of its intervention only and within the limits of Client's instructions, if any. The Company's sole responsibility is to its Client and this document does not exonerate parties to a transaction from exercising all their rights and obligations under the transaction documents. This document cannot be reproduced except in full, without prior written approval of the Company. Any unauthorized alteration, forgery or falsification of the content or appearance of this document is unlawful and offenders may be prosecuted to the fullest extent of the law.

Mode 13:

1. Turn on the power of all equipment.
2. The EUT will reads/writes disk through "WINEMC Test" test software.
3. The EUT execute the "WINEMC Test" test software to send "H" Pattern to display on the screen.
4. The EUT communicates with Notebook PC by Bluetooth radio.
5. The EUT communicates with Wireless AP by WIFI radio.
6. Executed AMCAP2 software to turn-on the Camera.
7. The EUT will receive GPS, LTE signal sources and continue to operate.
8. The EUT will receive the NFC RF signal source.
9. ISN test, using TFGEN 1.0.exe program will push traffic to 10%, 250ms for testing.
10. Setup the condition for test mode and begin the test.

Unless otherwise stated the results shown in this test report refer only to the sample(s) tested and such sample(s) are retained for 90 days only.

除非另有說明，此報告結果僅對測試之樣品負責，同時此樣品僅保留90天。本報告未經本公司書面許可，不可部份複製。

This document is issued by the Company subject to its General Conditions of Service printed overleaf, available on request or accessible at www.sgs.com/terms_and_conditions.htm and for electronic format documents, subject to Terms and Conditions for Electronic Documents at www.sgs.com/terms_e-document.htm. Attention is drawn to the limitation of liability, indemnification and jurisdiction issues defined therein. Any holder of this document is advised that information contained hereon reflects the Company's findings at the time of its intervention only and within the limits of Client's instructions, if any. The Company's sole responsibility is to its Client and this document does not exonerate parties to a transaction from exercising all their rights and obligations under the transaction documents. This document cannot be reproduced except in full, without prior written approval of the Company. Any unauthorized alteration, forgery or falsification of the content or appearance of this document is unlawful and offenders may be prosecuted to the fullest extent of the law.

1.7 Test Set-Up Configuration

Mode 8:

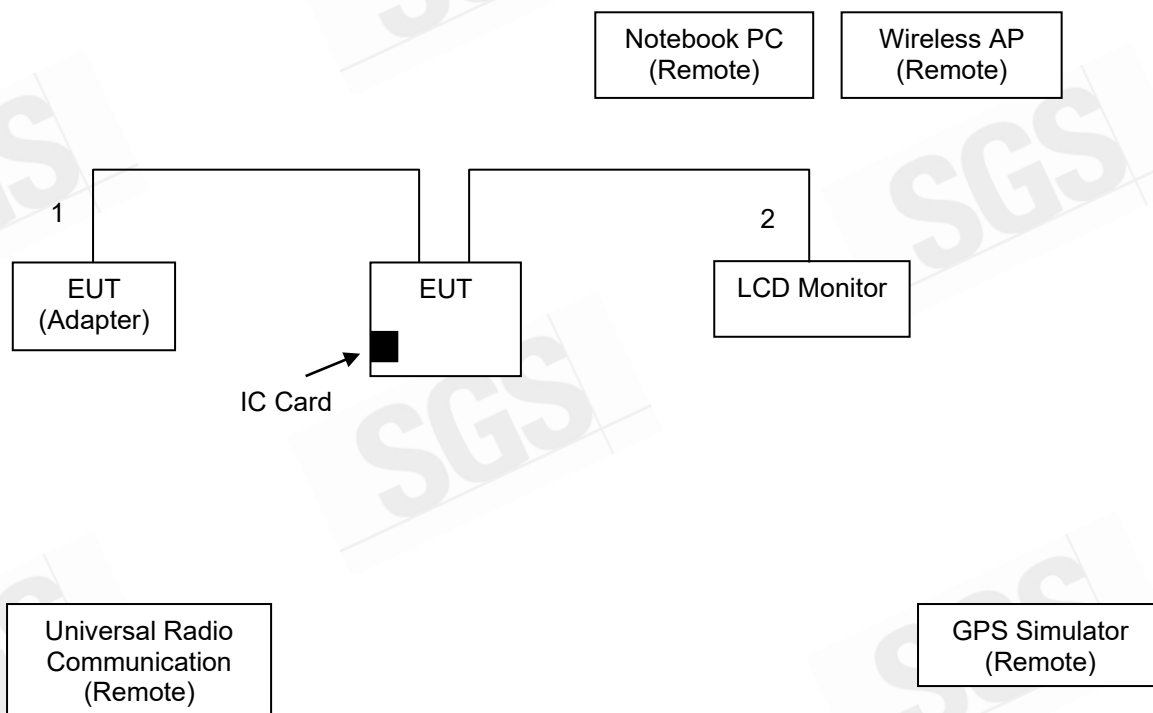

Unless otherwise stated the results shown in this test report refer only to the sample(s) tested and such sample(s) are retained for 90 days only.

除非另有說明，此報告結果僅對測試之樣品負責，同時此樣品僅保留90天。本報告未經本公司書面許可，不可部份複製。

This document is issued by the Company subject to its General Conditions of Service printed overleaf, available on request or accessible at www.sgs.com/terms_and_conditions.htm and for electronic format documents, subject to Terms and Conditions for Electronic Documents at www.sgs.com/terms_e-document.htm. Attention is drawn to the limitation of liability, indemnification and jurisdiction issues defined therein. Any holder of this document is advised that information contained hereon reflects the Company's findings at the time of its intervention only and within the limits of Client's instructions, if any. The Company's sole responsibility is to its Client and this document does not exonerate parties to a transaction from exercising all their rights and obligations under the transaction documents. This document cannot be reproduced except in full, without prior written approval of the Company. Any unauthorized alteration, forgery or falsification of the content or appearance of this document is unlawful and offenders may be prosecuted to the fullest extent of the law.

Mode 11:

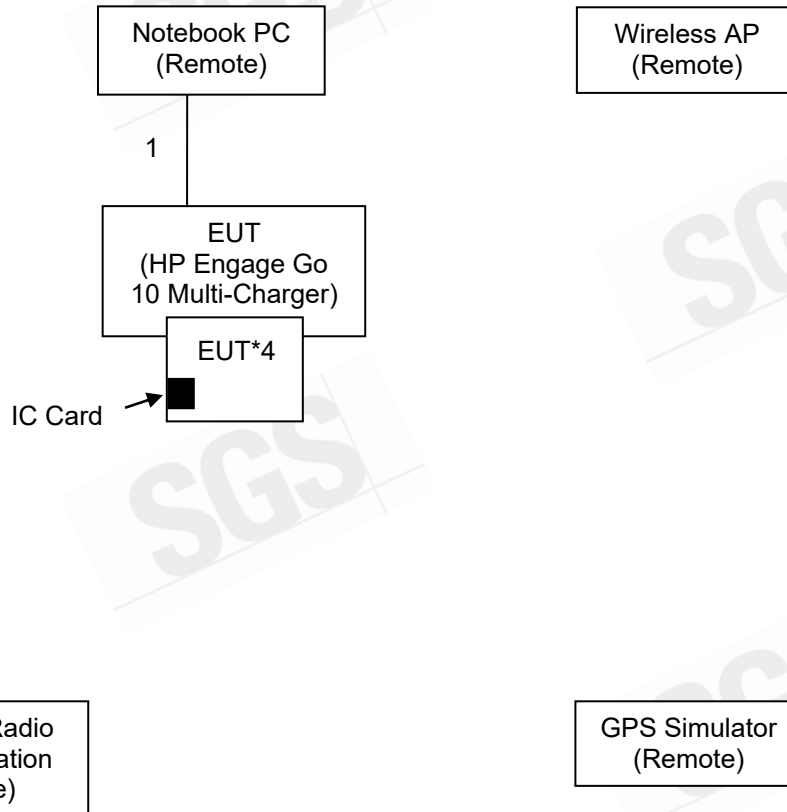

Unless otherwise stated the results shown in this test report refer only to the sample(s) tested and such sample(s) are retained for 90 days only.

除非另有說明，此報告結果僅對測試之樣品負責，同時此樣品僅保留90天。本報告未經本公司書面許可，不可部份複製。

This document is issued by the Company subject to its General Conditions of Service printed overleaf, available on request or accessible at www.sgs.com/terms_and_conditions.htm and for electronic format documents, subject to Terms and Conditions for Electronic Documents at www.sgs.com/terms_e-document.htm. Attention is drawn to the limitation of liability, indemnification and jurisdiction issues defined therein. Any holder of this document is advised that information contained hereon reflects the Company's findings at the time of its intervention only and within the limits of Client's instructions, if any. The Company's sole responsibility is to its Client and this document does not exonerate parties to a transaction from exercising all their rights and obligations under the transaction documents. This document cannot be reproduced except in full, without prior written approval of the Company. Any unauthorized alteration, forgery or falsification of the content or appearance of this document is unlawful and offenders may be prosecuted to the fullest extent of the law.

Mode 12:

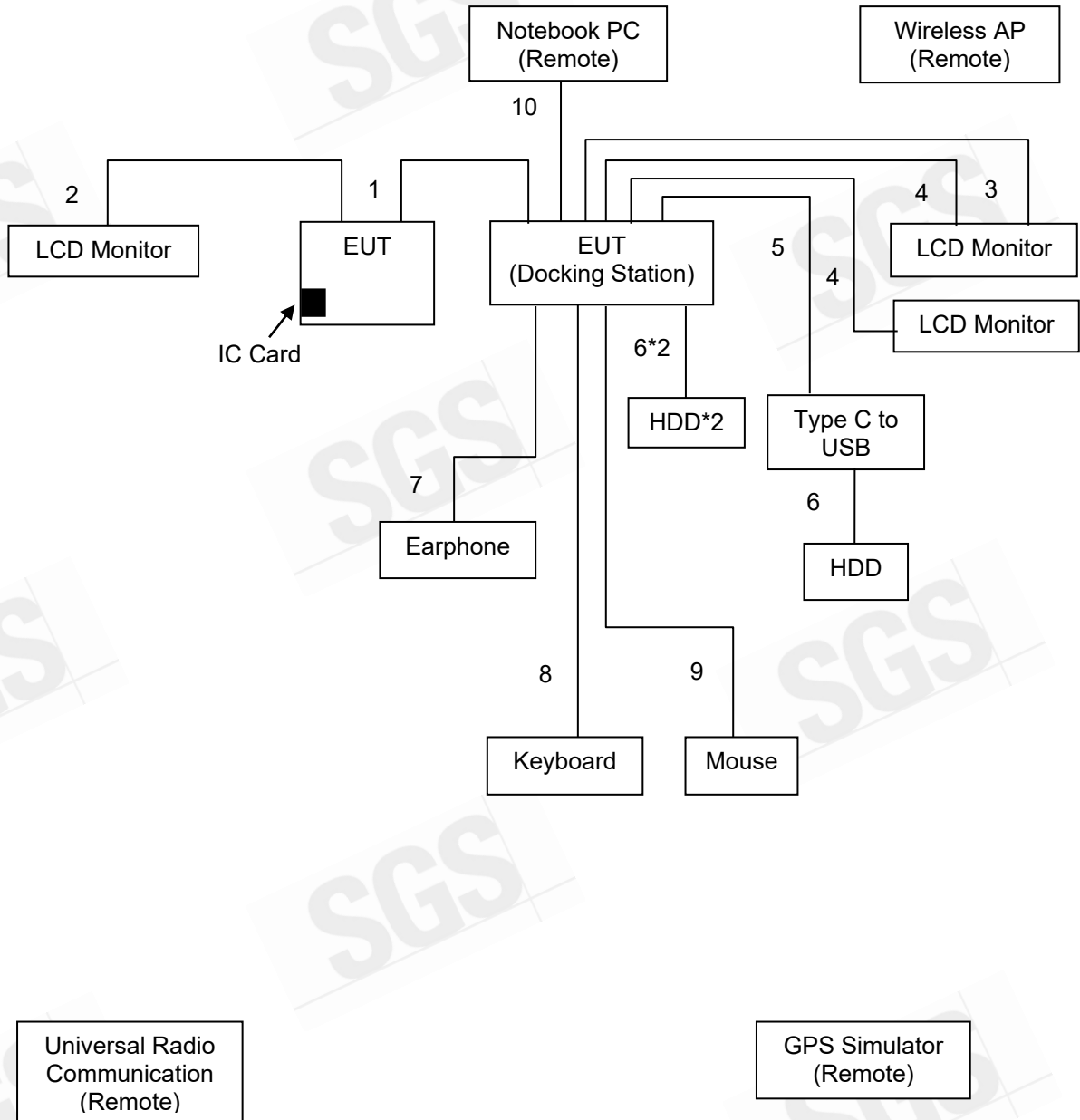

Universal Radio
Communication
(Remote)

GPS Simulator
(Remote)

Unless otherwise stated the results shown in this test report refer only to the sample(s) tested and such sample(s) are retained for 90 days only.

除非另有說明，此報告結果僅對測試之樣品負責，同時此樣品僅保留90天。本報告未經本公司書面許可，不可部份複製。

This document is issued by the Company subject to its General Conditions of Service printed overleaf, available on request or accessible at www.sgs.com/terms_and_conditions.htm and for electronic format documents, subject to Terms and Conditions for Electronic Documents at www.sgs.com/terms_e-document.htm. Attention is drawn to the limitation of liability, indemnification and jurisdiction issues defined therein. Any holder of this document is advised that information contained hereon reflects the Company's findings at the time of its intervention only and within the limits of Client's instructions, if any. The Company's sole responsibility is to its Client and this document does not exonerate parties to a transaction from exercising all their rights and obligations under the transaction documents. This document cannot be reproduced except in full, without prior written approval of the Company. Any unauthorized alteration, forgery or falsification of the content or appearance of this document is unlawful and offenders may be prosecuted to the fullest extent of the law.

Mode 13:

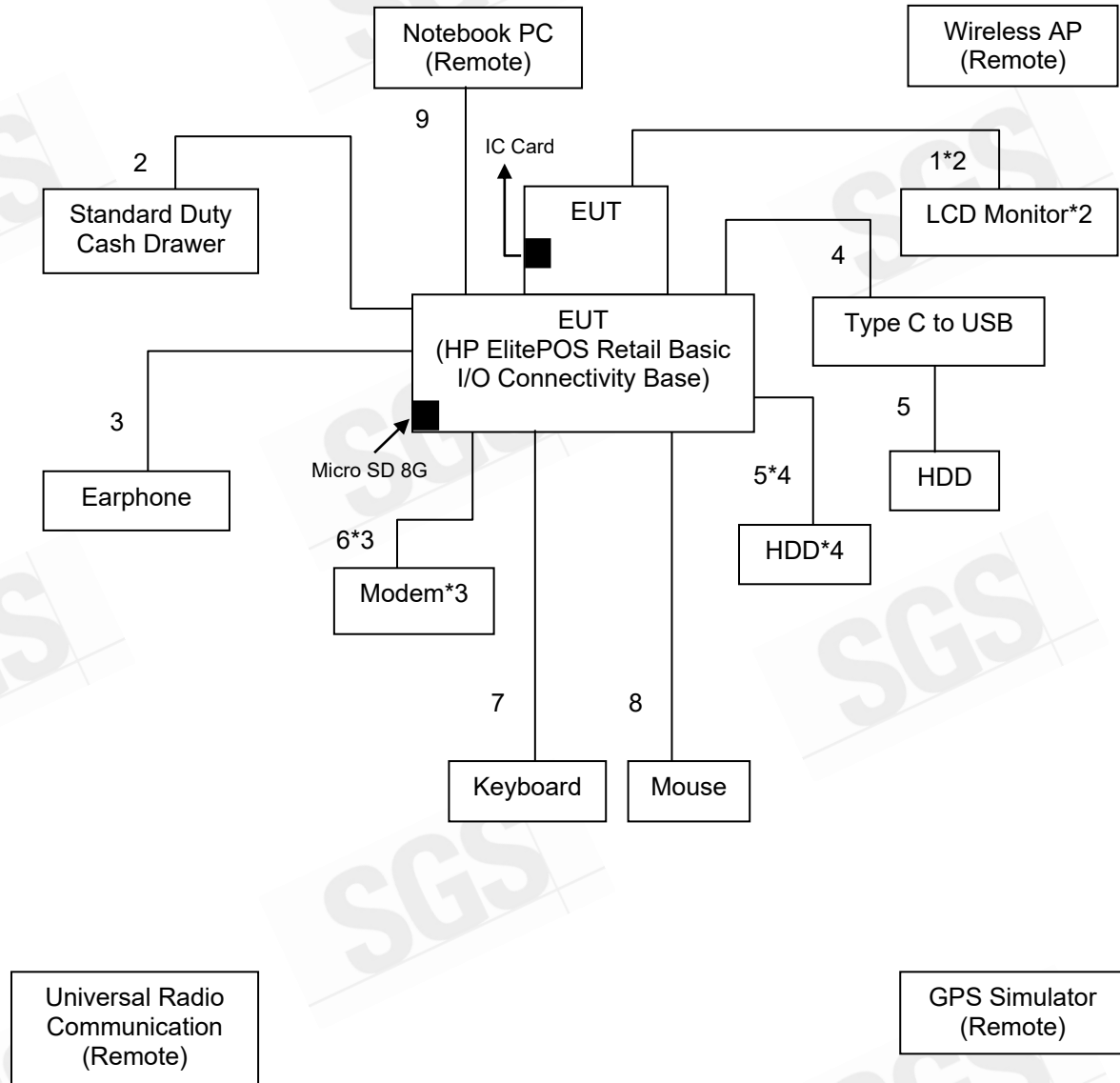

1.8 Accessories Cable List

See clause 1.3 of this report

Unless otherwise stated the results shown in this test report refer only to the sample(s) tested and such sample(s) are retained for 90 days only.

除非另有說明，此報告結果僅對測試之樣品負責，同時此樣品僅保留90天。本報告未經本公司書面許可，不可部份複製。

This document is issued by the Company subject to its General Conditions of Service printed overleaf, available on request or accessible at www.sgs.com/terms_and_conditions.htm and for electronic format documents, subject to Terms and Conditions for Electronic Documents at www.sgs.com/terms_e-document.htm. Attention is drawn to the limitation of liability, indemnification and jurisdiction issues defined therein. Any holder of this document is advised that information contained hereon reflects the Company's findings at the time of its intervention only and within the limits of Client's instructions, if any. The Company's sole responsibility is to its Client and this document does not exonerate parties to a transaction from exercising all their rights and obligations under the transaction documents. This document cannot be reproduced except in full, without prior written approval of the Company. Any unauthorized alteration, forgery or falsification of the content or appearance of this document is unlawful and offenders may be prosecuted to the fullest extent of the law.

1.9 Measurement Procedure

Conducted Emission Testing was performed according to ANSI C63.4:2014 in a shielded room with peripherals placed on a table, 0.8m high over a metal floor. It was located more than required distance away from the shielded room wall.

Radiated Emission Testing was performed according to ANSI C63.4:2014 at the 3/10m semi-anechoic chamber. The EUT was placed on a 0.8m high table along with the peripherals. The turn table was placed 10m distance from the antenna. Cables were placed in a position to produce maximum emissions as determined by experimentation, and operation mode was selected for production of maximum emission.

The frequencies and amplitudes of maximum emission were measured at varying azimuths, antenna heights and antenna polarities. Maximum emission levels are then reported.

1.10 Standards Applicable for Testing

Tests to be carried out under 47 CFR FCC Part 15 Subpart B/CISPR 22/ICES-003

Test Standards	Status
47 CFR FCC Part 15 Subpart B CISPR 22 ICES-003	Applicable
Deviation from Standard	No deviation

Unless otherwise stated the results shown in this test report refer only to the sample(s) tested and such sample(s) are retained for 90 days only.

除非另有說明，此報告結果僅對測試之樣品負責，同時此樣品僅保留90天。本報告未經本公司書面許可，不可部份複製。

This document is issued by the Company subject to its General Conditions of Service printed overleaf, available on request or accessible at www.sgs.com/terms_and_conditions.htm and for electronic format documents, subject to Terms and Conditions for Electronic Documents at www.sgs.com/terms_e-document.htm. Attention is drawn to the limitation of liability, indemnification and jurisdiction issues defined therein. Any holder of this document is advised that information contained hereon reflects the Company's findings at the time of its intervention only and within the limits of Client's instructions, if any. The Company's sole responsibility is to its Client and this document does not exonerate parties to a transaction from exercising all their rights and obligations under the transaction documents. This document cannot be reproduced except in full, without prior written approval of the Company. Any unauthorized alteration, forgery or falsification of the content or appearance of this document is unlawful and offenders may be prosecuted to the fullest extent of the law.

1.11 Decision Rules of Results

Reported measurement data comply with 47 CFR FCC Part 15 Subpart B and ICES-003.

Determining compliance shall be based on the results of the compliance measurement, not taking into account measurement instrumentation uncertainty.

1.12 Summary of Results

Standard	Test Type	Result
47 CFR FCC Part 15 Subpart B (Class B)	Conducted Emission	PASS
ICES-003 Issue 7: October 2020 (Class B)	Radiated Emission	PASS

1.13 Reporting Statements of Conformity

The conformity statement in this report is based solely on the test results, measurement uncertainty is excluded.

Unless otherwise stated the results shown in this test report refer only to the sample(s) tested and such sample(s) are retained for 90 days only.

除非另有說明，此報告結果僅對測試之樣品負責，同時此樣品僅保留90天。本報告未經本公司書面許可，不可部份複製。

This document is issued by the Company subject to its General Conditions of Service printed overleaf, available on request or accessible at www.sgs.com/terms_and_conditions.htm and for electronic format documents, subject to Terms and Conditions for Electronic Documents at www.sgs.com/terms_e-document.htm. Attention is drawn to the limitation of liability, indemnification and jurisdiction issues defined therein. Any holder of this document is advised that information contained hereon reflects the Company's findings at the time of its intervention only and within the limits of Client's instructions, if any. The Company's sole responsibility is to its Client and this document does not exonerate parties to a transaction from exercising all their rights and obligations under the transaction documents. This document cannot be reproduced except in full, without prior written approval of the Company. Any unauthorized alteration, forgery or falsification of the content or appearance of this document is unlawful and offenders may be prosecuted to the fullest extent of the law.

2. EMISSION

2.1 Test Results

Conducted Emission	Pass
Radiated Emission	Pass

2.2 Frequency Range

47 CFR FCC Part 15 Subpart B:

Conducted Emission : 150 kHz - 30 MHz

Radiated Emission : See below table

Highest frequency generated or used in the device or on which the device operates or tunes (MHz)	Upper frequency of measurement range (MHz)
Below 1.705	30
1.705 - 108	1000
108 - 500	2000
500 - 1000	5000
Above 1000	5th harmonic of the highest frequency or 40 GHz, whichever is lower.

ICES-003:

Conducted Emission : 150 kHz - 30 MHz

Radiated Emission : 30 MHz to 5thharmonic of the highest frequency or 40GHz, whichever is lower.

Highest internal frequency (F_x)	Highest measurement frequency
$F_x \leq 108$ MHz	1 GHz
$108 \text{ MHz} < F_x \leq 500$ MHz	2 GHz
$500 \text{ MHz} < F_x \leq 1$ GHz	5 GHz
$F_x > 1$ GHz	5 x F_x up to a maximum of 40 GHz

Note: F_x is the highest fundamental frequency generated and/or used in the ITE or digital apparatus under test.

Unless otherwise stated the results shown in this test report refer only to the sample(s) tested and such sample(s) are retained for 90 days only.

除非另有說明，此報告結果僅對測試之樣品負責，同時此樣品僅保留90天。本報告未經本公司書面許可，不可部份複製。

This document is issued by the Company subject to its General Conditions of Service printed overleaf, available on request or accessible at www.sgs.com/terms_and_conditions.htm and for electronic format documents, subject to Terms and Conditions for Electronic Documents at www.sgs.com/terms_e-document.htm. Attention is drawn to the limitation of liability, indemnification and jurisdiction issues defined therein. Any holder of this document is advised that information contained hereon reflects the Company's findings at the time of its intervention only and within the limits of Client's instructions, if any. The Company's sole responsibility is to its Client and this document does not exonerate parties to a transaction from exercising all their rights and obligations under the transaction documents. This document cannot be reproduced except in full, without prior written approval of the Company. Any unauthorized alteration, forgery or falsification of the content or appearance of this document is unlawful and offenders may be prosecuted to the fullest extent of the law.

2.3 Limits of Conducted and Radiated Emission

2.3.1 Limits of Conducted Emission

47 CFR FCC Part 15 Subpart B:

FREQUENCY (MHz)	Class A (dBuV)		Class B (dBuV)	
	Quasi - peak	Average	Quasi - peak	Average
0.15 - 0.5	79	66	66 - 56	56 - 46
0.50 – 5.0	73	60	56	46
5.0 – 30.0	73	60	60	50

Note : (1) The lower limit shall apply at the transition frequencies.

(2) The limit decreases linearly with the logarithm of the frequency in the range 0.15 to 0.50 MHz.

(3) All emanation from a class A/B digital device or system, including any network of conductors and apparatus connected there to, shall not exceed the level of field strengths specified above.

ICES-003:

FREQUENCY (MHz)	Class A (dBuV)		Class B (dBuV)	
	Quasi-peak	Average	Quasi-peak	Average
0.15 - 0.5	79	66	66 - 56*	56 - 46*
0.50 – 5.0	73	60	56	46
5.0 – 30.0	73	60	60	50

Note: The more stringent limit applies at transition frequencies.

*. The limit level in dBuV decreases linearly with the logarithm of frequency.

Unless otherwise stated the results shown in this test report refer only to the sample(s) tested and such sample(s) are retained for 90 days only.

除非另有說明，此報告結果僅對測試之樣品負責，同時此樣品僅保留90天。本報告未經本公司書面許可，不可部份複製。

This document is issued by the Company subject to its General Conditions of Service printed overleaf, available on request or accessible at www.sgs.com/terms_and_conditions.htm and for electronic format documents, subject to Terms and Conditions for Electronic Documents at www.sgs.com/terms_e-document.htm. Attention is drawn to the limitation of liability, indemnification and jurisdiction issues defined therein. Any holder of this document is advised that information contained hereon reflects the Company's findings at the time of its intervention only and within the limits of Client's instructions, if any. The Company's sole responsibility is to its Client and this document does not exonerate parties to a transaction from exercising all their rights and obligations under the transaction documents. This document cannot be reproduced except in full, without prior written approval of the Company. Any unauthorized alteration, forgery or falsification of the content or appearance of this document is unlawful and offenders may be prosecuted to the fullest extent of the law.

2.3.2 Limits of Radiated Emissions

47 CFR FCC Part 15 Subpart B Limit:

- Detector Function : Quasi – Peak

FREQUENCY (MHz)	Class A (at 10m)	Class B (at 3m)
	dBuV/m	dBuV/m
30~88	39	40
88~216	43.5	43.5
216~960	46.4	46
960~1000	49.5	54

- Detector Function : Peak , Average

FREQUENCY (MHz)	Class A (dBuV/m) (at 3m)		Class B (dBuV/m) (at 3m)	
	Peak	Average	Peak	Average
Above 1000	80	60	74	54

CISPR 22 Limit:

- Detector Function : Quasi – Peak

FREQUENCY (MHz)	Class A (at 10m)	Class B (at 10m)
	dBuV/m	dBuV/m
30~230	40	30
230~1000	47	37

NOTE 1 The lower limit shall apply at the transition frequency.

NOTE 2 Additional provisions may be required for cases where interference occurs.

Unless otherwise stated the results shown in this test report refer only to the sample(s) tested and such sample(s) are retained for 90 days only.

除非另有說明，此報告結果僅對測試之樣品負責，同時此樣品僅保留90天。本報告未經本公司書面許可，不可部份複製。

This document is issued by the Company subject to its General Conditions of Service printed overleaf, available on request or accessible at www.sgs.com/terms_and_conditions.htm and for electronic format documents, subject to Terms and Conditions for Electronic Documents at www.sgs.com/terms_e-document.htm. Attention is drawn to the limitation of liability, indemnification and jurisdiction issues defined therein. Any holder of this document is advised that information contained hereon reflects the Company's findings at the time of its intervention only and within the limits of Client's instructions, if any. The Company's sole responsibility is to its Client and this document does not exonerate parties to a transaction from exercising all their rights and obligations under the transaction documents. This document cannot be reproduced except in full, without prior written approval of the Company. Any unauthorized alteration, forgery or falsification of the content or appearance of this document is unlawful and offenders may be prosecuted to the fullest extent of the law.

ICES-003 Limit:

- Detector Function : Quasi-peak

Frequency (MHz)	Class A (3 m) (dBuV/m)	Class A (10 m) (dBuV/m)	Class B (3 m) (dBuV/m)	Class B (10 m) (dBuV/m)
30 - 88	50	40	40	30
88 - 216	54	43.5	43.5	33.1
216 - 230	56.9	46.4	46	35.6
230 - 960	57	47	47	37
960 - 1000	60	49.5	54	43.5

Note: The more stringent limit applies at transition frequencies

- Detector Function : Peak, Average

Frequency (MHz)	Class A (3 m) (dBuV/m)		Class B (3 m) (dBuV/m)	
	Peak	Average	Peak	Average
Above 1000	80	60	74	54

Unless otherwise stated the results shown in this test report refer only to the sample(s) tested and such sample(s) are retained for 90 days only.

除非另有說明，此報告結果僅對測試之樣品負責，同時此樣品僅保留90天。本報告未經本公司書面許可，不可部份複製。

This document is issued by the Company subject to its General Conditions of Service printed overleaf, available on request or accessible at www.sgs.com/terms_and_conditions.htm and for electronic format documents, subject to Terms and Conditions for Electronic Documents at www.sgs.com/terms_e-document.htm. Attention is drawn to the limitation of liability, indemnification and jurisdiction issues defined therein. Any holder of this document is advised that information contained hereon reflects the Company's findings at the time of its intervention only and within the limits of Client's instructions, if any. The Company's sole responsibility is to its Client and this document does not exonerate parties to a transaction from exercising all their rights and obligations under the transaction documents. This document cannot be reproduced except in full, without prior written approval of the Company. Any unauthorized alteration, forgery or falsification of the content or appearance of this document is unlawful and offenders may be prosecuted to the fullest extent of the law.

2.4. Test of Conducted Emission

2.4.1 Test Equipments

Conducted Emission Conducted Room No.B_EMC					
EQUIPMENT TYPE	Manufacturer	Model Number	Serial Number	Calibration Date	Calibration Due
Coaxial Cable	EMCI	EMCRG142	190809	04/28/2021	04/27/2022
EMI Test Receiver	R&S	ESCI	101073	07/01/2020	06/30/2021
LISN	Schwarzbeck	NSLK8128	5012	04/07/2021	04/06/2022
LISN	SCHWARZBECK	NSLK 8127	01022	04/15/2021	04/14/2022
Software	CCS-3A1-CE				
Compliance Certification Services Inc. (Wugu Laboratory)					
Testing Site: No.139, Wugong Rd., Wugu Dist., New Taipei City, Taiwan (R.O.C.)					
Measurement Uncertainty of Conducted Emission					
Expanded uncertainty Ulab (k=2) of Conducted Emission is 3.06 dB.					
Expanded uncertainty CISPR 16-4-2:2011+A1:2014+A2:2018 (k=2) of Conducted Emission measurement is 3.44 dB					

2.4.2 Measurement Level Calculation

Factor = LISN insertion loss + Cable loss + Pulse Limiter insertion loss

Measurement Level = Reading Level + Factor

Over (Margin) = Measurement Level – Limit

Unless otherwise stated the results shown in this test report refer only to the sample(s) tested and such sample(s) are retained for 90 days only.

除非另有說明，此報告結果僅對測試之樣品負責，同時此樣品僅保留90天。本報告未經本公司書面許可，不可部份複製。

This document is issued by the Company subject to its General Conditions of Service printed overleaf, available on request or accessible at www.sgs.com/terms_and_conditions.htm and for electronic format documents, subject to Terms and Conditions for Electronic Documents at www.sgs.com/terms_e-document.htm. Attention is drawn to the limitation of liability, indemnification and jurisdiction issues defined therein. Any holder of this document is advised that information contained hereon reflects the Company's findings at the time of its intervention only and within the limits of Client's instructions, if any. The Company's sole responsibility is to its Client and this document does not exonerate parties to a transaction from exercising all their rights and obligations under the transaction documents. This document cannot be reproduced except in full, without prior written approval of the Company. Any unauthorized alteration, forgery or falsification of the content or appearance of this document is unlawful and offenders may be prosecuted to the fullest extent of the law.

2.4.3 Measurement Data:

Model no.	HSC-I001R	Line:	L1
Environmental Conditions	24°C, 50% RH	Tested Date	2021/05/14
Test Mode	Mode 8	Tested By	Thomas Liu
6dB Bandwidth	9 kHz	Identifier number	TCOP CE site 17

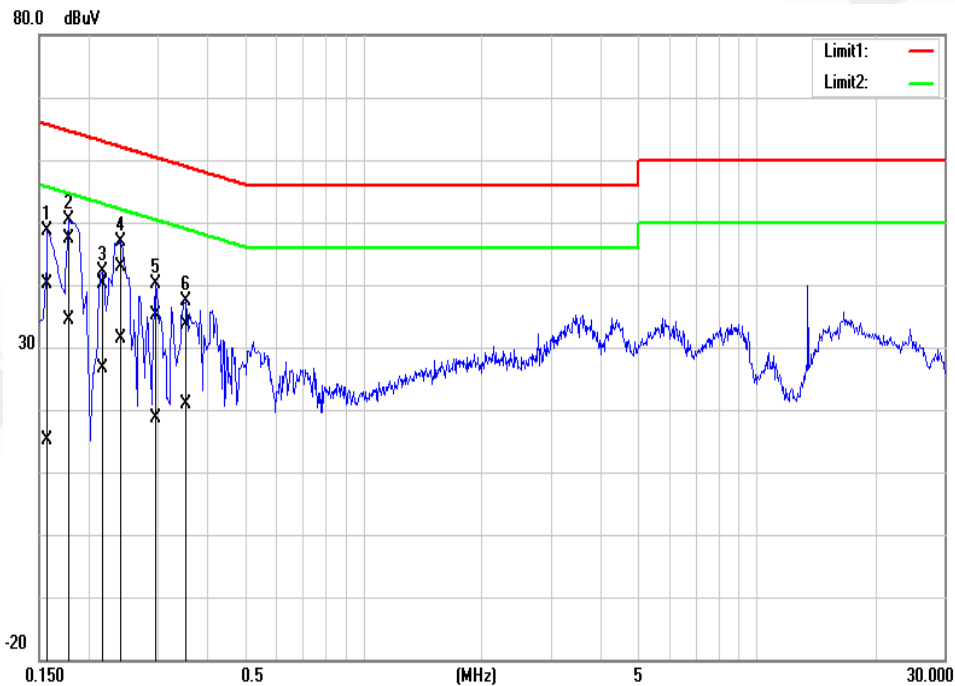

NO.	Frequency (MHz)	Quasi Peak reading (dBuV)	Average reading (dBuV)	Correction factor (dB)	Quasi Peak result (dBuV)	Average result (dBuV)	Quasi Peak limit (dBuV)	Average limit (dBuV)	Quasi Peak margin (dB)	Average margin (dB)	Remark
1	0.1580	40.11	15.11	0.12	40.23	15.23	65.56	55.57	-25.33	-40.34	Pass
2*	0.1780	47.25	34.34	0.14	47.39	34.48	64.57	54.58	-17.18	-20.10	Pass
3	0.2180	40.04	26.47	0.14	40.18	26.61	62.89	52.89	-22.71	-26.28	Pass
4	0.2420	42.83	31.21	0.14	42.97	31.35	62.02	52.03	-19.05	-20.68	Pass
5	0.2980	34.87	18.55	0.14	35.01	18.69	60.30	50.30	-25.29	-31.61	Pass
6	0.3540	33.47	20.73	0.15	33.62	20.88	58.87	48.87	-25.25	-27.99	Pass

Note: L1 = Live Line

Unless otherwise stated the results shown in this test report refer only to the sample(s) tested and such sample(s) are retained for 90 days only.

除非另有說明，此報告結果僅對測試之樣品負責，同時此樣品僅保留90天。本報告未經本公司書面許可，不可部份複製。

This document is issued by the Company subject to its General Conditions of Service printed overleaf, available on request or accessible at www.sgs.com/terms_and_conditions.htm and for electronic format documents, subject to Terms and Conditions for Electronic Documents at www.sgs.com/terms_e-document.htm. Attention is drawn to the limitation of liability, indemnification and jurisdiction issues defined therein. Any holder of this document is advised that information contained hereon reflects the Company's findings at the time of its intervention only and within the limits of Client's instructions, if any. The Company's sole responsibility is to its Client and this document does not exonerate parties to a transaction from exercising all their rights and obligations under the transaction documents. This document cannot be reproduced except in full, without prior written approval of the Company. Any unauthorized alteration, forgery or falsification of the content or appearance of this document is unlawful and offenders may be prosecuted to the fullest extent of the law.

Model no.	HSC-I001R	Line:	N
Environmental Conditions	24°C, 50% RH	Tested Date	2021/05/14
Test Mode	Mode 8	Tested By	Thomas Liu
6dB Bandwidth	9 kHz	Identifier number	TCOP CE site 17

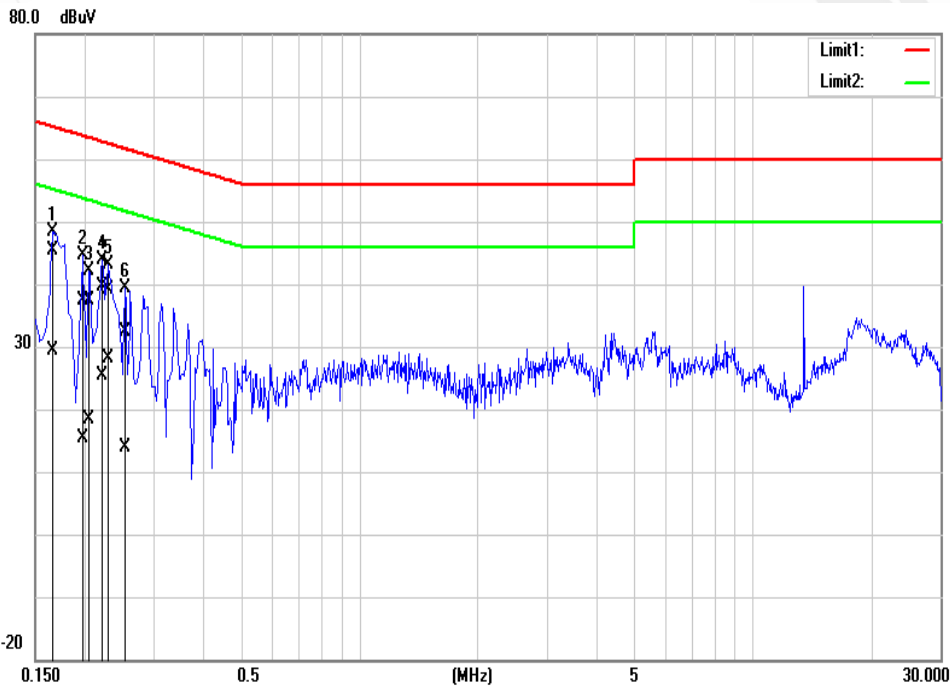

NO.	Frequency (MHz)	Quasi Peak reading (dBuV)	Average reading (dBuV)	Correction factor (dB)	Quasi Peak result (dBuV)	Average result (dBuV)	Quasi Peak limit (dBuV)	Average limit (dBuV)	Quasi Peak margin (dB)	Average margin (dB)	Remark (Pass/Fail)
1*	0.1660	45.33	29.23	0.14	45.47	29.37	65.15	55.16	-19.68	-25.79	Pass
2	0.1980	37.14	15.13	0.15	37.29	15.28	63.69	53.69	-26.40	-38.41	Pass
3	0.2060	37.12	18.28	0.15	37.27	18.43	63.36	53.37	-26.09	-34.94	Pass
4	0.2220	39.37	25.28	0.15	39.52	25.43	62.74	52.74	-23.22	-27.31	Pass
5	0.2300	39.10	27.96	0.15	39.25	28.11	62.45	52.45	-23.20	-24.34	Pass
6	0.2540	32.12	13.72	0.15	32.27	13.87	61.62	51.63	-29.35	-37.76	Pass

Note: N = Neutral Line

Unless otherwise stated the results shown in this test report refer only to the sample(s) tested and such sample(s) are retained for 90 days only.

除非另有說明，此報告結果僅對測試之樣品負責，同時此樣品僅保留90天。本報告未經本公司書面許可，不可部份複製。

This document is issued by the Company subject to its General Conditions of Service printed overleaf, available on request or accessible at www.sgs.com/terms_and_conditions.htm and for electronic format documents, subject to Terms and Conditions for Electronic Documents at www.sgs.com/terms_e-document.htm. Attention is drawn to the limitation of liability, indemnification and jurisdiction issues defined therein. Any holder of this document is advised that information contained hereon reflects the Company's findings at the time of its intervention only and within the limits of Client's instructions, if any. The Company's sole responsibility is to its Client and this document does not exonerate parties to a transaction from exercising all their rights and obligations under the transaction documents. This document cannot be reproduced except in full, without prior written approval of the Company. Any unauthorized alteration, forgery or falsification of the content or appearance of this document is unlawful and offenders may be prosecuted to the fullest extent of the law.

Model no.	HSC-I001R	Line:	L1
Environmental Conditions	23°C, 47% RH	Tested Date	2021/05/18
Test Mode	Mode 11	Tested By	Thomas Liu
6dB Bandwidth	9 kHz	Identifier number	TCOP CE site 17

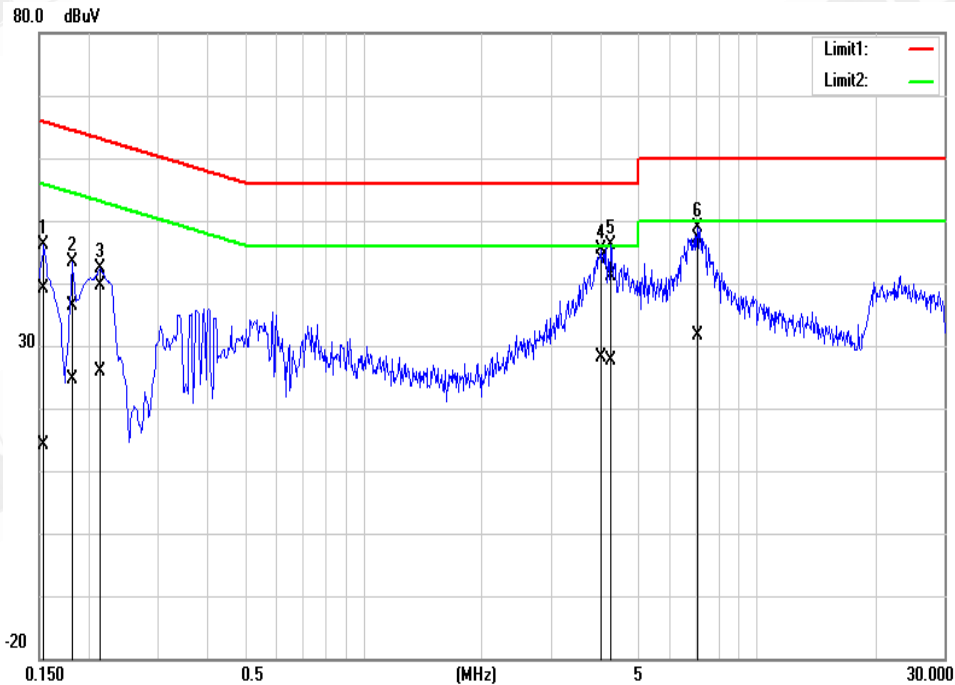

NO.	Frequency (MHz)	Quasi Peak reading (dBuV)	Average reading (dBuV)	Correction factor (dB)	Quasi Peak result (dBuV)	Average result (dBuV)	Quasi Peak limit (dBuV)	Average limit (dBuV)	Quasi Peak margin (dB)	Average margin (dB)	Remark (Pass/Fail)
1	0.1539	39.03	14.02	0.12	39.15	14.14	65.78	55.79	-26.63	-41.65	Pass
2	0.1819	36.32	24.61	0.14	36.46	24.75	64.39	54.40	-27.93	-29.65	Pass
3	0.2140	39.37	25.75	0.14	39.51	25.89	63.04	53.05	-23.53	-27.16	Pass
4*	4.0260	43.56	27.95	0.28	43.84	28.23	56.00	46.00	-12.16	-17.77	Pass
5	4.2660	40.78	27.32	0.29	41.07	27.61	56.00	46.00	-14.93	-18.39	Pass
6	7.0740	46.83	31.40	0.35	47.18	31.75	60.00	50.00	-12.82	-18.25	Pass

Note: L1 = Live Line

Unless otherwise stated the results shown in this test report refer only to the sample(s) tested and such sample(s) are retained for 90 days only.

除非另有說明，此報告結果僅對測試之樣品負責，同時此樣品僅保留90天。本報告未經本公司書面許可，不可部份複製。

This document is issued by the Company subject to its General Conditions of Service printed overleaf, available on request or accessible at www.sgs.com/terms_and_conditions.htm and for electronic format documents, subject to Terms and Conditions for Electronic Documents at www.sgs.com/terms_e-document.htm. Attention is drawn to the limitation of liability, indemnification and jurisdiction issues defined therein. Any holder of this document is advised that information contained hereon reflects the Company's findings at the time of its intervention only and within the limits of Client's instructions, if any. The Company's sole responsibility is to its Client and this document does not exonerate parties to a transaction from exercising all their rights and obligations under the transaction documents. This document cannot be reproduced except in full, without prior written approval of the Company. Any unauthorized alteration, forgery or falsification of the content or appearance of this document is unlawful and offenders may be prosecuted to the fullest extent of the law.

Model no.	HSC-I001R	Line:	N
Environmental Conditions	23°C, 47% RH	Tested Date	2021/05/18
Test Mode	Mode 11	Tested By	Thomas Liu
6dB Bandwidth	9 kHz	Identifier number	TCOP CE site 17

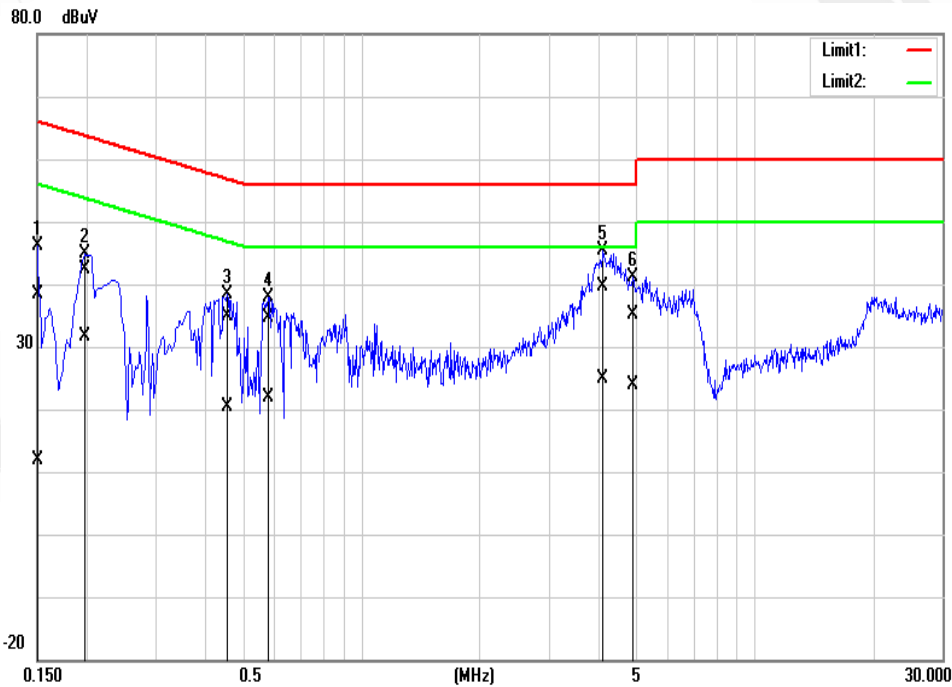

NO.	Frequency (MHz)	Quasi Peak reading (dBuV)	Average reading (dBuV)	Correction factor (dB)	Quasi Peak result (dBuV)	Average result (dBuV)	Quasi Peak limit (dBuV)	Average limit (dBuV)	Quasi Peak margin (dB)	Average margin (dB)	Remark (Pass/Fail)
1	0.1500	38.18	11.66	0.14	38.32	11.80	65.99	56.00	-27.67	-44.20	Pass
2	0.1980	42.23	31.53	0.15	42.38	31.68	63.69	53.69	-21.31	-22.01	Pass
3	0.4580	34.60	20.24	0.17	34.77	20.41	56.73	46.73	-21.96	-26.32	Pass
4	0.5820	34.41	21.79	0.17	34.58	21.96	56.00	46.00	-21.42	-24.04	Pass
5*	4.1220	39.45	24.58	0.29	39.74	24.87	56.00	46.00	-16.26	-21.13	Pass
6	4.9020	34.70	23.49	0.31	35.01	23.80	56.00	46.00	-20.99	-22.20	Pass

Note: N = Neutral Line

Unless otherwise stated the results shown in this test report refer only to the sample(s) tested and such sample(s) are retained for 90 days only.

除非另有說明，此報告結果僅對測試之樣品負責，同時此樣品僅保留90天。本報告未經本公司書面許可，不可部份複製。

This document is issued by the Company subject to its General Conditions of Service printed overleaf, available on request or accessible at www.sgs.com/terms_and_conditions.htm and for electronic format documents, subject to Terms and Conditions for Electronic Documents at www.sgs.com/terms_e-document.htm. Attention is drawn to the limitation of liability, indemnification and jurisdiction issues defined therein. Any holder of this document is advised that information contained hereon reflects the Company's findings at the time of its intervention only and within the limits of Client's instructions, if any. The Company's sole responsibility is to its Client and this document does not exonerate parties to a transaction from exercising all their rights and obligations under the transaction documents. This document cannot be reproduced except in full, without prior written approval of the Company. Any unauthorized alteration, forgery or falsification of the content or appearance of this document is unlawful and offenders may be prosecuted to the fullest extent of the law.

Model no.	HSC-I001R	Line:	L1
Environmental Conditions	26°C, 54% RH	Tested Date	2021/05/16
Test Mode	Mode 12	Tested By	Thomas Liu
6dB Bandwidth	9 kHz	Identifier number	TCOP CE site 17

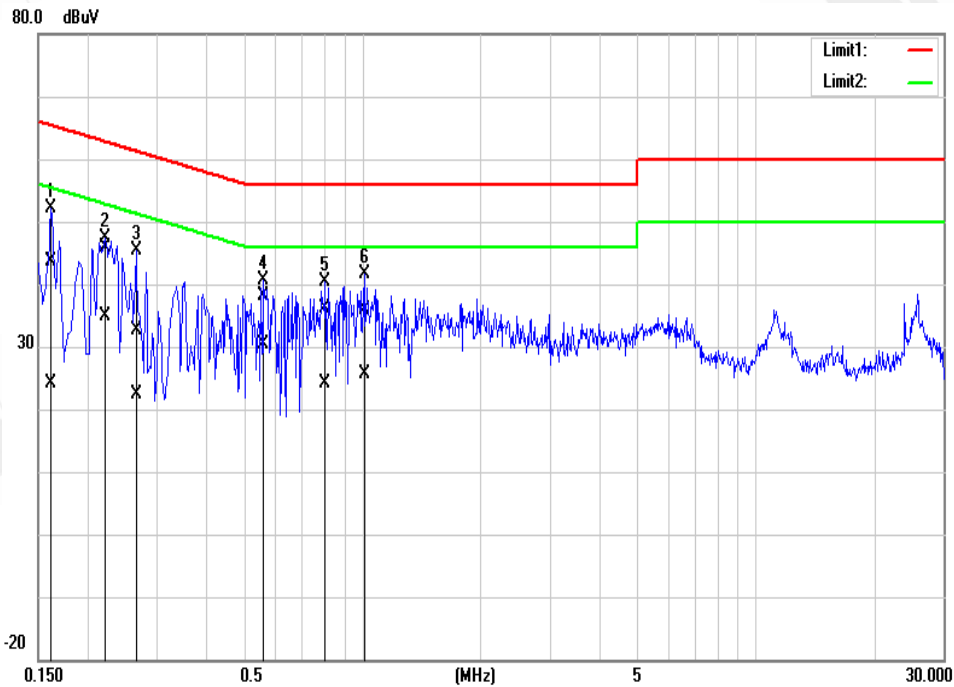

NO.	Frequency (MHz)	Quasi Peak reading (dBuV)	Average reading (dBuV)	Correction factor (dB)	Quasi Peak result (dBuV)	Average result (dBuV)	Quasi Peak limit (dBuV)	Average limit (dBuV)	Quasi Peak margin (dB)	Average margin (dB)	Remark (Pass/Fail)
1	0.1620	43.48	24.06	0.12	43.60	24.18	65.36	55.36	-21.76	-31.18	Pass
2	0.2220	45.64	34.80	0.14	45.78	34.94	62.74	52.74	-16.96	-17.80	Pass
3	0.2660	32.43	22.20	0.14	32.57	22.34	61.24	51.24	-28.67	-28.90	Pass
4*	0.5620	37.86	30.11	0.16	38.02	30.27	56.00	46.00	-17.98	-15.73	Pass
5	0.8059	35.90	23.96	0.17	36.07	24.13	56.00	46.00	-19.93	-21.87	Pass
6	1.0140	35.60	25.39	0.18	35.78	25.57	56.00	46.00	-20.22	-20.43	Pass

Note: L1 = Live Line

Unless otherwise stated the results shown in this test report refer only to the sample(s) tested and such sample(s) are retained for 90 days only.

除非另有說明，此報告結果僅對測試之樣品負責，同時此樣品僅保留90天。本報告未經本公司書面許可，不可部份複製。

This document is issued by the Company subject to its General Conditions of Service printed overleaf, available on request or accessible at www.sgs.com/terms_and_conditions.htm and for electronic format documents, subject to Terms and Conditions for Electronic Documents at www.sgs.com/terms_e-document.htm. Attention is drawn to the limitation of liability, indemnification and jurisdiction issues defined therein. Any holder of this document is advised that information contained hereon reflects the Company's findings at the time of its intervention only and within the limits of Client's instructions, if any. The Company's sole responsibility is to its Client and this document does not exonerate parties to a transaction from exercising all their rights and obligations under the transaction documents. This document cannot be reproduced except in full, without prior written approval of the Company. Any unauthorized alteration, forgery or falsification of the content or appearance of this document is unlawful and offenders may be prosecuted to the fullest extent of the law.

Model no.	HSC-I001R	Line:	N
Environmental Conditions	26°C, 54% RH	Tested Date	2021/05/16
Test Mode	Mode 12	Tested By	Thomas Liu
6dB Bandwidth	9 kHz	Identifier number	TCOP CE site 17

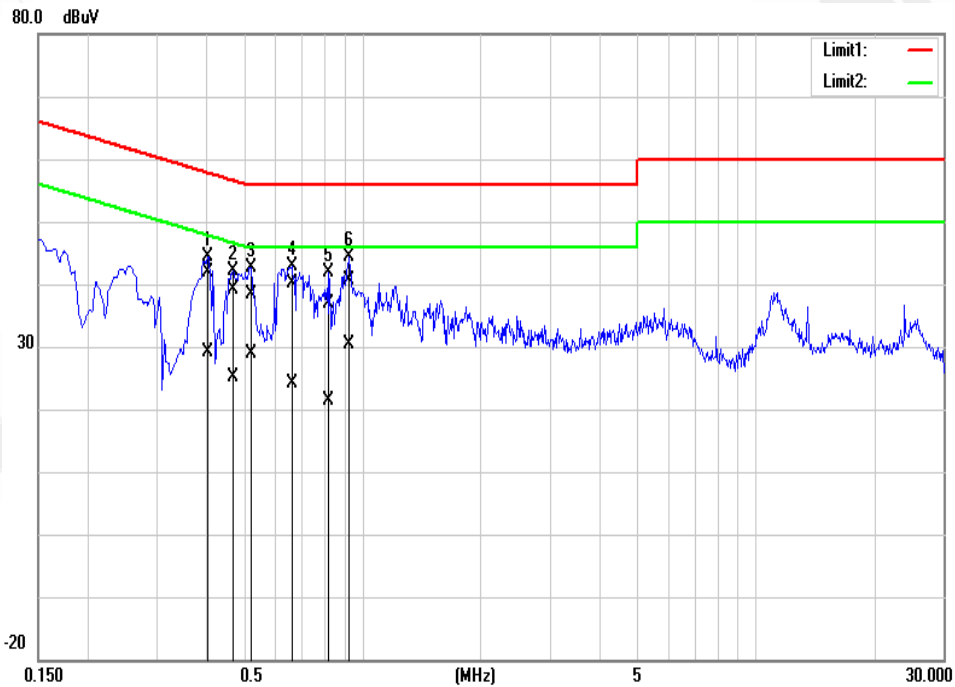

NO.	Frequency (MHz)	Quasi Peak reading (dBuV)	Average reading (dBuV)	Correction factor (dB)	Quasi Peak result (dBuV)	Average result (dBuV)	Quasi Peak limit (dBuV)	Average limit (dBuV)	Quasi Peak margin (dB)	Average margin (dB)	Remark (Pass/Fail)
1	0.4060	41.62	29.01	0.17	41.79	29.18	57.73	47.73	-15.94	-18.55	Pass
2	0.4700	38.93	24.99	0.17	39.10	25.16	56.51	46.51	-17.41	-21.35	Pass
3	0.5220	38.24	28.74	0.17	38.41	28.91	56.00	46.00	-17.59	-17.09	Pass
4	0.6620	40.04	23.95	0.17	40.21	24.12	56.00	46.00	-15.79	-21.88	Pass
5	0.8220	36.74	21.29	0.19	36.93	21.48	56.00	46.00	-19.07	-24.52	Pass
6*	0.9260	40.45	30.22	0.19	40.64	30.41	56.00	46.00	-15.36	-15.59	Pass

Note: N = Neutral Line

Unless otherwise stated the results shown in this test report refer only to the sample(s) tested and such sample(s) are retained for 90 days only.

除非另有說明，此報告結果僅對測試之樣品負責，同時此樣品僅保留90天。本報告未經本公司書面許可，不可部份複製。

This document is issued by the Company subject to its General Conditions of Service printed overleaf, available on request or accessible at www.sgs.com/terms_and_conditions.htm and for electronic format documents, subject to Terms and Conditions for Electronic Documents at www.sgs.com/terms_e-document.htm. Attention is drawn to the limitation of liability, indemnification and jurisdiction issues defined therein. Any holder of this document is advised that information contained hereon reflects the Company's findings at the time of its intervention only and within the limits of Client's instructions, if any. The Company's sole responsibility is to its Client and this document does not exonerate parties to a transaction from exercising all their rights and obligations under the transaction documents. This document cannot be reproduced except in full, without prior written approval of the Company. Any unauthorized alteration, forgery or falsification of the content or appearance of this document is unlawful and offenders may be prosecuted to the fullest extent of the law.

Model no.	HSC-I001R	Line:	L1
Environmental Conditions	26°C, 54% RH	Tested Date	2021/05/16
Test Mode	Mode 13	Tested By	Thomas Liu
6dB Bandwidth	9 kHz	Identifier number	TCOP CE site 17

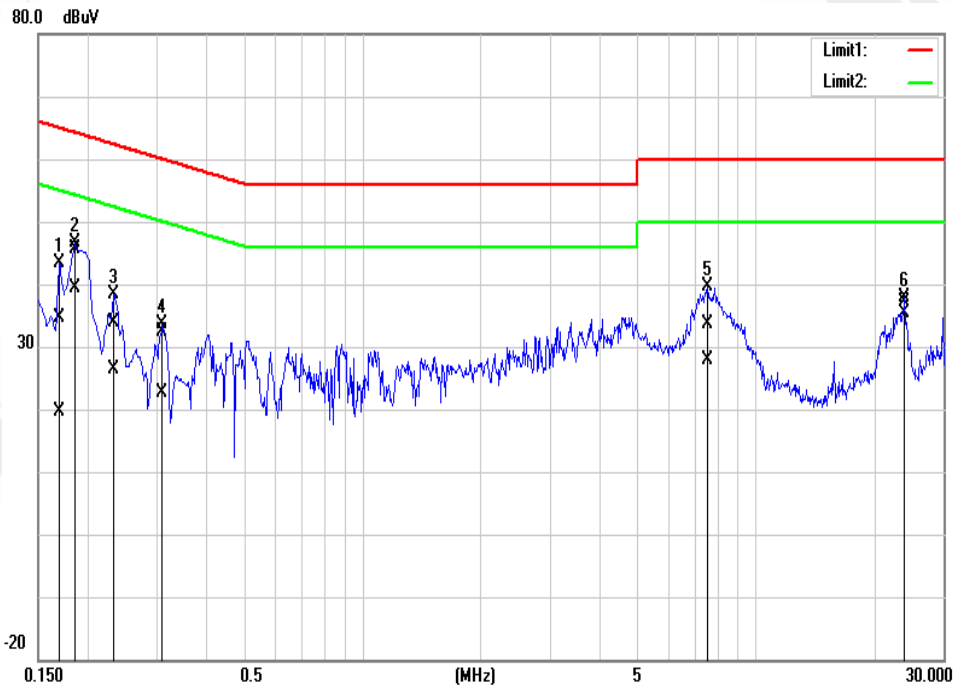

NO.	Frequency (MHz)	Quasi Peak reading (dBuV)	Average reading (dBuV)	Correction factor (dB)	Quasi Peak result (dBuV)	Average result (dBuV)	Quasi Peak limit (dBuV)	Average limit (dBuV)	Quasi Peak margin (dB)	Average margin (dB)	Remark (Pass/Fail)
1	0.1700	34.57	19.53	0.12	34.69	19.65	64.96	54.96	-30.27	-35.31	Pass
2	0.1860	45.57	39.14	0.14	45.71	39.28	64.21	54.21	-18.50	-14.93	Pass
3	0.2340	33.83	26.21	0.14	33.97	26.35	62.30	52.31	-28.33	-25.96	Pass
4	0.3100	32.20	22.43	0.15	32.35	22.58	59.97	49.97	-27.62	-27.39	Pass
5	7.5540	33.34	27.56	0.36	33.70	27.92	60.00	50.00	-26.30	-22.08	Pass
6*	23.9220	36.35	34.80	0.69	37.04	35.49	60.00	50.00	-22.96	-14.51	Pass

Note: L1 = Live Line

Unless otherwise stated the results shown in this test report refer only to the sample(s) tested and such sample(s) are retained for 90 days only.

除非另有說明，此報告結果僅對測試之樣品負責，同時此樣品僅保留90天。本報告未經本公司書面許可，不可部份複製。

This document is issued by the Company subject to its General Conditions of Service printed overleaf, available on request or accessible at www.sgs.com/terms_and_conditions.htm and for electronic format documents, subject to Terms and Conditions for Electronic Documents at www.sgs.com/terms_e-document.htm. Attention is drawn to the limitation of liability, indemnification and jurisdiction issues defined therein. Any holder of this document is advised that information contained hereon reflects the Company's findings at the time of its intervention only and within the limits of Client's instructions, if any. The Company's sole responsibility is to its Client and this document does not exonerate parties to a transaction from exercising all their rights and obligations under the transaction documents. This document cannot be reproduced except in full, without prior written approval of the Company. Any unauthorized alteration, forgery or falsification of the content or appearance of this document is unlawful and offenders may be prosecuted to the fullest extent of the law.

Model no.	HSC-I001R	Line:	N
Environmental Conditions	26°C, 54% RH	Tested Date	2021/05/16
Test Mode	Mode 13	Tested By	Thomas Liu
6dB Bandwidth	9 kHz	Identifier number	TCOP CE site 17

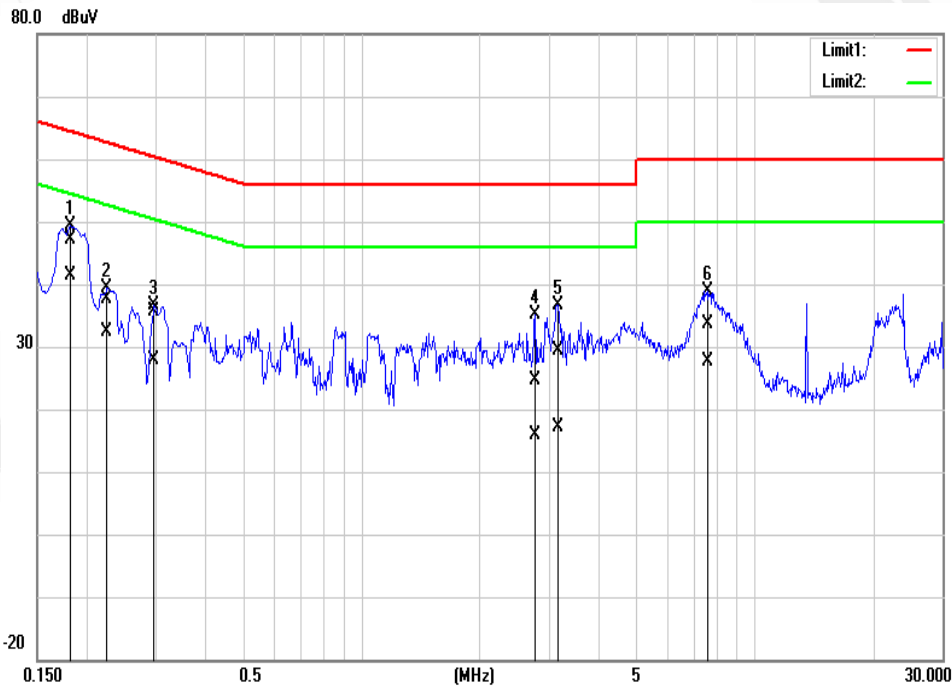

NO.	Frequency (MHz)	Quasi Peak reading (dBuV)	Average reading (dBuV)	Correction factor (dB)	Quasi Peak result (dBuV)	Average result (dBuV)	Quasi Peak limit (dBuV)	Average limit (dBuV)	Quasi Peak margin (dB)	Average margin (dB)	Remark (Pass/Fail)
1*	0.1819	47.05	41.15	0.15	47.20	41.30	64.39	54.40	-17.19	-13.10	Pass
2	0.2260	37.41	32.15	0.15	37.56	32.30	62.59	52.60	-25.03	-20.30	Pass
3	0.2980	35.39	27.82	0.15	35.54	27.97	60.30	50.30	-24.76	-22.33	Pass
4	2.7659	24.33	15.76	0.24	24.57	16.00	56.00	46.00	-31.43	-30.00	Pass
5	3.1580	29.16	16.76	0.26	29.42	17.02	56.00	46.00	-26.58	-28.98	Pass
6	7.5900	33.18	27.35	0.37	33.55	27.72	60.00	50.00	-26.45	-22.28	Pass

Note: N = Neutral Line

Unless otherwise stated the results shown in this test report refer only to the sample(s) tested and such sample(s) are retained for 90 days only.

除非另有說明，此報告結果僅對測試之樣品負責，同時此樣品僅保留90天。本報告未經本公司書面許可，不可部份複製。

This document is issued by the Company subject to its General Conditions of Service printed overleaf, available on request or accessible at www.sgs.com/terms_and_conditions.htm and for electronic format documents, subject to Terms and Conditions for Electronic Documents at www.sgs.com/terms_e-document.htm. Attention is drawn to the limitation of liability, indemnification and jurisdiction issues defined therein. Any holder of this document is advised that information contained hereon reflects the Company's findings at the time of its intervention only and within the limits of Client's instructions, if any. The Company's sole responsibility is to its Client and this document does not exonerate parties to a transaction from exercising all their rights and obligations under the transaction documents. This document cannot be reproduced except in full, without prior written approval of the Company. Any unauthorized alteration, forgery or falsification of the content or appearance of this document is unlawful and offenders may be prosecuted to the fullest extent of the law.

2.5 Test of Radiated Emission

2.5.1 Test Equipments

Below 1GHz

Radiated_Below_1GHz 10m EMC					
EQUIPMENT TYPE	Manufacturer	Model Number	Serial Number	Calibration Date	Calibration Due
Bilog Antenna	TESEQ	CBL 6112D	31674	02/22/2021	02/21/2022
Bilog Antenna	TESEQ	CBL 6112D	31675	03/15/2021	03/14/2022
Coaxial Cable	Huber+Suhner	SUCOFLEX 104PEA	330029	04/28/2021	04/27/2022
Coaxial Cable	Huber+Suhner	104PEA	33948/4PEA	04/28/2021	04/27/2022
Coaxial Cable	Huber+Suhner	104PEA	33949/4PEA	04/28/2021	04/27/2022
Coaxial Cable	Huber+Suhner	SUCOFLEX 104PEA	24813	04/28/2021	04/27/2022
EMI Test Receiver	R&S	ESCI	100961	06/08/2020	06/07/2021
EMI Test Receiver	R&S	ESCI	100962	06/12/2020	06/11/2021
Pre-Amplifier	HP	8447D	2944A07754	04/28/2021	04/27/2022
Pre-Amplifier	HP	8447D	2944A08150	04/28/2021	04/27/2022
AC POWER SOURCE	APE	AFC-130	991259	N.C.R	N.C.R
Antenna Tower	CCS	CC-A-1F	N/A	N.C.R	N.C.R
Antenna Tower	CCS	CC-A-1F	N/A	N.C.R	N.C.R
Controller	CCS	CC-C-1F	N/A	N.C.R	N.C.R
Controller	CCS	CC-C-1F	N/A	N.C.R	N.C.R
Turn Table	CCS	CC-T-1F	N/A	N.C.R	N.C.R
Software	EZ-EMC (CCS-3A1RE)				
Compliance Certification Services Inc. (Wugu Laboratory)					
Testing Site: No.139, Wugong Rd., Wugu Dist., New Taipei City, Taiwan (R.O.C.)					
Measurement Uncertainty of Radiated Emission					
Expanded uncertainty Ulab (k=2) of Radiated Emission is 4.15 dB. (30MHz-1GHz)					
Expanded uncertainty CISPR 16-4-2:2011+A1:2014+A2:2018 (k=2) of Radiated Emission measurement is 5.22 dB. (30MHz-1GHz)					

Unless otherwise stated the results shown in this test report refer only to the sample(s) tested and such sample(s) are retained for 90 days only.

除非另有說明，此報告結果僅對測試之樣品負責，同時此樣品僅保留90天。本報告未經本公司書面許可，不可部份複製。

This document is issued by the Company subject to its General Conditions of Service printed overleaf, available on request or accessible at www.sgs.com/terms_and_conditions.htm and for electronic format documents, subject to Terms and Conditions for Electronic Documents at www.sgs.com/terms_e-document.htm. Attention is drawn to the limitation of liability, indemnification and jurisdiction issues defined therein. Any holder of this document is advised that information contained hereon reflects the Company's findings at the time of its intervention only and within the limits of Client's instructions, if any. The Company's sole responsibility is to its Client and this document does not exonerate parties to a transaction from exercising all their rights and obligations under the transaction documents. This document cannot be reproduced except in full, without prior written approval of the Company. Any unauthorized alteration, forgery or falsification of the content or appearance of this document is unlawful and offenders may be prosecuted to the fullest extent of the law.

Above 1GHz

Radiated_Above_1GHz 10m EMC					
EQUIPMENT TYPE	Manufacturer	Model Number	Serial Number	Calibration Date	Calibration Due
Coaxial Cable	Huber+Suhner	SUCOFLEX 104PEA	329383	04/28/2021	04/27/2022
Coaxial Cable	Huber+Suhner	SUCOFLEX 104PEA	33945	04/28/2021	04/27/2022
Horn Antenna	ETS LINDGREN	3116	00026370	12/11/2020	12/10/2021
Horn Antenna	EMCO	3117	00055167	12/01/2020	11/30/2021
Pre-Amplifier	EMCI	EMC051845	980040	04/28/2021	04/27/2022
Pre-Amplifier	MITEQ	AMF-6F- 18004000-37-8P	985646	09/02/2020	09/01/2021
Spectrum Analyzer	Agilent	E4446A	MY48250297	08/24/2020	08/23/2021
AC POWER SOURCE	APE	AFC-130	991259	N.C.R	N.C.R
Antenna Tower	Sunol Sciences	TLT2	031010-5	N.C.R	N.C.R
Controller	Sunol Sciences	SC104V	031010-1	N.C.R	N.C.R
Turn Table	CCS	CC-T-1F	N/A	N.C.R	N.C.R
Software	EZ-EMC (CCS-3A1RE)				
Compliance Certification Services Inc. (Wugu Laboratory)					
Testing Site: No.139, Wugong Rd., Wugu Dist., New Taipei City, Taiwan (R.O.C.)					
Measurement Uncertainty of Radiated Emission					
Expanded uncertainty U _{lab} (k=2) of Radiated Emission measurement is 4.94 dB. (1-6GHz)					
Expanded uncertainty U _{lab} (k=2) of Radiated Emission measurement is 5.24 dB. (6-18GHz)					
Expanded uncertainty U _{lab} (k=2) of Radiated Emission measurement is 4.28 dB. (18-40GHz)					
Expanded uncertainty CISPR 16-4-2:2011+A1:2014+A2:2018 (k=2) of Radiated Emission measurement is 5.18 dB. (1-6GHz)					
Expanded uncertainty CISPR 16-4-2:2011+A1:2014+A2:2018 (k=2) of Radiated Emission measurement is 5.48 dB. (6-18GHz)					
Expanded uncertainty CISPR 16-4-2:2011+A1:2014+A2:2018 (k=2) of Radiated Emission measurement is --- dB. (18-40GHz)					

2.5.2 Measurement Level Calculation

Correction Factor = Antenna Factor + Cable loss - Amplifier Gain

Measurement Level = Reading Level + Correction Factor

Over (Margin) = Measurement Level – Limit

Unless otherwise stated the results shown in this test report refer only to the sample(s) tested and such sample(s) are retained for 90 days only.

除非另有說明，此報告結果僅對測試之樣品負責，同時此樣品僅保留90天。本報告未經本公司書面許可，不可部份複製。

This document is issued by the Company subject to its General Conditions of Service printed overleaf, available on request or accessible at www.sgs.com/terms_and_conditions.htm and for electronic format documents, subject to Terms and Conditions for Electronic Documents at www.sgs.com/terms_e-document.htm. Attention is drawn to the limitation of liability, indemnification and jurisdiction issues defined therein. Any holder of this document is advised that information contained hereon reflects the Company's findings at the time of its intervention only and within the limits of Client's instructions, if any. The Company's sole responsibility is to its Client and this document does not exonerate parties to a transaction from exercising all their rights and obligations under the transaction documents. This document cannot be reproduced except in full, without prior written approval of the Company. Any unauthorized alteration, forgery or falsification of the content or appearance of this document is unlawful and offenders may be prosecuted to the fullest extent of the law.

2.5.3 Measurement Data

Below 1GHz

Model no.	HSC-I001R	Test Mode	Mode 8
Environmental Conditions	25°C, 56% RH	Tested Date	2021/05/20
Antenna Pole	Vertical	Antenna Distance	10m
Detector Function	Quasi-peak.	Tested By	Rex Kuo
6dB Bandwidth	120 kHz	Identifier number	TCOP RE site 17
Standard	FCC Part 15 Subpart B		

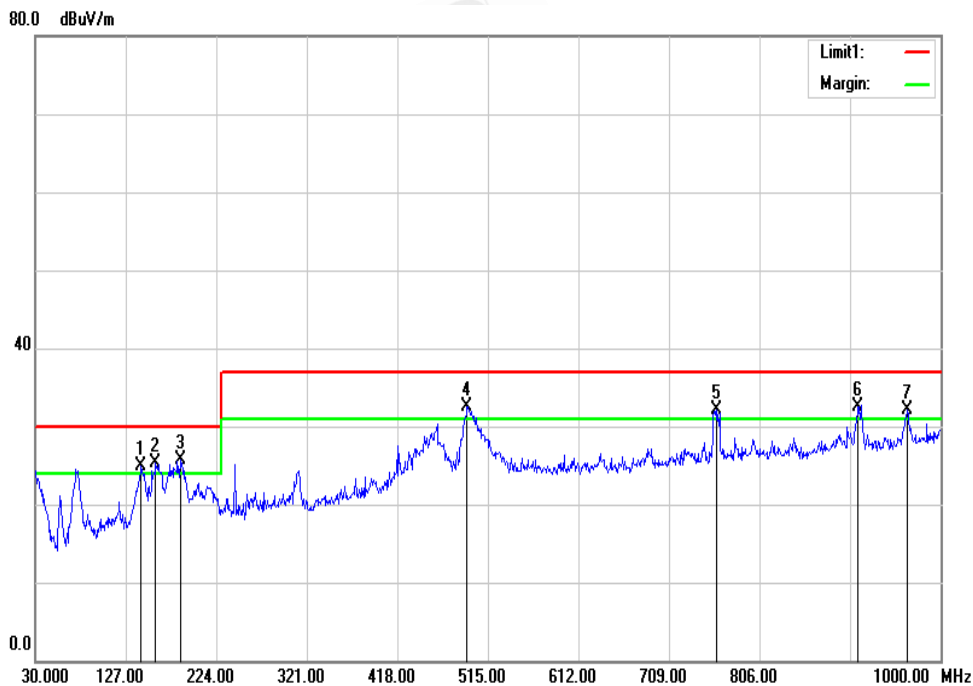

No.	Frequency (MHz)	Reading (dBuV)	Correction Factor (dB/m)	Result (dBuV/m)	Limit (dBuV/m)	Margin (dB)	Height (cm)	Degree (°)	Remark
1	143.4900	33.48	-8.57	24.91	30.00	-5.09	199	223	QP
2	159.0100	34.47	-9.13	25.34	30.00	-4.66	100	360	QP
3	185.2000	35.62	-9.92	25.70	30.00	-4.30	100	335	QP
4	492.6900	33.12	-0.52	32.60	37.00	-4.40	299	1	QP
5	760.4100	28.92	3.15	32.07	37.00	-4.93	199	359	QP
6	911.7300	27.43	5.14	32.57	37.00	-4.43	299	0	QP
7	964.1100	26.11	5.94	32.05	37.00	-4.95	129	360	QP

REMARKS: The other emission levels were very low against the limit.

Unless otherwise stated the results shown in this test report refer only to the sample(s) tested and such sample(s) are retained for 90 days only.
除非另有說明，此報告結果僅對測試之樣品負責，同時此樣品僅保留90天。本報告未經本公司書面許可，不可部份複製。

This document is issued by the Company subject to its General Conditions of Service printed overleaf, available on request or accessible at www.sgs.com/terms_and_conditions.htm and for electronic format documents, subject to Terms and Conditions for Electronic Documents at www.sgs.com/terms_e-document.htm. Attention is drawn to the limitation of liability, indemnification and jurisdiction issues defined therein. Any holder of this document is advised that information contained hereon reflects the Company's findings at the time of its intervention only and within the limits of Client's instructions, if any. The Company's sole responsibility is to its Client and this document does not exonerate parties to a transaction from exercising all their rights and obligations under the transaction documents. This document cannot be reproduced except in full, without prior written approval of the Company. Any unauthorized alteration, forgery or falsification of the content or appearance of this document is unlawful and offenders may be prosecuted to the fullest extent of the law.

Model no.	HSC-I001R	Test Mode	Mode 8
Environmental Conditions	25°C, 56% RH	Tested Date	2021/05/20
Antenna Pole	Horizontal	Antenna Distance	10m
Detector Function	Quasi-peak.	Tested By	Rex Kuo
6dB Bandwidth	120 kHz	Identifier number	TCOP RE site 17
Standard	FCC Part 15 Subpart B		

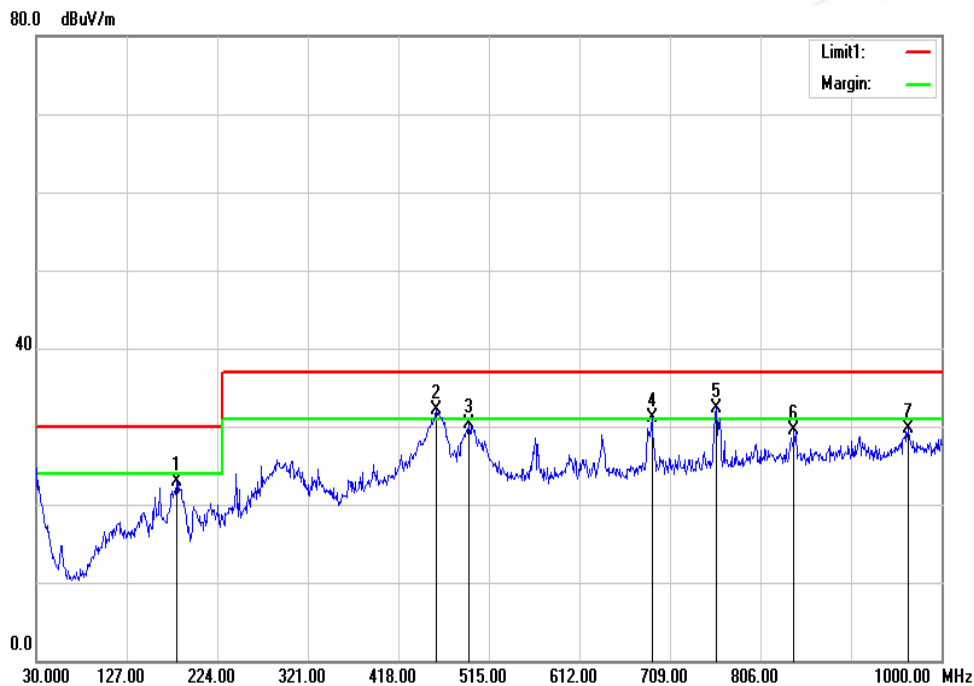

No.	Frequency (MHz)	Reading (dBuV)	Correction Factor (dB/m)	Result (dBuV/m)	Limit (dBuV/m)	Margin (dB)	Height (cm)	Degree (°)	Remark
1	180.3500	34.31	-11.44	22.87	30.00	-7.13	396	360	QP
2	458.7400	34.87	-2.81	32.06	37.00	-4.94	207	0	QP
3	493.6600	33.06	-2.69	30.37	37.00	-6.63	128	360	QP
4	689.6000	31.20	-0.07	31.13	37.00	-5.87	100	359	QP
5	758.4700	31.20	1.10	32.30	37.00	-4.70	100	58	QP
6	841.8900	27.58	1.90	29.48	37.00	-7.52	100	0	QP
7	964.1100	26.16	3.61	29.77	37.00	-7.23	400	10	QP

REMARKS: The other emission levels were very low against the limit.

Unless otherwise stated the results shown in this test report refer only to the sample(s) tested and such sample(s) are retained for 90 days only.
除非另有說明，此報告結果僅對測試之樣品負責，同時此樣品僅保留90天。本報告未經本公司書面許可，不可部份複製。

This document is issued by the Company subject to its General Conditions of Service printed overleaf, available on request or accessible at www.sgs.com/terms_and_conditions.htm and for electronic format documents, subject to Terms and Conditions for Electronic Documents at www.sgs.com/terms_e-document.htm. Attention is drawn to the limitation of liability, indemnification and jurisdiction issues defined therein. Any holder of this document is advised that information contained hereon reflects the Company's findings at the time of its intervention only and within the limits of Client's instructions, if any. The Company's sole responsibility is to its Client and this document does not exonerate parties to a transaction from exercising all their rights and obligations under the transaction documents. This document cannot be reproduced except in full, without prior written approval of the Company. Any unauthorized alteration, forgery or falsification of the content or appearance of this document is unlawful and offenders may be prosecuted to the fullest extent of the law.

Model no.	HSC-I001R	Test Mode	Mode 11
Environmental Conditions	25°C, 56% RH	Tested Date	2021/05/20
Antenna Pole	Vertical	Antenna Distance	10m
Detector Function	Quasi-peak.	Tested By	Rex Kuo
6dB Bandwidth	120 kHz	Identifier number	TCOP RE site 17
Standard	FCC Part 15 Subpart B		

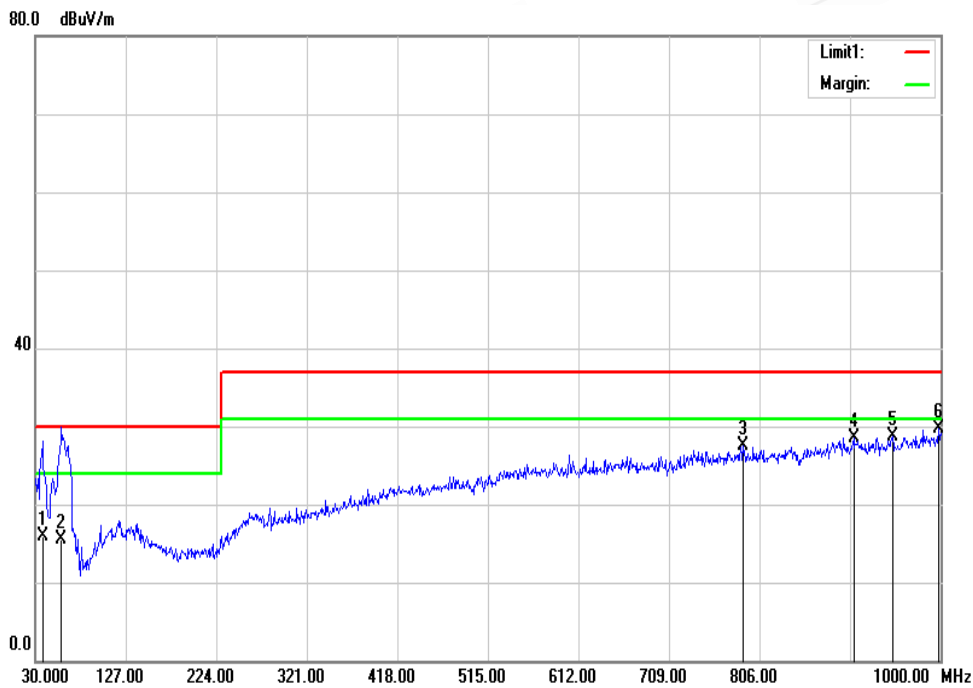

No.	Frequency (MHz)	Reading (dBuV)	Correction Factor (dB/m)	Result (dBuV/m)	Limit (dBuV/m)	Margin (dB)	Height (cm)	Degree (°)	Remark
1	37.7600	22.46	-6.46	16.00	30.00	-14.00	100	0	QP
2	58.1300	29.58	-14.07	15.51	30.00	-14.49	199	71	QP
3	788.5400	23.94	3.57	27.51	37.00	-9.49	399	0	QP
4	906.8800	23.48	5.11	28.59	37.00	-8.41	100	358	QP
5	948.5900	23.09	5.62	28.71	37.00	-8.29	100	359	QP
6	998.0600	23.20	6.49	29.69	37.00	-7.31	258	360	QP

REMARKS: The other emission levels were very low against the limit.

Unless otherwise stated the results shown in this test report refer only to the sample(s) tested and such sample(s) are retained for 90 days only.
除非另有說明，此報告結果僅對測試之樣品負責，同時此樣品僅保留90天。本報告未經本公司書面許可，不可部份複製。

This document is issued by the Company subject to its General Conditions of Service printed overleaf, available on request or accessible at www.sgs.com/terms_and_conditions.htm and for electronic format documents, subject to Terms and Conditions for Electronic Documents at www.sgs.com/terms_e-document.htm. Attention is drawn to the limitation of liability, indemnification and jurisdiction issues defined therein. Any holder of this document is advised that information contained hereon reflects the Company's findings at the time of its intervention only and within the limits of Client's instructions, if any. The Company's sole responsibility is to its Client and this document does not exonerate parties to a transaction from exercising all their rights and obligations under the transaction documents. This document cannot be reproduced except in full, without prior written approval of the Company. Any unauthorized alteration, forgery or falsification of the content or appearance of this document is unlawful and offenders may be prosecuted to the fullest extent of the law.

Model no.	HSC-I001R	Test Mode	Mode 11
Environmental Conditions	25°C, 56% RH	Tested Date	2021/05/20
Antenna Pole	Horizontal	Antenna Distance	10m
Detector Function	Quasi-peak.	Tested By	Rex Kuo
6dB Bandwidth	120 kHz	Identifier number	TCOP RE site 17
Standard	FCC Part 15 Subpart B		

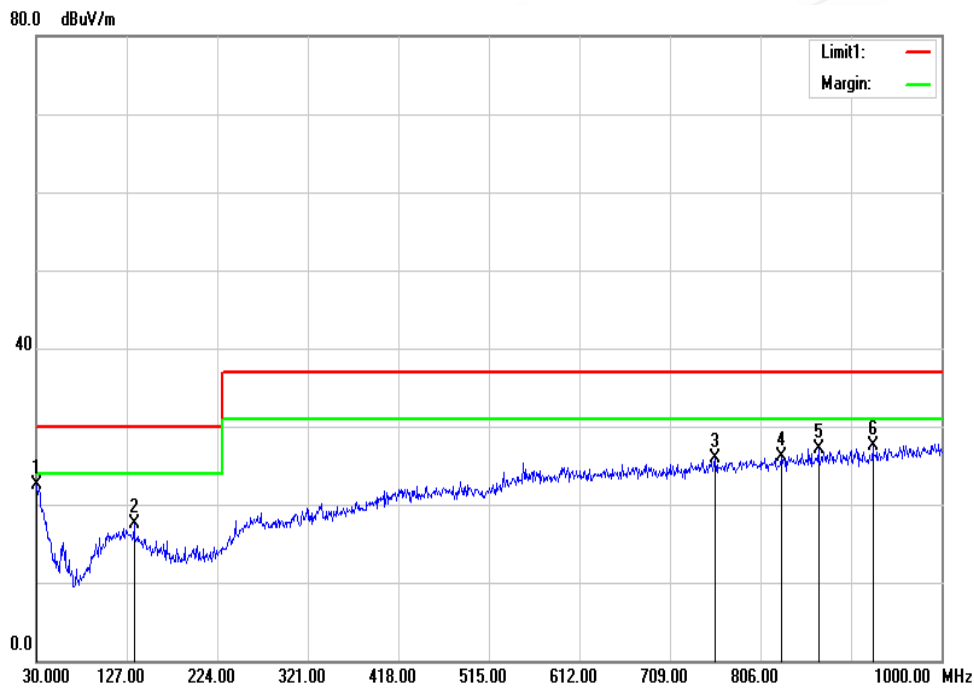

No.	Frequency (MHz)	Reading (dBuV)	Correction Factor (dB/m)	Result (dBuV/m)	Limit (dBuV/m)	Margin (dB)	Height (cm)	Degree (°)	Remark
1	30.0000	25.70	-3.16	22.54	30.00	-7.46	100	84	QP
2	134.7600	26.73	-9.24	17.49	30.00	-12.51	300	78	QP
3	757.5000	24.86	1.08	25.94	37.00	-11.06	299	360	QP
4	828.3100	24.56	1.62	26.18	37.00	-10.82	200	135	QP
5	868.0800	24.83	2.31	27.14	37.00	-9.86	299	360	QP
6	926.2800	24.74	2.84	27.58	37.00	-9.42	199	0	QP

REMARKS: The other emission levels were very low against the limit.

Unless otherwise stated the results shown in this test report refer only to the sample(s) tested and such sample(s) are retained for 90 days only.
除非另有說明，此報告結果僅對測試之樣品負責，同時此樣品僅保留90天。本報告未經本公司書面許可，不可部份複製。

This document is issued by the Company subject to its General Conditions of Service printed overleaf, available on request or accessible at www.sgs.com/terms_and_conditions.htm and for electronic format documents, subject to Terms and Conditions for Electronic Documents at www.sgs.com/terms_e-document.htm. Attention is drawn to the limitation of liability, indemnification and jurisdiction issues defined therein. Any holder of this document is advised that information contained hereon reflects the Company's findings at the time of its intervention only and within the limits of Client's instructions, if any. The Company's sole responsibility is to its Client and this document does not exonerate parties to a transaction from exercising all their rights and obligations under the transaction documents. This document cannot be reproduced except in full, without prior written approval of the Company. Any unauthorized alteration, forgery or falsification of the content or appearance of this document is unlawful and offenders may be prosecuted to the fullest extent of the law.

Model no.	HSC-I001R	Test Mode	Mode 12
Environmental Conditions	25°C, 52% RH	Tested Date	2021/05/22
Antenna Pole	Vertical	Antenna Distance	10m
Detector Function	Quasi-peak.	Tested By	Rex Kuo
6dB Bandwidth	120 kHz	Identifier number	TCOP RE site 17
Standard	FCC Part 15 Subpart B		

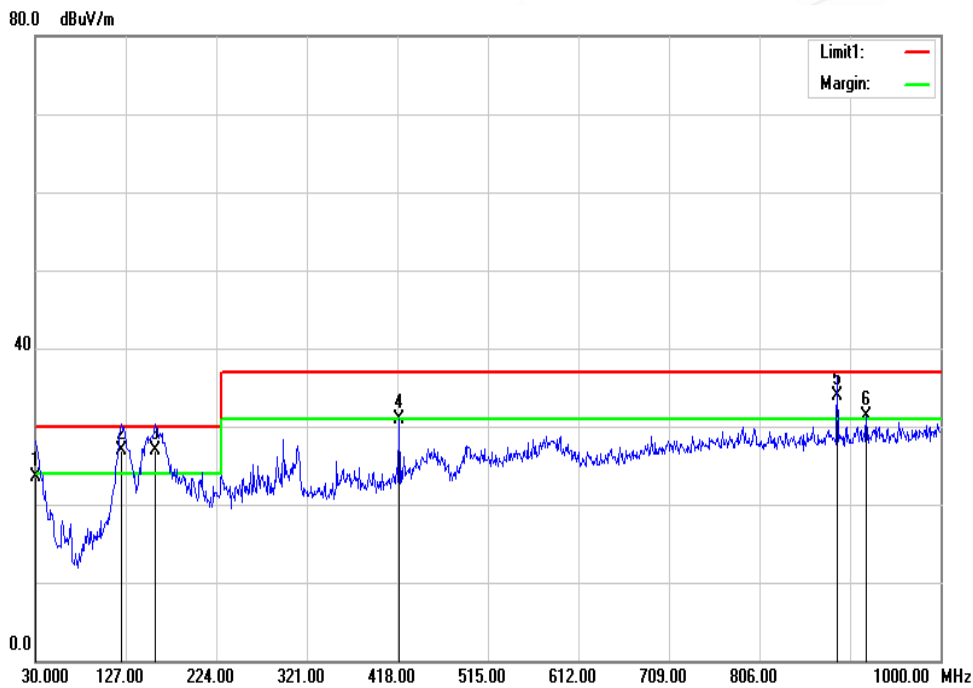

No.	Frequency (MHz)	Reading (dBuV)	Correction Factor (dB/m)	Result (dBuV/m)	Limit (dBuV/m)	Margin (dB)	Height (cm)	Degree (°)	Remark
1	30.0000	25.73	-2.28	23.45	30.00	-6.55	100	271	QP
2	122.1500	34.63	-7.82	26.81	30.00	-3.19	100	220	QP
3	159.0100	36.09	-9.13	26.96	30.00	-3.04	100	148	QP
4	419.9400	31.87	-1.06	30.81	37.00	-6.19	105	0	QP
5	889.4200	28.97	4.94	33.91	37.00	-3.09	199	360	QP
6	920.4600	26.04	5.20	31.24	37.00	-5.76	141	0	QP

REMARKS: The other emission levels were very low against the limit.

Unless otherwise stated the results shown in this test report refer only to the sample(s) tested and such sample(s) are retained for 90 days only.
除非另有說明，此報告結果僅對測試之樣品負責，同時此樣品僅保留90天。本報告未經本公司書面許可，不可部份複製。

This document is issued by the Company subject to its General Conditions of Service printed overleaf, available on request or accessible at www.sgs.com/terms_and_conditions.htm and for electronic format documents, subject to Terms and Conditions for Electronic Documents at www.sgs.com/terms_e-document.htm. Attention is drawn to the limitation of liability, indemnification and jurisdiction issues defined therein. Any holder of this document is advised that information contained hereon reflects the Company's findings at the time of its intervention only and within the limits of Client's instructions, if any. The Company's sole responsibility is to its Client and this document does not exonerate parties to a transaction from exercising all their rights and obligations under the transaction documents. This document cannot be reproduced except in full, without prior written approval of the Company. Any unauthorized alteration, forgery or falsification of the content or appearance of this document is unlawful and offenders may be prosecuted to the fullest extent of the law.

Model no.	HSC-I001R	Test Mode	Mode 12
Environmental Conditions	25°C, 52% RH	Tested Date	2021/05/22
Antenna Pole	Horizontal	Antenna Distance	10m
Detector Function	Quasi-peak.	Tested By	Rex Kuo
6dB Bandwidth	120 kHz	Identifier number	TCOP RE site 17
Standard	FCC Part 15 Subpart B		

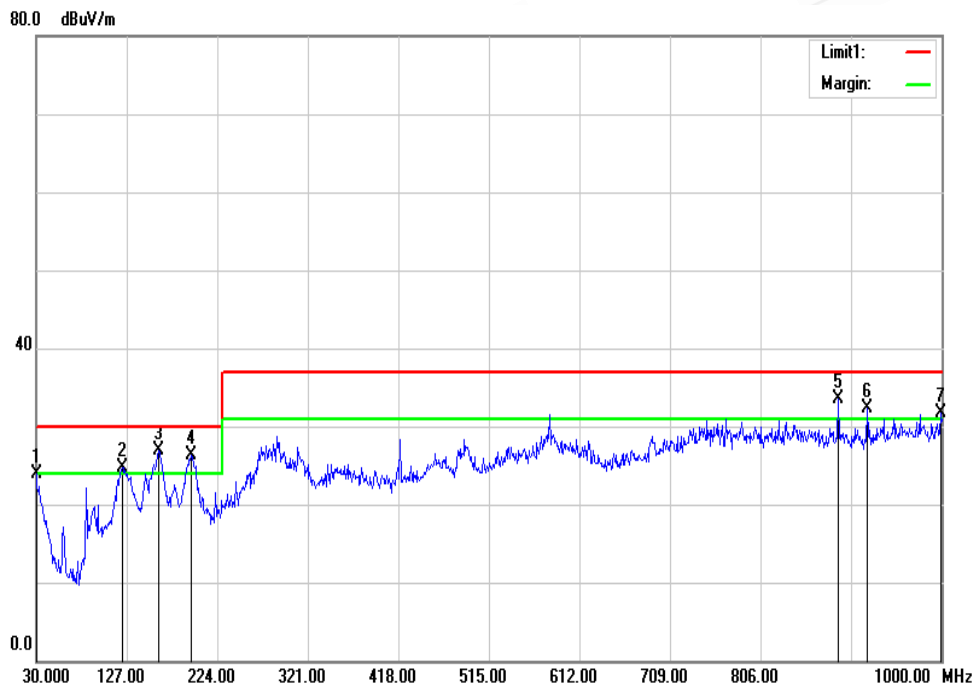

No.	Frequency (MHz)	Reading (dBuV)	Correction Factor (dB/m)	Result (dBuV/m)	Limit (dBuV/m)	Margin (dB)	Height (cm)	Degree (°)	Remark
1	30.0000	27.04	-3.16	23.88	30.00	-6.12	298	360	QP
2	122.1500	33.63	-8.93	24.70	30.00	-5.30	400	32	QP
3	160.9500	37.44	-10.59	26.85	30.00	-3.15	400	45	QP
4	195.8700	37.42	-11.05	26.37	30.00	-3.63	399	0	QP
5	889.4200	30.89	2.56	33.45	37.00	-3.55	300	59	QP
6	920.4600	29.49	2.74	32.23	37.00	-4.77	100	66	QP
7	999.0300	27.71	3.99	31.70	37.00	-5.30	100	304	QP

REMARKS: The other emission levels were very low against the limit.

Unless otherwise stated the results shown in this test report refer only to the sample(s) tested and such sample(s) are retained for 90 days only.

除非另有說明，此報告結果僅對測試之樣品負責，同時此樣品僅保留90天。本報告未經本公司書面許可，不可部份複製。

This document is issued by the Company subject to its General Conditions of Service printed overleaf, available on request or accessible at www.sgs.com/terms_and_conditions.htm and for electronic format documents, subject to Terms and Conditions for Electronic Documents at www.sgs.com/terms_e-document.htm. Attention is drawn to the limitation of liability, indemnification and jurisdiction issues defined therein. Any holder of this document is advised that information contained hereon reflects the Company's findings at the time of its intervention only and within the limits of Client's instructions, if any. The Company's sole responsibility is to its Client and this document does not exonerate parties to a transaction from exercising all their rights and obligations under the transaction documents. This document cannot be reproduced except in full, without prior written approval of the Company. Any unauthorized alteration, forgery or falsification of the content or appearance of this document is unlawful and offenders may be prosecuted to the fullest extent of the law.

Model no.	HSC-I001R	Test Mode	Mode 13
Environmental Conditions	25°C, 52% RH	Tested Date	2021/05/22
Antenna Pole	Vertical	Antenna Distance	10m
Detector Function	Quasi-peak.	Tested By	Rex Kuo
6dB Bandwidth	120 kHz	Identifier number	TCOP RE site 17
Standard	FCC Part 15 Subpart B		

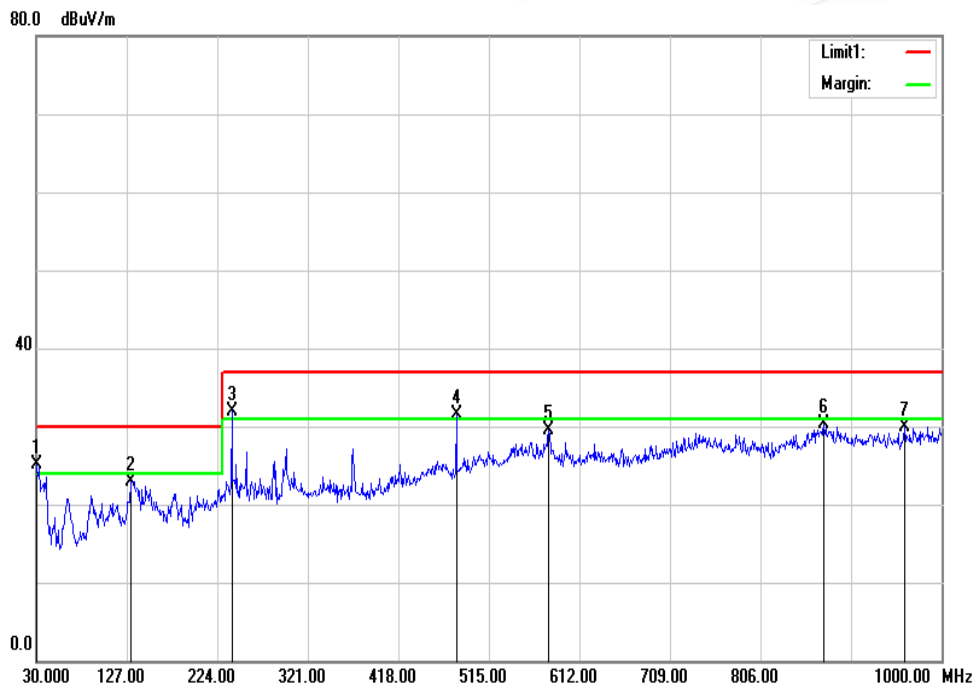

No.	Frequency (MHz)	Reading (dBuV)	Correction Factor (dB/m)	Result (dBuV/m)	Limit (dBuV/m)	Margin (dB)	Height (cm)	Degree (°)	Remark
1	30.0000	27.31	-2.28	25.03	30.00	-4.97	300	314	QP
2	131.8500	30.93	-7.95	22.98	30.00	-7.02	100	282	QP
3	239.5200	38.85	-7.02	31.83	37.00	-5.17	100	357	QP
4	480.0800	32.06	-0.60	31.46	37.00	-5.54	100	191	QP
5	579.0200	28.39	1.11	29.50	37.00	-7.50	300	0	QP
6	873.9000	25.59	4.77	30.36	37.00	-6.64	200	359	QP
7	960.2300	24.08	5.87	29.95	37.00	-7.05	300	0	QP

REMARKS: The other emission levels were very low against the limit.

Unless otherwise stated the results shown in this test report refer only to the sample(s) tested and such sample(s) are retained for 90 days only.
除非另有說明，此報告結果僅對測試之樣品負責，同時此樣品僅保留90天。本報告未經本公司書面許可，不可部份複製。

This document is issued by the Company subject to its General Conditions of Service printed overleaf, available on request or accessible at www.sgs.com/terms_and_conditions.htm and for electronic format documents, subject to Terms and Conditions for Electronic Documents at www.sgs.com/terms_e-document.htm. Attention is drawn to the limitation of liability, indemnification and jurisdiction issues defined therein. Any holder of this document is advised that information contained hereon reflects the Company's findings at the time of its intervention only and within the limits of Client's instructions, if any. The Company's sole responsibility is to its Client and this document does not exonerate parties to a transaction from exercising all their rights and obligations under the transaction documents. This document cannot be reproduced except in full, without prior written approval of the Company. Any unauthorized alteration, forgery or falsification of the content or appearance of this document is unlawful and offenders may be prosecuted to the fullest extent of the law.

Model no.	HSC-I001R	Test Mode	Mode 13
Environmental Conditions	25°C, 52% RH	Tested Date	2021/05/22
Antenna Pole	Horizontal	Antenna Distance	10m
Detector Function	Quasi-peak.	Tested By	Rex Kuo
6dB Bandwidth	120 kHz	Identifier number	TCOP RE site 17
Standard	FCC Part 15 Subpart B		

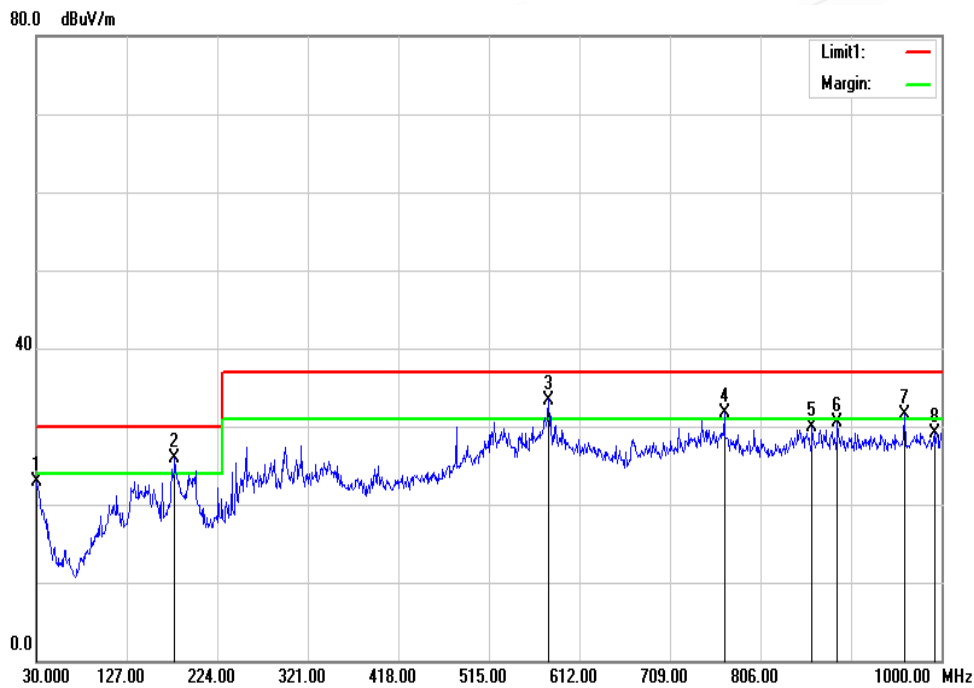

No.	Frequency (MHz)	Reading (dBuV)	Correction Factor (dB/m)	Result (dBuV/m)	Limit (dBuV/m)	Margin (dB)	Height (cm)	Degree (°)	Remark
1	30.0000	26.04	-3.16	22.88	30.00	-7.12	399	0	QP
2	178.4100	37.28	-11.40	25.88	30.00	-4.12	351	360	QP
3	579.0200	34.34	-0.94	33.40	37.00	-3.60	200	237	QP
4	767.2000	30.47	1.21	31.68	37.00	-5.32	100	141	QP
5	861.2900	27.66	2.22	29.88	37.00	-7.12	100	215	QP
6	888.4500	27.85	2.59	30.44	37.00	-6.56	100	352	QP
7	960.2300	28.01	3.56	31.57	37.00	-5.43	100	72	QP
8	992.2400	25.36	3.81	29.17	37.00	-7.83	100	138	QP

REMARKS: The other emission levels were very low against the limit.

Unless otherwise stated the results shown in this test report refer only to the sample(s) tested and such sample(s) are retained for 90 days only.

除非另有說明，此報告結果僅對測試之樣品負責，同時此樣品僅保留90天。本報告未經本公司書面許可，不可部份複製。

This document is issued by the Company subject to its General Conditions of Service printed overleaf, available on request or accessible at www.sgs.com/terms_and_conditions.htm and for electronic format documents, subject to Terms and Conditions for Electronic Documents at www.sgs.com/terms_e-document.htm. Attention is drawn to the limitation of liability, indemnification and jurisdiction issues defined therein. Any holder of this document is advised that information contained hereon reflects the Company's findings at the time of its intervention only and within the limits of Client's instructions, if any. The Company's sole responsibility is to its Client and this document does not exonerate parties to a transaction from exercising all their rights and obligations under the transaction documents. This document cannot be reproduced except in full, without prior written approval of the Company. Any unauthorized alteration, forgery or falsification of the content or appearance of this document is unlawful and offenders may be prosecuted to the fullest extent of the law.

Model no.	HSC-I001R	Test Mode	Mode 8
Environmental Conditions	25°C, 56% RH	Tested Date	2021/05/20
Antenna Pole	Vertical	Antenna Distance	10m
Detector Function	Quasi-peak.	Tested By	Rex Kuo
6dB Bandwidth	120 kHz	Identifier number	TCOP RE site 17
Standard	ISED ICES-003 Issue 7		

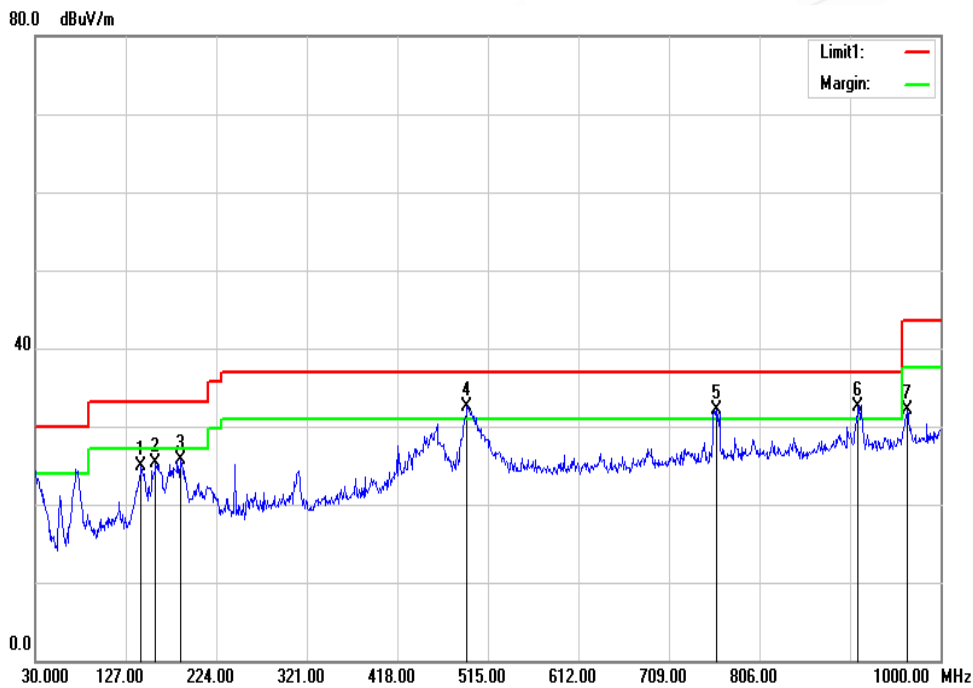

No.	Frequency (MHz)	Reading (dBuV)	Correction Factor (dB/m)	Result (dBuV/m)	Limit (dBuV/m)	Margin (dB)	Height (cm)	Degree (°)	Remark
1	143.4900	33.48	-8.57	24.91	33.10	-8.19	199	223	QP
2	159.0100	34.47	-9.13	25.34	33.10	-7.76	100	360	QP
3	185.2000	35.62	-9.92	25.70	33.10	-7.40	100	335	QP
4	492.6900	33.12	-0.52	32.60	37.00	-4.40	299	1	QP
5	760.4100	28.92	3.15	32.07	37.00	-4.93	199	359	QP
6	911.7300	27.43	5.14	32.57	37.00	-4.43	299	0	QP
7	964.1100	26.11	5.94	32.05	43.50	-11.45	129	360	QP

REMARKS: The other emission levels were very low against the limit.

Unless otherwise stated the results shown in this test report refer only to the sample(s) tested and such sample(s) are retained for 90 days only.

除非另有說明，此報告結果僅對測試之樣品負責，同時此樣品僅保留90天。本報告未經本公司書面許可，不可部份複製。

This document is issued by the Company subject to its General Conditions of Service printed overleaf, available on request or accessible at www.sgs.com/terms_and_conditions.htm and for electronic format documents, subject to Terms and Conditions for Electronic Documents at www.sgs.com/terms_e-document.htm. Attention is drawn to the limitation of liability, indemnification and jurisdiction issues defined therein. Any holder of this document is advised that information contained herein reflects the Company's findings at the time of its intervention only and within the limits of Client's instructions, if any. The Company's sole responsibility is to its Client and this document does not exonerate parties to a transaction from exercising all their rights and obligations under the transaction documents. This document cannot be reproduced except in full, without prior written approval of the Company. Any unauthorized alteration, forgery or falsification of the content or appearance of this document is unlawful and offenders may be prosecuted to the fullest extent of the law.

Model no.	HSC-I001R	Test Mode	Mode 8
Environmental Conditions	25°C, 56% RH	Tested Date	2021/05/20
Antenna Pole	Horizontal	Antenna Distance	10m
Detector Function	Quasi-peak.	Tested By	Rex Kuo
6dB Bandwidth	120 kHz	Identifier number	TCOP RE site 17
Standard	ISED ICES-003 Issue 7		

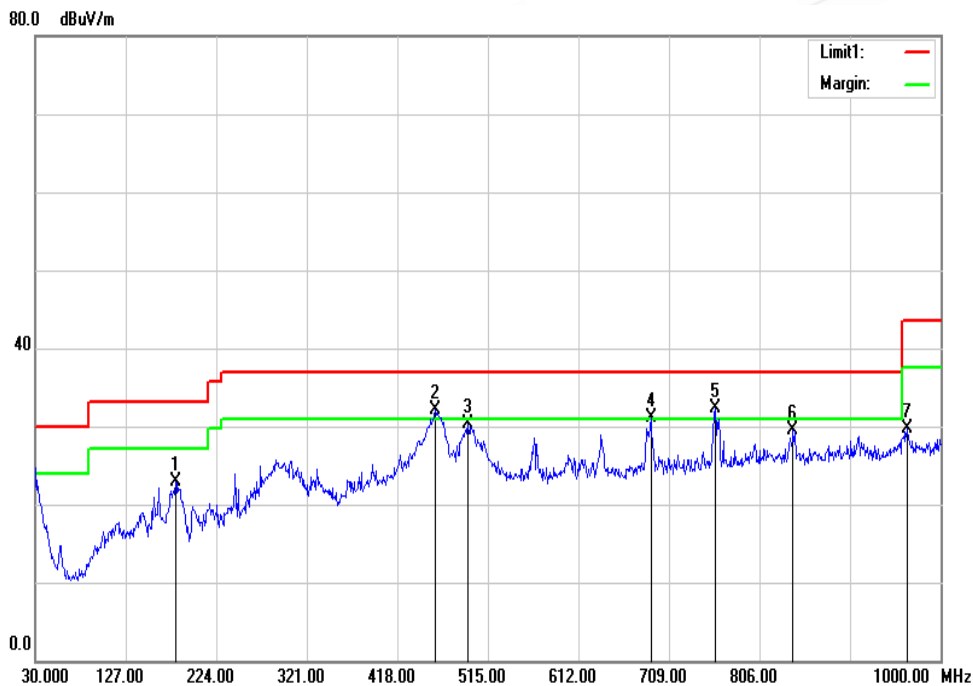

No.	Frequency (MHz)	Reading (dBuV)	Correction Factor (dB/m)	Result (dBuV/m)	Limit (dBuV/m)	Margin (dB)	Height (cm)	Degree (°)	Remark
1	180.3500	34.31	-11.44	22.87	33.10	-10.23	396	360	QP
2	458.7400	34.87	-2.81	32.06	37.00	-4.94	207	0	QP
3	493.6600	33.06	-2.69	30.37	37.00	-6.63	128	360	QP
4	689.6000	31.20	-0.07	31.13	37.00	-5.87	100	359	QP
5	758.4700	31.20	1.10	32.30	37.00	-4.70	100	58	QP
6	841.8900	27.58	1.90	29.48	37.00	-7.52	100	0	QP
7	964.1100	26.16	3.61	29.77	43.50	-13.73	400	10	QP

REMARKS: The other emission levels were very low against the limit.

Unless otherwise stated the results shown in this test report refer only to the sample(s) tested and such sample(s) are retained for 90 days only.
除非另有說明，此報告結果僅對測試之樣品負責，同時此樣品僅保留90天。本報告未經本公司書面許可，不可部份複製。

This document is issued by the Company subject to its General Conditions of Service printed overleaf, available on request or accessible at www.sgs.com/terms_and_conditions.htm and for electronic format documents, subject to Terms and Conditions for Electronic Documents at www.sgs.com/terms_e-document.htm. Attention is drawn to the limitation of liability, indemnification and jurisdiction issues defined therein. Any holder of this document is advised that information contained hereon reflects the Company's findings at the time of its intervention only and within the limits of Client's instructions, if any. The Company's sole responsibility is to its Client and this document does not exonerate parties to a transaction from exercising all their rights and obligations under the transaction documents. This document cannot be reproduced except in full, without prior written approval of the Company. Any unauthorized alteration, forgery or falsification of the content or appearance of this document is unlawful and offenders may be prosecuted to the fullest extent of the law.

Model no.	HSC-I001R	Test Mode	Mode 11
Environmental Conditions	25°C, 56% RH	Tested Date	2021/05/20
Antenna Pole	Vertical	Antenna Distance	10m
Detector Function	Quasi-peak.	Tested By	Rex Kuo
6dB Bandwidth	120 kHz	Identifier number	TCOP RE site 17
Standard	ISED ICES-003 Issue 7		

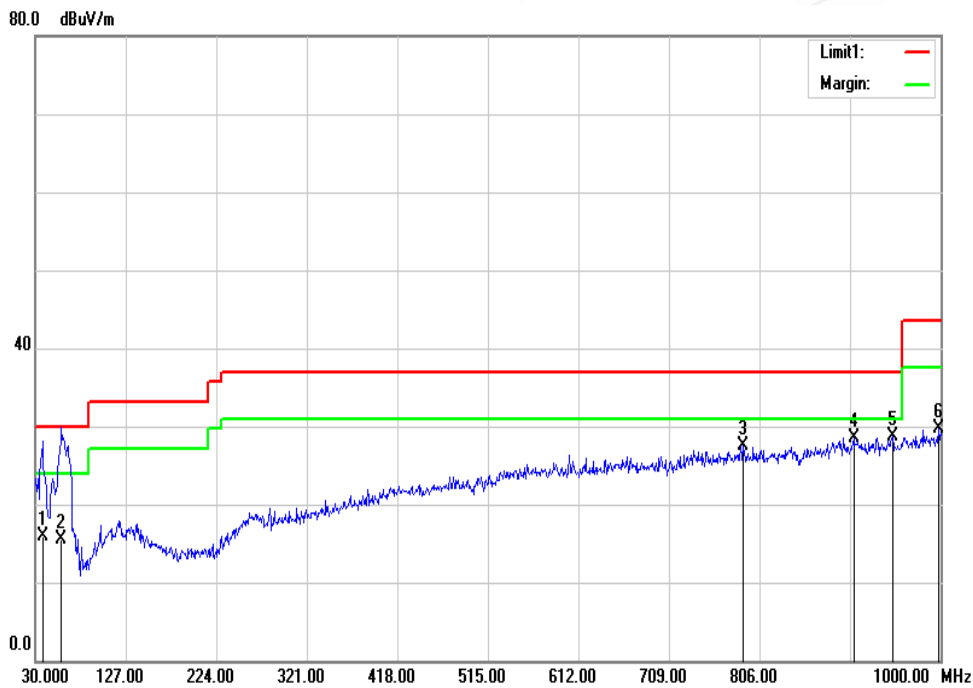

No.	Frequency (MHz)	Reading (dBuV)	Correction Factor (dB/m)	Result (dBuV/m)	Limit (dBuV/m)	Margin (dB)	Height (cm)	Degree (°)	Remark
1	37.7600	22.46	-6.46	16.00	30.00	-14.00	100	0	QP
2	58.1300	29.58	-14.07	15.51	30.00	-14.49	199	71	QP
3	788.5400	23.94	3.57	27.51	37.00	-9.49	399	0	QP
4	906.8800	23.48	5.11	28.59	37.00	-8.41	100	358	QP
5	948.5900	23.09	5.62	28.71	37.00	-8.29	100	359	QP
6	998.0600	23.20	6.49	29.69	43.50	-13.81	258	360	QP

REMARKS: The other emission levels were very low against the limit.

Unless otherwise stated the results shown in this test report refer only to the sample(s) tested and such sample(s) are retained for 90 days only.
除非另有說明，此報告結果僅對測試之樣品負責，同時此樣品僅保留90天。本報告未經本公司書面許可，不可部份複製。

This document is issued by the Company subject to its General Conditions of Service printed overleaf, available on request or accessible at www.sgs.com/terms_and_conditions.htm and for electronic format documents, subject to Terms and Conditions for Electronic Documents at www.sgs.com/terms_e-document.htm. Attention is drawn to the limitation of liability, indemnification and jurisdiction issues defined therein. Any holder of this document is advised that information contained hereon reflects the Company's findings at the time of its intervention only and within the limits of Client's instructions, if any. The Company's sole responsibility is to its Client and this document does not exonerate parties to a transaction from exercising all their rights and obligations under the transaction documents. This document cannot be reproduced except in full, without prior written approval of the Company. Any unauthorized alteration, forgery or falsification of the content or appearance of this document is unlawful and offenders may be prosecuted to the fullest extent of the law.

Model no.	HSC-I001R	Test Mode	Mode 11
Environmental Conditions	25°C, 56% RH	Tested Date	2021/05/20
Antenna Pole	Horizontal	Antenna Distance	10m
Detector Function	Quasi-peak.	Tested By	Rex Kuo
6dB Bandwidth	120 kHz	Identifier number	TCOP RE site 17
Standard	ISED ICES-003 Issue 7		

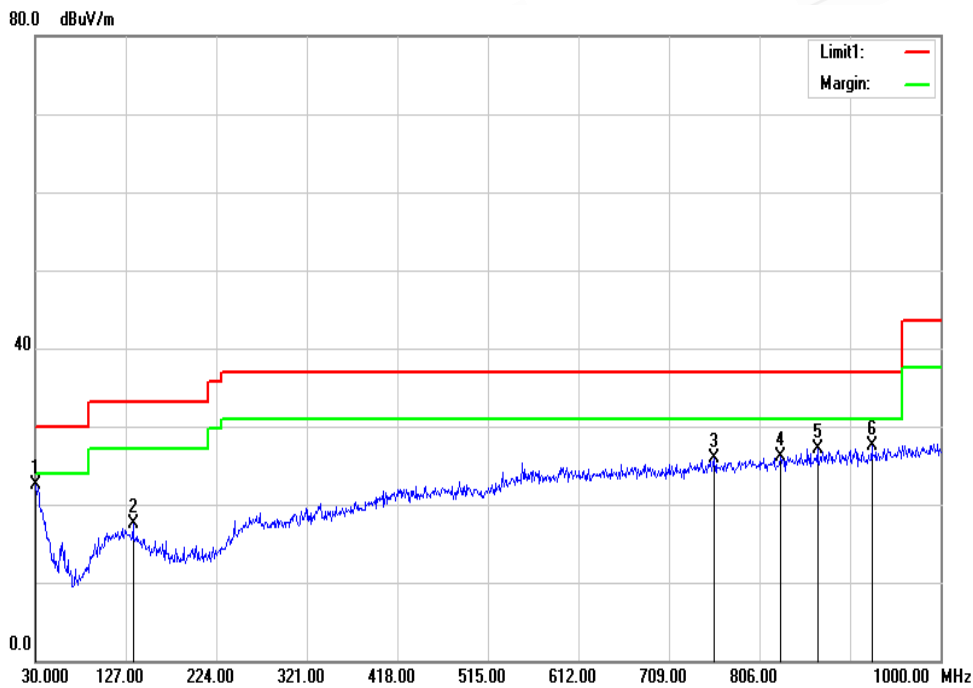

No.	Frequency (MHz)	Reading (dBuV)	Correction Factor (dB/m)	Result (dBuV/m)	Limit (dBuV/m)	Margin (dB)	Height (cm)	Degree (°)	Remark
1	30.0000	25.70	-3.16	22.54	30.00	-7.46	100	84	QP
2	134.7600	26.73	-9.24	17.49	33.10	-15.61	300	78	QP
3	757.5000	24.86	1.08	25.94	37.00	-11.06	299	360	QP
4	828.3100	24.56	1.62	26.18	37.00	-10.82	200	135	QP
5	868.0800	24.83	2.31	27.14	37.00	-9.86	299	360	QP
6	926.2800	24.74	2.84	27.58	37.00	-9.42	199	0	QP

REMARKS: The other emission levels were very low against the limit.

Unless otherwise stated the results shown in this test report refer only to the sample(s) tested and such sample(s) are retained for 90 days only.
除非另有說明，此報告結果僅對測試之樣品負責，同時此樣品僅保留90天。本報告未經本公司書面許可，不可部份複製。

This document is issued by the Company subject to its General Conditions of Service printed overleaf, available on request or accessible at www.sgs.com/terms_and_conditions.htm and for electronic format documents, subject to Terms and Conditions for Electronic Documents at www.sgs.com/terms_e-document.htm. Attention is drawn to the limitation of liability, indemnification and jurisdiction issues defined therein. Any holder of this document is advised that information contained hereon reflects the Company's findings at the time of its intervention only and within the limits of Client's instructions, if any. The Company's sole responsibility is to its Client and this document does not exonerate parties to a transaction from exercising all their rights and obligations under the transaction documents. This document cannot be reproduced except in full, without prior written approval of the Company. Any unauthorized alteration, forgery or falsification of the content or appearance of this document is unlawful and offenders may be prosecuted to the fullest extent of the law.

Model no.	HSC-I001R	Test Mode	Mode 12
Environmental Conditions	25°C, 52% RH	Tested Date	2021/05/22
Antenna Pole	Vertical	Antenna Distance	10m
Detector Function	Quasi-peak.	Tested By	Rex Kuo
6dB Bandwidth	120 kHz	Identifier number	TCOP RE site 17
Standard	ISED ICES-003 Issue 7		

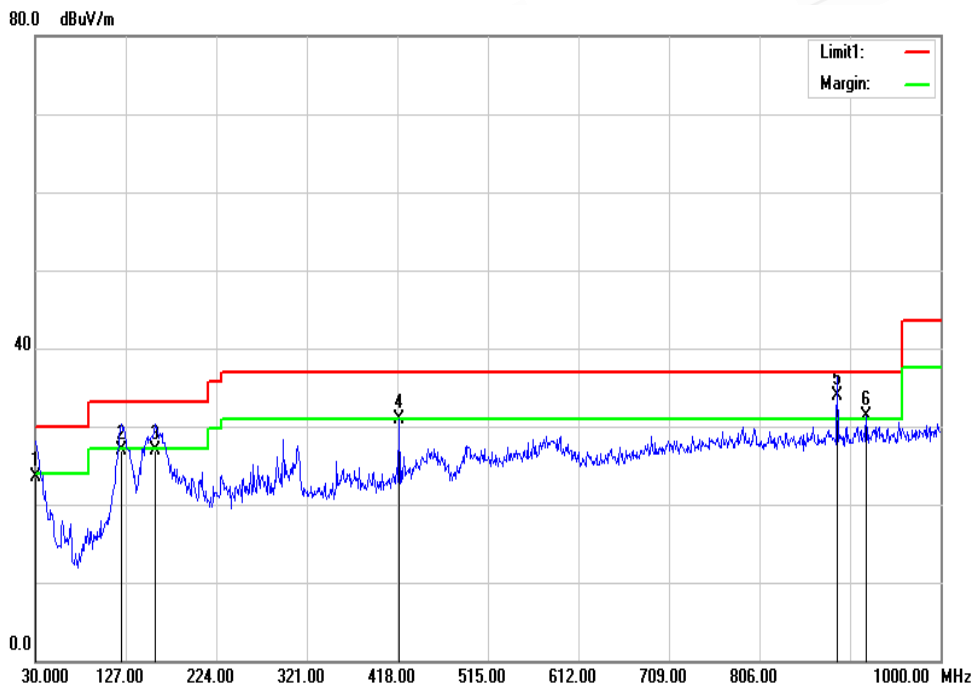

No.	Frequency (MHz)	Reading (dBuV)	Correction Factor (dB/m)	Result (dBuV/m)	Limit (dBuV/m)	Margin (dB)	Height (cm)	Degree (°)	Remark
1	30.0000	25.73	-2.28	23.45	30.00	-6.55	100	271	QP
2	122.1500	34.63	-7.82	26.81	33.10	-6.29	100	220	QP
3	159.0100	36.09	-9.13	26.96	33.10	-6.14	100	148	QP
4	419.9400	31.87	-1.06	30.81	37.00	-6.19	105	0	QP
5	889.4200	28.97	4.94	33.91	37.00	-3.09	199	360	QP
6	920.4600	26.04	5.20	31.24	37.00	-5.76	141	0	QP

REMARKS: The other emission levels were very low against the limit.

Unless otherwise stated the results shown in this test report refer only to the sample(s) tested and such sample(s) are retained for 90 days only.
除非另有說明，此報告結果僅對測試之樣品負責，同時此樣品僅保留90天。本報告未經本公司書面許可，不可部份複製。

This document is issued by the Company subject to its General Conditions of Service printed overleaf, available on request or accessible at www.sgs.com/terms_and_conditions.htm and for electronic format documents, subject to Terms and Conditions for Electronic Documents at www.sgs.com/terms_e-document.htm. Attention is drawn to the limitation of liability, indemnification and jurisdiction issues defined therein. Any holder of this document is advised that information contained hereon reflects the Company's findings at the time of its intervention only and within the limits of Client's instructions, if any. The Company's sole responsibility is to its Client and this document does not exonerate parties to a transaction from exercising all their rights and obligations under the transaction documents. This document cannot be reproduced except in full, without prior written approval of the Company. Any unauthorized alteration, forgery or falsification of the content or appearance of this document is unlawful and offenders may be prosecuted to the fullest extent of the law.

Model no.	HSC-I001R	Test Mode	Mode 12
Environmental Conditions	25°C, 52% RH	Tested Date	2021/05/22
Antenna Pole	Horizontal	Antenna Distance	10m
Detector Function	Quasi-peak.	Tested By	Rex Kuo
6dB Bandwidth	120 kHz	Identifier number	TCOP RE site 17
Standard	ISED ICES-003 Issue 7		

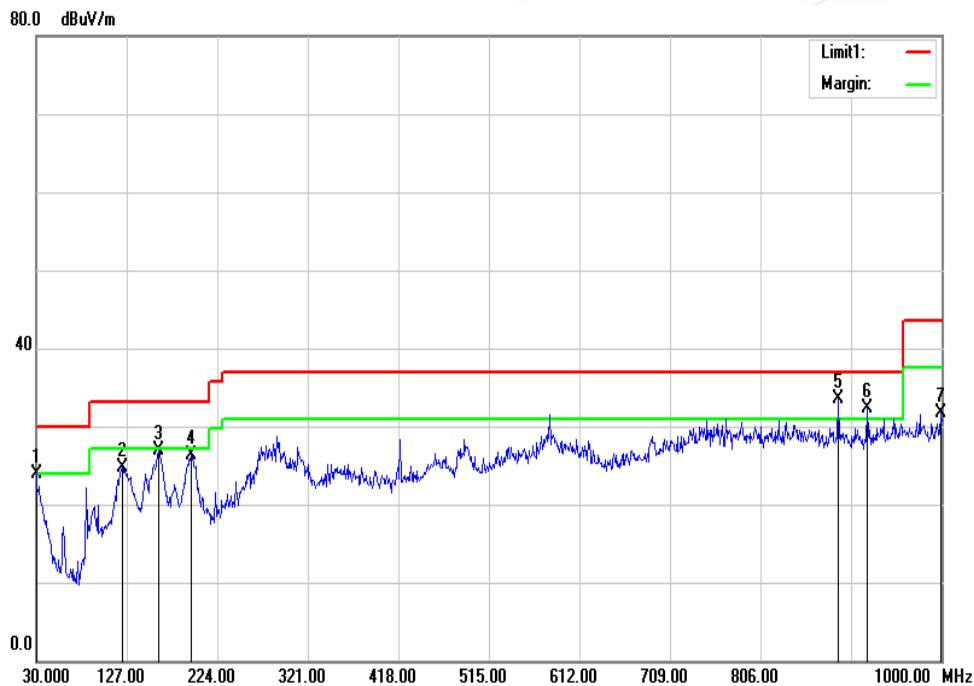

No.	Frequency (MHz)	Reading (dBuV)	Correction Factor (dB/m)	Result (dBuV/m)	Limit (dBuV/m)	Margin (dB)	Height (cm)	Degree (°)	Remark
1	30.0000	27.04	-3.16	23.88	30.00	-6.12	298	360	QP
2	122.1500	33.63	-8.93	24.70	33.10	-8.40	400	32	QP
3	160.9500	37.44	-10.59	26.85	33.10	-6.25	400	45	QP
4	195.8700	37.42	-11.05	26.37	33.10	-6.73	399	0	QP
5	889.4200	30.89	2.56	33.45	37.00	-3.55	300	59	QP
6	920.4600	29.49	2.74	32.23	37.00	-4.77	100	66	QP
7	999.0300	27.71	3.99	31.70	43.50	-11.80	100	304	QP

REMARKS: The other emission levels were very low against the limit.

Unless otherwise stated the results shown in this test report refer only to the sample(s) tested and such sample(s) are retained for 90 days only.
除非另有說明，此報告結果僅對測試之樣品負責，同時此樣品僅保留90天。本報告未經本公司書面許可，不可部份複製。

This document is issued by the Company subject to its General Conditions of Service printed overleaf, available on request or accessible at www.sgs.com/terms_and_conditions.htm and for electronic format documents, subject to Terms and Conditions for Electronic Documents at www.sgs.com/terms_e-document.htm. Attention is drawn to the limitation of liability, indemnification and jurisdiction issues defined therein. Any holder of this document is advised that information contained hereon reflects the Company's findings at the time of its intervention only and within the limits of Client's instructions, if any. The Company's sole responsibility is to its Client and this document does not exonerate parties to a transaction from exercising all their rights and obligations under the transaction documents. This document cannot be reproduced except in full, without prior written approval of the Company. Any unauthorized alteration, forgery or falsification of the content or appearance of this document is unlawful and offenders may be prosecuted to the fullest extent of the law.

Model no.	HSC-I001R	Test Mode	Mode 13
Environmental Conditions	25°C, 52% RH	Tested Date	2021/05/22
Antenna Pole	Vertical	Antenna Distance	10m
Detector Function	Quasi-peak.	Tested By	Rex Kuo
6dB Bandwidth	120 kHz	Identifier number	TCOP RE site 17
Standard	ISED ICES-003 Issue 7		

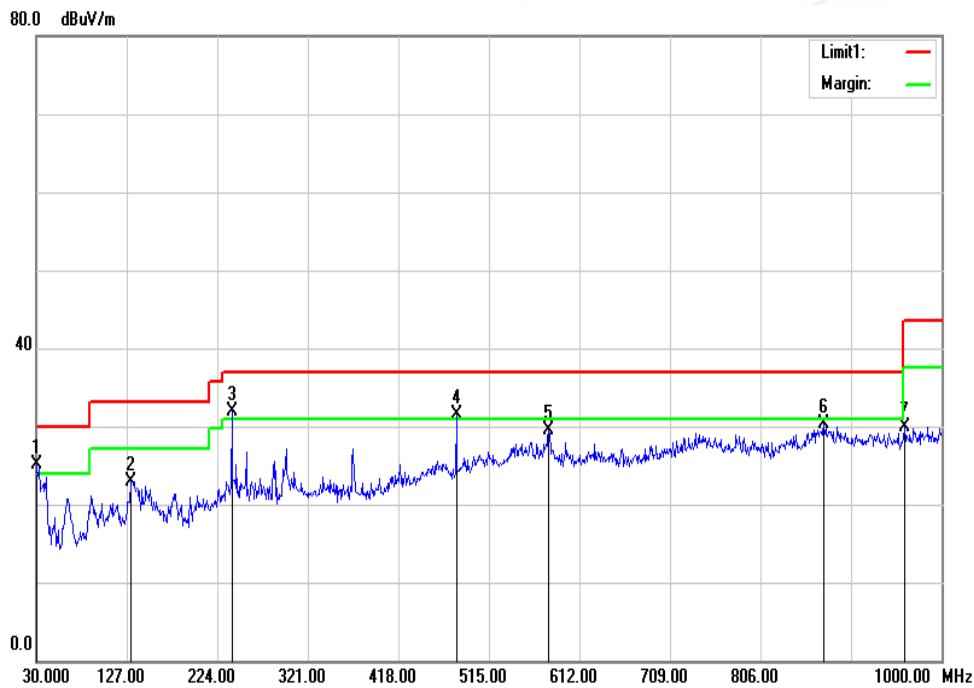

No.	Frequency (MHz)	Reading (dBuV)	Correction Factor (dB/m)	Result (dBuV/m)	Limit (dBuV/m)	Margin (dB)	Height (cm)	Degree (°)	Remark
1	30.0000	27.31	-2.28	25.03	30.00	-4.97	300	314	QP
2	131.8500	30.93	-7.95	22.98	33.10	-10.12	100	282	QP
3	239.5200	38.85	-7.02	31.83	37.00	-5.17	100	357	QP
4	480.0800	32.06	-0.60	31.46	37.00	-5.54	100	191	QP
5	579.0200	28.39	1.11	29.50	37.00	-7.50	300	0	QP
6	873.9000	25.59	4.77	30.36	37.00	-6.64	200	359	QP
7	960.2300	24.08	5.87	29.95	43.50	-13.55	300	0	QP

REMARKS: The other emission levels were very low against the limit.

Unless otherwise stated the results shown in this test report refer only to the sample(s) tested and such sample(s) are retained for 90 days only.
除非另有說明，此報告結果僅對測試之樣品負責，同時此樣品僅保留90天。本報告未經本公司書面許可，不可部份複製。

This document is issued by the Company subject to its General Conditions of Service printed overleaf, available on request or accessible at www.sgs.com/terms_and_conditions.htm and for electronic format documents, subject to Terms and Conditions for Electronic Documents at www.sgs.com/terms_e-document.htm. Attention is drawn to the limitation of liability, indemnification and jurisdiction issues defined therein. Any holder of this document is advised that information contained hereon reflects the Company's findings at the time of its intervention only and within the limits of Client's instructions, if any. The Company's sole responsibility is to its Client and this document does not exonerate parties to a transaction from exercising all their rights and obligations under the transaction documents. This document cannot be reproduced except in full, without prior written approval of the Company. Any unauthorized alteration, forgery or falsification of the content or appearance of this document is unlawful and offenders may be prosecuted to the fullest extent of the law.

Model no.	HSC-I001R	Test Mode	Mode 13
Environmental Conditions	25°C, 52% RH	Tested Date	2021/05/22
Antenna Pole	Horizontal	Antenna Distance	10m
Detector Function	Quasi-peak.	Tested By	Rex Kuo
6dB Bandwidth	120 kHz	Identifier number	TCOP RE site 17
Standard	ISED ICES-003 Issue 7		

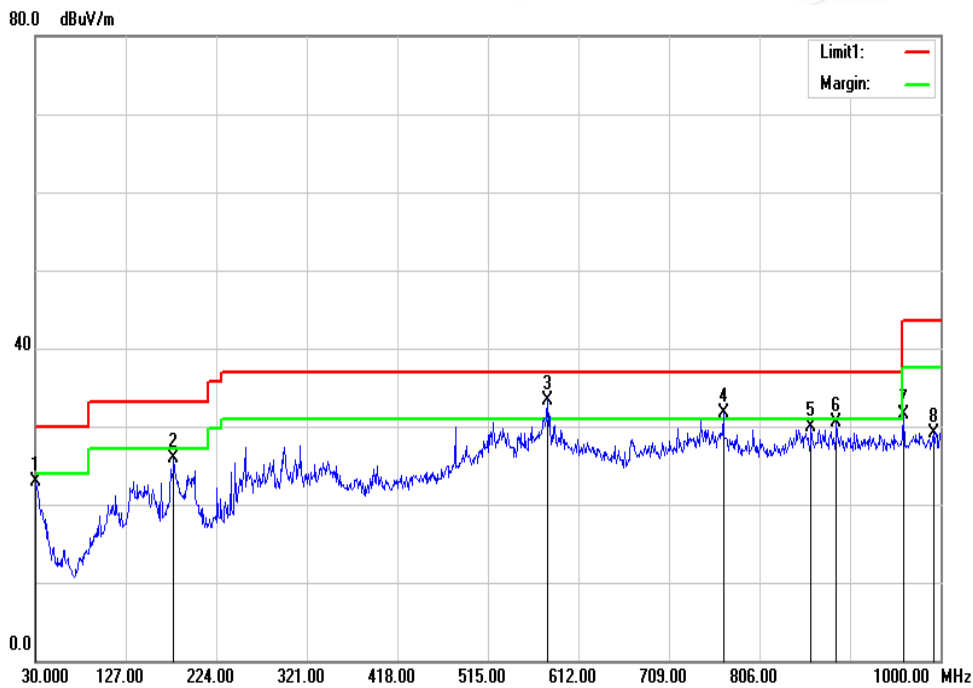

No.	Frequency (MHz)	Reading (dBuV)	Correction Factor (dB/m)	Result (dBuV/m)	Limit (dBuV/m)	Margin (dB)	Height (cm)	Degree (°)	Remark
1	30.0000	26.04	-3.16	22.88	30.00	-7.12	399	0	QP
2	178.4100	37.28	-11.40	25.88	33.10	-7.22	351	360	QP
3	579.0200	34.34	-0.94	33.40	37.00	-3.60	200	237	QP
4	767.2000	30.47	1.21	31.68	37.00	-5.32	100	141	QP
5	861.2900	27.66	2.22	29.88	37.00	-7.12	100	215	QP
6	888.4500	27.85	2.59	30.44	37.00	-6.56	100	352	QP
7	960.2300	28.01	3.56	31.57	43.50	-11.93	100	72	QP
8	992.2400	25.36	3.81	29.17	43.50	-14.33	100	138	QP

REMARKS: The other emission levels were very low against the limit.

Unless otherwise stated the results shown in this test report refer only to the sample(s) tested and such sample(s) are retained for 90 days only.

除非另有說明，此報告結果僅對測試之樣品負責，同時此樣品僅保留90天。本報告未經本公司書面許可，不可部份複製。

This document is issued by the Company subject to its General Conditions of Service printed overleaf, available on request or accessible at www.sgs.com/terms_and_conditions.htm and for electronic format documents, subject to Terms and Conditions for Electronic Documents at www.sgs.com/terms_e-document.htm. Attention is drawn to the limitation of liability, indemnification and jurisdiction issues defined therein. Any holder of this document is advised that information contained hereon reflects the Company's findings at the time of its intervention only and within the limits of Client's instructions, if any. The Company's sole responsibility is to its Client and this document does not exonerate parties to a transaction from exercising all their rights and obligations under the transaction documents. This document cannot be reproduced except in full, without prior written approval of the Company. Any unauthorized alteration, forgery or falsification of the content or appearance of this document is unlawful and offenders may be prosecuted to the fullest extent of the law.

Above 1GHz

Model no.	HSC-I001R	Test Mode	Mode 8
Environmental Conditions	25°C, 56% RH	Tested Date	2021/05/20
Antenna Pole	Vertical	Antenna Distance	3m
Highest frequency generated or used	5.8GHz	Upper frequency	29GHz
Detector Function	Peak & Average.	Tested By	Rex Kuo
6dB Bandwidth	1 MHz	Identifier number	TCOP RF site 17

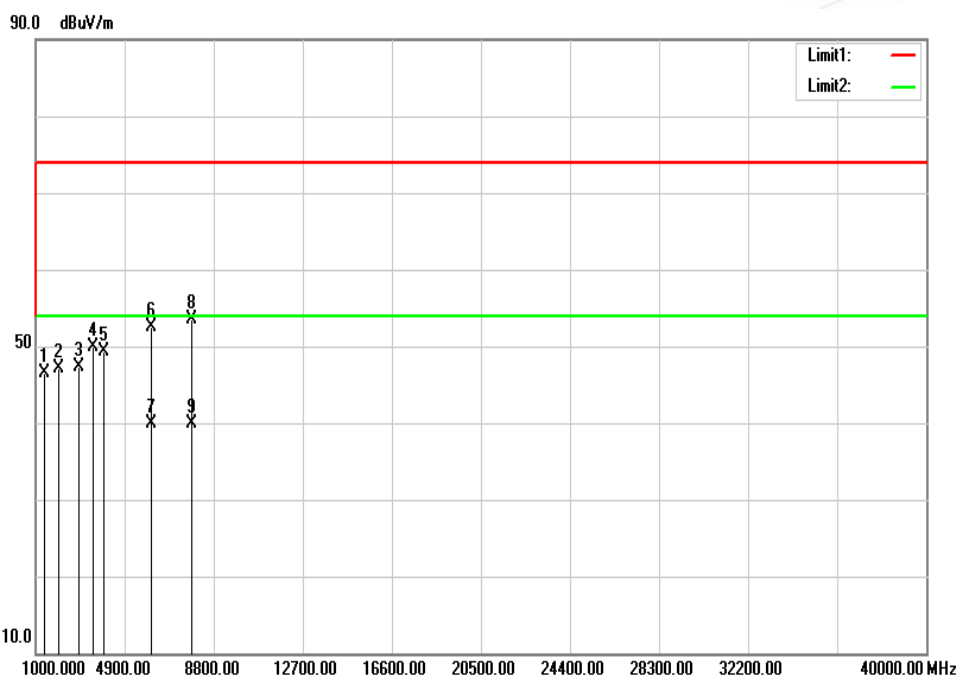

No.	Frequency (MHz)	Reading (dBuV)	Correction Factor (dB/m)	Result (dBuV/m)	Limit (dBuV/m)	Margin (dB)	Height (cm)	Degree (°)	Remark
1	1365.500	64.06	-17.59	46.47	74.00	-27.53	100	220	peak
2	1977.500	60.86	-13.73	47.13	74.00	-26.87	100	197	peak
3	2895.500	59.55	-12.22	47.33	74.00	-26.67	100	213	peak
4	3507.500	60.91	-11.09	49.82	74.00	-24.18	200	280	peak
5	4000.500	60.23	-10.84	49.39	74.00	-24.61	100	181	peak
6	6040.500	56.25	-3.73	52.52	74.00	-21.48	300	347	peak
7	6040.500	43.62	-3.73	39.89	54.00	-14.11	300	347	AVG
8	7817.000	56.31	-2.79	53.52	74.00	-20.48	200	311	peak
9	7817.000	42.73	-2.79	39.94	54.00	-14.06	200	311	AVG

REMARKS:

1. The other emission levels were very low against the limit.
2. Margin (dB) = Result (dBuV/m) – Limit (dBuV/m)

Unless otherwise stated the results shown in this test report refer only to the sample(s) tested and such sample(s) are retained for 90 days only.

除非另有說明，此報告結果僅對測試之樣品負責，同時此樣品僅保留90天。本報告未經本公司書面許可，不可部份複製。

This document is issued by the Company subject to its General Conditions of Service printed overleaf, available on request or accessible at www.sgs.com/terms_and_conditions.htm and for electronic format documents, subject to Terms and Conditions for Electronic Documents at www.sgs.com/terms_e-document.htm. Attention is drawn to the limitation of liability, indemnification and jurisdiction issues defined therein. Any holder of this document is advised that information contained hereon reflects the Company's findings at the time of its intervention only and within the limits of Client's instructions, if any. The Company's sole responsibility is to its Client and this document does not exonerate parties to a transaction from exercising all their rights and obligations under the transaction documents. This document cannot be reproduced except in full, without prior written approval of the Company. Any unauthorized alteration, forgery or falsification of the content or appearance of this document is unlawful and offenders may be prosecuted to the fullest extent of the law.

Model no.	HSC-I001R	Test Mode	Mode 8
Environmental Conditions	25°C, 56% RH	Tested Date	2021/05/20
Antenna Pole	Horizontal	Antenna Distance	3m
Highest frequency generated or used	5.8GHz	Upper frequency	29GHz
Detector Function	Peak & Average.	Tested By	Rex Kuo
6dB Bandwidth	1 MHz	Identifier number	TCOP RF site 17

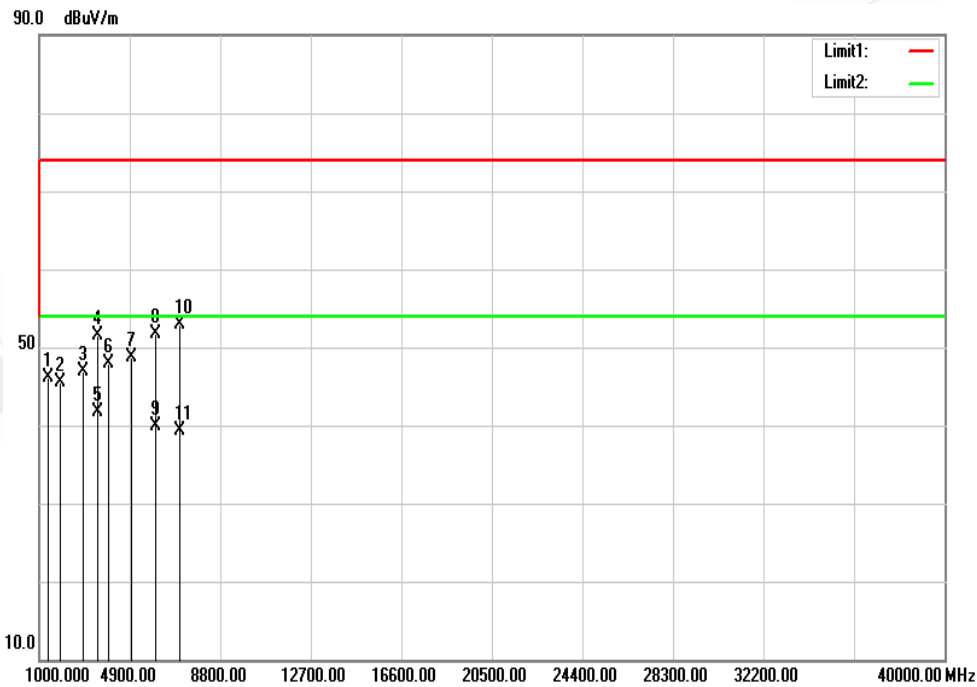

No.	Frequency (MHz)	Reading (dBuV)	Correction Factor (dB/m)	Result (dBuV/m)	Limit (dBuV/m)	Margin (dB)	Height (cm)	Degree (°)	Remark
1	1365.500	63.77	-17.59	46.18	74.00	-27.82	100	257	peak
2	1875.500	60.44	-14.91	45.53	74.00	-28.47	100	186	peak
3	2887.000	59.19	-12.24	46.95	74.00	-27.05	100	194	peak
4	3507.500	62.58	-11.09	51.49	74.00	-22.51	100	178	peak
5	3507.500	52.80	-11.09	41.71	54.00	-12.29	100	178	AVG
6	4000.500	58.79	-10.84	47.95	74.00	-26.05	200	323	peak
7	4978.000	56.25	-7.63	48.62	74.00	-25.38	300	304	peak
8	6023.500	55.35	-3.68	51.67	74.00	-22.33	193	360	peak
9	6023.500	43.49	-3.68	39.81	54.00	-14.19	193	360	AVG

Unless otherwise stated the results shown in this test report refer only to the sample(s) tested and such sample(s) are retained for 90 days only.

除非另有說明，此報告結果僅對測試之樣品負責，同時此樣品僅保留90天。本報告未經本公司書面許可，不可部份複製。

This document is issued by the Company subject to its General Conditions of Service printed overleaf, available on request or accessible at www.sgs.com/terms_and_conditions.htm and for electronic format documents, subject to Terms and Conditions for Electronic Documents at www.sgs.com/terms_e-document.htm. Attention is drawn to the limitation of liability, indemnification and jurisdiction issues defined therein. Any holder of this document is advised that information contained hereon reflects the Company's findings at the time of its intervention only and within the limits of Client's instructions, if any. The Company's sole responsibility is to its Client and this document does not exonerate parties to a transaction from exercising all their rights and obligations under the transaction documents. This document cannot be reproduced except in full, without prior written approval of the Company. Any unauthorized alteration, forgery or falsification of the content or appearance of this document is unlawful and offenders may be prosecuted to the fullest extent of the law.

No.	Frequency (MHz)	Reading (dBuV)	Correction Factor (dB/m)	Result (dBuV/m)	Limit (dBuV/m)	Margin (dB)	Height (cm)	Degree (°)	Remark
10	7026.500	55.93	-2.95	52.98	74.00	-21.02	239	0	peak
11	7026.500	42.23	-2.95	39.28	54.00	-14.72	239	0	AVG

REMARKS:

1. The other emission levels were very low against the limit.
2. Margin (dB) = Result (dBuV/m) – Limit (dBuV/m)

Unless otherwise stated the results shown in this test report refer only to the sample(s) tested and such sample(s) are retained for 90 days only.

除非另有說明，此報告結果僅對測試之樣品負責，同時此樣品僅保留90天。本報告未經本公司書面許可，不可部份複製。

This document is issued by the Company subject to its General Conditions of Service printed overleaf, available on request or accessible at www.sgs.com/terms_and_conditions.htm and for electronic format documents, subject to Terms and Conditions for Electronic Documents at www.sgs.com/terms_e-document.htm. Attention is drawn to the limitation of liability, indemnification and jurisdiction issues defined therein. Any holder of this document is advised that information contained hereon reflects the Company's findings at the time of its intervention only and within the limits of Client's instructions, if any. The Company's sole responsibility is to its Client and this document does not exonerate parties to a transaction from exercising all their rights and obligations under the transaction documents. This document cannot be reproduced except in full, without prior written approval of the Company. Any unauthorized alteration, forgery or falsification of the content or appearance of this document is unlawful and offenders may be prosecuted to the fullest extent of the law.

Model no.	HSC-I001R	Test Mode	Mode 11
Environmental Conditions	25°C, 56% RH	Tested Date	2021/05/20
Antenna Pole	Vertical	Antenna Distance	3m
Highest frequency generated or used	5.8GHz	Upper frequency	29GHz
Detector Function	Peak & Average.	Tested By	Rex Kuo
6dB Bandwidth	1 MHz	Identifier number	TCOP RF site 17

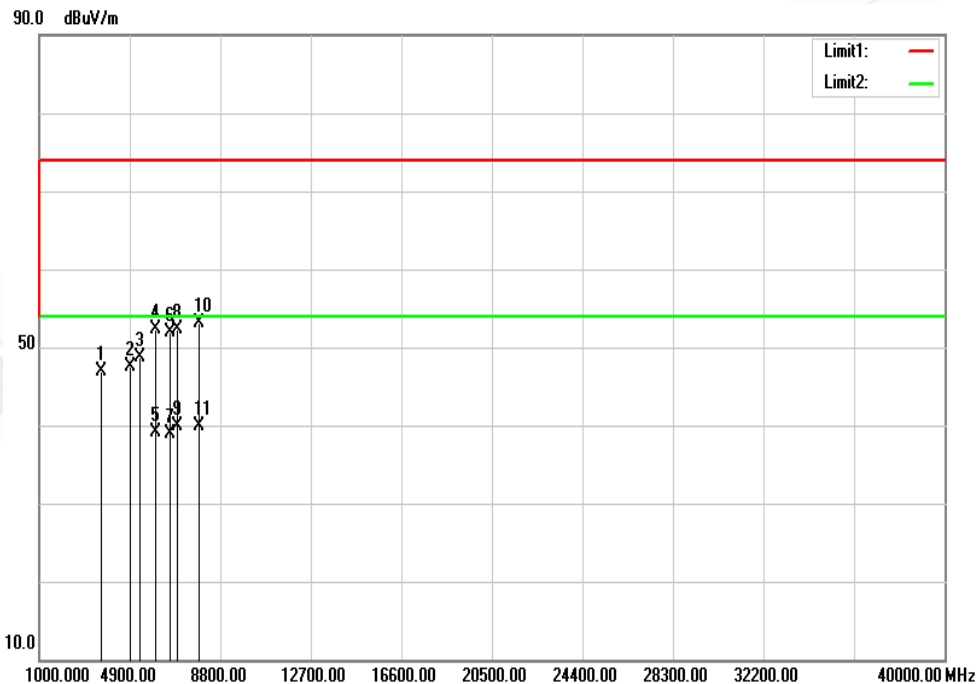

No.	Frequency (MHz)	Reading (dBuV)	Correction Factor (dB/m)	Result (dBuV/m)	Limit (dBuV/m)	Margin (dB)	Height (cm)	Degree (°)	Remark
1	3643.500	57.56	-10.69	46.87	74.00	-27.13	200	316	peak
2	4918.500	55.34	-7.84	47.50	74.00	-26.50	200	292	peak
3	5301.000	55.70	-6.95	48.75	74.00	-25.25	300	12	peak
4	5972.500	56.12	-3.83	52.29	74.00	-21.71	100	360	peak
5	5972.500	43.00	-3.83	39.17	54.00	-14.83	100	360	AVG
6	6610.000	56.00	-4.01	51.99	74.00	-22.01	100	232	peak
7	6610.000	42.82	-4.01	38.81	54.00	-15.19	100	232	AVG
8	6907.500	55.64	-3.26	52.38	74.00	-21.62	218	0	peak
9	6907.500	43.07	-3.26	39.81	54.00	-14.19	218	0	AVG

Unless otherwise stated the results shown in this test report refer only to the sample(s) tested and such sample(s) are retained for 90 days only.

除非另有說明，此報告結果僅對測試之樣品負責，同時此樣品僅保留90天。本報告未經本公司書面許可，不可部份複製。

This document is issued by the Company subject to its General Conditions of Service printed overleaf, available on request or accessible at www.sgs.com/terms_and_conditions.htm and for electronic format documents, subject to Terms and Conditions for Electronic Documents at www.sgs.com/terms_e-document.htm. Attention is drawn to the limitation of liability, indemnification and jurisdiction issues defined therein. Any holder of this document is advised that information contained hereon reflects the Company's findings at the time of its intervention only and within the limits of Client's instructions, if any. The Company's sole responsibility is to its Client and this document does not exonerate parties to a transaction from exercising all their rights and obligations under the transaction documents. This document cannot be reproduced except in full, without prior written approval of the Company. Any unauthorized alteration, forgery or falsification of the content or appearance of this document is unlawful and offenders may be prosecuted to the fullest extent of the law.

No.	Frequency (MHz)	Reading (dBuV)	Correction Factor (dB/m)	Result (dBuV/m)	Limit (dBuV/m)	Margin (dB)	Height (cm)	Degree (°)	Remark
10	7825.500	55.87	-2.80	53.07	74.00	-20.93	300	360	peak
11	7825.500	42.68	-2.80	39.88	54.00	-14.12	300	360	AVG

REMARKS:

1. The other emission levels were very low against the limit.
2. Margin (dB) = Result (dBuV/m) – Limit (dBuV/m)

Unless otherwise stated the results shown in this test report refer only to the sample(s) tested and such sample(s) are retained for 90 days only.

除非另有說明，此報告結果僅對測試之樣品負責，同時此樣品僅保留90天。本報告未經本公司書面許可，不可部份複製。

This document is issued by the Company subject to its General Conditions of Service printed overleaf, available on request or accessible at www.sgs.com/terms_and_conditions.htm and for electronic format documents, subject to Terms and Conditions for Electronic Documents at www.sgs.com/terms_e-document.htm. Attention is drawn to the limitation of liability, indemnification and jurisdiction issues defined therein. Any holder of this document is advised that information contained hereon reflects the Company's findings at the time of its intervention only and within the limits of Client's instructions, if any. The Company's sole responsibility is to its Client and this document does not exonerate parties to a transaction from exercising all their rights and obligations under the transaction documents. This document cannot be reproduced except in full, without prior written approval of the Company. Any unauthorized alteration, forgery or falsification of the content or appearance of this document is unlawful and offenders may be prosecuted to the fullest extent of the law.

Model no.	HSC-I001R	Test Mode	Mode 11
Environmental Conditions	25°C, 56% RH	Tested Date	2021/05/20
Antenna Pole	Horizontal	Antenna Distance	3m
Highest frequency generated or used	5.8GHz	Upper frequency	29GHz
Detector Function	Peak & Average.	Tested By	Rex Kuo
6dB Bandwidth	1 MHz	Identifier number	TCOP RF site 17

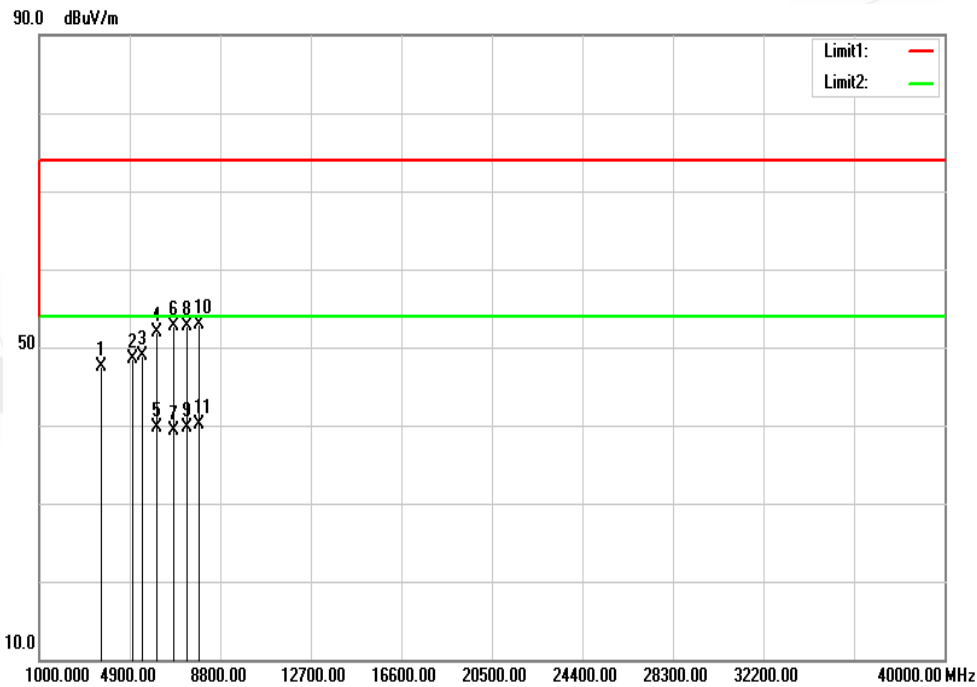

No.	Frequency (MHz)	Reading (dBuV)	Correction Factor (dB/m)	Result (dBuV/m)	Limit (dBuV/m)	Margin (dB)	Height (cm)	Degree (°)	Remark
1	3618.000	58.19	-10.67	47.52	74.00	-26.48	200	357	peak
2	4995.000	56.09	-7.57	48.52	74.00	-25.48	100	313	peak
3	5420.000	55.63	-6.81	48.82	74.00	-25.18	114	360	peak
4	6049.000	55.61	-3.75	51.86	74.00	-22.14	200	244	peak
5	6049.000	43.53	-3.75	39.78	54.00	-14.22	200	244	AVG
6	6737.500	56.42	-3.71	52.71	74.00	-21.29	300	0	peak
7	6737.500	42.96	-3.71	39.25	54.00	-14.75	300	0	AVG
8	7349.500	55.40	-2.74	52.66	74.00	-21.34	100	250	peak
9	7349.500	42.48	-2.74	39.74	54.00	-14.26	100	250	AVG

Unless otherwise stated the results shown in this test report refer only to the sample(s) tested and such sample(s) are retained for 90 days only.

除非另有說明，此報告結果僅對測試之樣品負責，同時此樣品僅保留90天。本報告未經本公司書面許可，不可部份複製。

This document is issued by the Company subject to its General Conditions of Service printed overleaf, available on request or accessible at www.sgs.com/terms_and_conditions.htm and for electronic format documents, subject to Terms and Conditions for Electronic Documents at www.sgs.com/terms_e-document.htm. Attention is drawn to the limitation of liability, indemnification and jurisdiction issues defined therein. Any holder of this document is advised that information contained hereon reflects the Company's findings at the time of its intervention only and within the limits of Client's instructions, if any. The Company's sole responsibility is to its Client and this document does not exonerate parties to a transaction from exercising all their rights and obligations under the transaction documents. This document cannot be reproduced except in full, without prior written approval of the Company. Any unauthorized alteration, forgery or falsification of the content or appearance of this document is unlawful and offenders may be prosecuted to the fullest extent of the law.

No.	Frequency (MHz)	Reading (dBuV)	Correction Factor (dB/m)	Result (dBuV/m)	Limit (dBuV/m)	Margin (dB)	Height (cm)	Degree (°)	Remark
10	7825.500	55.65	-2.80	52.85	74.00	-21.15	100	360	peak
11	7825.500	42.82	-2.80	40.02	54.00	-13.98	100	360	AVG

REMARKS:

1. The other emission levels were very low against the limit.
2. Margin (dB) = Result (dBuV/m) – Limit (dBuV/m)

Unless otherwise stated the results shown in this test report refer only to the sample(s) tested and such sample(s) are retained for 90 days only.

除非另有說明，此報告結果僅對測試之樣品負責，同時此樣品僅保留90天。本報告未經本公司書面許可，不可部份複製。

This document is issued by the Company subject to its General Conditions of Service printed overleaf, available on request or accessible at www.sgs.com/terms_and_conditions.htm and for electronic format documents, subject to Terms and Conditions for Electronic Documents at www.sgs.com/terms_e-document.htm. Attention is drawn to the limitation of liability, indemnification and jurisdiction issues defined therein. Any holder of this document is advised that information contained hereon reflects the Company's findings at the time of its intervention only and within the limits of Client's instructions, if any. The Company's sole responsibility is to its Client and this document does not exonerate parties to a transaction from exercising all their rights and obligations under the transaction documents. This document cannot be reproduced except in full, without prior written approval of the Company. Any unauthorized alteration, forgery or falsification of the content or appearance of this document is unlawful and offenders may be prosecuted to the fullest extent of the law.

Model no.	HSC-I001R	Test Mode	Mode 12
Environmental Conditions	25°C, 52% RH	Tested Date	2021/05/22
Antenna Pole	Vertical	Antenna Distance	3m
Highest frequency generated or used	5.8GHz	Upper frequency	29GHz
Detector Function	Peak & Average.	Tested By	Rex Kuo
6dB Bandwidth	1 MHz	Identifier number	TCOP RF site 17

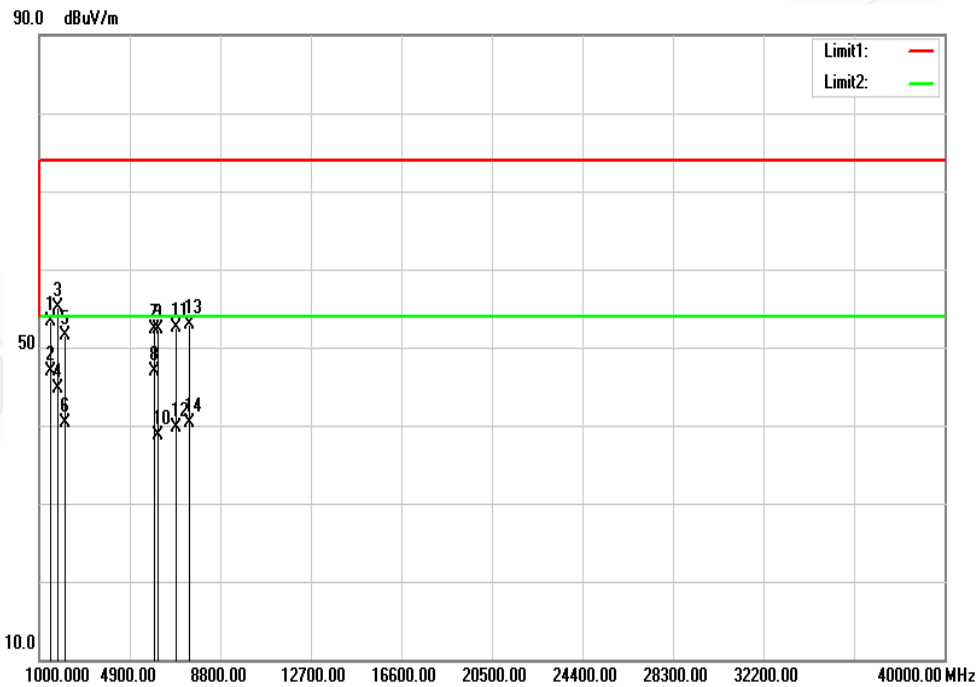

No.	Frequency (MHz)	Reading (dBuV)	Correction Factor (dB/m)	Result (dBuV/m)	Limit (dBuV/m)	Margin (dB)	Height (cm)	Degree (°)	Remark
1	1484.500	70.65	-17.44	53.21	74.00	-20.79	100	217	peak
2	1484.500	64.39	-17.44	46.95	54.00	-7.05	100	217	AVG
3	1773.500	71.02	-15.99	55.03	74.00	-18.97	100	250	peak
4	1773.500	60.61	-15.99	44.62	54.00	-9.38	100	250	AVG
5	2096.500	64.96	-13.43	51.53	74.00	-22.47	200	255	peak
6	2096.500	53.79	-13.43	40.36	54.00	-13.64	200	255	AVG
7	5930.000	56.46	-4.16	52.30	74.00	-21.70	100	131	peak
8	5930.000	50.97	-4.16	46.81	54.00	-7.19	100	131	AVG
9	6100.000	56.14	-3.89	52.25	74.00	-21.75	100	158	peak

Unless otherwise stated the results shown in this test report refer only to the sample(s) tested and such sample(s) are retained for 90 days only.

除非另有說明，此報告結果僅對測試之樣品負責，同時此樣品僅保留90天。本報告未經本公司書面許可，不可部份複製。

This document is issued by the Company subject to its General Conditions of Service printed overleaf, available on request or accessible at www.sgs.com/terms_and_conditions.htm and for electronic format documents, subject to Terms and Conditions for Electronic Documents at www.sgs.com/terms_e-document.htm. Attention is drawn to the limitation of liability, indemnification and jurisdiction issues defined therein. Any holder of this document is advised that information contained hereon reflects the Company's findings at the time of its intervention only and within the limits of Client's instructions, if any. The Company's sole responsibility is to its Client and this document does not exonerate parties to a transaction from exercising all their rights and obligations under the transaction documents. This document cannot be reproduced except in full, without prior written approval of the Company. Any unauthorized alteration, forgery or falsification of the content or appearance of this document is unlawful and offenders may be prosecuted to the fullest extent of the law.

No.	Frequency (MHz)	Reading (dBuV)	Correction Factor (dB/m)	Result (dBuV/m)	Limit (dBuV/m)	Margin (dB)	Height (cm)	Degree (°)	Remark
10	6100.000	42.60	-3.89	38.71	54.00	-15.29	100	158	AVG
11	6882.000	55.75	-3.33	52.42	74.00	-21.58	300	183	peak
12	6882.000	43.08	-3.33	39.75	54.00	-14.25	300	183	AVG
13	7451.500	55.76	-2.78	52.98	74.00	-21.02	300	6	peak
14	7451.500	42.99	-2.78	40.21	54.00	-13.79	300	6	AVG

REMARKS:

1. The other emission levels were very low against the limit.
2. Margin (dB) = Result (dBuV/m) – Limit (dBuV/m)

Unless otherwise stated the results shown in this test report refer only to the sample(s) tested and such sample(s) are retained for 90 days only.

除非另有說明，此報告結果僅對測試之樣品負責，同時此樣品僅保留90天。本報告未經本公司書面許可，不可部份複製。

This document is issued by the Company subject to its General Conditions of Service printed overleaf, available on request or accessible at www.sgs.com/terms_and_conditions.htm and for electronic format documents, subject to Terms and Conditions for Electronic Documents at www.sgs.com/terms_e-document.htm. Attention is drawn to the limitation of liability, indemnification and jurisdiction issues defined therein. Any holder of this document is advised that information contained hereon reflects the Company's findings at the time of its intervention only and within the limits of Client's instructions, if any. The Company's sole responsibility is to its Client and this document does not exonerate parties to a transaction from exercising all their rights and obligations under the transaction documents. This document cannot be reproduced except in full, without prior written approval of the Company. Any unauthorized alteration, forgery or falsification of the content or appearance of this document is unlawful and offenders may be prosecuted to the fullest extent of the law.

Model no.	HSC-I001R	Test Mode	Mode 12
Environmental Conditions	25°C, 52% RH	Tested Date	2021/05/22
Antenna Pole	Horizontal	Antenna Distance	3m
Highest frequency generated or used	5.8GHz	Upper frequency	29GHz
Detector Function	Peak & Average.	Tested By	Rex Kuo
6dB Bandwidth	1 MHz	Identifier number	TCOP RF site 17

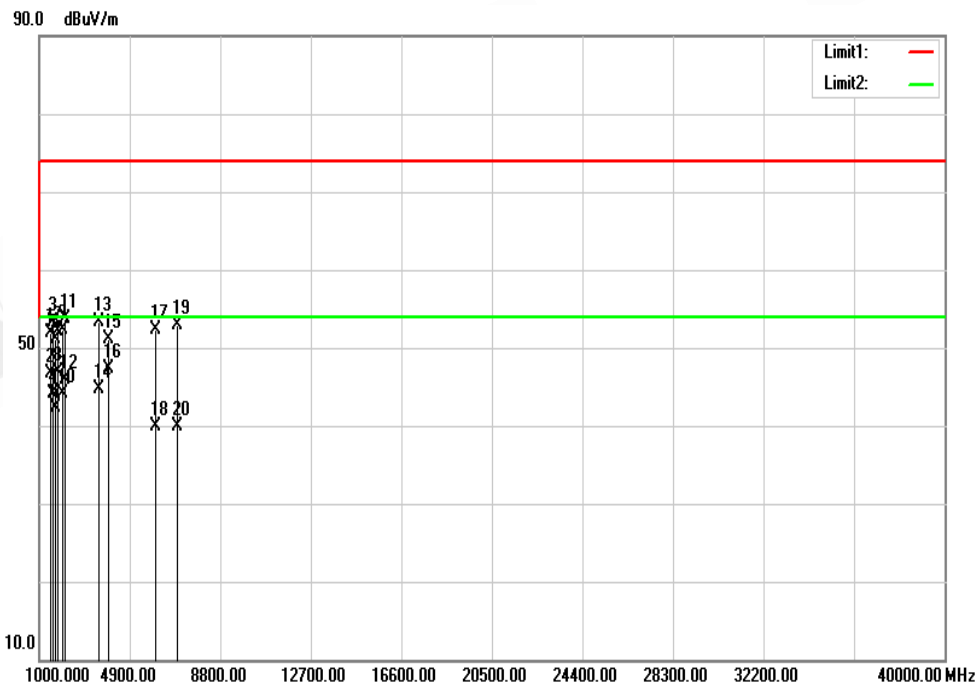

No.	Frequency (MHz)	Reading (dBuV)	Correction Factor (dB/m)	Result (dBuV/m)	Limit (dBuV/m)	Margin (dB)	Height (cm)	Degree (°)	Remark
1	1484.500	69.38	-17.44	51.94	74.00	-22.06	200	117	peak
2	1484.500	64.20	-17.44	46.76	54.00	-7.24	200	117	AVG
3	1578.000	70.55	-17.34	53.21	74.00	-20.79	300	18	peak
4	1578.000	61.37	-17.34	44.03	54.00	-9.97	300	18	AVG
5	1671.500	67.87	-16.77	51.10	74.00	-22.90	200	25	peak
6	1671.500	59.15	-16.77	42.38	54.00	-11.62	200	25	AVG
7	1782.000	68.03	-15.93	52.10	74.00	-21.90	200	190	peak
8	1782.000	62.90	-15.93	46.97	54.00	-7.03	200	190	AVG

Unless otherwise stated the results shown in this test report refer only to the sample(s) tested and such sample(s) are retained for 90 days only.

除非另有說明，此報告結果僅對測試之樣品負責，同時此樣品僅保留90天。本報告未經本公司書面許可，不可部份複製。

This document is issued by the Company subject to its General Conditions of Service printed overleaf, available on request or accessible at www.sgs.com/terms_and_conditions.htm and for electronic format documents, subject to Terms and Conditions for Electronic Documents at www.sgs.com/terms_e-document.htm. Attention is drawn to the limitation of liability, indemnification and jurisdiction issues defined therein. Any holder of this document is advised that information contained hereon reflects the Company's findings at the time of its intervention only and within the limits of Client's instructions, if any. The Company's sole responsibility is to its Client and this document does not exonerate parties to a transaction from exercising all their rights and obligations under the transaction documents. This document cannot be reproduced except in full, without prior written approval of the Company. Any unauthorized alteration, forgery or falsification of the content or appearance of this document is unlawful and offenders may be prosecuted to the fullest extent of the law.

No.	Frequency (MHz)	Reading (dBuV)	Correction Factor (dB/m)	Result (dBuV/m)	Limit (dBuV/m)	Margin (dB)	Height (cm)	Degree (°)	Remark
9	1994.500	65.75	-13.53	52.22	74.00	-21.78	200	45	peak
10	1994.500	57.65	-13.53	44.12	54.00	-9.88	200	45	AVG
11	2071.000	67.10	-13.43	53.67	74.00	-20.33	200	25	peak
12	2071.000	59.24	-13.43	45.81	54.00	-8.19	200	25	AVG
13	3558.500	64.16	-10.86	53.30	74.00	-20.70	200	360	peak
14	3558.500	55.55	-10.86	44.69	54.00	-9.31	200	360	AVG
15	4000.500	61.94	-10.84	51.10	74.00	-22.90	200	328	peak
16	4000.500	58.10	-10.84	47.26	54.00	-6.74	200	328	AVG
17	6023.500	55.95	-3.68	52.27	74.00	-21.73	100	1	peak
18	6023.500	43.54	-3.68	39.86	54.00	-14.14	100	1	AVG
19	6899.000	56.22	-3.28	52.94	74.00	-21.06	300	137	peak
20	6899.000	43.11	-3.28	39.83	54.00	-14.17	300	137	AVG

REMARKS:

1. The other emission levels were very low against the limit.
2. Margin (dB) = Result (dBuV/m) – Limit (dBuV/m)

Unless otherwise stated the results shown in this test report refer only to the sample(s) tested and such sample(s) are retained for 90 days only.

除非另有說明，此報告結果僅對測試之樣品負責，同時此樣品僅保留90天。本報告未經本公司書面許可，不可部份複製。

This document is issued by the Company subject to its General Conditions of Service printed overleaf, available on request or accessible at www.sgs.com/terms_and_conditions.htm and for electronic format documents, subject to Terms and Conditions for Electronic Documents at www.sgs.com/terms_e-document.htm. Attention is drawn to the limitation of liability, indemnification and jurisdiction issues defined therein. Any holder of this document is advised that information contained hereon reflects the Company's findings at the time of its intervention only and within the limits of Client's instructions, if any. The Company's sole responsibility is to its Client and this document does not exonerate parties to a transaction from exercising all their rights and obligations under the transaction documents. This document cannot be reproduced except in full, without prior written approval of the Company. Any unauthorized alteration, forgery or falsification of the content or appearance of this document is unlawful and offenders may be prosecuted to the fullest extent of the law.

Model no.	HSC-I001R	Test Mode	Mode 13
Environmental Conditions	25°C, 52% RH	Tested Date	2021/05/22
Antenna Pole	Vertical	Antenna Distance	3m
Highest frequency generated or used	5.8GHz	Upper frequency	29GHz
Detector Function	Peak & Average.	Tested By	Rex Kuo
6dB Bandwidth	1 MHz	Identifier number	TCOP RF site 17

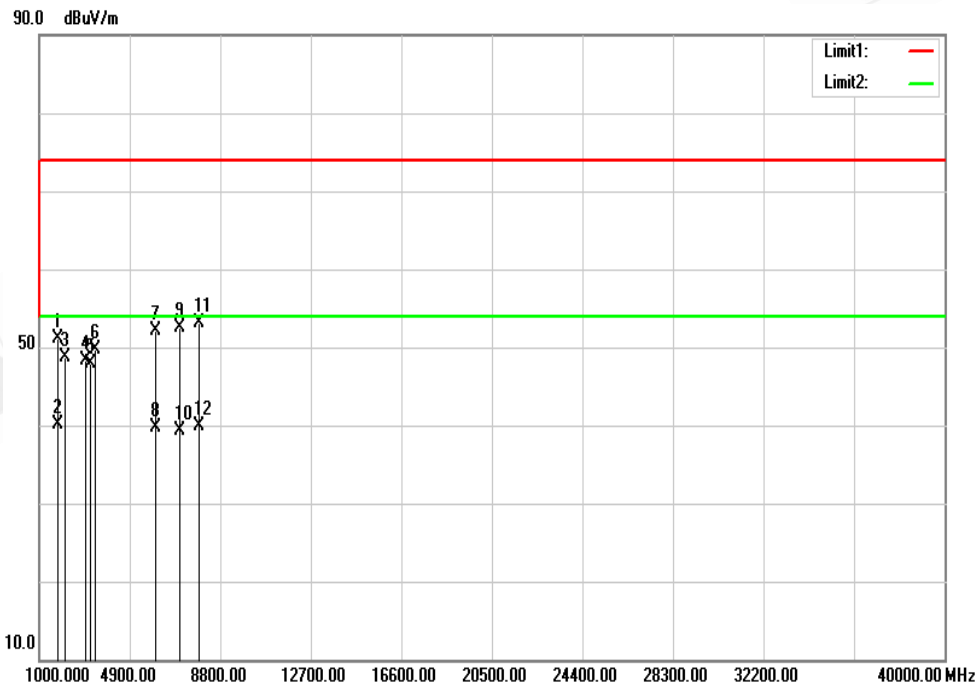

No.	Frequency (MHz)	Reading (dBuV)	Correction Factor (dB/m)	Result (dBuV/m)	Limit (dBuV/m)	Margin (dB)	Height (cm)	Degree (°)	Remark
1	1782.000	67.14	-16.02	51.12	74.00	-22.88	200	228	peak
2	1782.000	56.22	-16.02	40.20	54.00	-13.80	200	228	AVG
3	2088.000	61.70	-12.90	48.80	74.00	-25.20	200	3	peak
4	2980.500	60.30	-12.07	48.23	74.00	-25.77	200	312	peak
5	3201.500	59.47	-11.54	47.93	74.00	-26.07	200	81	peak
6	3380.000	61.27	-11.58	49.69	74.00	-24.31	200	266	peak
7	6006.500	55.84	-3.69	52.15	74.00	-21.85	100	140	peak
8	6006.500	43.34	-3.69	39.65	54.00	-14.35	100	140	AVG
9	7009.500	55.45	-2.97	52.48	74.00	-21.52	100	202	peak

Unless otherwise stated the results shown in this test report refer only to the sample(s) tested and such sample(s) are retained for 90 days only.

除非另有說明，此報告結果僅對測試之樣品負責，同時此樣品僅保留90天。本報告未經本公司書面許可，不可部份複製。

This document is issued by the Company subject to its General Conditions of Service printed overleaf, available on request or accessible at www.sgs.com/terms_and_conditions.htm and for electronic format documents, subject to Terms and Conditions for Electronic Documents at www.sgs.com/terms_e-document.htm. Attention is drawn to the limitation of liability, indemnification and jurisdiction issues defined therein. Any holder of this document is advised that information contained hereon reflects the Company's findings at the time of its intervention only and within the limits of Client's instructions, if any. The Company's sole responsibility is to its Client and this document does not exonerate parties to a transaction from exercising all their rights and obligations under the transaction documents. This document cannot be reproduced except in full, without prior written approval of the Company. Any unauthorized alteration, forgery or falsification of the content or appearance of this document is unlawful and offenders may be prosecuted to the fullest extent of the law.

No.	Frequency (MHz)	Reading (dBuV)	Correction Factor (dB/m)	Result (dBuV/m)	Limit (dBuV/m)	Margin (dB)	Height (cm)	Degree (°)	Remark
10	7009.500	42.36	-2.97	39.39	54.00	-14.61	100	202	AVG
11	7842.500	55.92	-2.84	53.08	74.00	-20.92	100	317	peak
12	7842.500	42.82	-2.84	39.98	54.00	-14.02	100	317	AVG

REMARKS:

1. The other emission levels were very low against the limit.
2. Margin (dB) = Result (dBuV/m) – Limit (dBuV/m)

Unless otherwise stated the results shown in this test report refer only to the sample(s) tested and such sample(s) are retained for 90 days only.

除非另有說明，此報告結果僅對測試之樣品負責，同時此樣品僅保留90天。本報告未經本公司書面許可，不可部份複製。

This document is issued by the Company subject to its General Conditions of Service printed overleaf, available on request or accessible at www.sgs.com/terms_and_conditions.htm and for electronic format documents, subject to Terms and Conditions for Electronic Documents at www.sgs.com/terms_e-document.htm. Attention is drawn to the limitation of liability, indemnification and jurisdiction issues defined therein. Any holder of this document is advised that information contained hereon reflects the Company's findings at the time of its intervention only and within the limits of Client's instructions, if any. The Company's sole responsibility is to its Client and this document does not exonerate parties to a transaction from exercising all their rights and obligations under the transaction documents. This document cannot be reproduced except in full, without prior written approval of the Company. Any unauthorized alteration, forgery or falsification of the content or appearance of this document is unlawful and offenders may be prosecuted to the fullest extent of the law.

Model no.	HSC-I001R	Test Mode	Mode 13
Environmental Conditions	25°C, 52% RH	Tested Date	2021/05/22
Antenna Pole	Horizontal	Antenna Distance	3m
Highest frequency generated or used	5.8GHz	Upper frequency	29GHz
Detector Function	Peak & Average.	Tested By	Rex Kuo
6dB Bandwidth	1 MHz	Identifier number	TCOP RF site 17

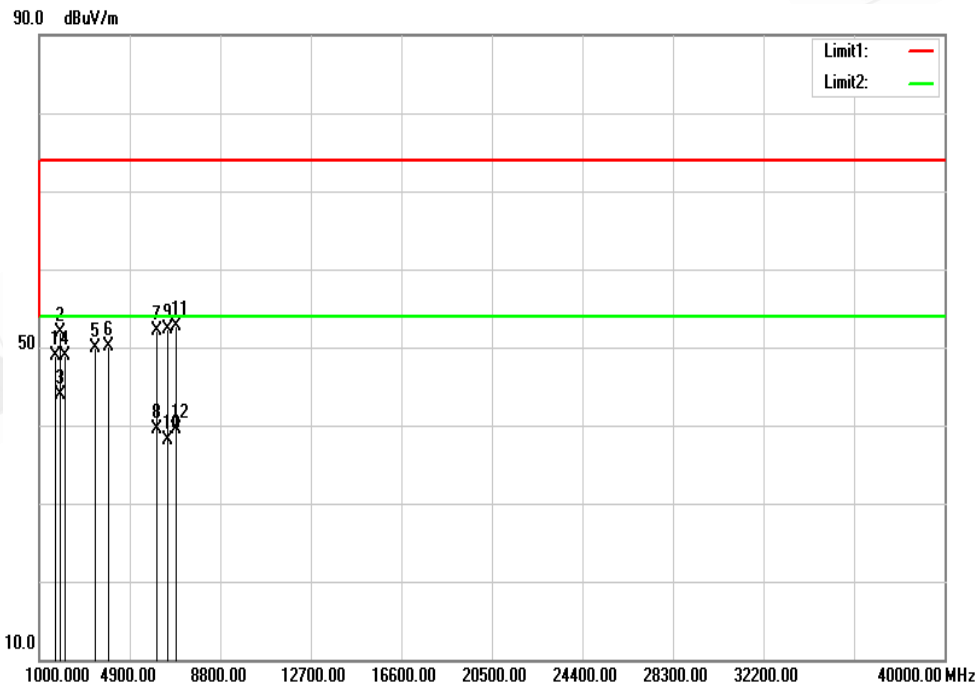

No.	Frequency (MHz)	Reading (dBuV)	Correction Factor (dB/m)	Result (dBuV/m)	Limit (dBuV/m)	Margin (dB)	Height (cm)	Degree (°)	Remark
1	1688.500	65.68	-16.76	48.92	74.00	-25.08	100	232	peak
2	1867.000	67.02	-15.08	51.94	74.00	-22.06	300	86	peak
3	1867.000	58.99	-15.08	43.91	54.00	-10.09	300	86	AVG
4	2088.000	61.86	-12.90	48.96	74.00	-25.04	300	93	peak
5	3380.000	61.53	-11.58	49.95	74.00	-24.05	200	166	peak
6	4000.500	60.85	-10.84	50.01	74.00	-23.99	100	170	peak
7	6032.000	56.04	-3.95	52.09	74.00	-21.91	100	324	peak
8	6032.000	43.54	-3.95	39.59	54.00	-14.41	100	324	AVG
9	6499.500	56.57	-4.32	52.25	74.00	-21.75	300	93	peak

Unless otherwise stated the results shown in this test report refer only to the sample(s) tested and such sample(s) are retained for 90 days only.
除非另有說明，此報告結果僅對測試之樣品負責，同時此樣品僅保留90天。本報告未經本公司書面許可，不可部份複製。

This document is issued by the Company subject to its General Conditions of Service printed overleaf, available on request or accessible at www.sgs.com/terms_and_conditions.htm and for electronic format documents, subject to Terms and Conditions for Electronic Documents at www.sgs.com/terms_e-document.htm. Attention is drawn to the limitation of liability, indemnification and jurisdiction issues defined therein. Any holder of this document is advised that information contained hereon reflects the Company's findings at the time of its intervention only and within the limits of Client's instructions, if any. The Company's sole responsibility is to its Client and this document does not exonerate parties to a transaction from exercising all their rights and obligations under the transaction documents. This document cannot be reproduced except in full, without prior written approval of the Company. Any unauthorized alteration, forgery or falsification of the content or appearance of this document is unlawful and offenders may be prosecuted to the fullest extent of the law.

No.	Frequency (MHz)	Reading (dBuV)	Correction Factor (dB/m)	Result (dBuV/m)	Limit (dBuV/m)	Margin (dB)	Height (cm)	Degree (°)	Remark
10	6499.500	42.41	-4.32	38.09	54.00	-15.91	300	93	AVG
11	6856.500	55.78	-3.11	52.67	74.00	-21.33	300	70	peak
12	6856.500	42.70	-3.11	39.59	54.00	-14.41	300	70	AVG

REMARKS:

1. The other emission levels were very low against the limit.
2. Margin (dB) = Result (dBuV/m) – Limit (dBuV/m)

Unless otherwise stated the results shown in this test report refer only to the sample(s) tested and such sample(s) are retained for 90 days only.

除非另有說明，此報告結果僅對測試之樣品負責，同時此樣品僅保留90天。本報告未經本公司書面許可，不可部份複製。

This document is issued by the Company subject to its General Conditions of Service printed overleaf, available on request or accessible at www.sgs.com/terms_and_conditions.htm and for electronic format documents, subject to Terms and Conditions for Electronic Documents at www.sgs.com/terms_e-document.htm. Attention is drawn to the limitation of liability, indemnification and jurisdiction issues defined therein. Any holder of this document is advised that information contained hereon reflects the Company's findings at the time of its intervention only and within the limits of Client's instructions, if any. The Company's sole responsibility is to its Client and this document does not exonerate parties to a transaction from exercising all their rights and obligations under the transaction documents. This document cannot be reproduced except in full, without prior written approval of the Company. Any unauthorized alteration, forgery or falsification of the content or appearance of this document is unlawful and offenders may be prosecuted to the fullest extent of the law.

APPENDIX

Photograph of Testing General Set-up

CE Testing Set-up

Model No.: HSC-I001R
Mode 8 +



Mode 8 -

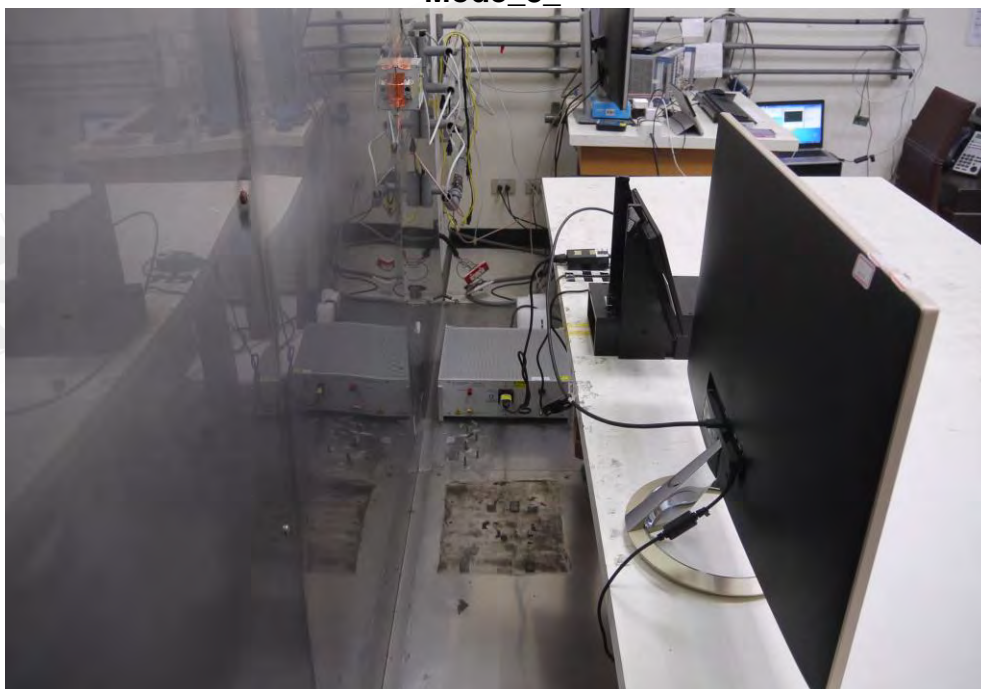

Unless otherwise stated the results shown in this test report refer only to the sample(s) tested and such sample(s) are retained for 90 days only.

除非另有說明，此報告結果僅對測試之樣品負責，同時此樣品僅保留90天。本報告未經本公司書面許可，不可部份複製。

This document is issued by the Company subject to its General Conditions of Service printed overleaf, available on request or accessible at www.sgs.com/terms_and_conditions.htm and for electronic format documents, subject to Terms and Conditions for Electronic Documents at www.sgs.com/terms_e-document.htm. Attention is drawn to the limitation of liability, indemnification and jurisdiction issues defined therein. Any holder of this document is advised that information contained herein reflects the Company's findings at the time of its intervention only and within the limits of Client's instructions, if any. The Company's sole responsibility is to its Client and this document does not exonerate parties to a transaction from exercising all their rights and obligations under the transaction documents. This document cannot be reproduced except in full, without prior written approval of the Company. Any unauthorized alteration, forgery or falsification of the content or appearance of this document is unlawful and offenders may be prosecuted to the fullest extent of the law.

Model No.: HSC-I001R

Mode_11_+

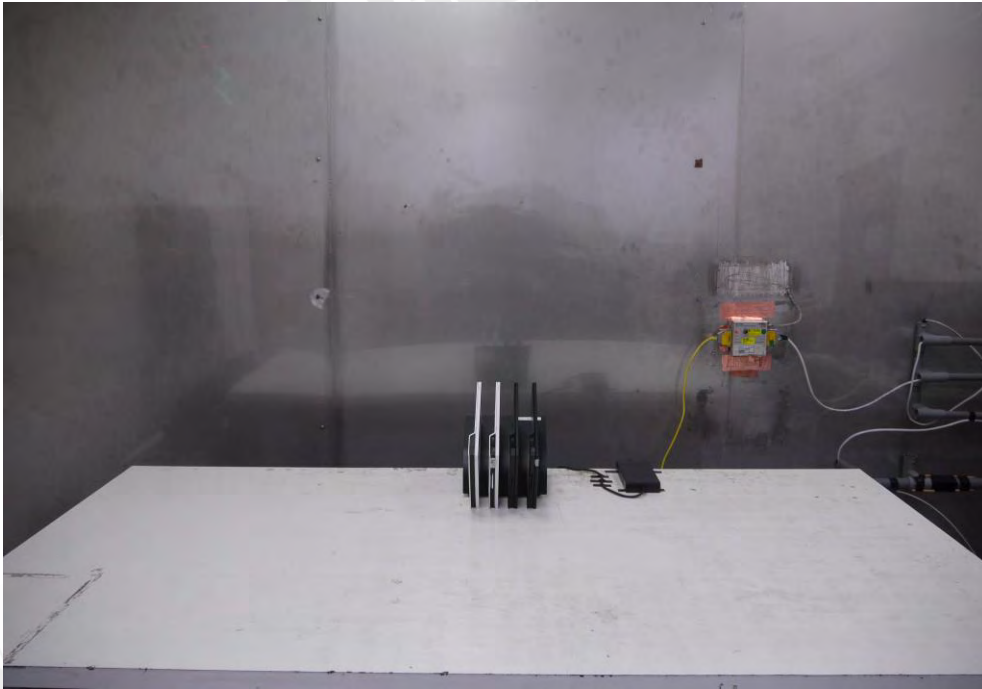

Mode_11_-



Unless otherwise stated the results shown in this test report refer only to the sample(s) tested and such sample(s) are retained for 90 days only.

除非另有說明，此報告結果僅對測試之樣品負責，同時此樣品僅保留90天。本報告未經本公司書面許可，不可部份複製。

This document is issued by the Company subject to its General Conditions of Service printed overleaf, available on request or accessible at www.sgs.com/terms_and_conditions.htm and for electronic format documents, subject to Terms and Conditions for Electronic Documents at www.sgs.com/terms_e-document.htm. Attention is drawn to the limitation of liability, indemnification and jurisdiction issues defined therein. Any holder of this document is advised that information contained hereon reflects the Company's findings at the time of its intervention only and within the limits of Client's instructions, if any. The Company's sole responsibility is to its Client and this document does not exonerate parties to a transaction from exercising all their rights and obligations under the transaction documents. This document cannot be reproduced except in full, without prior written approval of the Company. Any unauthorized alteration, forgery or falsification of the content or appearance of this document is unlawful and offenders may be prosecuted to the fullest extent of the law.

Model No.: HSC-I001R

Mode_12_+



Mode_12_-

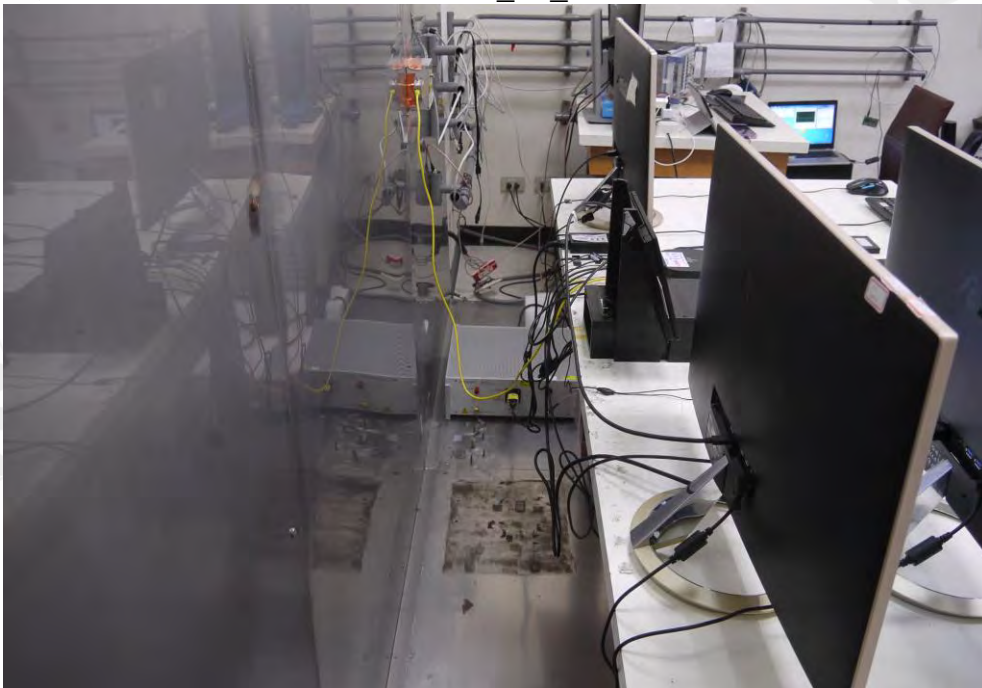

Unless otherwise stated the results shown in this test report refer only to the sample(s) tested and such sample(s) are retained for 90 days only.

除非另有說明，此報告結果僅對測試之樣品負責，同時此樣品僅保留90天。本報告未經本公司書面許可，不可部份複製。

This document is issued by the Company subject to its General Conditions of Service printed overleaf, available on request or accessible at www.sgs.com/terms_and_conditions.htm and for electronic format documents, subject to Terms and Conditions for Electronic Documents at www.sgs.com/terms_e-document.htm. Attention is drawn to the limitation of liability, indemnification and jurisdiction issues defined therein. Any holder of this document is advised that information contained hereon reflects the Company's findings at the time of its intervention only and within the limits of Client's instructions, if any. The Company's sole responsibility is to its Client and this document does not exonerate parties to a transaction from exercising all their rights and obligations under the transaction documents. This document cannot be reproduced except in full, without prior written approval of the Company. Any unauthorized alteration, forgery or falsification of the content or appearance of this document is unlawful and offenders may be prosecuted to the fullest extent of the law.

Model No.: HSC-I001R

Mode_13_+



Mode_13_-

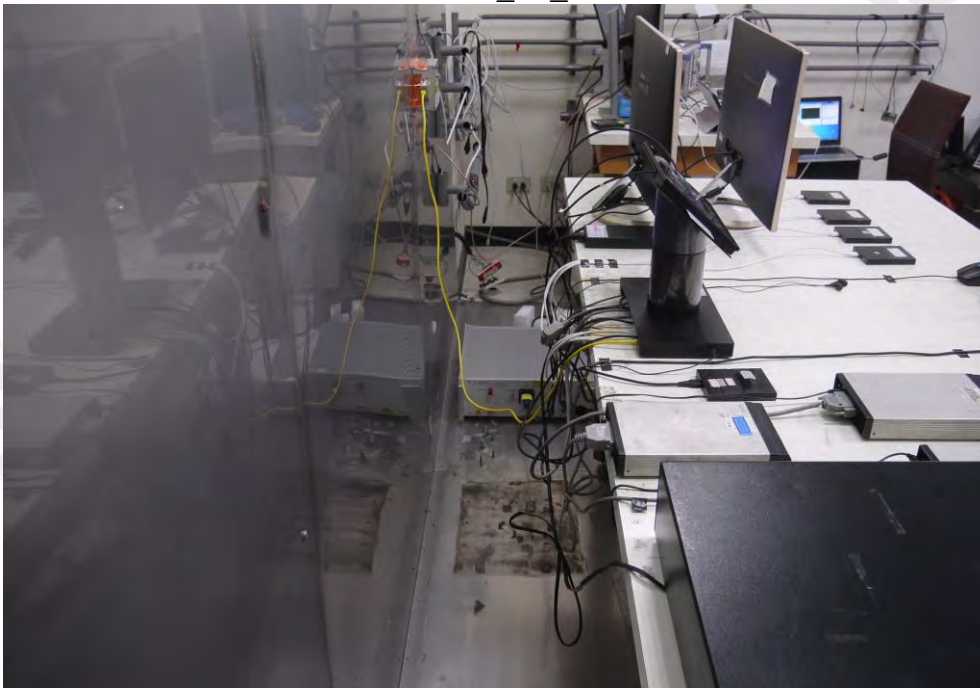

Unless otherwise stated the results shown in this test report refer only to the sample(s) tested and such sample(s) are retained for 90 days only.

除非另有說明，此報告結果僅對測試之樣品負責，同時此樣品僅保留90天。本報告未經本公司書面許可，不可部份複製。

This document is issued by the Company subject to its General Conditions of Service printed overleaf, available on request or accessible at www.sgs.com/terms_and_conditions.htm and for electronic format documents, subject to Terms and Conditions for Electronic Documents at www.sgs.com/terms_e-document.htm. Attention is drawn to the limitation of liability, indemnification and jurisdiction issues defined therein. Any holder of this document is advised that information contained hereon reflects the Company's findings at the time of its intervention only and within the limits of Client's instructions, if any. The Company's sole responsibility is to its Client and this document does not exonerate parties to a transaction from exercising all their rights and obligations under the transaction documents. This document cannot be reproduced except in full, without prior written approval of the Company. Any unauthorized alteration, forgery or falsification of the content or appearance of this document is unlawful and offenders may be prosecuted to the fullest extent of the law.

**RE Testing Set-up
Below 1GHz**

**Model No.: HSC-I001R
Mode_8_+**

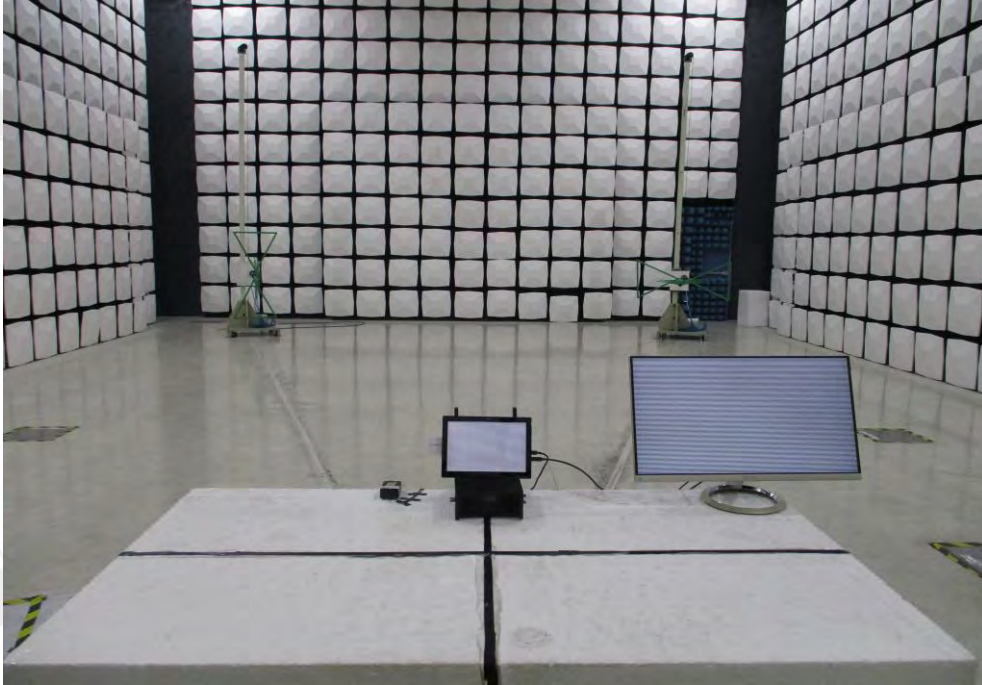

Mode_8_-

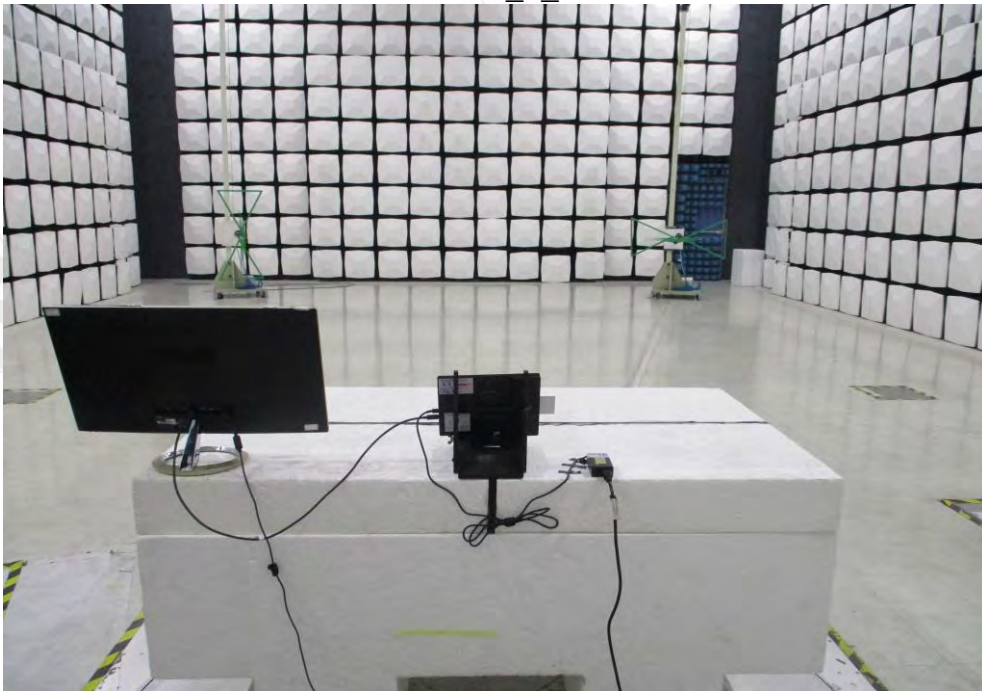

Unless otherwise stated the results shown in this test report refer only to the sample(s) tested and such sample(s) are retained for 90 days only.
除非另有說明，此報告結果僅對測試之樣品負責，同時此樣品僅保留90天。本報告未經本公司書面許可，不可部份複製。

This document is issued by the Company subject to its General Conditions of Service printed overleaf, available on request or accessible at www.sgs.com/terms_and_conditions.htm and for electronic format documents, subject to Terms and Conditions for Electronic Documents at www.sgs.com/terms_e-document.htm. Attention is drawn to the limitation of liability, indemnification and jurisdiction issues defined therein. Any holder of this document is advised that information contained hereon reflects the Company's findings at the time of its intervention only and within the limits of Client's instructions, if any. The Company's sole responsibility is to its Client and this document does not exonerate parties to a transaction from exercising all their rights and obligations under the transaction documents. This document cannot be reproduced except in full, without prior written approval of the Company. Any unauthorized alteration, forgery or falsification of the content or appearance of this document is unlawful and offenders may be prosecuted to the fullest extent of the law.

Model No.: HSC-I001R

Mode_11_+

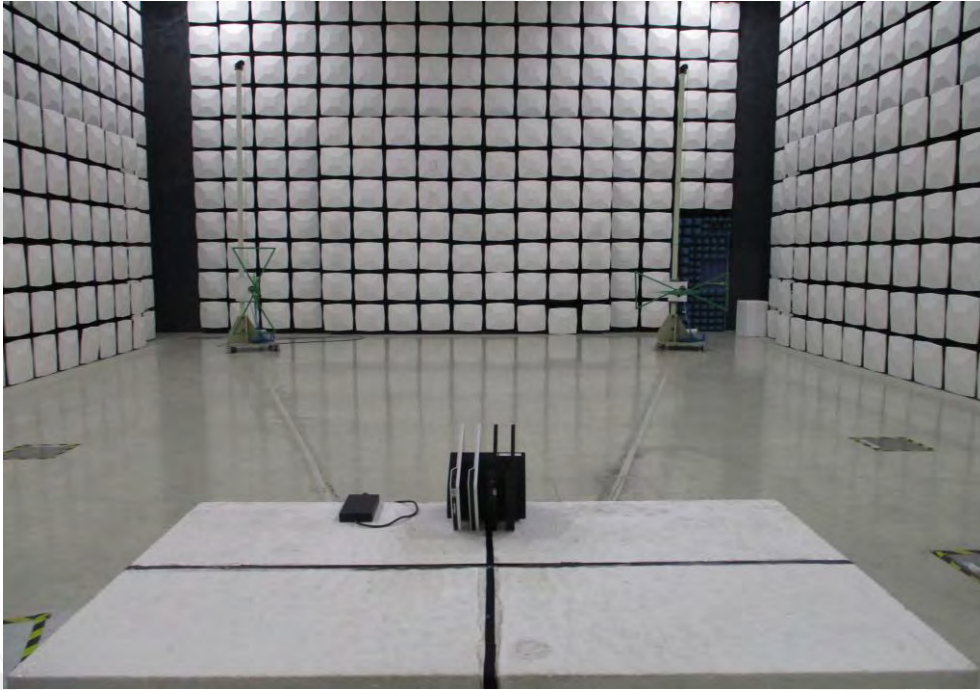

Mode_11_-

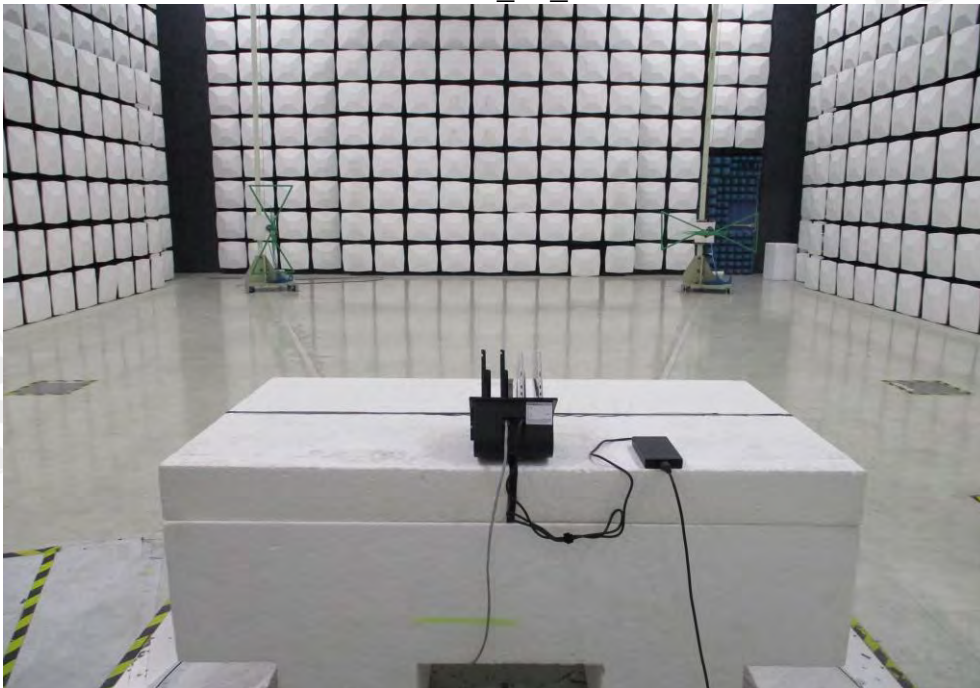

Unless otherwise stated the results shown in this test report refer only to the sample(s) tested and such sample(s) are retained for 90 days only.

除非另有說明，此報告結果僅對測試之樣品負責，同時此樣品僅保留90天。本報告未經本公司書面許可，不可部份複製。

This document is issued by the Company subject to its General Conditions of Service printed overleaf, available on request or accessible at www.sgs.com/terms_and_conditions.htm and for electronic format documents, subject to Terms and Conditions for Electronic Documents at www.sgs.com/terms_e-document.htm. Attention is drawn to the limitation of liability, indemnification and jurisdiction issues defined therein. Any holder of this document is advised that information contained hereon reflects the Company's findings at the time of its intervention only and within the limits of Client's instructions, if any. The Company's sole responsibility is to its Client and this document does not exonerate parties to a transaction from exercising all their rights and obligations under the transaction documents. This document cannot be reproduced except in full, without prior written approval of the Company. Any unauthorized alteration, forgery or falsification of the content or appearance of this document is unlawful and offenders may be prosecuted to the fullest extent of the law.

Model No.: HSC-I001R

Mode_12_+

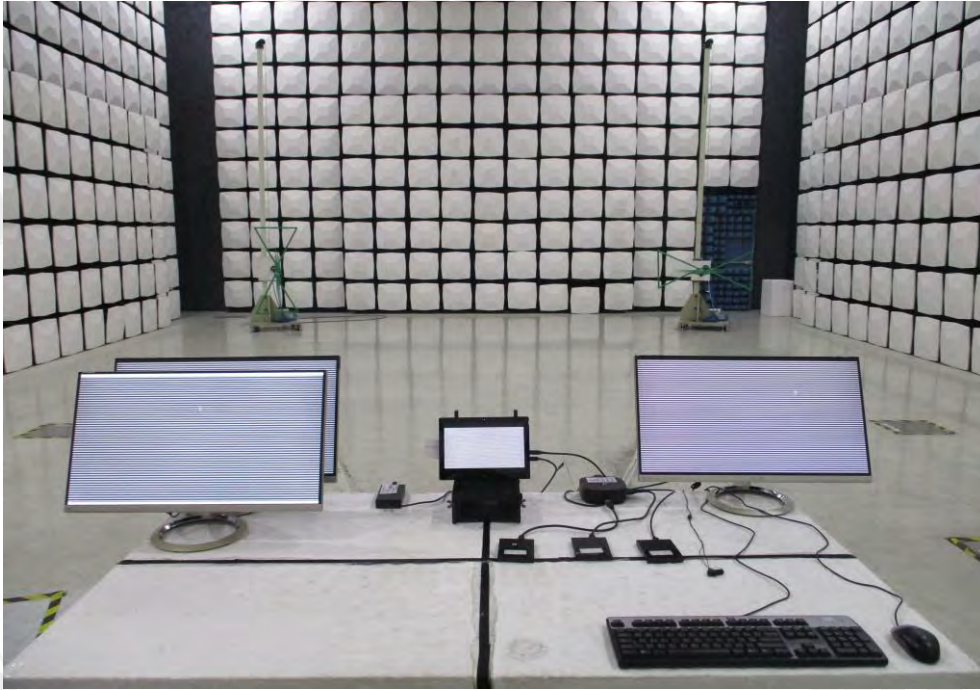

Mode_12_-



Unless otherwise stated the results shown in this test report refer only to the sample(s) tested and such sample(s) are retained for 90 days only.

除非另有說明，此報告結果僅對測試之樣品負責，同時此樣品僅保留90天。本報告未經本公司書面許可，不可部份複製。

This document is issued by the Company subject to its General Conditions of Service printed overleaf, available on request or accessible at www.sgs.com/terms_and_conditions.htm and for electronic format documents, subject to Terms and Conditions for Electronic Documents at www.sgs.com/terms_e-document.htm. Attention is drawn to the limitation of liability, indemnification and jurisdiction issues defined therein. Any holder of this document is advised that information contained hereon reflects the Company's findings at the time of its intervention only and within the limits of Client's instructions, if any. The Company's sole responsibility is to its Client and this document does not exonerate parties to a transaction from exercising all their rights and obligations under the transaction documents. This document cannot be reproduced except in full, without prior written approval of the Company. Any unauthorized alteration, forgery or falsification of the content or appearance of this document is unlawful and offenders may be prosecuted to the fullest extent of the law.

Model No.: HSC-I001R

Mode_13_+



Mode_13_-

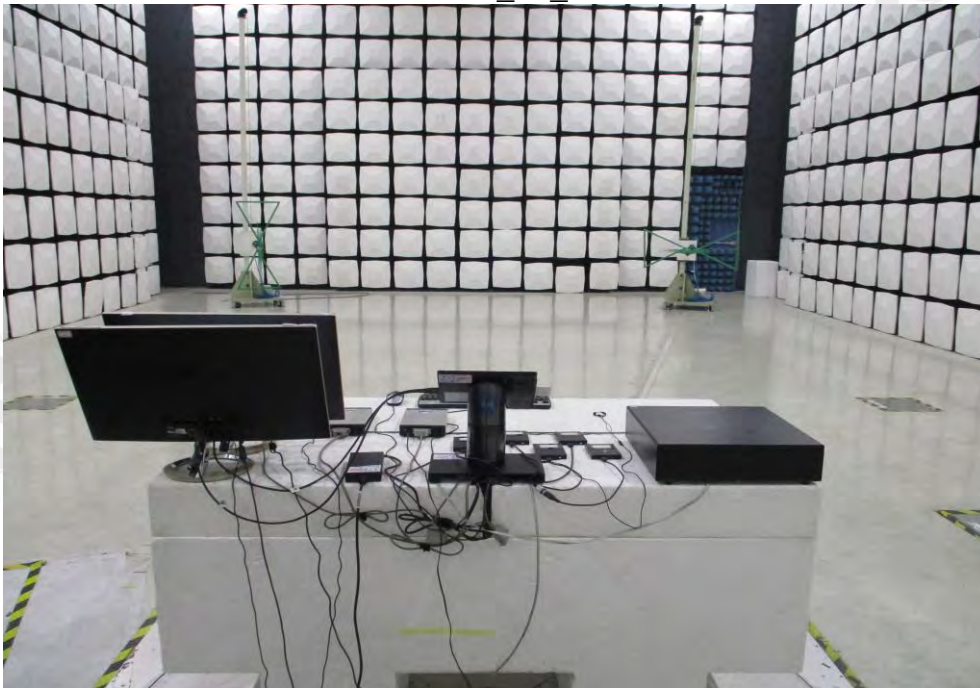

Unless otherwise stated the results shown in this test report refer only to the sample(s) tested and such sample(s) are retained for 90 days only.

除非另有說明，此報告結果僅對測試之樣品負責，同時此樣品僅保留90天。本報告未經本公司書面許可，不可部份複製。

This document is issued by the Company subject to its General Conditions of Service printed overleaf, available on request or accessible at www.sgs.com/terms_and_conditions.htm and for electronic format documents, subject to Terms and Conditions for Electronic Documents at www.sgs.com/terms_e-document.htm. Attention is drawn to the limitation of liability, indemnification and jurisdiction issues defined therein. Any holder of this document is advised that information contained hereon reflects the Company's findings at the time of its intervention only and within the limits of Client's instructions, if any. The Company's sole responsibility is to its Client and this document does not exonerate parties to a transaction from exercising all their rights and obligations under the transaction documents. This document cannot be reproduced except in full, without prior written approval of the Company. Any unauthorized alteration, forgery or falsification of the content or appearance of this document is unlawful and offenders may be prosecuted to the fullest extent of the law.

Above 1GHz

Model No.: HSC-I001R

Mode_8_+

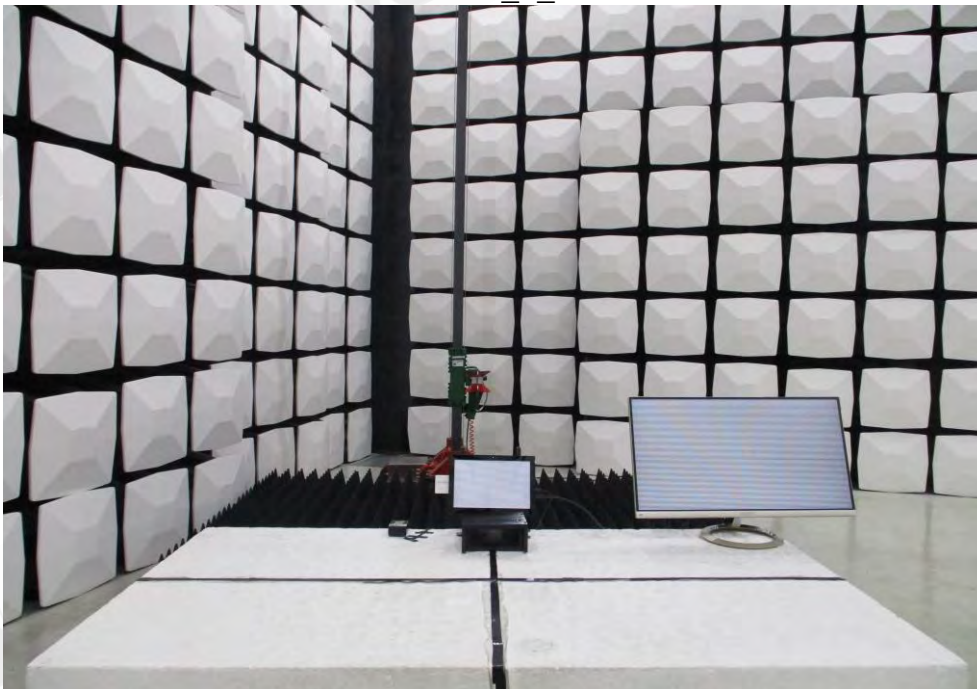

Mode 8 -

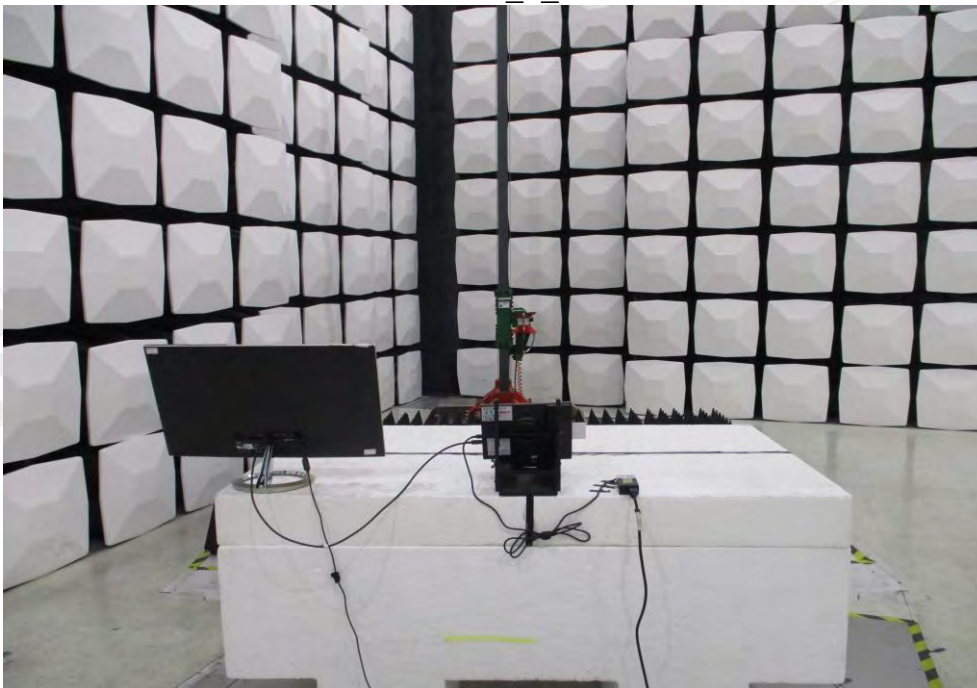

Unless otherwise stated the results shown in this test report refer only to the sample(s) tested and such sample(s) are retained for 90 days only.

除非另有說明，此報告結果僅對測試之樣品負責，同時此樣品僅保留90天。本報告未經本公司書面許可，不可部份複製。

This document is issued by the Company subject to its General Conditions of Service printed overleaf, available on request or accessible at www.sgs.com/terms_and_conditions.htm and for electronic format documents, subject to Terms and Conditions for Electronic Documents at www.sgs.com/terms_e-document.htm. Attention is drawn to the limitation of liability, indemnification and jurisdiction issues defined therein. Any holder of this document is advised that information contained hereon reflects the Company's findings at the time of its intervention only and within the limits of Client's instructions, if any. The Company's sole responsibility is to its Client and this document does not exonerate parties to a transaction from exercising all their rights and obligations under the transaction documents. This document cannot be reproduced except in full, without prior written approval of the Company. Any unauthorized alteration, forgery or falsification of the content or appearance of this document is unlawful and offenders may be prosecuted to the fullest extent of the law.

Model No.: HSC-I001R

Mode_11_+

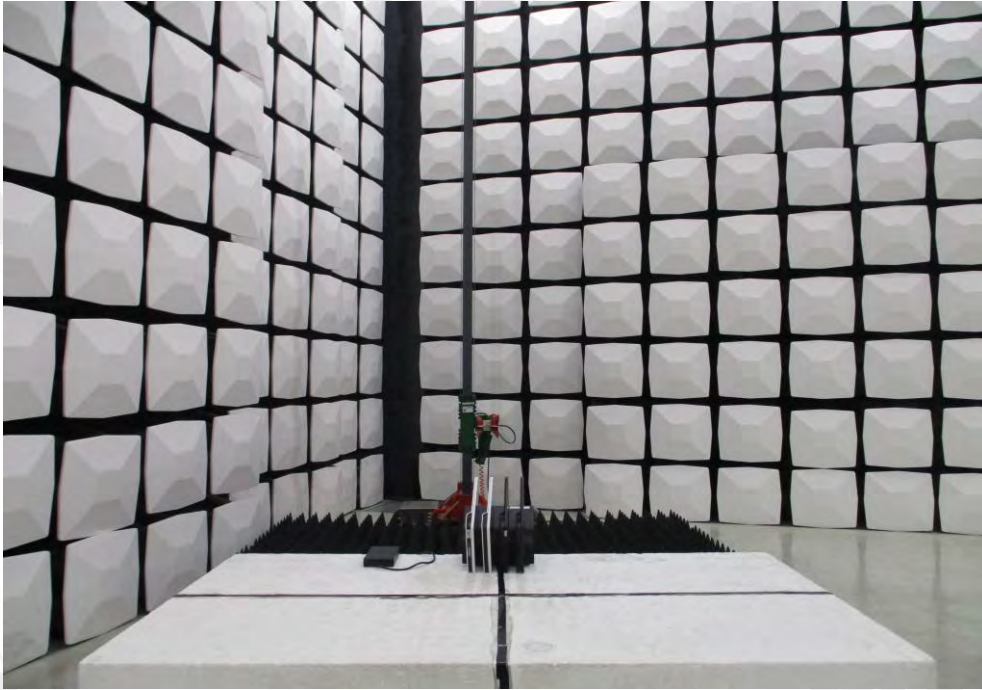

Mode_11_-

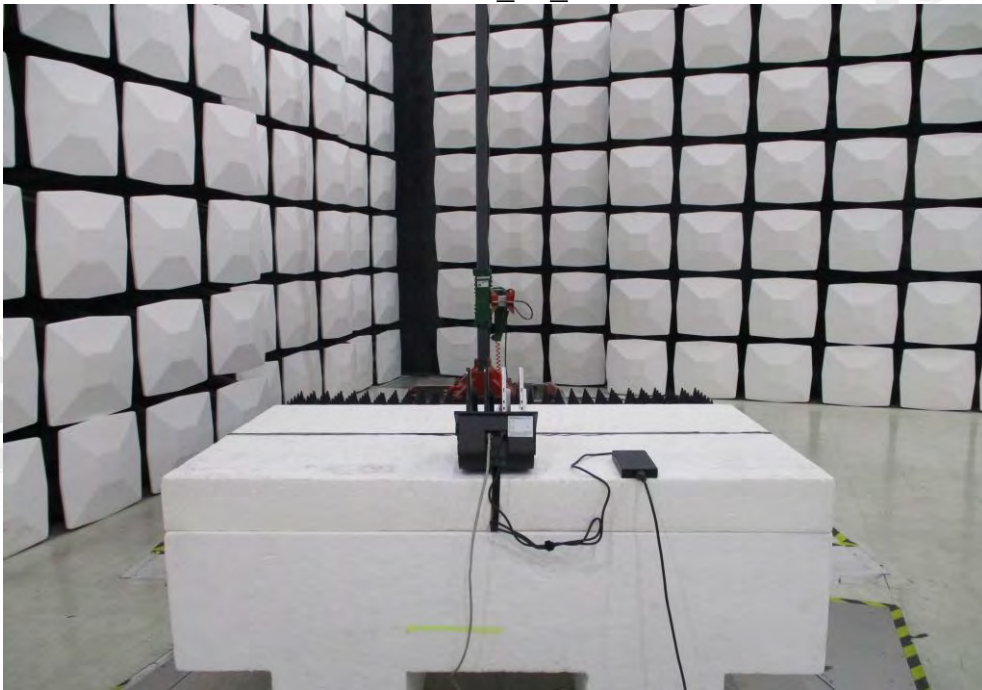

Unless otherwise stated the results shown in this test report refer only to the sample(s) tested and such sample(s) are retained for 90 days only.

除非另有說明，此報告結果僅對測試之樣品負責，同時此樣品僅保留90天。本報告未經本公司書面許可，不可部份複製。

This document is issued by the Company subject to its General Conditions of Service printed overleaf, available on request or accessible at www.sgs.com/terms_and_conditions.htm and for electronic format documents, subject to Terms and Conditions for Electronic Documents at www.sgs.com/terms_e-document.htm. Attention is drawn to the limitation of liability, indemnification and jurisdiction issues defined therein. Any holder of this document is advised that information contained hereon reflects the Company's findings at the time of its intervention only and within the limits of Client's instructions, if any. The Company's sole responsibility is to its Client and this document does not exonerate parties to a transaction from exercising all their rights and obligations under the transaction documents. This document cannot be reproduced except in full, without prior written approval of the Company. Any unauthorized alteration, forgery or falsification of the content or appearance of this document is unlawful and offenders may be prosecuted to the fullest extent of the law.

Model No.: HSC-I001R

Mode_12_+



Mode_12_-



Unless otherwise stated the results shown in this test report refer only to the sample(s) tested and such sample(s) are retained for 90 days only.

除非另有說明，此報告結果僅對測試之樣品負責，同時此樣品僅保留90天。本報告未經本公司書面許可，不可部份複製。

This document is issued by the Company subject to its General Conditions of Service printed overleaf, available on request or accessible at www.sgs.com/terms_and_conditions.htm and for electronic format documents, subject to Terms and Conditions for Electronic Documents at www.sgs.com/terms_e-document.htm. Attention is drawn to the limitation of liability, indemnification and jurisdiction issues defined therein. Any holder of this document is advised that information contained hereon reflects the Company's findings at the time of its intervention only and within the limits of Client's instructions, if any. The Company's sole responsibility is to its Client and this document does not exonerate parties to a transaction from exercising all their rights and obligations under the transaction documents. This document cannot be reproduced except in full, without prior written approval of the Company. Any unauthorized alteration, forgery or falsification of the content or appearance of this document is unlawful and offenders may be prosecuted to the fullest extent of the law.

Model No.: HSC-I001R

Mode_13_+



Mode_13_-

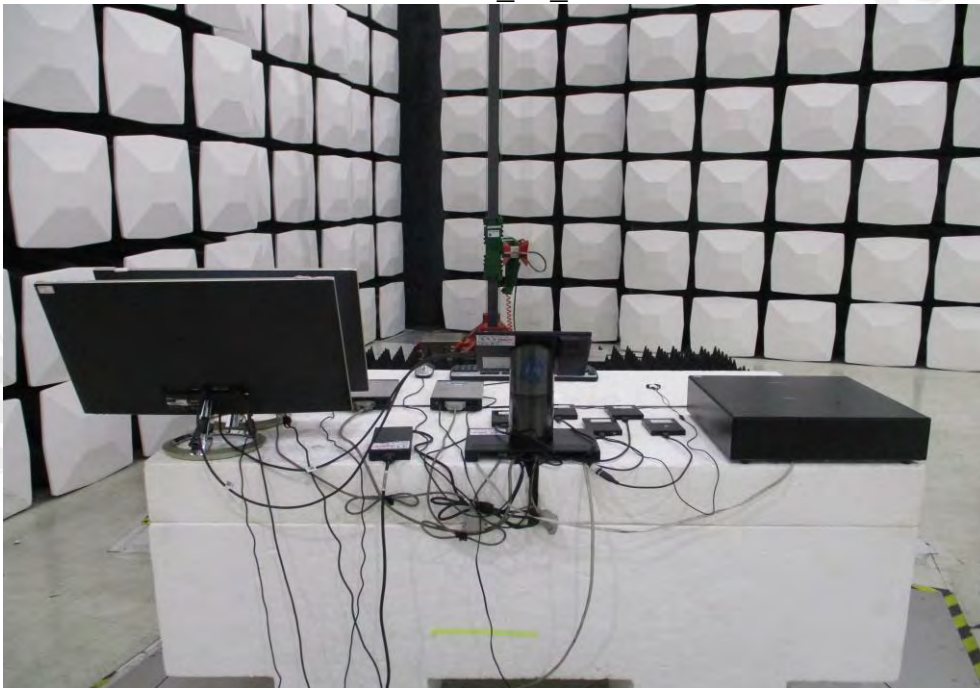

Unless otherwise stated the results shown in this test report refer only to the sample(s) tested and such sample(s) are retained for 90 days only.

除非另有說明，此報告結果僅對測試之樣品負責，同時此樣品僅保留90天。本報告未經本公司書面許可，不可部份複製。

This document is issued by the Company subject to its General Conditions of Service printed overleaf, available on request or accessible at www.sgs.com/terms_and_conditions.htm and for electronic format documents, subject to Terms and Conditions for Electronic Documents at www.sgs.com/terms_e-document.htm. Attention is drawn to the limitation of liability, indemnification and jurisdiction issues defined therein. Any holder of this document is advised that information contained hereon reflects the Company's findings at the time of its intervention only and within the limits of Client's instructions, if any. The Company's sole responsibility is to its Client and this document does not exonerate parties to a transaction from exercising all their rights and obligations under the transaction documents. This document cannot be reproduced except in full, without prior written approval of the Company. Any unauthorized alteration, forgery or falsification of the content or appearance of this document is unlawful and offenders may be prosecuted to the fullest extent of the law.

Photographs of Product Exterior

Model No.: HSC-I001R

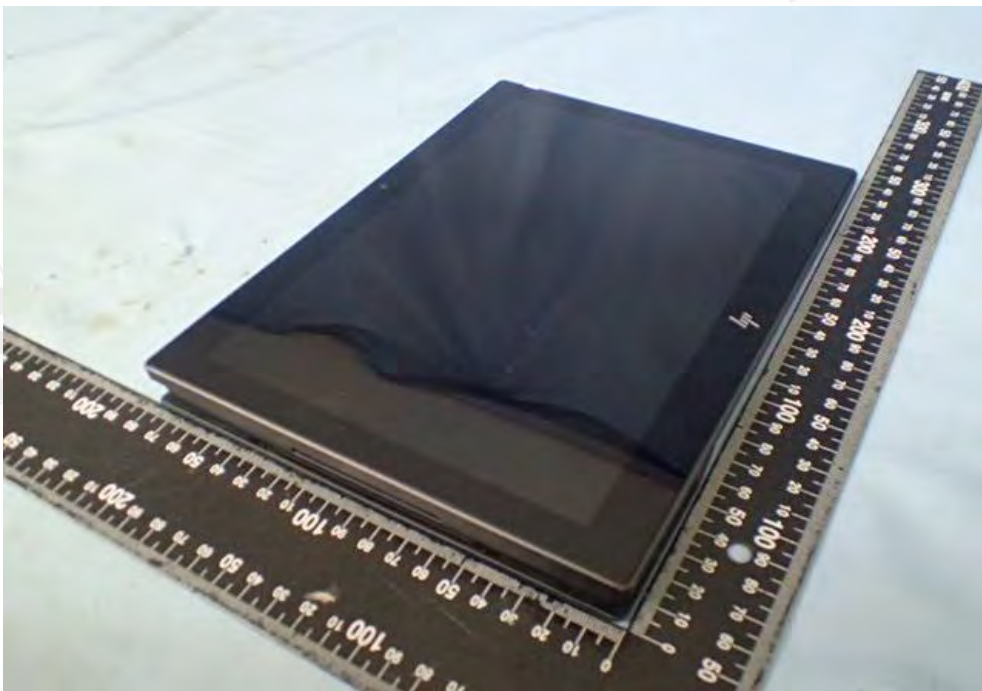
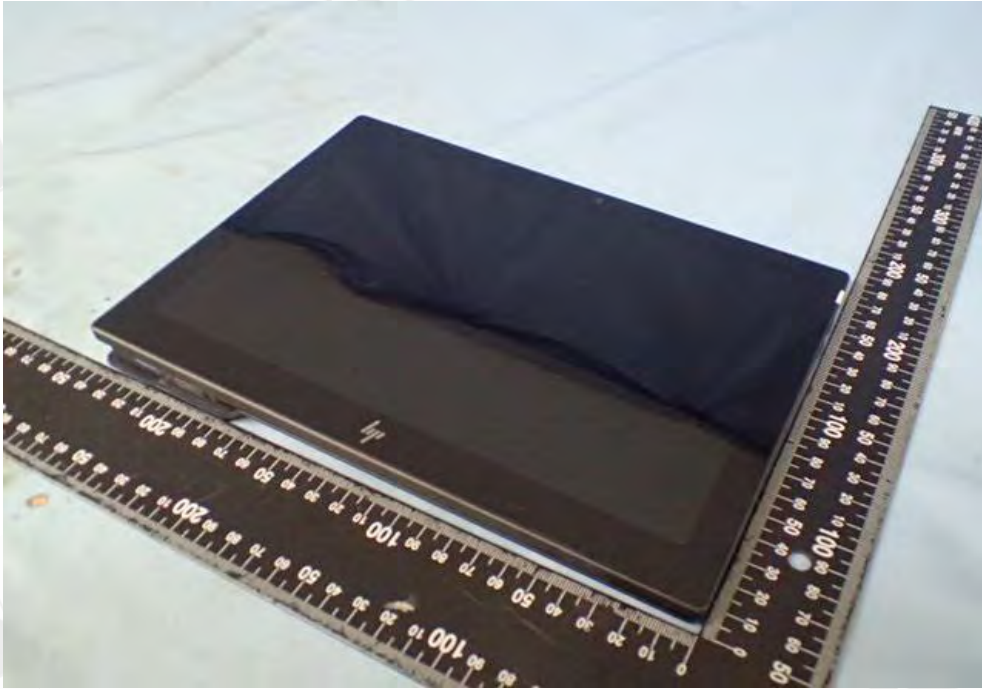

Unless otherwise stated the results shown in this test report refer only to the sample(s) tested and such sample(s) are retained for 90 days only.
除非另有說明，此報告結果僅對測試之樣品負責，同時此樣品僅保留90天。本報告未經本公司書面許可，不可部份複製。

This document is issued by the Company subject to its General Conditions of Service printed overleaf, available on request or accessible at www.sgs.com/terms_and_conditions.htm and for electronic format documents, subject to Terms and Conditions for Electronic Documents at www.sgs.com/terms_e-document.htm. Attention is drawn to the limitation of liability, indemnification and jurisdiction issues defined therein. Any holder of this document is advised that information contained herein reflects the Company's findings at the time of its intervention only and within the limits of Client's instructions, if any. The Company's sole responsibility is to its Client and this document does not exonerate parties to a transaction from exercising all their rights and obligations under the transaction documents. This document cannot be reproduced except in full, without prior written approval of the Company. Any unauthorized alteration, forgery or falsification of the content or appearance of this document is unlawful and offenders may be prosecuted to the fullest extent of the law.



Unless otherwise stated the results shown in this test report refer only to the sample(s) tested and such sample(s) are retained for 90 days only.
除非另有說明，此報告結果僅對測試之樣品負責，同時此樣品僅保留90天。本報告未經本公司書面許可，不可部份複製。

This document is issued by the Company subject to its General Conditions of Service printed overleaf, available on request or accessible at www.sgs.com/terms_and_conditions.htm and for electronic format documents, subject to Terms and Conditions for Electronic Documents at www.sgs.com/terms_e-document.htm. Attention is drawn to the limitation of liability, indemnification and jurisdiction issues defined therein. Any holder of this document is advised that information contained herein reflects the Company's findings at the time of its intervention only and within the limits of Client's instructions, if any. The Company's sole responsibility is to its Client and this document does not exonerate parties to a transaction from exercising all their rights and obligations under the transaction documents. This document cannot be reproduced except in full, without prior written approval of the Company. Any unauthorized alteration, forgery or falsification of the content or appearance of this document is unlawful and offenders may be prosecuted to the fullest extent of the law.



Unless otherwise stated the results shown in this test report refer only to the sample(s) tested and such sample(s) are retained for 90 days only.
除非另有說明，此報告結果僅對測試之樣品負責。同時此樣品僅保留90天。本報告未經本公司書面許可，不可部份複製。

This document is issued by the Company subject to its General Conditions of Service printed overleaf, available on request or accessible at www.sgs.com/terms_and_conditions.htm and for electronic format documents, subject to Terms and Conditions for Electronic Documents at www.sgs.com/terms_e-document.htm. Attention is drawn to the limitation of liability, indemnification and jurisdiction issues defined therein. Any holder of this document is advised that information contained hereon reflects the Company's findings at the time of its intervention only and within the limits of Client's instructions, if any. The Company's sole responsibility is to its Client and this document does not exonerate parties to a transaction from exercising all their rights and obligations under the transaction documents. This document cannot be reproduced except in full, without prior written approval of the Company. Any unauthorized alteration, forgery or falsification of the content or appearance of this document is unlawful and offenders may be prosecuted to the fullest extent of the law.



Unless otherwise stated the results shown in this test report refer only to the sample(s) tested and such sample(s) are retained for 90 days only.

除非另有說明，此報告結果僅對測試之樣品負責，同時此樣品僅保留90天。本報告未經本公司書面許可，不可部份複製。

This document is issued by the Company subject to its General Conditions of Service printed overleaf, available on request or accessible at www.sgs.com/terms_and_conditions.htm and for electronic format documents, subject to Terms and Conditions for Electronic Documents at www.sgs.com/terms_e-document.htm. Attention is drawn to the limitation of liability, indemnification and jurisdiction issues defined therein. Any holder of this document is advised that information contained hereon reflects the Company's findings at the time of its intervention only and within the limits of Client's instructions, if any. The Company's sole responsibility is to its Client and this document does not exonerate parties to a transaction from exercising all their rights and obligations under the transaction documents. This document cannot be reproduced except in full, without prior written approval of the Company. Any unauthorized alteration, forgery or falsification of the content or appearance of this document is unlawful and offenders may be prosecuted to the fullest extent of the law.



Unless otherwise stated the results shown in this test report refer only to the sample(s) tested and such sample(s) are retained for 90 days only.

除非另有說明，此報告結果僅對測試之樣品負責，同時此樣品僅保留90天。本報告未經本公司書面許可，不可部份複製。

This document is issued by the Company subject to its General Conditions of Service printed overleaf, available on request or accessible at www.sgs.com/terms_and_conditions.htm and for electronic format documents, subject to Terms and Conditions for Electronic Documents at www.sgs.com/terms_e-document.htm. Attention is drawn to the limitation of liability, indemnification and jurisdiction issues defined therein. Any holder of this document is advised that information contained hereon reflects the Company's findings at the time of its intervention only and within the limits of Client's instructions, if any. The Company's sole responsibility is to its Client and this document does not exonerate parties to a transaction from exercising all their rights and obligations under the transaction documents. This document cannot be reproduced except in full, without prior written approval of the Company. Any unauthorized alteration, forgery or falsification of the content or appearance of this document is unlawful and offenders may be prosecuted to the fullest extent of the law.

Adapter Model No.: TPN-CA21



Unless otherwise stated the results shown in this test report refer only to the sample(s) tested and such sample(s) are retained for 90 days only.
除非另有說明，此報告結果僅對測試之樣品負責，同時此樣品僅保留90天。本報告未經本公司書面許可，不可部份複製。

This document is issued by the Company subject to its General Conditions of Service printed overleaf, available on request or accessible at www.sgs.com/terms_and_conditions.htm and for electronic format documents, subject to Terms and Conditions for Electronic Documents at www.sgs.com/terms_e-document.htm. Attention is drawn to the limitation of liability, indemnification and jurisdiction issues defined therein. Any holder of this document is advised that information contained hereon reflects the Company's findings at the time of its intervention only and within the limits of Client's instructions, if any. The Company's sole responsibility is to its Client and this document does not exonerate parties to a transaction from exercising all their rights and obligations under the transaction documents. This document cannot be reproduced except in full, without prior written approval of the Company. Any unauthorized alteration, forgery or falsification of the content or appearance of this document is unlawful and offenders may be prosecuted to the fullest extent of the law.



Unless otherwise stated the results shown in this test report refer only to the sample(s) tested and such sample(s) are retained for 90 days only.

除非另有說明，此報告結果僅對測試之樣品負責，同時此樣品僅保留90天。本報告未經本公司書面許可，不可部份複製。

This document is issued by the Company subject to its General Conditions of Service printed overleaf, available on request or accessible at www.sgs.com/terms_and_conditions.htm and for electronic format documents, subject to Terms and Conditions for Electronic Documents at www.sgs.com/terms_e-document.htm. Attention is drawn to the limitation of liability, indemnification and jurisdiction issues defined therein. Any holder of this document is advised that information contained hereon reflects the Company's findings at the time of its intervention only and within the limits of Client's instructions, if any. The Company's sole responsibility is to its Client and this document does not exonerate parties to a transaction from exercising all their rights and obligations under the transaction documents. This document cannot be reproduced except in full, without prior written approval of the Company. Any unauthorized alteration, forgery or falsification of the content or appearance of this document is unlawful and offenders may be prosecuted to the fullest extent of the law.

Adapter Model No.: TPN-DA20



Unless otherwise stated the results shown in this test report refer only to the sample(s) tested and such sample(s) are retained for 90 days only.

除非另有說明，此報告結果僅對測試之樣品負責，同時此樣品僅保留90天。本報告未經本公司書面許可，不可部份複製。

This document is issued by the Company subject to its General Conditions of Service printed overleaf, available on request or accessible at www.sgs.com/terms_and_conditions.htm and for electronic format documents, subject to Terms and Conditions for Electronic Documents at www.sgs.com/terms_e-document.htm. Attention is drawn to the limitation of liability, indemnification and jurisdiction issues defined therein. Any holder of this document is advised that information contained herein reflects the Company's findings at the time of its intervention only and within the limits of Client's instructions, if any. The Company's sole responsibility is to its Client and this document does not exonerate parties to a transaction from exercising all their rights and obligations under the transaction documents. This document cannot be reproduced except in full, without prior written approval of the Company. Any unauthorized alteration, forgery or falsification of the content or appearance of this document is unlawful and offenders may be prosecuted to the fullest extent of the law.



Unless otherwise stated the results shown in this test report refer only to the sample(s) tested and such sample(s) are retained for 90 days only.
除非另有說明，此報告結果僅對測試之樣品負責，同時此樣品僅保留90天。本報告未經本公司書面許可，不可部份複製。

This document is issued by the Company subject to its General Conditions of Service printed overleaf, available on request or accessible at www.sgs.com/terms_and_conditions.htm and for electronic format documents, subject to Terms and Conditions for Electronic Documents at www.sgs.com/terms_e-document.htm. Attention is drawn to the limitation of liability, indemnification and jurisdiction issues defined therein. Any holder of this document is advised that information contained hereon reflects the Company's findings at the time of its intervention only and within the limits of Client's instructions, if any. The Company's sole responsibility is to its Client and this document does not exonerate parties to a transaction from exercising all their rights and obligations under the transaction documents. This document cannot be reproduced except in full, without prior written approval of the Company. Any unauthorized alteration, forgery or falsification of the content or appearance of this document is unlawful and offenders may be prosecuted to the fullest extent of the law.

Adapter Model No.: TPN-HA01



Unless otherwise stated the results shown in this test report refer only to the sample(s) tested and such sample(s) are retained for 90 days only.
除非另有說明，此報告結果僅對測試之樣品負責，同時此樣品僅保留90天。本報告未經本公司書面許可，不可部份複製。

This document is issued by the Company subject to its General Conditions of Service printed overleaf, available on request or accessible at www.sgs.com/terms_and_conditions.htm and for electronic format documents, subject to Terms and Conditions for Electronic Documents at www.sgs.com/terms_e-document.htm. Attention is drawn to the limitation of liability, indemnification and jurisdiction issues defined therein. Any holder of this document is advised that information contained hereon reflects the Company's findings at the time of its intervention only and within the limits of Client's instructions, if any. The Company's sole responsibility is to its Client and this document does not exonerate parties to a transaction from exercising all their rights and obligations under the transaction documents. This document cannot be reproduced except in full, without prior written approval of the Company. Any unauthorized alteration, forgery or falsification of the content or appearance of this document is unlawful and offenders may be prosecuted to the fullest extent of the law.



Unless otherwise stated the results shown in this test report refer only to the sample(s) tested and such sample(s) are retained for 90 days only.

除非另有說明，此報告結果僅對測試之樣品負責，同時此樣品僅保留90天。本報告未經本公司書面許可，不可部份複製。

This document is issued by the Company subject to its General Conditions of Service printed overleaf, available on request or accessible at www.sgs.com/terms_and_conditions.htm and for electronic format documents, subject to Terms and Conditions for Electronic Documents at www.sgs.com/terms_e-document.htm. Attention is drawn to the limitation of liability, indemnification and jurisdiction issues defined therein. Any holder of this document is advised that information contained hereon reflects the Company's findings at the time of its intervention only and within the limits of Client's instructions, if any. The Company's sole responsibility is to its Client and this document does not exonerate parties to a transaction from exercising all their rights and obligations under the transaction documents. This document cannot be reproduced except in full, without prior written approval of the Company. Any unauthorized alteration, forgery or falsification of the content or appearance of this document is unlawful and offenders may be prosecuted to the fullest extent of the law.

HP Engage Go 10 Multi-Charger Model No.: HSC-I002D

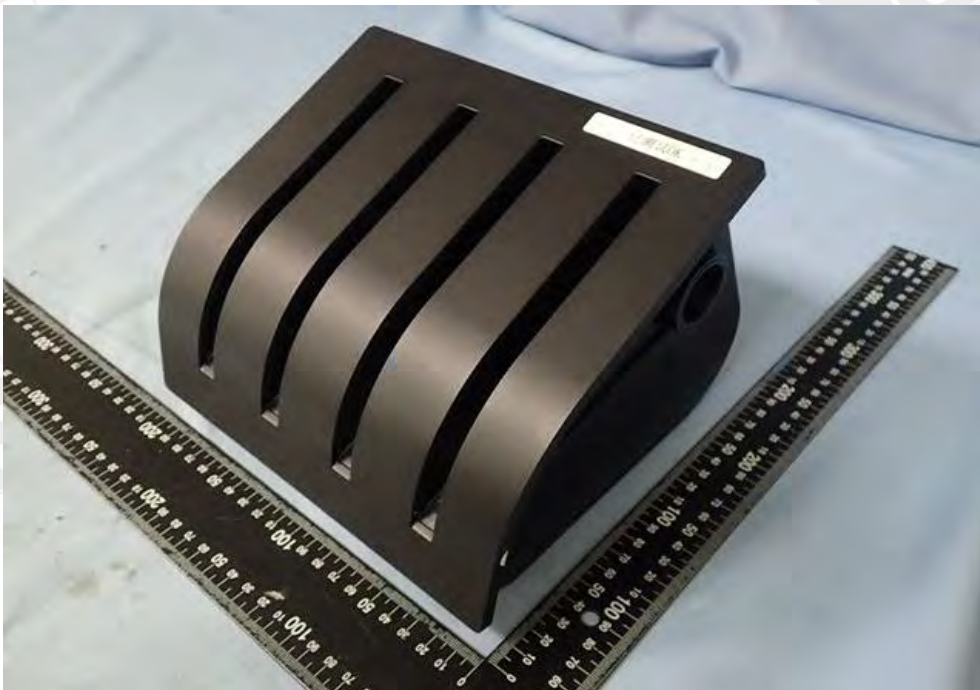

Unless otherwise stated the results shown in this test report refer only to the sample(s) tested and such sample(s) are retained for 90 days only.
除非另有說明，此報告結果僅對測試之樣品負責，同時此樣品僅保留90天。本報告未經本公司書面許可，不可部份複製。

This document is issued by the Company subject to its General Conditions of Service printed overleaf, available on request or accessible at www.sgs.com/terms_and_conditions.htm and for electronic format documents, subject to Terms and Conditions for Electronic Documents at www.sgs.com/terms_e-document.htm. Attention is drawn to the limitation of liability, indemnification and jurisdiction issues defined therein. Any holder of this document is advised that information contained hereon reflects the Company's findings at the time of its intervention only and within the limits of Client's instructions, if any. The Company's sole responsibility is to its Client and this document does not exonerate parties to a transaction from exercising all their rights and obligations under the transaction documents. This document cannot be reproduced except in full, without prior written approval of the Company. Any unauthorized alteration, forgery or falsification of the content or appearance of this document is unlawful and offenders may be prosecuted to the fullest extent of the law.

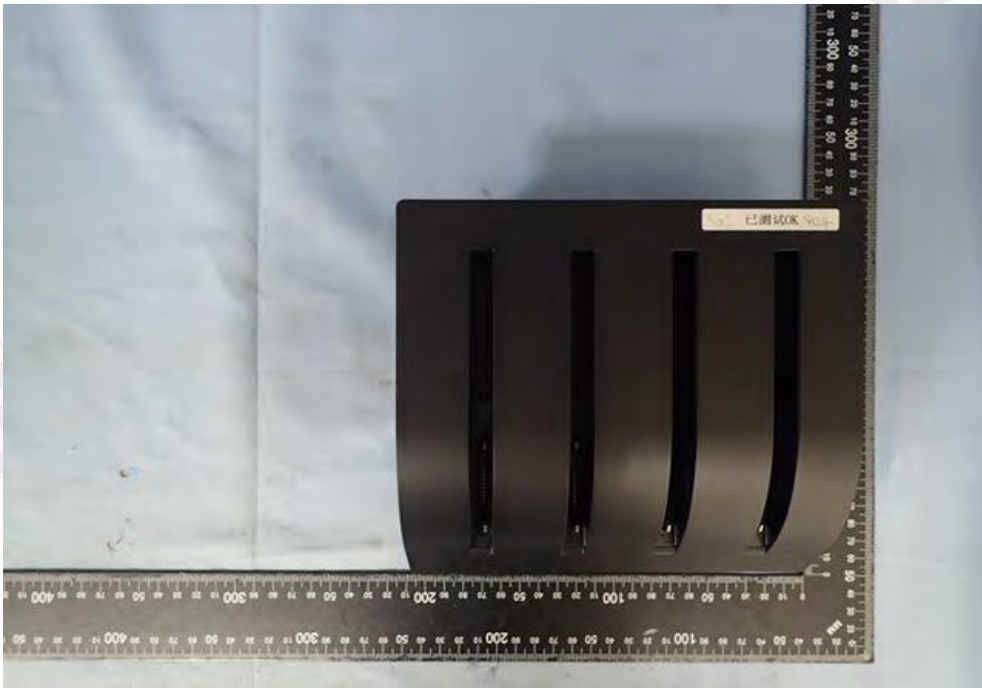
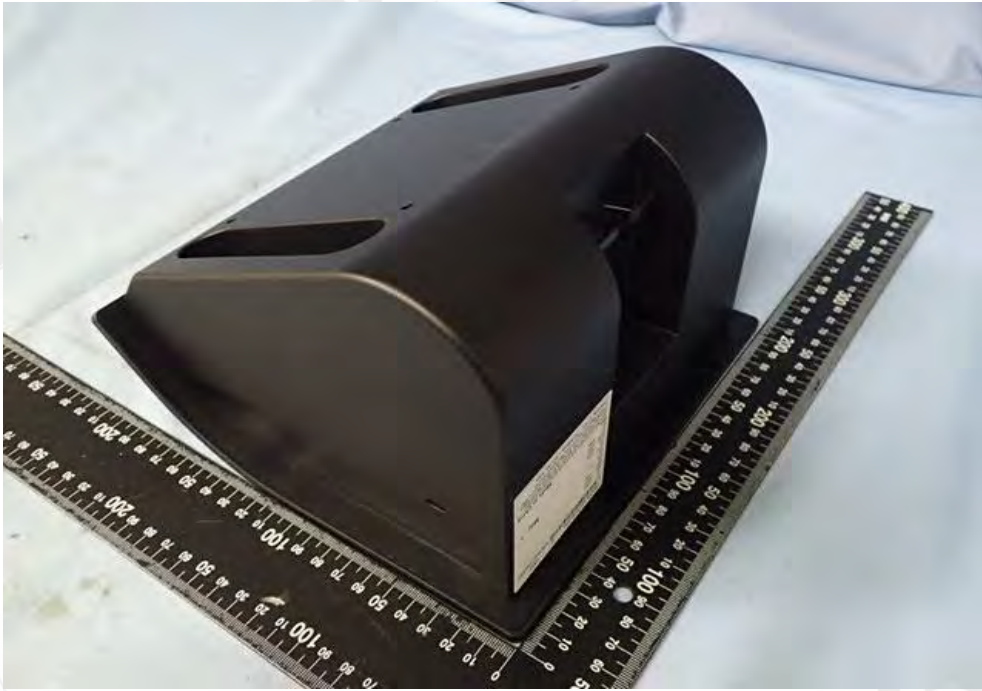

Unless otherwise stated the results shown in this test report refer only to the sample(s) tested and such sample(s) are retained for 90 days only.
除非另有說明，此報告結果僅對測試之樣品負責，同時此樣品僅保留90天。本報告未經本公司書面許可，不可部份複製。

This document is issued by the Company subject to its General Conditions of Service printed overleaf, available on request or accessible at www.sgs.com/terms_and_conditions.htm and for electronic format documents, subject to Terms and Conditions for Electronic Documents at www.sgs.com/terms_e-document.htm. Attention is drawn to the limitation of liability, indemnification and jurisdiction issues defined therein. Any holder of this document is advised that information contained hereon reflects the Company's findings at the time of its intervention only and within the limits of Client's instructions, if any. The Company's sole responsibility is to its Client and this document does not exonerate parties to a transaction from exercising all their rights and obligations under the transaction documents. This document cannot be reproduced except in full, without prior written approval of the Company. Any unauthorized alteration, forgery or falsification of the content or appearance of this document is unlawful and offenders may be prosecuted to the fullest extent of the law.

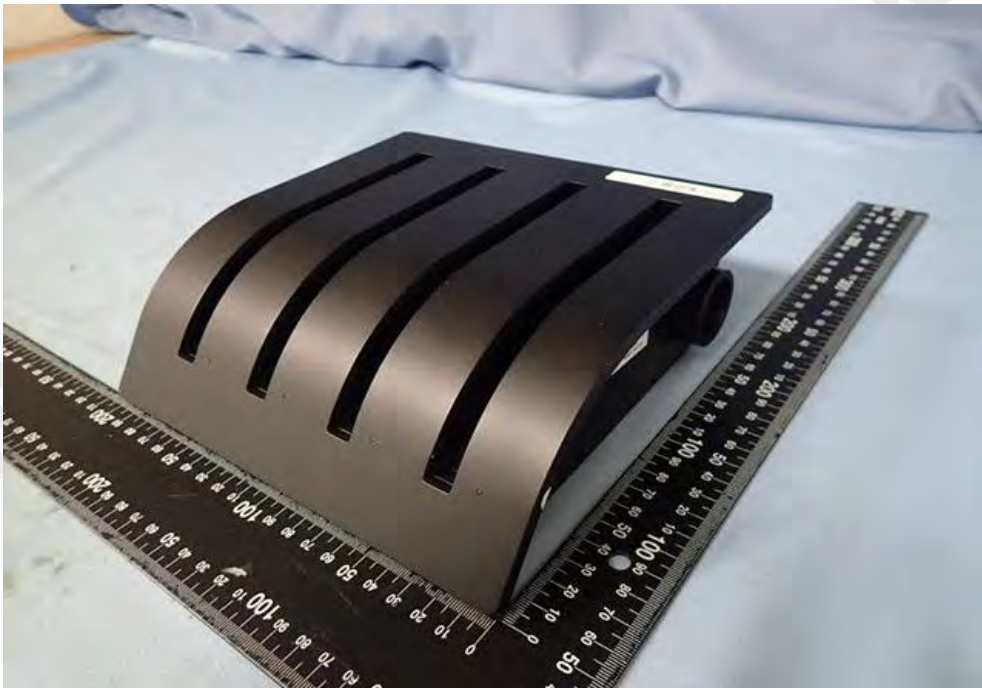

Unless otherwise stated the results shown in this test report refer only to the sample(s) tested and such sample(s) are retained for 90 days only.
除非另有說明，此報告結果僅對測試之樣品負責，同時此樣品僅保留90天。本報告未經本公司書面許可，不可部份複製。

This document is issued by the Company subject to its General Conditions of Service printed overleaf, available on request or accessible at www.sgs.com/terms_and_conditions.htm and for electronic format documents, subject to Terms and Conditions for Electronic Documents at www.sgs.com/terms_e-document.htm. Attention is drawn to the limitation of liability, indemnification and jurisdiction issues defined therein. Any holder of this document is advised that information contained herein reflects the Company's findings at the time of its intervention only and within the limits of Client's instructions, if any. The Company's sole responsibility is to its Client and this document does not exonerate parties to a transaction from exercising all their rights and obligations under the transaction documents. This document cannot be reproduced except in full, without prior written approval of the Company. Any unauthorized alteration, forgery or falsification of the content or appearance of this document is unlawful and offenders may be prosecuted to the fullest extent of the law.



Unless otherwise stated the results shown in this test report refer only to the sample(s) tested and such sample(s) are retained for 90 days only.
除非另有說明，此報告結果僅對測試之樣品負責，同時此樣品僅保留90天。本報告未經本公司書面許可，不可部份複製。

This document is issued by the Company subject to its General Conditions of Service printed overleaf, available on request or accessible at www.sgs.com/terms_and_conditions.htm and for electronic format documents, subject to Terms and Conditions for Electronic Documents at www.sgs.com/terms_e-document.htm. Attention is drawn to the limitation of liability, indemnification and jurisdiction issues defined therein. Any holder of this document is advised that information contained hereon reflects the Company's findings at the time of its intervention only and within the limits of Client's instructions, if any. The Company's sole responsibility is to its Client and this document does not exonerate parties to a transaction from exercising all their rights and obligations under the transaction documents. This document cannot be reproduced except in full, without prior written approval of the Company. Any unauthorized alteration, forgery or falsification of the content or appearance of this document is unlawful and offenders may be prosecuted to the fullest extent of the law.



Unless otherwise stated the results shown in this test report refer only to the sample(s) tested and such sample(s) are retained for 90 days only.

除非另有說明，此報告結果僅對測試之樣品負責，同時此樣品僅保留90天。本報告未經本公司書面許可，不可部份複製。

This document is issued by the Company subject to its General Conditions of Service printed overleaf, available on request or accessible at www.sgs.com/terms_and_conditions.htm and for electronic format documents, subject to Terms and Conditions for Electronic Documents at www.sgs.com/terms_e-document.htm. Attention is drawn to the limitation of liability, indemnification and jurisdiction issues defined therein. Any holder of this document is advised that information contained hereon reflects the Company's findings at the time of its intervention only and within the limits of Client's instructions, if any. The Company's sole responsibility is to its Client and this document does not exonerate parties to a transaction from exercising all their rights and obligations under the transaction documents. This document cannot be reproduced except in full, without prior written approval of the Company. Any unauthorized alteration, forgery or falsification of the content or appearance of this document is unlawful and offenders may be prosecuted to the fullest extent of the law.



Unless otherwise stated the results shown in this test report refer only to the sample(s) tested and such sample(s) are retained for 90 days only.

除非另有說明，此報告結果僅對測試之樣品負責，同時此樣品僅保留90天。本報告未經本公司書面許可，不可部份複製。

This document is issued by the Company subject to its General Conditions of Service printed overleaf, available on request or accessible at www.sgs.com/terms_and_conditions.htm and for electronic format documents, subject to Terms and Conditions for Electronic Documents at www.sgs.com/terms_e-document.htm. Attention is drawn to the limitation of liability, indemnification and jurisdiction issues defined therein. Any holder of this document is advised that information contained hereon reflects the Company's findings at the time of its intervention only and within the limits of Client's instructions, if any. The Company's sole responsibility is to its Client and this document does not exonerate parties to a transaction from exercising all their rights and obligations under the transaction documents. This document cannot be reproduced except in full, without prior written approval of the Company. Any unauthorized alteration, forgery or falsification of the content or appearance of this document is unlawful and offenders may be prosecuted to the fullest extent of the law.

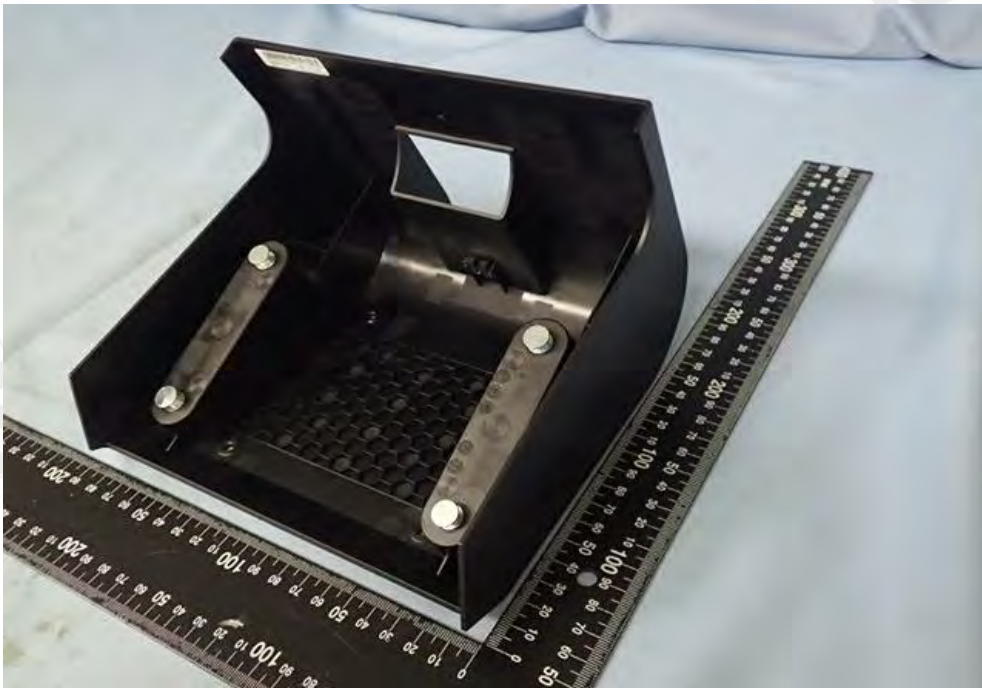
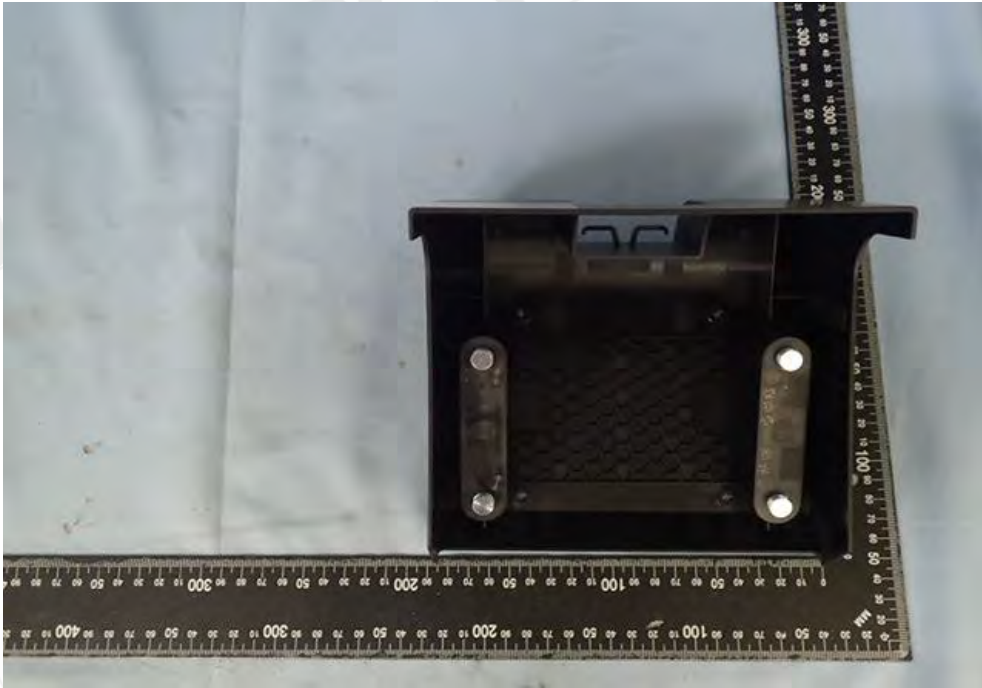

Unless otherwise stated the results shown in this test report refer only to the sample(s) tested and such sample(s) are retained for 90 days only.

除非另有說明，此報告結果僅對測試之樣品負責，同時此樣品僅保留90天。本報告未經本公司書面許可，不可部份複製。

This document is issued by the Company subject to its General Conditions of Service printed overleaf, available on request or accessible at www.sgs.com/terms_and_conditions.htm and for electronic format documents, subject to Terms and Conditions for Electronic Documents at www.sgs.com/terms_e-document.htm. Attention is drawn to the limitation of liability, indemnification and jurisdiction issues defined therein. Any holder of this document is advised that information contained hereon reflects the Company's findings at the time of its intervention only and within the limits of Client's instructions, if any. The Company's sole responsibility is to its Client and this document does not exonerate parties to a transaction from exercising all their rights and obligations under the transaction documents. This document cannot be reproduced except in full, without prior written approval of the Company. Any unauthorized alteration, forgery or falsification of the content or appearance of this document is unlawful and offenders may be prosecuted to the fullest extent of the law.



Unless otherwise stated the results shown in this test report refer only to the sample(s) tested and such sample(s) are retained for 90 days only.

除非另有說明，此報告結果僅對測試之樣品負責，同時此樣品僅保留90天。本報告未經本公司書面許可，不可部份複製。

This document is issued by the Company subject to its General Conditions of Service printed overleaf, available on request or accessible at www.sgs.com/terms_and_conditions.htm and for electronic format documents, subject to Terms and Conditions for Electronic Documents at www.sgs.com/terms_e-document.htm. Attention is drawn to the limitation of liability, indemnification and jurisdiction issues defined therein. Any holder of this document is advised that information contained hereon reflects the Company's findings at the time of its intervention only and within the limits of Client's instructions, if any. The Company's sole responsibility is to its Client and this document does not exonerate parties to a transaction from exercising all their rights and obligations under the transaction documents. This document cannot be reproduced except in full, without prior written approval of the Company. Any unauthorized alteration, forgery or falsification of the content or appearance of this document is unlawful and offenders may be prosecuted to the fullest extent of the law.

Dock Model No.: HSN-I001D
HP ElitePOS Retail Basic I/O Connectivity Base Model No.: TPC-I026-D

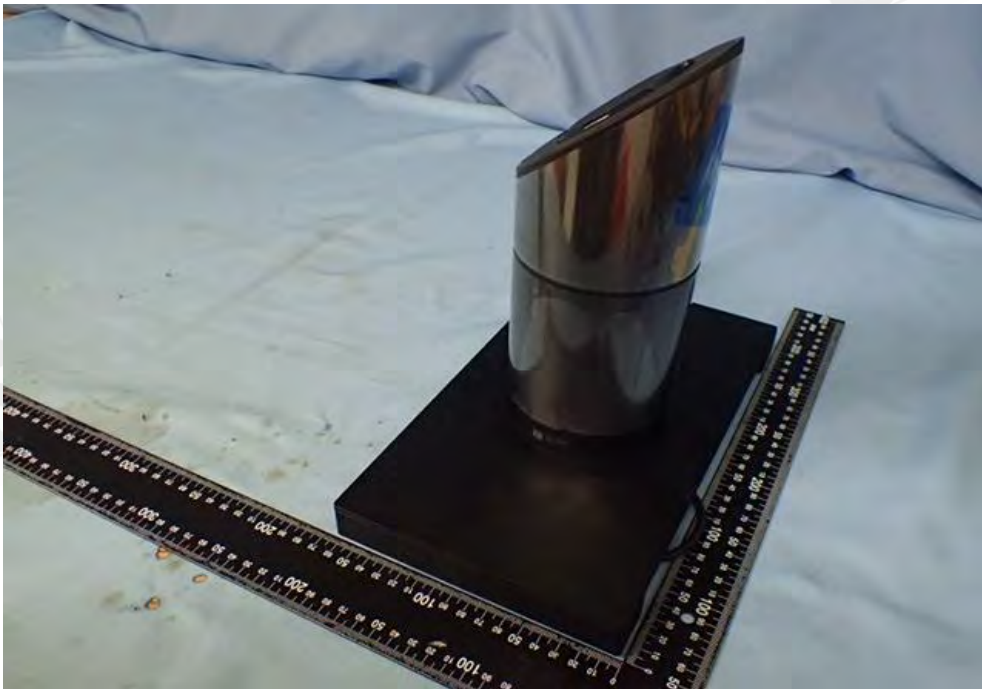

Unless otherwise stated the results shown in this test report refer only to the sample(s) tested and such sample(s) are retained for 90 days only.
除非另有說明，此報告結果僅對測試之樣品負責，同時此樣品僅保留90天。本報告未經本公司書面許可，不可部份複製。

This document is issued by the Company subject to its General Conditions of Service printed overleaf, available on request or accessible at www.sgs.com/terms_and_conditions.htm and for electronic format documents, subject to Terms and Conditions for Electronic Documents at www.sgs.com/terms_e-document.htm. Attention is drawn to the limitation of liability, indemnification and jurisdiction issues defined therein. Any holder of this document is advised that information contained hereon reflects the Company's findings at the time of its intervention only and within the limits of Client's instructions, if any. The Company's sole responsibility is to its Client and this document does not exonerate parties to a transaction from exercising all their rights and obligations under the transaction documents. This document cannot be reproduced except in full, without prior written approval of the Company. Any unauthorized alteration, forgery or falsification of the content or appearance of this document is unlawful and offenders may be prosecuted to the fullest extent of the law.



Unless otherwise stated the results shown in this test report refer only to the sample(s) tested and such sample(s) are retained for 90 days only.
除非另有說明，此報告結果僅對測試之樣品負責，同時此樣品僅保留90天。本報告未經本公司書面許可，不可部份複製。

This document is issued by the Company subject to its General Conditions of Service printed overleaf, available on request or accessible at www.sgs.com/terms_and_conditions.htm and for electronic format documents, subject to Terms and Conditions for Electronic Documents at www.sgs.com/terms_e-document.htm. Attention is drawn to the limitation of liability, indemnification and jurisdiction issues defined therein. Any holder of this document is advised that information contained hereon reflects the Company's findings at the time of its intervention only and within the limits of Client's instructions, if any. The Company's sole responsibility is to its Client and this document does not exonerate parties to a transaction from exercising all their rights and obligations under the transaction documents. This document cannot be reproduced except in full, without prior written approval of the Company. Any unauthorized alteration, forgery or falsification of the content or appearance of this document is unlawful and offenders may be prosecuted to the fullest extent of the law.



Unless otherwise stated the results shown in this test report refer only to the sample(s) tested and such sample(s) are retained for 90 days only.

除非另有說明，此報告結果僅對測試之樣品負責，同時此樣品僅保留90天。本報告未經本公司書面許可，不可部份複製。

This document is issued by the Company subject to its General Conditions of Service printed overleaf, available on request or accessible at www.sgs.com/terms_and_conditions.htm and for electronic format documents, subject to Terms and Conditions for Electronic Documents at www.sgs.com/terms_e-document.htm. Attention is drawn to the limitation of liability, indemnification and jurisdiction issues defined therein. Any holder of this document is advised that information contained hereon reflects the Company's findings at the time of its intervention only and within the limits of Client's instructions, if any. The Company's sole responsibility is to its Client and this document does not exonerate parties to a transaction from exercising all their rights and obligations under the transaction documents. This document cannot be reproduced except in full, without prior written approval of the Company. Any unauthorized alteration, forgery or falsification of the content or appearance of this document is unlawful and offenders may be prosecuted to the fullest extent of the law.



Unless otherwise stated the results shown in this test report refer only to the sample(s) tested and such sample(s) are retained for 90 days only.
除非另有說明，此報告結果僅對測試之樣品負責，同時此樣品僅保留90天。本報告未經本公司書面許可，不可部份複製。

This document is issued by the Company subject to its General Conditions of Service printed overleaf, available on request or accessible at www.sgs.com/terms_and_conditions.htm and for electronic format documents, subject to Terms and Conditions for Electronic Documents at www.sgs.com/terms_e-document.htm. Attention is drawn to the limitation of liability, indemnification and jurisdiction issues defined therein. Any holder of this document is advised that information contained hereon reflects the Company's findings at the time of its intervention only and within the limits of Client's instructions, if any. The Company's sole responsibility is to its Client and this document does not exonerate parties to a transaction from exercising all their rights and obligations under the transaction documents. This document cannot be reproduced except in full, without prior written approval of the Company. Any unauthorized alteration, forgery or falsification of the content or appearance of this document is unlawful and offenders may be prosecuted to the fullest extent of the law.

Docking Station Model No.: HSN-IX02



Unless otherwise stated the results shown in this test report refer only to the sample(s) tested and such sample(s) are retained for 90 days only.
除非另有說明，此報告結果僅對測試之樣品負責，同時此樣品僅保留90天。本報告未經本公司書面許可，不可部份複製。

This document is issued by the Company subject to its General Conditions of Service printed overleaf, available on request or accessible at www.sgs.com/terms_and_conditions.htm and for electronic format documents, subject to Terms and Conditions for Electronic Documents at www.sgs.com/terms_e-document.htm. Attention is drawn to the limitation of liability, indemnification and jurisdiction issues defined therein. Any holder of this document is advised that information contained hereon reflects the Company's findings at the time of its intervention only and within the limits of Client's instructions, if any. The Company's sole responsibility is to its Client and this document does not exonerate parties to a transaction from exercising all their rights and obligations under the transaction documents. This document cannot be reproduced except in full, without prior written approval of the Company. Any unauthorized alteration, forgery or falsification of the content or appearance of this document is unlawful and offenders may be prosecuted to the fullest extent of the law.



Unless otherwise stated the results shown in this test report refer only to the sample(s) tested and such sample(s) are retained for 90 days only.
除非另有說明，此報告結果僅對測試之樣品負責，同時此樣品僅保留90天。本報告未經本公司書面許可，不可部份複製。

This document is issued by the Company subject to its General Conditions of Service printed overleaf, available on request or accessible at www.sgs.com/terms_and_conditions.htm and for electronic format documents, subject to Terms and Conditions for Electronic Documents at www.sgs.com/terms_e-document.htm. Attention is drawn to the limitation of liability, indemnification and jurisdiction issues defined therein. Any holder of this document is advised that information contained hereon reflects the Company's findings at the time of its intervention only and within the limits of Client's instructions, if any. The Company's sole responsibility is to its Client and this document does not exonerate parties to a transaction from exercising all their rights and obligations under the transaction documents. This document cannot be reproduced except in full, without prior written approval of the Company. Any unauthorized alteration, forgery or falsification of the content or appearance of this document is unlawful and offenders may be prosecuted to the fullest extent of the law.



Unless otherwise stated the results shown in this test report refer only to the sample(s) tested and such sample(s) are retained for 90 days only.
除非另有說明，此報告結果僅對測試之樣品負責，同時此樣品僅保留90天。本報告未經本公司書面許可，不可部份複製。

This document is issued by the Company subject to its General Conditions of Service printed overleaf, available on request or accessible at www.sgs.com/terms_and_conditions.htm and for electronic format documents, subject to Terms and Conditions for Electronic Documents at www.sgs.com/terms_e-document.htm. Attention is drawn to the limitation of liability, indemnification and jurisdiction issues defined therein. Any holder of this document is advised that information contained herein reflects the Company's findings at the time of its intervention only and within the limits of Client's instructions, if any. The Company's sole responsibility is to its Client and this document does not exonerate parties to a transaction from exercising all their rights and obligations under the transaction documents. This document cannot be reproduced except in full, without prior written approval of the Company. Any unauthorized alteration, forgery or falsification of the content or appearance of this document is unlawful and offenders may be prosecuted to the fullest extent of the law.



Unless otherwise stated the results shown in this test report refer only to the sample(s) tested and such sample(s) are retained for 90 days only.

除非另有說明，此報告結果僅對測試之樣品負責，同時此樣品僅保留90天。本報告未經本公司書面許可，不可部份複製。

This document is issued by the Company subject to its General Conditions of Service printed overleaf, available on request or accessible at www.sgs.com/terms_and_conditions.htm and for electronic format documents, subject to Terms and Conditions for Electronic Documents at www.sgs.com/terms_e-document.htm. Attention is drawn to the limitation of liability, indemnification and jurisdiction issues defined therein. Any holder of this document is advised that information contained hereon reflects the Company's findings at the time of its intervention only and within the limits of Client's instructions, if any. The Company's sole responsibility is to its Client and this document does not exonerate parties to a transaction from exercising all their rights and obligations under the transaction documents. This document cannot be reproduced except in full, without prior written approval of the Company. Any unauthorized alteration, forgery or falsification of the content or appearance of this document is unlawful and offenders may be prosecuted to the fullest extent of the law.



Unless otherwise stated the results shown in this test report refer only to the sample(s) tested and such sample(s) are retained for 90 days only.
除非另有說明，此報告結果僅對測試之樣品負責，同時此樣品僅保留90天。本報告未經本公司書面許可，不可部份複製。

This document is issued by the Company subject to its General Conditions of Service printed overleaf, available on request or accessible at www.sgs.com/terms_and_conditions.htm and for electronic format documents, subject to Terms and Conditions for Electronic Documents at www.sgs.com/terms_e-document.htm. Attention is drawn to the limitation of liability, indemnification and jurisdiction issues defined therein. Any holder of this document is advised that information contained hereon reflects the Company's findings at the time of its intervention only and within the limits of Client's instructions, if any. The Company's sole responsibility is to its Client and this document does not exonerate parties to a transaction from exercising all their rights and obligations under the transaction documents. This document cannot be reproduced except in full, without prior written approval of the Company. Any unauthorized alteration, forgery or falsification of the content or appearance of this document is unlawful and offenders may be prosecuted to the fullest extent of the law.



Unless otherwise stated the results shown in this test report refer only to the sample(s) tested and such sample(s) are retained for 90 days only.
 除非另有說明，此報告結果僅對測試之樣品負責，同時此樣品僅保留90天。本報告未經本公司書面許可，不可部份複製。
 This document is issued by the Company subject to its General Conditions of Service printed overleaf, available on request or accessible at www.sgs.com/terms_and_conditions.htm and for electronic format documents, subject to Terms and Conditions for Electronic Documents at www.sgs.com/terms_e-document.htm. Attention is drawn to the limitation of liability, indemnification and jurisdiction issues defined therein. Any holder of this document is advised that information contained hereon reflects the Company's findings at the time of its intervention only and within the limits of Client's instructions, if any. The Company's sole responsibility is to its Client and this document does not exonerate parties to a transaction from exercising all their rights and obligations under the transaction documents. This document cannot be reproduced except in full, without prior written approval of the Company. Any unauthorized alteration, forgery or falsification of the content or appearance of this document is unlawful and offenders may be prosecuted to the fullest extent of the law.



Unless otherwise stated the results shown in this test report refer only to the sample(s) tested and such sample(s) are retained for 90 days only.
除非另有說明，此報告結果僅對測試之樣品負責，同時此樣品僅保留90天。本報告未經本公司書面許可，不可部份複製。

This document is issued by the Company subject to its General Conditions of Service printed overleaf, available on request or accessible at www.sgs.com/terms_and_conditions.htm and for electronic format documents, subject to Terms and Conditions for Electronic Documents at www.sgs.com/terms_e-document.htm. Attention is drawn to the limitation of liability, indemnification and jurisdiction issues defined therein. Any holder of this document is advised that information contained hereon reflects the Company's findings at the time of its intervention only and within the limits of Client's instructions, if any. The Company's sole responsibility is to its Client and this document does not exonerate parties to a transaction from exercising all their rights and obligations under the transaction documents. This document cannot be reproduced except in full, without prior written approval of the Company. Any unauthorized alteration, forgery or falsification of the content or appearance of this document is unlawful and offenders may be prosecuted to the fullest extent of the law.

HP ElitePOS Advanced I/O Connectivity Base Model No.: TPC-I027-D



Unless otherwise stated the results shown in this test report refer only to the sample(s) tested and such sample(s) are retained for 90 days only.

除非另有說明，此報告結果僅對測試之樣品負責，同時此樣品僅保留90天。本報告未經本公司書面許可，不可部份複製。

This document is issued by the Company subject to its General Conditions of Service printed overleaf, available on request or accessible at www.sgs.com/terms_and_conditions.htm and for electronic format documents, subject to Terms and Conditions for Electronic Documents at www.sgs.com/terms_e-document.htm. Attention is drawn to the limitation of liability, indemnification and jurisdiction issues defined therein. Any holder of this document is advised that information contained hereon reflects the Company's findings at the time of its intervention only and within the limits of Client's instructions, if any. The Company's sole responsibility is to its Client and this document does not exonerate parties to a transaction from exercising all their rights and obligations under the transaction documents. This document cannot be reproduced except in full, without prior written approval of the Company. Any unauthorized alteration, forgery or falsification of the content or appearance of this document is unlawful and offenders may be prosecuted to the fullest extent of the law.



Unless otherwise stated the results shown in this test report refer only to the sample(s) tested and such sample(s) are retained for 90 days only.
除非另有說明，此報告結果僅對測試之樣品負責，同時此樣品僅保留90天。本報告未經本公司書面許可，不可部份複製。

This document is issued by the Company subject to its General Conditions of Service printed overleaf, available on request or accessible at www.sgs.com/terms_and_conditions.htm and for electronic format documents, subject to Terms and Conditions for Electronic Documents at www.sgs.com/terms_e-document.htm. Attention is drawn to the limitation of liability, indemnification and jurisdiction issues defined therein. Any holder of this document is advised that information contained hereon reflects the Company's findings at the time of its intervention only and within the limits of Client's instructions, if any. The Company's sole responsibility is to its Client and this document does not exonerate parties to a transaction from exercising all their rights and obligations under the transaction documents. This document cannot be reproduced except in full, without prior written approval of the Company. Any unauthorized alteration, forgery or falsification of the content or appearance of this document is unlawful and offenders may be prosecuted to the fullest extent of the law.



Unless otherwise stated the results shown in this test report refer only to the sample(s) tested and such sample(s) are retained for 90 days only.
除非另有說明，此報告結果僅對測試之樣品負責，同時此樣品僅保留90天。本報告未經本公司書面許可，不可部份複製。

This document is issued by the Company subject to its General Conditions of Service printed overleaf, available on request or accessible at www.sgs.com/terms_and_conditions.htm and for electronic format documents, subject to Terms and Conditions for Electronic Documents at www.sgs.com/terms_e-document.htm. Attention is drawn to the limitation of liability, indemnification and jurisdiction issues defined therein. Any holder of this document is advised that information contained hereon reflects the Company's findings at the time of its intervention only and within the limits of Client's instructions, if any. The Company's sole responsibility is to its Client and this document does not exonerate parties to a transaction from exercising all their rights and obligations under the transaction documents. This document cannot be reproduced except in full, without prior written approval of the Company. Any unauthorized alteration, forgery or falsification of the content or appearance of this document is unlawful and offenders may be prosecuted to the fullest extent of the law.



Unless otherwise stated the results shown in this test report refer only to the sample(s) tested and such sample(s) are retained for 90 days only.
除非另有說明，此報告結果僅對測試之樣品負責，同時此樣品僅保留90天。本報告未經本公司書面許可，不可部份複製。

This document is issued by the Company subject to its General Conditions of Service printed overleaf, available on request or accessible at www.sgs.com/terms_and_conditions.htm and for electronic format documents, subject to Terms and Conditions for Electronic Documents at www.sgs.com/terms_e-document.htm. Attention is drawn to the limitation of liability, indemnification and jurisdiction issues defined therein. Any holder of this document is advised that information contained hereon reflects the Company's findings at the time of its intervention only and within the limits of Client's instructions, if any. The Company's sole responsibility is to its Client and this document does not exonerate parties to a transaction from exercising all their rights and obligations under the transaction documents. This document cannot be reproduced except in full, without prior written approval of the Company. Any unauthorized alteration, forgery or falsification of the content or appearance of this document is unlawful and offenders may be prosecuted to the fullest extent of the law.

Hub Model No.: TPC-I049-D



Unless otherwise stated the results shown in this test report refer only to the sample(s) tested and such sample(s) are retained for 90 days only.
除非另有說明，此報告結果僅對測試之樣品負責，同時此樣品僅保留90天。本報告未經本公司書面許可，不可部份複製。

This document is issued by the Company subject to its General Conditions of Service printed overleaf, available on request or accessible at www.sgs.com/terms_and_conditions.htm and for electronic format documents, subject to Terms and Conditions for Electronic Documents at www.sgs.com/terms_e-document.htm. Attention is drawn to the limitation of liability, indemnification and jurisdiction issues defined therein. Any holder of this document is advised that information contained herein reflects the Company's findings at the time of its intervention only and within the limits of Client's instructions, if any. The Company's sole responsibility is to its Client and this document does not exonerate parties to a transaction from exercising all their rights and obligations under the transaction documents. This document cannot be reproduced except in full, without prior written approval of the Company. Any unauthorized alteration, forgery or falsification of the content or appearance of this document is unlawful and offenders may be prosecuted to the fullest extent of the law.

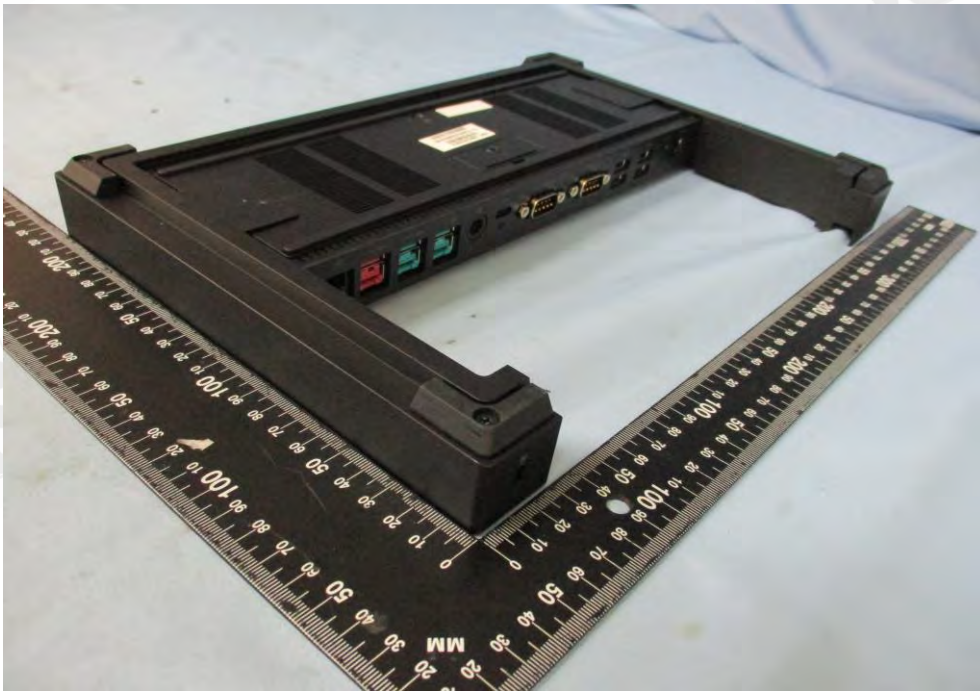
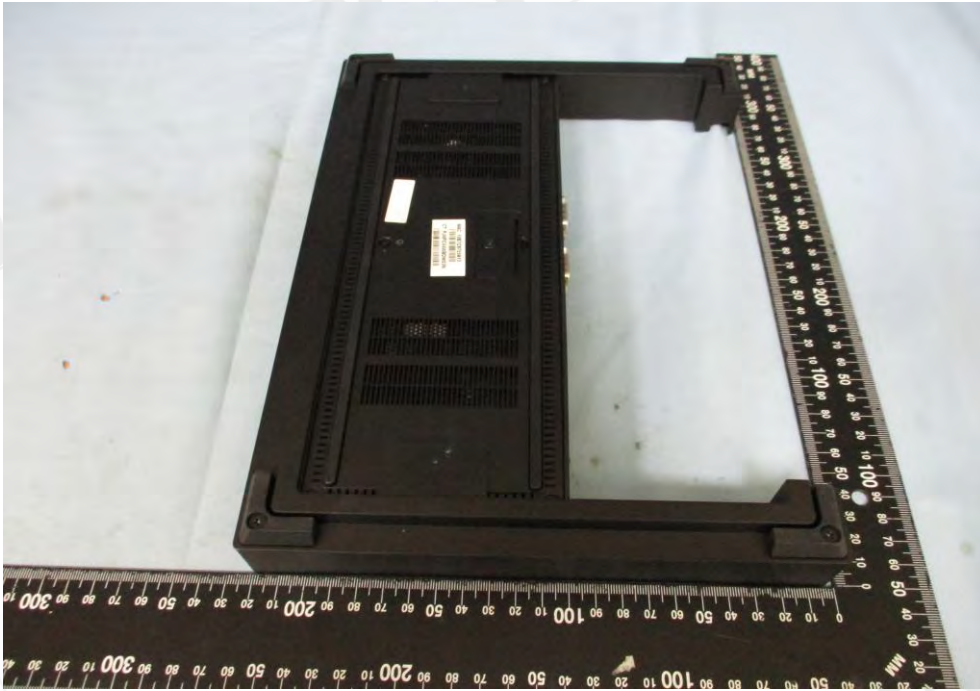

Unless otherwise stated the results shown in this test report refer only to the sample(s) tested and such sample(s) are retained for 90 days only.
除非另有說明，此報告結果僅對測試之樣品負責，同時此樣品僅保留90天。本報告未經本公司書面許可，不可部份複製。

This document is issued by the Company subject to its General Conditions of Service printed overleaf, available on request or accessible at www.sgs.com/terms_and_conditions.htm and for electronic format documents, subject to Terms and Conditions for Electronic Documents at www.sgs.com/terms_e-document.htm. Attention is drawn to the limitation of liability, indemnification and jurisdiction issues defined therein. Any holder of this document is advised that information contained hereon reflects the Company's findings at the time of its intervention only and within the limits of Client's instructions, if any. The Company's sole responsibility is to its Client and this document does not exonerate parties to a transaction from exercising all their rights and obligations under the transaction documents. This document cannot be reproduced except in full, without prior written approval of the Company. Any unauthorized alteration, forgery or falsification of the content or appearance of this document is unlawful and offenders may be prosecuted to the fullest extent of the law.



Unless otherwise stated the results shown in this test report refer only to the sample(s) tested and such sample(s) are retained for 90 days only.
除非另有說明，此報告結果僅對測試之樣品負責，同時此樣品僅保留90天。本報告未經本公司書面許可，不可部份複製。

This document is issued by the Company subject to its General Conditions of Service printed overleaf, available on request or accessible at www.sgs.com/terms_and_conditions.htm and for electronic format documents, subject to Terms and Conditions for Electronic Documents at www.sgs.com/terms_e-document.htm. Attention is drawn to the limitation of liability, indemnification and jurisdiction issues defined therein. Any holder of this document is advised that information contained herein reflects the Company's findings at the time of its intervention only and within the limits of Client's instructions, if any. The Company's sole responsibility is to its Client and this document does not exonerate parties to a transaction from exercising all their rights and obligations under the transaction documents. This document cannot be reproduced except in full, without prior written approval of the Company. Any unauthorized alteration, forgery or falsification of the content or appearance of this document is unlawful and offenders may be prosecuted to the fullest extent of the law.



**** End of Report ****

Unless otherwise stated the results shown in this test report refer only to the sample(s) tested and such sample(s) are retained for 90 days only.

除非另有說明，此報告結果僅對測試之樣品負責，同時此樣品僅保留90天。本報告未經本公司書面許可，不可部份複製。

This document is issued by the Company subject to its General Conditions of Service printed overleaf, available on request or accessible at www.sgs.com/terms_and_conditions.htm and for electronic format documents, subject to Terms and Conditions for Electronic Documents at www.sgs.com/terms_e-document.htm. Attention is drawn to the limitation of liability, indemnification and jurisdiction issues defined therein. Any holder of this document is advised that information contained hereon reflects the Company's findings at the time of its intervention only and within the limits of Client's instructions, if any. The Company's sole responsibility is to its Client and this document does not exonerate parties to a transaction from exercising all their rights and obligations under the transaction documents. This document cannot be reproduced except in full, without prior written approval of the Company. Any unauthorized alteration, forgery or falsification of the content or appearance of this document is unlawful and offenders may be prosecuted to the fullest extent of the law.