

FCC SDoC REPORT

ICES-003 TEST REPORT

Project No. : TM-2207000003P
Applicant : INVENTEC CORPORATION
Address : 66 Hou-Kang st., Shih-Lin District, Taipei, Taiwan, R.O.C.
Manufacturer : INVENTEC CORPORATION
Address : 66 Hou-Kang st., Shih-Lin District, Taipei, Taiwan, R.O.C.

Equipment Under Test (EUT) :

Product Name : Tablet
Brand Name : HP
Model No. : HSC-I006R
Added Model(s) : N/A
Test Voltage : AC 120V, 60Hz
Standards : 47 CFR FCC Part 15 Subpart B
 ICES-003 Issue 7: October 2020
 ANSI C63.4: 2014
Date of Sample Receipt : Jul. 01, 2022
Date of Test : Jul. 01 ~ 08, 2022
Date of Issue : Jul. 21, 2022

Test Result :	PASS
----------------------	-------------

In the configuration tested, the EUT complied with the standards specified above.

Remarks :

This report details the results of the testing carried out on one sample, the results contained in this test report do not relate to other samples of the same product. The manufacturer should ensure that all products in series production are in conformity with the product sample detailed in this report.

This report may only be reproduced and distributed in full. If the product in this report is used in any configuration other than that detailed in the report, the manufacturer must ensure the new system complies with all relevant standards. Any mention of Compliance Certification Services Inc. or testing done by Compliance Certification Services Inc. in connection with distribution or use of the product described in this report must be approved by Compliance Certification Services Inc. in writing.

Approved By:  **Date:** Jul. 21, 2022



Hex Chiang (Supervisor)

Unless otherwise stated the results shown in this test report refer only to the sample(s) tested and such sample(s) are retained for 90 days only.

除非另有說明，此報告結果僅對測試之樣品負責，同時此樣品僅保留90天。本報告未經本公司書面許可，不可部份複製。

This document is issued by the Company subject to its General Conditions of Service printed overleaf, available on request or accessible at www.sgs.com/terms_and_conditions.htm and for electronic format documents, subject to Terms and Conditions for Electronic Documents at www.sgs.com/terms_e-document.htm. Attention is drawn to the limitation of liability, indemnification and jurisdiction issues defined therein. Any holder of this document is advised that information contained hereon reflects the Company's findings at the time of its intervention only and within the limits of Client's instructions, if any. The Company's sole responsibility is to its Client and this document does not exonerate parties to a transaction from exercising all their rights and obligations under the transaction documents. This document cannot be reproduced except in full, without prior written approval of the Company. Any unauthorized alteration, forgery or falsification of the content or appearance of this document is unlawful and offenders may be prosecuted to the fullest extent of the law.

Revision History			
Revision	Report Number	Description	Issue Date
00	TMWK2207002659KE	Original	Jul. 21, 2022

Unless otherwise stated the results shown in this test report refer only to the sample(s) tested and such sample(s) are retained for 90 days only.

除非另有說明，此報告結果僅對測試之樣品負責，同時此樣品僅保留90天。本報告未經本公司書面許可，不可部份複製。

This document is issued by the Company subject to its General Conditions of Service printed overleaf, available on request or accessible at www.sgs.com/terms_and_conditions.htm and for electronic format documents, subject to Terms and Conditions for Electronic Documents at www.sgs.com/terms_e-document.htm. Attention is drawn to the limitation of liability, indemnification and jurisdiction issues defined therein. Any holder of this document is advised that information contained hereon reflects the Company's findings at the time of its intervention only and within the limits of Client's instructions, if any. The Company's sole responsibility is to its Client and this document does not exonerate parties to a transaction from exercising all their rights and obligations under the transaction documents. This document cannot be reproduced except in full, without prior written approval of the Company. Any unauthorized alteration, forgery or falsification of the content or appearance of this document is unlawful and offenders may be prosecuted to the fullest extent of the law.

Contents

1. GENERAL INFORMATION	4
1.1 APPLICANT & MANUFACTURER INFORMATION.....	4
1.2 GENERAL DESCRIPTION OF EUT.....	4
1.3 DETAILS OF EUT.....	5
1.4 THE WORST CASE OF THE EUT.....	7
1.5 DESCRIPTION OF SUPPORT UNITS.....	8
1.6 OPERATION PROCEDURE.....	11
1.7 TEST SET-UP CONFIGURATION.....	12
1.8 ACCESSORIES CABLE LIST.....	14
1.9 MEASUREMENT PROCEDURE.....	15
1.10 STANDARDS APPLICABLE FOR TESTING.....	15
1.11 DECISION RULES OF RESULTS.....	16
1.12 SUMMARY OF RESULTS.....	16
1.13 REPORTING STATEMENTS OF CONFORMITY.....	16
2. EMISSION	17
2.1 TEST RESULTS.....	17
2.2 FREQUENCY RANGE.....	17
2.3 LIMITS OF CONDUCTED AND RADIATED EMISSION.....	18
2.3.1 LIMITS OF CONDUCTED EMISSION.....	18
2.3.2 LIMITS OF RADIATED EMISSIONS.....	19
2.4. TEST OF CONDUCTED EMISSION.....	21
2.4.1 TEST EQUIPMENTS.....	21
2.4.2 MEASUREMENT LEVEL CALCULATION.....	21
2.4.3 MEASUREMENT DATA:.....	22
2.5 TEST OF RADIATED EMISSION.....	28
2.5.1 TEST EQUIPMENTS.....	28
2.5.2 MEASUREMENT LEVEL CALCULATION.....	29
2.5.3 MEASUREMENT DATA.....	30
APPENDIX	50
PHOTOGRAPH OF TESTING GENERAL SET-UP.....	50
PHOTOGRAPHS OF PRODUCT.....	59

Unless otherwise stated the results shown in this test report refer only to the sample(s) tested and such sample(s) are retained for 90 days only.

除非另有說明，此報告結果僅對測試之樣品負責，同時此樣品僅保留90天。本報告未經本公司書面許可，不可部份複製。

This document is issued by the Company subject to its General Conditions of Service printed overleaf, available on request or accessible at www.sgs.com/terms_and_conditions.htm and for electronic format documents, subject to Terms and Conditions for Electronic Documents at www.sgs.com/terms_e-document.htm. Attention is drawn to the limitation of liability, indemnification and jurisdiction issues defined therein. Any holder of this document is advised that information contained hereon reflects the Company's findings at the time of its intervention only and within the limits of Client's instructions, if any. The Company's sole responsibility is to its Client and this document does not exonerate parties to a transaction from exercising all their rights and obligations under the transaction documents. This document cannot be reproduced except in full, without prior written approval of the Company. Any unauthorized alteration, forgery or falsification of the content or appearance of this document is unlawful and offenders may be prosecuted to the fullest extent of the law.

1. General Information

1.1 Applicant & Manufacturer Information

Applicant : INVENTEC CORPORATION
Address : 66 Hou-Kang st., Shih-Lin District, Taipei, Taiwan, R.O.C.
Manufacturer : INVENTEC CORPORATION
Address : 66 Hou-Kang st., Shih-Lin District, Taipei, Taiwan, R.O.C.

1.2 General Description of EUT

Product Name : Tablet
Brand Name : HP
Model No. : HSC-I006R
Added Model(s) : N/A
Variant Description : N/A

Unless otherwise stated the results shown in this test report refer only to the sample(s) tested and such sample(s) are retained for 90 days only.

除非另有說明，此報告結果僅對測試之樣品負責，同時此樣品僅保留90天。本報告未經本公司書面許可，不可部份複製。

This document is issued by the Company subject to its General Conditions of Service printed overleaf, available on request or accessible at www.sgs.com/terms_and_conditions.htm and for electronic format documents, subject to Terms and Conditions for Electronic Documents at www.sgs.com/terms_e-document.htm. Attention is drawn to the limitation of liability, indemnification and jurisdiction issues defined therein. Any holder of this document is advised that information contained hereon reflects the Company's findings at the time of its intervention only and within the limits of Client's instructions, if any. The Company's sole responsibility is to its Client and this document does not exonerate parties to a transaction from exercising all their rights and obligations under the transaction documents. This document cannot be reproduced except in full, without prior written approval of the Company. Any unauthorized alteration, forgery or falsification of the content or appearance of this document is unlawful and offenders may be prosecuted to the fullest extent of the law.

1.3 Details of EUT

EUT Power Rating	AC 100 ~ 240V	
Highest operate description	5.8GHz	
Power Adapter	Chicony (hp)	TPN-CA21
	Delta (hp)	TPN-DA20
	Lite-on (hp)	TPN-LA23
	Honor (hp)	TPN-HA01
Adapter Power Rating	For TPN-DA20 I/P: 100-240Vac, 50-60Hz, 1.7A O/P: 5Vdc, 3A / 9Vdc, 3A / 12Vdc, 5A / 15Vdc, 4.33A / 20Vdc, 3.25A	
	For TPN-CA21 ; TPN-LA23 ; TPN-HA01 I/P: 100-240Vac, 50-60Hz, 1.6A O/P: 5Vdc, 3A / 9Vdc, 3A / 12Vdc, 5A / 15Vdc, 4.33A / 20Vdc, 3.25A	
AC Power Cord Type	Shielded, 1.8m (Detachable) to Power Adaptor	
DC Power Cable Type (Type C)	Shielded, 1.8m (Non-Detachable) to Power Adapter	
Memory	DDR4 4266MHz (32GB / 64GB)	
Main Board	Inventec	6050A3404001
CPU	Intel	i3-1110G4 1.8GHz
		i5-1140G7 1.1GHz
13.5" LCD Panel	INX	N135NCG-GT1
Touch Screen	MUTTO	B132893Q1
	LAIBAO	TGF-135FF006BM
	Henghao	8B0D501A
		8G0D505A
SSD	Kingston	OM3PDP3128B-AH (128GB)
		OM3PDP3256B-AH (256GB)
	Kioxia	KBG50ZNS256G (256GB)
	Western Digital	SDAPTUW-128G-1006 (128GB)
		SDDPTQD-256G-1006 (256GB)
	Micron	MTFDKKBK256TFK-1BC1AABHA (256GB)
	Phison	PSEDN128GA17DC0 (128GB)
SSSTC	CL4-3D256-HP (256GB)	

Unless otherwise stated the results shown in this test report refer only to the sample(s) tested and such sample(s) are retained for 90 days only.

除非另有說明，此報告結果僅對測試之樣品負責，同時此樣品僅保留90天。本報告未經本公司書面許可，不可部份複製。

This document is issued by the Company subject to its General Conditions of Service printed overleaf, available on request or accessible at www.sgs.com/terms_and_conditions.htm and for electronic format documents, subject to Terms and Conditions for Electronic Documents at www.sgs.com/terms_e-document.htm. Attention is drawn to the limitation of liability, indemnification and jurisdiction issues defined therein. Any holder of this document is advised that information contained hereon reflects the Company's findings at the time of its intervention only and within the limits of Client's instructions, if any. The Company's sole responsibility is to its Client and this document does not exonerate parties to a transaction from exercising all their rights and obligations under the transaction documents. This document cannot be reproduced except in full, without prior written approval of the Company. Any unauthorized alteration, forgery or falsification of the content or appearance of this document is unlawful and offenders may be prosecuted to the fullest extent of the law.

CCD	Luxvisions	7BA805T2B
		8BF206T2
	TFC	YHCB
		YHCY
Battery Pack	Dynapack(hp)	TPN-DB1I
Wireless LAN+Bluetooth Combo	Intel	AX201D2W
WWAN	Fibocom	FM350-GL
		L860-GL-16
NFC Module	WNC	XRAV-1
Dock (Optional)	HP	HSN-I001D
Docking Station (Optional)	HP	HSN-IX02
HP ElitePOS Retail Basic I/O Connectivity Base (Optional)	HP	TPC-I026-D
HP ElitePOS Advanced I/O Connectivity Base (Optional)	HP	TPC-I027-D
Hub (Optional)	HP	TPC-I049-D

Unless otherwise stated the results shown in this test report refer only to the sample(s) tested and such sample(s) are retained for 90 days only.

除非另有說明，此報告結果僅對測試之樣品負責，同時此樣品僅保留90天。本報告未經本公司書面許可，不可部份複製。

This document is issued by the Company subject to its General Conditions of Service printed overleaf, available on request or accessible at www.sgs.com/terms_and_conditions.htm and for electronic format documents, subject to Terms and Conditions for Electronic Documents at www.sgs.com/terms_e-document.htm. Attention is drawn to the limitation of liability, indemnification and jurisdiction issues defined therein. Any holder of this document is advised that information contained hereon reflects the Company's findings at the time of its intervention only and within the limits of Client's instructions, if any. The Company's sole responsibility is to its Client and this document does not exonerate parties to a transaction from exercising all their rights and obligations under the transaction documents. This document cannot be reproduced except in full, without prior written approval of the Company. Any unauthorized alteration, forgery or falsification of the content or appearance of this document is unlawful and offenders may be prosecuted to the fullest extent of the law.

Pre-test Mode

Mode	CPU	Memory	LCD Panel	Touch Screen	SSD	CCD	Battery Pack	Wireless LAN+Bluetooth	WWAN	NFC	Main Board	Adapter	HP ElitePOS Retail Basic I/O Connectivity Base / HP ElitePOS Advanced I/O Connectivity Base / Hub	Dock	Docking Station
1	Intel i3-1110G4 1.8GHz	32GB	INX N135NCG-GT1	MUTTO B132893Q1	Kingston OM3PDP3128B-AH (128GB)	Luxvisions 7BA805T2B	Dynapack(hp) TPN-DB11	Intel AX201D2W	Fibocom FM350-GL	WNC XRAV-1	Inventec 6050A3404001	Chicony (hp) TPN-CA21	N/A	N/A	N/A
2	Intel i5-1140G7 1.1GHz	64GB	INX N135NCG-GT1	LAIBAO TGF-135FF006BM	Kingston OM3PDP3256B-AH (256GB)	Luxvisions 88F206T2	Dynapack(hp) TPN-DB11	Intel AX201D2W	Fibocom L860-GL-16	WNC XRAV-1	Inventec 6050A3404001	Delta (hp) TPN-DA20	N/A	N/A	N/A
3	Intel i5-1140G7 1.1GHz	64GB	INX N135NCG-GT1	Henghao 8B0D501A	Kioxia KBG50ZNS256G (256GB)	TFC YHCB	Dynapack(hp) TPN-DB11	Intel AX201D2W	Fibocom L860-GL-16	WNC XRAV-1	Inventec 6050A3404001	Lite-on (hp) TPN-LA23	N/A	N/A	N/A
4	Intel i5-1140G7 1.1GHz	64GB	INX N135NCG-GT1	Henghao 8G0D505A	Western Digital SDAPTJW-128G-1006 (128GB)	TFC YHCY	Dynapack(hp) TPN-DB11	Intel AX201D2W	Fibocom L860-GL-16	WNC XRAV-1	Inventec 6050A3404001	Honor (hp) TPN-HA01	N/A	N/A	N/A
5	Intel i5-1140G7 1.1GHz	64GB	INX N135NCG-GT1	MUTTO B132893Q1	Western Digital SDDPTQD-256G-1006 (256GB)	TFC YHCB	Dynapack(hp) TPN-DB11	Intel AX201D2W	Fibocom L860-GL-16	WNC XRAV-1	Inventec 6050A3404001	Chicony (hp) TPN-CA21	N/A	N/A	N/A
6	Intel i5-1140G7 1.1GHz	64GB	INX N135NCG-GT1	MUTTO B132893Q1	Micron MTFDKBK256TFK-1BC1AABHA (256GB)	TFC YHCB	Dynapack(hp) TPN-DB11	Intel AX201D2W	Fibocom L860-GL-16	WNC XRAV-1	Inventec 6050A3404001	Chicony (hp) TPN-CA21	N/A	N/A	N/A
7	Intel i5-1140G7 1.1GHz	64GB	INX N135NCG-GT1	MUTTO B132893Q1	Phison PSEDN128GA17DC0 (128GB)	TFC YHCB	Dynapack(hp) TPN-DB11	Intel AX201D2W	Fibocom L860-GL-16	WNC XRAV-1	Inventec 6050A3404001	Chicony (hp) TPN-CA21	N/A	N/A	N/A
8	Intel i5-1140G7 1.1GHz	64GB	INX N135NCG-GT1	MUTTO B132893Q1	SSSTC CL4-3D256-HP (256GB)	TFC YHCB	Dynapack(hp) TPN-DB11	Intel AX201D2W	Fibocom L860-GL-16	WNC XRAV-1	Inventec 6050A3404001	Chicony (hp) TPN-CA21	N/A	N/A	N/A
9	Intel i5-1140G7 1.1GHz	64GB	INX N135NCG-GT1	MUTTO B132893Q1	Western Digital SDDPTQD-256G-1006 (256GB)	TFC YHCB	Dynapack(hp) TPN-DB11	Intel AX201D2W	Fibocom L860-GL-16	WNC XRAV-1	Inventec 6050A3404001	Chicony (hp) TPN-CA21	N/A	N/A	HP HSN-IX02
10	Intel i5-1140G7 1.1GHz	64GB	INX N135NCG-GT1	MUTTO B132893Q1	Western Digital SDDPTQD-256G-1006 (256GB)	TFC YHCB	Dynapack(hp) TPN-DB11	Intel AX201D2W	Fibocom L860-GL-16	WNC XRAV-1	Inventec 6050A3404001	Chicony (hp) TPN-CA21	HP TPC-1026-D	HP HSN-1001D	N/A
11	Intel i5-1140G7 1.1GHz	64GB	INX N135NCG-GT1	MUTTO B132893Q1	Western Digital SDDPTQD-256G-1006 (256GB)	TFC YHCB	Dynapack(hp) TPN-DB11	Intel AX201D2W	Fibocom L860-GL-16	WNC XRAV-1	Inventec 6050A3404001	Chicony (hp) TPN-CA21	HP TPC-1027-D	HP HSN-1001D	N/A
12	Intel i5-1140G7 1.1GHz	64GB	INX N135NCG-GT1	MUTTO B132893Q1	Western Digital SDDPTQD-256G-1006 (256GB)	TFC YHCB	Dynapack(hp) TPN-DB11	Intel AX201D2W	Fibocom L860-GL-16	WNC XRAV-1	Inventec 6050A3404001	Chicony (hp) TPN-CA21	HP TPC-1049-D	HP HSN-1001D	N/A

1.4 The worst case of the EUT

EUT will be carried out in the worst case as followings:

Worst Case	
CE	Mode 5, 9, 10 (1800 x 1200 Resolution)
Below 1GHz RE	Mode 5, 9, 10 (1800 x 1200 Resolution)
Above 1GHz RE	Mode 5, 9, 10 (1800 x 1200 Resolution)

Unless otherwise stated the results shown in this test report refer only to the sample(s) tested and such sample(s) are retained for 90 days only.

除非另有說明，此報告結果僅對測試之樣品負責，同時此樣品僅保留90天。本報告未經本公司書面許可，不可部份複製。

This document is issued by the Company subject to its General Conditions of Service printed overleaf, available on request or accessible at www.sgs.com/terms_and_conditions.htm and for electronic format documents, subject to Terms and Conditions for Electronic Documents at www.sgs.com/terms_e-document.htm. Attention is drawn to the limitation of liability, indemnification and jurisdiction issues defined therein. Any holder of this document is advised that information contained hereon reflects the Company's findings at the time of its intervention only and within the limits of Client's instructions, if any. The Company's sole responsibility is to its Client and this document does not exonerate parties to a transaction from exercising all their rights and obligations under the transaction documents. This document cannot be reproduced except in full, without prior written approval of the Company. Any unauthorized alteration, forgery or falsification of the content or appearance of this document is unlawful and offenders may be prosecuted to the fullest extent of the law.

1.5 Description of Support Units

Mode 5:

PRODUCT	MANUFACTURER	MODEL NO.	SERIAL NO.
LCD Monitor	ASUS	MX27U	N/A
IC Card	N/A	N/A	N/A
Notebook PC (Remote)	HP	Pavilion dv6	CNF9491GLJ
Wireless AP (Remote)	ASUS	RT-AX88U	L41THP000064
Universal Radio Communication (Remote)	R&S	CMW 500	N/A
GPS Simulator (Remote)	IFR	GPS-101	N/A

Mode 9:

PRODUCT	MANUFACTURER	MODEL NO.	SERIAL NO.
LCD Monitor	ASUS	MX27U	N/A
LCD Monitor	ASUS	MX27U	N/A
LCD Monitor	ASUS	MX27U	N/A
Mouse	Logitech	M-U0026	NA
Type C to USB	HP	N/A	N/A
Earphone	Lenovo	GS-4021M	57Y4488
IC Card	N/A	N/A	N/A
HDD	WD	My Passport	WXE1E84CVPPA
HDD	WD	My Passport	WXA1AA4DRYDJ
HDD	WD	My Passport	WXB1AA4EEJ9P
HDD	WD	My Passport	WXD1E849K9YF
Notebook PC (Remote)	HP	Pavilion dv6	CNF9491GLJ
Wireless AP (Remote)	ASUS	RT-AX88U	L41THP000064
SIM Card	VIBO	N/A	N/A
Universal Radio Communication (Remote)	R&S	CMW 500	N/A
GPS Simulator (Remote)	IFR	GPS-101	N/A

Unless otherwise stated the results shown in this test report refer only to the sample(s) tested and such sample(s) are retained for 90 days only.

除非另有說明，此報告結果僅對測試之樣品負責，同時此樣品僅保留90天。本報告未經本公司書面許可，不可部份複製。

This document is issued by the Company subject to its General Conditions of Service printed overleaf, available on request or accessible at www.sgs.com/terms_and_conditions.htm and for electronic format documents, subject to Terms and Conditions for Electronic Documents at www.sgs.com/terms_e-document.htm. Attention is drawn to the limitation of liability, indemnification and jurisdiction issues defined therein. Any holder of this document is advised that information contained hereon reflects the Company's findings at the time of its intervention only and within the limits of Client's instructions, if any. The Company's sole responsibility is to its Client and this document does not exonerate parties to a transaction from exercising all their rights and obligations under the transaction documents. This document cannot be reproduced except in full, without prior written approval of the Company. Any unauthorized alteration, forgery or falsification of the content or appearance of this document is unlawful and offenders may be prosecuted to the fullest extent of the law.

Mode 10:

PRODUCT	MANUFACTURER	MODEL NO.	SERIAL NO.
LCD Monitor	ASUS	MX27U	N/A
LCD Monitor	ASUS	MX27U	N/A
Keyboard	Logitech	Y-S0002	N/A
Mouse	Logitech	M-U0026	N/A
Keyboard	HP	KB2101U	PUKAA1046004690
Earphone	Lenovo	GS-4021M	57Y4488
Modem	ACEEX	DM-1414	405026749
Modem	ACEEX	DM-1414	405026749
Modem	ACEEX	DM-1414	405026749
IC Card	N/A	N/A	N/A
Micro SD 8G	Transcend	N/A	N/A
Type C to USB	HP	N/A	N/A
HDD	WD	My Passport	WXA1AA4DRYDJ
HDD	WD	My Passport	WXB1AA4EEJ9P
HDD	WD	My Passport	WXD1E849K9YF
HDD	WD	My Passport	WX21E54RD766
HDD	WD	My Passport	WX91A744F4NL
Notebook PC (Remote)	HP	Pavilion dv6	CNF9491GLJ
Wireless AP (Remote)	ASUS	RT-AX88U	L41THP000064
SIM Card	VIBO	N/A	N/A
Universal Radio Communication (Remote)	R&S	CMW 500	N/A
GPS Simulator (Remote)	IFR	GPS-101	N/A
Standard Duty Cash Drawer	HP	VB400-BL1616	N/A

Unless otherwise stated the results shown in this test report refer only to the sample(s) tested and such sample(s) are retained for 90 days only.

除非另有說明，此報告結果僅對測試之樣品負責，同時此樣品僅保留90天。本報告未經本公司書面許可，不可部份複製。

This document is issued by the Company subject to its General Conditions of Service printed overleaf, available on request or accessible at www.sgs.com/terms_and_conditions.htm and for electronic format documents, subject to Terms and Conditions for Electronic Documents at www.sgs.com/terms_e-document.htm. Attention is drawn to the limitation of liability, indemnification and jurisdiction issues defined therein. Any holder of this document is advised that information contained hereon reflects the Company's findings at the time of its intervention only and within the limits of Client's instructions, if any. The Company's sole responsibility is to its Client and this document does not exonerate parties to a transaction from exercising all their rights and obligations under the transaction documents. This document cannot be reproduced except in full, without prior written approval of the Company. Any unauthorized alteration, forgery or falsification of the content or appearance of this document is unlawful and offenders may be prosecuted to the fullest extent of the law.

Support Equipment Used in Tested Cable

Mode 5:

Cable Type	Core	Length	Shielding/Non-shielding
DC Power Cable (Type C) (1)	N/A	1.8m	Shielding
Type C Cable (2)	N/A	1.8m	Shielding

Mode 9:

Cable Type	Core	Length	Shielding/Non-shielding
Type C Cable (1)	N/A	0.5m	Shielding
DC Power Cable (Type C) (2)	N/A	1.8m	Shielding
HDMI Cable (3)	N/A	1.8m	Shielding
Display Cable (4)*2	N/A	1.8m	Shielding
Type C to USB Cable (5)	N/A	0.1m	Shielding
USB HDD Cable (6)*4	N/A	0.6m	Shielding
Earphone Cable (7)	N/A	1.8m	Non-shielding
USB Mouse Cable (8)	N/A	1.8m	Shielding
LAN Cable (9)	N/A	10.0m	Non-shielding

Mode 10:

Cable Type	Core	Length	Shielding/Non-shielding
Type C Cable (1)	N/A	1.8m	Shielding
RJ11 Cable (2)	N/A	1.0m	Non-shielding
Earphone Cable (3)	N/A	1.8m	Non-shielding
Type C to USB Cable (4)	N/A	0.1m	Shielding
USB HDD Cable (5)*5	N/A	0.6m	Shielding
RS232 Cable (6)*3	N/A	1.8m	Shielding
USB Keyboard Cable (7)	N/A	1.8m	Shielding
USB Mouse Cable (8)	N/A	1.8m	Shielding
LAN Cable (9)	N/A	10.0m	Non-shielding
DC Power Cable (Type C) (10)	N/A	1.8m	Shielding

Unless otherwise stated the results shown in this test report refer only to the sample(s) tested and such sample(s) are retained for 90 days only.

除非另有說明，此報告結果僅對測試之樣品負責，同時此樣品僅保留90天。本報告未經本公司書面許可，不可部份複製。

This document is issued by the Company subject to its General Conditions of Service printed overleaf, available on request or accessible at www.sgs.com/terms_and_conditions.htm and for electronic format documents, subject to Terms and Conditions for Electronic Documents at www.sgs.com/terms_e-document.htm. Attention is drawn to the limitation of liability, indemnification and jurisdiction issues defined therein. Any holder of this document is advised that information contained hereon reflects the Company's findings at the time of its intervention only and within the limits of Client's instructions, if any. The Company's sole responsibility is to its Client and this document does not exonerate parties to a transaction from exercising all their rights and obligations under the transaction documents. This document cannot be reproduced except in full, without prior written approval of the Company. Any unauthorized alteration, forgery or falsification of the content or appearance of this document is unlawful and offenders may be prosecuted to the fullest extent of the law.

1.6 Operation Procedure

Mode 5:

1. Turn on the power of all equipment.
2. The EUT execute the "WINEMC Test" test software to send "H" Pattern to display on the screen.
3. The EUT communicates with Notebook PC by Bluetooth radio.
4. The EUT communicates with Wireless AP by WIFI radio.
5. Executed AMCAP2 software to turn-on the Camera.
6. The EUT will receive GPS, LTE signal sources and continue to operate.
7. The EUT will receive the NFC RF signal source.
8. Setup the condition for test mode and begin the test.

Mode 9:

1. Turn on the power of all equipment.
2. The EUT will reads/writes disk through "WINEMC Test" test software.
3. The EUT execute the "WINEMC Test" test software to send "H" Pattern to display on the screen.
4. The EUT communicates with Notebook PC by Bluetooth radio.
5. The EUT communicates with Wireless AP by WIFI radio.
6. Executed AMCAP2 software to turn-on the Camera.
7. The EUT will receive GPS, LTE signal sources and continue to operate.
8. The EUT will receive the NFC RF signal source.
9. ISN test, using TFGEN 1.0.exe program will push traffic to 10%, 250ms for testing.
10. Setup the condition for test mode and begin the test.

Mode 10:

1. Turn on the power of all equipment.
2. The EUT will reads/writes disk through "WINEMC Test" test software.
3. The EUT execute the "WINEMC Test" test software to send "H" Pattern to display on the screen.
4. The EUT communicates with Notebook PC by Bluetooth radio.
5. The EUT communicates with Wireless AP by WIFI radio.
6. Executed AMCAP2 software to turn-on the Camera.
7. The EUT will receive GPS, LTE signal sources and continue to operate.
8. The EUT will receive the NFC RF signal source.
9. ISN test, using TFGEN 1.0.exe program will push traffic to 10%, 250ms for testing.
10. Setup the condition for test mode and begin the test.

Unless otherwise stated the results shown in this test report refer only to the sample(s) tested and such sample(s) are retained for 90 days only.

除非另有說明，此報告結果僅對測試之樣品負責，同時此樣品僅保留90天。本報告未經本公司書面許可，不可部份複製。

This document is issued by the Company subject to its General Conditions of Service printed overleaf, available on request or accessible at www.sgs.com/terms_and_conditions.htm and for electronic format documents, subject to Terms and Conditions for Electronic Documents at www.sgs.com/terms_e-document.htm. Attention is drawn to the limitation of liability, indemnification and jurisdiction issues defined therein. Any holder of this document is advised that information contained hereon reflects the Company's findings at the time of its intervention only and within the limits of Client's instructions, if any. The Company's sole responsibility is to its Client and this document does not exonerate parties to a transaction from exercising all their rights and obligations under the transaction documents. This document cannot be reproduced except in full, without prior written approval of the Company. Any unauthorized alteration, forgery or falsification of the content or appearance of this document is unlawful and offenders may be prosecuted to the fullest extent of the law.

1.7 Test Set-Up Configuration

Mode 5:

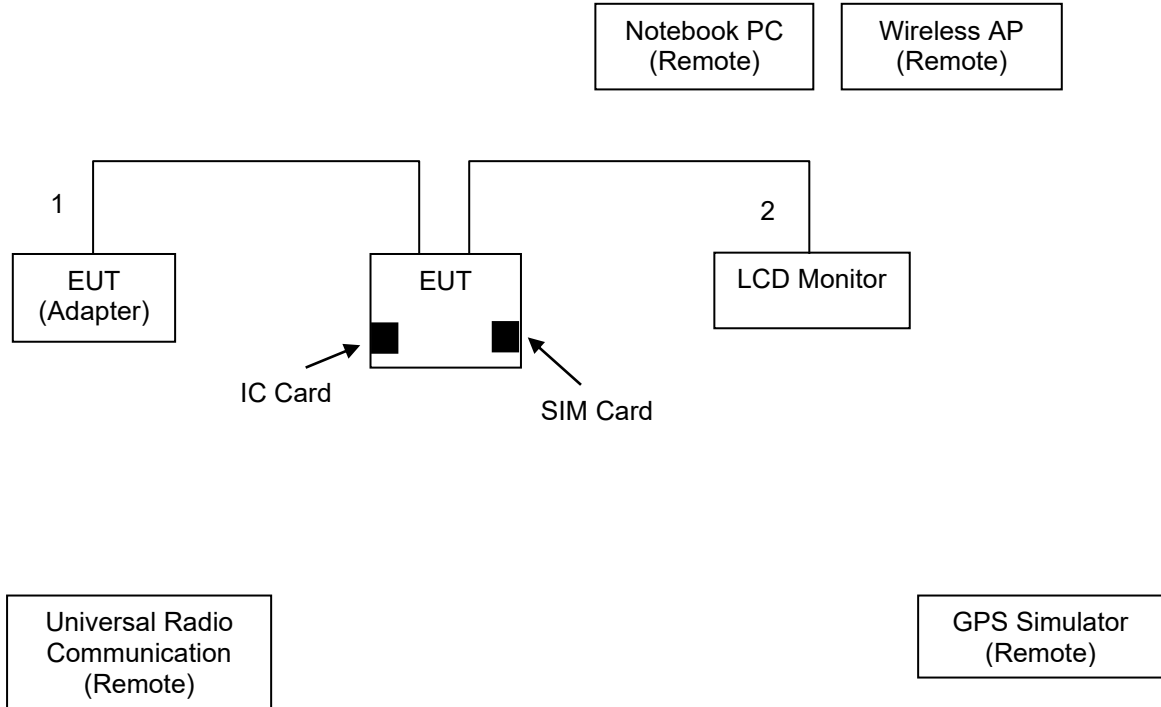

Unless otherwise stated the results shown in this test report refer only to the sample(s) tested and such sample(s) are retained for 90 days only.

除非另有說明，此報告結果僅對測試之樣品負責，同時此樣品僅保留90天。本報告未經本公司書面許可，不可部份複製。

This document is issued by the Company subject to its General Conditions of Service printed overleaf, available on request or accessible at www.sgs.com/terms_and_conditions.htm and for electronic format documents, subject to Terms and Conditions for Electronic Documents at www.sgs.com/terms_e-document.htm. Attention is drawn to the limitation of liability, indemnification and jurisdiction issues defined therein. Any holder of this document is advised that information contained hereon reflects the Company's findings at the time of its intervention only and within the limits of Client's instructions, if any. The Company's sole responsibility is to its Client and this document does not exonerate parties to a transaction from exercising all their rights and obligations under the transaction documents. This document cannot be reproduced except in full, without prior written approval of the Company. Any unauthorized alteration, forgery or falsification of the content or appearance of this document is unlawful and offenders may be prosecuted to the fullest extent of the law.

Mode 9:

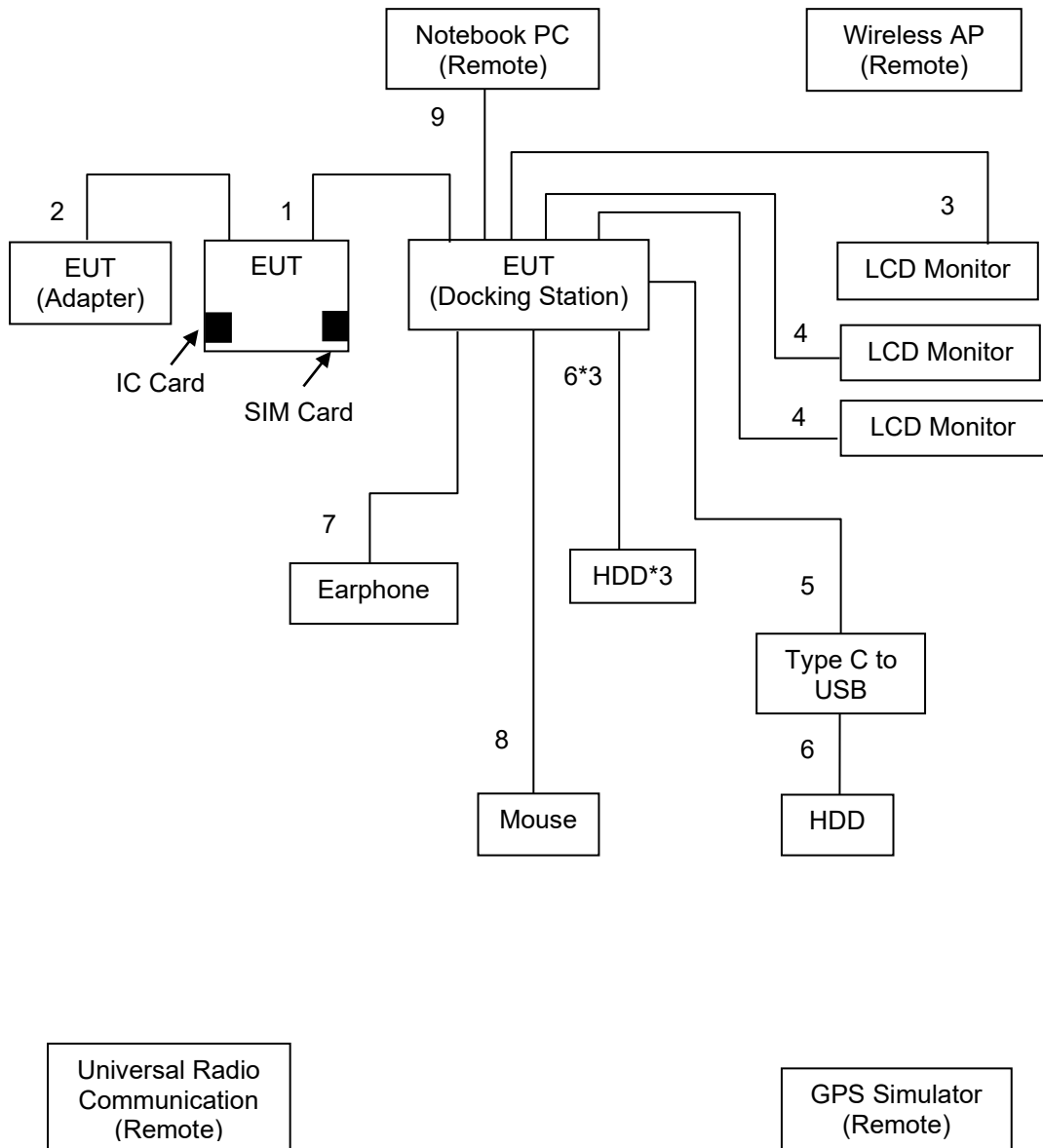

Unless otherwise stated the results shown in this test report refer only to the sample(s) tested and such sample(s) are retained for 90 days only.

除非另有說明，此報告結果僅對測試之樣品負責，同時此樣品僅保留90天。本報告未經本公司書面許可，不可部份複製。

This document is issued by the Company subject to its General Conditions of Service printed overleaf, available on request or accessible at www.sgs.com/terms_and_conditions.htm and for electronic format documents, subject to Terms and Conditions for Electronic Documents at www.sgs.com/terms_e-document.htm. Attention is drawn to the limitation of liability, indemnification and jurisdiction issues defined therein. Any holder of this document is advised that information contained hereon reflects the Company's findings at the time of its intervention only and within the limits of Client's instructions, if any. The Company's sole responsibility is to its Client and this document does not exonerate parties to a transaction from exercising all their rights and obligations under the transaction documents. This document cannot be reproduced except in full, without prior written approval of the Company. Any unauthorized alteration, forgery or falsification of the content or appearance of this document is unlawful and offenders may be prosecuted to the fullest extent of the law.

Mode 10:

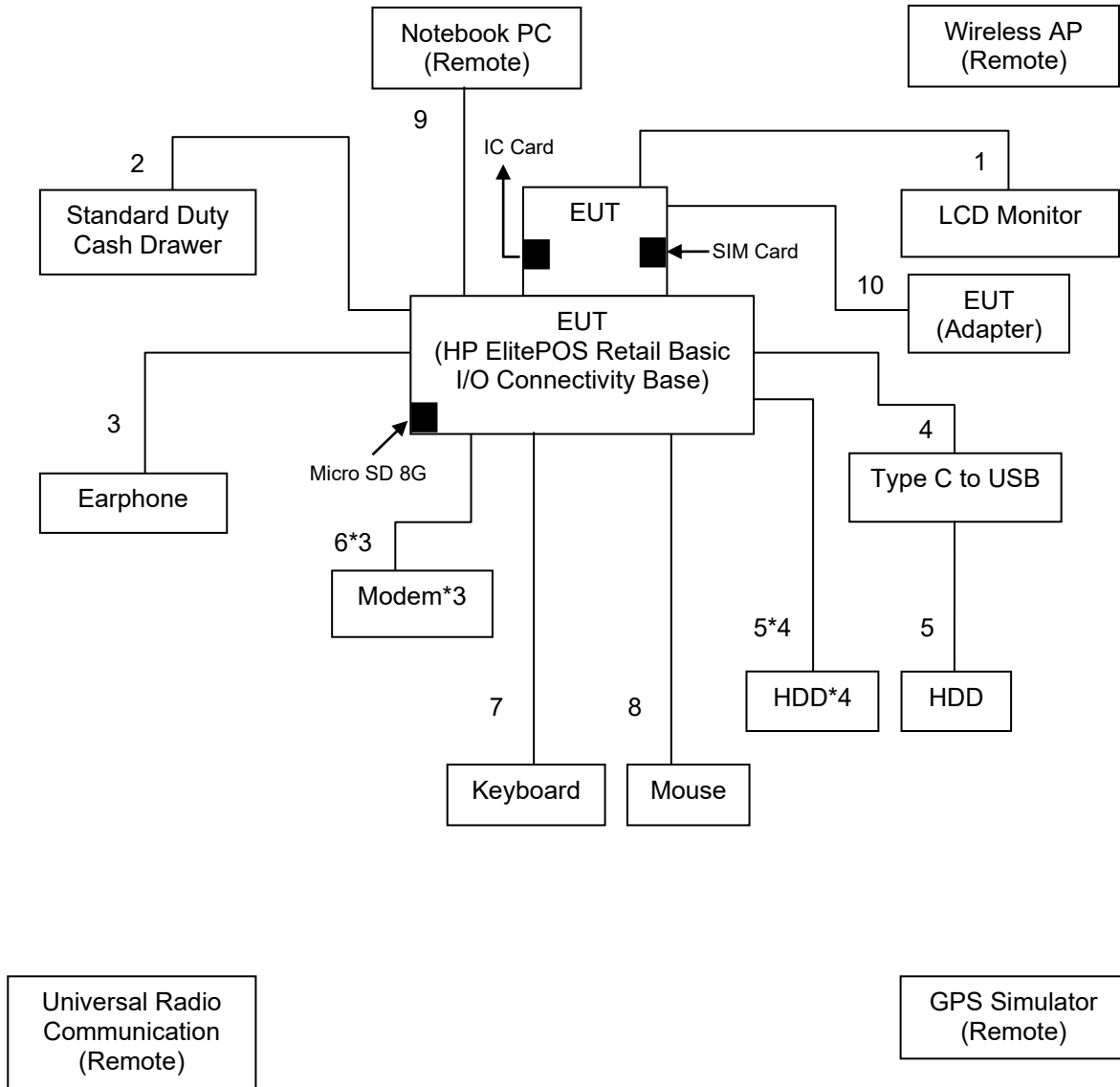

1.8 Accessories Cable List

See clause 1.3 of this report

Unless otherwise stated the results shown in this test report refer only to the sample(s) tested and such sample(s) are retained for 90 days only.

除非另有說明，此報告結果僅對測試之樣品負責，同時此樣品僅保留90天。本報告未經本公司書面許可，不可部份複製。

This document is issued by the Company subject to its General Conditions of Service printed overleaf, available on request or accessible at www.sgs.com/terms_and_conditions.htm and for electronic format documents, subject to Terms and Conditions for Electronic Documents at www.sgs.com/terms_e-document.htm. Attention is drawn to the limitation of liability, indemnification and jurisdiction issues defined therein. Any holder of this document is advised that information contained hereon reflects the Company's findings at the time of its intervention only and within the limits of Client's instructions, if any. The Company's sole responsibility is to its Client and this document does not exonerate parties to a transaction from exercising all their rights and obligations under the transaction documents. This document cannot be reproduced except in full, without prior written approval of the Company. Any unauthorized alteration, forgery or falsification of the content or appearance of this document is unlawful and offenders may be prosecuted to the fullest extent of the law.

1.9 Measurement Procedure

Conducted Emission Testing was performed according to ANSI C63.4:2014 in a shielded room with peripherals placed on a table, 0.8m high over a metal floor. It was located more than required distance away from the shielded room wall.

Radiated Emission Testing was performed according to ANSI C63.4:2014 at the 3/10m semi-anechoic chamber. The EUT was placed on a 0.8m high table along with the peripherals. The turn table was placed 10m distance from the antenna. Cables were placed in a position to produce maximum emissions as determined by experimentation, and operation mode was selected for production of maximum emission.

The frequencies and amplitudes of maximum emission were measured at varying azimuths, antenna heights and antenna polarities. Maximum emission levels are then reported.

1.10 Standards Applicable for Testing

Tests to be carried out under 47 CFR FCC Part 15 Subpart B/CISPR 22/
ICES-003/ANSI C63.4: 2014

Test Standards	Status
47 CFR FCC Part 15 Subpart B CISPR 22 ICES-003 ANSI C63.4: 2014	Applicable
Deviation from Standard	No deviation

Unless otherwise stated the results shown in this test report refer only to the sample(s) tested and such sample(s) are retained for 90 days only.

除非另有說明，此報告結果僅對測試之樣品負責，同時此樣品僅保留90天。本報告未經本公司書面許可，不可部份複製。

This document is issued by the Company subject to its General Conditions of Service printed overleaf, available on request or accessible at www.sgs.com/terms_and_conditions.htm and for electronic format documents, subject to Terms and Conditions for Electronic Documents at www.sgs.com/terms_e-document.htm. Attention is drawn to the limitation of liability, indemnification and jurisdiction issues defined therein. Any holder of this document is advised that information contained hereon reflects the Company's findings at the time of its intervention only and within the limits of Client's instructions, if any. The Company's sole responsibility is to its Client and this document does not exonerate parties to a transaction from exercising all their rights and obligations under the transaction documents. This document cannot be reproduced except in full, without prior written approval of the Company. Any unauthorized alteration, forgery or falsification of the content or appearance of this document is unlawful and offenders may be prosecuted to the fullest extent of the law.

1.11 Decision Rules of Results

Reported measurement data comply with 47 CFR FCC Part 15 Subpart B and ICES-003.

Determining compliance shall be based on the results of the compliance measurement, not taking into account measurement instrumentation uncertainty.

1.12 Summary of Results

Standard	Test Type	Result
47 CFR FCC Part 15 Subpart B ICES-003 Issue 7: October 2020 ANSI C63.4: 2014	Conducted Emission	PASS
	Radiated Emission	PASS

1.13 Reporting Statements of Conformity

The conformity statement in this report is based solely on the test results, measurement uncertainty is excluded.

Unless otherwise stated the results shown in this test report refer only to the sample(s) tested and such sample(s) are retained for 90 days only.

除非另有說明，此報告結果僅對測試之樣品負責，同時此樣品僅保留90天。本報告未經本公司書面許可，不可部份複製。

This document is issued by the Company subject to its General Conditions of Service printed overleaf, available on request or accessible at www.sgs.com/terms_and_conditions.htm and for electronic format documents, subject to Terms and Conditions for Electronic Documents at www.sgs.com/terms_e-document.htm. Attention is drawn to the limitation of liability, indemnification and jurisdiction issues defined therein. Any holder of this document is advised that information contained hereon reflects the Company's findings at the time of its intervention only and within the limits of Client's instructions, if any. The Company's sole responsibility is to its Client and this document does not exonerate parties to a transaction from exercising all their rights and obligations under the transaction documents. This document cannot be reproduced except in full, without prior written approval of the Company. Any unauthorized alteration, forgery or falsification of the content or appearance of this document is unlawful and offenders may be prosecuted to the fullest extent of the law.

2. EMISSION

2.1 Test Results

Conducted Emission	Pass
Radiated Emission	Pass

2.2 Frequency Range

47 CFR FCC Part 15 Subpart B:

Conducted Emission : 150 kHz - 30 MHz

Radiated Emission : See below table

Highest frequency generated or used in the device or on which the device operates or tunes (MHz)	Upper frequency of measurement range (MHz)
Below 1.705	30
1.705 - 108	1000
108 - 500	2000
500 - 1000	5000
Above 1000	5th harmonic of the highest frequency or 40 GHz, whichever is lower.

ICES-003:

Conducted Emission : 150 kHz - 30 MHz

Radiated Emission : 30 MHz to 5thharmonic of the highest frequency or 40GHz, whichever is lower.

Highest internal frequency (F_x)	Highest measurement frequency
$F_x \leq 108$ MHz	1 GHz
$108 \text{ MHz} < F_x \leq 500$ MHz	2 GHz
$500 \text{ MHz} < F_x \leq 1$ GHz	5 GHz
$F_x > 1$ GHz	$5 \times F_x$ up to a maximum of 40 GHz

Note: F_x is the highest fundamental frequency generated and/or used in the ITE or digital apparatus under test.

Unless otherwise stated the results shown in this test report refer only to the sample(s) tested and such sample(s) are retained for 90 days only.

除非另有說明，此報告結果僅對測試之樣品負責，同時此樣品僅保留90天。本報告未經本公司書面許可，不可部份複製。

This document is issued by the Company subject to its General Conditions of Service printed overleaf, available on request or accessible at www.sgs.com/terms_and_conditions.htm and for electronic format documents, subject to Terms and Conditions for Electronic Documents at www.sgs.com/terms_e-document.htm. Attention is drawn to the limitation of liability, indemnification and jurisdiction issues defined therein. Any holder of this document is advised that information contained hereon reflects the Company's findings at the time of its intervention only and within the limits of Client's instructions, if any. The Company's sole responsibility is to its Client and this document does not exonerate parties to a transaction from exercising all their rights and obligations under the transaction documents. This document cannot be reproduced except in full, without prior written approval of the Company. Any unauthorized alteration, forgery or falsification of the content or appearance of this document is unlawful and offenders may be prosecuted to the fullest extent of the law.

2.3 Limits of Conducted and Radiated Emission

2.3.1 Limits of Conducted Emission

47 CFR FCC Part 15 Subpart B:

FREQUENCY (MHz)	Class A (dBuV)		Class B (dBuV)	
	Quasi - peak	Average	Quasi - peak	Average
0.15 - 0.5	79	66	66 - 56	56 - 46
0.50 – 5.0	73	60	56	46
5.0 – 30.0	73	60	60	50

Note : (1) The lower limit shall apply at the transition frequencies.

- (2) The limit decreases linearly with the logarithm of the frequency in the range 0.15 to 0.50 MHz.
- (3) All emanation from a class A/B digital device or system, including any network of conductors and apparatus connected there to, shall not exceed the level of field strengths specified above.

ICES-003:

FREQUENCY (MHz)	Class A (dBuV)		Class B (dBuV)	
	Quasi-peak	Average	Quasi-peak	Average
0.15 - 0.5	79	66	66 - 56*	56 - 46*
0.50 – 5.0	73	60	56	46
5.0 – 30.0	73	60	60	50

Note: The more stringent limit applies at transition frequencies.

*. The limit level in dBuV decreases linearly with the logarithm of frequency.

Unless otherwise stated the results shown in this test report refer only to the sample(s) tested and such sample(s) are retained for 90 days only.

除非另有說明，此報告結果僅對測試之樣品負責，同時此樣品僅保留90天。本報告未經本公司書面許可，不可部份複製。

This document is issued by the Company subject to its General Conditions of Service printed overleaf, available on request or accessible at www.sgs.com/terms_and_conditions.htm and for electronic format documents, subject to Terms and Conditions for Electronic Documents at www.sgs.com/terms_e-document.htm. Attention is drawn to the limitation of liability, indemnification and jurisdiction issues defined therein. Any holder of this document is advised that information contained hereon reflects the Company's findings at the time of its intervention only and within the limits of Client's instructions, if any. The Company's sole responsibility is to its Client and this document does not exonerate parties to a transaction from exercising all their rights and obligations under the transaction documents. This document cannot be reproduced except in full, without prior written approval of the Company. Any unauthorized alteration, forgery or falsification of the content or appearance of this document is unlawful and offenders may be prosecuted to the fullest extent of the law.

2.3.2 Limits of Radiated Emissions

47 CFR FCC Part 15 Subpart B Limit:

- Detector Function : Quasi – Peak

FREQUENCY (MHz)	Class A (at 10m)	Class B (at 3m)
	dBuV/m	dBuV/m
30~88	39	40
88~216	43.5	43.5
216~960	46.4	46
960~1000	49.5	54

- Detector Function : Peak , Average

FREQUENCY (MHz)	Class A (dBuV/m) (at 3m)		Class B (dBuV/m) (at 3m)	
	Peak	Average	Peak	Average
Above 1000	80	60	74	54

CISPR 22 Limit:

- Detector Function : Quasi – Peak

FREQUENCY (MHz)	Class A (at 10m)	Class B (at 10m)
	dBuV/m	dBuV/m
30~230	40	30
230~1000	47	37

NOTE 1 The lower limit shall apply at the transition frequency.

NOTE 2 Additional provisions may be required for cases where interference occurs.

Unless otherwise stated the results shown in this test report refer only to the sample(s) tested and such sample(s) are retained for 90 days only.

除非另有說明，此報告結果僅對測試之樣品負責，同時此樣品僅保留90天。本報告未經本公司書面許可，不可部份複製。

This document is issued by the Company subject to its General Conditions of Service printed overleaf, available on request or accessible at www.sgs.com/terms_and_conditions.htm and for electronic format documents, subject to Terms and Conditions for Electronic Documents at www.sgs.com/terms_e-document.htm. Attention is drawn to the limitation of liability, indemnification and jurisdiction issues defined therein. Any holder of this document is advised that information contained hereon reflects the Company's findings at the time of its intervention only and within the limits of Client's instructions, if any. The Company's sole responsibility is to its Client and this document does not exonerate parties to a transaction from exercising all their rights and obligations under the transaction documents. This document cannot be reproduced except in full, without prior written approval of the Company. Any unauthorized alteration, forgery or falsification of the content or appearance of this document is unlawful and offenders may be prosecuted to the fullest extent of the law.

ICES-003 Limit:

- Detector Function : Quasi-peak

Frequency (MHz)	Class A (3 m) (dBuV/m)	Class A (10 m) (dBuV/m)	Class B (3 m) (dBuV/m)	Class B (10 m) (dBuV/m)
30 - 88	50	40	40	30
88 - 216	54	43.5	43.5	33.1
216 - 230	56.9	46.4	46	35.6
230 - 960	57	47	47	37
960 - 1000	60	49.5	54	43.5

Note: The more stringent limit applies at transition frequencies

- Detector Function : Peak, Average

Frequency (MHz)	Class A (3 m) (dBuV/m)		Class B (3 m) (dBuV/m)	
	Peak	Average	Peak	Average
Above 1000	80	60	74	54

Unless otherwise stated the results shown in this test report refer only to the sample(s) tested and such sample(s) are retained for 90 days only.

除非另有說明，此報告結果僅對測試之樣品負責，同時此樣品僅保留90天。本報告未經本公司書面許可，不可部份複製。

This document is issued by the Company subject to its General Conditions of Service printed overleaf, available on request or accessible at www.sgs.com/terms_and_conditions.htm and for electronic format documents, subject to Terms and Conditions for Electronic Documents at www.sgs.com/terms_e-document.htm. Attention is drawn to the limitation of liability, indemnification and jurisdiction issues defined therein. Any holder of this document is advised that information contained hereon reflects the Company's findings at the time of its intervention only and within the limits of Client's instructions, if any. The Company's sole responsibility is to its Client and this document does not exonerate parties to a transaction from exercising all their rights and obligations under the transaction documents. This document cannot be reproduced except in full, without prior written approval of the Company. Any unauthorized alteration, forgery or falsification of the content or appearance of this document is unlawful and offenders may be prosecuted to the fullest extent of the law.

2.4. Test of Conducted Emission

2.4.1 Test Equipments

Conducted_Emission Conducted Room No.B_EMC					
EQUIPMENT TYPE	Manufacturer	Model Number	Serial Number	Calibration Date	Calibration Due
Coaxial Cable	EMCI	EMCRG142	190809	04/22/2022	04/21/2023
EMI Test Receiver	R&S	ESR3	102915	11/29/2021	11/28/2022
LISN	Schwarzbeck	NSLK 8127	01068	01/17/2022	01/16/2023
LISN	Schwarzbeck	NSLK 8127	01069	01/17/2022	01/16/2023
Pulse Limiter	SCHWARZBECK	VTSD 9561-F	00815	02/23/2022	02/22/2023
Software	CCS-3A1-CE				
Compliance Certification Services Inc. (Wugu Laboratory)					
Testing Site: No.139, Wugong Rd., Wugu Dist., New Taipei City, Taiwan (R.O.C.)					
Measurement Uncertainty of Conducted Emission					
Expanded uncertainty Ulab (k=2) of Conducted Emission is 3.06 dB.					
Expanded uncertainty CISPR 16-4-2:2011+A1:2014+A2:2018 (k=2) of Conducted Emission measurement is 3.44 dB					

2.4.2 Measurement Level Calculation

Factor = LISN insertion loss + Cable loss + Pulse Limiter insertion loss

Measurement Level = Reading Level + Factor

Over (Margin) = Measurement Level – Limit

Unless otherwise stated the results shown in this test report refer only to the sample(s) tested and such sample(s) are retained for 90 days only.

除非另有說明，此報告結果僅對測試之樣品負責，同時此樣品僅保留90天。本報告未經本公司書面許可，不可部份複製。

This document is issued by the Company subject to its General Conditions of Service printed overleaf, available on request or accessible at www.sgs.com/terms_and_conditions.htm and for electronic format documents, subject to Terms and Conditions for Electronic Documents at www.sgs.com/terms_e-document.htm. Attention is drawn to the limitation of liability, indemnification and jurisdiction issues defined therein. Any holder of this document is advised that information contained hereon reflects the Company's findings at the time of its intervention only and within the limits of Client's instructions, if any. The Company's sole responsibility is to its Client and this document does not exonerate parties to a transaction from exercising all their rights and obligations under the transaction documents. This document cannot be reproduced except in full, without prior written approval of the Company. Any unauthorized alteration, forgery or falsification of the content or appearance of this document is unlawful and offenders may be prosecuted to the fullest extent of the law.

2.4.3 Measurement Data:

Model no.	HSC-I006R	Line:	L1
Environmental Conditions	24°C, 46% RH	Tested Date	2022/07/01
Test Mode	Mode 5	Tested By	Thomas Liu
6dB Bandwidth	9 kHz	Identifier number	TCOP CE site 17

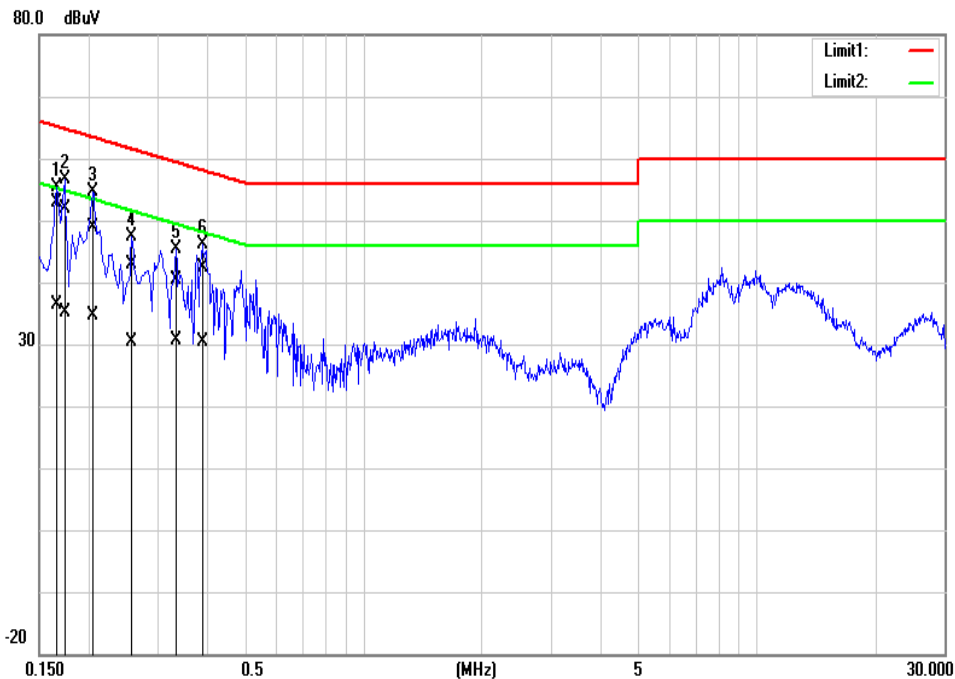

NO.	Frequency (MHz)	Quasi Peak reading (dBuV)	Average reading (dBuV)	Correction factor (dB)	Quasi Peak result (dBuV)	Average result (dBuV)	Quasi Peak limit (dBuV)	Average limit (dBuV)	Quasi Peak margin (dB)	Average margin (dB)	Remark (Pass/Fail)
1*	0.1660	42.63	26.07	10.27	52.90	36.34	65.15	55.16	-12.25	-18.82	Pass
2	0.1740	41.71	24.81	10.27	51.98	35.08	64.76	54.77	-12.78	-19.69	Pass
3	0.2060	38.72	24.40	10.28	49.00	34.68	63.36	53.37	-14.36	-18.69	Pass
4	0.2580	32.55	20.18	10.28	42.83	30.46	61.49	51.50	-18.66	-21.04	Pass
5	0.3339	30.15	20.33	10.29	40.44	30.62	59.35	49.35	-18.91	-18.73	Pass
6	0.3899	32.20	20.10	10.29	42.49	30.39	58.06	48.07	-15.57	-17.68	Pass

Note: L1 = Live Line

Unless otherwise stated the results shown in this test report refer only to the sample(s) tested and such sample(s) are retained for 90 days only.

除非另有說明，此報告結果僅對測試之樣品負責，同時此樣品僅保留90天。本報告未經本公司書面許可，不可部份複製。

This document is issued by the Company subject to its General Conditions of Service printed overleaf, available on request or accessible at www.sgs.com/terms_and_conditions.htm and for electronic format documents, subject to Terms and Conditions for Electronic Documents at www.sgs.com/terms_e-document.htm. Attention is drawn to the limitation of liability, indemnification and jurisdiction issues defined therein. Any holder of this document is advised that information contained hereon reflects the Company's findings at the time of its intervention only and within the limits of Client's instructions, if any. The Company's sole responsibility is to its Client and this document does not exonerate parties to a transaction from exercising all their rights and obligations under the transaction documents. This document cannot be reproduced except in full, without prior written approval of the Company. Any unauthorized alteration, forgery or falsification of the content or appearance of this document is unlawful and offenders may be prosecuted to the fullest extent of the law.

Model no.	HSC-I006R	Line:	N
Environmental Conditions	24°C, 46% RH	Tested Date	2022/07/01
Test Mode	Mode 5	Tested By	Thomas Liu
6dB Bandwidth	9 kHz	Identifier number	TCOP CE site 17

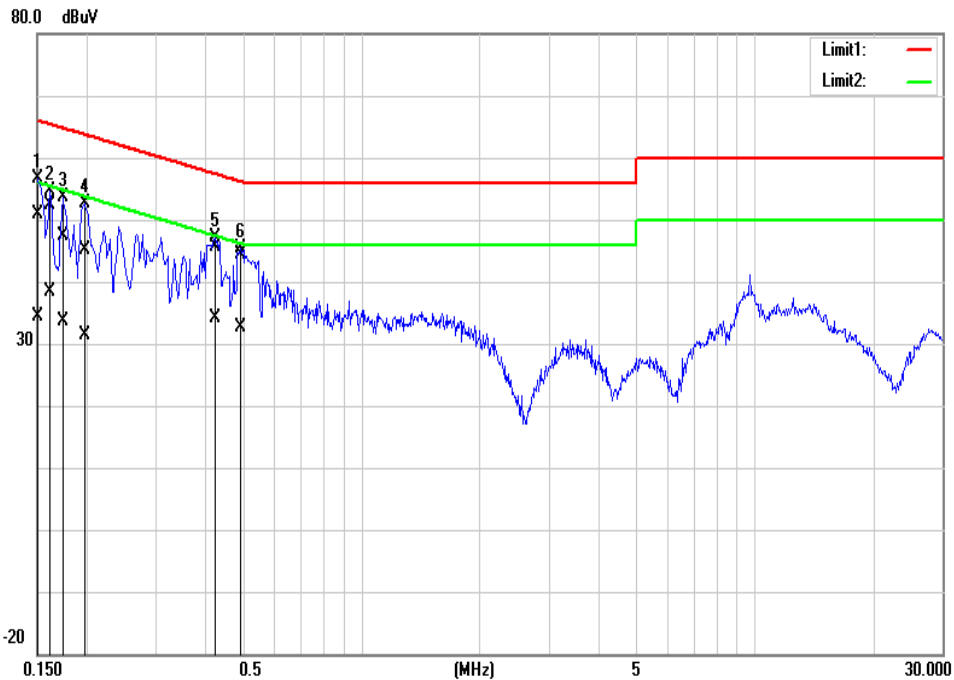

NO.	Frequency (MHz)	Quasi Peak reading (dBuV)	Average reading (dBuV)	Correction factor (dB)	Quasi Peak result (dBuV)	Average result (dBuV)	Quasi Peak limit (dBuV)	Average limit (dBuV)	Quasi Peak margin (dB)	Average margin (dB)	Remark (Pass/Fail)
1	0.1500	40.53	24.19	10.25	50.78	34.44	65.99	56.00	-15.21	-21.56	Pass
2	0.1620	42.13	28.23	10.25	52.38	38.48	65.36	55.36	-12.98	-16.88	Pass
3	0.1740	37.17	23.34	10.25	47.42	33.59	64.76	54.77	-17.34	-21.18	Pass
4	0.1980	34.92	21.02	10.26	45.18	31.28	63.69	53.69	-18.51	-22.41	Pass
5*	0.4260	35.43	23.90	10.27	45.70	34.17	57.33	47.33	-11.63	-13.16	Pass
6	0.4940	34.01	22.34	10.27	44.28	32.61	56.10	46.10	-11.82	-13.49	Pass

Note: N = Neutral Line

Unless otherwise stated the results shown in this test report refer only to the sample(s) tested and such sample(s) are retained for 90 days only.

除非另有說明，此報告結果僅對測試之樣品負責，同時此樣品僅保留90天。本報告未經本公司書面許可，不可部份複製。

This document is issued by the Company subject to its General Conditions of Service printed overleaf, available on request or accessible at www.sgs.com/terms_and_conditions.htm and for electronic format documents, subject to Terms and Conditions for Electronic Documents at www.sgs.com/terms_e-document.htm. Attention is drawn to the limitation of liability, indemnification and jurisdiction issues defined therein. Any holder of this document is advised that information contained hereon reflects the Company's findings at the time of its intervention only and within the limits of Client's instructions, if any. The Company's sole responsibility is to its Client and this document does not exonerate parties to a transaction from exercising all their rights and obligations under the transaction documents. This document cannot be reproduced except in full, without prior written approval of the Company. Any unauthorized alteration, forgery or falsification of the content or appearance of this document is unlawful and offenders may be prosecuted to the fullest extent of the law.

Model no.	HSC-I006R	Line:	L1
Environmental Conditions	24°C, 46% RH	Tested Date	2022/07/01
Test Mode	Mode 9	Tested By	Thomas Liu
6dB Bandwidth	9 kHz	Identifier number	TCOP CE site 17

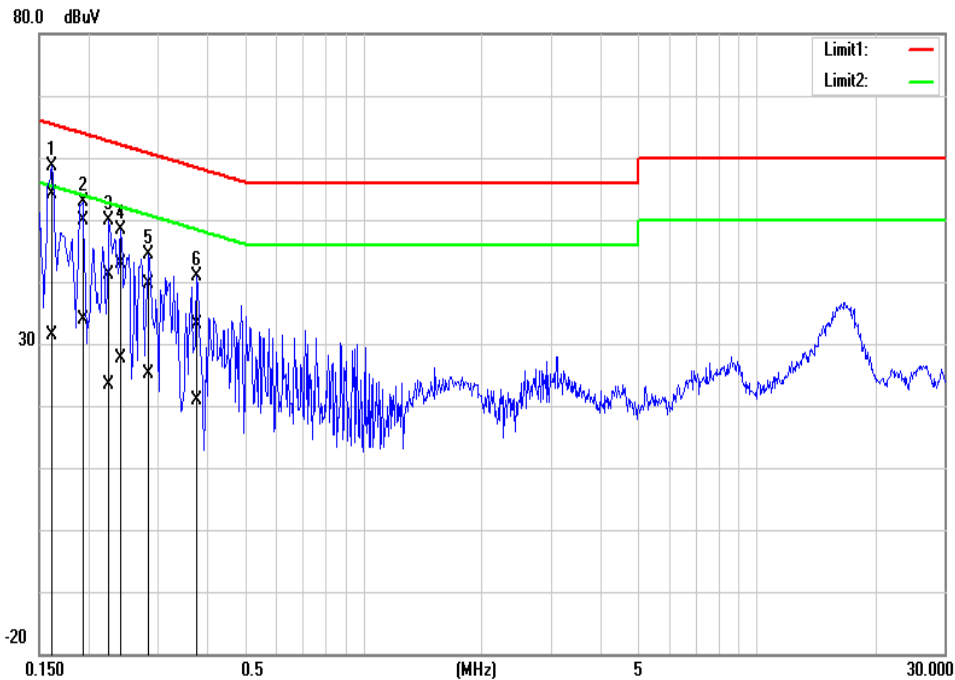

NO.	Frequency (MHz)	Quasi Peak reading (dBuV)	Average reading (dBuV)	Correction factor (dB)	Quasi Peak result (dBuV)	Average result (dBuV)	Quasi Peak limit (dBuV)	Average limit (dBuV)	Quasi Peak margin (dB)	Average margin (dB)	Remark (Pass/Fail)
1*	0.1620	43.98	21.19	10.27	54.25	31.46	65.36	55.36	-11.11	-23.90	Pass
2	0.1940	39.55	23.70	10.28	49.83	33.98	63.86	53.86	-14.03	-19.88	Pass
3	0.2260	30.83	13.19	10.28	41.11	23.47	62.59	52.60	-21.48	-29.13	Pass
4	0.2420	32.57	17.47	10.28	42.85	27.75	62.02	52.03	-19.17	-24.28	Pass
5	0.2860	29.47	14.82	10.28	39.75	25.10	60.64	50.64	-20.89	-25.54	Pass
6	0.3780	22.75	10.64	10.29	33.04	20.93	58.32	48.32	-25.28	-27.39	Pass

Note: L1 = Live Line

Unless otherwise stated the results shown in this test report refer only to the sample(s) tested and such sample(s) are retained for 90 days only.

除非另有說明，此報告結果僅對測試之樣品負責，同時此樣品僅保留90天。本報告未經本公司書面許可，不可部份複製。

This document is issued by the Company subject to its General Conditions of Service printed overleaf, available on request or accessible at www.sgs.com/terms_and_conditions.htm and for electronic format documents, subject to Terms and Conditions for Electronic Documents at www.sgs.com/terms_e-document.htm. Attention is drawn to the limitation of liability, indemnification and jurisdiction issues defined therein. Any holder of this document is advised that information contained hereon reflects the Company's findings at the time of its intervention only and within the limits of Client's instructions, if any. The Company's sole responsibility is to its Client and this document does not exonerate parties to a transaction from exercising all their rights and obligations under the transaction documents. This document cannot be reproduced except in full, without prior written approval of the Company. Any unauthorized alteration, forgery or falsification of the content or appearance of this document is unlawful and offenders may be prosecuted to the fullest extent of the law.

Model no.	HSC-I006R	Line:	N
Environmental Conditions	24°C, 46% RH	Tested Date	2022/07/01
Test Mode	Mode 9	Tested By	Thomas Liu
6dB Bandwidth	9 kHz	Identifier number	TCOP CE site 17

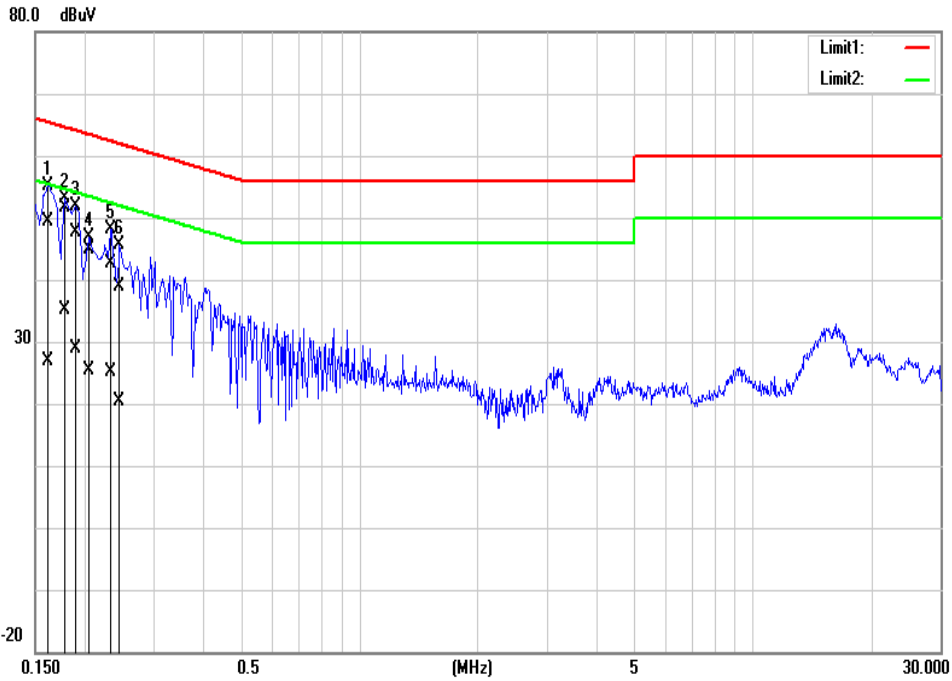

NO.	Frequency (MHz)	Quasi Peak reading (dBuV)	Average reading (dBuV)	Correction factor (dB)	Quasi Peak result (dBuV)	Average result (dBuV)	Quasi Peak limit (dBuV)	Average limit (dBuV)	Quasi Peak margin (dB)	Average margin (dB)	Remark (Pass/Fail)
1	0.1620	39.14	16.52	10.25	49.39	26.77	65.36	55.36	-15.97	-28.59	Pass
2*	0.1780	41.45	24.92	10.26	51.71	35.18	64.57	54.58	-12.86	-19.40	Pass
3	0.1900	37.49	18.58	10.26	47.75	28.84	64.03	54.04	-16.28	-25.20	Pass
4	0.2060	34.60	15.18	10.26	44.86	25.44	63.36	53.37	-18.50	-27.93	Pass
5	0.2340	32.29	14.98	10.26	42.55	25.24	62.30	52.31	-19.75	-27.07	Pass
6	0.2460	28.57	10.15	10.26	38.83	20.41	61.89	51.89	-23.06	-31.48	Pass

Note: N = Neutral Line

Unless otherwise stated the results shown in this test report refer only to the sample(s) tested and such sample(s) are retained for 90 days only.

除非另有說明，此報告結果僅對測試之樣品負責，同時此樣品僅保留90天。本報告未經本公司書面許可，不可部份複製。

This document is issued by the Company subject to its General Conditions of Service printed overleaf, available on request or accessible at www.sgs.com/terms_and_conditions.htm and for electronic format documents, subject to Terms and Conditions for Electronic Documents at www.sgs.com/terms_e-document.htm. Attention is drawn to the limitation of liability, indemnification and jurisdiction issues defined therein. Any holder of this document is advised that information contained hereon reflects the Company's findings at the time of its intervention only and within the limits of Client's instructions, if any. The Company's sole responsibility is to its Client and this document does not exonerate parties to a transaction from exercising all their rights and obligations under the transaction documents. This document cannot be reproduced except in full, without prior written approval of the Company. Any unauthorized alteration, forgery or falsification of the content or appearance of this document is unlawful and offenders may be prosecuted to the fullest extent of the law.

Model no.	HSC-I006R	Line:	L1
Environmental Conditions	25°C, 52% RH	Tested Date	2022/07/02
Test Mode	Mode 10	Tested By	Thomas Liu
6dB Bandwidth	9 kHz	Identifier number	TCOP CE site 17

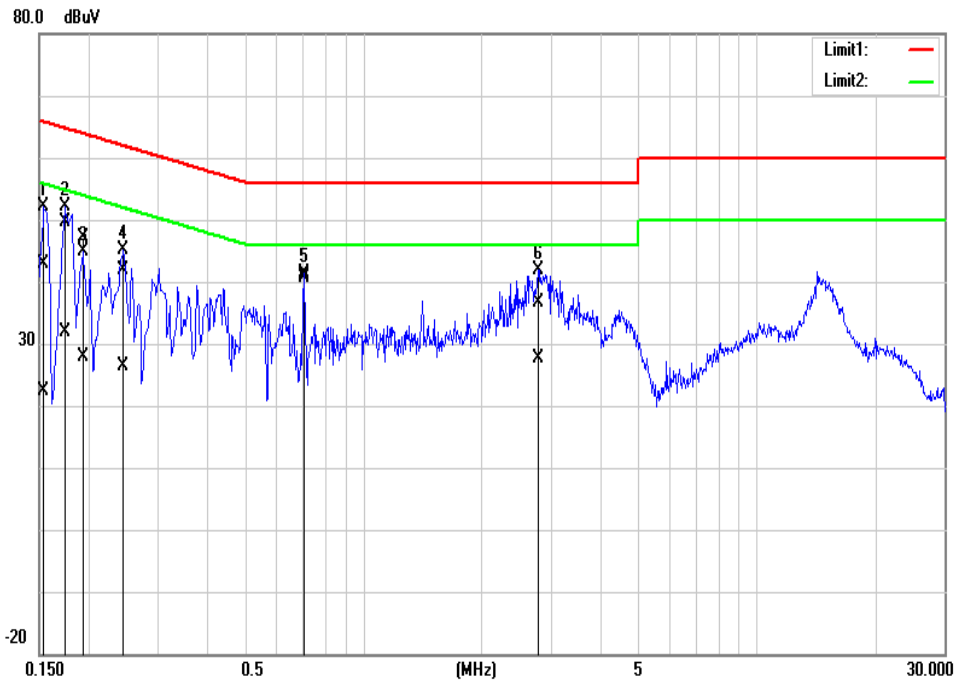

NO.	Frequency (MHz)	Quasi Peak reading (dBuV)	Average reading (dBuV)	Correction factor (dB)	Quasi Peak result (dBuV)	Average result (dBuV)	Quasi Peak limit (dBuV)	Average limit (dBuV)	Quasi Peak margin (dB)	Average margin (dB)	Remark (Pass/Fail)
1	0.1539	32.65	12.04	10.27	42.92	22.31	65.78	55.79	-22.86	-33.48	Pass
2	0.1740	39.38	21.58	10.27	49.65	31.85	64.76	54.77	-15.11	-22.92	Pass
3	0.1940	36.81	17.71	10.28	47.09	27.99	63.86	53.86	-16.77	-25.87	Pass
4	0.2460	31.69	16.04	10.28	41.97	26.32	61.89	51.89	-19.92	-25.57	Pass
5*	0.7060	30.76	30.23	10.31	41.07	40.54	56.00	46.00	-14.93	-5.46	Pass
6	2.7820	26.38	17.16	10.37	36.75	27.53	56.00	46.00	-19.25	-18.47	Pass

Note: L1 = Live Line

Unless otherwise stated the results shown in this test report refer only to the sample(s) tested and such sample(s) are retained for 90 days only.

除非另有說明，此報告結果僅對測試之樣品負責，同時此樣品僅保留90天。本報告未經本公司書面許可，不可部份複製。

This document is issued by the Company subject to its General Conditions of Service printed overleaf, available on request or accessible at www.sgs.com/terms_and_conditions.htm and for electronic format documents, subject to Terms and Conditions for Electronic Documents at www.sgs.com/terms_e-document.htm. Attention is drawn to the limitation of liability, indemnification and jurisdiction issues defined therein. Any holder of this document is advised that information contained hereon reflects the Company's findings at the time of its intervention only and within the limits of Client's instructions, if any. The Company's sole responsibility is to its Client and this document does not exonerate parties to a transaction from exercising all their rights and obligations under the transaction documents. This document cannot be reproduced except in full, without prior written approval of the Company. Any unauthorized alteration, forgery or falsification of the content or appearance of this document is unlawful and offenders may be prosecuted to the fullest extent of the law.

Model no.	HSC-I006R	Line:	N
Environmental Conditions	25°C, 52% RH	Tested Date	2022/07/02
Test Mode	Mode 10	Tested By	Thomas Liu
6dB Bandwidth	9 kHz	Identifier number	TCOP CE site 17

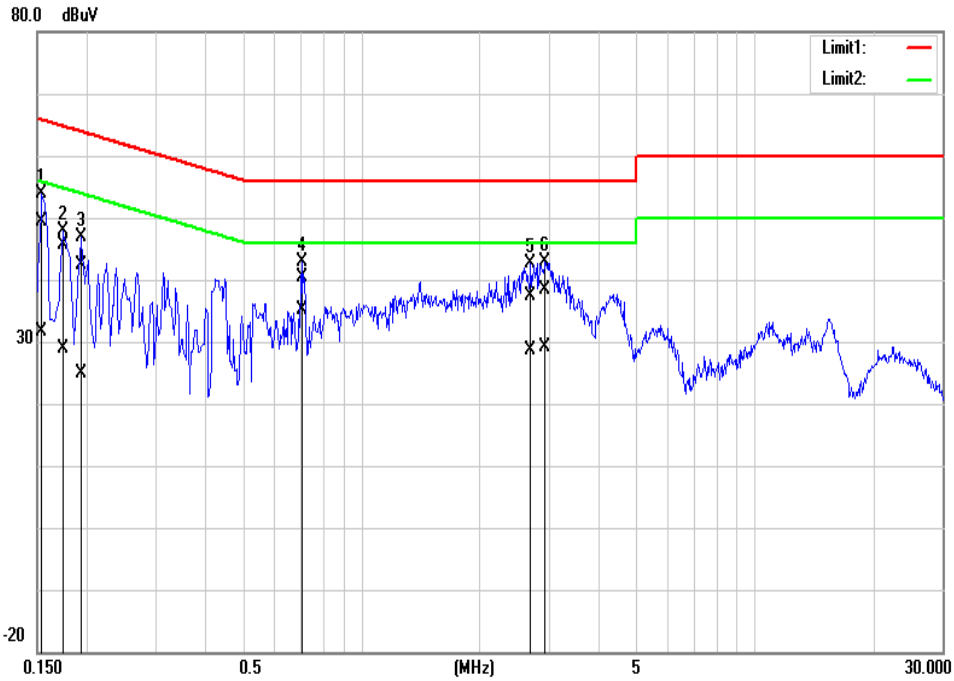

NO.	Frequency (MHz)	Quasi Peak reading (dBuV)	Average reading (dBuV)	Correction factor (dB)	Quasi Peak result (dBuV)	Average result (dBuV)	Quasi Peak limit (dBuV)	Average limit (dBuV)	Quasi Peak margin (dB)	Average margin (dB)	Remark (Pass/Fail)
1	0.1539	39.21	21.32	10.25	49.46	31.57	65.78	55.79	-16.32	-24.22	Pass
2	0.1740	35.38	18.61	10.25	45.63	28.86	64.76	54.77	-19.13	-25.91	Pass
3	0.1940	32.17	14.67	10.26	42.43	24.93	63.86	53.86	-21.43	-28.93	Pass
4*	0.7060	30.11	24.74	10.29	40.40	35.03	56.00	46.00	-15.60	-10.97	Pass
5	2.7060	27.11	18.32	10.35	37.46	28.67	56.00	46.00	-18.54	-17.33	Pass
6	2.9340	27.95	18.74	10.35	38.30	29.09	56.00	46.00	-17.70	-16.91	Pass

Note: N = Neutral Line

Unless otherwise stated the results shown in this test report refer only to the sample(s) tested and such sample(s) are retained for 90 days only.

除非另有說明，此報告結果僅對測試之樣品負責，同時此樣品僅保留90天。本報告未經本公司書面許可，不可部份複製。

This document is issued by the Company subject to its General Conditions of Service printed overleaf, available on request or accessible at www.sgs.com/terms_and_conditions.htm and for electronic format documents, subject to Terms and Conditions for Electronic Documents at www.sgs.com/terms_e-document.htm. Attention is drawn to the limitation of liability, indemnification and jurisdiction issues defined therein. Any holder of this document is advised that information contained hereon reflects the Company's findings at the time of its intervention only and within the limits of Client's instructions, if any. The Company's sole responsibility is to its Client and this document does not exonerate parties to a transaction from exercising all their rights and obligations under the transaction documents. This document cannot be reproduced except in full, without prior written approval of the Company. Any unauthorized alteration, forgery or falsification of the content or appearance of this document is unlawful and offenders may be prosecuted to the fullest extent of the law.

2.5 Test of Radiated Emission

2.5.1 Test Equipments

Below 1GHz

Radiated_Below_1GHz 10m EMC					
EQUIPMENT TYPE	Manufacturer	Model Number	Serial Number	Calibration Date	Calibration Due
Bilog Antenna	TESEQ	CBL 6112D	31674	02/15/2022	02/14/2023
Bilog Antenna	TESEQ	CBL 6112D	31675	03/11/2022	03/10/2023
Coaxial Cable	Huber+Suhner	SUCOFLEX 104PEA	330029	04/22/2022	04/21/2023
Coaxial Cable	Huber+Suhner	104PEA	33948/4PEA	04/22/2022	04/21/2023
Coaxial Cable	Huber+Suhner	104PEA	33949/4PEA	04/22/2022	04/21/2023
Coaxial Cable	Huber+Suhner	SUCOFLEX 104PEA	24813	04/22/2022	04/21/2023
EMI Test Receiver	R&S	ESCI	100961	05/11/2022	05/10/2023
EMI Test Receiver	R&S	ESCI	100962	05/19/2022	05/18/2023
Pre-Amplifier	HP	8447D	2944A07754	04/22/2022	04/21/2023
Pre-Amplifier	HP	8447D	2944A08150	04/22/2022	04/21/2023
AC POWER SOURCE	APE	AFC-130	991259	N.C.R	N.C.R
Antenna Tower	CCS	CC-A-1F	N/A	N.C.R	N.C.R
Antenna Tower	CCS	CC-A-1F	N/A	N.C.R	N.C.R
Controller	CCS	CC-C-1F	N/A	N.C.R	N.C.R
Controller	CCS	CC-C-1F	N/A	N.C.R	N.C.R
Turn Table	CCS	CC-T-1F	N/A	N.C.R	N.C.R
Software	EZ-EMC (CCS-3A1RE)				
Compliance Certification Services Inc. (Wugu Laboratory)					
Testing Site: No.139, Wugong Rd., Wugu Dist., New Taipei City, Taiwan (R.O.C.)					
Measurement Uncertainty of Radiated Emission					
Expanded uncertainty Ulab (k=2) of Radiated Emission is 4.41 dB. (30MHz-1GHz)					
Expanded uncertainty CISPR 16-4-2:2011+A1:2014+A2:2018 (k=2) of Radiated Emission measurement is 5.22 dB. (30MHz-1GHz)					

Unless otherwise stated the results shown in this test report refer only to the sample(s) tested and such sample(s) are retained for 90 days only.

除非另有說明，此報告結果僅對測試之樣品負責，同時此樣品僅保留90天。本報告未經本公司書面許可，不可部份複製。

This document is issued by the Company subject to its General Conditions of Service printed overleaf, available on request or accessible at www.sgs.com/terms_and_conditions.htm and for electronic format documents, subject to Terms and Conditions for Electronic Documents at www.sgs.com/terms_e-document.htm. Attention is drawn to the limitation of liability, indemnification and jurisdiction issues defined therein. Any holder of this document is advised that information contained hereon reflects the Company's findings at the time of its intervention only and within the limits of Client's instructions, if any. The Company's sole responsibility is to its Client and this document does not exonerate parties to a transaction from exercising all their rights and obligations under the transaction documents. This document cannot be reproduced except in full, without prior written approval of the Company. Any unauthorized alteration, forgery or falsification of the content or appearance of this document is unlawful and offenders may be prosecuted to the fullest extent of the law.

Above 1GHz

Radiated_Above_1GHz 10m EMC					
EQUIPMENT TYPE	Manufacturer	Model Number	Serial Number	Calibration Date	Calibration Due
Band Reject Filters	MICRO TRONICS	BRM 50702	112	11/23/2021	11/22/2022
Coaxial Cable	Huber+Suhner	SUCOFLEX 104PEA	329383	04/22/2022	04/21/2023
Coaxial Cable	Huber+Suhner	SUCOFLEX 104PEA	33945	04/22/2022	04/21/2023
Horn Antenna	ETS LINDGREN	3116	00026370	11/30/2021	11/29/2022
Horn Antenna	EMCO	3117	00055167	11/25/2021	11/24/2022
Pre-Amplifier	EMCI	EMC051845	980040	04/22/2022	04/21/2023
Pre-Amplifier	MITEQ	AMF-6F-18004000-37-8P	985646	09/08/2021	09/07/2022
Spectrum Analyzer	Agilent	E4446A	MY48250297	08/18/2021	08/17/2022
AC POWER SOURCE	APE	AFC-130	991259	N.C.R	N.C.R
Antenna Tower	Sunol Sciences	TLT2	031010-5	N.C.R	N.C.R
Controller	Sunol Sciences	SC104V	031010-1	N.C.R	N.C.R
Turn Table	CCS	CC-T-1F	N/A	N.C.R	N.C.R
Software	EZ-EMC (CCS-3A1RE)				
Compliance Certification Services Inc. (Wugu Laboratory)					
Testing Site: No.139, Wugong Rd., Wugu Dist., New Taipei City, Taiwan (R.O.C.)					
Measurement Uncertainty of Radiated Emission					
Expanded uncertainty Ulab (k=2) of Radiated Emission measurement is 4.97 dB. (1-6GHz)					
Expanded uncertainty Ulab (k=2) of Radiated Emission measurement is 5.13 dB. (6-18GHz)					
Expanded uncertainty Ulab (k=2) of Radiated Emission measurement is 3.94 dB. (18-40GHz)					
Expanded uncertainty CISPR 16-4-2:2011+A1:2014+A2:2018 (k=2) of Radiated Emission measurement is 5.18 dB. (1-6GHz)					
Expanded uncertainty CISPR 16-4-2:2011+A1:2014+A2:2018 (k=2) of Radiated Emission measurement is 5.48 dB. (6-18GHz)					
Expanded uncertainty CISPR 16-4-2:2011+A1:2014+A2:2018 (k=2) of Radiated Emission measurement is --- dB. (18-40GHz)					

2.5.2 Measurement Level Calculation

Correction Factor = Antenna Factor + Cable loss - Amplifier Gain

Measurement Level = Reading Level + Correction Factor

Over (Margin) = Measurement Level – Limit

Unless otherwise stated the results shown in this test report refer only to the sample(s) tested and such sample(s) are retained for 90 days only.

除非另有說明，此報告結果僅對測試之樣品負責，同時此樣品僅保留90天。本報告未經本公司書面許可，不可部份複製。

This document is issued by the Company subject to its General Conditions of Service printed overleaf, available on request or accessible at www.sgs.com/terms_and_conditions.htm and for electronic format documents, subject to Terms and Conditions for Electronic Documents at www.sgs.com/terms_e-document.htm. Attention is drawn to the limitation of liability, indemnification and jurisdiction issues defined therein. Any holder of this document is advised that information contained hereon reflects the Company's findings at the time of its intervention only and within the limits of Client's instructions, if any. The Company's sole responsibility is to its Client and this document does not exonerate parties to a transaction from exercising all their rights and obligations under the transaction documents. This document cannot be reproduced except in full, without prior written approval of the Company. Any unauthorized alteration, forgery or falsification of the content or appearance of this document is unlawful and offenders may be prosecuted to the fullest extent of the law.

2.5.3 Measurement Data

Below 1GHz

Model no.	HSC-I006R	Test Mode	Mode 5
Environmental Conditions	26°C, 60% RH	Tested Date	2022/07/08
Antenna Pole	Vertical	Antenna Distance	10m
Detector Function	Quasi-peak.	Tested By	Lowka Chen
6dB Bandwidth	120 kHz	Identifier number	TCOP RE site 17
Standard	FCC Part 15 Subpart B		

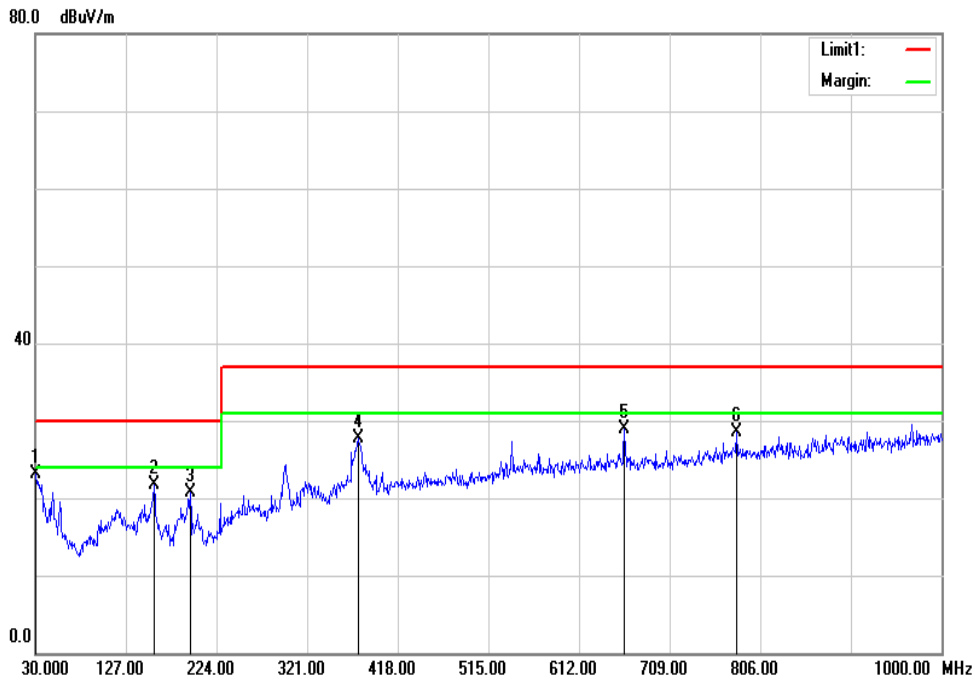

No.	Frequency (MHz)	Reading (dBuV)	Correction Factor (dB/m)	Result (dBuV/m)	Limit (dBuV/m)	Margin (dB)	Height (cm)	Degree (°)	Remark
1	30.9700	26.29	-3.18	23.11	30.00	-6.89	100	20	QP
2	157.0700	30.65	-9.04	21.61	30.00	-8.39	100	0	QP
3	195.8700	30.12	-9.50	20.62	30.00	-9.38	100	160	QP
4	375.3200	30.17	-2.42	27.75	37.00	-9.25	100	320	QP
5	660.5000	27.13	1.86	28.99	37.00	-8.01	199	358	QP
6	780.7800	25.03	3.39	28.42	37.00	-8.58	199	326	QP

REMARKS: The other emission levels were very low against the limit.

Unless otherwise stated the results shown in this test report refer only to the sample(s) tested and such sample(s) are retained for 90 days only.
除非另有說明，此報告結果僅對測試之樣品負責，同時此樣品僅保留90天。本報告未經本公司書面許可，不可部份複製。

This document is issued by the Company subject to its General Conditions of Service printed overleaf, available on request or accessible at www.sgs.com/terms_and_conditions.htm and for electronic format documents, subject to Terms and Conditions for Electronic Documents at www.sgs.com/terms_e-document.htm. Attention is drawn to the limitation of liability, indemnification and jurisdiction issues defined therein. Any holder of this document is advised that information contained hereon reflects the Company's findings at the time of its intervention only and within the limits of Client's instructions, if any. The Company's sole responsibility is to its Client and this document does not exonerate parties to a transaction from exercising all their rights and obligations under the transaction documents. This document cannot be reproduced except in full, without prior written approval of the Company. Any unauthorized alteration, forgery or falsification of the content or appearance of this document is unlawful and offenders may be prosecuted to the fullest extent of the law.

Model no.	HSC-I006R	Test Mode	Mode 5
Environmental Conditions	26°C, 60% RH	Tested Date	2022/07/08
Antenna Pole	Horizontal	Antenna Distance	10m
Detector Function	Quasi-peak.	Tested By	Lowka Chen
6dB Bandwidth	120 kHz	Identifier number	TCOP RE site 17
Standard	FCC Part 15 Subpart B		

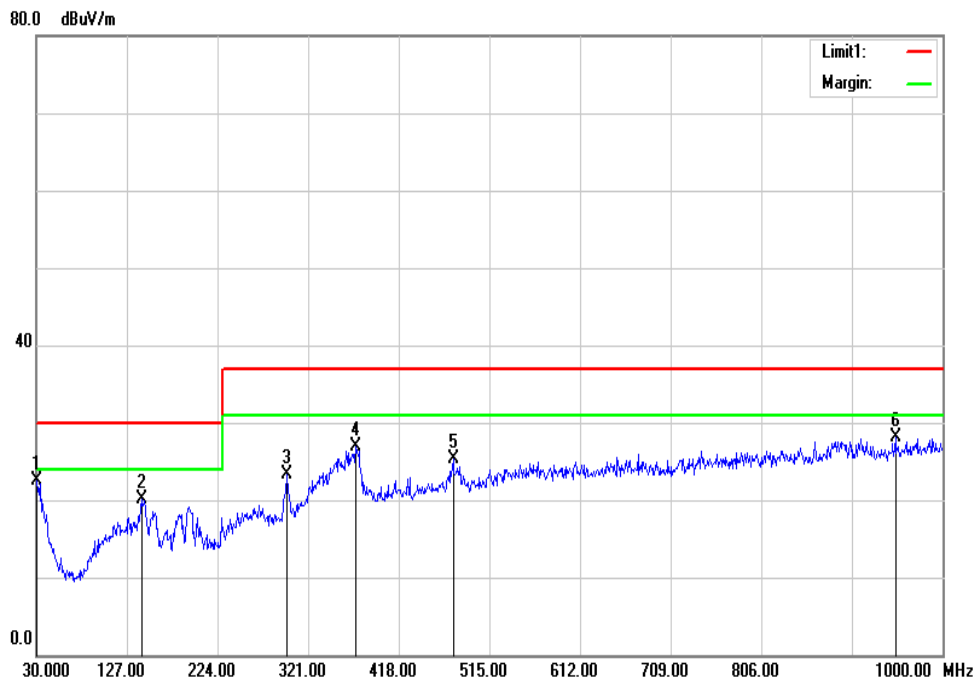

No.	Frequency (MHz)	Reading (dBuV)	Correction Factor (dB/m)	Result (dBuV/m)	Limit (dBuV/m)	Margin (dB)	Height (cm)	Degree (°)	Remark
1	30.9700	26.33	-3.86	22.47	30.00	-7.53	300	0	QP
2	142.5200	29.56	-9.54	20.02	30.00	-9.98	400	356	QP
3	298.6900	29.28	-6.07	23.21	37.00	-13.79	300	39	QP
4	371.4400	31.17	-4.28	26.89	37.00	-10.11	300	0	QP
5	476.2000	27.78	-2.42	25.36	37.00	-11.64	400	359	QP
6	949.5600	24.51	3.54	28.05	37.00	-8.95	400	80	QP

REMARKS: The other emission levels were very low against the limit.

Unless otherwise stated the results shown in this test report refer only to the sample(s) tested and such sample(s) are retained for 90 days only.

除非另有說明，此報告結果僅對測試之樣品負責，同時此樣品僅保留90天。本報告未經本公司書面許可，不可部份複製。

This document is issued by the Company subject to its General Conditions of Service printed overleaf, available on request or accessible at www.sgs.com/terms_and_conditions.htm and for electronic format documents, subject to Terms and Conditions for Electronic Documents at www.sgs.com/terms_e-document.htm. Attention is drawn to the limitation of liability, indemnification and jurisdiction issues defined therein. Any holder of this document is advised that information contained hereon reflects the Company's findings at the time of its intervention only and within the limits of Client's instructions, if any. The Company's sole responsibility is to its Client and this document does not exonerate parties to a transaction from exercising all their rights and obligations under the transaction documents. This document cannot be reproduced except in full, without prior written approval of the Company. Any unauthorized alteration, forgery or falsification of the content or appearance of this document is unlawful and offenders may be prosecuted to the fullest extent of the law.

Model no.	HSC-I006R	Test Mode	Mode 9
Environmental Conditions	26°C, 60% RH	Tested Date	2022/07/08
Antenna Pole	Vertical	Antenna Distance	10m
Detector Function	Quasi-peak.	Tested By	Lowka Chen
6dB Bandwidth	120 kHz	Identifier number	TCOP RE site 17
Standard	FCC Part 15 Subpart B		

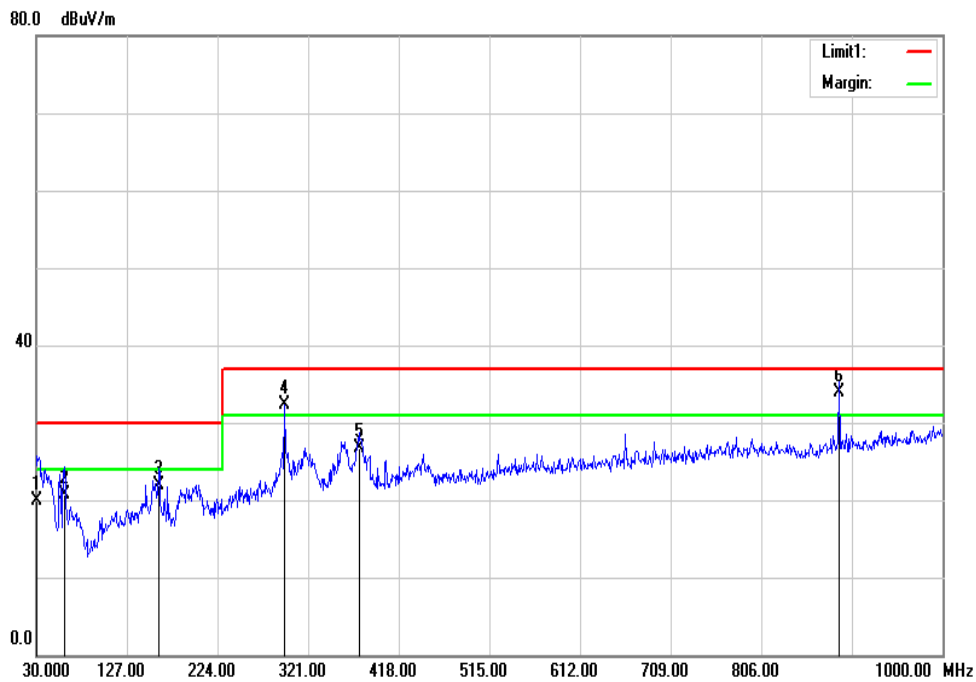

No.	Frequency (MHz)	Reading (dBuV)	Correction Factor (dB/m)	Result (dBuV/m)	Limit (dBuV/m)	Margin (dB)	Height (cm)	Degree (°)	Remark
1	30.9700	23.15	-3.18	19.97	30.00	-10.03	100	297	QP
2	60.0700	35.15	-14.40	20.75	30.00	-9.25	199	0	QP
3	160.9500	31.03	-9.20	21.83	30.00	-8.17	100	0	QP
4	295.7800	36.88	-4.65	32.23	37.00	-4.77	100	359	QP
5	375.3200	29.14	-2.42	26.72	37.00	-10.28	100	359	QP
6	889.4200	29.01	4.85	33.86	37.00	-3.14	199	326	QP

REMARKS: The other emission levels were very low against the limit.

Unless otherwise stated the results shown in this test report refer only to the sample(s) tested and such sample(s) are retained for 90 days only.

除非另有說明，此報告結果僅對測試之樣品負責，同時此樣品僅保留90天。本報告未經本公司書面許可，不可部份複製。

This document is issued by the Company subject to its General Conditions of Service printed overleaf, available on request or accessible at www.sgs.com/terms_and_conditions.htm and for electronic format documents, subject to Terms and Conditions for Electronic Documents at www.sgs.com/terms_e-document.htm. Attention is drawn to the limitation of liability, indemnification and jurisdiction issues defined therein. Any holder of this document is advised that information contained hereon reflects the Company's findings at the time of its intervention only and within the limits of Client's instructions, if any. The Company's sole responsibility is to its Client and this document does not exonerate parties to a transaction from exercising all their rights and obligations under the transaction documents. This document cannot be reproduced except in full, without prior written approval of the Company. Any unauthorized alteration, forgery or falsification of the content or appearance of this document is unlawful and offenders may be prosecuted to the fullest extent of the law.

Model no.	HSC-I006R	Test Mode	Mode 9
Environmental Conditions	26°C, 60% RH	Tested Date	2022/07/08
Antenna Pole	Horizontal	Antenna Distance	10m
Detector Function	Quasi-peak.	Tested By	Lowka Chen
6dB Bandwidth	120 kHz	Identifier number	TCOP RE site 17
Standard	FCC Part 15 Subpart B		

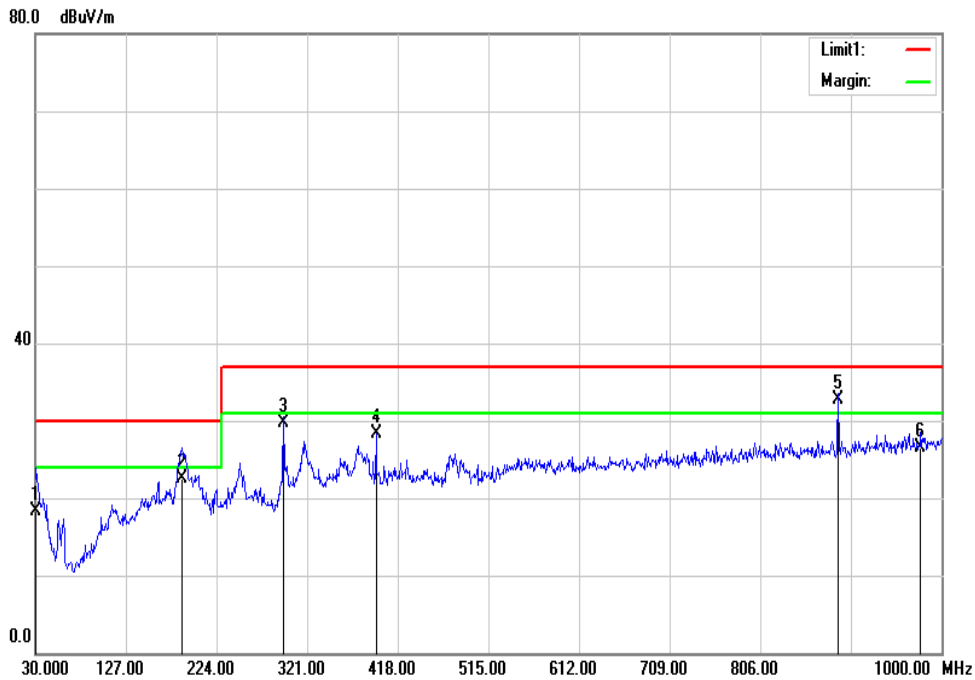

No.	Frequency (MHz)	Reading (dBuV)	Correction Factor (dB/m)	Result (dBuV/m)	Limit (dBuV/m)	Margin (dB)	Height (cm)	Degree (°)	Remark
1	30.0000	21.59	-3.35	18.24	30.00	-11.76	400	215	QP
2	187.1400	33.43	-10.90	22.53	30.00	-7.47	400	17	QP
3	295.7800	35.78	-6.11	29.67	37.00	-7.33	400	330	QP
4	394.7200	31.98	-3.66	28.32	37.00	-8.68	300	342	QP
5	889.4200	30.02	2.78	32.80	37.00	-4.20	300	0	QP
6	977.6900	22.65	3.89	26.54	37.00	-10.46	300	194	QP

REMARKS: The other emission levels were very low against the limit.

Unless otherwise stated the results shown in this test report refer only to the sample(s) tested and such sample(s) are retained for 90 days only.

除非另有說明，此報告結果僅對測試之樣品負責，同時此樣品僅保留90天。本報告未經本公司書面許可，不可部份複製。

This document is issued by the Company subject to its General Conditions of Service printed overleaf, available on request or accessible at www.sgs.com/terms_and_conditions.htm and for electronic format documents, subject to Terms and Conditions for Electronic Documents at www.sgs.com/terms_e-document.htm. Attention is drawn to the limitation of liability, indemnification and jurisdiction issues defined therein. Any holder of this document is advised that information contained hereon reflects the Company's findings at the time of its intervention only and within the limits of Client's instructions, if any. The Company's sole responsibility is to its Client and this document does not exonerate parties to a transaction from exercising all their rights and obligations under the transaction documents. This document cannot be reproduced except in full, without prior written approval of the Company. Any unauthorized alteration, forgery or falsification of the content or appearance of this document is unlawful and offenders may be prosecuted to the fullest extent of the law.

Model no.	HSC-I006R	Test Mode	Mode 10
Environmental Conditions	26°C, 60% RH	Tested Date	2022/07/08
Antenna Pole	Vertical	Antenna Distance	10m
Detector Function	Quasi-peak.	Tested By	Lowka Chen
6dB Bandwidth	120 kHz	Identifier number	TCOP RE site 17
Standard	FCC Part 15 Subpart B		

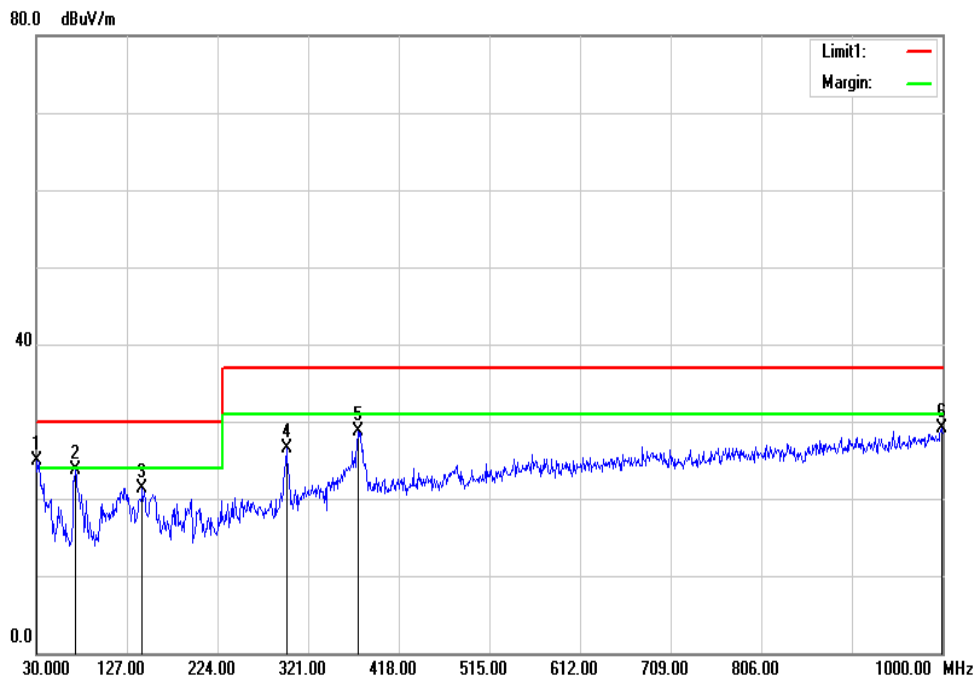

No.	Frequency (MHz)	Reading (dBuV)	Correction Factor (dB/m)	Result (dBuV/m)	Limit (dBuV/m)	Margin (dB)	Height (cm)	Degree (°)	Remark
1	30.9700	28.09	-3.18	24.91	30.00	-5.09	199	140	QP
2	71.7100	37.76	-14.15	23.61	30.00	-6.39	199	100	QP
3	143.4900	29.83	-8.46	21.37	30.00	-8.63	100	323	QP
4	297.7200	31.10	-4.62	26.48	37.00	-10.52	100	360	QP
5	374.3500	31.10	-2.45	28.65	37.00	-8.35	100	323	QP
6	999.0300	22.48	6.68	29.16	37.00	-7.84	100	360	QP

REMARKS: The other emission levels were very low against the limit.

Unless otherwise stated the results shown in this test report refer only to the sample(s) tested and such sample(s) are retained for 90 days only.

除非另有說明，此報告結果僅對測試之樣品負責，同時此樣品僅保留90天。本報告未經本公司書面許可，不可部份複製。

This document is issued by the Company subject to its General Conditions of Service printed overleaf, available on request or accessible at www.sgs.com/terms_and_conditions.htm and for electronic format documents, subject to Terms and Conditions for Electronic Documents at www.sgs.com/terms_e-document.htm. Attention is drawn to the limitation of liability, indemnification and jurisdiction issues defined therein. Any holder of this document is advised that information contained hereon reflects the Company's findings at the time of its intervention only and within the limits of Client's instructions, if any. The Company's sole responsibility is to its Client and this document does not exonerate parties to a transaction from exercising all their rights and obligations under the transaction documents. This document cannot be reproduced except in full, without prior written approval of the Company. Any unauthorized alteration, forgery or falsification of the content or appearance of this document is unlawful and offenders may be prosecuted to the fullest extent of the law.

Model no.	HSC-I006R	Test Mode	Mode 10
Environmental Conditions	26°C, 60% RH	Tested Date	2022/07/08
Antenna Pole	Horizontal	Antenna Distance	10m
Detector Function	Quasi-peak.	Tested By	Lowka Chen
6dB Bandwidth	120 kHz	Identifier number	TCOP RE site 17
Standard	FCC Part 15 Subpart B		

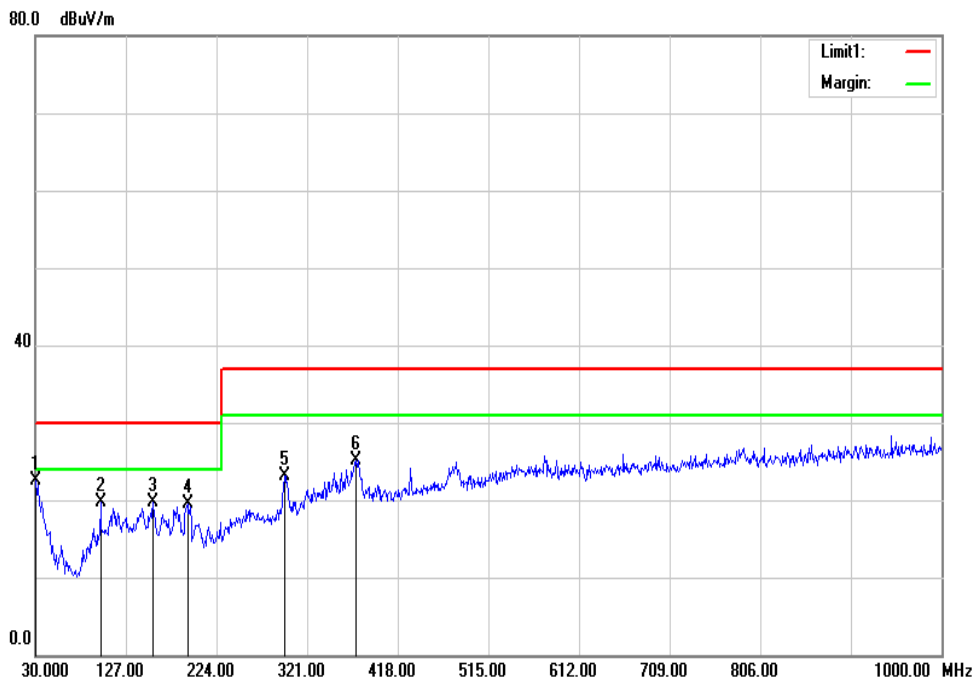

No.	Frequency (MHz)	Reading (dBuV)	Correction Factor (dB/m)	Result (dBuV/m)	Limit (dBuV/m)	Margin (dB)	Height (cm)	Degree (°)	Remark
1	30.9700	26.40	-3.86	22.54	30.00	-7.46	400	303	QP
2	99.8400	30.02	-10.31	19.71	30.00	-10.29	400	223	QP
3	156.1000	29.89	-10.21	19.68	30.00	-10.32	400	360	QP
4	192.9600	30.27	-10.79	19.48	30.00	-10.52	400	223	QP
5	296.7500	29.24	-6.09	23.15	37.00	-13.85	300	59	QP
6	373.3800	29.39	-4.24	25.15	37.00	-11.85	300	359	QP

REMARKS: The other emission levels were very low against the limit.

Unless otherwise stated the results shown in this test report refer only to the sample(s) tested and such sample(s) are retained for 90 days only.

除非另有說明，此報告結果僅對測試之樣品負責，同時此樣品僅保留90天。本報告未經本公司書面許可，不可部份複製。

This document is issued by the Company subject to its General Conditions of Service printed overleaf, available on request or accessible at www.sgs.com/terms_and_conditions.htm and for electronic format documents, subject to Terms and Conditions for Electronic Documents at www.sgs.com/terms_e-document.htm. Attention is drawn to the limitation of liability, indemnification and jurisdiction issues defined therein. Any holder of this document is advised that information contained hereon reflects the Company's findings at the time of its intervention only and within the limits of Client's instructions, if any. The Company's sole responsibility is to its Client and this document does not exonerate parties to a transaction from exercising all their rights and obligations under the transaction documents. This document cannot be reproduced except in full, without prior written approval of the Company. Any unauthorized alteration, forgery or falsification of the content or appearance of this document is unlawful and offenders may be prosecuted to the fullest extent of the law.

Model no.	HSC-I006R	Test Mode	Mode 5
Environmental Conditions	26°C, 60% RH	Tested Date	2022/07/08
Antenna Pole	Vertical	Antenna Distance	10m
Detector Function	Quasi-peak.	Tested By	Lowka Chen
6dB Bandwidth	120 kHz	Identifier number	TCOP RE site 17
Standard	ISED ICES-003 Issue 7		

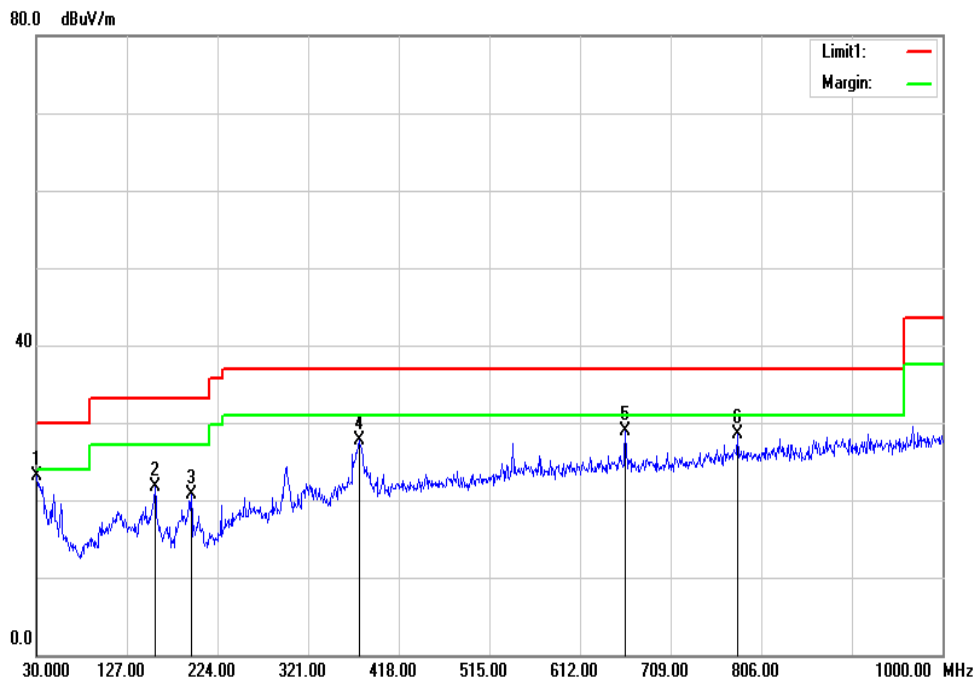

No.	Frequency (MHz)	Reading (dBuV)	Correction Factor (dB/m)	Result (dBuV/m)	Limit (dBuV/m)	Margin (dB)	Height (cm)	Degree (°)	Remark
1	30.9700	26.29	-3.18	23.11	30.00	-6.89	100	20	QP
2	157.0700	30.65	-9.04	21.61	33.10	-11.49	100	0	QP
3	195.8700	30.12	-9.50	20.62	33.10	-12.48	100	160	QP
4	375.3200	30.17	-2.42	27.75	37.00	-9.25	100	320	QP
5	660.5000	27.13	1.86	28.99	37.00	-8.01	199	358	QP
6	780.7800	25.03	3.39	28.42	37.00	-8.58	199	326	QP

REMARKS: The other emission levels were very low against the limit.

Unless otherwise stated the results shown in this test report refer only to the sample(s) tested and such sample(s) are retained for 90 days only.

除非另有說明，此報告結果僅對測試之樣品負責，同時此樣品僅保留90天。本報告未經本公司書面許可，不可部份複製。

This document is issued by the Company subject to its General Conditions of Service printed overleaf, available on request or accessible at www.sgs.com/terms_and_conditions.htm and for electronic format documents, subject to Terms and Conditions for Electronic Documents at www.sgs.com/terms_e-document.htm. Attention is drawn to the limitation of liability, indemnification and jurisdiction issues defined therein. Any holder of this document is advised that information contained hereon reflects the Company's findings at the time of its intervention only and within the limits of Client's instructions, if any. The Company's sole responsibility is to its Client and this document does not exonerate parties to a transaction from exercising all their rights and obligations under the transaction documents. This document cannot be reproduced except in full, without prior written approval of the Company. Any unauthorized alteration, forgery or falsification of the content or appearance of this document is unlawful and offenders may be prosecuted to the fullest extent of the law.

Model no.	HSC-I006R	Test Mode	Mode 5
Environmental Conditions	26°C, 60% RH	Tested Date	2022/07/08
Antenna Pole	Horizontal	Antenna Distance	10m
Detector Function	Quasi-peak.	Tested By	Lowka Chen
6dB Bandwidth	120 kHz	Identifier number	TCOP RE site 17
Standard	ISED ICES-003 Issue 7		

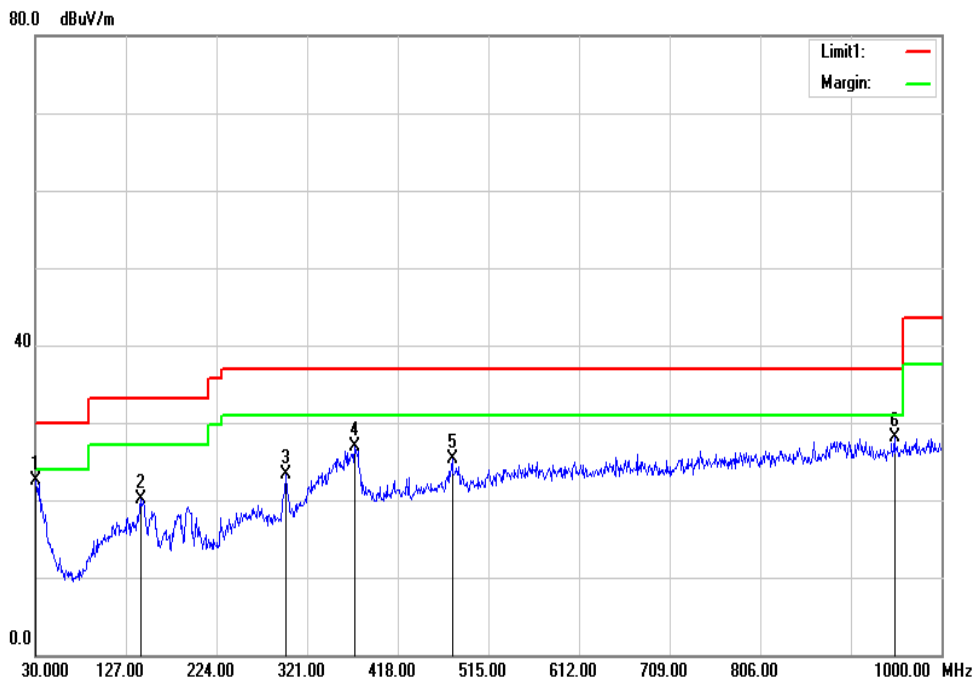

No.	Frequency (MHz)	Reading (dBuV)	Correction Factor (dB/m)	Result (dBuV/m)	Limit (dBuV/m)	Margin (dB)	Height (cm)	Degree (°)	Remark
1	30.9700	26.33	-3.86	22.47	30.00	-7.53	300	0	QP
2	142.5200	29.56	-9.54	20.02	33.10	-13.08	400	356	QP
3	298.6900	29.28	-6.07	23.21	37.00	-13.79	300	39	QP
4	371.4400	31.17	-4.28	26.89	37.00	-10.11	300	0	QP
5	476.2000	27.78	-2.42	25.36	37.00	-11.64	400	359	QP
6	949.5600	24.51	3.54	28.05	37.00	-8.95	400	80	QP

REMARKS: The other emission levels were very low against the limit.

Unless otherwise stated the results shown in this test report refer only to the sample(s) tested and such sample(s) are retained for 90 days only.

除非另有說明，此報告結果僅對測試之樣品負責，同時此樣品僅保留90天。本報告未經本公司書面許可，不可部份複製。

This document is issued by the Company subject to its General Conditions of Service printed overleaf, available on request or accessible at www.sgs.com/terms_and_conditions.htm and for electronic format documents, subject to Terms and Conditions for Electronic Documents at www.sgs.com/terms_e-document.htm. Attention is drawn to the limitation of liability, indemnification and jurisdiction issues defined therein. Any holder of this document is advised that information contained hereon reflects the Company's findings at the time of its intervention only and within the limits of Client's instructions, if any. The Company's sole responsibility is to its Client and this document does not exonerate parties to a transaction from exercising all their rights and obligations under the transaction documents. This document cannot be reproduced except in full, without prior written approval of the Company. Any unauthorized alteration, forgery or falsification of the content or appearance of this document is unlawful and offenders may be prosecuted to the fullest extent of the law.

Model no.	HSC-I006R	Test Mode	Mode 9
Environmental Conditions	26°C, 60% RH	Tested Date	2022/07/08
Antenna Pole	Vertical	Antenna Distance	10m
Detector Function	Quasi-peak.	Tested By	Lowka Chen
6dB Bandwidth	120 kHz	Identifier number	TCOP RE site 17
Standard	ISED ICES-003 Issue 7		

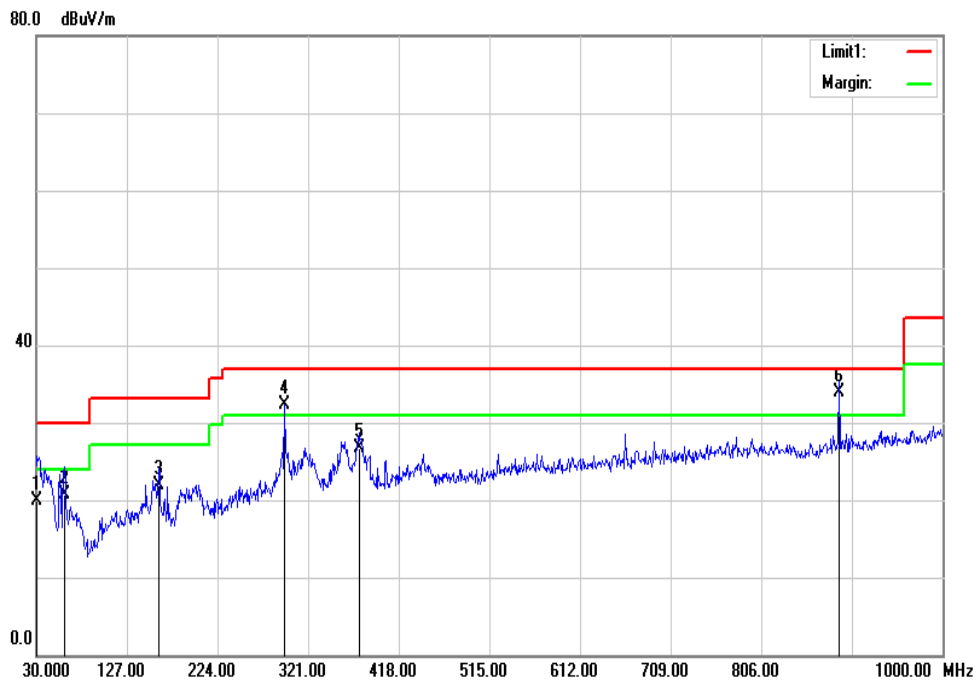

No.	Frequency (MHz)	Reading (dBuV)	Correction Factor (dB/m)	Result (dBuV/m)	Limit (dBuV/m)	Margin (dB)	Height (cm)	Degree (°)	Remark
1	30.9700	23.15	-3.18	19.97	30.00	-10.03	100	297	QP
2	60.0700	35.15	-14.40	20.75	30.00	-9.25	199	0	QP
3	160.9500	31.03	-9.20	21.83	33.10	-11.27	100	0	QP
4	295.7800	36.88	-4.65	32.23	37.00	-4.77	100	359	QP
5	375.3200	29.14	-2.42	26.72	37.00	-10.28	100	359	QP
6	889.4200	29.01	4.85	33.86	37.00	-3.14	199	326	QP

REMARKS: The other emission levels were very low against the limit.

Unless otherwise stated the results shown in this test report refer only to the sample(s) tested and such sample(s) are retained for 90 days only.

除非另有說明，此報告結果僅對測試之樣品負責，同時此樣品僅保留90天。本報告未經本公司書面許可，不可部份複製。

This document is issued by the Company subject to its General Conditions of Service printed overleaf, available on request or accessible at www.sgs.com/terms_and_conditions.htm and for electronic format documents, subject to Terms and Conditions for Electronic Documents at www.sgs.com/terms_e-document.htm. Attention is drawn to the limitation of liability, indemnification and jurisdiction issues defined therein. Any holder of this document is advised that information contained hereon reflects the Company's findings at the time of its intervention only and within the limits of Client's instructions, if any. The Company's sole responsibility is to its Client and this document does not exonerate parties to a transaction from exercising all their rights and obligations under the transaction documents. This document cannot be reproduced except in full, without prior written approval of the Company. Any unauthorized alteration, forgery or falsification of the content or appearance of this document is unlawful and offenders may be prosecuted to the fullest extent of the law.

Model no.	HSC-I006R	Test Mode	Mode 9
Environmental Conditions	26°C, 60% RH	Tested Date	2022/07/08
Antenna Pole	Horizontal	Antenna Distance	10m
Detector Function	Quasi-peak.	Tested By	Lowka Chen
6dB Bandwidth	120 kHz	Identifier number	TCOP RE site 17
Standard	ISED ICES-003 Issue 7		

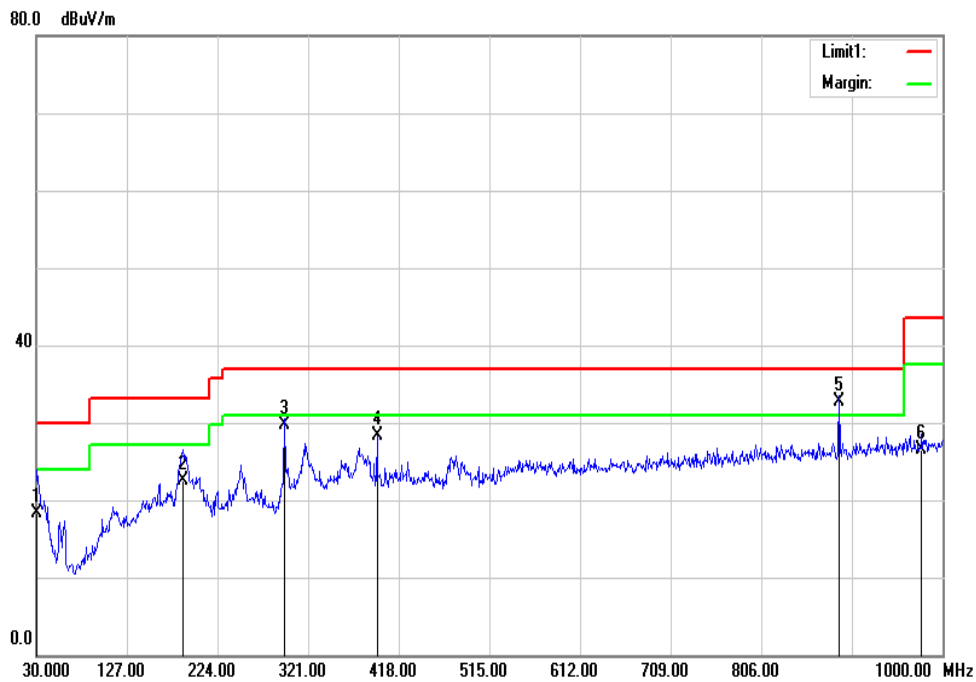

No.	Frequency (MHz)	Reading (dBuV)	Correction Factor (dB/m)	Result (dBuV/m)	Limit (dBuV/m)	Margin (dB)	Height (cm)	Degree (°)	Remark
1	30.0000	21.59	-3.35	18.24	30.00	-11.76	400	215	QP
2	187.1400	33.43	-10.90	22.53	33.10	-10.57	400	17	QP
3	295.7800	35.78	-6.11	29.67	37.00	-7.33	400	330	QP
4	394.7200	31.98	-3.66	28.32	37.00	-8.68	300	342	QP
5	889.4200	30.02	2.78	32.80	37.00	-4.20	300	0	QP
6	977.6900	22.65	3.89	26.54	43.50	-16.96	300	194	QP

REMARKS: The other emission levels were very low against the limit.

Unless otherwise stated the results shown in this test report refer only to the sample(s) tested and such sample(s) are retained for 90 days only.

除非另有說明，此報告結果僅對測試之樣品負責，同時此樣品僅保留90天。本報告未經本公司書面許可，不可部份複製。

This document is issued by the Company subject to its General Conditions of Service printed overleaf, available on request or accessible at www.sgs.com/terms_and_conditions.htm and for electronic format documents, subject to Terms and Conditions for Electronic Documents at www.sgs.com/terms_e-document.htm. Attention is drawn to the limitation of liability, indemnification and jurisdiction issues defined therein. Any holder of this document is advised that information contained hereon reflects the Company's findings at the time of its intervention only and within the limits of Client's instructions, if any. The Company's sole responsibility is to its Client and this document does not exonerate parties to a transaction from exercising all their rights and obligations under the transaction documents. This document cannot be reproduced except in full, without prior written approval of the Company. Any unauthorized alteration, forgery or falsification of the content or appearance of this document is unlawful and offenders may be prosecuted to the fullest extent of the law.

Model no.	HSC-I006R	Test Mode	Mode 10
Environmental Conditions	26°C, 60% RH	Tested Date	2022/07/08
Antenna Pole	Vertical	Antenna Distance	10m
Detector Function	Quasi-peak.	Tested By	Lowka Chen
6dB Bandwidth	120 kHz	Identifier number	TCOP RE site 17
Standard	ISED ICES-003 Issue 7		

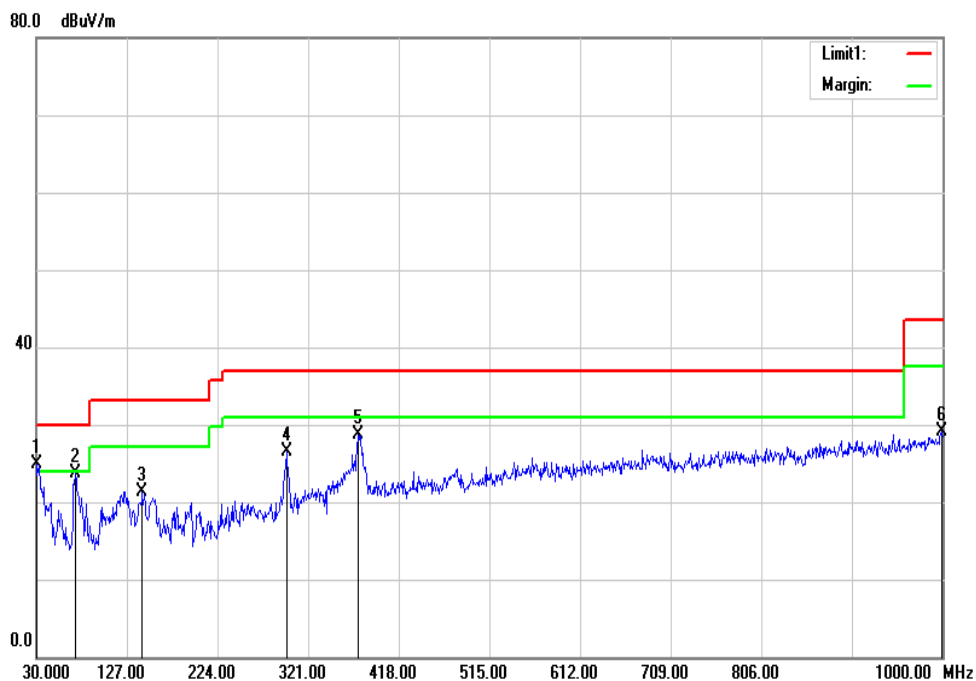

No.	Frequency (MHz)	Reading (dBuV)	Correction Factor (dB/m)	Result (dBuV/m)	Limit (dBuV/m)	Margin (dB)	Height (cm)	Degree (°)	Remark
1	30.9700	28.09	-3.18	24.91	30.00	-5.09	199	140	QP
2	71.7100	37.76	-14.15	23.61	30.00	-6.39	199	100	QP
3	143.4900	29.83	-8.46	21.37	33.10	-11.73	100	323	QP
4	297.7200	31.10	-4.62	26.48	37.00	-10.52	100	360	QP
5	374.3500	31.10	-2.45	28.65	37.00	-8.35	100	323	QP
6	999.0300	22.48	6.68	29.16	43.50	-14.34	100	360	QP

REMARKS: The other emission levels were very low against the limit.

Unless otherwise stated the results shown in this test report refer only to the sample(s) tested and such sample(s) are retained for 90 days only.

除非另有說明，此報告結果僅對測試之樣品負責，同時此樣品僅保留90天。本報告未經本公司書面許可，不可部份複製。

This document is issued by the Company subject to its General Conditions of Service printed overleaf, available on request or accessible at www.sgs.com/terms_and_conditions.htm and for electronic format documents, subject to Terms and Conditions for Electronic Documents at www.sgs.com/terms_e-document.htm. Attention is drawn to the limitation of liability, indemnification and jurisdiction issues defined therein. Any holder of this document is advised that information contained hereon reflects the Company's findings at the time of its intervention only and within the limits of Client's instructions, if any. The Company's sole responsibility is to its Client and this document does not exonerate parties to a transaction from exercising all their rights and obligations under the transaction documents. This document cannot be reproduced except in full, without prior written approval of the Company. Any unauthorized alteration, forgery or falsification of the content or appearance of this document is unlawful and offenders may be prosecuted to the fullest extent of the law.

Model no.	HSC-I006R	Test Mode	Mode 10
Environmental Conditions	26°C, 60% RH	Tested Date	2022/07/08
Antenna Pole	Horizontal	Antenna Distance	10m
Detector Function	Quasi-peak.	Tested By	Lowka Chen
6dB Bandwidth	120 kHz	Identifier number	TCOP RE site 17
Standard	ISED ICES-003 Issue 7		

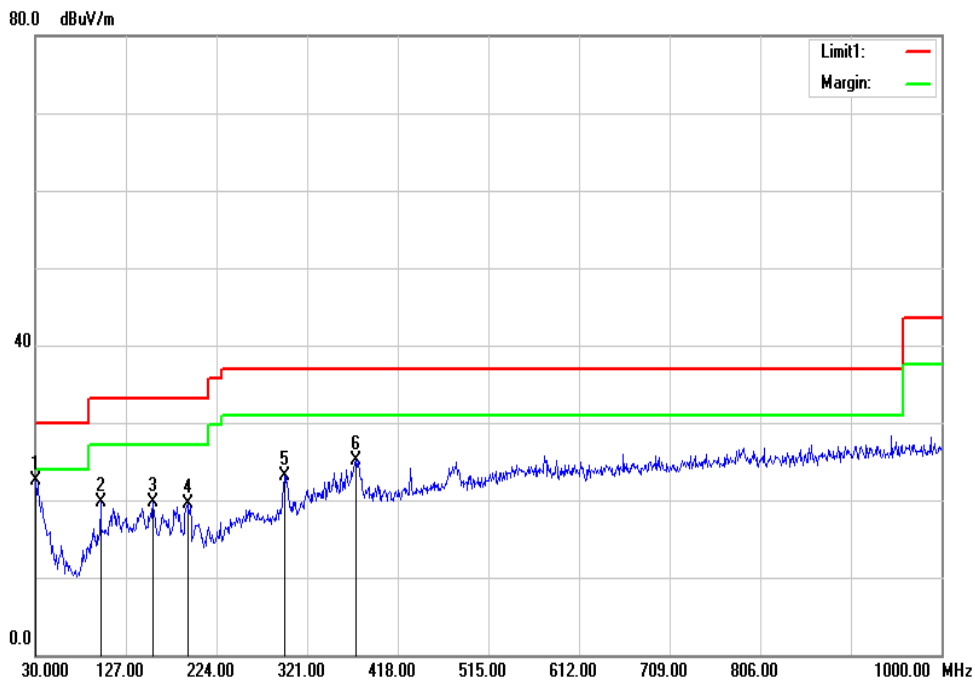

No.	Frequency (MHz)	Reading (dBuV)	Correction Factor (dB/m)	Result (dBuV/m)	Limit (dBuV/m)	Margin (dB)	Height (cm)	Degree (°)	Remark
1	30.9700	26.40	-3.86	22.54	30.00	-7.46	400	303	QP
2	99.8400	30.02	-10.31	19.71	33.10	-13.39	400	223	QP
3	156.1000	29.89	-10.21	19.68	33.10	-13.42	400	360	QP
4	192.9600	30.27	-10.79	19.48	33.10	-13.62	400	223	QP
5	296.7500	29.24	-6.09	23.15	37.00	-13.85	300	59	QP
6	373.3800	29.39	-4.24	25.15	37.00	-11.85	300	359	QP

REMARKS: The other emission levels were very low against the limit.

Unless otherwise stated the results shown in this test report refer only to the sample(s) tested and such sample(s) are retained for 90 days only.

除非另有說明，此報告結果僅對測試之樣品負責，同時此樣品僅保留90天。本報告未經本公司書面許可，不可部份複製。

This document is issued by the Company subject to its General Conditions of Service printed overleaf, available on request or accessible at www.sgs.com/terms_and_conditions.htm and for electronic format documents, subject to Terms and Conditions for Electronic Documents at www.sgs.com/terms_e-document.htm. Attention is drawn to the limitation of liability, indemnification and jurisdiction issues defined therein. Any holder of this document is advised that information contained hereon reflects the Company's findings at the time of its intervention only and within the limits of Client's instructions, if any. The Company's sole responsibility is to its Client and this document does not exonerate parties to a transaction from exercising all their rights and obligations under the transaction documents. This document cannot be reproduced except in full, without prior written approval of the Company. Any unauthorized alteration, forgery or falsification of the content or appearance of this document is unlawful and offenders may be prosecuted to the fullest extent of the law.

Above 1GHz

Model no.	HSC-I006R	Test Mode	Mode 5
Environmental Conditions	26°C, 60% RH	Tested Date	2022/07/08
Antenna Pole	Vertical	Antenna Distance	3m
Highest frequency generated or used	5.8GHz	Upper frequency	29GHz
Detector Function	Peak & Average.	Tested By	Lowka Chen
6dB Bandwidth	1 MHz	Identifier number	TCOP RF site 17

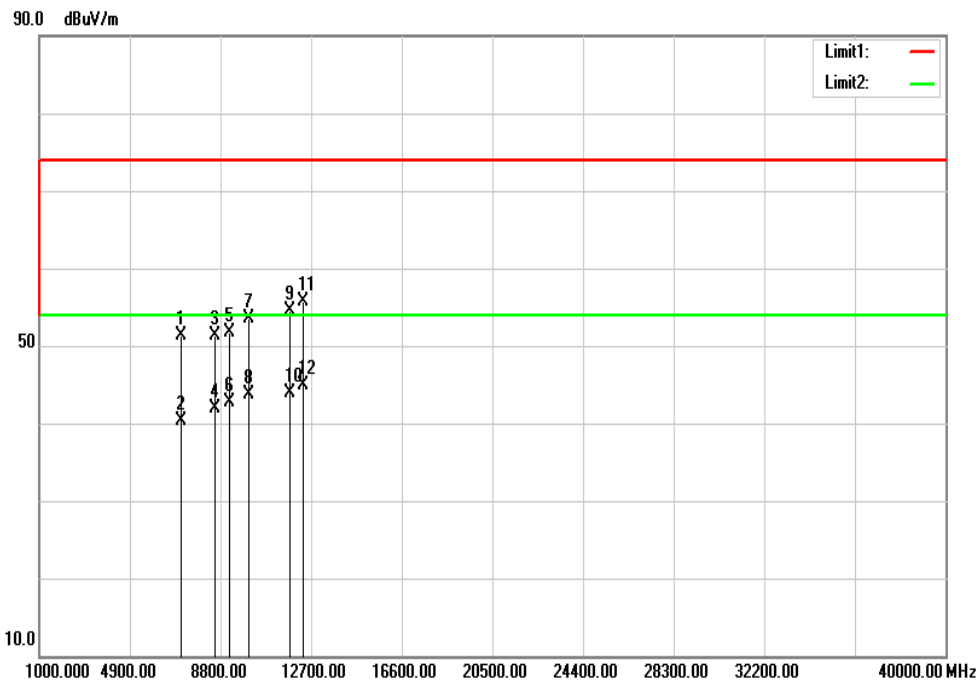

No.	Frequency (MHz)	Reading (dBuV)	Correction Factor (dB/m)	Result (dBuV/m)	Limit (dBuV/m)	Margin (dB)	Height (cm)	Degree (°)	Remark
1	7123.000	54.72	-3.38	51.34	74.00	-22.66	300	359	peak
2	7123.000	43.62	-3.38	40.24	54.00	-13.76	300	359	AVG
3	8585.500	53.99	-2.63	51.36	74.00	-22.64	400	9	peak
4	8585.500	44.46	-2.63	41.83	54.00	-12.17	400	9	AVG
5	9190.000	53.38	-1.75	51.63	74.00	-22.37	200	322	peak
6	9190.000	44.50	-1.75	42.75	54.00	-11.25	200	322	AVG
7	10009.000	52.49	1.02	53.51	74.00	-20.49	200	82	peak

Unless otherwise stated the results shown in this test report refer only to the sample(s) tested and such sample(s) are retained for 90 days only.

除非另有說明，此報告結果僅對測試之樣品負責，同時此樣品僅保留90天。本報告未經本公司書面許可，不可部份複製。

This document is issued by the Company subject to its General Conditions of Service printed overleaf, available on request or accessible at www.sgs.com/terms_and_conditions.htm and for electronic format documents, subject to Terms and Conditions for Electronic Documents at www.sgs.com/terms_e-document.htm. Attention is drawn to the limitation of liability, indemnification and jurisdiction issues defined therein. Any holder of this document is advised that information contained hereon reflects the Company's findings at the time of its intervention only and within the limits of Client's instructions, if any. The Company's sole responsibility is to its Client and this document does not exonerate parties to a transaction from exercising all their rights and obligations under the transaction documents. This document cannot be reproduced except in full, without prior written approval of the Company. Any unauthorized alteration, forgery or falsification of the content or appearance of this document is unlawful and offenders may be prosecuted to the fullest extent of the law.

No.	Frequency (MHz)	Reading (dBuV)	Correction Factor (dB/m)	Result (dBuV/m)	Limit (dBuV/m)	Margin (dB)	Height (cm)	Degree (°)	Remark
8	10009.000	42.64	1.02	43.66	54.00	-10.34	200	82	AVG
9	11764.000	48.98	5.45	54.43	74.00	-19.57	400	128	peak
10	11764.000	38.47	5.45	43.92	54.00	-10.08	400	128	AVG
11	12349.000	47.60	8.04	55.64	74.00	-18.36	100	248	peak
12	12349.000	36.77	8.04	44.81	54.00	-9.19	100	248	AVG

REMARKS:

1. The other emission levels were very low against the limit.
2. Margin (dB) = Result (dBuV/m) – Limit (dBuV/m)

Unless otherwise stated the results shown in this test report refer only to the sample(s) tested and such sample(s) are retained for 90 days only.

除非另有說明，此報告結果僅對測試之樣品負責，同時此樣品僅保留90天。本報告未經本公司書面許可，不可部份複製。

This document is issued by the Company subject to its General Conditions of Service printed overleaf, available on request or accessible at www.sgs.com/terms_and_conditions.htm and for electronic format documents, subject to Terms and Conditions for Electronic Documents at www.sgs.com/terms_e-document.htm. Attention is drawn to the limitation of liability, indemnification and jurisdiction issues defined therein. Any holder of this document is advised that information contained hereon reflects the Company's findings at the time of its intervention only and within the limits of Client's instructions, if any. The Company's sole responsibility is to its Client and this document does not exonerate parties to a transaction from exercising all their rights and obligations under the transaction documents. This document cannot be reproduced except in full, without prior written approval of the Company. Any unauthorized alteration, forgery or falsification of the content or appearance of this document is unlawful and offenders may be prosecuted to the fullest extent of the law.

Model no.	HSC-I006R	Test Mode	Mode 5
Environmental Conditions	26°C, 60% RH	Tested Date	2022/07/08
Antenna Pole	Horizontal	Antenna Distance	3m
Highest frequency generated or used	5.8GHz	Upper frequency	29GHz
Detector Function	Peak & Average.	Tested By	Lowka Chen
6dB Bandwidth	1 MHz	Identifier number	TCOP RF site 17

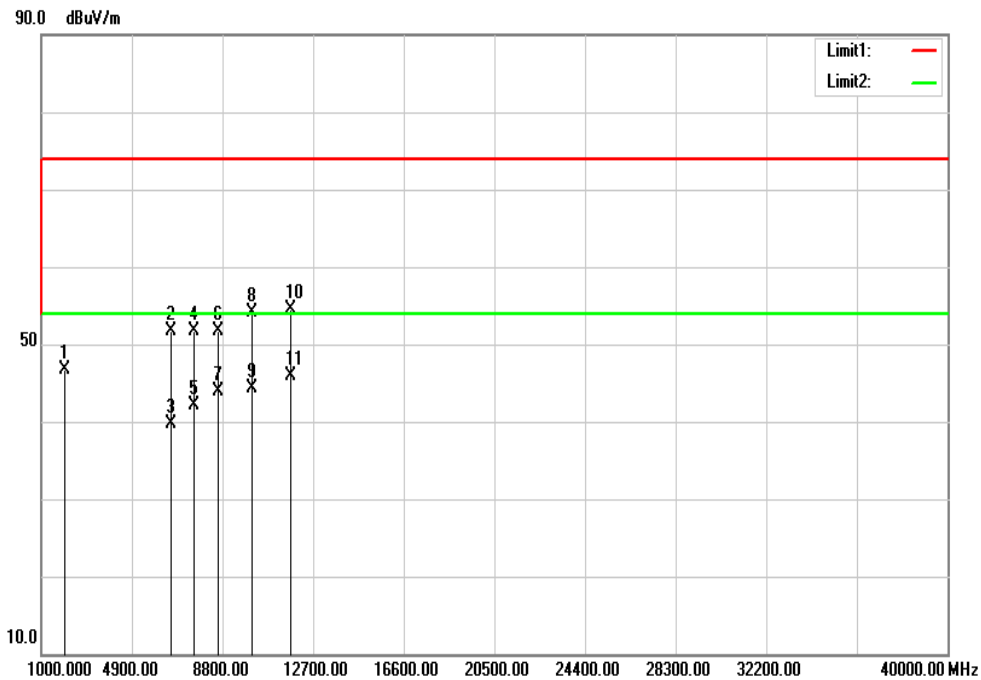

No.	Frequency (MHz)	Reading (dBuV)	Correction Factor (dB/m)	Result (dBuV/m)	Limit (dBuV/m)	Margin (dB)	Height (cm)	Degree (°)	Remark
1	2014.000	60.56	-13.78	46.78	74.00	-27.22	200	213	peak
2	6577.000	56.14	-4.41	51.73	74.00	-22.27	100	129	peak
3	6577.000	44.08	-4.41	39.67	54.00	-14.33	100	129	AVG
4	7591.000	55.44	-3.65	51.79	74.00	-22.21	300	305	peak
5	7591.000	45.83	-3.65	42.18	54.00	-11.82	300	305	AVG
6	8605.000	54.22	-2.60	51.62	74.00	-22.38	300	194	peak
7	8605.000	46.55	-2.60	43.95	54.00	-10.05	300	194	AVG
8	10048.000	53.12	1.08	54.20	74.00	-19.80	400	213	peak
9	10048.000	43.18	1.08	44.26	54.00	-9.74	400	213	AVG
10	11725.000	49.20	5.36	54.56	74.00	-19.44	200	305	peak
11	11725.000	40.48	5.36	45.84	54.00	-8.16	200	305	AVG

REMARKS:

1. The other emission levels were very low against the limit.
2. Margin (dB) = Result (dBuV/m) – Limit (dBuV/m)

Unless otherwise stated the results shown in this test report refer only to the sample(s) tested and such sample(s) are retained for 90 days only.

除非另有說明，此報告結果僅對測試之樣品負責，同時此樣品僅保留90天。本報告未經本公司書面許可，不可部份複製。

This document is issued by the Company subject to its General Conditions of Service printed overleaf, available on request or accessible at www.sgs.com/terms_and_conditions.htm and for electronic format documents, subject to Terms and Conditions for Electronic Documents at www.sgs.com/terms_e-document.htm. Attention is drawn to the limitation of liability, indemnification and jurisdiction issues defined therein. Any holder of this document is advised that information contained hereon reflects the Company's findings at the time of its intervention only and within the limits of Client's instructions, if any. The Company's sole responsibility is to its Client and this document does not exonerate parties to a transaction from exercising all their rights and obligations under the transaction documents. This document cannot be reproduced except in full, without prior written approval of the Company. Any unauthorized alteration, forgery or falsification of the content or appearance of this document is unlawful and offenders may be prosecuted to the fullest extent of the law.

Model no.	HSC-I006R	Test Mode	Mode 9
Environmental Conditions	26°C, 60% RH	Tested Date	2022/07/08
Antenna Pole	Vertical	Antenna Distance	3m
Highest frequency generated or used	5.8GHz	Upper frequency	29GHz
Detector Function	Peak & Average.	Tested By	Lowka Chen
6dB Bandwidth	1 MHz	Identifier number	TCOP RF site 17

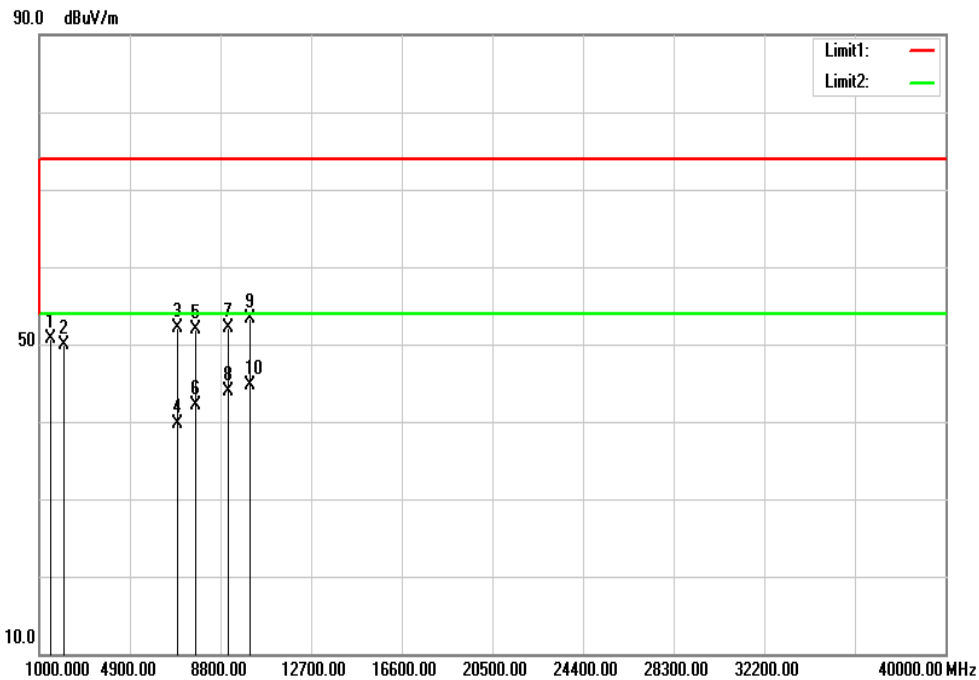

No.	Frequency (MHz)	Reading (dBuV)	Correction Factor (dB/m)	Result (dBuV/m)	Limit (dBuV/m)	Margin (dB)	Height (cm)	Degree (°)	Remark
1	1487.500	69.10	-18.45	50.65	74.00	-23.35	100	231	peak
2	2072.500	63.28	-13.37	49.91	74.00	-24.09	100	305	peak
3	6967.000	55.58	-3.39	52.19	74.00	-21.81	300	360	peak
4	6967.000	43.06	-3.39	39.67	54.00	-14.33	300	360	AVG
5	7708.000	55.50	-3.68	51.82	74.00	-22.18	200	0	peak
6	7708.000	45.83	-3.68	42.15	54.00	-11.85	200	0	AVG
7	9170.500	53.84	-1.77	52.07	74.00	-21.93	400	27	peak
8	9170.500	45.65	-1.77	43.88	54.00	-10.12	400	27	AVG
9	10048.000	52.32	1.08	53.40	74.00	-20.60	200	148	peak
10	10048.000	43.57	1.08	44.65	54.00	-9.35	200	148	AVG

REMARKS:

- The other emission levels were very low against the limit.
- Margin (dB) = Result (dBuV/m) – Limit (dBuV/m)

Unless otherwise stated the results shown in this test report refer only to the sample(s) tested and such sample(s) are retained for 90 days only.

除非另有說明，此報告結果僅對測試之樣品負責，同時此樣品僅保留90天。本報告未經本公司書面許可，不可部份複製。

This document is issued by the Company subject to its General Conditions of Service printed overleaf, available on request or accessible at www.sgs.com/terms_and_conditions.htm and for electronic format documents, subject to Terms and Conditions for Electronic Documents at www.sgs.com/terms_e-document.htm. Attention is drawn to the limitation of liability, indemnification and jurisdiction issues defined therein. Any holder of this document is advised that information contained hereon reflects the Company's findings at the time of its intervention only and within the limits of Client's instructions, if any. The Company's sole responsibility is to its Client and this document does not exonerate parties to a transaction from exercising all their rights and obligations under the transaction documents. This document cannot be reproduced except in full, without prior written approval of the Company. Any unauthorized alteration, forgery or falsification of the content or appearance of this document is unlawful and offenders may be prosecuted to the fullest extent of the law.

Model no.	HSC-I006R	Test Mode	Mode 9
Environmental Conditions	26°C, 60% RH	Tested Date	2022/07/08
Antenna Pole	Horizontal	Antenna Distance	3m
Highest frequency generated or used	5.8GHz	Upper frequency	29GHz
Detector Function	Peak & Average.	Tested By	Lowka Chen
6dB Bandwidth	1 MHz	Identifier number	TCOP RF site 17

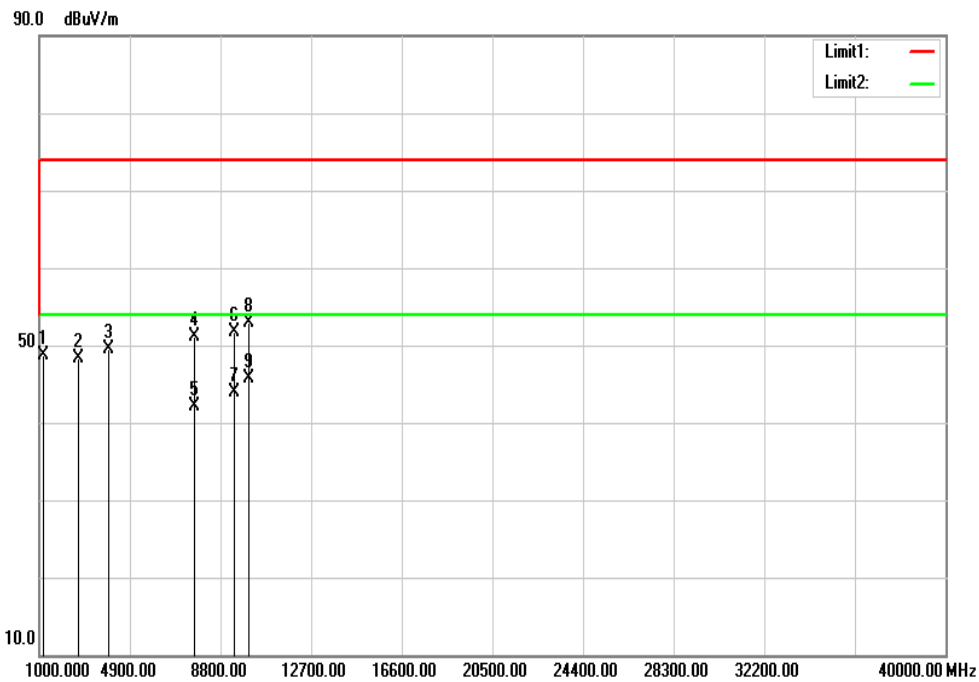

No.	Frequency (MHz)	Reading (dBuV)	Correction Factor (dB/m)	Result (dBuV/m)	Limit (dBuV/m)	Margin (dB)	Height (cm)	Degree (°)	Remark
1	1156.000	66.05	-17.31	48.74	74.00	-25.26	200	230	peak
2	2677.000	61.05	-12.79	48.26	74.00	-25.74	300	313	peak
3	4003.000	60.13	-10.63	49.50	74.00	-24.50	300	332	peak
4	7669.000	54.68	-3.67	51.01	74.00	-22.99	200	174	peak
5	7669.000	45.80	-3.67	42.13	54.00	-11.87	200	174	AVG
6	9385.000	53.21	-1.44	51.77	74.00	-22.23	100	155	peak
7	9385.000	45.31	-1.44	43.87	54.00	-10.13	100	155	AVG
8	10009.000	51.96	1.02	52.98	74.00	-21.02	200	230	peak
9	10009.000	44.64	1.02	45.66	54.00	-8.34	200	230	AVG

REMARKS:

1. The other emission levels were very low against the limit.
2. Margin (dB) = Result (dBuV/m) – Limit (dBuV/m)

Unless otherwise stated the results shown in this test report refer only to the sample(s) tested and such sample(s) are retained for 90 days only.

除非另有說明，此報告結果僅對測試之樣品負責，同時此樣品僅保留90天。本報告未經本公司書面許可，不可部份複製。

This document is issued by the Company subject to its General Conditions of Service printed overleaf, available on request or accessible at www.sgs.com/terms_and_conditions.htm and for electronic format documents, subject to Terms and Conditions for Electronic Documents at www.sgs.com/terms_e-document.htm. Attention is drawn to the limitation of liability, indemnification and jurisdiction issues defined therein. Any holder of this document is advised that information contained hereon reflects the Company's findings at the time of its intervention only and within the limits of Client's instructions, if any. The Company's sole responsibility is to its Client and this document does not exonerate parties to a transaction from exercising all their rights and obligations under the transaction documents. This document cannot be reproduced except in full, without prior written approval of the Company. Any unauthorized alteration, forgery or falsification of the content or appearance of this document is unlawful and offenders may be prosecuted to the fullest extent of the law.

Model no.	HSC-I006R	Test Mode	Mode 10
Environmental Conditions	26°C, 60% RH	Tested Date	2022/07/08
Antenna Pole	Vertical	Antenna Distance	3m
Highest frequency generated or used	5.8GHz	Upper frequency	29GHz
Detector Function	Peak & Average.	Tested By	Lowka Chen
6dB Bandwidth	1 MHz	Identifier number	TCOP RF site 17

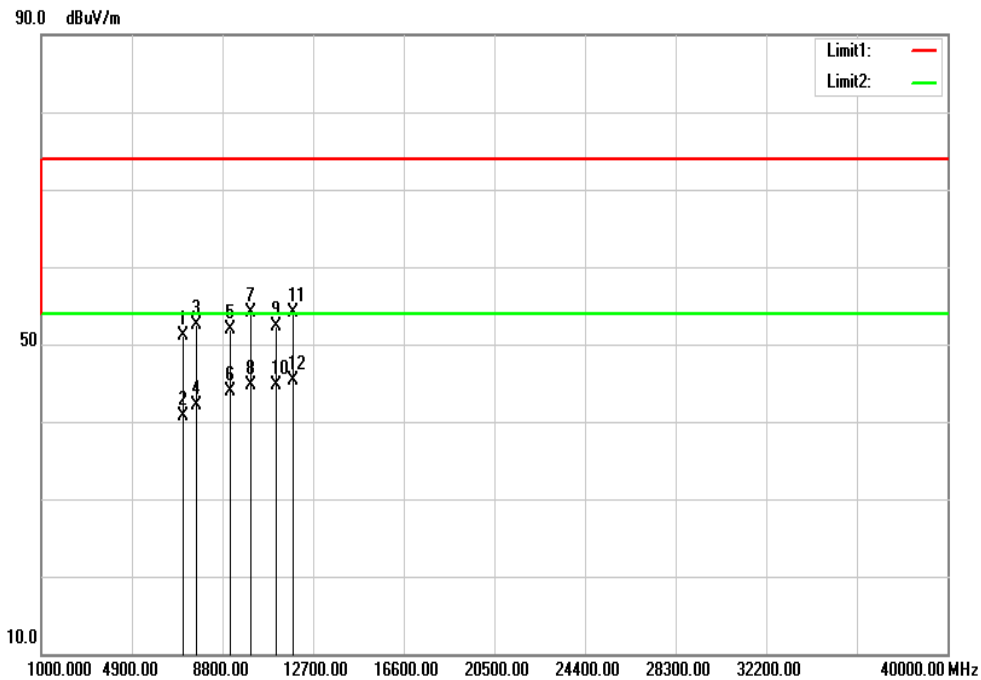

No.	Frequency (MHz)	Reading (dBuV)	Correction Factor (dB/m)	Result (dBuV/m)	Limit (dBuV/m)	Margin (dB)	Height (cm)	Degree (°)	Remark
1	7123.000	54.58	-3.38	51.20	74.00	-22.80	200	356	peak
2	7123.000	44.14	-3.38	40.76	54.00	-13.24	200	356	AVG
3	7669.000	56.21	-3.67	52.54	74.00	-21.46	100	211	peak
4	7669.000	45.80	-3.67	42.13	54.00	-11.87	100	211	AVG
5	9151.000	53.74	-1.80	51.94	74.00	-22.06	300	285	peak
6	9151.000	45.75	-1.80	43.95	54.00	-10.05	300	285	AVG
7	10009.000	53.00	1.02	54.02	74.00	-19.98	100	211	peak
8	10009.000	43.66	1.02	44.68	54.00	-9.32	100	211	AVG
9	11101.000	48.87	3.48	52.35	74.00	-21.65	200	359	peak

Unless otherwise stated the results shown in this test report refer only to the sample(s) tested and such sample(s) are retained for 90 days only.

除非另有說明，此報告結果僅對測試之樣品負責，同時此樣品僅保留90天。本報告未經本公司書面許可，不可部份複製。

This document is issued by the Company subject to its General Conditions of Service printed overleaf, available on request or accessible at www.sgs.com/terms_and_conditions.htm and for electronic format documents, subject to Terms and Conditions for Electronic Documents at www.sgs.com/terms_e-document.htm. Attention is drawn to the limitation of liability, indemnification and jurisdiction issues defined therein. Any holder of this document is advised that information contained hereon reflects the Company's findings at the time of its intervention only and within the limits of Client's instructions, if any. The Company's sole responsibility is to its Client and this document does not exonerate parties to a transaction from exercising all their rights and obligations under the transaction documents. This document cannot be reproduced except in full, without prior written approval of the Company. Any unauthorized alteration, forgery or falsification of the content or appearance of this document is unlawful and offenders may be prosecuted to the fullest extent of the law.

No.	Frequency (MHz)	Reading (dBuV)	Correction Factor (dB/m)	Result (dBuV/m)	Limit (dBuV/m)	Margin (dB)	Height (cm)	Degree (°)	Remark
10	11101.000	41.24	3.48	44.72	54.00	-9.28	200	359	AVG
11	11842.000	48.44	5.60	54.04	74.00	-19.96	100	202	peak
12	11842.000	39.70	5.60	45.30	54.00	-8.70	100	202	AVG

REMARKS:

1. The other emission levels were very low against the limit.
2. Margin (dB) = Result (dBuV/m) – Limit (dBuV/m)

Unless otherwise stated the results shown in this test report refer only to the sample(s) tested and such sample(s) are retained for 90 days only.

除非另有說明，此報告結果僅對測試之樣品負責，同時此樣品僅保留90天。本報告未經本公司書面許可，不可部份複製。

This document is issued by the Company subject to its General Conditions of Service printed overleaf, available on request or accessible at www.sgs.com/terms_and_conditions.htm and for electronic format documents, subject to Terms and Conditions for Electronic Documents at www.sgs.com/terms_e-document.htm. Attention is drawn to the limitation of liability, indemnification and jurisdiction issues defined therein. Any holder of this document is advised that information contained hereon reflects the Company's findings at the time of its intervention only and within the limits of Client's instructions, if any. The Company's sole responsibility is to its Client and this document does not exonerate parties to a transaction from exercising all their rights and obligations under the transaction documents. This document cannot be reproduced except in full, without prior written approval of the Company. Any unauthorized alteration, forgery or falsification of the content or appearance of this document is unlawful and offenders may be prosecuted to the fullest extent of the law.

Model no.	HSC-I006R	Test Mode	Mode 10
Environmental Conditions	26°C, 60% RH	Tested Date	2022/07/08
Antenna Pole	Horizontal	Antenna Distance	3m
Highest frequency generated or used	5.8GHz	Upper frequency	29GHz
Detector Function	Peak & Average.	Tested By	Lowka Chen
6dB Bandwidth	1 MHz	Identifier number	TCOP RF site 17

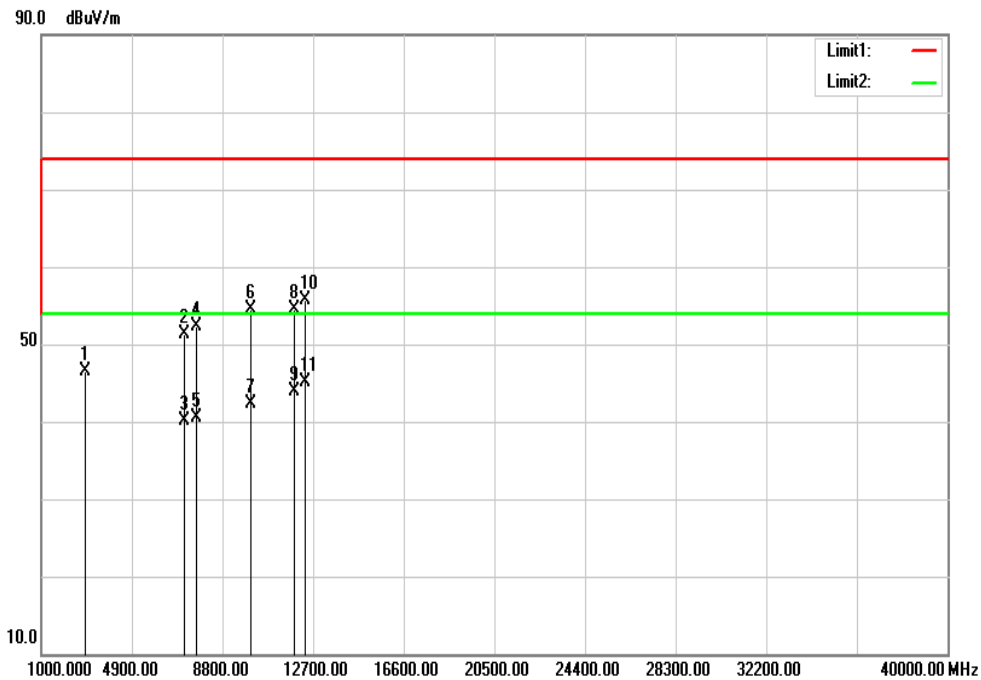

No.	Frequency (MHz)	Reading (dBuV)	Correction Factor (dB/m)	Result (dBuV/m)	Limit (dBuV/m)	Margin (dB)	Height (cm)	Degree (°)	Remark
1	2911.000	58.66	-12.15	46.51	74.00	-27.49	100	268	peak
2	7162.000	54.77	-3.41	51.36	74.00	-22.64	200	360	peak
3	7162.000	43.59	-3.41	40.18	54.00	-13.82	200	360	AVG
4	7669.000	55.99	-3.67	52.32	74.00	-21.68	400	359	peak
5	7669.000	44.24	-3.67	40.57	54.00	-13.43	400	359	AVG
6	10009.000	53.49	1.02	54.51	74.00	-19.49	200	83	peak
7	10009.000	41.34	1.02	42.36	54.00	-11.64	200	83	AVG
8	11881.000	48.82	5.67	54.49	74.00	-19.51	300	305	peak
9	11881.000	38.22	5.67	43.89	54.00	-10.11	300	305	AVG
10	12349.000	47.75	8.04	55.79	74.00	-18.21	200	258	peak
11	12349.000	37.12	8.04	45.16	54.00	-8.84	200	258	AVG

REMARKS:

1. The other emission levels were very low against the limit.
2. Margin (dB) = Result (dBuV/m) – Limit (dBuV/m)

Unless otherwise stated the results shown in this test report refer only to the sample(s) tested and such sample(s) are retained for 90 days only.

除非另有說明，此報告結果僅對測試之樣品負責，同時此樣品僅保留90天。本報告未經本公司書面許可，不可部份複製。

This document is issued by the Company subject to its General Conditions of Service printed overleaf, available on request or accessible at www.sgs.com/terms_and_conditions.htm and for electronic format documents, subject to Terms and Conditions for Electronic Documents at www.sgs.com/terms_e-document.htm. Attention is drawn to the limitation of liability, indemnification and jurisdiction issues defined therein. Any holder of this document is advised that information contained hereon reflects the Company's findings at the time of its intervention only and within the limits of Client's instructions, if any. The Company's sole responsibility is to its Client and this document does not exonerate parties to a transaction from exercising all their rights and obligations under the transaction documents. This document cannot be reproduced except in full, without prior written approval of the Company. Any unauthorized alteration, forgery or falsification of the content or appearance of this document is unlawful and offenders may be prosecuted to the fullest extent of the law.

APPENDIX

Photograph of Testing General Set-up

CE Testing Set-up

Model No.: HSC-I006R

Mode_5_+



Mode_5_-



Unless otherwise stated the results shown in this test report refer only to the sample(s) tested and such sample(s) are retained for 90 days only.

除非另有說明，此報告結果僅對測試之樣品負責，同時此樣品僅保留90天。本報告未經本公司書面許可，不可部份複製。

This document is issued by the Company subject to its General Conditions of Service printed overleaf, available on request or accessible at www.sgs.com/terms_and_conditions.htm and for electronic format documents, subject to Terms and Conditions for Electronic Documents at www.sgs.com/terms_e-document.htm. Attention is drawn to the limitation of liability, indemnification and jurisdiction issues defined therein. Any holder of this document is advised that information contained hereon reflects the Company's findings at the time of its intervention only and within the limits of Client's instructions, if any. The Company's sole responsibility is to its Client and this document does not exonerate parties to a transaction from exercising all their rights and obligations under the transaction documents. This document cannot be reproduced except in full, without prior written approval of the Company. Any unauthorized alteration, forgery or falsification of the content or appearance of this document is unlawful and offenders may be prosecuted to the fullest extent of the law.

Model No.: HSC-I006R

Mode_9_+



Mode_9_-

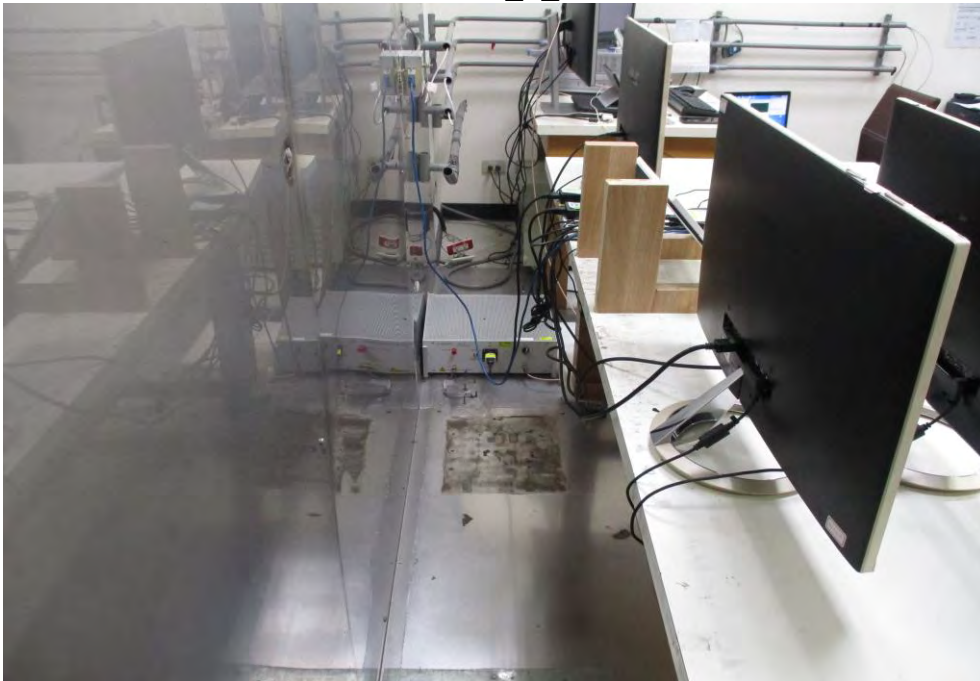

Unless otherwise stated the results shown in this test report refer only to the sample(s) tested and such sample(s) are retained for 90 days only.

除非另有說明，此報告結果僅對測試之樣品負責，同時此樣品僅保留90天。本報告未經本公司書面許可，不可部份複製。

This document is issued by the Company subject to its General Conditions of Service printed overleaf, available on request or accessible at www.sgs.com/terms_and_conditions.htm and for electronic format documents, subject to Terms and Conditions for Electronic Documents at www.sgs.com/terms_e-document.htm. Attention is drawn to the limitation of liability, indemnification and jurisdiction issues defined therein. Any holder of this document is advised that information contained hereon reflects the Company's findings at the time of its intervention only and within the limits of Client's instructions, if any. The Company's sole responsibility is to its Client and this document does not exonerate parties to a transaction from exercising all their rights and obligations under the transaction documents. This document cannot be reproduced except in full, without prior written approval of the Company. Any unauthorized alteration, forgery or falsification of the content or appearance of this document is unlawful and offenders may be prosecuted to the fullest extent of the law.

Model No.: HSC-I006R

Mode_10_+



Mode_10_-



Unless otherwise stated the results shown in this test report refer only to the sample(s) tested and such sample(s) are retained for 90 days only.

除非另有說明，此報告結果僅對測試之樣品負責，同時此樣品僅保留90天。本報告未經本公司書面許可，不可部份複製。

This document is issued by the Company subject to its General Conditions of Service printed overleaf, available on request or accessible at www.sgs.com/terms_and_conditions.htm and for electronic format documents, subject to Terms and Conditions for Electronic Documents at www.sgs.com/terms_e-document.htm. Attention is drawn to the limitation of liability, indemnification and jurisdiction issues defined therein. Any holder of this document is advised that information contained hereon reflects the Company's findings at the time of its intervention only and within the limits of Client's instructions, if any. The Company's sole responsibility is to its Client and this document does not exonerate parties to a transaction from exercising all their rights and obligations under the transaction documents. This document cannot be reproduced except in full, without prior written approval of the Company. Any unauthorized alteration, forgery or falsification of the content or appearance of this document is unlawful and offenders may be prosecuted to the fullest extent of the law.

**RE Testing Set-up
Below 1GHz**

**Model No.: HSC-I006R
Mode_5_+**

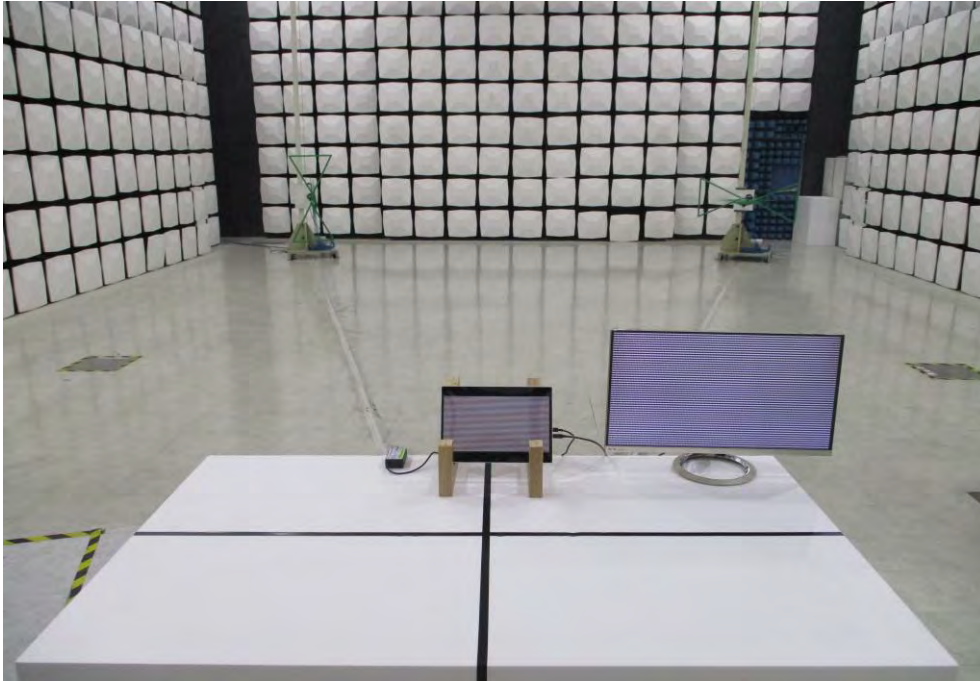

Mode_5_-

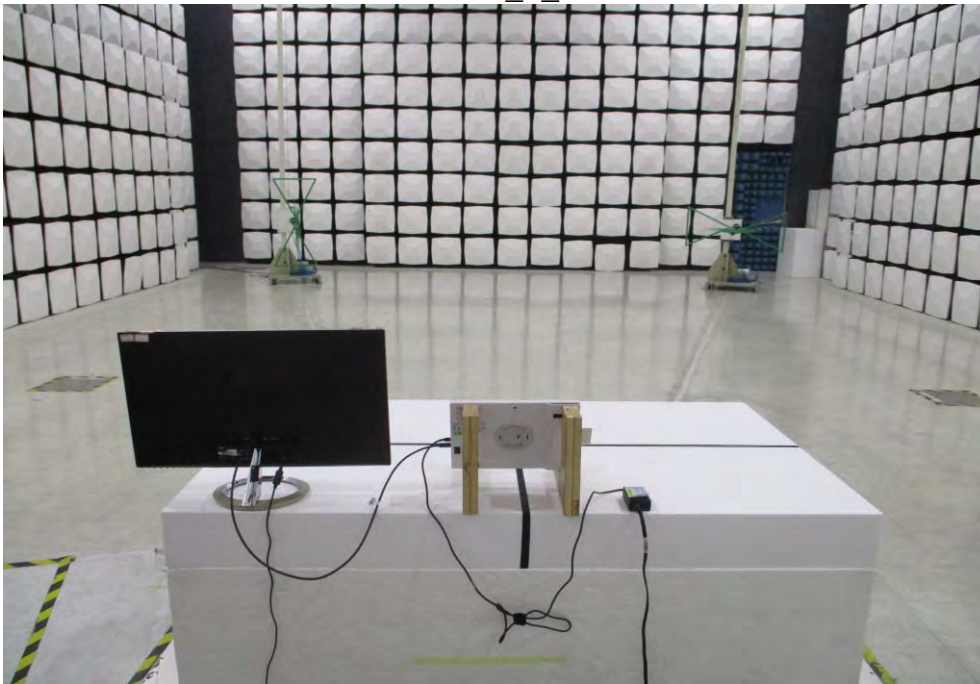

Unless otherwise stated the results shown in this test report refer only to the sample(s) tested and such sample(s) are retained for 90 days only.

除非另有說明，此報告結果僅對測試之樣品負責，同時此樣品僅保留90天。本報告未經本公司書面許可，不可部份複製。

This document is issued by the Company subject to its General Conditions of Service printed overleaf, available on request or accessible at www.sgs.com/terms_and_conditions.htm and for electronic format documents, subject to Terms and Conditions for Electronic Documents at www.sgs.com/terms_e-document.htm. Attention is drawn to the limitation of liability, indemnification and jurisdiction issues defined therein. Any holder of this document is advised that information contained hereon reflects the Company's findings at the time of its intervention only and within the limits of Client's instructions, if any. The Company's sole responsibility is to its Client and this document does not exonerate parties to a transaction from exercising all their rights and obligations under the transaction documents. This document cannot be reproduced except in full, without prior written approval of the Company. Any unauthorized alteration, forgery or falsification of the content or appearance of this document is unlawful and offenders may be prosecuted to the fullest extent of the law.

Model No.: HSC-I006R

Mode 9_+



Mode 9_-

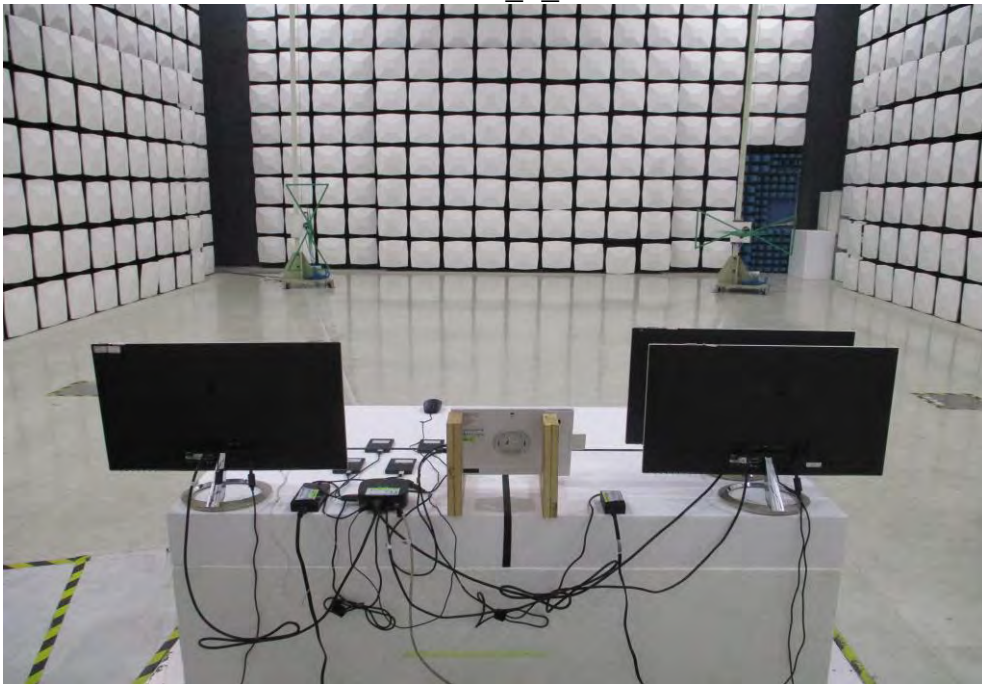

Unless otherwise stated the results shown in this test report refer only to the sample(s) tested and such sample(s) are retained for 90 days only.

除非另有說明，此報告結果僅對測試之樣品負責，同時此樣品僅保留90天。本報告未經本公司書面許可，不可部份複製。

This document is issued by the Company subject to its General Conditions of Service printed overleaf, available on request or accessible at www.sgs.com/terms_and_conditions.htm and for electronic format documents, subject to Terms and Conditions for Electronic Documents at www.sgs.com/terms_e-document.htm. Attention is drawn to the limitation of liability, indemnification and jurisdiction issues defined therein. Any holder of this document is advised that information contained hereon reflects the Company's findings at the time of its intervention only and within the limits of Client's instructions, if any. The Company's sole responsibility is to its Client and this document does not exonerate parties to a transaction from exercising all their rights and obligations under the transaction documents. This document cannot be reproduced except in full, without prior written approval of the Company. Any unauthorized alteration, forgery or falsification of the content or appearance of this document is unlawful and offenders may be prosecuted to the fullest extent of the law.

Model No.: HSC-I006R

Mode_10_+



Mode_10_-

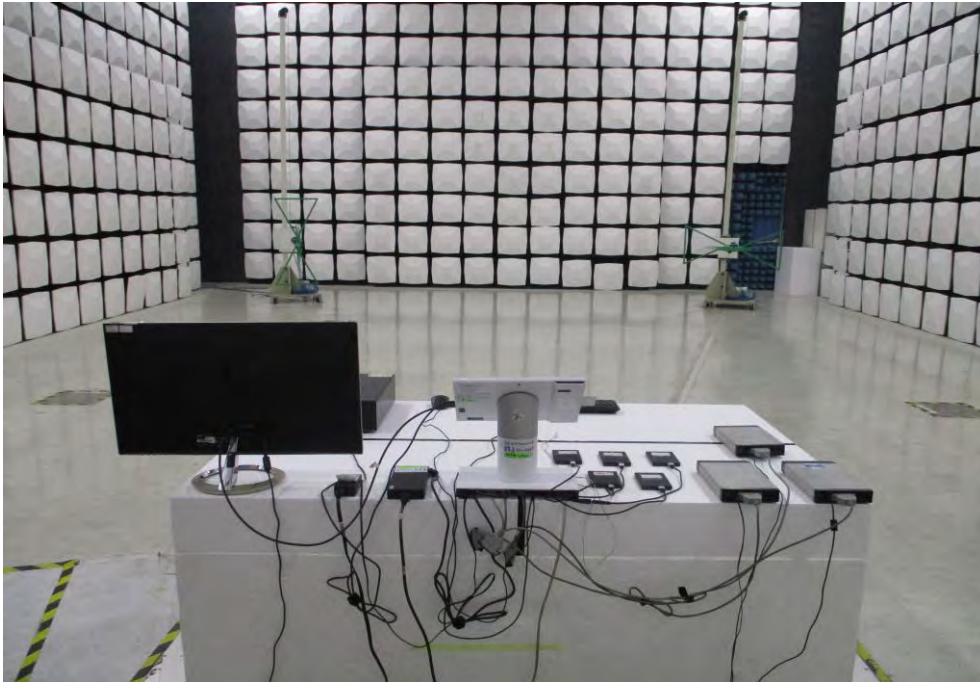

Unless otherwise stated the results shown in this test report refer only to the sample(s) tested and such sample(s) are retained for 90 days only.

除非另有說明，此報告結果僅對測試之樣品負責，同時此樣品僅保留90天。本報告未經本公司書面許可，不可部份複製。

This document is issued by the Company subject to its General Conditions of Service printed overleaf, available on request or accessible at www.sgs.com/terms_and_conditions.htm and for electronic format documents, subject to Terms and Conditions for Electronic Documents at www.sgs.com/terms_e-document.htm. Attention is drawn to the limitation of liability, indemnification and jurisdiction issues defined therein. Any holder of this document is advised that information contained hereon reflects the Company's findings at the time of its intervention only and within the limits of Client's instructions, if any. The Company's sole responsibility is to its Client and this document does not exonerate parties to a transaction from exercising all their rights and obligations under the transaction documents. This document cannot be reproduced except in full, without prior written approval of the Company. Any unauthorized alteration, forgery or falsification of the content or appearance of this document is unlawful and offenders may be prosecuted to the fullest extent of the law.

Above 1GHz

Model No.: HSC-I006R

Mode 5_+

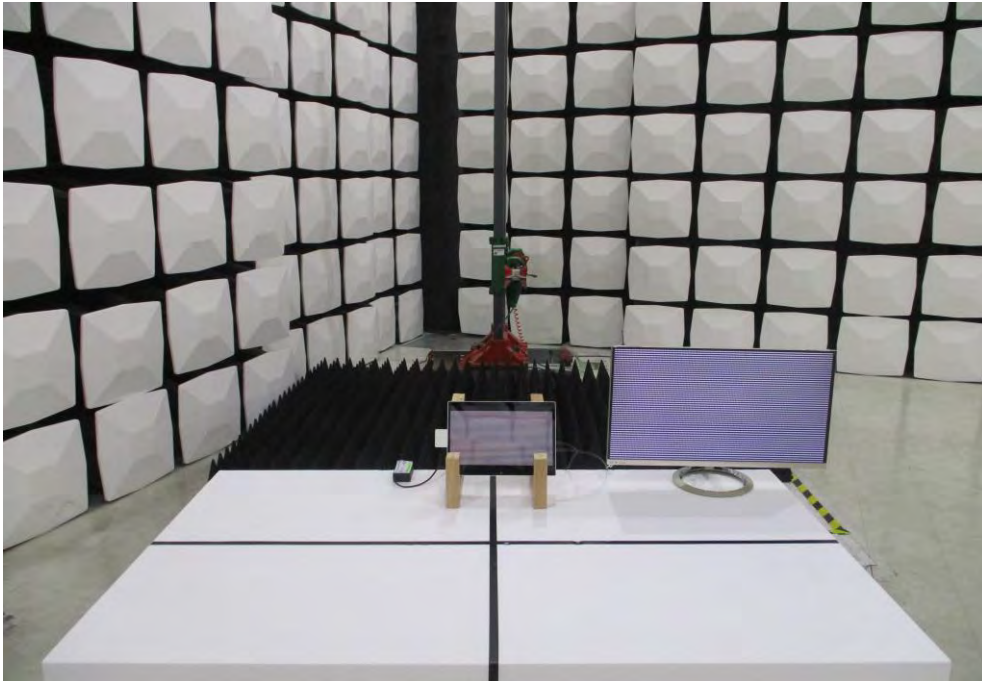

Mode 5_-

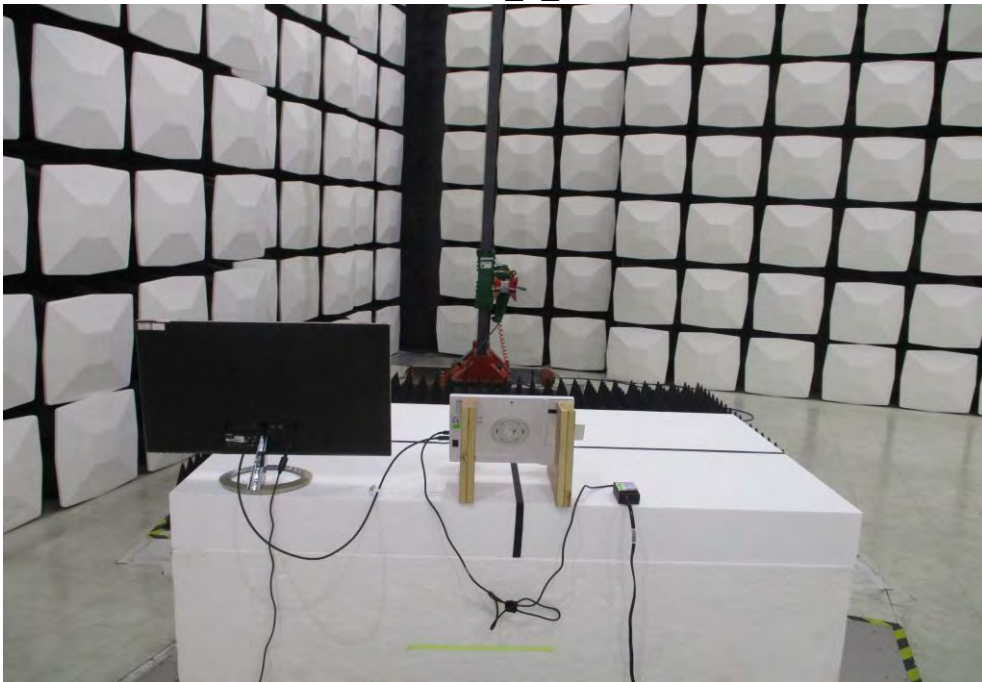

Unless otherwise stated the results shown in this test report refer only to the sample(s) tested and such sample(s) are retained for 90 days only.

除非另有說明，此報告結果僅對測試之樣品負責，同時此樣品僅保留90天。本報告未經本公司書面許可，不可部份複製。

This document is issued by the Company subject to its General Conditions of Service printed overleaf, available on request or accessible at www.sgs.com/terms_and_conditions.htm and for electronic format documents, subject to Terms and Conditions for Electronic Documents at www.sgs.com/terms_e-document.htm. Attention is drawn to the limitation of liability, indemnification and jurisdiction issues defined therein. Any holder of this document is advised that information contained hereon reflects the Company's findings at the time of its intervention only and within the limits of Client's instructions, if any. The Company's sole responsibility is to its Client and this document does not exonerate parties to a transaction from exercising all their rights and obligations under the transaction documents. This document cannot be reproduced except in full, without prior written approval of the Company. Any unauthorized alteration, forgery or falsification of the content or appearance of this document is unlawful and offenders may be prosecuted to the fullest extent of the law.

Model No.: HSC-I006R

Mode 9_+

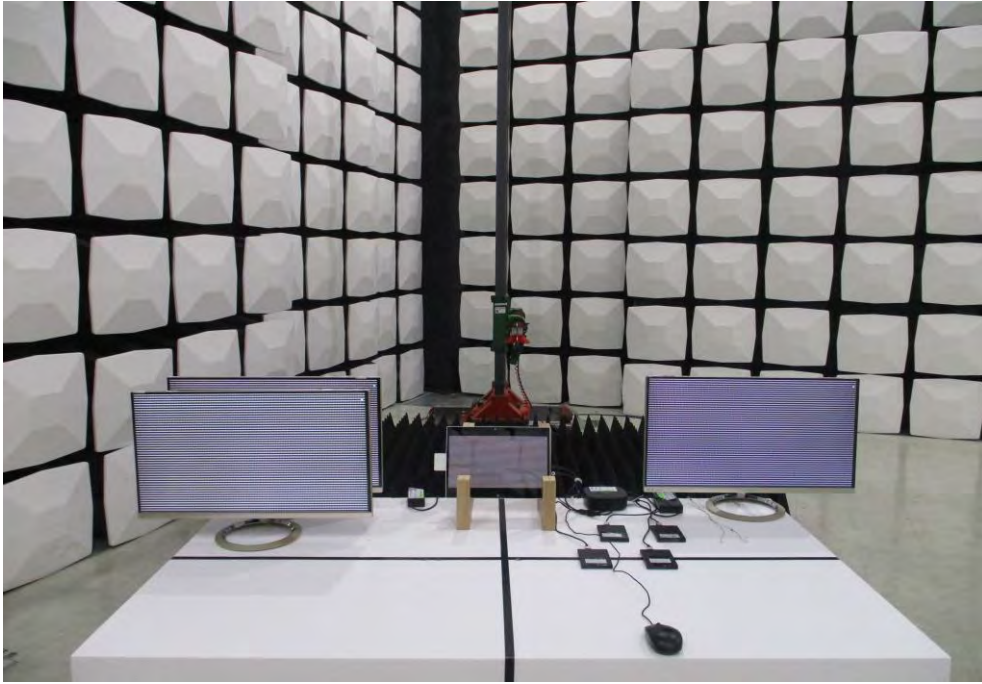

Mode 9_-

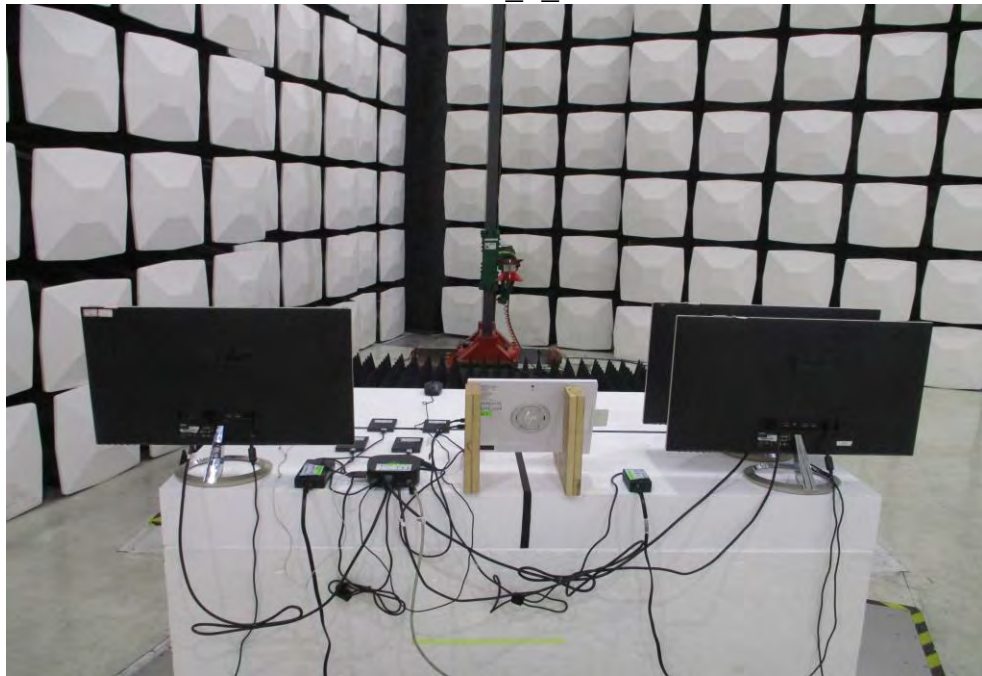

Unless otherwise stated the results shown in this test report refer only to the sample(s) tested and such sample(s) are retained for 90 days only.

除非另有說明，此報告結果僅對測試之樣品負責，同時此樣品僅保留90天。本報告未經本公司書面許可，不可部份複製。

This document is issued by the Company subject to its General Conditions of Service printed overleaf, available on request or accessible at www.sgs.com/terms_and_conditions.htm and for electronic format documents, subject to Terms and Conditions for Electronic Documents at www.sgs.com/terms_e-document.htm. Attention is drawn to the limitation of liability, indemnification and jurisdiction issues defined therein. Any holder of this document is advised that information contained hereon reflects the Company's findings at the time of its intervention only and within the limits of Client's instructions, if any. The Company's sole responsibility is to its Client and this document does not exonerate parties to a transaction from exercising all their rights and obligations under the transaction documents. This document cannot be reproduced except in full, without prior written approval of the Company. Any unauthorized alteration, forgery or falsification of the content or appearance of this document is unlawful and offenders may be prosecuted to the fullest extent of the law.

Model No.: HSC-I006R

Mode_10_+



Mode_10_-

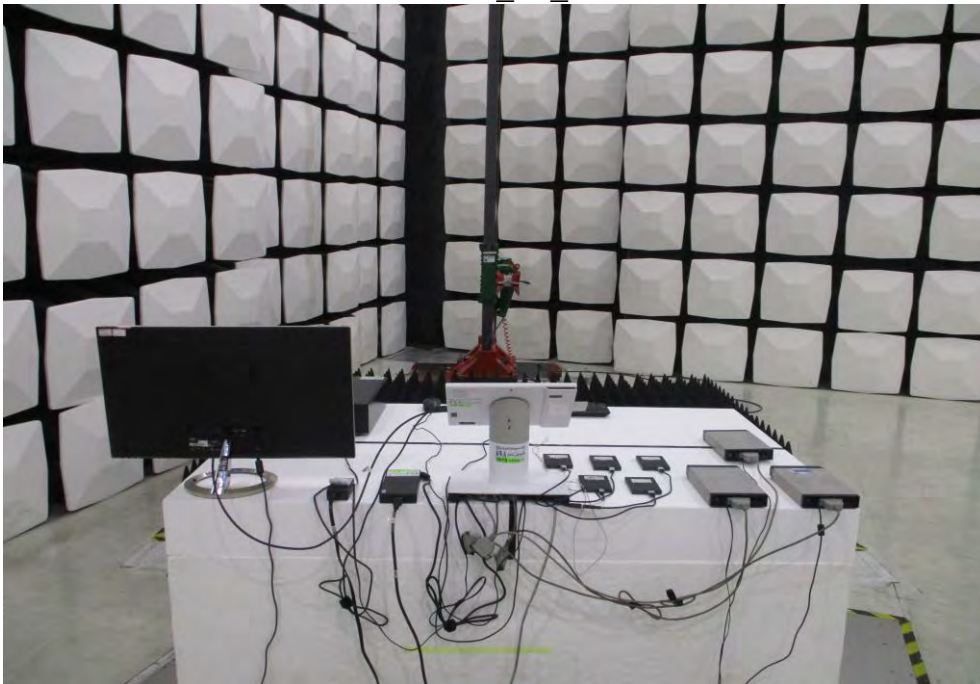

Unless otherwise stated the results shown in this test report refer only to the sample(s) tested and such sample(s) are retained for 90 days only.

除非另有說明，此報告結果僅對測試之樣品負責，同時此樣品僅保留90天。本報告未經本公司書面許可，不可部份複製。

This document is issued by the Company subject to its General Conditions of Service printed overleaf, available on request or accessible at www.sgs.com/terms_and_conditions.htm and for electronic format documents, subject to Terms and Conditions for Electronic Documents at www.sgs.com/terms_e-document.htm. Attention is drawn to the limitation of liability, indemnification and jurisdiction issues defined therein. Any holder of this document is advised that information contained hereon reflects the Company's findings at the time of its intervention only and within the limits of Client's instructions, if any. The Company's sole responsibility is to its Client and this document does not exonerate parties to a transaction from exercising all their rights and obligations under the transaction documents. This document cannot be reproduced except in full, without prior written approval of the Company. Any unauthorized alteration, forgery or falsification of the content or appearance of this document is unlawful and offenders may be prosecuted to the fullest extent of the law.

Photographs of Product Exterior

Model No.: HSC-I006R

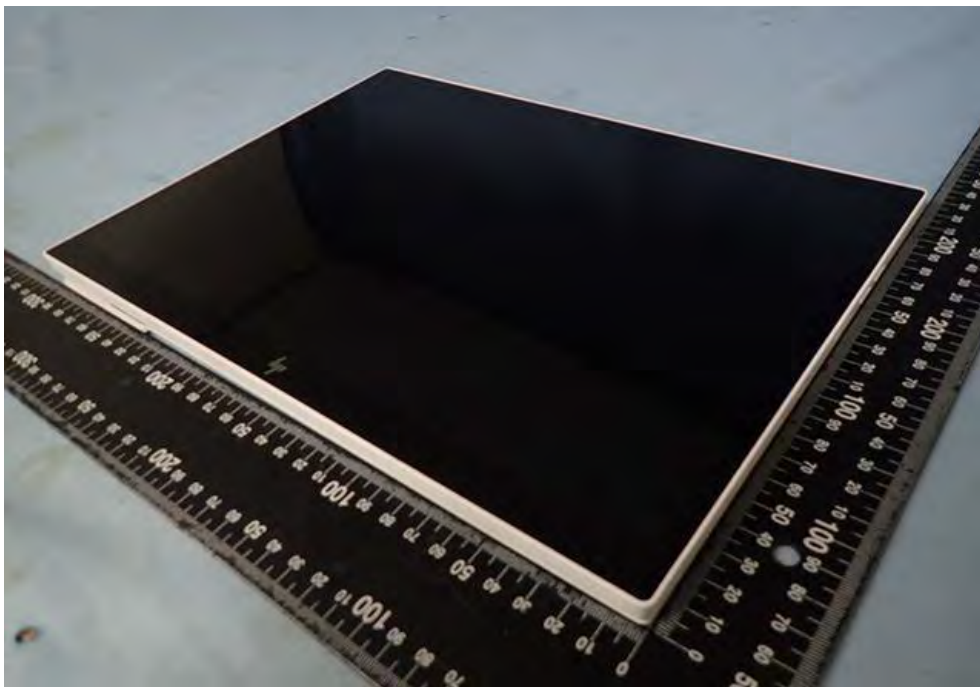

Unless otherwise stated the results shown in this test report refer only to the sample(s) tested and such sample(s) are retained for 90 days only.

除非另有說明，此報告結果僅對測試之樣品負責，同時此樣品僅保留90天。本報告未經本公司書面許可，不可部份複製。

This document is issued by the Company subject to its General Conditions of Service printed overleaf, available on request or accessible at www.sgs.com/terms_and_conditions.htm and for electronic format documents, subject to Terms and Conditions for Electronic Documents at www.sgs.com/terms_e-document.htm. Attention is drawn to the limitation of liability, indemnification and jurisdiction issues defined therein. Any holder of this document is advised that information contained hereon reflects the Company's findings at the time of its intervention only and within the limits of Client's instructions, if any. The Company's sole responsibility is to its Client and this document does not exonerate parties to a transaction from exercising all their rights and obligations under the transaction documents. This document cannot be reproduced except in full, without prior written approval of the Company. Any unauthorized alteration, forgery or falsification of the content or appearance of this document is unlawful and offenders may be prosecuted to the fullest extent of the law.



Unless otherwise stated the results shown in this test report refer only to the sample(s) tested and such sample(s) are retained for 90 days only.

除非另有說明，此報告結果僅對測試之樣品負責，同時此樣品僅保留90天。本報告未經本公司書面許可，不可部份複製。

This document is issued by the Company subject to its General Conditions of Service printed overleaf, available on request or accessible at www.sgs.com/terms_and_conditions.htm and for electronic format documents, subject to Terms and Conditions for Electronic Documents at www.sgs.com/terms_e-document.htm. Attention is drawn to the limitation of liability, indemnification and jurisdiction issues defined therein. Any holder of this document is advised that information contained hereon reflects the Company's findings at the time of its intervention only and within the limits of Client's instructions, if any. The Company's sole responsibility is to its Client and this document does not exonerate parties to a transaction from exercising all their rights and obligations under the transaction documents. This document cannot be reproduced except in full, without prior written approval of the Company. Any unauthorized alteration, forgery or falsification of the content or appearance of this document is unlawful and offenders may be prosecuted to the fullest extent of the law.



Unless otherwise stated the results shown in this test report refer only to the sample(s) tested and such sample(s) are retained for 90 days only.

除非另有說明，此報告結果僅對測試之樣品負責，同時此樣品僅保留90天。本報告未經本公司書面許可，不可部份複製。

This document is issued by the Company subject to its General Conditions of Service printed overleaf, available on request or accessible at www.sgs.com/terms_and_conditions.htm and for electronic format documents, subject to Terms and Conditions for Electronic Documents at www.sgs.com/terms_e-document.htm. Attention is drawn to the limitation of liability, indemnification and jurisdiction issues defined therein. Any holder of this document is advised that information contained hereon reflects the Company's findings at the time of its intervention only and within the limits of Client's instructions, if any. The Company's sole responsibility is to its Client and this document does not exonerate parties to a transaction from exercising all their rights and obligations under the transaction documents. This document cannot be reproduced except in full, without prior written approval of the Company. Any unauthorized alteration, forgery or falsification of the content or appearance of this document is unlawful and offenders may be prosecuted to the fullest extent of the law.

Adapter Model No.: TPN-CA21



Unless otherwise stated the results shown in this test report refer only to the sample(s) tested and such sample(s) are retained for 90 days only.

除非另有說明，此報告結果僅對測試之樣品負責，同時此樣品僅保留90天。本報告未經本公司書面許可，不可部份複製。

This document is issued by the Company subject to its General Conditions of Service printed overleaf, available on request or accessible at www.sgs.com/terms_and_conditions.htm and for electronic format documents, subject to Terms and Conditions for Electronic Documents at www.sgs.com/terms_e-document.htm. Attention is drawn to the limitation of liability, indemnification and jurisdiction issues defined therein. Any holder of this document is advised that information contained hereon reflects the Company's findings at the time of its intervention only and within the limits of Client's instructions, if any. The Company's sole responsibility is to its Client and this document does not exonerate parties to a transaction from exercising all their rights and obligations under the transaction documents. This document cannot be reproduced except in full, without prior written approval of the Company. Any unauthorized alteration, forgery or falsification of the content or appearance of this document is unlawful and offenders may be prosecuted to the fullest extent of the law.



Unless otherwise stated the results shown in this test report refer only to the sample(s) tested and such sample(s) are retained for 90 days only.

除非另有說明，此報告結果僅對測試之樣品負責，同時此樣品僅保留90天。本報告未經本公司書面許可，不可部份複製。

This document is issued by the Company subject to its General Conditions of Service printed overleaf, available on request or accessible at www.sgs.com/terms_and_conditions.htm and for electronic format documents, subject to Terms and Conditions for Electronic Documents at www.sgs.com/terms_e-document.htm. Attention is drawn to the limitation of liability, indemnification and jurisdiction issues defined therein. Any holder of this document is advised that information contained hereon reflects the Company's findings at the time of its intervention only and within the limits of Client's instructions, if any. The Company's sole responsibility is to its Client and this document does not exonerate parties to a transaction from exercising all their rights and obligations under the transaction documents. This document cannot be reproduced except in full, without prior written approval of the Company. Any unauthorized alteration, forgery or falsification of the content or appearance of this document is unlawful and offenders may be prosecuted to the fullest extent of the law.

Adapter Model No.: TPN-DA20



Unless otherwise stated the results shown in this test report refer only to the sample(s) tested and such sample(s) are retained for 90 days only.

除非另有說明，此報告結果僅對測試之樣品負責，同時此樣品僅保留90天。本報告未經本公司書面許可，不可部份複製。

This document is issued by the Company subject to its General Conditions of Service printed overleaf, available on request or accessible at www.sgs.com/terms_and_conditions.htm and for electronic format documents, subject to Terms and Conditions for Electronic Documents at www.sgs.com/terms_e-document.htm. Attention is drawn to the limitation of liability, indemnification and jurisdiction issues defined therein. Any holder of this document is advised that information contained hereon reflects the Company's findings at the time of its intervention only and within the limits of Client's instructions, if any. The Company's sole responsibility is to its Client and this document does not exonerate parties to a transaction from exercising all their rights and obligations under the transaction documents. This document cannot be reproduced except in full, without prior written approval of the Company. Any unauthorized alteration, forgery or falsification of the content or appearance of this document is unlawful and offenders may be prosecuted to the fullest extent of the law.



Unless otherwise stated the results shown in this test report refer only to the sample(s) tested and such sample(s) are retained for 90 days only.

除非另有說明，此報告結果僅對測試之樣品負責，同時此樣品僅保留90天。本報告未經本公司書面許可，不可部份複製。

This document is issued by the Company subject to its General Conditions of Service printed overleaf, available on request or accessible at www.sgs.com/terms_and_conditions.htm and for electronic format documents, subject to Terms and Conditions for Electronic Documents at www.sgs.com/terms_e-document.htm. Attention is drawn to the limitation of liability, indemnification and jurisdiction issues defined therein. Any holder of this document is advised that information contained hereon reflects the Company's findings at the time of its intervention only and within the limits of Client's instructions, if any. The Company's sole responsibility is to its Client and this document does not exonerate parties to a transaction from exercising all their rights and obligations under the transaction documents. This document cannot be reproduced except in full, without prior written approval of the Company. Any unauthorized alteration, forgery or falsification of the content or appearance of this document is unlawful and offenders may be prosecuted to the fullest extent of the law.

Adapter Model No.: TPN-LA23



Unless otherwise stated the results shown in this test report refer only to the sample(s) tested and such sample(s) are retained for 90 days only.

除非另有說明，此報告結果僅對測試之樣品負責，同時此樣品僅保留90天。本報告未經本公司書面許可，不可部份複製。

This document is issued by the Company subject to its General Conditions of Service printed overleaf, available on request or accessible at www.sgs.com/terms_and_conditions.htm and for electronic format documents, subject to Terms and Conditions for Electronic Documents at www.sgs.com/terms_e-document.htm. Attention is drawn to the limitation of liability, indemnification and jurisdiction issues defined therein. Any holder of this document is advised that information contained hereon reflects the Company's findings at the time of its intervention only and within the limits of Client's instructions, if any. The Company's sole responsibility is to its Client and this document does not exonerate parties to a transaction from exercising all their rights and obligations under the transaction documents. This document cannot be reproduced except in full, without prior written approval of the Company. Any unauthorized alteration, forgery or falsification of the content or appearance of this document is unlawful and offenders may be prosecuted to the fullest extent of the law.



Unless otherwise stated the results shown in this test report refer only to the sample(s) tested and such sample(s) are retained for 90 days only.

除非另有說明，此報告結果僅對測試之樣品負責，同時此樣品僅保留90天。本報告未經本公司書面許可，不可部份複製。

This document is issued by the Company subject to its General Conditions of Service printed overleaf, available on request or accessible at www.sgs.com/terms_and_conditions.htm and for electronic format documents, subject to Terms and Conditions for Electronic Documents at www.sgs.com/terms_e-document.htm. Attention is drawn to the limitation of liability, indemnification and jurisdiction issues defined therein. Any holder of this document is advised that information contained hereon reflects the Company's findings at the time of its intervention only and within the limits of Client's instructions, if any. The Company's sole responsibility is to its Client and this document does not exonerate parties to a transaction from exercising all their rights and obligations under the transaction documents. This document cannot be reproduced except in full, without prior written approval of the Company. Any unauthorized alteration, forgery or falsification of the content or appearance of this document is unlawful and offenders may be prosecuted to the fullest extent of the law.

Adapter Model No.: TPN-HA01



Unless otherwise stated the results shown in this test report refer only to the sample(s) tested and such sample(s) are retained for 90 days only.

除非另有說明，此報告結果僅對測試之樣品負責，同時此樣品僅保留90天。本報告未經本公司書面許可，不可部份複製。

This document is issued by the Company subject to its General Conditions of Service printed overleaf, available on request or accessible at www.sgs.com/terms_and_conditions.htm and for electronic format documents, subject to Terms and Conditions for Electronic Documents at www.sgs.com/terms_e-document.htm. Attention is drawn to the limitation of liability, indemnification and jurisdiction issues defined therein. Any holder of this document is advised that information contained hereon reflects the Company's findings at the time of its intervention only and within the limits of Client's instructions, if any. The Company's sole responsibility is to its Client and this document does not exonerate parties to a transaction from exercising all their rights and obligations under the transaction documents. This document cannot be reproduced except in full, without prior written approval of the Company. Any unauthorized alteration, forgery or falsification of the content or appearance of this document is unlawful and offenders may be prosecuted to the fullest extent of the law.



Unless otherwise stated the results shown in this test report refer only to the sample(s) tested and such sample(s) are retained for 90 days only.

除非另有說明，此報告結果僅對測試之樣品負責，同時此樣品僅保留90天。本報告未經本公司書面許可，不可部份複製。

This document is issued by the Company subject to its General Conditions of Service printed overleaf, available on request or accessible at www.sgs.com/terms_and_conditions.htm and for electronic format documents, subject to Terms and Conditions for Electronic Documents at www.sgs.com/terms_e-document.htm. Attention is drawn to the limitation of liability, indemnification and jurisdiction issues defined therein. Any holder of this document is advised that information contained hereon reflects the Company's findings at the time of its intervention only and within the limits of Client's instructions, if any. The Company's sole responsibility is to its Client and this document does not exonerate parties to a transaction from exercising all their rights and obligations under the transaction documents. This document cannot be reproduced except in full, without prior written approval of the Company. Any unauthorized alteration, forgery or falsification of the content or appearance of this document is unlawful and offenders may be prosecuted to the fullest extent of the law.

Dock Model No.: HSN-I001D



Unless otherwise stated the results shown in this test report refer only to the sample(s) tested and such sample(s) are retained for 90 days only.

除非另有說明，此報告結果僅對測試之樣品負責，同時此樣品僅保留90天。本報告未經本公司書面許可，不可部份複製。

This document is issued by the Company subject to its General Conditions of Service printed overleaf, available on request or accessible at www.sgs.com/terms_and_conditions.htm and for electronic format documents, subject to Terms and Conditions for Electronic Documents at www.sgs.com/terms_e-document.htm. Attention is drawn to the limitation of liability, indemnification and jurisdiction issues defined therein. Any holder of this document is advised that information contained hereon reflects the Company's findings at the time of its intervention only and within the limits of Client's instructions, if any. The Company's sole responsibility is to its Client and this document does not exonerate parties to a transaction from exercising all their rights and obligations under the transaction documents. This document cannot be reproduced except in full, without prior written approval of the Company. Any unauthorized alteration, forgery or falsification of the content or appearance of this document is unlawful and offenders may be prosecuted to the fullest extent of the law.



Unless otherwise stated the results shown in this test report refer only to the sample(s) tested and such sample(s) are retained for 90 days only.

除非另有說明，此報告結果僅對測試之樣品負責，同時此樣品僅保留90天。本報告未經本公司書面許可，不可部份複製。

This document is issued by the Company subject to its General Conditions of Service printed overleaf, available on request or accessible at www.sgs.com/terms_and_conditions.htm and for electronic format documents, subject to Terms and Conditions for Electronic Documents at www.sgs.com/terms_e-document.htm. Attention is drawn to the limitation of liability, indemnification and jurisdiction issues defined therein. Any holder of this document is advised that information contained hereon reflects the Company's findings at the time of its intervention only and within the limits of Client's instructions, if any. The Company's sole responsibility is to its Client and this document does not exonerate parties to a transaction from exercising all their rights and obligations under the transaction documents. This document cannot be reproduced except in full, without prior written approval of the Company. Any unauthorized alteration, forgery or falsification of the content or appearance of this document is unlawful and offenders may be prosecuted to the fullest extent of the law.



Unless otherwise stated the results shown in this test report refer only to the sample(s) tested and such sample(s) are retained for 90 days only.

除非另有說明，此報告結果僅對測試之樣品負責，同時此樣品僅保留90天。本報告未經本公司書面許可，不可部份複製。

This document is issued by the Company subject to its General Conditions of Service printed overleaf, available on request or accessible at www.sgs.com/terms_and_conditions.htm and for electronic format documents, subject to Terms and Conditions for Electronic Documents at www.sgs.com/terms_e-document.htm. Attention is drawn to the limitation of liability, indemnification and jurisdiction issues defined therein. Any holder of this document is advised that information contained hereon reflects the Company's findings at the time of its intervention only and within the limits of Client's instructions, if any. The Company's sole responsibility is to its Client and this document does not exonerate parties to a transaction from exercising all their rights and obligations under the transaction documents. This document cannot be reproduced except in full, without prior written approval of the Company. Any unauthorized alteration, forgery or falsification of the content or appearance of this document is unlawful and offenders may be prosecuted to the fullest extent of the law.



Unless otherwise stated the results shown in this test report refer only to the sample(s) tested and such sample(s) are retained for 90 days only.

除非另有說明，此報告結果僅對測試之樣品負責，同時此樣品僅保留90天。本報告未經本公司書面許可，不可部份複製。

This document is issued by the Company subject to its General Conditions of Service printed overleaf, available on request or accessible at www.sgs.com/terms_and_conditions.htm and for electronic format documents, subject to Terms and Conditions for Electronic Documents at www.sgs.com/terms_e-document.htm. Attention is drawn to the limitation of liability, indemnification and jurisdiction issues defined therein. Any holder of this document is advised that information contained hereon reflects the Company's findings at the time of its intervention only and within the limits of Client's instructions, if any. The Company's sole responsibility is to its Client and this document does not exonerate parties to a transaction from exercising all their rights and obligations under the transaction documents. This document cannot be reproduced except in full, without prior written approval of the Company. Any unauthorized alteration, forgery or falsification of the content or appearance of this document is unlawful and offenders may be prosecuted to the fullest extent of the law.

HP ElitePOS Retail Basic I/O Connectivity Base Model No.: TPC-I026-D

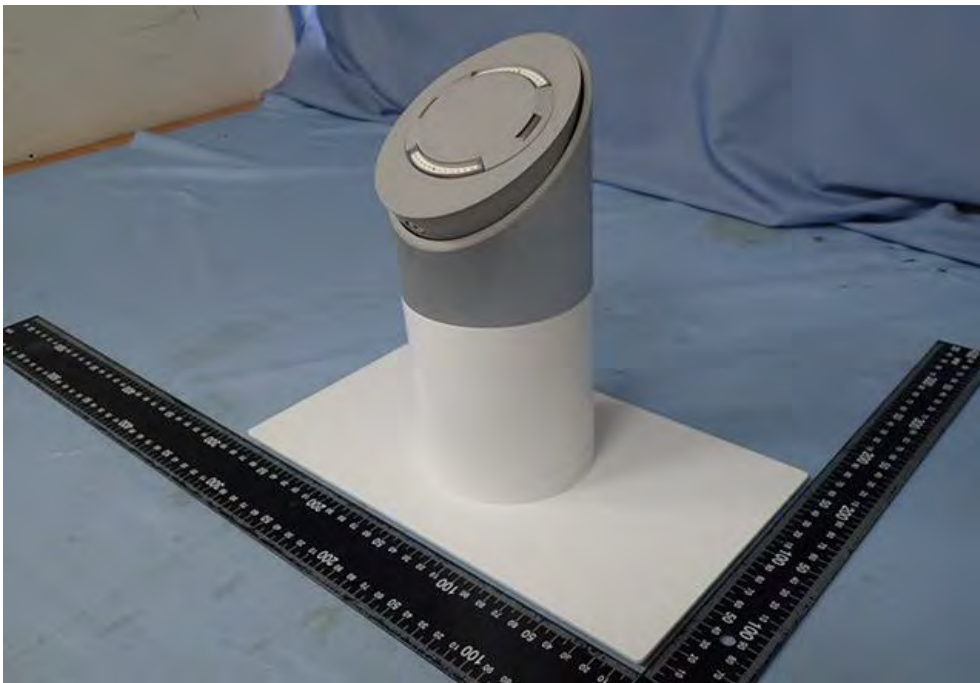
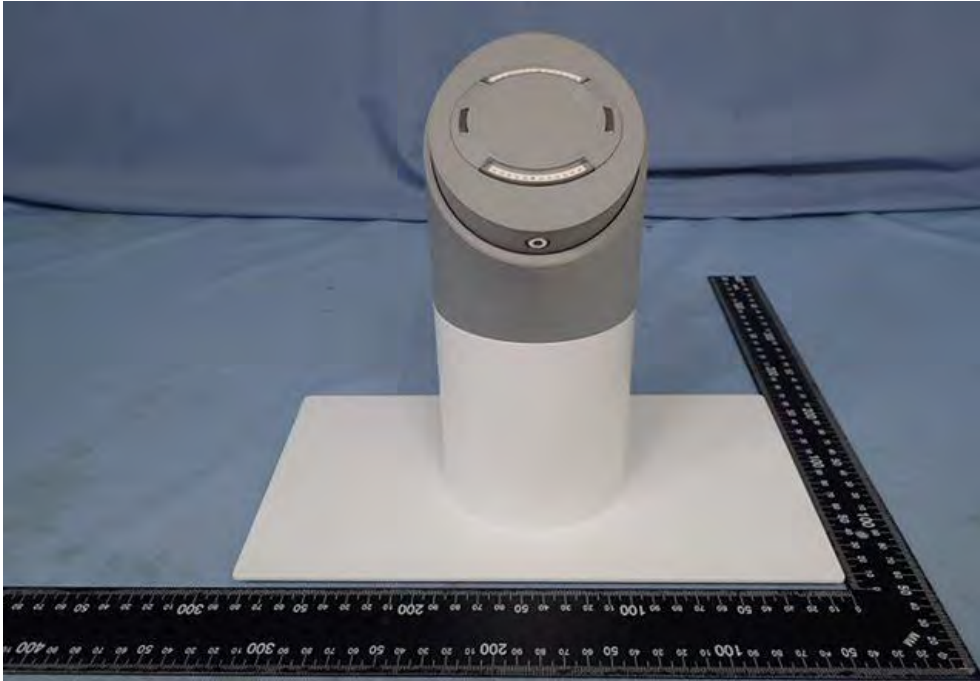

Unless otherwise stated the results shown in this test report refer only to the sample(s) tested and such sample(s) are retained for 90 days only.

除非另有說明，此報告結果僅對測試之樣品負責，同時此樣品僅保留90天。本報告未經本公司書面許可，不可部份複製。

This document is issued by the Company subject to its General Conditions of Service printed overleaf, available on request or accessible at www.sgs.com/terms_and_conditions.htm and for electronic format documents, subject to Terms and Conditions for Electronic Documents at www.sgs.com/terms_e-document.htm. Attention is drawn to the limitation of liability, indemnification and jurisdiction issues defined therein. Any holder of this document is advised that information contained hereon reflects the Company's findings at the time of its intervention only and within the limits of Client's instructions, if any. The Company's sole responsibility is to its Client and this document does not exonerate parties to a transaction from exercising all their rights and obligations under the transaction documents. This document cannot be reproduced except in full, without prior written approval of the Company. Any unauthorized alteration, forgery or falsification of the content or appearance of this document is unlawful and offenders may be prosecuted to the fullest extent of the law.

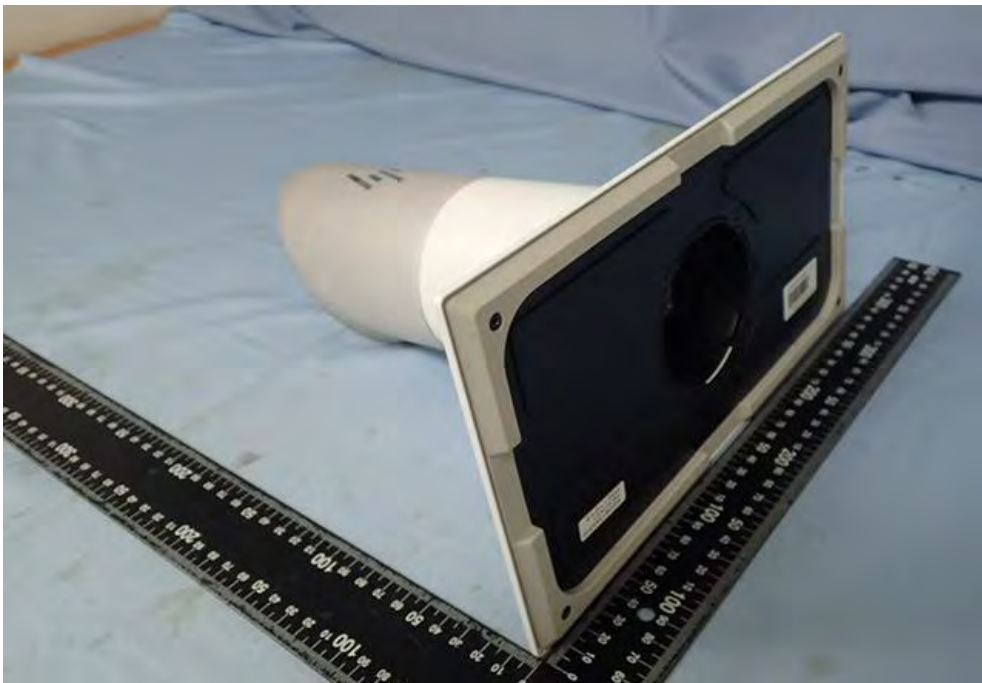
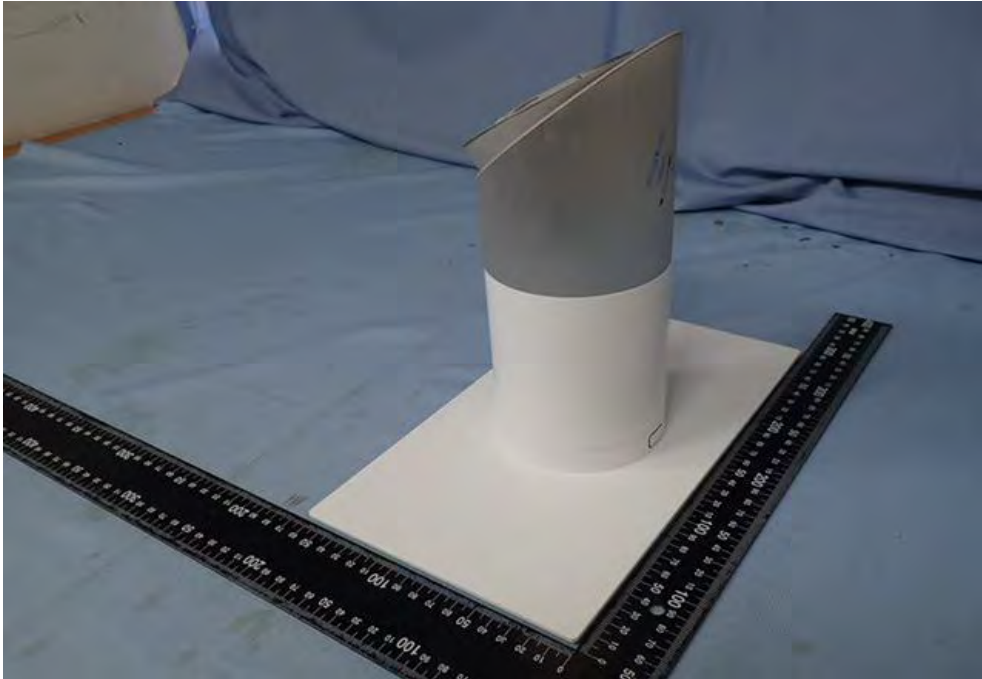

Unless otherwise stated the results shown in this test report refer only to the sample(s) tested and such sample(s) are retained for 90 days only.

除非另有說明，此報告結果僅對測試之樣品負責，同時此樣品僅保留90天。本報告未經本公司書面許可，不可部份複製。

This document is issued by the Company subject to its General Conditions of Service printed overleaf, available on request or accessible at www.sgs.com/terms_and_conditions.htm and for electronic format documents, subject to Terms and Conditions for Electronic Documents at www.sgs.com/terms_e-document.htm. Attention is drawn to the limitation of liability, indemnification and jurisdiction issues defined therein. Any holder of this document is advised that information contained hereon reflects the Company's findings at the time of its intervention only and within the limits of Client's instructions, if any. The Company's sole responsibility is to its Client and this document does not exonerate parties to a transaction from exercising all their rights and obligations under the transaction documents. This document cannot be reproduced except in full, without prior written approval of the Company. Any unauthorized alteration, forgery or falsification of the content or appearance of this document is unlawful and offenders may be prosecuted to the fullest extent of the law.



Unless otherwise stated the results shown in this test report refer only to the sample(s) tested and such sample(s) are retained for 90 days only.

除非另有說明，此報告結果僅對測試之樣品負責，同時此樣品僅保留90天。本報告未經本公司書面許可，不可部份複製。

This document is issued by the Company subject to its General Conditions of Service printed overleaf, available on request or accessible at www.sgs.com/terms_and_conditions.htm and for electronic format documents, subject to Terms and Conditions for Electronic Documents at www.sgs.com/terms_e-document.htm. Attention is drawn to the limitation of liability, indemnification and jurisdiction issues defined therein. Any holder of this document is advised that information contained hereon reflects the Company's findings at the time of its intervention only and within the limits of Client's instructions, if any. The Company's sole responsibility is to its Client and this document does not exonerate parties to a transaction from exercising all their rights and obligations under the transaction documents. This document cannot be reproduced except in full, without prior written approval of the Company. Any unauthorized alteration, forgery or falsification of the content or appearance of this document is unlawful and offenders may be prosecuted to the fullest extent of the law.



Unless otherwise stated the results shown in this test report refer only to the sample(s) tested and such sample(s) are retained for 90 days only.

除非另有說明，此報告結果僅對測試之樣品負責，同時此樣品僅保留90天。本報告未經本公司書面許可，不可部份複製。

This document is issued by the Company subject to its General Conditions of Service printed overleaf, available on request or accessible at www.sgs.com/terms_and_conditions.htm and for electronic format documents, subject to Terms and Conditions for Electronic Documents at www.sgs.com/terms_e-document.htm. Attention is drawn to the limitation of liability, indemnification and jurisdiction issues defined therein. Any holder of this document is advised that information contained hereon reflects the Company's findings at the time of its intervention only and within the limits of Client's instructions, if any. The Company's sole responsibility is to its Client and this document does not exonerate parties to a transaction from exercising all their rights and obligations under the transaction documents. This document cannot be reproduced except in full, without prior written approval of the Company. Any unauthorized alteration, forgery or falsification of the content or appearance of this document is unlawful and offenders may be prosecuted to the fullest extent of the law.

Docking Station Model No.: HSN-IX02



Unless otherwise stated the results shown in this test report refer only to the sample(s) tested and such sample(s) are retained for 90 days only.

除非另有說明，此報告結果僅對測試之樣品負責，同時此樣品僅保留90天。本報告未經本公司書面許可，不可部份複製。

This document is issued by the Company subject to its General Conditions of Service printed overleaf, available on request or accessible at www.sgs.com/terms_and_conditions.htm and for electronic format documents, subject to Terms and Conditions for Electronic Documents at www.sgs.com/terms_e-document.htm. Attention is drawn to the limitation of liability, indemnification and jurisdiction issues defined therein. Any holder of this document is advised that information contained hereon reflects the Company's findings at the time of its intervention only and within the limits of Client's instructions, if any. The Company's sole responsibility is to its Client and this document does not exonerate parties to a transaction from exercising all their rights and obligations under the transaction documents. This document cannot be reproduced except in full, without prior written approval of the Company. Any unauthorized alteration, forgery or falsification of the content or appearance of this document is unlawful and offenders may be prosecuted to the fullest extent of the law.



Unless otherwise stated the results shown in this test report refer only to the sample(s) tested and such sample(s) are retained for 90 days only.

除非另有說明，此報告結果僅對測試之樣品負責，同時此樣品僅保留90天。本報告未經本公司書面許可，不可部份複製。

This document is issued by the Company subject to its General Conditions of Service printed overleaf, available on request or accessible at www.sgs.com/terms_and_conditions.htm and for electronic format documents, subject to Terms and Conditions for Electronic Documents at www.sgs.com/terms_e-document.htm. Attention is drawn to the limitation of liability, indemnification and jurisdiction issues defined therein. Any holder of this document is advised that information contained hereon reflects the Company's findings at the time of its intervention only and within the limits of Client's instructions, if any. The Company's sole responsibility is to its Client and this document does not exonerate parties to a transaction from exercising all their rights and obligations under the transaction documents. This document cannot be reproduced except in full, without prior written approval of the Company. Any unauthorized alteration, forgery or falsification of the content or appearance of this document is unlawful and offenders may be prosecuted to the fullest extent of the law.



Unless otherwise stated the results shown in this test report refer only to the sample(s) tested and such sample(s) are retained for 90 days only.

除非另有說明，此報告結果僅對測試之樣品負責，同時此樣品僅保留90天。本報告未經本公司書面許可，不可部份複製。

This document is issued by the Company subject to its General Conditions of Service printed overleaf, available on request or accessible at www.sgs.com/terms_and_conditions.htm and for electronic format documents, subject to Terms and Conditions for Electronic Documents at www.sgs.com/terms_e-document.htm. Attention is drawn to the limitation of liability, indemnification and jurisdiction issues defined therein. Any holder of this document is advised that information contained hereon reflects the Company's findings at the time of its intervention only and within the limits of Client's instructions, if any. The Company's sole responsibility is to its Client and this document does not exonerate parties to a transaction from exercising all their rights and obligations under the transaction documents. This document cannot be reproduced except in full, without prior written approval of the Company. Any unauthorized alteration, forgery or falsification of the content or appearance of this document is unlawful and offenders may be prosecuted to the fullest extent of the law.



Unless otherwise stated the results shown in this test report refer only to the sample(s) tested and such sample(s) are retained for 90 days only.

除非另有說明，此報告結果僅對測試之樣品負責，同時此樣品僅保留90天。本報告未經本公司書面許可，不可部份複製。

This document is issued by the Company subject to its General Conditions of Service printed overleaf, available on request or accessible at www.sgs.com/terms_and_conditions.htm and for electronic format documents, subject to Terms and Conditions for Electronic Documents at www.sgs.com/terms_e-document.htm. Attention is drawn to the limitation of liability, indemnification and jurisdiction issues defined therein. Any holder of this document is advised that information contained hereon reflects the Company's findings at the time of its intervention only and within the limits of Client's instructions, if any. The Company's sole responsibility is to its Client and this document does not exonerate parties to a transaction from exercising all their rights and obligations under the transaction documents. This document cannot be reproduced except in full, without prior written approval of the Company. Any unauthorized alteration, forgery or falsification of the content or appearance of this document is unlawful and offenders may be prosecuted to the fullest extent of the law.



Unless otherwise stated the results shown in this test report refer only to the sample(s) tested and such sample(s) are retained for 90 days only.
除非另有說明，此報告結果僅對測試之樣品負責，同時此樣品僅保留90天。本報告未經本公司書面許可，不可部份複製。

This document is issued by the Company subject to its General Conditions of Service printed overleaf, available on request or accessible at www.sgs.com/terms_and_conditions.htm and for electronic format documents, subject to Terms and Conditions for Electronic Documents at www.sgs.com/terms_e-document.htm. Attention is drawn to the limitation of liability, indemnification and jurisdiction issues defined therein. Any holder of this document is advised that information contained hereon reflects the Company's findings at the time of its intervention only and within the limits of Client's instructions, if any. The Company's sole responsibility is to its Client and this document does not exonerate parties to a transaction from exercising all their rights and obligations under the transaction documents. This document cannot be reproduced except in full, without prior written approval of the Company. Any unauthorized alteration, forgery or falsification of the content or appearance of this document is unlawful and offenders may be prosecuted to the fullest extent of the law.



Unless otherwise stated the results shown in this test report refer only to the sample(s) tested and such sample(s) are retained for 90 days only.

除非另有說明，此報告結果僅對測試之樣品負責，同時此樣品僅保留90天。本報告未經本公司書面許可，不可部份複製。

This document is issued by the Company subject to its General Conditions of Service printed overleaf, available on request or accessible at www.sgs.com/terms_and_conditions.htm and for electronic format documents, subject to Terms and Conditions for Electronic Documents at www.sgs.com/terms_e-document.htm. Attention is drawn to the limitation of liability, indemnification and jurisdiction issues defined therein. Any holder of this document is advised that information contained hereon reflects the Company's findings at the time of its intervention only and within the limits of Client's instructions, if any. The Company's sole responsibility is to its Client and this document does not exonerate parties to a transaction from exercising all their rights and obligations under the transaction documents. This document cannot be reproduced except in full, without prior written approval of the Company. Any unauthorized alteration, forgery or falsification of the content or appearance of this document is unlawful and offenders may be prosecuted to the fullest extent of the law.



Unless otherwise stated the results shown in this test report refer only to the sample(s) tested and such sample(s) are retained for 90 days only.

除非另有說明，此報告結果僅對測試之樣品負責，同時此樣品僅保留90天。本報告未經本公司書面許可，不可部份複製。

This document is issued by the Company subject to its General Conditions of Service printed overleaf, available on request or accessible at www.sgs.com/terms_and_conditions.htm and for electronic format documents, subject to Terms and Conditions for Electronic Documents at www.sgs.com/terms_e-document.htm. Attention is drawn to the limitation of liability, indemnification and jurisdiction issues defined therein. Any holder of this document is advised that information contained hereon reflects the Company's findings at the time of its intervention only and within the limits of Client's instructions, if any. The Company's sole responsibility is to its Client and this document does not exonerate parties to a transaction from exercising all their rights and obligations under the transaction documents. This document cannot be reproduced except in full, without prior written approval of the Company. Any unauthorized alteration, forgery or falsification of the content or appearance of this document is unlawful and offenders may be prosecuted to the fullest extent of the law.

HP ElitePOS Advanced I/O Connectivity Base Model No.: TPC-I027-D



Unless otherwise stated the results shown in this test report refer only to the sample(s) tested and such sample(s) are retained for 90 days only.

除非另有說明，此報告結果僅對測試之樣品負責，同時此樣品僅保留90天。本報告未經本公司書面許可，不可部份複製。

This document is issued by the Company subject to its General Conditions of Service printed overleaf, available on request or accessible at www.sgs.com/terms_and_conditions.htm and for electronic format documents, subject to Terms and Conditions for Electronic Documents at www.sgs.com/terms_e-document.htm. Attention is drawn to the limitation of liability, indemnification and jurisdiction issues defined therein. Any holder of this document is advised that information contained hereon reflects the Company's findings at the time of its intervention only and within the limits of Client's instructions, if any. The Company's sole responsibility is to its Client and this document does not exonerate parties to a transaction from exercising all their rights and obligations under the transaction documents. This document cannot be reproduced except in full, without prior written approval of the Company. Any unauthorized alteration, forgery or falsification of the content or appearance of this document is unlawful and offenders may be prosecuted to the fullest extent of the law.



Unless otherwise stated the results shown in this test report refer only to the sample(s) tested and such sample(s) are retained for 90 days only.

除非另有說明，此報告結果僅對測試之樣品負責，同時此樣品僅保留90天。本報告未經本公司書面許可，不可部份複製。

This document is issued by the Company subject to its General Conditions of Service printed overleaf, available on request or accessible at www.sgs.com/terms_and_conditions.htm and for electronic format documents, subject to Terms and Conditions for Electronic Documents at www.sgs.com/terms_e-document.htm. Attention is drawn to the limitation of liability, indemnification and jurisdiction issues defined therein. Any holder of this document is advised that information contained hereon reflects the Company's findings at the time of its intervention only and within the limits of Client's instructions, if any. The Company's sole responsibility is to its Client and this document does not exonerate parties to a transaction from exercising all their rights and obligations under the transaction documents. This document cannot be reproduced except in full, without prior written approval of the Company. Any unauthorized alteration, forgery or falsification of the content or appearance of this document is unlawful and offenders may be prosecuted to the fullest extent of the law.



Unless otherwise stated the results shown in this test report refer only to the sample(s) tested and such sample(s) are retained for 90 days only.

除非另有說明，此報告結果僅對測試之樣品負責，同時此樣品僅保留90天。本報告未經本公司書面許可，不可部份複製。

This document is issued by the Company subject to its General Conditions of Service printed overleaf, available on request or accessible at www.sgs.com/terms_and_conditions.htm and for electronic format documents, subject to Terms and Conditions for Electronic Documents at www.sgs.com/terms_e-document.htm. Attention is drawn to the limitation of liability, indemnification and jurisdiction issues defined therein. Any holder of this document is advised that information contained hereon reflects the Company's findings at the time of its intervention only and within the limits of Client's instructions, if any. The Company's sole responsibility is to its Client and this document does not exonerate parties to a transaction from exercising all their rights and obligations under the transaction documents. This document cannot be reproduced except in full, without prior written approval of the Company. Any unauthorized alteration, forgery or falsification of the content or appearance of this document is unlawful and offenders may be prosecuted to the fullest extent of the law.



Unless otherwise stated the results shown in this test report refer only to the sample(s) tested and such sample(s) are retained for 90 days only.

除非另有說明，此報告結果僅對測試之樣品負責，同時此樣品僅保留90天。本報告未經本公司書面許可，不可部份複製。

This document is issued by the Company subject to its General Conditions of Service printed overleaf, available on request or accessible at www.sgs.com/terms_and_conditions.htm and for electronic format documents, subject to Terms and Conditions for Electronic Documents at www.sgs.com/terms_e-document.htm. Attention is drawn to the limitation of liability, indemnification and jurisdiction issues defined therein. Any holder of this document is advised that information contained hereon reflects the Company's findings at the time of its intervention only and within the limits of Client's instructions, if any. The Company's sole responsibility is to its Client and this document does not exonerate parties to a transaction from exercising all their rights and obligations under the transaction documents. This document cannot be reproduced except in full, without prior written approval of the Company. Any unauthorized alteration, forgery or falsification of the content or appearance of this document is unlawful and offenders may be prosecuted to the fullest extent of the law.

Hub Model No.: TPC-I049-D



Unless otherwise stated the results shown in this test report refer only to the sample(s) tested and such sample(s) are retained for 90 days only.

除非另有說明，此報告結果僅對測試之樣品負責，同時此樣品僅保留90天。本報告未經本公司書面許可，不可部份複製。

This document is issued by the Company subject to its General Conditions of Service printed overleaf, available on request or accessible at www.sgs.com/terms_and_conditions.htm and for electronic format documents, subject to Terms and Conditions for Electronic Documents at www.sgs.com/terms_e-document.htm. Attention is drawn to the limitation of liability, indemnification and jurisdiction issues defined therein. Any holder of this document is advised that information contained hereon reflects the Company's findings at the time of its intervention only and within the limits of Client's instructions, if any. The Company's sole responsibility is to its Client and this document does not exonerate parties to a transaction from exercising all their rights and obligations under the transaction documents. This document cannot be reproduced except in full, without prior written approval of the Company. Any unauthorized alteration, forgery or falsification of the content or appearance of this document is unlawful and offenders may be prosecuted to the fullest extent of the law.

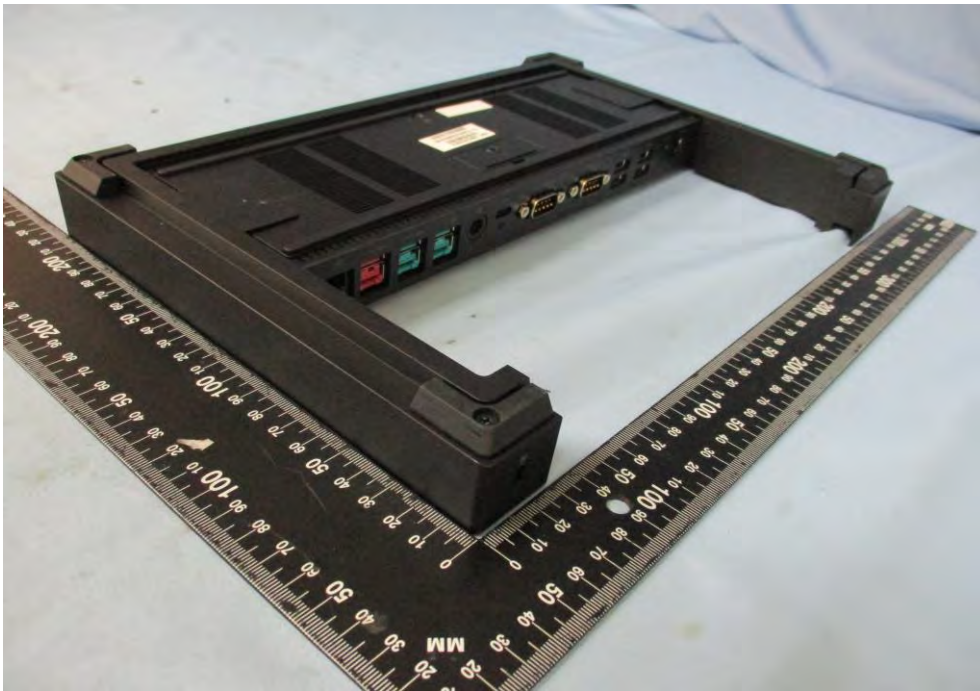
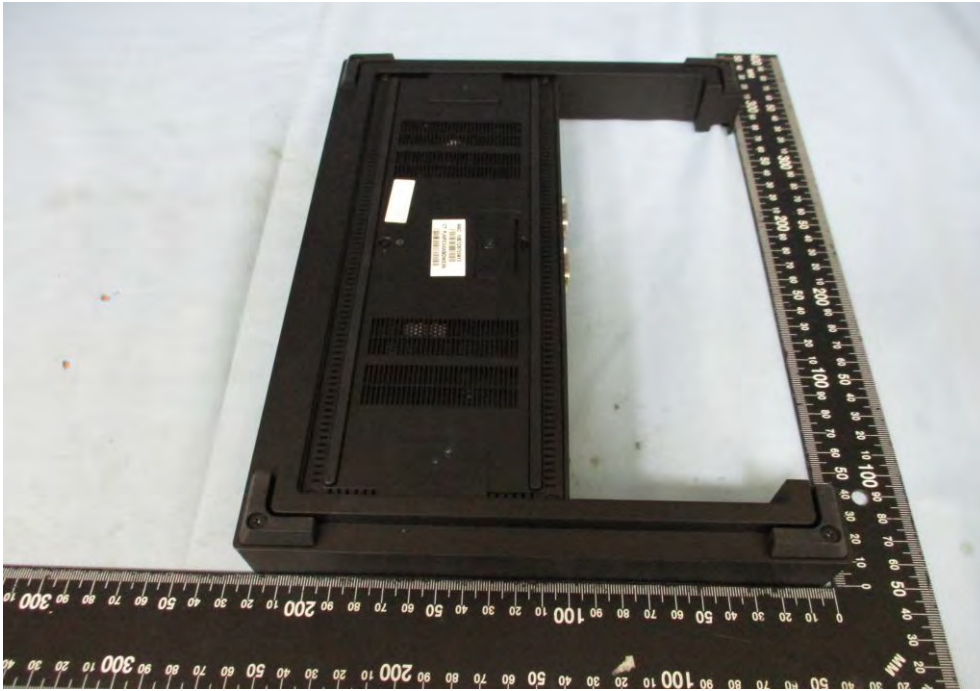

Unless otherwise stated the results shown in this test report refer only to the sample(s) tested and such sample(s) are retained for 90 days only.

除非另有說明，此報告結果僅對測試之樣品負責，同時此樣品僅保留90天。本報告未經本公司書面許可，不可部份複製。

This document is issued by the Company subject to its General Conditions of Service printed overleaf, available on request or accessible at www.sgs.com/terms_and_conditions.htm and for electronic format documents, subject to Terms and Conditions for Electronic Documents at www.sgs.com/terms_e-document.htm. Attention is drawn to the limitation of liability, indemnification and jurisdiction issues defined therein. Any holder of this document is advised that information contained hereon reflects the Company's findings at the time of its intervention only and within the limits of Client's instructions, if any. The Company's sole responsibility is to its Client and this document does not exonerate parties to a transaction from exercising all their rights and obligations under the transaction documents. This document cannot be reproduced except in full, without prior written approval of the Company. Any unauthorized alteration, forgery or falsification of the content or appearance of this document is unlawful and offenders may be prosecuted to the fullest extent of the law.



Unless otherwise stated the results shown in this test report refer only to the sample(s) tested and such sample(s) are retained for 90 days only.

除非另有說明，此報告結果僅對測試之樣品負責，同時此樣品僅保留90天。本報告未經本公司書面許可，不可部份複製。

This document is issued by the Company subject to its General Conditions of Service printed overleaf, available on request or accessible at www.sgs.com/terms_and_conditions.htm and for electronic format documents, subject to Terms and Conditions for Electronic Documents at www.sgs.com/terms_e-document.htm. Attention is drawn to the limitation of liability, indemnification and jurisdiction issues defined therein. Any holder of this document is advised that information contained hereon reflects the Company's findings at the time of its intervention only and within the limits of Client's instructions, if any. The Company's sole responsibility is to its Client and this document does not exonerate parties to a transaction from exercising all their rights and obligations under the transaction documents. This document cannot be reproduced except in full, without prior written approval of the Company. Any unauthorized alteration, forgery or falsification of the content or appearance of this document is unlawful and offenders may be prosecuted to the fullest extent of the law.



**** End of Report ****

Unless otherwise stated the results shown in this test report refer only to the sample(s) tested and such sample(s) are retained for 90 days only.

除非另有說明，此報告結果僅對測試之樣品負責，同時此樣品僅保留90天。本報告未經本公司書面許可，不可部份複製。

This document is issued by the Company subject to its General Conditions of Service printed overleaf, available on request or accessible at www.sgs.com/terms_and_conditions.htm and for electronic format documents, subject to Terms and Conditions for Electronic Documents at www.sgs.com/terms_e-document.htm. Attention is drawn to the limitation of liability, indemnification and jurisdiction issues defined therein. Any holder of this document is advised that information contained hereon reflects the Company's findings at the time of its intervention only and within the limits of Client's instructions, if any. The Company's sole responsibility is to its Client and this document does not exonerate parties to a transaction from exercising all their rights and obligations under the transaction documents. This document cannot be reproduced except in full, without prior written approval of the Company. Any unauthorized alteration, forgery or falsification of the content or appearance of this document is unlawful and offenders may be prosecuted to the fullest extent of the law.