



TEST REPORT

EUT Description	WWAN module installed on Tablet
Brand Name	HP
Model Name	HSC-I006R
FCC/IC ID	FCC ID: B94HCI006RKV; IC ID: 21374-FM350GL
Date of Test Start/End	2021-08-10 / 2022-08-26
Features	WWAN (5G NR, LTE, UMTS), WLAN, BT (see section 5)
Description	HP HSC-I006R + WNC Antenna

Applicant	HP Inc.
Address	1501 Page Mill Road, Palo Alto CA 94304 USA
Contact Person	Cindy Su
Telephone / Email	+886 2 37899591/cindy.su@hp.com

Reference Standards	FCC 47 CFR Part §2.1093 RSS-102, issue 5 (see section 1)	
RF Exposure Environment	Portable devices - General population/uncontrolled exposure	
Exposure Conditions	Body worn	
	SAR Result	SAR Limit
Maximum SAR Result & Limit	1.43 W/kg (1g)	1.6 W/kg (1g)
Min. test separation distance	0mm to phantom, 2.50mm to antenna edge	

Test Report identification	220720-03.TR02
Revision Control	Rev. 02 This test report revision replaces any previous test report revision (See section 8)

The test results relate only to the samples tested.
Reference to accreditation shall be used only by full reproduction of test report.

Issued by

Reviewed by

Edgar Garcia
(Test Engineer)

Zayd OUACHICHA
(Technical Manager)

**Intel Corporation S.A.S – WRF Lab
425 rue de Goa – Le Cargo B6 - 06600 Antibes, France
Tel. +33493001400 / Fax +33493001401**

Table of Contents

1. Standards, reference documents and applicable test methods	4
2. General conditions, competences and guarantees	4
3. Environmental Conditions	5
4. Test samples	5
5. EUT Features	6
6. Remarks and comments	13
7. Test Verdicts summary	13
8. Document Revision History	14
Annex A. Test & System Description	14
A.1 SAR DEFINITION	14
A.2 SAR MEASUREMENT SYSTEM	15
A.2.1 SAR Measurement Setup	15
A.2.2 E-Field Measurement Probe	16
A.2.3 Flat Phantom	16
A.2.4 Device Positioner	17
A.3 DATA EVALUATION	18
A.4 SYSTEM AND LIQUID CHECK	20
A.4.1 System Check	20
A.4.2 Liquid Check	21
A.5 TEST EQUIPMENT LIST	22
A.5.1 SAR System #2*	22
A.5.2 SAR System #3**	22
A.5.3 Shared Instrumentation	23
A.5.4 Tissue Simulant Liquid	23
A.6 MEASUREMENT UNCERTAINTY EVALUATION	24
A.7 RF EXPOSURE LIMITS	25
Annex B. Test Results	26
B.1 TEST CONDITIONS	26
B.1.1 Test SAR Test positions relative to the phantom	26
B.1.2 Test signal, Output power and Test Frequencies	27
B.1.3 5G NR TDD consideration	27
B.1.4 Evaluation Exclusion and Test Reductions	28
B.2 CONDUCTED POWER MEASUREMENTS TABLET MODE	33
B.2.1 WCDMA / HSPA / DC-HSPA	33
B.2.2 LTE	36
A.1.2 LTE UL Carrier Aggregation	65
A.1.3 5G NR (FR1)	66
A.2 TISSUE PARAMETERS MEASUREMENT	80
A.3 SYSTEM CHECK MEASUREMENTS	81
A.4 SAR TEST RESULTS	82
A.4.1 WCDMA	82
A.4.2 LTE	83
A.4.3 5G NR	88
A.4.4 ENDC	90
A.4.5 SAR Measurement Variability	91
A.4.7 Simultaneous Transmission SAR Evaluation	92
Annex B. Test System Plots	99

Annex C. TSL Dielectric Parameters 143

- C.1 BODY 700MHZ-900MHZ SAR SYSTEM 2..... 143
- C.2 BODY 1700MHZ-3700MHZ SAR SYSTEM 2..... 144
- C.3 800MHZ-3900MHZ SAR SYSTEM 3 146

Annex D. Calibration Certificates 148

Annex E. Photographs 150

- E.1 TEST SAMPLES 150
- E.2 TEST POSITIONS 151
- E.3 ANTENNA HOST PLATFORM LOCATION AND ADJACENT EDGE POSITIONS RELATIVE TO THE BODY 152
- E.4 PHANTOM LIQUID LEVEL DURING MEASUREMENTS 154

Annex F. NFC SAR test exclusion 155

- F.1 EVALUATION EXCLUSION AND TEST REDUCTIONS 155

1. Standards, reference documents and applicable test methods

FCC	<p>FCC Title 47 CFR Part §2.1093 – Radiofrequency radiation exposure evaluation: portable devices. 2020-10-01 Edition</p> <p>FCC OET KDB 447498 D01 v06– RF Exposure Procedures and Equipment Authorization Policies for Mobile and Portable Devices.</p> <p>FCC OET KDB 616217 D04 v01r02 – SAR Evaluation Considerations for Laptop, Notebook, Netbook and Tablet Computers.</p> <p>FCC OET KDB 865664 D01 v01r04 – SAR Measurement Requirements for 100 MHz to 6 GHz.</p> <p>FCC OET KDB 865664 D02 v01r02 – RF Exposure Compliance Reporting and Documentation Considerations.</p> <p>FCC OET KDB 941225 D05 v02r05 – SAR Evaluation Considerations for LTE Devices.</p> <p>FCC OET KDB 941225 D01 v03r01 – 3G SAR Measurement Procedures.</p> <p>IEEE Std 1528-2013 – IEEE Recommended Practice Determining the Peak Spatial-Average Specific Absorption Rate (SAR) in the Human Head from Wireless Communication Devices: Measurement Techniques...</p> <p>TCB workshop November 2017; RF Exposure Procedures (LTE UL/DL Carrier Aggregation SAR)</p> <p>TCB workshop October 2018; RF Exposure Procedures (LTE Inter-Band Uplink Carrier Aggregation –Interim Procedures)</p> <p>TCB workshop November 2019; RF Exposure Policy Updates (5G NR FR1 NSA EN-DC UE SAR Evaluations)</p> <p>TCB workshop November 2019; 5G NR/ EN-DC Compliance Test Configurations</p>
ISED	<ol style="list-style-type: none"> 1. ISED RSS 102, Issue 5 – Radio Frequency (RF) Exposure Compliance of Radio communication Apparatus (All Frequency Bands) 2. ISED RSS-102 Supplementary Procedures SPR-001 SAR testing requirements with regard to bystanders for laptop type computers with antennas built-in on display screen (Laptop Mode / Tablet Mode) 3. ISED Notice 2020-DRS2020 Applicability of IEC/IEEE62209-1528 and IEC 62209 -3 standard 4. ISED Notice 2016-DRS001 – Applicability of latest FCC RF Exposure KDB Procedures and Other Procedures. 5. ISED Notice 2012-DRS0529 – SAR correction for measured conductivity and relative permittivity based on IEC 62209-2 standard. 6. FCC OET KDB 447498 D01 V06 General RF Exposure Guidance v01– RF Exposure Procedures and Equipment Authorization Policies for Mobile and Portable Devices. 7. FCC OET KDB 616217 D04 v01r02 – SAR Evaluation Considerations for Laptop, Notebook, Netbook and Tablet Computers. 8. FCC OET KDB 865664 D01 v01r04 – SAR Measurement Requirements for 100 MHz to 6 GHz. 9. FCC OET KDB 865664 D02 v01r02 – RF Exposure Compliance Reporting and Documentation Considerations. 10. FCC OET KDB 941225 D05 v02r05 – SAR Evaluation Considerations for LTE Devices. 11. FCC OET KDB 941225 D01 v03r01 – 3G SAR Measurement Procedures. 12. IEC/IEEE 62209-1528:2020 Measurement procedure for the assessment of specific absorption rate of human exposure to radio frequency fields from hand-held and body-mounted wireless communication devices – Part 1528: Human models, instrumentation, and procedures (Frequency range of 4 MHz to 10 GHz)

2. General conditions, competences and guarantees

- ✓ Tests performed under FCC standards identified in section 1 are covered by A2LA accreditation.
- ✓ Tests performed under ISED standards identified in section 1 are covered by Cofrac accreditation.
- ✓ Intel Corporation SAS Wireless RF Lab (Intel WRF Lab) is an ISO/IEC 17025:2017 laboratory accredited by the American Association for Laboratory Accreditation (A2LA) with the certificate number 3478.01.
- ✓ Intel Corporation SAS Wireless RF Lab (Intel WRF Lab) is an Accredited Test Firm recognized by the FCC, with Designation Number FR0011.
- ✓ Intel Corporation SAS Wireless RF Lab (Intel WRF Lab) is an ISO/IEC 17025:2017 testing laboratory accredited by the French Committee for Accreditation (Cofrac) with the certificate number 1-6736.
- ✓ Intel Corporation SAS Wireless RF Lab (Intel WRF Lab) is a Registered Test Site listed by ISED, with ISED #1000Y.
- ✓ Intel WRF Lab declines any responsibility with respect to the identified information provided by the customer and that may affect the validity of results.
- ✓ Intel WRF Lab only provides testing services and is committed to providing reliable, unbiased test results and interpretations.
- ✓ Intel WRF Lab is liable to the client for the maintenance of the confidentiality of all information related to the item under test and the results of the test.
- ✓ Intel WRF Lab has developed calibration and proficiency programs for its measurement equipment to ensure correlated and reliable results to its customers.
- ✓ This report is only referred to the item that has undergone the test.
- ✓ This report does not imply an approval of the product by the Certification Bodies or competent Authorities.

3. Environmental Conditions

- ✓ At the site where the measurements were performed the following limits were not exceeded during the tests:

Temperature	22.6°C ± 1.5°C
Humidity	44% ± 6%
Liquid Temperature	21.5°C ± 1.5°C

4. Test samples

Sample	Control #	Description	Model	Serial #	Date of receipt	Comment
#01	220720-03.S06	WWAN module installed on Tablet	HSC-I006R	C892NE008Q	2022-08-19	5G NR tests
#02	220720-03.S04	WWAN module installed on Tablet	HSC-I006R	C902NE00HT	2022-08-19	WCDMA / LTE tests

5. EUT Features

The herein information is provided by the customer.

Intel WRF Lab declines any responsibility for the accuracy of the stated customer provided information, especially if it has any impact on the correctness of test results presented in this report.

Brand Name	HP
Model Name	HSC-I006R
Prototype / Production	Production
Host Identification	HSC-I006R

Supported radios

WWAN: The module is a data only DUT. The applicable frequency bands and operating modes are identified in the following table.

Mode	Bands	Supported Tx Mode			
		RMC	HSDPA	HSUPA	DC-HSDPA
WCDMA / HSPA+	FDD II (1850.0 – 1910.0 MHz)	✓	✓	✓	✓
	FDD IV (1710.0 – 1755.0 MHz)	✓	✓	✓	✓
	FDD V (824.0 – 849.0 MHz)	✓	✓	✓	✓

FDD/TDD	Bands	Modulations	Bandwidth					
			1.4	3	5	10	15	20
LTE FDD	Band 2 (1850.0 – 1910.0 MHz)	QPSK/16QAM/64QAM/256QAM	✓	✓	✓	✓	✓	✓
	Band 4 (1710.0 – 1755.0 MHz)	QPSK/16QAM/64QAM/256QAM	✓	✓	✓	✓	✓	✓
	Band 5 (824.0 – 849.0 MHz)	QPSK/16QAM/64QAM/256QAM	✓	✓	✓	✓		
	Band 7 (2500.0 – 2570.0 MHz)	QPSK/16QAM/64QAM/256QAM			✓	✓	✓	✓
	Band 12 (699.0 – 716.0 MHz)	QPSK/16QAM/64QAM/256QAM	✓	✓	✓	✓		
	Band 13 (777.0 – 787.0 MHz)	QPSK/16QAM/64QAM/256QAM			✓	✓		
	Band 14 (788.0 – 798.0 MHz)	QPSK/16QAM/64QAM/256QAM			✓	✓		
	Band 17 (704.0 – 716.0 MHz)	QPSK/16QAM/64QAM/256QAM			✓	✓		
	Band 25 (1850.0 – 1915.0 MHz)	QPSK/16QAM/64QAM/256QAM	✓	✓	✓	✓	✓	✓
	Band 26 (814.0 – 849.0 MHz)	QPSK/16QAM/64QAM/256QAM	✓	✓	✓	✓	✓	
	Band 30 (2305.0 – 2315.0 MHz)	QPSK/16QAM/64QAM/256QAM			✓	✓		
LTE TDD	Band 66 (1710.0 – 1780.0 MHz)	QPSK/16QAM/64QAM/256QAM	✓	✓	✓	✓	✓	✓
	Band 38 (2570.0 – 2620.0 MHz)	QPSK/16QAM/64QAM/256QAM			✓	✓	✓	✓
	Band 41 (2496.0 – 2690.0 MHz)	QPSK/16QAM/64QAM/256QAM			✓	✓	✓	✓
	Band 48 (3550.0 – 3700.0 MHz)	QPSK/16QAM/64QAM/256QAM			✓	✓	✓	✓

Bands	Modulation	SCS (KHz)	Bandwidth													
			5	10	15	20	25	30	40	50	60	70	80	90	100	
N2 FDD (1850.0 – 1910.0 MHz)	PI/2 BPSK QPSK 16QAM 64QAM 256QAM	15 30	✓	✓	✓	✓										
N5 FDD (824.0 – 849.0 MHz)	PV2 BPSK QPSK 16QAM 64QAM 256QAM	15 30 60	✓	✓	✓	✓										
N7 FDD (2500.0 – 2570.0 MHz)	PV2 BPSK QPSK 16QAM 64QAM 256QAM	15 30	✓	✓	✓	✓										
N25 FDD (1850.0 – 1915 MHz)	PV2 BPSK QPSK 16QAM 64QAM 256QAM	15 30	✓	✓	✓	✓										
N30 FDD (2305.0 – 2315.0 MHz)	PV2 BPSK QPSK 16QAM 64QAM 256QAM	15 30	✓	✓												
N38 TDD (2570.0 – 2620.0 MHz)	PV2 BPSK QPSK 16QAM 64QAM 256QAM	15 30 60	✓	✓	✓	✓										
N41 TDD (2496.0 – 2690.0 MHz)	PV2 BPSK QPSK 16QAM 64QAM 256QAM	15 30				✓			✓	✓	✓		✓	✓	✓	
N66 FDD (1710.0 – 1780.0 MHz)	PV2 BPSK QPSK 16QAM 64QAM 256QAM	15 30	✓	✓	✓	✓			✓							
N77 TDD* (3700.0 – 3980.0 MHz)	PV2 BPSK QPSK 16QAM 64QAM 256QAM	15 30		✓	✓	✓			✓	✓	✓		✓	✓	✓	
N78 TDD** (3700.0 – 3800.0 MHz)	PV2 BPSK QPSK 16QAM 64QAM 256QAM	15 30		✓	✓	✓			✓	✓	✓		✓	✓	✓	

*FCC limits 5G NR B77 to 3700-3980MHz

** FCC limits 5G NR B78 to 3700-3800MHz

UL carrier aggregation LTE (Inter-Band)		UL carrier aggregation LTE (Intra-band)
2A – 5A	5A – 48A	5B
2A – 12A	5A – 66A	7C
2A – 13A	12A – 30A	38C
2A – 14A	12A – 66A	41C
2A – 48A	13A – 48A	48C
4A – 5A	13A – 66A	66B
4A – 12A	14A – 30A	66C
4A – 13A	14A – 66A	
5A – 7A	25A – 26A	
5A – 30A	48A – 66A	

EN/DC possible combinations	
NR 5G Band	Associated LTE Bands
N2A	5, 12, 13, 14
N5A	2, 7, 30, 66, 48
N66A	5, 12, 13, 48
N41A	2, 66, 41
N77A	2, 5, 12, 13, 14, 30, 66, 41
N78A	2, 5, 7, 38

UL carrier aggregation 5G FR1	
	n2A – n5A
	n5A – n66A

WLAN

Mode	UL Freq Range
802.11b/g/n/ax	2.4GHz (2400.0 – 2483.5 MHz)
802.11a/n/ac/ax	5.2GHz (5150.0 – 5250.0 MHz) 5.3GHz (5250.0 – 5350.0 MHz) 5.6GHz (5470.0 – 5725.0 MHz) 5.8GHz (5725.0 – 5850.0 MHz)
802.11ax	6.0GHz (5925.0 – 7125.0 MHz)
Bluetooth v5.2 & BLE	2.4GHz (2400.0 – 2483.5 MHz)

Antenna Information “information provided by the applicant”

The DUTs have 2 WWAN TX antennas:

Transmitter	Main (Antenna 5)	Aux (Antenna 8)
Manufacturer	WNC	WNC
Antenna type	PIFA antenna	PIFA antenna
Part number	6036B0323801 (81ELA215.G57)	6036B0324001 (81ELA215.G60)

See Annex E for more details on antennas location.

NFC	
Tx/Rx Freq. Range	13.553 ~ 13.567MHz
Channel Number	1
20dBW	2.66kHz
99%OBW	2.24KHz
Antenna Type	Loop antenna
Modulation	ASK

WWAN Antenna Mapping

Configuration	Main (Ant 5)	Aux (Ant 8)
WCDMA	LB / MHB	
LTE	LB / MHB	
		UHB
NR 5G SA	(LB / MHB)	
		UHB
LTE ULCA	LB	MHB /UHB
	MHB	UHB
	B41	UHB
NR 5G ENDC	LB	MHB / B41
	B41	N41
	MHB	B41/N41
	B41/N41	UHB
	MHB	UHB
NR 5G ULCA	LB	MHB

- LB: WCDMA FDD V, LTE B5/12/13/14/17/26, 5G NR n5
- MHB: WCDMA FDD II/ FDD IV, LTE B2/4/7/25/30/66/38, 5G NR n2/n7/n25/n30/n38/n66
- UHB: LTE: B41/48; NR 5G: n41/n77/n78

Note: For EN-DC mode the 4G and 5G carriers transmit on separate antennas.
 For inter-bands on LTE and NR 5G ULCA the carriers transmit on separate antennas.

Simultaneous Transmission Configurations

- WWAN Main (Ant5) + WWAN Aux (Ant8) + WLAN 2.4GHz Main + BT Aux
- WWAN Main (Ant5) + WWAN Aux (Ant8) + WLAN 2.4GHz Main + WLAN 2.4GHz Aux
- WWAN Main (Ant5) + WWAN Aux (Ant8) + WLAN 5GHz Main + BT Aux
- WWAN Main (Ant5) + WWAN Aux (Ant8) + WLAN 5GHz Main + WLAN 5GHz Aux
- WWAN Main (Ant5) + WWAN Aux (Ant8) + WLAN 5GHz Main + WLAN 5GHz Aux + BT Aux
- WWAN Main (Ant5) + WWAN Aux (Ant8) + WLAN 6GHz Main + BT Aux
- WWAN Main (Ant5) + WWAN Aux (Ant8) + WLAN 6GHz Main + WLAN 6GHz Aux
- WWAN Main (Ant5) + WWAN Aux (Ant8) + WLAN 6GHz Main + WLAN 6GHz Aux + BT Aux

WLAN transmitter is considered in this report just for the simultaneous transmission evaluation with the WWAN module (See section A.4.7)

Additional information

- 5.60-5.65 GHz band (TDWR) is supported by the device
- Band gap is supported by the device
- Two power settings are implemented in the DUT:
 - Max power for Docking and Tablet modes
- Maximum Power Reduction (MPR) is implemented according to 3GPP, built-in by design on the tune-up power:

Modulation	Channel bandwidth / #RB						MPR (dB)
	1.4 MHz	3.0 MHz	5 MHz	10 MHz	15 MHz	20 MHz	
QPSK	> 5	> 4	> 8	> 12	> 16	> 18	≤ 1
16 QAM	≤ 5	≤ 4	≤ 8	≤ 12	≤ 16	≤ 18	≤ 1
16 QAM	> 5	> 4	> 8	> 12	> 16	> 18	≤ 2
64 QAM	≤ 5	≤ 4	≤ 8	≤ 12	≤ 16	≥ 18	≤ 2
64 QAM	> 5	> 4	> 8	> 12	> 16	> 18	≤ 3
256 QAM	≥ 1						≤ 5

The DUT uses the maximum MPR values described in the above tables.

The maximum power reduction is applicable on the tune up tolerance.

According to 3GPP 38-101-1, the UE is allowed to reduce the maximum output power due to higher order modulations and for channel bandwidths that meets both following criteria:

- Channel bandwidth ≤ 100MHz.
- Relative channel bandwidth ≤ 4% for TDD bands and ≤ 3% for FDD bands

Maximum power reduction (MPR) for power class 3			
Modulation	MPR (Db)		
	Edge RB allocations	Outer RB allocations	Inner RB allocations
DFT-s-OFDM PI/2 BPSK	≤ 3.5 ¹ 0.5 ²	≤ 1.2 ¹ 0.5 ²	≤ 0.2 ¹ 0 ²
DFT-s-OFDM QPSK	≤ 1		0
DFT-s-OFDM 16 QAM	≤ 2		≤ 1
DFT-s-OFDM 64 QAM	≤ 2.5		
DFT-s-OFDM 256 QAM	4.5		
CP-OFDM QPSK	≤ 3		≤ 1.5
CP-OFDM 16 QAM	≤ 3		≤ 2
CP-OFDM 64 QAM	≤ 3.5		
CP-OFDM 256 QAM	≤ 6.5		

NOTE 1: Applicable for UE operating in TDD mode with PI/2 PBSK modulation and if the IE [P-Boost-BPSK] is set to 1 and 40% or less slots in radio frame are used for UL transmission for bands n40, n77, n78 and n79.
NOTE 2: Applicable for UE operating in FDD mode, or in TDD mode in bands other than n40, n77, n78 and n79 and if the IE [Pboost-BPSK] is set to 0 and if more than 40% of slots in radio frame are used for UL transmission for bands n40, n77, n78 and n79.

Maximum power reduction (MPR) for power class 2			
Modulation	MPR (dB)		
	Edge RB allocations	Outer RB allocations	Inner RB allocations
DFT-s-OFDM PI/2 BPSK	≤ 3.5	≤ 0.5	0
DFT-s-OFDM QPSK	≤ 3.5	≤ 1	0
DFT-s-OFDM 16 QAM	≤ 3.5	≤ 2	≤ 1
DFT-s-OFDM 64 QAM	≤ 3.5	≤ 2.5	
DFT-s-OFDM 256 QAM	≤ 4.5		
CP-OFDM QPSK	≤ 3.5	≤ 3	≤ 1.5
CP-OFDM 16 QAM	≤ 3.5	≤ 3	≤ 2
CP-OFDM 64 QAM	≤ 3.5		
CP-OFDM 256 QAM	≤ 6.5		

The DUT uses the maximum MPR values described in the above tables.

The maximum power reduction is applicable on the tune up tolerance.

The following tables indicates the power levels and tolerance for docking & tablet modes:

Maximum Output power specification + Tune up tolerance

Mode	Tx Ant	Technology	Bands	Class	Nominal (dBm)	Tolerance dB	Lower Tolerance (dBm)	Upper Tolerance (dBm)
Docking	Ant 5	WCDMA/HSPA	FDD II (1850.0 – 1910.0 MHz)	3	23.5	±1	22.5	24.5
		WCDMA/HSPA	FDD IV (1710.0 – 1755.0 MHz)	3	23.5	±1	22.5	24.5
		WCDMA/HSPA	FDD V (824.0 – 849.0 MHz)	3	23.5	±1	22.5	24.5
		LTE	B2 (1850.0 – 1910.0 MHz)	3	23.0	±1	22.0	24.0
		LTE	B4 (1710.0 – 1755.0 MHz)	3	23.0	±1	22.0	24.0
		LTE	B5 (824.0 – 849.0 MHz)	3	24.0	±1	23.0	25.0
		LTE	B7 (2500.0 – 2570.0 MHz)	3	23.0	±1	22.0	24.0
		LTE	B12 (699.0 – 716.0 MHz)	3	23.0	±1	22.0	24.0
		LTE	B13 (777.0 – 787.0 MHz)	3	23.0	±1	22.0	24.0
		LTE	B14 (788.0 – 798.0 MHz)	3	23.0	±1	22.0	24.0
		LTE	B17 (704.0 – 716.0 MHz)	3	23.0	±1	22.0	24.0
		LTE	B25 (1850.0 – 1915.0 MHz)	3	23.0	±1	22.0	24.0
		LTE	B26 (814.0 – 849.0 MHz)	3	24.0	±1	23.0	25.0
		LTE	B30 (2305.0 – 2315.0 MHz)	3	23.0	±1	22.0	24.0
		LTE	B38 (2570.0 – 2620.0 MHz)	3	23.0	±1	22.0	24.0
		LTE	B41 (2496.0 – 2690.0 MHz)	3	23.0	±1	22.0	24.0
	LTE	B41-HPUE (2496.0 – 2690.0 MHz)	2	26.0	±1	25.0	27.0	
	LTE	B66 (1710.0 – 1780.0 MHz)	3	23.0	±1	22.0	24.0	
	LTE	B2 (1850.0 – 1910.0 MHz)	3	23.0	±1	22.0	24.0	
	LTE	B4 (1710.0 – 1755.0 MHz)	3	23.0	±1	22.0	24.0	
	LTE	B7 (2500.0 – 2570.0 MHz)	3	23.0	±1	22.0	24.0	
	LTE	B25 (1850.0 – 1915.0 MHz)	3	23.0	±1	22.0	24.0	
	LTE	B30 (2305.0 – 2315.0 MHz)	3	23.0	±1	22.0	24.0	
	LTE	B41 (2496.0 – 2690.0 MHz)	3	23.0	±1	22.0	24.0	
	LTE	B41-HPUE(2496.0 – 2690.0 MHz)	2	26.0	±1	25.0	27.0	
	LTE	B48 (3550.0 – 3700.0 MHz)	3	21.0	±1	20.0	22.0	
	LTE	B66 (1710.0 – 1780.0 MHz)	3	23.0	±1	22.0	24.0	
	LTE	B66 (1710.0 – 1780.0 MHz)	3	23.0	±1	22.0	24.0	
	Ant 5	5G NR	N2 (1850.0 – 1910.0 MHz)	3	23.0	±1	22.0	24.0
	5G NR	N5 (824.0 – 849.0 MHz)	3	23.0	±1	22.0	24.0	
	5G NR	N7 (2500.0 – 2570.0 MHz)	3	23.0	±1	22.0	24.0	
	5G NR	N25 (1850.0 – 1915.0 MHz)	3	23.0	±1	22.0	24.0	
	5G NR	N30 (2305.0 – 2315.0 MHz)	3	23.0	±1	22.0	24.0	
	5G NR	N38 (2570.0 – 2620.0 MHz)	3	23.0	±1	22.0	24.0	
	5G NR	N41 (2496.0 – 2690.0 MHz)	3	23.0	±1	22.0	24.0	
	5G NR	N41-HPUE(2496.0 – 2690.0 MHz)	2	26.0	±1	25.0	27.0	
	5G NR	N66 (1710.0 – 1780.0 MHz)	3	23.0	±1	22.0	24.0	
	5G NR	N77 (3700.0 – 3980.0 MHz)	3	23.0	±1	22.0	24.0	
	5G NR	N77-HPUE(3700.0 – 3980.0 MHz)	2	26.0	±1	25.0	27.0	
	5G NR	N78 (3700.0 – 3800.0 MHz)	3	23.0	±1	22.0	24.0	
	5G NR	N78-HPUE(3700.0 – 3800.0 MHz)	2	26.0	±1	25.0	27.0	
	Ant 8	5G NR	N2 (1850.0 – 1910.0 MHz)	3	23.0	±1	22.0	24.0
	5G NR	N38 (2570.0 – 2620.0 MHz)	3	23.0	±1	22.0	24.0	
	5G NR	N41 (2496.0 – 2690.0 MHz)	3	23.0	±1	22.0	24.0	
	5G NR	N41-HPUE(2496.0 – 2690.0 MHz)	2	26.0	±1	25.0	27.0	
	5G NR	N66 (1710.0 – 1780.0 MHz)	3	23.0	±1	22.0	24.0	
5G NR	N77 (3700.0 – 3980.0 MHz)	3	23.0	±1	22.0	24.0		
5G NR	N77-HPUE(3700.0 – 3980.0 MHz)	2	26.0	±1	25.0	27.0		
5G NR	N78 (3700.0 – 3800.0 MHz)	3	23.0	±1	22.0	24.0		
5G NR	N78-HPUE(3700.0 – 3800.0 MHz)	2	26.0	±1	25.0	27.0		

Mode	Tx Ant	Technology	Bands	Class	Nominal (dBm)	Tolerance dB	Lower Tolerance (dBm)	Upper Tolerance (dBm)
Tablet	Ant 5	WCDMA/HSPA	FDD II (1850.0 – 1910.0 MHz)	3	15.0	±1	14.0	16.0
		WCDMA/HSPA	FDD IV (1710.0 – 1755.0 MHz)	3	15.0	±1	14.0	16.0
		WCDMA/HSPA	FDD V (824.0 – 849.0 MHz)	3	19.0	±1	18.0	20.0
		LTE	B2 (1850.0 – 1910.0 MHz)	3	16.5	±1	15.5	17.5
		LTE	B4 (1710.0 – 1755.0 MHz)	3	19.0	±1	18.0	20.0
		LTE	B5 (824.0 – 849.0 MHz)	3	16.0	±1	15.0	17.0
		LTE	B7 (2500.0 – 2570.0 MHz)	3	17.0	±1	16.0	18.0
		LTE	B12 (699.0 – 716.0 MHz)	3	19.0	±1	18.0	20.0
		LTE	B13 (777.0 – 787.0 MHz)	3	18.0	±1	17.0	19.0
		LTE	B14 (788.0 – 798.0 MHz)	3	17.5	±1	16.5	18.5
		LTE	B17 (704.0 – 716.0 MHz)	3	19.0	±1	18.0	20.0
		LTE	B25 (1850.0 – 1915.0 MHz)	3	16.5	±1	15.5	17.5
		LTE	B26 (814.0 – 849.0 MHz)	3	16.0	±1	15.0	17.0
		LTE	B30 (2305.0 – 2315.0 MHz)	3	16.0	±1	15.0	17.0
		LTE	B38 (2570.0 – 2620.0 MHz)	3	17.5	±1	16.5	18.5
		LTE	B41 (2496.0 – 2690.0 MHz)	3	18.5	±1	17.5	19.5
		LTE	B41-HPUE (2496.0 – 2690.0 MHz)	2	18.5	±1	17.5	19.5
	LTE	B66 (1710.0 – 1780.0 MHz)	3	19.0	±1	18.0	20.0	
	Ant 8	LTE	B2 (1850.0 – 1910.0 MHz)	3	15.0	±1	14.0	16.0
		LTE	B4 (1710.0 – 1755.0 MHz)	3	15.0	±1	14.0	16.0
		LTE	B7 (2500.0 – 2570.0 MHz)	3	17.0	±1	16.0	18.0
		LTE	B25 (1850.0 – 1915.0 MHz)	3	15.0	±1	14.0	16.0
		LTE	B30 (2305.0 – 2315.0 MHz)	3	16.5	±1	15.5	17.5
		LTE	B41 (2496.0 – 2690.0 MHz)	3	16.5	±1	15.5	17.5
		LTE	B41-HPUE(2496.0 – 2690.0 MHz)	2	16.5	±1	15.5	17.5
	Ant 5	5G NR	N2 (1850.0 – 1910.0 MHz)	3	16.5	±1	15.5	17.5
		5G NR	N5 (824.0 – 849.0 MHz)	3	16.0	±1	15.0	17.0
		5G NR	N7 (2500.0 – 2570.0 MHz)	3	17.0	±1	16.0	18.0
		5G NR	N25 (1850.0 – 1915.0 MHz)	3	16.5	±1	15.5	17.5
		5G NR	N30 (2305.0 – 2315.0 MHz)	3	16.0	±1	15.0	17.0
		5G NR	N38 (2570.0 – 2620.0 MHz)	3	17.5	±1	16.5	18.5
		5G NR	N41 (2496.0 – 2690.0 MHz)	3	18.5	±1	17.5	19.5
		5G NR	N41-HPUE(2496.0 – 2690.0 MHz)	2	18.5	±1	17.5	19.5
		5G NR	N66 (1710.0 – 1780.0 MHz)	3	19.0	±1	18.0	20.0
		5G NR	N77 (3700.0 – 3980.0 MHz)	3	14.5	±1	13.5	15.5
		5G NR	N77-HPUE(3700.0 – 3980.0 MHz)	2	14.5	±1	13.5	15.5
		5G NR	N78 (3700.0 – 3800.0 MHz)	3	15.0	±1	14.0	16.0
	Ant 8	5G NR	N78-HPUE(3700.0 – 3800.0 MHz)	2	15.0	±1	14.0	16.0
		5G NR	N2 (1850.0 – 1910.0 MHz)	3	15.0	±1	14.0	16.0
		5G NR	N38 (2570.0 – 2620.0 MHz)	3	17.0	±1	16.0	18.0
		5G NR	N41 (2496.0 – 2690.0 MHz)	3	16.5	±1	15.5	17.5
		5G NR	N41-HPUE(2496.0 – 2690.0 MHz)	2	16.5	±1	15.5	17.5
5G NR		N66 (1710.0 – 1780.0 MHz)	3	15.0	±1	14.0	16.0	
5G NR		N77 (3700.0 – 3980.0 MHz)	3	13.0	±1	12.0	14.0	
5G NR		N77-HPUE(3700.0 – 3980.0 MHz)	2	13.0	±1	12.0	14.0	
5G NR	N78 (3700.0 – 3800.0 MHz)	3	12.5	±1	11.5	13.5		
5G NR	N78-HPUE(3700.0 – 3800.0 MHz)	2	12.5	±1	11.5	13.5		

6. Remarks and comments

1. Only the plots for the test positions with the highest measured SAR per band/mode are included in Annex B as required per FCC OET KDB 865664 D02, paragraph 2.3.h.
2. Maximum transmission power on modulations 64QAM and 256QAM for LTE and 5G NR, are lower than other QPSK and 16QAM modulations. Therefore, higher power modulations were chosen to perform all tests shown in this test report.

7. Test Verdicts summary

The statement of conformity to applicable standards in the table below are based on the measured values, without taking into account the measurement uncertainties.

Mode	Band (UL)	Highest Reported SAR (1g) (W/kg)	Verdict
WCDMA	FDD II (1850.0 – 1910.0 MHz)	0.58	P
	FDD IV (1710.0 – 1755.0 MHz)	0.35	P
	FDD V (824.0 – 849.0 MHz)	0.77	P
LTE FDD	Band 2 (1850.0 – 1910.0 MHz)	NM	NA
	Band 4 (1710.0 – 1755.0 MHz)	NM	NA
	Band 5 (824.0 – 849.0 MHz)	NM	NA
	Band 7 (2500.0 – 2570.0 MHz)	0.90	P
	Band 12 (699.0 – 716.0 MHz)	1.09	P
	Band 13 (777.0 – 787.0 MHz)	0.78	P
	Band 14 (788.0 – 798.0 MHz)	0.68	P
	Band 17 (704.0 – 716.0 MHz)	NM	NA
	Band 25 (1850.0 – 1915.0 MHz)	1.14	P
	Band 26 (814.0 – 849.0 MHz)	0.40	P
	Band 30 (2305.0 – 2315.0 MHz)	1.02	P
	Band 66 (1710.0 – 1780.0 MHz)	1.43	P
	LTE TDD	Band 38 (2570.0 – 2620.0 MHz)	NM
Band 41 (2496.0 – 2690.0 MHz)		0.51	P
Band 48 (3550.0 – 3700.0 MHz)		0.60	P
5G NR FR1 FDD	Band 2 (1850.0 – 1910.0 MHz)	0.25	P
	Band 5 (824.0 – 849.0 MHz)	0.38	P
	Band 7 (2500.0 – 2570.0 MHz)	0.68	P
	Band 25 (1850.0 – 1915.0 MHz)	0.48	P
	Band 30 (2305.0 – 2315.0 MHz)	0.91	P
	Band 66 (1710.0 – 1780.0 MHz)	0.63	P
5G NR FR1 TDD	Band 38 (2570.0 – 2620.0 MHz)	0.08	P
	Band 41 (2496.0 – 2690.0 MHz)	0.09	P
	Band 77 (3700.0 – 3980.0 MHz)	0.14	P
	Band 78 (3700.0 – 3800.0 MHz)	0.17	P

P: Pass

F: Fail

NM: Not Measured

NA: Not Applicable

According to the FCC OET KDB 690783 D01, this is the summary of the values for the Grant Listing:

Highest Reported SAR (1g) (W/kg)				
Exposure Condition	Equipment Class			
	PCE	DTS	DSS	U-NII
Body Worn	1.43	0.67	0.40	0.88
Simultaneous Tx	Sum-SAR: 3.39 SPLSR: 0.02	Sum-SAR: 2.73 SPLSR: 0.01	Sum-SAR: 3.39 SPLSR: 0.02	Sum-SAR: 3.39 SPLSR: 0.02

Considering the results of the performed test according to FCC 47CFR Part 2.1093 & ISED RSS 102, Issue 5 the item under test is IN COMPLIANCE with the requested specifications specified in Section1. Standards, reference documents and applicable test methods

8. Document Revision History

Revision #	Modified by	Revision Details
Rev.00	E. Garcia	First Issue
Rev.01	E. Garcia	Corrected antenna host platform location in docking mode, section E.3 Corrected Calibration date for CMW500, section A.5.3
Rev.02	E. Garcia	NFC module added on Section 5, A.4.7 and Annex F

Annex A. Test & System Description

A.1 SAR Definition

Specific Absorption rate is defined as the time derivative of the incremental energy (dW) absorbed by (dissipated in) and incremental mass (dm) contained in a volume element (dV) of a given density (ρ).

$$SAR = \frac{d}{dt} \cdot \left(\frac{dW}{dm} \right) = \frac{d}{dt} \cdot \left(\frac{dW}{\rho \cdot dV} \right)$$

SAR is expressed in units of watts per kilogram (W/kg). SAR can be related to the electric field at a point by

$$SAR = \frac{\sigma |E|^2}{\rho}$$

Where:

- σ = Conductivity of the tissue (S/m)
- ρ = Mass density of the tissue (kg/m³)
- E = RMS electric field strength (V/m)

A.2 SAR Measurement System

A.2.1 SAR Measurement Setup

The DASY6 system for performing compliance tests consists of the following items:

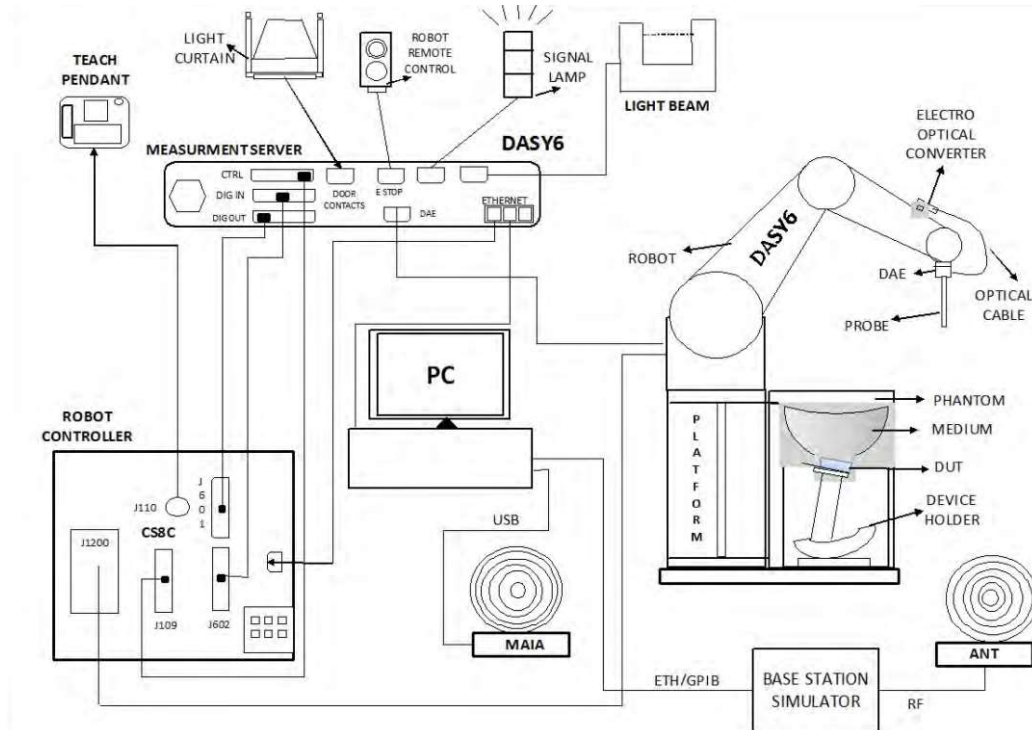

- ✓ A standard high precision 6-axis robot (Stäubli TX/RX family) with controller, teach pendant and software. It includes an arm extension for accommodating the data acquisition electronics (DAE)
- ✓ An isotropic field probe optimized and calibrated for the targeted measurements.
- ✓ A data acquisition electronics (DAE) which performs the signal amplification, signal multiplexing, AD-conversion, offset measurements, mechanical surface detection, collision detection, etc. The unit is battery powered with standard or rechargeable batteries. The signal is optically transmitted to the EOC.
- ✓ The Electro-optical Converter (EOC) performs the conversion from optical to electrical signals for the digital communication to the DAE. The EOC signal is transmitted to the measurement server.
- ✓ The function of the measurement server is to perform the time critical tasks such as signal filtering, control of the robot operation and fast movements interrupts.
- ✓ The Light Beam used is for probe alignment. This improves the (absolute) accuracy of the probe positioning.
- ✓ A computer running Win7 professional operating system and the DASY6 software.
- ✓ Remote control and teach pendant as well as additional circuitry for robot safety such as warning lamps, etc.
- ✓ The phantom, the device holder and other accessories according to the targeted measurement.
- ✓ MAIA is a hardware interface (Antenna) used to evaluate the modulation and audio interference characteristics of RF signals.
- ✓ ANT is an ultra-wideband antenna for use with the base station simulators over 698 MHz to 6GHz.
- ✓ The base station simulator is an equipment used for SAR cellular tests in order to emulate the cellular signals characteristics and behavior between a regular base station and the equipment under test.
- ✓ Tissue simulating liquid.
- ✓ System Validation dipoles.
- ✓ Network emulator.

A.2.2 E-Field Measurement Probe

The probe is constructed using three orthogonal dipole sensors arranged on an interlocking, triangular prism core. The probe has built-in shielding against static charges and is contained within a PEEK cylindrical enclosure material at the tip.



The probe's characteristics are:

Frequency Range	30MHz – 6GHz
Length	337 mm
Probe tip external diameter	2.5 mm
Typical distance between dipoles and the probe tip	1 mm
Axial Isotropy (in human-equivalent liquids)	±0.3 dB
Hemispherical Isotropy (in human-equivalent liquids)	±0.5 dB
Linearity	±0.2 dB
Maximum operating SAR	100 W/kg
Lower SAR detection threshold	0.001 W/kg

A.2.3 Flat Phantom

Phantom for compliance testing of handheld and body-mounted wireless devices in the frequency range of 30 MHz to 6 GHz. ELI is fully compatible with the IEC 62209-2 standard and all known tissue simulating liquids. ELI has been optimized regarding its performance and can be integrated into our standard phantom tables. A cover prevents evaporation of the liquid. Reference markings on the phantom allow installation of the complete setup, including all predefined phantom positions and measurement grids, by teaching three points. The phantom is compatible with all SPEAG dosimetric probes and dipoles.

The phantom's characteristics are:

Material	Vinylester, glass fiber reinforced (VE-GF)
Shell thickness	2 mm ± 0.2 mm
Filling volume	30 Liters approx.
Dimensions	Major axis: 600mm / Minor axis: 400mm

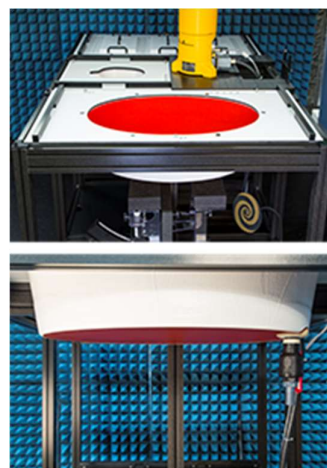

A.2.4 Device Positioner

The SAR in the phantom is approximately inversely proportional to the square of the distance between the source and the liquid surface. For a source at 5 mm distance, a positioning uncertainty of 0.5 mm would produce a SAR uncertainty of 20%. Accurate device positioning is therefore crucial for accurate and repeatable measurements. The positions in which the devices must be measured are defined by the standards.



The DASY device holder is designed to cope with the different positions given in the standard. It has two scales for device rotation (with respect to the body axis) and device inclination (with respect to the line between the ear reference points). The rotation center for both scales is the ear reference point (ERP). Thus the device needs no repositioning when changing the angles.

The DASY device holder is constructed of low-loss POM material having the following dielectric parameters: relative permittivity $\epsilon=3$ and loss tangent $\delta=0.02$. The amount of dielectric material has been reduced in the closest vicinity of the device, since measurements have suggested that the influence of the clamp on the test results could thus be lowered.

A simple but effective and easy-to-use extension for the Mounting Device; facilitates testing of larger devices according to IEC 62209-2 (e.g., laptops, cameras, etc.); lightweight and fits easily on the upper part of the Mounting Device in place of the phone positioner. The extension is fully compatible with the Twin SAM, ELI and other Flat Phantoms.



A.3 Data Evaluation

Power Reference measurement

The robot measures the E field in a specified reference position that can be either the selected section's grid reference point or a user point in this section at 4mm of the inner surface of the phantom, 2mm for frequencies above 3GHz.

Area Scan

Measurement procedures for evaluating SAR from wireless handsets typically start with a coarse measurement grid to determine the approximate location of the local peak SAR values. This is known as the area-scan procedure. The SAR distribution is scanned along the inside surface of one side of the phantom head, at least for an area larger than the projection of the handset and antenna. The distance between the measured points and phantom surface should be less than 8 mm, and should remain constant (with variation less than ± 1 mm) during the entire scan in order to determine the locations of the local peak SAR with sufficient accuracy. The angle between the probe axis and the surface normal line is recommended but not required to be less than 30° . If this angle is larger than 30° and the closest point on the probe-tip housing to the phantom surface is closer than a probe diameter, the boundary effect may become larger and polarization dependent. This additional uncertainty needs to be analyzed and accounted for. To achieve this, modified test procedures and additional uncertainty analyses not described in this recommended practice may be required. The measurement and interpolation point spacing should be chosen such as to allow identification of the local peak locations to within one-half of the linear dimension of a side of the zoom-scan volume. Because a local peak having specific amplitude and steep gradients may produce a lower peak spatial-average SAR compared to peaks with slightly lower amplitude and less steep gradients, it is necessary to evaluate these other peaks as well. However, since the spatial gradients of local SAR peaks are a function of the wavelength inside the tissue-equivalent liquid and the incident magnetic field strength, it is not necessary to evaluate local peaks that are less than 2 dB or more below the global maximum peak. Two-dimensional spline algorithms (Brishoual et al. 2001; Press et al., 1996) are typically used to determine the peaks and gradients within the scanned area. If a peak is found at a distance from the scan border of less than one-half the edge dimension of the desired 1 g or 10 g cube, the measurement area should be enlarged if possible.

Zoom Scan

To evaluate the peak spatial-average SAR values for 1 g or 10 g cubes, fine resolution volume scans, called zoom scans, are performed at the peak SAR locations identified during the area scan. The minimum zoom scan volume size should extend at least 1.5 times the edge dimension of a 1 g cube in all directions from the center of the scan volume, for both 1 g and 10 g peak spatial-average SAR evaluations. Along the phantom curved surfaces, the front face of the volume facing the tissue/liquid interface conforms to the curved boundary, to ensure that all SAR peaks are captured. The back face should be equally distorted to maintain the correct averaging mass. The flatness and orientation of the four side faces are unchanged from that of a cube whose orientation is within $\pm 30^\circ$ of the line normal to the phantom at the center of the cube face next to the phantom surface. The peak local SAR locations that were determined in the area scan (interpolated values) should be used for the centers of the zoom scans. If a scan volume cannot be centered due to proximity of a phantom shape feature, the probe should be tilted to allow scan volume enlargement. If probe tilt is not feasible, the zoom-scan origin may be shifted, but not by more than half of the 1 g or 10 g cube edge dimension.

After the zoom-scan measurement, extrapolations from the closest measured points to the surface, for example along lines parallel to the zoom-scan centerline, and interpolations to a finer resolution between all measured and extrapolated points are performed. Extrapolation algorithm considerations are described in 6.5.3, and 3-D spline methods (Brishoual et al., 2001; Kreyszig, 1983; Press et al., 1996) can be used for interpolation. The peak spatial-average SAR is finally determined by a numerical averaging of the local SAR values in the interpolation grid, using for example a trapezoidal algorithm for the integration (averaging).

In some areas of the phantom, such as the jaw and upper head regions, the angle of the probe with respect to the line normal to the surface may be relatively large, e.g., greater than $\pm 30^\circ$, which could increase the boundary effect error to a larger level. In these cases, during the zoom scan a change in the orientation of the probe, the phantom, or both is recommended but not required for the duration of the zoom scan, so that the angle between the probe axis and the line normal to the surface is within 30° for all measurement points.

Power Drift measurement

The robot re-measures the E-Field in the same reference location measured at the Power Reference. The drift measurement gives the field difference in dB from the first to the last reference reading. This allows a user to monitor the power drift of the device under test that must remain within a maximum variation of $\pm 5\%$.

Post-processing

The procedure for spatial peak SAR evaluation has been implemented according to the IEEE1528 and IEC 62209-1/2 standards. It can be conducted for 1g and 10g.

The software allows evaluations that combine measured data and robot positions, such as:

- ✓ Maximum search
- ✓ Extrapolation
- ✓ Boundary correction
- ✓ Peak search for averaged SAR

Interpolation between the measured points is performed when the resolution of the grid is not fine enough to compute the average SAR over a given mass.

Extrapolation routines are used to obtain SAR values between the lowest measurement points and the inner phantom surface. The extrapolation is determined by the surface detection distance and the probe sensor offset. Several measurements at different distances are necessary for the extrapolation.

A.4 System and Liquid Check

A.4.1 System Check

The system performance check verifies that the system operates within its specifications. System and operator errors can be detected and corrected. It is recommended that the system performance check be performed prior to any usage of the system in order to guarantee reproducible results.

The system performance check uses normal SAR measurements in a simplified setup with a well characterized source. This setup was selected to give a high sensitivity to all parameters that might fail or vary over time. The system check does not intend to replace the calibration of the components, but indicates situations where the system uncertainty is exceeded due to drift or failure.

In the simplified setup for system check, the EUT is replaced by a calibrated dipole and the power source is replaced by a controlled continuous wave generated by a signal generator. The calibrated dipole must be placed beneath the flat phantom section of the phantom at the correct distance.

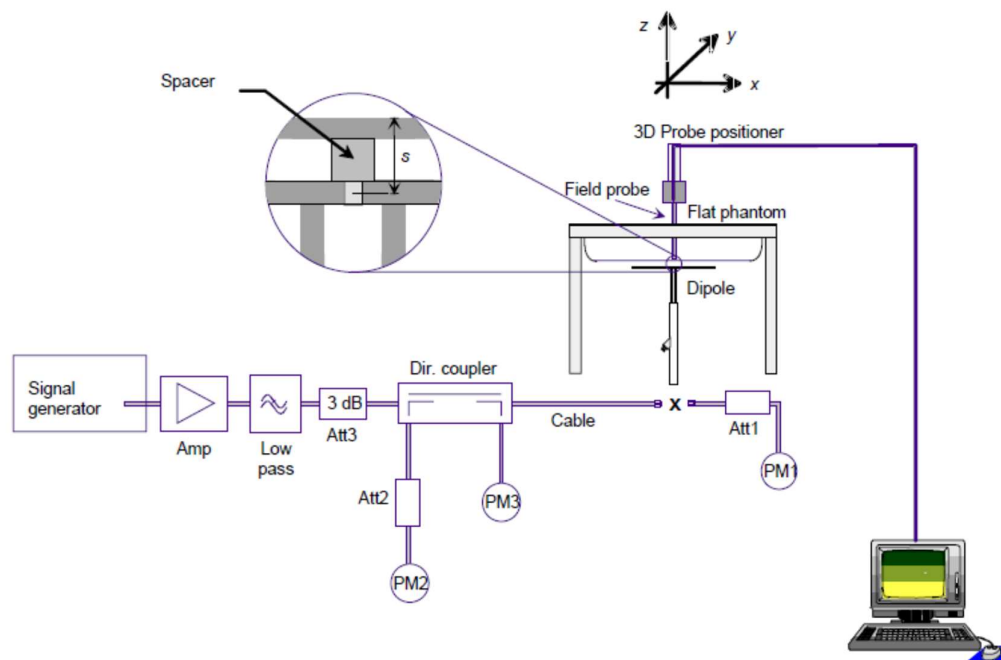

The equipment setup is shown below:

- ✓ Signal Generator
- ✓ Amplifier
- ✓ Directional coupler
- ✓ Power meter
- ✓ Calibrated dipole

First, the power meter PM1 (including attenuator Att1) is connected to the cable to measure the forward power at the location of the connector (x) to the system check source. The signal generator is adjusted for the desired forward power at the connector as read by power meter PM1 after attenuation Att1 and also as coupled through Att2 to PM2. After connecting the cable to the source, the signal generator is readjusted for the same reading at power meter PM2.

SAR results are normalized to a forward power of 1W to compare the values with the calibration reports results as described at IEEE 1528 and IEC 62209 standards.

A.4.2 Liquid Check

The dielectric parameters check is done prior to the use of the tissue simulating liquid. The verification is made by comparing the relative permittivity and conductivity to the values recommended by the applicable standards.

The liquid verification was performed using the following test setup:

- ✓ VNA (Vector Network Analyzer)
- ✓ Open-Short-Load calibration kit
- ✓ RF Cable
- ✓ Open-Ended Coaxial probe
- ✓ DAK software tool
- ✓ SAR Liquid
- ✓ De-ionized water
- ✓ Thermometer

These are the target dielectric properties of the tissue-equivalent liquid material as defined in FCC OET KDB 865664 D01.

Frequency (MHz)	Body SAR	
	ϵ_r (F/m)	σ (S/m)
150	61.9	0.80
300	58.2	0.92
450	56.7	0.94
835	55.2	0.97
900	55.0	1.05
1450	54.0	1.30
1800-2000	53.3	1.52
2450	52.7	1.95
3000	52.0	2.73
5800	48.2	6.00

(ϵ_r = relative permittivity, σ = conductivity and ρ = 1000 kg/m³)

The measurement system implement a SAR error compensation algorithm as documented in IEEE Std 1528-2013 (equivalent to draft standard IEEE P1528-2011) to automatically compensate the measured SAR results for deviations between the measured and required tissue dielectric parameters (applied to only scale up the measured SAR, and not downward) so, according to FCC OET KDB 865664 D01, the tolerance for ϵ_r and σ may be relaxed to $\pm 10\%$.

A.5 Test Equipment List

A.5.1 SAR System #2*

ID #	Device	Type/Model	Serial Number	Manufacturer	Cal. Date	Cal. Due Date
002-009	Dosimetric E-Field probe	EX3DV4	3978	SPEAG	2022-05-17	2023-05-17
001-017	Data Acquisition Electronics	DAE4	1703	SPEAG	2022-04-28	2023-04-28
002-000	6-axis Robot	TX60 L	F16/55FXA1/A/01	STAÜBLI	n/a	n/a
002-001	Robot Controller	CS8C	F16/55FXA1/C/01	STAÜBLI	n/a	n/a
002-002	Measurement Server	DASY6 P/N: SE UMS 028 BB	1489	SPEAG	n/a	n/a
002-003	Electro-Optical Converter	EOC60	1098	SPEAG	n/a	n/a
002-004	Light Beam Unit	SE UKS 030 AA	-	Di-soric	n/a	n/a
002-005	Oval Flat Phantom	ELI v8.0	2048	SPEAG	n/a	n/a
002-007	Measurement SW	DASY v6.14	9-5DEE27C2	SPEAG	n/a	n/a
002-006	Laptop Holder	P/N SM LH1 001 CD	-	SPEAG	n/a	n/a

*Used for LTE tests

A.5.2 SAR System #3**

ID #	Device	Type/Model	Serial Number	Manufacturer	Cal. Date	Cal. Due Date
003-000	6-Axis Robot	TX60L speag	F17/59RCB1/A/01	STAÜBLI	NA	NA
003-001	Robot Controller	CS8C	F17/59RCB1/C/01	STAÜBLI	NA	NA
003-002	Oval Flat Phantom	ELI V5.0	1260	SPEAG	NA	NA
003-003	Light Beam Unit	SE UKS 030 AA	1170	Di-soric	NA	NA
003-004	Measurement Server	DASY6	1547	SPEAG	NA	NA
003-005	Electro Optical Converter	EOC60	1104	SPEAG	NA	NA
003-006	Measurement Software	DASY6 V16.0.0.116	9-5ED1AC01	SPEAG	NA	NA
085-000	Dosimetric E-Field probe	EX3DV4	1517	SPEAG	2022-03-17	2023-03-17
086-000	Data Acquisition Electronics	DAE4	7455	SPEAG	2022-03-21	2023-03-21
003-009	Laptop Holder	N/A	N/A	SPEAG	NA	NA
458-000	Automation SW	SARA v2.3	-	Intel	n/a	n/a

**Used 5G NR tests

A.5.3 Shared Instrumentation

ID #	Device	Type/Model	Serial Number	Manufacturer	Cal. Date	Cal. Due Date
123-000	USB Power Sensor	NRP-Z81	102278	R&S	2021-04-13	2023-04-13
124-000	USB Power Sensor	NRP-Z81	102279	R&S	2021-04-13	2023-04-13
135-000	Network Emulator	CMW500	152721	R&S	2022-03-29	2024-03-29
023-000	5G Network Emulator	CMX500	101444	R&S	NA	NA
126-000	Vector Signal Generator	ESG E4438C	MY45092885	Agilent	2021-05-27	2023-05-27
099-000	Liquid measurement SW	DAK-3.5 V2.6.0.5	9-2687B491	SPEAG	n/a	n/a
089-000	Vector Reflectometer	R140 1-Port 14 GHz Analyzer	0190616	Copper Mountain tech	2021-09-02	2023-09-02
071-000	750 MHz System Validation Dipole	D750V3	1136	SPEAG	2021-01-21	2023-01-21
072-000	835 MHz System Validation Dipole	D835V2	4d192	SPEAG	2021-01-21	2023-01-21
073-000	1750 MHz System Validation Dipole	D1750V2	1133	SPEAG	2021-01-14	2023-01-14
074-000	1900 MHz System Validation Dipole	D1900V2	5d197	SPEAG	2021-01-14	2023-01-14
075-000	2300 MHz System Validation Dipole	D2300V2	1046	SPEAG	2021-01-13	2023-01-13
076-000	2600 MHz System Validation Dipole	D2600V2	1100	SPEAG	2021-01-13	2023-01-13
404-000	3700 MHz System Validation Dipole	D3700V2	1093	SPEAG	2021-05-21	2023-05-21
327-000	Temperature & Humidity Logger	RA32E-TH1-RAS	RA32-F0DED9	AVTECH	2021-03-09	2023-03-09
398-000	Thermometer	922	33622932/208	Testo	2021-11-09	2023-11-19
198-000	0.8-21GHz RF amplifier	TVA-82-213A	2004003	Mini-Circuits	2022-02-01	2023-01-26
078-000	RF Cable	ST-18/SMAm/SMAm/48	1158830	Huber & Suhner	2022-02-01	2023-01-26
079-000	RF Cable	ST-18/SMAm/SMAm/48	1158831	Huber & Suhner	2022-02-01	2023-01-26
077-000	Coupler	CD0.5-8-20-30	1251-002	Amd-group	2022-02-01	2023-01-26

A.5.4 Tissue Simulant Liquid

TSL	Manufacturer / Model	Freq Range (MHz)	Main Ingredients	Note
Body WideBand System2	SPEAG MBBL600-6000V6 Batch 191014-02	600-6000	Ethenediol, Sodium petroleum sulfonate, Hexylene Glycol / 2-Methyl-pentane-2.4-diol, Alkoxylated alcohol	Used for WCDMA and LTE tests
Body WideBand System 3	SPEAG MBBL600-6000V6 Batch 220309-1	600-6000	Ethenediol, Sodium petroleum sulfonate, Hexylene Glycol / 2-Methyl-pentane-2.4-diol, Alkoxylated alcohol	Used for 5G NR tests

A.6 Measurement Uncertainty Evaluation

The system uncertainty evaluation is shown in the table below with a coverage factor of $k = 2$ to indicate a 95% level of confidence:

SPEAG DASY6 Uncertainty Budget According to IEC/IEEE 62209-1528 (4 MHz - 6 GHz) including IEEE 1528-2013 and IEC 62209-1/2016, IEC 62209-2/2010								
Symbol	Error Description	Uncert. Value	Prob. Dist.	Div.	(ci) 1g	(ci) 10g	Std Unc. (1g)	Std Unc. (10g)
Measurement System Errors								
CF	<i>Probe Calibration</i>	±14.0 %	N	2	1	1	±7.0 %	±7.0 %
CF _{drift}	Probe Calibration Drift	±1.0 %	N	1	1	1	±1.0 %	±1.0 %
LIN	Probe Linearity	±4.7 %	R	√3	1	1	±2.7 %	±2.7 %
BBS	Broadband Signal	±3.0 %	N	2	1	1	±1.5 %	±1.5 %
ISO	<i>Axial Isotropy</i>	±4.7 %	R	√3	0.5	0.5	±1.4 %	±1.4 %
ISO	Hemispherical Isotropy	±9.6 %	R	√3	0.5	0.5	±2.8 %	±2.8 %
DAE	Data Acquisition	±0.3 %	N	1	1	1	±0.3 %	±0.3 %
AMB	RF Ambient	±1.8 %	N	1	1	1	±1.8 %	±1.8 %
Δ _{sys}	Probe Positioning	±0.2 %	N	1	0.33	0.33	±0.1 %	±0.1 %
DAT	Data Processing	±2.3 %	N	1	1	1	±2.3 %	±2.3 %
Phantom and Device Errors								
LIQ(σ)	Conductivity (meas.) _{DAK}	±2.5 %	N	1	0.78	0.71	±2.0 %	±1.8 %
LIQ(Tσ)	Conductivity (temp.) _{BB}	±3.4 %	R	√3	0.78	0.71	±1.5 %	±1.4 %
EPS	Phantom Permittivity	±14.0 %	R	√3	0.25	0.25	±2.0 %	±2.0 %
DAS	Distance DUT - TSL	±2.0 %	N	1	2	2	±4.0 %	±4.0 %
H	Device Holder	±3.6 %	N	1	1	1	±3.6 %	±3.6 %
MOD	DUT Modulation _m	±2.4 %	R	√3	1	1	±1.4 %	±1.4 %
TAS	Time-average SAR	±2.6 %	R	√3	1	1	±1.5 %	±1.5 %
RF _{drift}	DUT drift	±5.0 %	N	1	1	1	±2.9 %	±2.9 %
Correction to the SAR results								
C(ε, σ)	Deviation to Target	±1.9 %	N	1	1	0.84	±1.9 %	±1.6 %
Combined Std. Uncertainty							±11.5 %	±11.4 %
Expanded STD Uncertainty							±23.1 %	±22.9 %

A.7 RF Exposure Limits

SAR assessments have been made in line with the requirements of FCC 47 CFR Part 2.1093 & ISED RSS 102 issue on the limitation of exposure of the general population / uncontrolled exposure for portable devices.

Exposure Type	General Population / Uncontrolled Environment
Peak spatial-average SAR (averaged over any 1 gram of tissue)	1.6 W/kg
Whole body average SAR	0.08 W/kg
Peak spatial-average SAR (extremities) (averaged over any 10 grams of tissue)	4.0 W/kg

Annex B. Test Results

The herein test results were performed by:

Test case measurement	Test Personnel
SAR measurement	E. Garcia, Y.Haddad
Conducted measurement	F. Heurtematte

B.1 Test Conditions

B.1.1 Test SAR Test positions relative to the phantom

The device under test was a Tablet, **FM350-GL**. The device was operated utilizing proprietary software, and each channel was measured using a communication tester to determine the maximum average power.

The device has 2 power settings:

- Docking mode
- Tablet mode

See section 5 for details about power values for the configuration

See Annex E.3 for information about the platform antenna configuration

Docking mode

As described below on section B.1.4, docking position does not require SAR testing.

Notebook	WWAN Ant 5	WWAN Ant 8
Position	Docking	Docking

Tablet mode

According to FCC OET KDB 616217 D04, the back surface and edges of the tablet should be tested for SAR compliance with the tablet touching the phantom. The SAR Test Exclusion Threshold in FCC OET KDB 447498 can be applied to determine SAR test exclusion for adjacent edge configurations. (See section 5 for power specifications)

The reduced power values shown on section 5 and the closest distance from the antenna to an adjacent tablet edge is used to determine if SAR testing is required for the adjacent edges, with the adjacent edge positioned against the phantom and the edge containing the antenna positioned perpendicular to the phantom.

Considering the antenna location diagrams in Annex E and the test exclusions described before, the surfaces/edges to be measured for each antenna are:

Tablet	WWAN Ant 5	WWAN Ant 8
Position	Top Edge Back Face Right Edge	Top Edge Back Face

See B.1.4 for a more detailed list of the applied reductions.

See E.2 Test position section for more information on the tested positions.

B.1.2 Test signal, Output power and Test Frequencies

B.1.1.1 LTE TDD consideration

According to KDB 941225 D05 SAR for LTE Devices, for Time-Division Duplex (TDD) systems, SAR must be tested using a fixed periodic duty factor according to the highest transmission duty factor implemented for the device and supported by the defined 3GPP LTE TDD configurations.

LTE TDD Bands support 3GPP TS 36.211 section 4.2 for Type 2 Frame structure and table 2 for uplink-downlink configurations and table 1 for special subframe configurations

Table 1

Special subframe configuration	Normal cyclic prefix in downlink			Extended cyclic prefix in downlink		
	DwPTS	UpPTS		DwPTS	UpPTS	
		Normal cyclic prefix in uplink	Extended cyclic prefix in uplink		Normal cyclic prefix in uplink	Extended cyclic prefix in uplink
0	6592 T _s	(1+X) 2192 T _s	(1+X) 2560 T _s	7680 · T _s	(1+X) 2192 T _s	(1+X) 2560 T _s
1	19760 T _s			20480 T _s		
2	21952 T _s			23040 T _s		
3	24144 T _s			25600 T _s		
4	26336 T _s			7680 T _s		
5	6592 T _s	(2+X) 2192 T _s	(2+X) 2560 T _s	20480 T _s	(2+X) 2192 T _s	(2+X) 2560 T _s
6	19760 T _s			23040 T _s		
7	21952 T _s			12800 T _s		
8	24144 T _s			-		
9	13168 T _s			-		
10	13168 T _s	13150 T _s	12800 T _s	-	-	-

Table2

Uplink-Downlink Config.	Downlink-to-Uplink Switch-point Periodicity	Subframe Number										Calculated Duty Cycle (%)
		0	1	2	3	4	5	6	7	8	9	
0	5 ms	D	S	U	U	U	D	S	U	U	U	63.3%
1	5 ms	D	S	U	U	D	D	S	U	U	D	43.3%
2	5 ms	D	S	U	D	D	D	S	U	D	D	23.3%
3	10 ms	D	S	U	U	U	D	D	D	D	D	31.7%
4	10 ms	D	S	U	U	D	D	D	D	D	D	21.7%
5	10 ms	D	S	U	D	D	D	D	D	D	D	11.7%
6	5 ms	D	S	U	U	U	D	S	U	U	D	53.3%

Calculated duty cycle = Extended cyclic prefix in uplink *(TS)# of S + # of U / period
 The configuration used for SAR testing was the number 0 which corresponds to the highest duty cycle (Power Class 3)

Frame structure and maximal measured duty cycle (91%) for NR 5G FR1 are described in the table 3.

B.1.3 5G NR TDD consideration

Table3

Subframe Number																													
Radio Frame 0																													
SF0	SF1			SF2			SF3			SF4			SF5			SF6			SF7			SF8			SF9				
0	1	2	3	4	5	6	7	8	9	0	1	2	3	4	5	6	7	8	9	0	1	2	3	4	5	6	7	8	9
D	s	U	U	S	U	S	U	S	U	S	U	S	U	S	U	S	U	S	U	S	U	S	U	S	U	S	U	S	U
Radio Frame 1-2																													
SF0	SF1			SF2			SF3			SF4			SF5			SF6			SF7			SF8			SF9				
0	1	2	3	4	5	6	7	8	9	0	1	2	3	4	5	6	7	8	9	0	1	2	3	4	5	6	7	8	9
S	U	S	U	S	U	S	U	S	U	S	U	S	U	S	U	S	U	S	U	S	U	S	U	S	U	S	U	S	U
Radio Frame 3																													
SF0	SF1			SF2			SF3			SF4			SF5			SF6			SF7			SF8			SF9				
0	1	2	3	4	5	6	7	8	9	0	1	2	3	4	5	6	7	8	9	0	1	2	3	4	5	6	7	8	9
S	U	S	U	S	U	S	U	S	U	S	U	S	U	S	U	S	U	S	U	S	U	S	U	S	U	S	U	S	U

“D”: Full DL slot, “s”: partial slot, “S”: partial slot for PUSCH, “U”: full UL slot

B.1.4 Evaluation Exclusion and Test Reductions

(i) SAR evaluation exclusion

The SAR Test Exclusion Threshold in FCC OET KDB 447498 can be applied to determine SAR test exclusion for adjacent edge configurations. For 100MHz to 6GHz and test separation distances ≤ 50 mm, the 1-g and 10-g SAR test exclusion thresholds are determined by the following formula:

$$\left[\frac{\text{(max. power of channel, including tune – up tolerance, mW)}}{\text{(min. test separation distance, mm)}} \right] \cdot \left[\sqrt{f_{\text{(GHz)}}} \right] \leq 3.0 \text{ for } 1g \text{ SAR, and } \leq 7.5 \text{ for } 10g \text{ extremity SAR} \quad (1)$$

Where:

- f(GHz) is the RF channel transmit frequency in GHz
- Power and distance are rounded to the nearest mW and mm before calculation
- The result is rounded to one decimal place for comparison
- The values 3.0 and 7.5 are referred to as numeric thresholds

The test exclusions are applicable only when the minimum test separation distance is ≤ 50 mm, and for transmission frequencies between 100 MHz and 6 GHz. When the minimum test separation distance is < 5 mm, a distance of 5 mm is applied to determine SAR test exclusion.

For test separation distances > 50 mm, the 1-g and 10-g SAR test exclusion thresholds are determined using the following formulas:

$$\left(\left(\text{Power allowed at numeric threshold for } 50 \text{ mm in (1)} \right) + (\text{test separation distance} - 50 \text{ mm}) \cdot (f_{\text{MHz}}/150) \right) \text{mW,} \quad (2)$$

for 100MHz to 1500MHz

$$\left(\left(\text{Power allowed at numeric threshold for } 50 \text{ mm in (1)} \right) + (\text{test separation distance} - 50 \text{ mm}) \cdot 10 \right) \text{mW,} \quad (3)$$

for 1500MHz and ≤ 6 GHz

Test Exclusion

Antenna	Band Name	Output power				Back Face	Top Edge	Left Edge	Right Edge	Bottom Edge	Docking	Back Face	Top Edge	Left Edge	Right Edge	Bottom Edge	Docking
		Docking		Tablet													
		dBm	mW	dBm	mW												
WWAN Ant 5	UTRA II	24.5	281.8	16.0	39.8	<50	>50	>50	<50	>50	>50	T	T	R	R	R	R
	UTRAIV	24.5	281.8	16.0	39.8	<50	>50	>50	<50	>50	>50	T	T	R	R	R	R
	UTRA V	24.5	281.8	20.0	100	<50	<50	>50	<50	>50	>50	T	T	R	R	R	R
	LTE 2	24.0	251.2	17.5	56.2	<50	<50	>50	<50	>50	>50	R	R	R	R	R	R
	LTE 4	24.0	251.2	20.0	100	<50	<50	>50	<50	>50	>50	R	R	R	R	R	R
	LTE 5	25.0	316.2	17.0	50.1	<50	<50	>50	<50	>50	>50	R	R	R	R	R	R
	LTE 7	24.0	251.2	18.0	63.1	<50	<50	>50	<50	>50	>50	T	T	R	R	R	R
	LTE 12	24.0	251.2	20.0	100	<50	<50	>50	<50	>50	>50	T	T	R	R	R	R
	LTE 13	24.0	251.2	19.0	79.4	<50	<50	>50	<50	>50	>50	T	T	R	R	R	R
	LTE 14	24.0	251.2	18.5	70.8	<50	<50	>50	<50	>50	>50	T	T	R	R	R	R
	LTE 17	24.0	251.2	20.0	100	<50	<50	>50	<50	>50	>50	R	R	R	R	R	R
	LTE 25	24.0	251.2	17.5	56.2	<50	<50	>50	<50	>50	>50	T	T	R	R	R	R
	LTE 26	25.0	316.2	17.0	50.1	<50	<50	>50	<50	>50	>50	T	T	R	R	R	R
	LTE 30	24.0	251.2	17.0	50.1	<50	<50	>50	<50	>50	>50	T	T	R	R	R	R
	LTE 38	24.0	251.2	18.5	70.8	<50	<50	>50	<50	>50	>50	R	R	R	R	R	R
	LTE 41	24.0	251.2	19.5	89.1	<50	<50	>50	<50	>50	>50	T	T	R	T	R	R
	LTE 66	24.0	251.2	20.0	100	<50	<50	>50	<50	>50	>50	T	T	R	T	R	R
	NR 2	24.0	251.2	17.5	56.2	<50	<50	>50	<50	>50	>50	T	T	R	R	R	R
	NR 5	24.0	251.2	17.0	50.1	<50	<50	>50	<50	>50	>50	T	T	R	R	R	R
	NR 7	24.0	251.2	18.0	63.1	<50	<50	>50	<50	>50	>50	T	T	R	R	R	R
NR 25	24.0	251.2	17.5	56.2	<50	<50	>50	<50	>50	>50	T	T	R	R	R	R	
NR 30	24.0	251.2	17.0	50.1	<50	<50	>50	<50	>50	>50	T	T	R	R	R	R	
NR 38	24.0	251.2	18.5	70.8	<50	<50	>50	<50	>50	>50	R	R	R	R	R	R	
NR 41	24.0	251.2	19.5	89.1	<50	<50	>50	<50	>50	>50	T	T	R	T	R	R	
NR 66	24.0	251.2	20.0	100	<50	<50	>50	<50	>50	>50	T	T	R	T	R	R	
NR 77	24.0	251.2	15.5	35.5	<50	<50	>50	<50	>50	>50	T	T	R	R	R	R	
NR 78	24.0	251.2	16.0	39.8	<50	<50	>50	<50	>50	>50	T	T	R	R	R	R	

T: Tested position
R: Reduced

See Annex E for a more detailed explanation of the separation distance related to the platform.

Antenna	Band Name	Output power				Back Face	Top Edge	Left Edge	Right Edge	Bottom Edge	Docking
		Docking		Tablet							
		dBm	mW	dBm	mW						
WWAN Ant 8	LTE 2	24.0	251.2	16.0	39.8	<50	<50	>50	>50	>50	>50
	LTE 4	24.0	251.2	16.0	39.8	<50	<50	>50	>50	>50	>50
	LTE 7	24.0	251.2	18.0	63.1	<50	<50	>50	>50	>50	>50
	LTE 25	24.0	251.2	16.0	39.8	<50	<50	>50	>50	>50	>50
	LTE 30	24.0	251.2	17.5	56.2	<50	<50	>50	>50	>50	>50
	LTE 41	24.0	251.2	17.5	56.2	<50	<50	>50	>50	>50	>50
	LTE 48	22.0	158.5	13.5	22.4	<50	<50	>50	>50	>50	>50
	LTE 66	22.0	158.5	16.0	39.8	<50	<50	>50	>50	>50	>50
	NR 2*	24.0	251.2	16.0	39.8	<50	<50	>50	>50	>50	>50
	NR 38	24.0	251.2	18.0	63.1	<50	<50	>50	>50	>50	>50
	NR 41	24.0	251.2	17.5	56.2	<50	<50	>50	>50	>50	>50
	NR 66	24.0	251.2	16.0	39.8	<50	<50	>50	>50	>50	>50
	NR 77	24.0	251.2	14.0	25.1	<50	<50	>50	>50	>50	>50
NR 78	24.0	251.2	13.5	22.4	<50	<50	>50	>50	>50	>50	

Back Face	Top Edge	Left Edge	Right Edge	Bottom Edge	Docking
R	R	R	R	R	R
R	R	R	R	R	R
T	T	R	R	R	R
T	T	R	R	R	R
T	T	R	R	R	R
T	T	R	R	R	R
T	T	R	R	R	R
T	T	R	R	R	R
T	T	R	R	R	R
T	T	R	R	R	R
T	T	R	R	R	R
T	T	R	R	R	R
T	T	R	R	R	R

T: Tested position
 R: Reduced
 See Annex E for a more detailed explanation of the separation distance related to the platform.
 *ENDC mode only

In order to evaluate SAR test exclusion for docking and tablet user positions in which the separation distance passes the 50mm limit, equations (2) and (3) are used with the corresponding frequencies for each band, the user distances for the two positions and with the power values described on Section 5. The table below shows all cellular bands evaluated in this report grouped by frequency band, separation distances and the corresponding Power threshold in mW for each combination (distance and frequency)

Bands	Frequency	Separation distance to the body on mm										Threshold values in mW
		60	70	80	90	100	110	160	170	190	200	
LTE 12,13, 14, 17	750	223	273	323	373	423	473	723	773	873	923	
FDD V LTE 5, 26 NR 5	835	220	275	331	387	442	498	776	832	943	999	
FDD IV LTE 4, 66 NR 66	1750	213	313	413	513	613	713	1213	1313	1513	1613	
FDD II LTE 2, 25 NR 2, 25	1900	209	309	409	509	609	709	1209	1309	1509	1609	
LTE 30 NR 30	2300	199	299	399	499	599	699	1199	1299	1499	1599	
LTE 7, 38, 41 NR 7, 38, 41	2600	193	293	393	493	593	693	1193	1293	1493	1593	
LTE 48 NR 77, 78	3700	180	280	380	480	580	680	1180	1280	1480	1580	

The highest output power for all bands is 100mW which is smaller than all the values of the table, for distances >200mm. Since the considered distance between the user body and the antenna is minimum 200mm. Refer to annex F3 for antenna position and its adjacent edges.

(ii) General SAR test reduction

According to FCC OET KDB 447498, testing of other required channels within the operating mode of a frequency band is not required when the reported 1-g or 10-g SAR for the mid-band or highest output power channel is:

- ≤ 0.8 W/kg or 2.0 W/kg, for 1-g or 10-g respectively, when the transmission band is ≤ 100 MHz
- ≤ 0.6 W/kg or 1.5 W/kg, for 1-g or 10-g respectively, when the transmission band is between 100 MHz and 200 MHz
- ≤ 0.4 W/kg or 1.0 W/kg, for 1-g or 10-g respectively, when the transmission band is ≥ 200 MHz

WWAN SAR Test reduction

Transmission Mode	SAR test exclusion/reduction
HSDPA	According to FCC OET KDB 941225 D01, SAR evaluation is not required when the maximum average output power is $< \frac{1}{4}$ dB higher than the measured on the corresponding channels without HSDPA, using 12.2kbps RMC, and the maximum SAR for 12.2kbps RMC is < 1.2 W/kg.
HSUPA	According to FCC OET KDB 941225 D01, SAR evaluation is not required when the maximum average output power is $< \frac{1}{4}$ dB higher than the measured on the corresponding channels without HSUPA, using 12.2kbps RMC, and the maximum SAR for 12.2kbps RMC is < 1.2 W/kg.
DC+HSDPA	According to FCC OET KDB 941225 D01, SAR evaluation is not required when the maximum average output power is $< \frac{1}{4}$ dB higher than the measured on the corresponding channels without DC+HSDPA, using 12.2kbps RMC, and the maximum SAR for 12.2kbps RMC is < 1.2 W/kg.
LTE	<p>According to FCC OET KDB 941225 D05, testing of 100% RB allocation, higher order modulations or lower BW is not required when these conditions are met:</p> <p>For QPSK with 100% RB allocation, SAR is not required when the highest maximum output power for 100 % RB allocation is less than the highest maximum output power in 50% and 1 RB allocations and the highest reported SAR for 1 RB and 50% RB allocation are ≤ 0.8 W/kg.</p> <p>For each modulation besides QPSK, SAR is required only when the highest maximum output power for the configuration in the higher order modulation is $> \frac{1}{2}$ dB higher than the same configuration in QPSK or when the reported SAR for the QPSK configuration is > 1.45 W/kg.</p> <p>For lower BW, only measure SAR when the highest maximum output power of a configuration requiring testing in the smaller channel bandwidth is $> \frac{1}{2}$ dB higher than the equivalent channel configurations in the largest channel bandwidth configuration or the reported SAR of a configuration for the largest channel bandwidth is > 1.45 W/kg.</p> <p>For LTE bands that do not support at least three non-overlapping channels in certain channel bandwidths, test the available non-overlapping channels instead. When a device supports overlapping channel assignment in a channel bandwidth configuration, the middle channel of the group of overlapping channels should be selected for testing; therefore, the requirement for H, M, and L channels may not fully apply</p>
5G NR	According to TCB workshop November 2019; RF Exposure Policy Updates (5G NR FR1 NSA EN-DC UE SAR Evaluations), the FCC OET KDB 941225 D05 rules apply.

B.2 Conducted Power Measurements Tablet mode

B.2.1 WCDMA / HSPA / DC-HSPA

B.2.1.1 WCDMA Band II – Antenna Ant 5

Mode	Channel Number	Freq (MHz)	Subset	Average Power Measured (dBm)	Factory Upper Tolerance (dBm)
RMC	9262	1852.4	-	15.62	16.00
	9400	1880.0	-	15.54	16.00
	9538	1907.6	-	15.51	16.00
HSDPA	9262	1852.4	1	15.53	16.00
			2	15.52	16.00
			3	15.49	16.00
			4	15.55	16.00
	9400	1880	1	15.50	16.00
			2	15.47	16.00
			3	15.09	16.00
			4	15.05	16.00
	9538	1907.6	1	15.02	16.00
			2	15.05	16.00
			3	14.99	16.00
			4	15.00	16.00
HSUPA	9262	1852.4	1	15.53	16.00
			2	15.54	16.00
			3	15.52	16.00
			4	15.50	16.00
			5	15.49	16.00
	9400	1880	1	15.47	16.00
			2	15.55	16.00
			3	15.55	16.00
			4	15.50	16.00
			5	15.51	16.00
	9538	1907.6	1	15.47	16.00
			2	15.48	16.00
			3	15.09	16.00
			4	15.11	16.00
			5	15.05	16.00
DC-HSDPA	9262	1852.4	1	15.07	16.00
			2	15.02	16.00
			3	14.99	16.00
			4	15.05	16.00
	9400	1880	1	15.05	16.00
			2	14.99	16.00
			3	15.00	16.00
			4	15.00	16.00
	9538	1907.6	1	14.97	16.00
			2	14.45	16.00
			3	14.55	16.00
			4	14.52	16.00

(i) WCDMA Band IV – Antenna Ant 5

Mode	Channel Number	Freq (MHz)	Subset	Average Power Measured (dBm)	Factory Upper Tolerance (dBm)
RMC	1312	1712.4	-	15.84	16.00
	1413	1732.6	-	15.79	16.00
	1513	1752.6	-	15.79	16.00
HSDPA	1312	1712.4	1	15.83	16.00
			2	15.77	16.00
			3	15.77	16.00
			4	15.85	16.00
	1413	1732.6	1	15.79	16.00
			2	15.76	16.00
			3	15.35	16.00
			4	15.30	16.00
	1513	1752.6	1	15.27	16.00
			2	15.33	16.00
			3	15.27	16.00
			4	15.25	16.00
HSUPA	1312	1712.4	1	15.83	16.00
			2	15.85	16.00
			3	15.77	16.00
			4	15.75	16.00
			5	15.77	16.00
	1413	1732.6	1	15.79	16.00
			2	15.85	16.00
			3	15.83	16.00
			4	15.79	16.00
			5	15.80	16.00
	1513	1752.6	1	15.76	16.00
			2	15.77	16.00
			3	15.35	16.00
			4	15.35	16.00
			5	15.30	16.00
DC-HSDPA	1312	1712.4	1	15.33	16.00
			2	15.27	16.00
			3	15.27	16.00
			4	15.33	16.00
	1413	1732.6	1	15.34	16.00
			2	15.27	16.00
			3	15.30	16.00
			4	15.25	16.00
	1513	1752.6	1	15.27	16.00
			2	14.86	16.00
			3	14.79	16.00
			4	14.78	16.00

(ii) WCDMA Band V – Antenna Ant 5

Mode	Channel Number	Freq (MHz)	Subset	Average Power Measured (dBm)	Factory Upper Tolerance (dBm)
RMC	4132	826.4	-	19.53	20.00
	4183	836.6	-	19.49	20.00
	4233	846.6	-	19.46	20.00
HSDPA	4132	826.4	1	19.55	20.00
			2	19.55	20.00
			3	19.44	20.00
			4	19.58	20.00
	4183	836.6	1	19.56	20.00
			2	19.50	20.00
			3	19.11	20.00
			4	19.09	20.00
	4233	846.6	1	19.02	20.00
			2	19.05	20.00
			3	19.04	20.00
			4	19.01	20.00
HSUPA	4132	826.4	1	19.55	20.00
			2	19.56	20.00
			3	19.55	20.00
			4	19.55	20.00
			5	19.44	20.00
	4183	836.6	1	19.51	20.00
			2	19.58	20.00
			3	19.48	20.00
			4	19.56	20.00
			5	19.53	20.00
	4233	846.6	1	19.50	20.00
			2	19.48	20.00
			3	19.11	20.00
			4	19.10	20.00
			5	19.09	20.00
DC-HSDPA	4132	826.4	1	19.11	20.00
			2	19.02	20.00
			3	19.01	20.00
			4	19.05	20.00
	4183	836.6	1	18.98	20.00
			2	19.04	20.00
			3	19.04	20.00
			4	19.01	20.00
	4233	846.6	1	18.96	20.00
			2	18.73	20.00
			3	18.70	20.00
			4	18.66	20.00

B.2.2 LTE

(i) LTE Band 2 FDD – Antennas 5 & 8

SAR Measurement for LTE Band 2 FDD (Frequency range: 1850 – 1910MHz) is covered by LTE Band 25 FDD (Frequency range: 1850 – 1915MHz) due to overlapping frequency range, same maximum tune-up and same bandwidth.

(ii) LTE Band 4 FDD – Antenna 5 & 8

SAR Measurement for LTE Band 4 FDD (Frequency range: 1710 – 1755MHz) is covered by LTE Band 66 FDD (Frequency range: 1710 – 1780MHz) due to overlapping frequency range, same maximum tune-up and same bandwidth.

(iii) LTE Band 7 FDD – Antenna 5

Band	BW	Channel #	Freq (MHz)	% RB Allocation	RB Position	QPSK			16 QAM		
						Factory Upper Tolerance (dBm)	M P R	Measured Output Power (dBm)	Factory Upper Tolerance (dBm)	M P R	Measured Output Power (dBm)
LTE 7	20 MHz	20850	2510	1RB Low	1 Pos 0	18.00	0	17.15	18.00	1	16.33
				1RB Mid	1 Pos 50	18.00	0	17.24	18.00	1	16.43
				1RB High	1 Pos 99	18.00	0	17.19	18.00	1	16.36
				50% RB Low	50 Pos 0	18.00	1	16.18	18.00	2	15.19
				50% RB Mid	50 Pos 24	18.00	1	16.26	18.00	2	15.25
				50% RB High	50 Pos 50	18.00	1	16.29	18.00	2	15.28
		100% RB	100 Pos 0	18.00	1	16.22	18.00	2	15.19		
		21100	2535	1RB Low	1 Pos 0	18.00	0	17.20	18.00	1	16.39
				1RB Mid	1 Pos 50	18.00	0	17.42	18.00	1	16.64
				1RB High	1 Pos 99	18.00	0	17.34	18.00	1	16.56
				50% RB Low	50 Pos 0	18.00	1	16.39	18.00	2	15.38
				50% RB Mid	50 Pos 24	18.00	1	16.44	18.00	2	15.43
				50% RB High	50 Pos 50	18.00	1	16.44	18.00	2	15.42
		100% RB	100 Pos 0	18.00	1	16.40	18.00	2	15.35		
		21350	2560	1RB Low	1 Pos 0	18.00	0	17.28	18.00	1	16.43
				1RB Mid	1 Pos 50	18.00	0	17.42	18.00	1	16.64
				1RB High	1 Pos 99	18.00	0	17.41	18.00	1	16.55
				50% RB Low	50 Pos 0	18.00	1	16.38	18.00	2	15.35
	50% RB Mid			50 Pos 24	18.00	1	16.43	18.00	2	15.40	
	50% RB High			50 Pos 50	18.00	1	16.45	18.00	2	15.45	
	100% RB	100 Pos 0	18.00	1	16.41	18.00	2	15.36			
	15 MHz	20825	2507.5	1RB Low	1 Pos 0	18.00	0	17.15	18.00	1	16.42
				1RB Mid	1 Pos 38	18.00	0	17.23	18.00	1	16.53
				1RB High	1 Pos 74	18.00	0	17.19	18.00	1	16.49
				50% RB Low	38 Pos 0	18.00	1	16.23	18.00	2	15.22
				50% RB Mid	38 Pos 19	18.00	1	16.23	18.00	2	15.22
				50% RB High	38 Pos 39	18.00	1	16.25	18.00	2	15.24
		100% RB	75 Pos 0	18.00	1	16.26	18.00	2	15.24		
		21100	2535	1RB Low	1 Pos 0	18.00	0	17.35	18.00	1	16.34
				1RB Mid	1 Pos 38	18.00	0	17.43	18.00	1	16.47
				1RB High	1 Pos 74	18.00	0	17.35	18.00	1	16.38
				50% RB Low	38 Pos 0	18.00	1	16.30	18.00	2	15.27
				50% RB Mid	38 Pos 19	18.00	1	16.35	18.00	2	15.35
				50% RB High	38 Pos 39	18.00	1	16.36	18.00	2	15.33
		100% RB	75 Pos 0	18.00	1	16.40	18.00	2	15.36		
		21375	2562.5	1RB Low	1 Pos 0	18.00	0	17.33	18.00	1	16.47
				1RB Mid	1 Pos 38	18.00	0	17.45	18.00	1	16.58
				1RB High	1 Pos 74	18.00	0	17.41	18.00	1	16.55
				50% RB Low	38 Pos 0	18.00	1	16.39	18.00	2	15.40
	50% RB Mid			38 Pos 19	18.00	1	16.41	18.00	2	15.42	
	50% RB High			38 Pos 39	18.00	1	16.44	18.00	2	15.46	
	100% RB	75 Pos 0	18.00	1	16.45	18.00	2	15.41			
	10 MHz	20800	2505	1RB Low	1 Pos 0	18.00	0	17.23	18.00	1	16.43
				1RB Mid	1 Pos 24	18.00	0	17.27	18.00	1	16.59
				1RB High	1 Pos 49	18.00	0	17.25	18.00	1	16.54
				50% RB Low	25 Pos 0	18.00	1	16.27	18.00	2	15.32
				50% RB Mid	25 Pos 12	18.00	1	16.32	18.00	2	15.38
				50% RB High	25 Pos 25	18.00	1	16.32	18.00	2	15.38
100% RB		50 Pos0	18.00	1	16.30	18.00	2	15.26			
21100		2535	1RB Low	1 Pos 0	18.00	0	17.42	18.00	1	16.12	
			1RB Mid	1 Pos 24	18.00	0	17.48	18.00	1	16.35	
			1RB High	1 Pos 49	18.00	0	17.48	18.00	1	16.32	
			50% RB Low	25 Pos 0	18.00	1	16.37	18.00	2	15.37	
			50% RB Mid	25 Pos 12	18.00	1	16.35	18.00	2	15.34	
			50% RB High	25 Pos 25	18.00	1	16.44	18.00	2	15.41	
100% RB		50 Pos0	18.00	1	16.44	18.00	2	15.42			
21400		2565	1RB Low	1 Pos 0	18.00	0	17.39	18.00	1	16.65	
			1RB Mid	1 Pos 24	18.00	0	17.51	18.00	1	16.74	
			1RB High	1 Pos 49	18.00	0	17.46	18.00	1	16.76	
			50% RB Low	25 Pos 0	18.00	1	16.46	18.00	2	15.52	
	50% RB Mid		25 Pos 12	18.00	1	16.48	18.00	2	15.53		
	50% RB High		25 Pos 25	18.00	1	16.45	18.00	2	15.51		
100% RB	50 Pos0	18.00	1	16.47	18.00	2	15.43				

Band	BW	Channel #	Freq (MHz)	% RB Allocation	RB Position	QPSK			16 QAM		
						Factory Upper Tolerance (dBm)	M P R	Measured Output Power (dBm)	Factory Upper Tolerance (dBm)	M P R	Measured Output Power (dBm)
LTE 7	5 MHz	20775	2502.5	1RB Low	1 Pos 0	18.00	0	17.33	18.00	1	16.57
				1RB Mid	1 Pos 12	18.00	0	17.35	18.00	1	16.56
				1RB High	1 Pos 24	18.00	0	17.37	18.00	1	16.59
				50% RB Low	12 Pos 0	18.00	1	16.28	18.00	2	15.24
				50% RB Mid	12 Pos 6	18.00	1	16.26	18.00	2	15.20
				50% RB High	12 Pos 11	18.00	1	16.28	18.00	2	15.23
		21100	2535	100% RB	25 Pos 0	18.00	1	16.29	18.00	2	15.31
				1RB Low	1 Pos 0	18.00	0	17.38	18.00	1	16.62
				1RB Mid	1 Pos 12	18.00	0	17.44	18.00	1	16.65
				1RB High	1 Pos 24	18.00	0	17.44	18.00	1	16.68
				50% RB Low	12 Pos 0	18.00	1	16.35	18.00	2	15.36
				50% RB Mid	12 Pos 6	18.00	1	16.34	18.00	2	15.32
		21425	2567.5	50% RB High	12 Pos 11	18.00	1	16.40	18.00	2	15.40
				100% RB	25 Pos 0	18.00	1	16.43	18.00	2	15.40
				1RB Low	1 Pos 0	18.00	0	17.46	18.00	1	16.64
				1RB Mid	1 Pos 12	18.00	0	17.49	18.00	1	16.68
				1RB High	1 Pos 24	18.00	0	17.55	18.00	1	16.68
				50% RB Low	12 Pos 0	18.00	1	16.51	18.00	2	15.43
		50% RB Mid	12 Pos 6	18.00	1	16.47	18.00	2	15.39		
		50% RB High	12 Pos 11	18.00	1	16.47	18.00	2	15.38		
		100% RB	25 Pos 0	18.00	1	16.47	18.00	2	15.43		

(i) LTE Band 7 FDD – Antenna 8

Band	BW	Channel #	Freq (MHz)	% RB Allocation	RB Position	QPSK			16 QAM		
						Factory Upper Tolerance (dBm)	M P R	Measured Output Power (dBm)	Factory Upper Tolerance (dBm)	M P R	Measured Output Power (dBm)
LTE 7	20 MHz	20850	2510	1RB Low	1 Pos 0	18.00	0	16.92	18.00	1	16.10
				1RB Mid	1 Pos 50	18.00	0	17.03	18.00	1	16.25
				1RB High	1 Pos 99	18.00	0	17.00	18.00	1	16.15
				50% RB Low	50 Pos 0	18.00	1	16.01	18.00	2	14.98
				50% RB Mid	50 Pos 24	18.00	1	16.05	18.00	2	15.03
				50% RB High	50 Pos 50	18.00	1	16.10	18.00	2	15.13
		100% RB	100 Pos 0	18.00	1	16.02	18.00	2	14.97		
		21100	2535	1RB Low	1 Pos 0	18.00	0	16.99	18.00	1	16.16
				1RB Mid	1 Pos 50	18.00	0	17.20	18.00	1	16.39
				1RB High	1 Pos 99	18.00	0	17.14	18.00	1	16.34
				50% RB Low	50 Pos 0	18.00	1	16.18	18.00	2	15.15
				50% RB Mid	50 Pos 24	18.00	1	16.23	18.00	2	15.19
				50% RB High	50 Pos 50	18.00	1	16.15	18.00	2	15.17
		100% RB	100 Pos 0	18.00	1	16.14	18.00	2	15.11		
		21350	2560	1RB Low	1 Pos 0	18.00	0	17.04	18.00	1	16.20
				1RB Mid	1 Pos 50	18.00	0	17.18	18.00	1	16.38
				1RB High	1 Pos 99	18.00	0	17.12	18.00	1	16.28
				50% RB Low	50 Pos 0	18.00	1	16.10	18.00	2	15.08
	50% RB Mid			50 Pos 24	18.00	1	16.22	18.00	2	15.19	
	50% RB High			50 Pos 50	18.00	1	16.16	18.00	2	15.15	
	100% RB	100 Pos 0	18.00	1	16.15	18.00	2	15.10			
	15 MHz	20825	2507.5	1RB Low	1 Pos 0	18.00	0	16.92	18.00	1	16.23
				1RB Mid	1 Pos 38	18.00	0	16.99	18.00	1	16.36
				1RB High	1 Pos 74	18.00	0	16.94	18.00	1	16.24
				50% RB Low	38 Pos 0	18.00	1	15.99	18.00	2	14.98
				50% RB Mid	38 Pos 19	18.00	1	16.01	18.00	2	15.00
				50% RB High	38 Pos 39	18.00	1	16.00	18.00	2	15.04
		100% RB	75 Pos 0	18.00	1	16.04	18.00	2	15.02		
		21100	2535	1RB Low	1 Pos 0	18.00	0	17.04	18.00	1	16.30
				1RB Mid	1 Pos 38	18.00	0	17.14	18.00	1	16.44
				1RB High	1 Pos 74	18.00	0	17.07	18.00	1	16.41
				50% RB Low	38 Pos 0	18.00	1	16.10	18.00	2	15.09
				50% RB Mid	38 Pos 19	18.00	1	16.14	18.00	2	15.12
				50% RB High	38 Pos 39	18.00	1	16.08	18.00	2	15.08
		100% RB	75 Pos 0	18.00	1	16.13	18.00	2	15.10		
		21375	2562.5	1RB Low	1 Pos 0	18.00	0	17.02	18.00	1	16.29
				1RB Mid	1 Pos 38	18.00	0	17.17	18.00	1	16.46
				1RB High	1 Pos 74	18.00	0	17.12	18.00	1	16.42
				50% RB Low	38 Pos 0	18.00	1	16.12	18.00	2	15.09
	50% RB Mid			38 Pos 19	18.00	1	16.14	18.00	2	15.12	
	50% RB High			38 Pos 39	18.00	1	16.17	18.00	2	15.17	
	100% RB	75 Pos 0	18.00	1	16.16	18.00	2	15.14			
	10 MHz	20800	2505	1RB Low	1 Pos 0	18.00	0	17.00	18.00	1	16.24
				1RB Mid	1 Pos 24	18.00	0	17.06	18.00	1	16.35
				1RB High	1 Pos 49	18.00	0	17.04	18.00	1	16.29
				50% RB Low	25 Pos 0	18.00	1	16.06	18.00	2	15.12
				50% RB Mid	25 Pos 12	18.00	1	16.07	18.00	2	15.12
				50% RB High	25 Pos 25	18.00	1	16.06	18.00	2	15.13
100% RB		50 Pos0	18.00	1	16.10	18.00	2	15.02			
21100		2535	1RB Low	1 Pos 0	18.00	0	17.07	18.00	1	16.33	
			1RB Mid	1 Pos 24	18.00	0	17.21	18.00	1	16.48	
			1RB High	1 Pos 49	18.00	0	17.18	18.00	1	16.44	
			50% RB Low	25 Pos 0	18.00	1	16.13	18.00	2	15.21	
			50% RB Mid	25 Pos 12	18.00	1	16.13	18.00	2	15.19	
			50% RB High	25 Pos 25	18.00	1	16.18	18.00	2	15.25	
100% RB		50 Pos0	18.00	1	16.18	18.00	2	15.14			
21400		2565	1RB Low	1 Pos 0	18.00	0	17.05	18.00	1	16.41	
			1RB Mid	1 Pos 24	18.00	0	17.22	18.00	1	16.49	
			1RB High	1 Pos 49	18.00	0	17.18	18.00	1	16.47	
			50% RB Low	25 Pos 0	18.00	1	16.21	18.00	2	15.29	
	50% RB Mid		25 Pos 12	18.00	1	16.19	18.00	2	15.26		
	50% RB High		25 Pos 25	18.00	1	16.19	18.00	2	15.25		
100% RB	50 Pos0	18.00	1	16.22	18.00	2	15.18				

Band	BW	Channel #	Freq (MHz)	% RB Allocation	RB Position	QPSK			16 QAM		
						Factory Upper Tolerance (dBm)	M P R	Measured Output Power (dBm)	Factory Upper Tolerance (dBm)	M P R	Measured Output Power (dBm)
LTE 7	5 MHz	20775	2502.5	1RB Low	1 Pos 0	18.00	0	17.12	18.00	1	16.39
				1RB Mid	1 Pos 12	18.00	0	17.09	18.00	1	16.25
				1RB High	1 Pos 24	18.00	0	17.12	18.00	1	16.35
				50% RB Low	12 Pos 0	18.00	1	16.05	18.00	2	15.00
				50% RB Mid	12 Pos 6	18.00	1	16.02	18.00	2	14.96
				50% RB High	12 Pos 11	18.00	1	16.02	18.00	2	14.98
		21100	2535	100% RB	25 Pos 0	18.00	1	16.04	18.00	2	15.04
				1RB Low	1 Pos 0	18.00	0	17.16	18.00	1	16.39
				1RB Mid	1 Pos 12	18.00	0	17.22	18.00	1	16.44
				1RB High	1 Pos 24	18.00	0	17.23	18.00	1	16.45
				50% RB Low	12 Pos 0	18.00	1	16.13	18.00	2	15.09
				50% RB Mid	12 Pos 6	18.00	1	16.12	18.00	2	15.08
		21425	2567.5	50% RB High	12 Pos 11	18.00	1	16.13	18.00	2	15.08
				100% RB	25 Pos 0	18.00	1	16.18	18.00	2	15.17
				1RB Low	1 Pos 0	18.00	0	17.16	18.00	1	16.39
				1RB Mid	1 Pos 12	18.00	0	17.22	18.00	1	16.44
				1RB High	1 Pos 24	18.00	0	17.18	18.00	1	16.41
				50% RB Low	12 Pos 0	18.00	1	16.19	18.00	2	15.22
		50% RB Mid	12 Pos 6	18.00	1	16.14	18.00	2	15.14		
		50% RB High	12 Pos 11	18.00	1	16.14	18.00	2	15.14		
		100% RB	25 Pos 0	18.00	1	16.16	18.00	2	15.24		

(ii) LTE Band 12 FDD – Antenna 5

Band	BW	Channel #	Freq (MHz)	% RB Allocation	RB Position	QPSK			16 QAM			
						Factory Upper Tolerance (dBm)	M P R	Measured Output Power (dBm)	Factory Upper Tolerance (dBm)	M P R	Measured Output Power (dBm)	
LTE 12	10 MHz	23095	707.5	1RB Low	1 Pos 0	20.00	0	19.19	20.00	1	18.43	
				1RB Mid	1 Pos 24	20.00	0	19.13	20.00	1	18.40	
				1RB High	1 Pos 49	20.00	0	19.11	20.00	1	18.39	
				50% RB Low	25 Pos 0	20.00	1	18.09	20.00	2	17.15	
				50% RB Mid	25 Pos 12	20.00	1	18.11	20.00	2	17.15	
				50% RB High	25 Pos 24	20.00	1	18.11	20.00	2	17.17	
	100% RB	50 Pos 0	20.00	1	18.07	20.00	2	17.07				
	5 MHz	23035	701.5	1RB Low	1 Pos 0	20.00	0	19.20	20.00	1	18.47	
				1RB Mid	1 Pos 12	20.00	0	19.27	20.00	1	18.54	
				1RB High	1 Pos 24	20.00	0	19.17	20.00	1	18.42	
				50% RB Low	12 Pos 0	20.00	1	18.18	20.00	2	17.17	
				50% RB Mid	12 Pos 6	20.00	1	18.16	20.00	2	17.08	
				50% RB High	12 Pos 11	20.00	1	18.11	20.00	2	17.02	
		100% RB	25 Pos 0	20.00	1	18.16	20.00	2	17.11			
		23095	707.5	1RB Low	1 Pos 0	20.00	0	19.16	20.00	1	18.43	
				1RB Mid	1 Pos 12	20.00	0	19.13	20.00	1	18.40	
				1RB High	1 Pos 24	20.00	0	19.13	20.00	1	18.41	
				50% RB Low	12 Pos 0	20.00	1	18.06	20.00	2	17.09	
				50% RB Mid	12 Pos 6	20.00	1	18.08	20.00	2	17.06	
				50% RB High	12 Pos 11	20.00	1	18.07	20.00	2	17.10	
		100% RB	25 Pos 0	20.00	1	18.09	20.00	2	17.14			
		23155	713.5	1RB Low	1 Pos 0	20.00	0	19.13	20.00	1	18.32	
				1RB Mid	1 Pos 12	20.00	0	19.15	20.00	1	18.34	
				1RB High	1 Pos 24	20.00	0	19.18	20.00	1	18.33	
				50% RB Low	12 Pos 0	20.00	1	18.11	20.00	2	17.03	
				50% RB Mid	12 Pos 6	20.00	1	18.09	20.00	2	17.01	
				50% RB High	12 Pos 11	20.00	1	18.08	20.00	2	17.00	
		100% RB	25 Pos 0	20.00	1	18.09	20.00	2	17.06			
		3 MHz	23025	700.5	1RB Low	1 Pos 0	20.00	0	19.15	20.00	1	18.44
					1RB Mid	1 Pos 7	20.00	0	19.17	20.00	1	18.44
					1RB High	1 Pos 14	20.00	0	19.19	20.00	1	18.52
	50% RB Low				8 Pos 0	20.00	1	18.04	20.00	2	17.09	
	50% RB Mid				8 Pos 4	20.00	1	18.07	20.00	2	17.13	
	50% RB High				8 Pos 7	20.00	1	18.06	20.00	2	17.08	
	100% RB		15 Pos 0	20.00	1	18.09	20.00	2	17.08			
	23095		707.5	1RB Low	1 Pos 0	20.00	0	19.14	20.00	1	18.40	
				1RB Mid	1 Pos 7	20.00	0	19.09	20.00	1	18.41	
				1RB High	1 Pos 14	20.00	0	19.05	20.00	1	18.39	
				50% RB Low	8 Pos 0	20.00	1	18.02	20.00	2	17.04	
				50% RB Mid	8 Pos 4	20.00	1	18.05	20.00	2	17.08	
				50% RB High	8 Pos 7	20.00	1	18.06	20.00	2	17.05	
	100% RB		15 Pos 0	20.00	1	18.06	20.00	2	17.04			
	23165		714.5	1RB Low	1 Pos 0	20.00	0	19.11	20.00	1	18.40	
				1RB Mid	1 Pos 7	20.00	0	19.12	20.00	1	18.46	
				1RB High	1 Pos 14	20.00	0	19.08	20.00	1	18.38	
				50% RB Low	8 Pos 0	20.00	1	18.05	20.00	2	17.08	
				50% RB Mid	8 Pos 4	20.00	1	18.01	20.00	2	17.05	
				50% RB High	8 Pos 7	20.00	1	18.02	20.00	2	17.04	
100% RB	15 Pos 0		20.00	1	18.03	20.00	2	17.03				

Band	BW	Channel #	Freq (MHz)	% RB Allocation	RB Position	QPSK			16 QAM				
						Factory Upper Tolerance (dBm)	M P R	Measured Output Power (dBm)	Factory Upper Tolerance (dBm)	M P R	Measured Output Power (dBm)		
LTE 12	1.4 MHz	23017	700	1 RB Low	1 Pos 0	20.00	0	19.12	20.00	1	18.04		
				1 RB Mid	1 Pos 2	20.00	0	19.19	20.00	1	18.14		
				1 RB High	1 Pos 5	20.00	0	19.16	20.00	1	18.07		
				50% RB Low	3 Pos 0	20.00	0	19.11	20.00	1	18.26		
				50% RB Mid	3 Pos 1	20.00	0	19.10	20.00	1	18.28		
				50% RB High	3 Pos 2	20.00	0	19.11	20.00	1	18.32		
		23095	708	100% RB	6 Pos 0	20.00	1	18.07	20.00	2	17.14		
				1 RB Low	1 Pos 0	20.00	0	19.19	20.00	1	18.17		
				1 RB Mid	1 Pos 2	20.00	0	19.12	20.00	1	18.27		
				1 RB High	1 Pos 5	20.00	0	19.09	20.00	1	18.04		
				50% RB Low	3 Pos 0	20.00	0	19.08	20.00	1	18.14		
				50% RB Mid	3 Pos 1	20.00	0	18.98	20.00	1	18.18		
		23173	715	50% RB High	3 Pos 2	20.00	0	19.01	20.00	1	18.20		
				100% RB	6 Pos 0	20.00	1	18.07	20.00	2	17.09		
				1 RB Low	1 Pos 0	20.00	0	19.14	20.00	1	18.02		
				1 RB Mid	1 Pos 2	20.00	0	19.11	20.00	1	18.05		
				1 RB High	1 Pos 5	20.00	0	19.05	20.00	1	18.01		
				50% RB Low	3 Pos 0	20.00	0	19.02	20.00	1	18.20		
						50% RB Mid	3 Pos 1	20.00	0	19.08	20.00	1	18.24
						50% RB High	3 Pos 2	20.00	0	19.06	20.00	1	18.30
						100% RB	6 Pos 0	20.00	1	18.05	20.00	2	17.11

(iii) LTE Band 13 FDD – Antenna 5

Band	BW	Channel #	Freq (MHz)	% RB Allocation	RB Position	QPSK			16 QAM		
						Factory Upper Tolerance (dBm)	M P R	Measured Output Power (dBm)	Factory Upper Tolerance (dBm)	M P R	Measured Output Power (dBm)
LTE 13	10 MHz	23230	782	1RB Low	1 Pos 0	19.00	0	17.99	19.00	1	17.19
				1RB Mid	1 Pos 24	19.00	0	18.00	19.00	1	17.27
				1RB High	1 Pos 49	19.00	0	17.95	19.00	1	17.19
				50% RB Low	25 Pos 0	19.00	1	16.83	19.00	2	15.91
				50% RB Mid	25 Pos 12	19.00	1	16.91	19.00	2	16.00
				50% RB High	25 Pos 24	19.00	1	16.88	19.00	2	15.92
	5.0 MHz	23230	782	100% RB	50 Pos 0	19.00	1	16.87	19.00	2	15.84
				1RB Low	1 Pos 0	19.00	0	18.08	19.00	1	17.20
				1RB Mid	1 Pos 12	19.00	0	18.03	19.00	1	17.16
				1RB High	1 Pos 24	19.00	0	17.96	19.00	1	17.12
				50% RB Low	12 Pos 0	19.00	1	16.89	19.00	2	15.84
				50% RB Mid	12 Pos 6	19.00	1	16.87	19.00	2	15.85
				50% RB High	12 Pos 11	19.00	1	16.89	19.00	2	15.84
				100% RB	25 Pos 0	19.00	1	16.91	19.00	2	15.93

(iv) TE Band 14 FDD – Antenna 5

Band	BW	Channel #	Freq (MHz)	% RB Allocation	RB Position	QPSK			16 QAM		
						Factory Upper Tolerance (dBm)	M P R	Measured Output Power (dBm)	Factory Upper Tolerance (dBm)	M P R	Measured Output Power (dBm)
LTE 14	10 MHz	23330	793	1RB Low	1 Pos 0	18.50	0	16.90	18.50	1	16.15
				1RB Mid	1 Pos 24	18.50	0	16.94	18.50	1	16.22
				1RB High	1 Pos 49	18.50	0	16.94	18.50	1	16.18
				50% RB Low	25 Pos 0	18.50	1	15.86	18.50	2	14.93
				50% RB Mid	25 Pos 12	18.50	1	15.87	18.50	2	14.93
				50% RB High	25 Pos 24	18.50	1	15.92	18.50	2	14.99
	5.0 MHz	23330	793	100% RB	50 Pos 0	18.50	1	15.90	18.50	2	14.85
				1RB Low	1 Pos 0	18.50	0	16.93	18.50	1	16.17
				1RB Mid	1 Pos 12	18.50	0	16.94	18.50	1	16.16
				1RB High	1 Pos 24	18.50	0	16.96	18.50	1	16.17
				50% RB Low	12 Pos 0	18.50	1	15.84	18.50	2	14.82
				50% RB Mid	12 Pos 6	18.50	1	15.87	18.50	2	14.84
				50% RB High	12 Pos 11	18.50	1	15.86	18.50	2	14.83
				100% RB	25 Pos 0	18.50	1	15.82	18.50	2	14.88

(v) LTE Band 17 FDD – Antennas 5

SAR Measurement for LTE Band 17 FDD (Frequency range: 704 – 716MHz) is covered by LTE Band 12 FDD (Frequency range: 699 – 716MHz) due to overlapping frequency range, same maximum tune-up and same bandwidth.

(vi) LTE Band 25 FDD – Antenna 5

Band	BW	Channel #	Freq (MHz)	% RB Allocation	RB Position	QPSK			16 QAM		
						Factory Upper Tolerance (dBm)	M P R	Measured Output Power (dBm)	Factory Upper Tolerance (dBm)	M P R	Measured Output Power (dBm)
LTE 25	20 MHz	26140	1860.0	1RB Low	1 Pos 0	17.50	0	16.88	17.50	1	16.07
				1RB Mid	1 Pos 50	17.50	0	16.94	17.50	1	16.17
				1RB High	1 Pos 99	17.50	0	16.96	17.50	1	16.15
				50% RB Low	50 Pos 0	17.50	1	15.99	17.50	2	15.04
				50% RB Mid	50 Pos 24	17.50	1	16.02	17.50	2	15.10
				50% RB High	50 Pos 50	17.50	1	16.04	17.50	2	15.11
		100% RB	100 Pos 0	17.50	1	16.02	17.50	2	15.05		
		26365	1882.5	1RB Low	1 Pos 0	17.50	0	16.88	17.50	1	16.08
				1RB Mid	1 Pos 50	17.50	0	17.08	17.50	1	16.24
				1RB High	1 Pos 99	17.50	0	17.00	17.50	1	16.19
				50% RB Low	50 Pos 0	17.50	1	15.92	17.50	2	14.95
				50% RB Mid	50 Pos 24	17.50	1	16.04	17.50	2	15.11
				50% RB High	50 Pos 50	17.50	1	15.99	17.50	2	15.05
		100% RB	100 Pos 0	17.50	1	15.98	17.50	2	15.00		
		26590	1905.0	1RB Low	1 Pos 0	17.50	0	16.95	17.50	1	16.14
				1RB Mid	1 Pos 50	17.50	0	17.13	17.50	1	16.32
				1RB High	1 Pos 99	17.50	0	17.12	17.50	1	16.26
				50% RB Low	50 Pos 0	17.50	1	16.06	17.50	2	15.06
	50% RB Mid			50 Pos 24	17.50	1	16.11	17.50	2	15.10	
	50% RB High			50 Pos 50	17.50	1	16.01	17.50	2	15.03	
	100% RB	100 Pos 0	17.50	1	16.06	17.50	2	15.03			
	15 MHz	26115	1857.5	1RB Low	1 Pos 0	17.50	0	16.89	17.50	1	16.18
				1RB Mid	1 Pos 38	17.50	0	16.95	17.50	1	16.24
				1RB High	1 Pos 74	17.50	0	16.90	17.50	1	16.20
				50% RB Low	38 Pos 0	17.50	1	15.91	17.50	2	14.99
				50% RB Mid	38 Pos 19	17.50	1	15.94	17.50	2	15.01
				50% RB High	38 Pos 39	17.50	1	15.88	17.50	2	14.98
		100% RB	75 Pos 0	17.50	1	15.92	17.50	2	15.01		
		26365	1882.5	1RB Low	1 Pos 0	17.50	0	16.95	17.50	1	16.27
				1RB Mid	1 Pos 38	17.50	0	17.03	17.50	1	16.32
				1RB High	1 Pos 74	17.50	0	16.97	17.50	1	16.26
				50% RB Low	38 Pos 0	17.50	1	15.96	17.50	2	15.08
				50% RB Mid	38 Pos 19	17.50	1	16.00	17.50	2	15.09
				50% RB High	38 Pos 39	17.50	1	15.94	17.50	2	15.01
		100% RB	75 Pos 0	17.50	1	15.99	17.50	2	15.05		
		26615	1907.5	1RB Low	1 Pos 0	17.50	0	16.96	17.50	1	16.26
				1RB Mid	1 Pos 38	17.50	0	17.11	17.50	1	16.40
				1RB High	1 Pos 74	17.50	0	17.09	17.50	1	16.42
				50% RB Low	38 Pos 0	17.50	1	16.06	17.50	2	15.04
	50% RB Mid			38 Pos 19	17.50	1	16.08	17.50	2	15.09	
	50% RB High			38 Pos 39	17.50	1	16.07	17.50	2	15.06	
	100% RB	75 Pos 0	17.50	1	16.09	17.50	2	15.07			
	10 MHz	26090	1855.0	1RB Low	1 Pos 0	17.50	0	17.03	17.50	1	16.32
				1RB Mid	1 Pos 24	17.50	0	16.98	17.50	1	16.26
				1RB High	1 Pos 49	17.50	0	16.99	17.50	1	16.29
				50% RB Low	25 Pos 0	17.50	1	15.96	17.50	2	15.06
				50% RB Mid	25 Pos 12	17.50	1	15.97	17.50	2	15.11
				50% RB High	25 Pos 25	17.50	1	15.96	17.50	2	15.06
100% RB		50 Pos0	17.50	1	15.97	17.50	2	15.02			
26365		1882.5	1RB Low	1 Pos 0	17.50	0	17.11	17.50	1	16.38	
			1RB Mid	1 Pos 24	17.50	0	17.08	17.50	1	16.36	
			1RB High	1 Pos 49	17.50	0	17.05	17.50	1	16.36	
			50% RB Low	25 Pos 0	17.50	1	16.05	17.50	2	15.16	
			50% RB Mid	25 Pos 12	17.50	1	16.06	17.50	2	15.17	
			50% RB High	25 Pos 25	17.50	1	16.04	17.50	2	15.15	
100% RB		50 Pos0	17.50	1	16.07	17.50	2	15.10			
26640		1910.0	1RB Low	1 Pos 0	17.50	0	17.16	17.50	1	16.41	
			1RB Mid	1 Pos 24	17.50	0	17.16	17.50	1	16.42	
			1RB High	1 Pos 49	17.50	0	17.23	17.50	1	16.50	
			50% RB Low	25 Pos 0	17.50	1	16.20	17.50	2	15.24	
	50% RB Mid		25 Pos 12	17.50	1	16.16	17.50	2	15.23		
	50% RB High		25 Pos 25	17.50	1	16.10	17.50	2	15.18		
100% RB	50 Pos0	17.50	1	16.17	17.50	2	15.15				

Band	BW	Channel #	Freq (MHz)	% RB Allocation	RB Position	QPSK			16 QAM		
						Factory Upper Tolerance (dBm)	M P R	Measured Output Power (dBm)	Factory Upper Tolerance (dBm)	M P R	Measured Output Power (dBm)
LTE25	5 MHz	26065	1852.5	1RB Low	1 Pos 0	17.50	0	17.06	17.50	1	16.30
				1RB Mid	1 Pos 38	17.50	0	17.05	17.50	1	16.26
				1RB High	1 Pos 74	17.50	0	17.05	17.50	1	16.26
				50% RB Low	38 Pos 0	17.50	1	15.92	17.50	2	15.02
				50% RB Mid	38 Pos 19	17.50	1	15.93	17.50	2	15.00
				50% RB High	38 Pos 39	17.50	1	15.93	17.50	2	14.98
		100% RB	75 Pos 0	17.50	1	15.95	17.50	2	15.05		
		26365	1882.5	1RB Low	1 Pos 0	17.50	0	17.12	17.50	1	16.31
				1RB Mid	1 Pos 38	17.50	0	17.12	17.50	1	16.27
				1RB High	1 Pos 74	17.50	0	17.10	17.50	1	16.32
				50% RB Low	38 Pos 0	17.50	1	16.03	17.50	2	15.07
				50% RB Mid	38 Pos 19	17.50	1	16.00	17.50	2	15.05
				50% RB High	38 Pos 39	17.50	1	15.96	17.50	2	15.02
		100% RB	75 Pos 0	17.50	1	16.04	17.50	2	15.17		
		26665	1912.5	1RB Low	1 Pos 0	17.50	0	17.24	17.50	1	16.44
				1RB Mid	1 Pos 38	17.50	0	17.30	17.50	1	16.45
				1RB High	1 Pos 74	17.50	0	17.33	17.50	1	16.48
				50% RB Low	38 Pos 0	17.50	1	16.20	17.50	2	15.19
	50% RB Mid			38 Pos 19	17.50	1	16.15	17.50	2	15.11	
	50% RB High			38 Pos 39	17.50	1	16.15	17.50	2	15.10	
	100% RB	75 Pos 0	17.50	1	16.18	17.50	2	15.21			
	3 MHz	26055	1851.5	1RB Low	1 Pos 0	17.50	0	16.96	17.50	1	16.26
				1RB Mid	1 Pos 24	17.50	0	16.98	17.50	1	16.31
				1RB High	1 Pos 49	17.50	0	16.86	17.50	1	16.22
				50% RB Low	25 Pos 0	17.50	1	15.91	17.50	2	15.01
				50% RB Mid	25 Pos 12	17.50	1	15.88	17.50	2	14.96
				50% RB High	25 Pos 24	17.50	1	15.88	17.50	2	14.97
		100% RB	50 Pos 0	17.50	1	15.91	17.50	2	14.97		
		26365	1882.5	1RB Low	1 Pos 0	17.50	0	17.00	17.50	1	16.30
				1RB Mid	1 Pos 24	17.50	0	17.03	17.50	1	16.37
				1RB High	1 Pos 49	17.50	0	16.93	17.50	1	16.29
				50% RB Low	25 Pos 0	17.50	1	15.93	17.50	2	15.02
				50% RB Mid	25 Pos 12	17.50	1	15.91	17.50	2	15.01
				50% RB High	25 Pos 24	17.50	1	15.89	17.50	2	14.99
		100% RB	50 Pos 0	17.50	1	15.95	17.50	2	15.01		
		26675	1913.5	1RB Low	1 Pos 0	17.50	0	17.11	17.50	1	16.45
				1RB Mid	1 Pos 24	17.50	0	17.15	17.50	1	16.48
				1RB High	1 Pos 49	17.50	0	17.13	17.50	1	16.43
				50% RB Low	25 Pos 0	17.50	1	16.05	17.50	2	15.08
	50% RB Mid			25 Pos 12	17.50	1	16.11	17.50	2	15.13	
	50% RB High			25 Pos 24	17.50	1	16.07	17.50	2	15.11	
	100% RB	50 Pos 0	17.50	1	16.13	17.50	2	15.10			
	1.4 MHz	26047	1850.7	1RB Low	1 Pos 0	17.50	0	17.08	17.50	1	15.92
				1RB Mid	1 Pos 12	17.50	0	17.08	17.50	1	16.03
				1RB High	1 Pos 24	17.50	0	17.01	17.50	1	15.93
				50% RB Low	12 Pos 0	17.50	0	16.96	17.50	1	16.12
				50% RB Mid	12 Pos 6	17.50	0	16.99	17.50	1	16.12
				50% RB High	12 Pos 11	17.50	0	16.98	17.50	1	16.13
		100% RB	25 Pos 0	17.50	1	15.94	17.50	2	15.08		
		26365	1882.5	1RB Low	1 Pos 0	17.50	0	17.05	17.50	1	15.94
				1RB Mid	1 Pos 12	17.50	0	17.08	17.50	1	16.01
				1RB High	1 Pos 24	17.50	0	17.06	17.50	1	15.92
				50% RB Low	12 Pos 0	17.50	0	16.99	17.50	1	16.13
				50% RB Mid	12 Pos 6	17.50	0	16.97	17.50	1	16.14
				50% RB High	12 Pos 11	17.50	0	16.93	17.50	1	16.12
		100% RB	25 Pos 0	17.50	1	15.95	17.50	2	15.09		
		26683	1914.3	1RB Low	1 Pos 0	17.50	0	17.25	17.50	1	16.11
				1RB Mid	1 Pos 12	17.50	0	17.25	17.50	1	16.21
				1RB High	1 Pos 24	17.50	0	17.22	17.50	1	16.11
				50% RB Low	12 Pos 0	17.50	0	17.16	17.50	1	16.31
50% RB Mid	12 Pos 6			17.50	0	17.16	17.50	1	16.30		
50% RB High	12 Pos 11			17.50	0	17.18	17.50	1	16.33		
100% RB	25 Pos 0	17.50	1	16.13	17.50	2	15.22				

(vii) LTE Band 25 FDD – Antenna 8

Band	BW	Channel #	Freq (MHz)	% RB Allocation	RB Position	QPSK			16 QAM		
						Factory Upper Tolerance (dBm)	M P R	Measured Output Power (dBm)	Factory Upper Tolerance (dBm)	M P R	Measured Output Power (dBm)
LTE 25	20 MHz	26140	1860.0	1RB Low	1 Pos 0	16.00	0	15.69	16.00	1	14.83
				1RB Mid	1 Pos 50	16.00	0	15.68	16.00	1	14.91
				1RB High	1 Pos 99	16.00	0	15.72	16.00	1	14.90
				50% RB Low	50 Pos 0	16.00	1	14.70	16.00	2	13.70
				50% RB Mid	50 Pos 24	16.00	1	14.82	16.00	2	13.81
				50% RB High	50 Pos 50	16.00	1	14.86	16.00	2	13.83
		100% RB	100 Pos 0	16.00	1	14.75	16.00	2	13.71		
		26365	1882.5	1RB Low	1 Pos 0	16.00	0	15.66	16.00	1	14.86
				1RB Mid	1 Pos 50	16.00	0	15.84	16.00	1	15.00
				1RB High	1 Pos 99	16.00	0	15.79	16.00	1	14.92
				50% RB Low	50 Pos 0	16.00	1	14.77	16.00	2	13.72
				50% RB Mid	50 Pos 24	16.00	1	14.86	16.00	2	13.82
				50% RB High	50 Pos 50	16.00	1	14.85	16.00	2	13.85
		100% RB	100 Pos 0	16.00	1	14.83	16.00	2	13.80		
		26590	1905.0	1RB Low	1 Pos 0	16.00	0	15.74	16.00	1	14.89
				1RB Mid	1 Pos 50	16.00	0	15.96	16.00	1	15.00
				1RB High	1 Pos 99	16.00	0	16.00	16.00	1	15.00
				50% RB Low	50 Pos 0	16.00	1	14.82	16.00	2	13.86
	50% RB Mid			50 Pos 24	16.00	1	14.90	16.00	2	13.98	
	50% RB High			50 Pos 50	16.00	1	14.79	16.00	2	13.83	
	100% RB	100 Pos 0	16.00	1	14.80	16.00	2	13.85			
	15 MHz	26115	1857.5	1RB Low	1 Pos 0	16.00	0	15.66	16.00	1	14.97
				1RB Mid	1 Pos 38	16.00	0	15.69	16.00	1	15.00
				1RB High	1 Pos 74	16.00	0	15.66	16.00	1	15.00
				50% RB Low	38 Pos 0	16.00	1	14.70	16.00	2	13.69
				50% RB Mid	38 Pos 19	16.00	1	14.72	16.00	2	13.69
				50% RB High	38 Pos 39	16.00	1	14.77	16.00	2	13.75
		100% RB	75 Pos 0	16.00	1	14.73	16.00	2	13.72		
		26365	1882.5	1RB Low	1 Pos 0	16.00	0	15.73	16.00	1	15.00
				1RB Mid	1 Pos 38	16.00	0	15.79	16.00	1	15.00
				1RB High	1 Pos 74	16.00	0	15.75	16.00	1	15.00
				50% RB Low	38 Pos 0	16.00	1	14.79	16.00	2	13.80
				50% RB Mid	38 Pos 19	16.00	1	14.83	16.00	2	13.85
				50% RB High	38 Pos 39	16.00	1	14.84	16.00	2	13.81
		100% RB	75 Pos 0	16.00	1	14.80	16.00	2	13.82		
		26615	1907.5	1RB Low	1 Pos 0	16.00	0	15.75	16.00	1	15.00
				1RB Mid	1 Pos 38	16.00	0	15.93	16.00	1	15.00
				1RB High	1 Pos 74	16.00	0	15.92	16.00	1	15.00
				50% RB Low	38 Pos 0	16.00	1	14.81	16.00	2	13.87
	50% RB Mid			38 Pos 19	16.00	1	14.84	16.00	2	13.89	
	50% RB High			38 Pos 39	16.00	1	14.84	16.00	2	13.89	
	100% RB	75 Pos 0	16.00	1	14.83	16.00	2	13.94			
	10 MHz	26090	1855.0	1RB Low	1 Pos 0	16.00	0	15.78	16.00	1	15.00
				1RB Mid	1 Pos 24	16.00	0	15.71	16.00	1	15.00
				1RB High	1 Pos 49	16.00	0	15.73	16.00	1	15.00
				50% RB Low	25 Pos 0	16.00	1	14.68	16.00	2	13.74
				50% RB Mid	25 Pos 12	16.00	1	14.73	16.00	2	13.80
				50% RB High	25 Pos 25	16.00	1	14.73	16.00	2	13.79
100% RB		50 Pos0	16.00	1	14.74	16.00	2	13.71			
26365		1882.5	1RB Low	1 Pos 0	16.00	0	15.85	16.00	1	15.00	
			1RB Mid	1 Pos 24	16.00	0	15.83	16.00	1	15.00	
			1RB High	1 Pos 49	16.00	0	15.86	16.00	1	15.00	
			50% RB Low	25 Pos 0	16.00	1	14.84	16.00	2	13.94	
			50% RB Mid	25 Pos 12	16.00	1	14.85	16.00	2	13.94	
			50% RB High	25 Pos 25	16.00	1	14.84	16.00	2	13.94	
100% RB		50 Pos0	16.00	1	14.90	16.00	2	13.87			
26640		1910.0	1RB Low	1 Pos 0	16.00	0	15.98	16.00	1	15.00	
			1RB Mid	1 Pos 24	16.00	0	15.99	16.00	1	15.00	
			1RB High	1 Pos 49	16.00	0	16.00	16.00	1	15.00	
			50% RB Low	25 Pos 0	16.00	1	14.94	16.00	2	14.00	
	50% RB Mid		25 Pos 12	16.00	1	14.91	16.00	2	14.00		
	50% RB High		25 Pos 25	16.00	1	14.86	16.00	2	13.98		
100% RB	50 Pos0	16.00	1	14.95	16.00	2	14.00				

Band	BW	Channel #	Freq (MHz)	% RB Allocation	RB Position	QPSK			16 QAM		
						Factory Upper Tolerance (dBm)	M P R	Measured Output Power (dBm)	Factory Upper Tolerance (dBm)	M P R	Measured Output Power (dBm)
LTE25	5 MHz	26065	1852.5	1RB Low	1 Pos 0	16.00	0	15.80	16.00	1	14.99
				1RB Mid	1 Pos 38	16.00	0	15.79	16.00	1	15.00
				1RB High	1 Pos 74	16.00	0	15.78	16.00	1	14.98
				50% RB Low	38 Pos 0	16.00	1	14.72	16.00	2	13.68
				50% RB Mid	38 Pos 19	16.00	1	14.71	16.00	2	13.70
				50% RB High	38 Pos 39	16.00	1	14.75	16.00	2	13.70
		100% RB	75 Pos 0	16.00	1	14.75	16.00	2	13.76		
		26365	1882.5	1RB Low	1 Pos 0	16.00	0	15.89	16.00	1	15.00
				1RB Mid	1 Pos 38	16.00	0	15.89	16.00	1	15.00
				1RB High	1 Pos 74	16.00	0	15.88	16.00	1	15.00
				50% RB Low	38 Pos 0	16.00	1	14.85	16.00	2	13.83
				50% RB Mid	38 Pos 19	16.00	1	14.85	16.00	2	13.79
				50% RB High	38 Pos 39	16.00	1	14.82	16.00	2	13.75
		100% RB	75 Pos 0	16.00	1	14.88	16.00	2	13.87		
		26665	1912.5	1RB Low	1 Pos 0	16.00	0	16.00	16.00	1	15.00
				1RB Mid	1 Pos 38	16.00	0	16.00	16.00	1	15.00
				1RB High	1 Pos 74	16.00	0	16.00	16.00	1	15.00
				50% RB Low	38 Pos 0	16.00	1	14.96	16.00	2	14.00
	50% RB Mid			38 Pos 19	16.00	1	14.89	16.00	2	13.94	
	50% RB High			38 Pos 39	16.00	1	14.93	16.00	2	13.95	
	100% RB	75 Pos 0	16.00	1	14.94	16.00	2	14.00			
	3 MHz	26055	1851.5	1RB Low	1 Pos 0	16.00	0	15.69	16.00	1	15.00
				1RB Mid	1 Pos 24	16.00	0	15.73	16.00	1	15.00
				1RB High	1 Pos 49	16.00	0	15.65	16.00	1	14.99
				50% RB Low	25 Pos 0	16.00	1	14.75	16.00	2	13.71
				50% RB Mid	25 Pos 12	16.00	1	14.70	16.00	2	13.70
				50% RB High	25 Pos 24	16.00	1	14.74	16.00	2	13.70
		100% RB	50 Pos 0	16.00	1	14.72	16.00	2	13.67		
		26365	1882.5	1RB Low	1 Pos 0	16.00	0	15.76	16.00	1	15.00
				1RB Mid	1 Pos 24	16.00	0	15.81	16.00	1	15.00
				1RB High	1 Pos 49	16.00	0	15.72	16.00	1	15.00
				50% RB Low	25 Pos 0	16.00	1	14.79	16.00	2	13.79
				50% RB Mid	25 Pos 12	16.00	1	14.73	16.00	2	13.77
				50% RB High	25 Pos 24	16.00	1	14.73	16.00	2	13.75
		100% RB	50 Pos 0	16.00	1	14.77	16.00	2	13.75		
		26675	1913.5	1RB Low	1 Pos 0	16.00	0	15.94	16.00	1	15.00
				1RB Mid	1 Pos 24	16.00	0	15.98	16.00	1	15.00
				1RB High	1 Pos 49	16.00	0	15.94	16.00	1	15.00
				50% RB Low	25 Pos 0	16.00	1	14.86	16.00	2	13.97
	50% RB Mid			25 Pos 12	16.00	1	14.92	16.00	2	13.99	
	50% RB High			25 Pos 24	16.00	1	14.88	16.00	2	13.96	
	100% RB	50 Pos 0	16.00	1	14.91	16.00	2	13.95			
	1.4 MHz	26047	1850.7	1RB Low	1 Pos 0	16.00	0	15.66	16.00	1	14.66
				1RB Mid	1 Pos 12	16.00	0	15.70	16.00	1	14.75
				1RB High	1 Pos 24	16.00	0	15.63	16.00	1	14.67
				50% RB Low	12 Pos 0	16.00	0	15.59	16.00	1	14.90
				50% RB Mid	12 Pos 6	16.00	0	15.63	16.00	1	14.90
				50% RB High	12 Pos 11	16.00	0	15.60	16.00	1	14.92
100% RB		25 Pos 0	16.00	1	14.75	16.00	2	13.74			
26365		1882.5	1RB Low	1 Pos 0	16.00	0	15.75	16.00	1	14.72	
			1RB Mid	1 Pos 12	16.00	0	15.77	16.00	1	14.78	
			1RB High	1 Pos 24	16.00	0	15.73	16.00	1	14.70	
			50% RB Low	12 Pos 0	16.00	0	15.69	16.00	1	14.97	
			50% RB Mid	12 Pos 6	16.00	0	15.72	16.00	1	14.96	
			50% RB High	12 Pos 11	16.00	0	15.65	16.00	1	14.95	
100% RB		25 Pos 0	16.00	1	14.80	16.00	2	13.83			
26683		1914.3	1RB Low	1 Pos 0	16.00	0	15.92	16.00	1	14.82	
			1RB Mid	1 Pos 12	16.00	0	15.95	16.00	1	14.92	
			1RB High	1 Pos 24	16.00	0	15.92	16.00	1	14.86	
			50% RB Low	12 Pos 0	16.00	0	15.89	16.00	1	15.00	
	50% RB Mid		12 Pos 6	16.00	0	15.91	16.00	1	15.00		
	50% RB High		12 Pos 11	16.00	0	15.91	16.00	1	15.00		
100% RB	25 Pos 0	16.00	1	14.91	16.00	2	14.00				

(viii) LTE Band 26 FDD – Antenna 5

Band	BW	Channel #	Freq (MHz)	% RB Allocation	RB Position	QPSK			16 QAM		
						Factory Upper Tolerance (dBm)	M P R	Measured Output Power (dBm)	Factory Upper Tolerance (dBm)	M P R	Measured Output Power (dBm)
LTE26	15 MHz	26775	821.5	1RB Low	1 Pos 0	17.00	0	16.93	17.00	1	16.00
				1RB Mid	1 Pos 38	17.00	0	17.00	17.00	1	16.00
				1RB High	1 Pos 74	17.00	0	16.96	17.00	1	16.00
				50% RB Low	38 Pos 0	17.00	1	15.93	17.00	2	14.97
				50% RB Mid	38 Pos 19	17.00	1	15.97	17.00	2	14.96
				50% RB High	38 Pos 39	17.00	1	16.00	17.00	2	14.95
		100% RB	75 Pos 0	17.00	1	16.00	17.00	2	14.96		
		26865	831.5	1RB Low	1 Pos 0	17.00	0	16.91	17.00	1	16.00
				1RB Mid	1 Pos 38	17.00	0	17.00	17.00	1	16.00
				1RB High	1 Pos 74	17.00	0	16.96	17.00	1	16.00
				50% RB Low	38 Pos 0	17.00	1	15.97	17.00	2	15.00
				50% RB Mid	38 Pos 19	17.00	1	16.00	17.00	2	14.99
				50% RB High	38 Pos 39	17.00	1	16.00	17.00	2	15.00
		100% RB	75 Pos 0	17.00	1	15.97	17.00	2	15.00		
		26965	841.5	1RB Low	1 Pos 0	17.00	0	16.96	17.00	1	16.00
				1RB Mid	1 Pos 38	17.00	0	17.00	17.00	1	16.00
				1RB High	1 Pos 74	17.00	0	16.88	17.00	1	16.00
				50% RB Low	38 Pos 0	17.00	1	16.00	17.00	2	15.00
	50% RB Mid			38 Pos 19	17.00	1	16.00	17.00	2	14.99	
	50% RB High			38 Pos 39	17.00	1	16.00	17.00	2	14.98	
	100% RB	75 Pos 0	17.00	1	16.00	17.00	2	15.00			
	10 MHz	26750	820	1RB Low	1 Pos 0	17.00	0	17.00	17.00	1	16.00
				1RB Mid	1 Pos 24	17.00	0	16.99	17.00	1	16.00
				1RB High	1 Pos 49	17.00	0	17.00	17.00	1	16.00
				50% RB Low	25 Pos 0	17.00	1	15.99	17.00	2	15.00
				50% RB Mid	25 Pos 12	17.00	1	15.95	17.00	2	14.98
				50% RB High	25 Pos 24	17.00	1	15.93	17.00	2	15.00
		100% RB	50 Pos 0	17.00	1	15.98	17.00	2	14.97		
		26865	831.5	1RB Low	1 Pos 0	17.00	0	16.99	17.00	1	16.00
				1RB Mid	1 Pos 24	17.00	0	17.00	17.00	1	16.00
				1RB High	1 Pos 49	17.00	0	17.00	17.00	1	16.00
				50% RB Low	25 Pos 0	17.00	1	16.00	17.00	2	15.00
				50% RB Mid	25 Pos 12	17.00	1	16.00	17.00	2	15.00
				50% RB High	25 Pos 24	17.00	1	16.00	17.00	2	15.00
		100% RB	50 Pos 0	17.00	1	16.00	17.00	2	15.00		
		26990	844	1RB Low	1 Pos 0	17.00	0	17.00	17.00	1	16.00
				1RB Mid	1 Pos 24	17.00	0	17.00	17.00	1	16.00
				1RB High	1 Pos 49	17.00	0	17.00	17.00	1	16.00
				50% RB Low	25 Pos 0	17.00	1	16.00	17.00	2	15.00
	50% RB Mid			25 Pos 12	17.00	1	16.00	17.00	2	15.00	
	50% RB High			25 Pos 24	17.00	1	16.00	17.00	2	15.00	
	100% RB	50 Pos 0	17.00	1	16.00	17.00	2	15.00			
	5.0 MHz	26715	816.5	1RB Low	1 Pos 0	17.00	0	17.00	17.00	1	16.00
				1RB Mid	1 Pos 12	17.00	0	17.00	17.00	1	16.00
				1RB High	1 Pos 24	17.00	0	17.00	17.00	1	16.00
				50% RB Low	12 Pos 0	17.00	1	15.97	17.00	2	14.90
				50% RB Mid	12 Pos 6	17.00	1	15.97	17.00	2	14.93
				50% RB High	12 Pos 11	17.00	1	15.96	17.00	2	14.90
100% RB		25 Pos 0	17.00	1	15.97	17.00	2	15.00			
26865		831.5	1RB Low	1 Pos 0	17.00	0	17.00	17.00	1	16.00	
			1RB Mid	1 Pos 12	17.00	0	17.00	17.00	1	16.00	
			1RB High	1 Pos 24	17.00	0	17.00	17.00	1	16.00	
			50% RB Low	12 Pos 0	17.00	1	16.00	17.00	2	15.00	
			50% RB Mid	12 Pos 6	17.00	1	16.00	17.00	2	14.98	
			50% RB High	12 Pos 11	17.00	1	16.00	17.00	2	15.00	
100% RB		25 Pos 0	17.00	1	16.00	17.00	2	15.00			
27015		846.5	1RB Low	1 Pos 0	17.00	0	17.00	17.00	1	16.00	
			1RB Mid	1 Pos 12	17.00	0	17.00	17.00	1	16.00	
			1RB High	1 Pos 24	17.00	0	17.00	17.00	1	16.00	
			50% RB Low	12 Pos 0	17.00	1	16.00	17.00	2	14.99	
	50% RB Mid		12 Pos 6	17.00	1	15.98	17.00	2	14.95		
	50% RB High		12 Pos 11	17.00	1	16.00	17.00	2	14.93		
100% RB	25 Pos 0	17.00	1	15.98	17.00	2	15.00				

Band	BW	Channel #	Freq (MHz)	% RB Allocation	RB Position	QPSK			16 QAM		
						Factory Upper Tolerance (dBm)	M P R	Measured Output Power (dBm)	Factory Upper Tolerance (dBm)	M P R	Measured Output Power (dBm)
LTE26	3.0 MHz	26705	815.5	1RB Low	1 Pos 0	17.00	0	16.94	17.00	1	16.00
				1RB Mid	1 Pos 7	17.00	0	16.99	17.00	1	16.00
				1RB High	1 Pos 14	17.00	0	16.94	17.00	1	16.00
				50% RB Low	8 Pos 0	17.00	1	15.84	17.00	2	14.88
				50% RB Mid	8 Pos 4	17.00	1	15.91	17.00	2	14.92
				50% RB High	8 Pos 7	17.00	1	15.88	17.00	2	14.89
		100% RB	15 Pos 0	17.00	1	15.91	17.00	2	14.88		
		26865	831.5	1RB Low	1 Pos 0	17.00	0	17.00	17.00	1	16.00
				1RB Mid	1 Pos 7	17.00	0	17.00	17.00	1	16.00
				1RB High	1 Pos 14	17.00	0	16.96	17.00	1	16.00
				50% RB Low	8 Pos 0	17.00	1	16.00	17.00	2	15.00
				50% RB Mid	8 Pos 4	17.00	1	15.99	17.00	2	15.00
				50% RB High	8 Pos 7	17.00	1	16.00	17.00	2	15.00
		100% RB	15 Pos 0	17.00	1	16.00	17.00	2	15.00		
		27025	847.5	1RB Low	1 Pos 0	17.00	0	17.00	17.00	1	16.00
				1RB Mid	1 Pos 7	17.00	0	16.98	17.00	1	16.00
				1RB High	1 Pos 14	17.00	0	16.99	17.00	1	16.00
				50% RB Low	8 Pos 0	17.00	1	15.96	17.00	2	15.00
	50% RB Mid			8 Pos 4	17.00	1	15.97	17.00	2	15.00	
	50% RB High			8 Pos 7	17.00	1	15.92	17.00	2	14.94	
	100% RB	15 Pos 0	17.00	1	15.99	17.00	2	14.99			
	1.4 MHz	26697	814.7	1RB Low	1 Pos 0	17.00	0	16.98	17.00	1	15.86
				1RB Mid	1 Pos 2	17.00	0	16.99	17.00	1	15.93
				1RB High	1 Pos 5	17.00	0	17.00	17.00	1	15.89
				50% RB Low	3 Pos 0	17.00	0	16.91	17.00	1	16.00
				50% RB Mid	3 Pos 1	17.00	0	16.92	17.00	1	16.00
				50% RB High	3 Pos 2	17.00	0	16.91	17.00	1	16.00
		100% RB	6 Pos 0	17.00	1	15.88	17.00	2	14.95		
		26865	831.5	1RB Low	1 Pos 0	17.00	0	17.00	17.00	1	16.00
				1RB Mid	1 Pos 2	17.00	0	17.00	17.00	1	16.00
				1RB High	1 Pos 5	17.00	0	17.00	17.00	1	16.00
				50% RB Low	3 Pos 0	17.00	0	17.00	17.00	1	16.00
				50% RB Mid	3 Pos 1	17.00	0	17.00	17.00	1	16.00
				50% RB High	3 Pos 2	17.00	0	17.00	17.00	1	16.00
		100% RB	6 Pos 0	17.00	1	15.99	17.00	2	15.00		
		27033	848.3	1RB Low	1 Pos 0	17.00	0	16.86	17.00	1	15.98
				1RB Mid	1 Pos 2	17.00	0	17.00	17.00	1	15.98
				1RB High	1 Pos 5	17.00	0	16.98	17.00	1	15.91
				50% RB Low	3 Pos 0	17.00	0	16.99	17.00	1	16.00
	50% RB Mid			3 Pos 1	17.00	0	16.96	17.00	1	16.00	
	50% RB High			3 Pos 2	17.00	0	16.98	17.00	1	16.00	
	100% RB	6 Pos 0	17.00	1	15.96	17.00	2	15.00			

(ix) LTE Band 30 FDD – Antenna 5

Band	BW	Channel #	Freq (MHz)	% RB Allocation	RB Position	QPSK			16 QAM		
						Factory Upper Tolerance (dBm)	M P R	Measured Output Power (dBm)	Factory Upper Tolerance (dBm)	M P R	Measured Output Power (dBm)
LTE30	10 MHz	27710	2310	1RB Low	1 Pos 0	17.00	0	16.32	17.00	1	15.49
				1RB Mid	1 Pos 24	17.00	0	16.36	17.00	1	15.52
				1RB High	1 Pos 49	17.00	0	16.30	17.00	1	15.50
				50% RB Low	25 Pos 0	17.00	1	15.36	17.00	2	14.39
				50% RB Mid	25 Pos 12	17.00	1	15.25	17.00	2	14.30
				50% RB High	25 Pos 24	17.00	1	15.08	17.00	2	14.16
	100% RB	50 Pos 0	17.00	1	15.25	17.00	2	14.22			
	5.0 MHz	27710	2310	1RB Low	1 Pos 0	17.00	0	16.30	17.00	1	15.34
				1RB Mid	1 Pos 12	17.00	0	16.35	17.00	1	15.37
				1RB High	1 Pos 24	17.00	0	16.35	17.00	1	15.39
				50% RB Low	12 Pos 0	17.00	1	15.28	17.00	2	14.27
				50% RB Mid	12 Pos 6	17.00	1	15.19	17.00	2	14.16
				50% RB High	12 Pos 11	17.00	1	15.13	17.00	2	14.05
				100% RB	25 Pos 0	17.00	1	15.23	17.00	2	14.27

(x) LTE Band 30 FDD – Antenna 8

Band	BW	Channel #	Freq (MHz)	% RB Allocation	RB Position	QPSK			16 QAM		
						Factory Upper Tolerance (dBm)	M P R	Measured Output Power (dBm)	Factory Upper Tolerance (dBm)	M P R	Measured Output Power (dBm)
LTE30	10 MHz	27710	2310	1RB Low	1 Pos 0	17.50	0	16.97	17.50	1	16.19
				1RB Mid	1 Pos 24	17.50	0	17.03	17.50	1	16.23
				1RB High	1 Pos 49	17.50	0	16.96	17.50	1	16.23
				50% RB Low	25 Pos 0	17.50	1	16.02	17.50	2	15.08
				50% RB Mid	25 Pos 12	17.50	1	15.96	17.50	2	15.02
				50% RB High	25 Pos 24	17.50	1	15.80	17.50	2	14.85
	100% RB	50 Pos 0	17.50	1	15.88	17.50	2	14.87			
	5.0 MHz	27710	2310	1RB Low	1 Pos 0	17.50	0	16.97	17.50	1	16.16
				1RB Mid	1 Pos 12	17.50	0	17.07	17.50	1	16.14
				1RB High	1 Pos 24	17.50	0	17.06	17.50	1	16.16
				50% RB Low	12 Pos 0	17.50	1	15.96	17.50	2	14.99
				50% RB Mid	12 Pos 6	17.50	1	15.90	17.50	2	14.85
				50% RB High	12 Pos 11	17.50	1	15.82	17.50	2	14.76
				100% RB	25 Pos 0	17.50	1	15.88	17.50	2	14.94

(xi) LTE Band38 TDD – Antenna 5

SAR Measurement for LTE Band 38 TDD (Frequency range: 2570 – 2620MHz) is covered by LTE Band 41 TDD (Frequency range: 2496 – 2690MHz) due to overlapping frequency range, same maximum tune-up and same bandwidth.

LTE Band 41 TDD – Antenna 5

Band	BW	Channel #	Freq (MHz)	% RB Allocation	RB Position	QPSK			16 QAM		
						Factory Upper Tolerance (dBm)	M P R	Measured Output Power (dBm)	Factory Upper Tolerance (dBm)	M P R	Measured Output Power (dBm)
LTE41	20 MHz	39750	2506	1RB Low	1 Pos 0	19.50	0	19.00	19.50	1	18.19
				1RB Mid	1 Pos 50	19.50	0	18.90	19.50	1	18.06
				1RB High	1 Pos 99	19.50	0	18.51	19.50	1	17.72
				50% RB Low	50 Pos 0	19.50	1	17.87	19.50	2	16.84
				50% RB Mid	50 Pos 24	19.50	1	17.81	19.50	2	16.84
				50% RB High	50 Pos 50	19.50	1	17.75	19.50	2	16.72
				100% RB	100 Pos 0	19.50	1	17.81	19.50	2	16.77
		40185	2549.5	1RB Low	1 Pos 0	19.50	0	17.96	19.50	1	16.61
				1RB Mid	1 Pos 50	19.50	0	17.97	19.50	1	16.65
				1RB High	1 Pos 99	19.50	0	17.94	19.50	1	16.53
				50% RB Low	50 Pos 0	19.50	1	17.03	19.50	2	16.02
				50% RB Mid	50 Pos 24	19.50	1	16.96	19.50	2	15.94
				50% RB High	50 Pos 50	19.50	1	16.92	19.50	2	15.90
				100% RB	100 Pos 0	19.50	1	16.95	19.50	2	15.94
		40620	2593	1RB Low	1 Pos 0	19.50	0	18.33	19.50	1	17.29
				1RB Mid	1 Pos 50	19.50	0	18.71	19.50	1	17.63
				1RB High	1 Pos 99	19.50	0	18.90	19.50	1	17.82
				50% RB Low	50 Pos 0	19.50	1	17.47	19.50	2	16.44
				50% RB Mid	50 Pos 24	19.50	1	17.61	19.50	2	16.58
				50% RB High	50 Pos 50	19.50	1	17.84	19.50	2	16.79
				100% RB	100 Pos 0	19.50	1	17.63	19.50	2	16.65
		41055	2636.5	1RB Low	1 Pos 0	19.50	0	19.15	19.50	1	18.35
				1RB Mid	1 Pos 50	19.50	0	19.34	19.50	1	18.46
				1RB High	1 Pos 99	19.50	0	19.32	19.50	1	18.49
				50% RB Low	50 Pos 0	19.50	1	18.37	19.50	2	17.38
				50% RB Mid	50 Pos 24	19.50	1	18.31	19.50	2	17.36
				50% RB High	50 Pos 50	19.50	1	18.39	19.50	2	17.40
				100% RB	100 Pos 0	19.50	1	18.33	19.50	2	17.34
		41490	2680	1RB Low	1 Pos 0	19.50	0	18.89	19.50	1	17.55
				1RB Mid	1 Pos 50	19.50	0	18.97	19.50	1	17.66
				1RB High	1 Pos 99	19.50	0	18.53	19.50	1	17.22
				50% RB Low	50 Pos 0	19.50	1	17.91	19.50	2	16.92
				50% RB Mid	50 Pos 24	19.50	1	17.91	19.50	2	16.90
				50% RB High	50 Pos 50	19.50	1	17.78	19.50	2	16.78
				100% RB	100 Pos 0	19.50	1	17.86	19.50	2	16.84

Band	BW	Channel #	Freq (MHz)	% RB Allocation	RB Position	QPSK			16 QAM			
						Factory Upper Tolerance (dBm)	M P R	Measured Output Power (dBm)	Factory Upper Tolerance (dBm)	M P R	Measured Output Power (dBm)	
LTE41	15 MHz	39750	2506	1RB Low	1 Pos 0	19.50	0	18.85	19.50	1	18.27	
				1RB Mid	1 Pos 38	19.50	0	18.77	19.50	1	18.14	
				1RB High	1 Pos 74	19.50	0	18.52	19.50	1	17.88	
				50% RB Low	38 Pos 0	19.50	1	17.83	19.50	2	16.85	
				50% RB Mid	38 Pos 19	19.50	1	17.79	19.50	2	16.79	
				50% RB High	38 Pos 39	19.50	1	17.75	19.50	2	16.77	
		40185	2549.5	2593	1RB Low	1 Pos 0	19.50	0	18.06	19.50	1	17.07
					1RB Mid	1 Pos 38	19.50	0	17.93	19.50	1	16.99
					1RB High	1 Pos 74	19.50	0	17.87	19.50	1	16.95
					50% RB Low	38 Pos 0	19.50	1	16.96	19.50	2	15.93
					50% RB Mid	38 Pos 19	19.50	1	16.92	19.50	2	15.93
					50% RB High	38 Pos 39	19.50	1	16.92	19.50	2	15.92
		40620	2593	2636.5	100% RB	75 Pos 0	19.50	1	16.95	19.50	2	15.96
					1RB Low	1 Pos 0	19.50	0	18.41	19.50	1	17.44
					1RB Mid	1 Pos 38	19.50	0	18.68	19.50	1	17.68
					1RB High	1 Pos 74	19.50	0	18.77	19.50	1	17.80
					50% RB Low	38 Pos 0	19.50	1	17.48	19.50	2	16.52
					50% RB Mid	38 Pos 19	19.50	1	17.59	19.50	2	16.62
		41055	2636.5	2680.0	50% RB High	38 Pos 39	19.50	1	17.73	19.50	2	16.74
					100% RB	75 Pos 0	19.50	1	17.66	19.50	2	16.57
					1RB Low	1 Pos 0	19.50	0	19.22	19.50	1	18.50
					1RB Mid	1 Pos 38	19.50	0	19.28	19.50	1	18.50
					1RB High	1 Pos 74	19.50	0	19.38	19.50	1	18.50
					50% RB Low	38 Pos 0	19.50	1	18.28	19.50	2	17.32
		41490	2680.0	2720.0	50% RB Mid	38 Pos 19	19.50	1	18.28	19.50	2	17.30
					50% RB High	38 Pos 39	19.50	1	18.29	19.50	2	17.33
					100% RB	75 Pos 0	19.50	1	18.35	19.50	2	17.33
					1RB Low	1 Pos 0	19.50	0	18.95	19.50	1	18.04
					1RB Mid	1 Pos 38	19.50	0	18.93	19.50	1	18.00
					1RB High	1 Pos 74	19.50	0	18.72	19.50	1	17.72
		41490	2680.0	2760.0	50% RB Low	38 Pos 0	19.50	1	17.96	19.50	2	16.93
					50% RB Mid	38 Pos 19	19.50	1	17.84	19.50	2	16.85
					50% RB High	38 Pos 39	19.50	1	17.78	19.50	2	16.80
					100% RB	75 Pos 0	19.50	1	17.86	19.50	2	16.82

Band	BW	Channel #	Freq (MHz)	% RB Allocation	RB Position	QPSK			16 QAM			
						Factory Upper Tolerance (dBm)	M P R	Measured Output Power (dBm)	Factory Upper Tolerance (dBm)	M P R	Measured Output Power (dBm)	
LTE41	10 MHz	39750	2506	1RB Low	1 Pos 0	19.50	0	18.91	19.50	1	18.22	
				1RB Mid	1 Pos 24	19.50	0	18.85	19.50	1	18.17	
				1RB High	1 Pos 49	19.50	0	18.68	19.50	1	18.02	
				50% RB Low	25 Pos 0	19.50	1	17.83	19.50	2	16.90	
				50% RB Mid	25 Pos 12	19.50	1	17.83	19.50	2	16.93	
				50% RB High	25 Pos 24	19.50	1	17.81	19.50	2	16.82	
		40185	2549.5	2593	1RB Low	1 Pos 0	19.50	0	17.93	19.50	1	16.86
					1RB Mid	1 Pos 24	19.50	0	17.96	19.50	1	16.84
					1RB High	1 Pos 49	19.50	0	17.94	19.50	1	16.83
					50% RB Low	25 Pos 0	19.50	1	16.96	19.50	2	15.95
					50% RB Mid	25 Pos 12	19.50	1	16.91	19.50	2	15.95
					50% RB High	25 Pos 24	19.50	1	16.95	19.50	2	15.94
		40620	2593	2636.5	100% RB	50 Pos 0	19.50	1	16.98	19.50	2	15.93
					1RB Low	1 Pos 0	19.50	0	18.48	19.50	1	17.54
					1RB Mid	1 Pos 24	19.50	0	18.64	19.50	1	17.69
					1RB High	1 Pos 49	19.50	0	18.72	19.50	1	17.76
					50% RB Low	25 Pos 0	19.50	1	17.54	19.50	2	16.59
					50% RB Mid	25 Pos 12	19.50	1	17.62	19.50	2	16.66
		41055	2636.5	2680	100% RB	50 Pos 0	19.50	1	17.74	19.50	2	16.76
					1RB Low	1 Pos 0	19.50	1	17.66	19.50	2	16.65
					1RB Mid	1 Pos 24	19.50	0	19.28	19.50	1	18.50
					1RB High	1 Pos 49	19.50	0	19.30	19.50	1	18.50
					50% RB Low	25 Pos 0	19.50	0	19.45	19.50	1	18.50
					50% RB Mid	25 Pos 12	19.50	1	18.35	19.50	2	17.39
		41490	2680	2720	100% RB	50 Pos 0	19.50	1	18.31	19.50	2	17.37
					1RB Low	1 Pos 0	19.50	1	18.37	19.50	2	17.44
					1RB Mid	1 Pos 24	19.50	1	18.34	19.50	2	17.32
					1RB High	1 Pos 49	19.50	0	18.95	19.50	1	17.88
					50% RB Low	25 Pos 0	19.50	0	18.92	19.50	1	17.86
					50% RB Mid	25 Pos 12	19.50	0	18.70	19.50	1	17.65
		41490	2680	2760	100% RB	50 Pos 0	19.50	1	17.94	19.50	2	16.94
					1RB Low	1 Pos 0	19.50	1	17.86	19.50	2	16.90
					1RB Mid	1 Pos 24	19.50	1	17.81	19.50	2	16.85
					1RB High	1 Pos 49	19.50	1	17.90	19.50	2	16.90

Band	BW	Channel #	Freq (MHz)	% RB Allocation	RB Position	QPSK			16 QAM		
						Factory Upper Tolerance (dBm)	M P R	Measured Output Power (dBm)	Factory Upper Tolerance (dBm)	M P R	Measured Output Power (dBm)
LTE41	5.0 MHz	39750	2506	1RB Low	1 Pos 0	19.50	0	17.93	19.50	1	17.17
				1RB Mid	1 Pos 12	19.50	0	17.93	19.50	1	17.15
				1RB High	1 Pos 24	19.50	0	17.87	19.50	1	17.21
				50% RB Low	12 Pos 0	19.50	1	16.98	19.50	2	15.99
				50% RB Mid	12 Pos 6	19.50	1	16.92	19.50	2	15.97
				50% RB High	12 Pos 11	19.50	1	16.91	19.50	2	15.89
		40185	2549.5	100% RB	25 Pos 0	19.50	1	16.94	19.50	2	15.93
				1RB Low	1 Pos 0	19.50	0	18.58	19.50	1	17.75
				1RB Mid	1 Pos 12	19.50	0	18.68	19.50	1	17.83
				1RB High	1 Pos 24	19.50	0	18.71	19.50	1	17.85
				50% RB Low	12 Pos 0	19.50	1	17.60	19.50	2	16.51
				50% RB Mid	12 Pos 6	19.50	1	17.66	19.50	2	16.58
		40620	2593	50% RB High	12 Pos 11	19.50	1	17.66	19.50	2	16.58
				100% RB	25 Pos 0	19.50	1	17.62	19.50	2	16.59
				1RB Low	1 Pos 0	19.50	0	19.39	19.50	1	18.50
				1RB Mid	1 Pos 12	19.50	0	19.42	19.50	1	18.50
				1RB High	1 Pos 24	19.50	0	19.49	19.50	1	18.50
				50% RB Low	12 Pos 0	19.50	1	18.30	19.50	2	17.31
		41055	2636.5	50% RB Mid	12 Pos 6	19.50	1	18.28	19.50	2	17.28
				50% RB High	12 Pos 11	19.50	1	18.34	19.50	2	17.27
				100% RB	25 Pos 0	19.50	1	18.31	19.50	2	17.31
				1RB Low	1 Pos 0	19.50	0	18.95	19.50	1	18.23
				1RB Mid	1 Pos 12	19.50	0	18.89	19.50	1	18.14
				1RB High	1 Pos 24	19.50	0	18.73	19.50	1	18.07
		41490	2680	50% RB Low	12 Pos 0	19.50	1	17.96	19.50	2	16.91
				50% RB Mid	12 Pos 6	19.50	1	17.87	19.50	2	16.91
				50% RB High	12 Pos 11	19.50	1	17.86	19.50	2	16.89
				100% RB	25 Pos 0	19.50	1	17.88	19.50	2	16.90
				1RB Low	1 Pos 0	19.50	0	17.93	19.50	1	17.17
				1RB Mid	1 Pos 12	19.50	0	17.93	19.50	1	17.15
				1RB High	1 Pos 24	19.50	0	17.87	19.50	1	17.21
				50% RB Low	12 Pos 0	19.50	1	16.98	19.50	2	15.99
				50% RB Mid	12 Pos 6	19.50	1	16.92	19.50	2	15.97
				50% RB High	12 Pos 11	19.50	1	16.91	19.50	2	15.89
				100% RB	25 Pos 0	19.50	1	16.94	19.50	2	15.93

(xii) LTE Band 41 TDD – Antenna 8

Band	BW	Channel #	Freq (MHz)	% RB Allocation	RB Position	QPSK			16 QAM		
						Factory Upper Tolerance (dBm)	M P R	Measured Output Power (dBm)	Factory Upper Tolerance (dBm)	M P R	Measured Output Power (dBm)
LTE41	20 MHz	39750	2506	1RB Low	1 Pos 0	17.50	0	15.99	17.50	1	15.14
				1RB Mid	1 Pos 50	17.50	0	16.29	17.50	1	15.49
				1RB High	1 Pos 99	17.50	0	16.42	17.50	1	15.60
				50% RB Low	50 Pos 0	17.50	1	15.17	17.50	2	14.20
				50% RB Mid	50 Pos 24	17.50	1	15.33	17.50	2	14.33
				50% RB High	50 Pos 50	17.50	1	15.41	17.50	2	14.44
		40185	2549.5	100% RB	100 Pos 0	17.50	1	15.28	17.50	2	14.33
				1RB Low	1 Pos 0	17.50	0	16.10	17.50	1	15.26
				1RB Mid	1 Pos 50	17.50	0	16.06	17.50	1	15.36
				1RB High	1 Pos 99	17.50	0	16.09	17.50	1	15.22
				50% RB Low	50 Pos 0	17.50	1	15.22	17.50	2	14.32
				50% RB Mid	50 Pos 24	17.50	1	15.21	17.50	2	14.23
		40620	2593	50% RB High	50 Pos 50	17.50	1	15.14	17.50	2	14.16
				100% RB	100 Pos 0	17.50	1	15.20	17.50	2	14.22
				1RB Low	1 Pos 0	17.50	0	16.35	17.50	1	15.53
				1RB Mid	1 Pos 50	17.50	0	16.62	17.50	1	15.83
				1RB High	1 Pos 99	17.50	0	16.64	17.50	1	15.82
				50% RB Low	50 Pos 0	17.50	1	15.50	17.50	2	14.53
		41055	2636.5	50% RB Mid	50 Pos 24	17.50	1	15.60	17.50	2	14.62
				50% RB High	50 Pos 50	17.50	1	15.62	17.50	2	14.65
				100% RB	100 Pos 0	17.50	1	15.59	17.50	2	14.60
				1RB Low	1 Pos 0	17.50	0	16.48	17.50	1	15.66
				1RB Mid	1 Pos 50	17.50	0	16.49	17.50	1	15.69
				1RB High	1 Pos 99	17.50	0	16.41	17.50	1	15.54
		41490	2680	50% RB Low	50 Pos 0	17.50	1	15.57	17.50	2	14.60
				50% RB Mid	50 Pos 24	17.50	1	15.52	17.50	2	14.51
				50% RB High	50 Pos 50	17.50	1	15.50	17.50	2	14.52
				100% RB	100 Pos 0	17.50	1	15.48	17.50	2	14.56
				1RB Low	1 Pos 0	17.50	0	16.32	17.50	1	15.45
				1RB Mid	1 Pos 50	17.50	0	16.53	17.50	1	15.71
				1RB High	1 Pos 99	17.50	0	16.26	17.50	1	15.41
				50% RB Low	50 Pos 0	17.50	1	15.48	17.50	2	14.52
				50% RB Mid	50 Pos 24	17.50	1	15.47	17.50	2	14.56
				50% RB High	50 Pos 50	17.50	1	15.41	17.50	2	14.43
				100% RB	100 Pos 0	17.50	1	15.46	17.50	2	14.52

Band	BW	Channel #	Freq (MHz)	% RB Allocation	RB Position	QPSK			16 QAM			
						Factory Upper Tolerance (dBm)	M P R	Measured Output Power (dBm)	Factory Upper Tolerance (dBm)	M P R	Measured Output Power (dBm)	
LTE41	15 MHz	39750	2506	1RB Low	1 Pos 0	17.50	0	16.04	17.50	1	15.37	
				1RB Mid	1 Pos 38	17.50	0	16.26	17.50	1	15.63	
				1RB High	1 Pos 74	17.50	0	16.36	17.50	1	15.70	
				50% RB Low	38 Pos 0	17.50	1	15.20	17.50	2	14.27	
				50% RB Mid	38 Pos 19	17.50	1	15.30	17.50	2	14.31	
				50% RB High	38 Pos 39	17.50	1	15.36	17.50	2	14.39	
		40185	2549.5	2593	100% RB	75 Pos 0	17.50	1	15.33	17.50	2	14.33
					1RB Low	1 Pos 0	17.50	0	16.18	17.50	1	15.52
					1RB Mid	1 Pos 38	17.50	0	16.12	17.50	1	15.51
					1RB High	1 Pos 74	17.50	0	16.13	17.50	1	15.47
					50% RB Low	38 Pos 0	17.50	1	15.19	17.50	2	14.22
					50% RB Mid	38 Pos 19	17.50	1	15.12	17.50	2	14.15
		40620	2593	2636.5	50% RB High	38 Pos 39	17.50	1	15.12	17.50	2	14.14
					100% RB	75 Pos 0	17.50	1	15.19	17.50	2	14.22
					1RB Low	1 Pos 0	17.50	0	16.39	17.50	1	15.71
					1RB Mid	1 Pos 38	17.50	0	16.56	17.50	1	15.91
					1RB High	1 Pos 74	17.50	0	16.56	17.50	1	15.88
					50% RB Low	38 Pos 0	17.50	1	15.50	17.50	2	14.52
		41055	2636.5	2680.0	50% RB Mid	38 Pos 19	17.50	1	15.46	17.50	2	14.64
					50% RB High	38 Pos 39	17.50	1	15.64	17.50	2	14.65
					100% RB	75 Pos 0	17.50	1	15.53	17.50	2	14.52
					1RB Low	1 Pos 0	17.50	0	16.49	17.50	1	15.77
					1RB Mid	1 Pos 38	17.50	0	16.43	17.50	1	15.73
					1RB High	1 Pos 74	17.50	0	16.44	17.50	1	15.73
		41490	2680.0	2680.0	50% RB Low	38 Pos 0	17.50	1	15.48	17.50	2	14.55
					50% RB Mid	38 Pos 19	17.50	1	15.41	17.50	2	14.46
					50% RB High	38 Pos 39	17.50	1	15.43	17.50	2	14.46
					100% RB	75 Pos 0	17.50	1	15.48	17.50	2	14.52
					1RB Low	1 Pos 0	17.50	0	16.43	17.50	1	15.77
					1RB Mid	1 Pos 38	17.50	0	16.50	17.50	1	15.83
		41490	2680.0	2680.0	1RB High	1 Pos 74	17.50	0	16.30	17.50	1	15.62
					50% RB Low	38 Pos 0	17.50	1	15.55	17.50	2	14.57
					50% RB Mid	38 Pos 19	17.50	1	15.46	17.50	2	14.47
					50% RB High	38 Pos 39	17.50	1	15.38	17.50	2	14.41
					100% RB	75 Pos 0	17.50	1	15.48	17.50	2	14.49

Band	BW	Channel #	Freq (MHz)	% RB Allocation	RB Position	QPSK			16 QAM			
						Factory Upper Tolerance (dBm)	M P R	Measured Output Power (dBm)	Factory Upper Tolerance (dBm)	M P R	Measured Output Power (dBm)	
LTE41	10 MHz	39750	2506	1RB Low	1 Pos 0	17.50	0	16.16	17.50	1	15.44	
				1RB Mid	1 Pos 24	17.50	0	16.28	17.50	1	15.74	
				1RB High	1 Pos 49	17.50	0	16.38	17.50	1	15.64	
				50% RB Low	25 Pos 0	17.50	1	15.26	17.50	2	14.43	
				50% RB Mid	25 Pos 12	17.50	1	15.24	17.50	2	14.40	
				50% RB High	25 Pos 24	17.50	1	15.33	17.50	2	14.50	
		40185	2549.5	2593	100% RB	50 Pos 0	17.50	1	15.29	17.50	2	14.30
					1RB Low	1 Pos 0	17.50	0	16.16	17.50	1	15.46
					1RB Mid	1 Pos 24	17.50	0	16.13	17.50	1	15.47
					1RB High	1 Pos 49	17.50	0	16.07	17.50	1	15.45
					50% RB Low	25 Pos 0	17.50	1	15.16	17.50	2	14.27
					50% RB Mid	25 Pos 12	17.50	1	15.13	17.50	2	14.26
		40620	2593	2636.5	50% RB High	25 Pos 24	17.50	1	15.11	17.50	2	14.21
					100% RB	50 Pos 0	17.50	1	15.18	17.50	2	14.17
					1RB Low	1 Pos 0	17.50	0	16.45	17.50	1	15.78
					1RB Mid	1 Pos 24	17.50	0	16.59	17.50	1	15.92
					1RB High	1 Pos 49	17.50	0	16.61	17.50	1	15.95
					50% RB Low	25 Pos 0	17.50	1	15.60	17.50	2	14.66
		41055	2636.5	2680	50% RB Mid	25 Pos 12	17.50	1	15.55	17.50	2	14.68
					100% RB	50 Pos 0	17.50	1	15.58	17.50	2	14.74
					1RB Low	1 Pos 0	17.50	1	15.62	17.50	2	14.66
					1RB Mid	1 Pos 24	17.50	0	16.52	17.50	1	15.82
					1RB High	1 Pos 49	17.50	0	16.45	17.50	1	15.76
					50% RB Low	25 Pos 0	17.50	0	16.50	17.50	1	15.80
		41490	2680	2680	50% RB Mid	25 Pos 12	17.50	1	15.46	17.50	2	14.56
					100% RB	50 Pos 0	17.50	1	15.44	17.50	2	14.53
					1RB Low	1 Pos 0	17.50	1	15.46	17.50	2	14.56
					1RB Mid	1 Pos 24	17.50	1	15.46	17.50	2	14.51
					1RB High	1 Pos 49	17.50	0	16.49	17.50	1	15.81
					50% RB Low	25 Pos 0	17.50	0	16.51	17.50	1	15.82
		41490	2680	2680	50% RB Mid	25 Pos 12	17.50	0	16.34	17.50	1	15.70
					100% RB	50 Pos 0	17.50	1	15.49	17.50	2	14.65
					1RB Low	1 Pos 0	17.50	1	15.46	17.50	2	14.58
					1RB Mid	1 Pos 24	17.50	1	15.41	17.50	2	14.52
		41490	2680	2680	1RB High	1 Pos 49	17.50	1	15.50	17.50	2	14.49

Band	BW	Channel #	Freq (MHz)	% RB Allocation	RB Position	QPSK			16 QAM			
						Factory Upper Tolerance (dBm)	M P R	Measured Output Power (dBm)	Factory Upper Tolerance (dBm)	M P R	Measured Output Power (dBm)	
LTE41	5.0 MHz	39750	2506	1RB Low	1 Pos 0	17.50	0	16.31	17.50	1	15.60	
				1RB Mid	1 Pos 12	17.50	0	16.39	17.50	1	15.67	
				1RB High	1 Pos 24	17.50	0	16.44	17.50	1	15.73	
				50% RB Low	12 Pos 0	17.50	1	15.31	17.50	2	14.33	
				50% RB Mid	12 Pos 6	17.50	1	15.27	17.50	2	14.31	
				50% RB High	12 Pos 11	17.50	1	15.28	17.50	2	14.32	
		40185	2549.5	2593	100% RB	25 Pos 0	17.50	1	15.31	17.50	2	14.38
					1RB Low	1 Pos 0	17.50	0	16.23	17.50	1	15.56
					1RB Mid	1 Pos 12	17.50	0	16.25	17.50	1	15.49
					1RB High	1 Pos 24	17.50	0	16.19	17.50	1	15.45
					50% RB Low	12 Pos 0	17.50	1	15.16	17.50	2	14.18
					50% RB Mid	12 Pos 6	17.50	1	15.09	17.50	2	14.14
		40620	2593	2636.5	50% RB High	12 Pos 11	17.50	1	15.08	17.50	2	14.08
					100% RB	25 Pos 0	17.50	1	15.14	17.50	2	14.20
					1RB Low	1 Pos 0	17.50	0	16.50	17.50	1	15.88
					1RB Mid	1 Pos 12	17.50	0	16.61	17.50	1	15.98
					1RB High	1 Pos 24	17.50	0	16.60	17.50	1	16.00
					50% RB Low	12 Pos 0	17.50	1	15.54	17.50	2	14.56
		41055	2636.5	2680	50% RB Mid	12 Pos 6	17.50	1	15.59	17.50	2	14.57
					50% RB High	12 Pos 11	17.50	1	15.59	17.50	2	14.56
					100% RB	25 Pos 0	17.50	1	15.57	17.50	2	14.61
					1RB Low	1 Pos 0	17.50	0	16.50	17.50	1	15.82
					1RB Mid	1 Pos 12	17.50	0	16.53	17.50	1	15.82
					1RB High	1 Pos 24	17.50	0	16.49	17.50	1	15.78
		41490	2680	2680	50% RB Low	12 Pos 0	17.50	1	15.45	17.50	2	14.53
					50% RB Mid	12 Pos 6	17.50	1	15.40	17.50	2	14.41
					50% RB High	12 Pos 11	17.50	1	15.45	17.50	2	14.45
					100% RB	25 Pos 0	17.50	1	15.45	17.50	2	14.51
					1RB Low	1 Pos 0	17.50	0	16.48	17.50	1	15.85
					1RB Mid	1 Pos 12	17.50	0	16.53	17.50	1	15.88
		41490	2680	2680	1RB High	1 Pos 24	17.50	0	16.48	17.50	1	15.83
					50% RB Low	12 Pos 0	17.50	1	15.48	17.50	2	14.47
					50% RB Mid	12 Pos 6	17.50	1	15.44	17.50	2	14.46
					50% RB High	12 Pos 11	17.50	1	15.49	17.50	2	14.50
					100% RB	25 Pos 0	17.50	1	15.49	17.50	2	14.51

(xiii) LTE Band 48 TDD – Antenna 8

Band	BW	Channel #	Freq (MHz)	% RB Allocation	RB Position	QPSK			16 QAM		
						Factory Upper Tolerance (dBm)	M P R	Measured Output Power (dBm)	Factory Upper Tolerance (dBm)	M P R	Measured Output Power (dBm)
LTE 48	20 MHz	55340	3560	1RB Low	1 Pos 0	13.50	0	12.35	13.50	1	11.44
				1RB Mid	1 Pos 50	13.50	0	12.44	13.50	1	11.59
				1RB High	1 Pos 99	13.50	0	12.23	13.50	1	11.46
				50% RB Low	50 Pos 0	13.50	1	11.37	13.50	2	10.40
				50% RB Mid	50 Pos 24	13.50	1	11.40	13.50	2	10.44
				50% RB High	50 Pos 50	13.50	1	11.35	13.50	2	10.38
		100% RB	100 Pos 0	13.50	1	11.36	13.50	2	10.36		
		55990	3625	1RB Low	1 Pos 0	13.50	0	12.31	13.50	1	11.38
				1RB Mid	1 Pos 50	13.50	0	12.34	13.50	1	11.54
				1RB High	1 Pos 99	13.50	0	12.32	13.50	1	11.47
				50% RB Low	50 Pos 0	13.50	1	11.27	13.50	2	10.31
				50% RB Mid	50 Pos 24	13.50	1	11.32	13.50	2	10.36
				50% RB High	50 Pos 50	13.50	1	11.36	13.50	2	10.41
		100% RB	100 Pos 0	13.50	1	11.31	13.50	2	10.33		
		56640	3690	1RB Low	1 Pos 0	13.50	0	12.00	13.50	1	11.55
				1RB Mid	1 Pos 50	13.50	0	11.99	13.50	1	11.27
				1RB High	1 Pos 99	13.50	0	11.79	13.50	1	11.30
				50% RB Low	50 Pos 0	13.50	1	11.11	13.50	2	10.18
	50% RB Mid			50 Pos 24	13.50	1	11.09	13.50	2	10.11	
	50% RB High			50 Pos 50	13.50	1	11.01	13.50	2	10.03	
	100% RB	100 Pos 0	13.50	1	11.08	13.50	2	10.05			
	15 MHz	55315	3557.5	1RB Low	1 Pos 0	13.50	0	12.27	13.50	1	11.93
				1RB Mid	1 Pos 38	13.50	0	12.44	13.50	1	11.92
				1RB High	1 Pos 74	13.50	0	12.40	13.50	1	11.85
				50% RB Low	38 Pos 0	13.50	1	11.41	13.50	2	10.39
				50% RB Mid	38 Pos 19	13.50	1	11.37	13.50	2	10.34
				50% RB High	38 Pos 39	13.50	1	11.37	13.50	2	10.33
		100% RB	75 Pos 0	13.50	1	11.42	13.50	2	10.34		
		55990	3625	1RB Low	1 Pos 0	13.50	0	12.38	13.50	1	11.85
				1RB Mid	1 Pos 38	13.50	0	12.40	13.50	1	11.90
				1RB High	1 Pos 74	13.50	0	12.33	13.50	1	11.85
				50% RB Low	38 Pos 0	13.50	1	11.30	13.50	2	10.41
				50% RB Mid	38 Pos 19	13.50	1	11.32	13.50	2	10.39
				50% RB High	38 Pos 39	13.50	1	11.26	13.50	2	10.27
		100% RB	75 Pos 0	13.50	1	11.31	13.50	2	10.33		
		56665	3692.5	1RB Low	1 Pos 0	13.50	0	12.34	13.50	1	11.80
				1RB Mid	1 Pos 38	13.50	0	12.35	13.50	1	11.86
				1RB High	1 Pos 74	13.50	0	12.37	13.50	1	11.87
				50% RB Low	38 Pos 0	13.50	1	11.22	13.50	2	10.26
	50% RB Mid			38 Pos 19	13.50	1	11.32	13.50	2	10.38	
	50% RB High			38 Pos 39	13.50	1	11.36	13.50	2	10.3	
	100% RB	75 Pos 0	13.50	1	11.36	13.50	2	10.25			
	10 MHz	55290	3555	1RB Low	1 Pos 0	13.50	0	12.28	13.50	1	11.75
				1RB Mid	1 Pos 24	13.50	0	12.32	13.50	1	11.83
				1RB High	1 Pos 49	13.50	0	12.31	13.50	1	11.87
				50% RB Low	25 Pos 0	13.50	1	11.22	13.50	2	10.30
				50% RB Mid	25 Pos 12	13.50	1	11.22	13.50	2	10.27
				50% RB High	25 Pos 25	13.50	1	11.23	13.50	2	10.26
100% RB		50 Pos0	13.50	1	11.26	13.50	2	10.24			
55990		3625	1RB Low	1 Pos 0	13.50	0	12.03	13.50	1	11.55	
			1RB Mid	1 Pos 24	13.50	0	12.05	13.50	1	11.52	
			1RB High	1 Pos 49	13.50	0	11.94	13.50	1	11.40	
			50% RB Low	25 Pos 0	13.50	1	11.06	13.50	2	10.10	
			50% RB Mid	25 Pos 12	13.50	1	10.99	13.50	2	10.03	
			50% RB High	25 Pos 25	13.50	1	10.90	13.50	2	9.97	
100% RB		50 Pos0	13.50	1	11.05	13.50	2	9.96			
56690		3695	1RB Low	1 Pos 0	13.50	0	12.07	13.50	1	11.13	
			1RB Mid	1 Pos 24	13.50	0	12.03	13.50	1	11.18	
			1RB High	1 Pos 49	13.50	0	12.01	13.50	1	11.03	
			50% RB Low	25 Pos 0	13.50	1	11.02	13.50	2	10.04	
	50% RB Mid		25 Pos 12	13.50	1	10.98	13.50	2	10.00		
	50% RB High		25 Pos 25	13.50	1	10.94	13.50	2	9.93		
100% RB	50 Pos0	13.50	1	10.98	13.50	2	9.94				

Band	BW	Channel #	Freq (MHz)	% RB Allocation	RB Position	QPSK			16 QAM		
						Factory Upper Tolerance (dBm)	M P R	Measured Output Power (dBm)	Factory Upper Tolerance (dBm)	M P R	Measured Output Power (dBm)
LTE 48	5 MHz	55265	3552.5	1RB Low	1 Pos 0	13.50	0	12.54	13.50	1	11.76
				1RB Mid	1 Pos 12	13.50	0	12.48	13.50	1	11.67
				1RB High	1 Pos 24	13.50	0	12.44	13.50	1	11.69
				50% RB Low	12 Pos 0	13.50	1	11.42	13.50	2	10.37
				50% RB Mid	12 Pos 6	13.50	1	11.43	13.50	2	10.33
				50% RB High	12 Pos 11	13.50	1	11.39	13.50	2	10.28
				100% RB	25 Pos 0	13.50	1	11.39	13.50	2	10.29
		55990	3625	1RB Low	1 Pos 0	13.50	0	12.44	13.50	1	11.57
				1RB Mid	1 Pos 12	13.50	0	12.53	13.50	1	11.69
				1RB High	1 Pos 24	13.50	0	12.43	13.50	1	11.63
				50% RB Low	12 Pos 0	13.50	1	11.30	13.50	2	10.22
				50% RB Mid	12 Pos 6	13.50	1	11.27	13.50	2	10.23
				50% RB High	12 Pos 11	13.50	1	11.29	13.50	2	10.23
				100% RB	25 Pos 0	13.50	1	11.31	13.50	2	10.20
		56715	3697.5	1RB Low	1 Pos 0	13.50	0	12.13	13.50	1	11.31
				1RB Mid	1 Pos 12	13.50	0	12.04	13.50	1	11.25
				1RB High	1 Pos 24	13.50	0	12.08	13.50	1	11.23
				50% RB Low	12 Pos 0	13.50	1	11.01	13.50	2	9.94
				50% RB Mid	12 Pos 6	13.50	1	10.93	13.50	2	9.88
				50% RB High	12 Pos 11	13.50	1	10.89	13.50	2	9.92
				100% RB	25 Pos 0	13.50	1	10.95	13.50	2	9.85

(xiv) LTE Band 66 FDD – Antenna 5

Band	BW	Channel #	Freq (MHz)	% RB Allocation	RB Position	QPSK			16 QAM		
						Factory Upper Tolerance (dBm)	M P R	Measured Output Power (dBm)	Factory Upper Tolerance (dBm)	M P R	Measured Output Power (dBm)
LTE66	20 MHz	132072	1720	1RB Low	1 Pos 0	20.00	0	19.02	20.00	1	18.22
				1RB Mid	1 Pos 50	20.00	0	19.10	20.00	1	18.31
				1RB High	1 Pos 99	20.00	0	19.05	20.00	1	18.24
				50% RB Low	50 Pos 0	20.00	1	18.05	20.00	2	17.03
				50% RB Mid	50 Pos 24	20.00	1	18.09	20.00	2	17.10
				50% RB High	50 Pos 50	20.00	1	18.10	20.00	2	17.08
		100% RB	100 Pos 0	20.00	1	18.06	20.00	2	17.01		
		132322	1745	1RB Low	1 Pos 0	20.00	0	18.87	20.00	1	17.65
				1RB Mid	1 Pos 50	20.00	0	18.96	20.00	1	17.75
				1RB High	1 Pos 99	20.00	0	18.88	20.00	1	17.67
				50% RB Low	50 Pos 0	20.00	1	18.01	20.00	2	17.02
				50% RB Mid	50 Pos 24	20.00	1	17.93	20.00	2	16.96
				50% RB High	50 Pos 50	20.00	1	17.89	20.00	2	16.90
		100% RB	100 Pos 0	20.00	1	17.94	20.00	2	16.92		
		132572	1770	1RB Low	1 Pos 0	20.00	0	18.90	20.00	1	17.68
				1RB Mid	1 Pos 50	20.00	0	18.98	20.00	1	17.78
				1RB High	1 Pos 99	20.00	0	18.92	20.00	1	17.75
				50% RB Low	50 Pos 0	20.00	1	17.78	20.00	2	16.69
	50% RB Mid			50 Pos 24	20.00	1	17.90	20.00	2	16.83	
	50% RB High			50 Pos 50	20.00	1	17.83	20.00	2	16.76	
	100% RB	100 Pos 0	20.00	1	17.79	20.00	2	16.76			
	15 MHz	132047	1717.5	1RB Low	1 Pos 0	20.00	0	19.05	20.00	1	18.37
				1RB Mid	1 Pos 38	20.00	0	19.08	20.00	1	18.38
				1RB High	1 Pos 74	20.00	0	19.02	20.00	1	18.33
				50% RB Low	38 Pos 0	20.00	1	17.99	20.00	2	17.00
				50% RB Mid	38 Pos 19	20.00	1	18.06	20.00	2	17.05
				50% RB High	38 Pos 39	20.00	1	18.06	20.00	2	17.07
		100% RB	75 Pos 0	20.00	1	18.04	20.00	2	17.05		
		132422	1755	1RB Low	1 Pos 0	20.00	0	18.93	20.00	1	17.90
				1RB Mid	1 Pos 38	20.00	0	19.00	20.00	1	18.01
				1RB High	1 Pos 74	20.00	0	18.93	20.00	1	17.93
				50% RB Low	38 Pos 0	20.00	1	17.91	20.00	2	16.91
				50% RB Mid	38 Pos 19	20.00	1	17.92	20.00	2	16.89
				50% RB High	38 Pos 39	20.00	1	17.87	20.00	2	16.82
		100% RB	75 Pos 0	20.00	1	17.91	20.00	2	16.91		
		132597	1772.5	1RB Low	1 Pos 0	20.00	0	18.84	20.00	1	18.01
				1RB Mid	1 Pos 38	20.00	0	18.92	20.00	1	18.10
				1RB High	1 Pos 74	20.00	0	18.90	20.00	1	18.04
				50% RB Low	38 Pos 0	20.00	1	17.79	20.00	2	16.79
	50% RB Mid			38 Pos 19	20.00	1	17.85	20.00	2	16.87	
	50% RB High			38 Pos 39	20.00	1	17.83	20.00	2	16.83	
	100% RB	75 Pos 0	20.00	1	17.78	20.00	2	16.78			
	10 MHz	132022	1715	1RB Low	1 Pos 0	20.00	0	19.16	20.00	1	18.40
				1RB Mid	1 Pos 24	20.00	0	19.14	20.00	1	18.42
				1RB High	1 Pos 49	20.00	0	19.12	20.00	1	18.41
				50% RB Low	25 Pos 0	20.00	1	18.10	20.00	2	17.15
				50% RB Mid	25 Pos 12	20.00	1	18.12	20.00	2	17.17
				50% RB High	25 Pos 24	20.00	1	18.12	20.00	2	17.19
100% RB		50 Pos 0	20.00	1	18.13	20.00	2	17.09			
132422		1755	1RB Low	1 Pos 0	20.00	0	18.97	20.00	1	17.86	
			1RB Mid	1 Pos 24	20.00	0	19.01	20.00	1	17.87	
			1RB High	1 Pos 49	20.00	0	19.01	20.00	1	17.87	
			50% RB Low	25 Pos 0	20.00	1	17.95	20.00	2	16.99	
			50% RB Mid	25 Pos 12	20.00	1	17.90	20.00	2	16.91	
			50% RB High	25 Pos 24	20.00	1	17.91	20.00	2	16.90	
100% RB		50 Pos 0	20.00	1	18.01	20.00	2	16.99			
132622		1775	1RB Low	1 Pos 0	20.00	0	18.94	20.00	1	18.06	
			1RB Mid	1 Pos 24	20.00	0	18.96	20.00	1	18.06	
			1RB High	1 Pos 49	20.00	0	19.02	20.00	1	18.11	
			50% RB Low	25 Pos 0	20.00	1	17.89	20.00	2	16.88	
	50% RB Mid		25 Pos 12	20.00	1	17.89	20.00	2	16.92		
	50% RB High		25 Pos 24	20.00	1	17.85	20.00	2	16.84		
100% RB	50 Pos 0	20.00	1	17.88	20.00	2	16.84				

Band	BW	Channel #	Freq (MHz)	% RB Allocation	RB Position	QPSK			16 QAM		
						Factory Upper Tolerance (dBm)	M P R	Measured Output Power (dBm)	Factory Upper Tolerance (dBm)	M P R	Measured Output Power (dBm)
LTE66	5.0 MHz	131997	1712.5	1RB Low	1 Pos 0	20.00	0	19.19	20.00	1	18.47
				1RB Mid	1 Pos 12	20.00	0	19.19	20.00	1	18.45
				1RB High	1 Pos 24	20.00	0	19.17	20.00	1	18.43
				50% RB Low	12 Pos 0	20.00	1	18.07	20.00	2	17.05
				50% RB Mid	12 Pos 6	20.00	1	18.10	20.00	2	17.06
				50% RB High	12 Pos 11	20.00	1	18.11	20.00	2	17.05
		100% RB	25 Pos 0	20.00	1	18.11	20.00	2	17.11		
		1RB Low	1 Pos 0	20.00	0	18.94	20.00	1	18.22		
		1RB Mid	1 Pos 12	20.00	0	18.95	20.00	1	18.22		
		1RB High	1 Pos 24	20.00	0	18.99	20.00	1	18.24		
		50% RB Low	12 Pos 0	20.00	1	17.94	20.00	2	16.98		
		50% RB Mid	12 Pos 6	20.00	1	17.92	20.00	2	16.92		
		50% RB High	12 Pos 11	20.00	1	17.86	20.00	2	16.91		
		100% RB	25 Pos 0	20.00	1	17.96	20.00	2	16.95		
		1RB Low	1 Pos 0	20.00	0	18.93	20.00	1	18.14		
		1RB Mid	1 Pos 12	20.00	0	19.01	20.00	1	18.20		
		1RB High	1 Pos 24	20.00	0	19.01	20.00	1	18.21		
		50% RB Low	12 Pos 0	20.00	1	18.04	20.00	2	16.94		
		50% RB Mid	12 Pos 6	20.00	1	17.97	20.00	2	16.88		
		50% RB High	12 Pos 11	20.00	1	17.91	20.00	2	16.80		
		100% RB	25 Pos 0	20.00	1	17.93	20.00	2	16.86		
		1RB Low	1 Pos 0	20.00	0	19.10	20.00	1	18.41		
		1RB Mid	1 Pos 7	20.00	0	19.10	20.00	1	18.45		
		1RB High	1 Pos 14	20.00	0	19.05	20.00	1	18.40		
		50% RB Low	8 Pos 0	20.00	1	18.00	20.00	2	17.04		
		50% RB Mid	8 Pos 4	20.00	1	18.04	20.00	2	17.06		
		50% RB High	8 Pos 7	20.00	1	18.05	20.00	2	17.07		
		100% RB	15 Pos 0	20.00	1	18.07	20.00	2	17.03		
		1RB Low	1 Pos 0	20.00	0	18.94	20.00	1	18.21		
		1RB Mid	1 Pos 7	20.00	0	18.94	20.00	1	18.27		
	1RB High	1 Pos 14	20.00	0	18.92	20.00	1	18.23			
	50% RB Low	8 Pos 0	20.00	1	17.90	20.00	2	16.92			
	50% RB Mid	8 Pos 4	20.00	1	17.89	20.00	2	16.91			
	50% RB High	8 Pos 7	20.00	1	17.88	20.00	2	16.86			
	100% RB	15 Pos 0	20.00	1	17.90	20.00	2	16.86			
	1RB Low	1 Pos 0	20.00	0	18.93	20.00	1	18.28			
	1RB Mid	1 Pos 7	20.00	0	18.96	20.00	1	18.31			
	1RB High	1 Pos 14	20.00	0	18.94	20.00	1	18.25			
	50% RB Low	8 Pos 0	20.00	1	17.92	20.00	2	16.94			
	50% RB Mid	8 Pos 4	20.00	1	17.93	20.00	2	16.96			
	50% RB High	8 Pos 7	20.00	1	17.91	20.00	2	16.91			
	100% RB	15 Pos 0	20.00	1	17.91	20.00	2	16.88			
	1RB Low	1 Pos 0	20.00	0	19.14	20.00	1	18.10			
	1RB Mid	1 Pos 2	20.00	0	19.22	20.00	1	18.17			
	1RB High	1 Pos 5	20.00	0	19.13	20.00	1	18.08			
	50% RB Low	3 Pos 0	20.00	0	19.03	20.00	1	18.22			
	50% RB Mid	3 Pos 1	20.00	0	19.07	20.00	1	18.20			
	50% RB High	3 Pos 2	20.00	0	19.05	20.00	1	18.22			
	100% RB	6 Pos 0	20.00	1	18.05	20.00	2	17.07			
	1RB Low	1 Pos 0	20.00	0	19.00	20.00	1	17.92			
	1RB Mid	1 Pos 2	20.00	0	19.07	20.00	1	18.01			
	1RB High	1 Pos 5	20.00	0	18.98	20.00	1	17.93			
	50% RB Low	3 Pos 0	20.00	0	18.93	20.00	1	18.06			
	50% RB Mid	3 Pos 1	20.00	0	18.94	20.00	1	18.06			
	50% RB High	3 Pos 2	20.00	0	18.94	20.00	1	18.09			
	100% RB	6 Pos 0	20.00	1	17.90	20.00	2	16.92			
	1RB Low	1 Pos 0	20.00	0	19.03	20.00	1	17.92			
	1RB Mid	1 Pos 2	20.00	0	19.05	20.00	1	18.03			
	1RB High	1 Pos 5	20.00	0	19.02	20.00	1	17.95			
	50% RB Low	3 Pos 0	20.00	0	18.96	20.00	1	18.08			
	50% RB Mid	3 Pos 1	20.00	0	18.95	20.00	1	18.06			
	50% RB High	3 Pos 2	20.00	0	18.97	20.00	1	18.11			
	100% RB	6 Pos 0	20.00	1	17.92	20.00	2	16.96			

(xv) LTE Band 66 FDD – Antenna 8

Band	BW	Channel #	Freq (MHz)	% RB Allocation	RB Position	QPSK			16 QAM		
						Factory Upper Tolerance (dBm)	M P R	Measured Output Power (dBm)	Factory Upper Tolerance (dBm)	M P R	Measured Output Power (dBm)
LTE66	20 MHz	132072	1720	1RB Low	1 Pos 0	16.00	0	15.69	16.00	1	14.83
				1RB Mid	1 Pos 50	16.00	0	15.73	16.00	1	15.00
				1RB High	1 Pos 99	16.00	0	15.81	16.00	1	14.98
				50% RB Low	50 Pos 0	16.00	1	14.80	16.00	2	13.75
				50% RB Mid	50 Pos 24	16.00	1	14.81	16.00	2	13.81
				50% RB High	50 Pos 50	16.00	1	14.96	16.00	2	13.95
		100% RB	100 Pos 0	16.00	1	14.84	16.00	2	13.81		
		132322	1745	1RB Low	1 Pos 0	16.00	0	15.64	16.00	1	14.83
				1RB Mid	1 Pos 50	16.00	0	15.70	16.00	1	14.96
				1RB High	1 Pos 99	16.00	0	15.74	16.00	1	14.88
				50% RB Low	50 Pos 0	16.00	1	14.88	16.00	2	13.86
				50% RB Mid	50 Pos 24	16.00	1	14.82	16.00	2	13.81
				50% RB High	50 Pos 50	16.00	1	14.85	16.00	2	13.82
		100% RB	100 Pos 0	16.00	1	14.85	16.00	2	13.84		
		132572	1770	1RB Low	1 Pos 0	16.00	0	15.62	16.00	1	14.84
				1RB Mid	1 Pos 50	16.00	0	15.72	16.00	1	14.93
				1RB High	1 Pos 99	16.00	0	15.72	16.00	1	14.88
				50% RB Low	50 Pos 0	16.00	1	14.63	16.00	2	13.60
	50% RB Mid			50 Pos 24	16.00	1	14.77	16.00	2	13.74	
	50% RB High			50 Pos 50	16.00	1	14.60	16.00	2	13.57	
	100% RB	100 Pos 0	16.00	1	14.60	16.00	2	13.56			
	15 MHz	132047	1717.5	1RB Low	1 Pos 0	16.00	0	15.66	16.00	1	14.98
				1RB Mid	1 Pos 38	16.00	0	15.68	16.00	1	15.00
				1RB High	1 Pos 74	16.00	0	15.70	16.00	1	15.00
				50% RB Low	38 Pos 0	16.00	1	14.70	16.00	2	13.70
				50% RB Mid	38 Pos 19	16.00	1	14.80	16.00	2	13.74
				50% RB High	38 Pos 39	16.00	1	14.83	16.00	2	13.86
		100% RB	75 Pos 0	16.00	1	14.83	16.00	2	13.79		
		132422	1755	1RB Low	1 Pos 0	16.00	0	15.62	16.00	1	15.00
				1RB Mid	1 Pos 38	16.00	0	15.68	16.00	1	15.00
				1RB High	1 Pos 74	16.00	0	15.63	16.00	1	15.00
				50% RB Low	38 Pos 0	16.00	1	14.76	16.00	2	13.77
				50% RB Mid	38 Pos 19	16.00	1	14.78	16.00	2	13.75
				50% RB High	38 Pos 39	16.00	1	14.75	16.00	2	13.77
		100% RB	75 Pos 0	16.00	1	14.82	16.00	2	13.78		
		132597	1772.5	1RB Low	1 Pos 0	16.00	0	15.62	16.00	1	14.95
				1RB Mid	1 Pos 38	16.00	0	15.67	16.00	1	15.00
				1RB High	1 Pos 74	16.00	0	15.64	16.00	1	15.00
				50% RB Low	38 Pos 0	16.00	1	14.69	16.00	2	13.69
	50% RB Mid			38 Pos 19	16.00	1	14.73	16.00	2	13.73	
	50% RB High			38 Pos 39	16.00	1	14.65	16.00	2	13.61	
	100% RB	75 Pos 0	16.00	1	14.69	16.00	2	13.67			
	10 MHz	132022	1715	1RB Low	1 Pos 0	16.00	0	15.78	16.00	1	15.00
				1RB Mid	1 Pos 24	16.00	0	15.74	16.00	1	15.00
				1RB High	1 Pos 49	16.00	0	15.79	16.00	1	15.00
				50% RB Low	25 Pos 0	16.00	1	14.78	16.00	2	13.89
				50% RB Mid	25 Pos 12	16.00	1	14.78	16.00	2	13.83
				50% RB High	25 Pos 24	16.00	1	14.83	16.00	2	13.87
100% RB		50 Pos 0	16.00	1	14.82	16.00	2	13.84			
132422		1755	1RB Low	1 Pos 0	16.00	0	15.77	16.00	1	15.00	
			1RB Mid	1 Pos 24	16.00	0	15.72	16.00	1	15.00	
			1RB High	1 Pos 49	16.00	0	15.79	16.00	1	15.00	
			50% RB Low	25 Pos 0	16.00	1	14.81	16.00	2	13.92	
			50% RB Mid	25 Pos 12	16.00	1	14.83	16.00	2	13.86	
			50% RB High	25 Pos 24	16.00	1	14.82	16.00	2	13.88	
100% RB		50 Pos 0	16.00	1	14.92	16.00	2	13.84			
132622		1775	1RB Low	1 Pos 0	16.00	0	15.75	16.00	1	15.00	
			1RB Mid	1 Pos 24	16.00	0	15.65	16.00	1	15.00	
			1RB High	1 Pos 49	16.00	0	15.74	16.00	1	15.00	
			50% RB Low	25 Pos 0	16.00	1	14.81	16.00	2	13.84	
	50% RB Mid		25 Pos 12	16.00	1	14.76	16.00	2	13.77		
	50% RB High		25 Pos 24	16.00	1	14.68	16.00	2	13.70		
100% RB	50 Pos 0	16.00	1	14.77	16.00	2	13.73				

Band	BW	Channel #	Freq (MHz)	% RB Allocation	RB Position	QPSK			16 QAM		
						Factory Upper Tolerance (dBm)	M P R	Measured Output Power (dBm)	Factory Upper Tolerance (dBm)	M P R	Measured Output Power (dBm)
LTE66	5.0 MHz	131997	1712.5	1RB Low	1 Pos 0	16.00	0	15.87	16.00	1	15.00
				1RB Mid	1 Pos 12	16.00	0	15.81	16.00	1	15.00
				1RB High	1 Pos 24	16.00	0	15.88	16.00	1	15.00
				50% RB Low	12 Pos 0	16.00	1	14.73	16.00	2	13.71
				50% RB Mid	12 Pos 6	16.00	1	14.75	16.00	2	13.74
				50% RB High	12 Pos 11	16.00	1	14.76	16.00	2	13.74
		100% RB	25 Pos 0	16.00	1	14.77	16.00	2	13.81		
		132422	1755	1RB Low	1 Pos 0	16.00	0	15.86	16.00	1	15.00
				1RB Mid	1 Pos 12	16.00	0	15.78	16.00	1	15.00
				1RB High	1 Pos 24	16.00	0	15.88	16.00	1	15.00
				50% RB Low	12 Pos 0	16.00	1	14.78	16.00	2	13.75
				50% RB Mid	12 Pos 6	16.00	1	14.79	16.00	2	13.71
				50% RB High	12 Pos 11	16.00	1	14.75	16.00	2	13.70
		100% RB	25 Pos 0	16.00	1	14.83	16.00	2	13.81		
		132647	1777.5	1RB Low	1 Pos 0	16.00	0	15.81	16.00	1	15.00
				1RB Mid	1 Pos 12	16.00	0	15.80	16.00	1	15.00
				1RB High	1 Pos 24	16.00	0	15.85	16.00	1	15.00
				50% RB Low	12 Pos 0	16.00	1	14.79	16.00	2	13.78
	50% RB Mid			12 Pos 6	16.00	1	14.75	16.00	2	13.70	
	50% RB High			12 Pos 11	16.00	1	14.72	16.00	2	13.64	
	100% RB	25 Pos 0	16.00	1	14.74	16.00	2	13.81			
	3.0 MHz	131987	1711.5	1RB Low	1 Pos 0	16.00	0	15.69	16.00	1	15.00
				1RB Mid	1 Pos 7	16.00	0	15.71	16.00	1	15.00
				1RB High	1 Pos 14	16.00	0	15.66	16.00	1	15.00
				50% RB Low	8 Pos 0	16.00	1	14.71	16.00	2	13.71
				50% RB Mid	8 Pos 4	16.00	1	14.70	16.00	2	13.70
				50% RB High	8 Pos 7	16.00	1	14.74	16.00	2	13.73
		100% RB	15 Pos 0	16.00	1	14.77	16.00	2	13.71		
		132422	1755	1RB Low	1 Pos 0	16.00	0	15.68	16.00	1	15.00
				1RB Mid	1 Pos 7	16.00	0	15.70	16.00	1	15.00
				1RB High	1 Pos 14	16.00	0	15.64	16.00	1	15.00
				50% RB Low	8 Pos 0	16.00	1	14.76	16.00	2	13.78
				50% RB Mid	8 Pos 4	16.00	1	14.76	16.00	2	13.77
				50% RB High	8 Pos 7	16.00	1	14.71	16.00	2	13.75
		100% RB	15 Pos 0	16.00	1	14.72	16.00	2	13.71		
		132657	1778.5	1RB Low	1 Pos 0	16.00	0	15.69	16.00	1	15.00
				1RB Mid	1 Pos 7	16.00	0	15.70	16.00	1	15.00
				1RB High	1 Pos 14	16.00	0	15.64	16.00	1	15.00
				50% RB Low	8 Pos 0	16.00	1	14.74	16.00	2	13.77
	50% RB Mid			8 Pos 4	16.00	1	14.73	16.00	2	13.75	
	50% RB High			8 Pos 7	16.00	1	14.75	16.00	2	13.75	
	100% RB	15 Pos 0	16.00	1	14.78	16.00	2	13.70			
	1.4 MHz	131979	1710	1RB Low	1 Pos 0	16.00	0	15.69	16.00	1	14.71
				1RB Mid	1 Pos 2	16.00	0	15.75	16.00	1	14.82
				1RB High	1 Pos 5	16.00	0	15.71	16.00	1	14.73
				50% RB Low	3 Pos 0	16.00	0	15.62	16.00	1	14.89
				50% RB Mid	3 Pos 1	16.00	0	15.62	16.00	1	14.88
				50% RB High	3 Pos 2	16.00	0	15.66	16.00	1	14.91
100% RB		6 Pos 0	16.00	1	14.72	16.00	2	13.72			
132422		1755	1RB Low	1 Pos 0	16.00	0	15.76	16.00	1	14.79	
			1RB Mid	1 Pos 2	16.00	0	15.80	16.00	1	14.87	
			1RB High	1 Pos 5	16.00	0	15.75	16.00	1	14.80	
			50% RB Low	3 Pos 0	16.00	0	15.68	16.00	1	14.90	
			50% RB Mid	3 Pos 1	16.00	0	15.70	16.00	1	14.92	
			50% RB High	3 Pos 2	16.00	0	15.71	16.00	1	14.94	
100% RB		6 Pos 0	16.00	1	14.76	16.00	2	13.77			
132665		1779.3	1RB Low	1 Pos 0	16.00	0	15.73	16.00	1	14.77	
			1RB Mid	1 Pos 2	16.00	0	15.77	16.00	1	14.82	
			1RB High	1 Pos 5	16.00	0	15.77	16.00	1	14.76	
			50% RB Low	3 Pos 0	16.00	0	15.69	16.00	1	14.93	
	50% RB Mid		3 Pos 1	16.00	0	15.70	16.00	1	14.90		
	50% RB High		3 Pos 2	16.00	0	15.70	16.00	1	14.93		
100% RB	6 Pos 0	16.00	1	14.77	16.00	2	13.77				

A.1.2 LTE UL Carrier Aggregation

(i) Intra-Band Contiguous

UL CA shall be tested based on the worst-case SAR configuration determined from non-CA SAR testing result. The UL CA mode power measurements represent the total power across both carriers.

According to November 2017 TCB workshop, the following needs to be performed: The maximum measured output power, RB allocation, CC offsets, CC channel BWs, MPR, modulation and other relevant information for all UL CA SAR configurations are required in SAR reports to support the test setup and results, including explanations, call box configurations and certain testing restriction

1) When the maximum output for UL CA is \leq standalone LTE mode

- The primary carrier is configured according to the highest standalone SAR configuration tested
- The secondary carrier and subsequent CCs are configured according to procedures used for power measurement and parameters similar to that used for the PCC

2) When the Reported SAR for UL CA configuration, is > 1.2 W/kg, UL CA SAR is also required for all the other test channels.

LTE CA 5B Antenna 5:

Band	Modulation / BW	PCC			SCC			Pwr Avg (dBm)	Factory Upper Tolerance (dBm)
		Ch	Freq (MHz)	RB Allocation	Ch	Freq (MHz)	RB Allocation		
LTE 5B	QPSK / 10MHz	26775	822.5	1RB High	20476	831.6	1RB Low	16.85	17.00

LTE CA 7C Antenna 8:

Band	Modulation / BW	PCC			SCC			Pwr Avg (dBm)	Factory Upper Tolerance (dBm)
		Ch	Freq (MHz)	RB Allocation	Ch	Freq (MHz)	RB Allocation		
LTE 41C	QPSK / 20MHz	20850	2510	1RB High	21100	2535	1RB Low	17.37	18.00

LTE CA 38C Antenna 8:

SAR Measurement for LTE Band 38 TDD (Frequency range: 2570 – 2620MHz) is covered by LTE Band 41 TDD (Frequency range: 2496 – 2690MHz) due to overlapping frequency range, same maximum tune-up and same bandwidth.

LTE CA 41C Antenna 8:

Band	Modulation / BW	PCC			SCC			Pwr Avg (dBm)	Factory Upper Tolerance (dBm)
		Ch	Freq (MHz)	RB Allocation	Ch	Freq (MHz)	RB Allocation		
LTE 41C	QPSK / 20MHz	40521	2583.1	1RB High	40719	2602.9	1RB Low	17.00	17.00

LTE CA 48C Antenna 8:

Band	Modulation / BW	PCC			SCC			Pwr Avg (dBm)	Factory Upper Tolerance (dBm)
		Ch	Freq (MHz)	RB Allocation	Ch	Freq (MHz)	RB Allocation		
LTE 48C	QPSK / 20MHz	55891	3615.1	1RB High	56089	3634.9	1RB Low	13.01	13.50

LTE CA 66B, 66C Antenna 5:

Band	Modulation / BW	PCC			SCC			Pwr Avg (dBm)	Factory Upper Tolerance (dBm)
		Ch	Freq (MHz)	RB Allocation	Ch	Freq (MHz)	RB Allocation		
LTE 66B	QPSK / 10MHz	132373	1750.1	1RB High	132472	1760	1RB Low	19.03	20.00
LTE 66C	QPSK / 20MHz	132323	1745.1	1RB High	132521	1764.9	1RB Low	19.83	20.00

A.1.3 5G NR (FR1)

(i) 5G NR (FR1) Band 2 FDD – Antenna 8

Band	BW (MHz)	Modulation	Mode	RB Allocation	RB Offset	Factory upper tolerance (dBm)	Measured Output Power (dBm)					
							Frequency (MHz) / Channel					
							1860	1880	1900			
NR2	20	DFS-s OFDM	PI/2 BPSK	1RB Low	0	16.00	15.47	15.55	15.63			
			QPSK	1RB Low	0	16.00	15.47	15.57	15.63			
				1RB Mid	50	16.00	15.53	15.92	15.53			
				1RB High	99	16.00	15.50	15.77	15.71			
				50% RB Low	0	16.00	15.56	15.62	15.69			
				50% RB Mid	25	16.00	15.58	15.87	15.73			
				50% RB High	49	16.00	15.69	15.88	15.73			
				100% RB	0	16.00	15.57	15.78	15.70			
			16QAM	1RB Low	0	16.00	15.68	15.78	15.87			
			64QAM	1RB Low	0	16.00	15.50	15.58	15.63			
			256QAM	1RB Low	0	16.00	15.60	15.66	15.73			
			CP-OFDM	QPSK	1RB Low	0	16.00	15.57	15.68	15.73		
										Frequency (MHz) / Channel		
										1857.5	1880	1902.5
								371500	376000	380500		
	15	DFS-s OFDM	QPSK	1RB Low	0	16.00	15.55	15.71	15.67			
				50% RB Low	0	16.00	15.56	15.79	15.60			
								Frequency (MHz) / Channel				
								1855	1880	1905		
								371000	376000	381000		
	10	DFS-s OFDM	QPSK	1RB Low	0	16.00	15.43	15.68	15.51			
				50% RB Low	0	16.00	15.40	15.61	15.52			
								Frequency (MHz) / Channel				
								1852.5	1880	1907.5		
								370500	376000	381500		
	5	DFS-s OFDM	QPSK	1RB Low	0	16.00	15.50	15.84	15.61			
				50% RB Low	0	16.00	15.54	15.80	15.66			

(ii) 5G NR (FR1) Band 5 FDD – Antenna 5

Band	BW (MHz)	Modulation	Mode	RB Allocation	RB Offset	Factory upper tolerance (dBm)	Measured Output Power (dBm)						
							Frequency (MHz) / Channel						
							834	836.5	839				
							166800	167300	167800				
NR5	20	DFS-s OFDM	PI/2 BPSK	1RB Low	0	17.00	16.32	16.28	16.32				
			QPSK	1RB Low	0	17.00	16.33	16.28	16.35				
				1RB Mid	50	17.00	16.30	16.31	16.34				
				1RB High	99	17.00	16.28	16.22	16.16				
				50% RB Low	0	17.00	16.33	16.30	16.35				
				50% RB Mid	25	17.00	16.38	16.41	16.42				
				50% RB High	49	17.00	16.30	16.34	16.36				
				100% RB	0	17.00	16.33	16.36	16.39				
			16QAM	1RB Low	0	17.00	16.55	16.50	16.57				
			64QAM	1RB Low	0	17.00	16.50	16.51	16.41				
	256QAM	1RB Low	0	17.00	16.49	16.49	16.41						
	CP-OFDM	QPSK	1RB Low	0	17.00	16.34	16.31	16.32					
								Frequency (MHz) / Channel					
								1857.5	1880	1880			
								371500	376000	380500			
	15	DFS-s OFDM	QPSK	1RB Low	0	17.00	16.37	16.36	16.40				
				50% RB Low	0	17.00	16.40	16.37	16.47				
											Frequency (MHz) / Channel		
											1855	1880	1905
								371000	376000	381000			
	10	DFS-s OFDM	QPSK	1RB Low	0	17.00	16.31	16.27	16.25				
				50% RB Low	0	17.00	16.22	16.23	16.29				
								Frequency (MHz) / Channel					
								1852.5	1880	1907.5			
								370500	376000	381500			
	5	DFS-s OFDM	QPSK	1RB Low	0	17.00	16.39	16.41	16.32				
				50% RB Low	0	17.00	16.39	16.47	16.32				

(iii) 5G NR (FR1) Band 7 FDD – Antenna 5

Band	BW (MHz)	Modulation	Mode	RB Allocation	RB Offset	Factory upper tolerance (dBm)	Measured Output Power (dBm)			
							Frequency (MHz) / Channel			
							2510	2535	2560	
NR7	20	DFS-s OFDM	PI/2 BPSK	1RB Low	0	18.00	17.36	17.45	17.49	
			QPSK	1RB Low	0	18.00	17.34	17.47	17.56	
				1RB Mid	50	18.00	17.44	17.52	17.61	
				1RB High	99	18.00	17.38	17.48	17.69	
				50% RB Low	0	18.00	17.42	17.59	17.63	
				50% RB Mid	25	18.00	17.50	17.59	17.68	
				50% RB High	49	18.00	17.51	17.55	17.75	
			100% RB	0	18.00	17.46	17.62	17.70		
			16QAM	1RB Low	0	18.00	17.46	17.58	17.69	
			64QAM	1RB Low	0	18.00	17.12	17.20	17.29	
	256QAM	1RB Low	0	18.00	17.57	17.68	17.75			
	CP-OFDM	QPSK	1RB Low	0	18.00	17.28	17.39	17.47		
								Frequency (MHz) / Channel		
								2507.5	2535	2562.5
								501500	507000	512500
	15	DFS-s OFDM	QPSK	1RB Low	0	18.00	17.40	17.58	17.64	
				50% RB Low	0	18.00	17.44	17.56	17.68	
								Frequency (MHz) / Channel		
								2505	2535	2565
								501000	507000	513000
	10	DFS-s OFDM	QPSK	1RB Low	0	18.00	17.31	17.39	17.50	
50% RB Low				0	18.00	17.25	17.41	17.50		
							Frequency (MHz) / Channel			
							2502.5	2535	2567.5	
							500500	507000	513500	
5	DFS-s OFDM	QPSK	1RB Low	0	18.00	17.42	17.56	17.66		
			50% RB Low	0	18.00	17.42	17.60	17.82		

(iv) 5G NR (FR1) Band 25 FDD – Antenna 5

Band	BW (MHz)	Modulation	Mode	RB Allocation	RB Offset	Factory upper tolerance (dBm)	Measured Output Power (dBm)			
							Frequency (MHz) / Channel			
							1860	1880	1905	
NR25	20	DFS-s OFDM	PI/2 BPSK	1RB Low	0	17.50	16.82	16.90	17.03	
			QPSK	1RB Low	0	17.50	16.82	16.96	17.05	
				1RB Mid	50	17.50	16.83	17.11	17.12	
				1RB High	99	17.50	16.87	17.08	17.12	
				50% RB Low	0	17.50	16.97	16.91	17.10	
				50% RB Mid	25	17.50	16.95	17.17	17.23	
				50% RB High	49	17.50	16.96	17.10	17.16	
				100% RB	0	17.50	16.97	17.06	17.20	
			16QAM	1RB Low	0	17.50	16.98	17.13	17.26	
			64QAM	1RB Low	0	17.50	16.67	16.76	17.00	
			256QAM	1RB Low	0	17.50	17.07	17.16	17.28	
			CP-OFDM	QPSK	1RB Low	0	17.50	16.83	16.94	17.07
								Frequency (MHz) / Channel		
								1857.5	1880	1907.5
								371500	376500	38100
	15	DFS-s OFDM	QPSK	1RB Low	0	17.50	16.87	17.03	17.12	
				50% RB Low	0	17.50	16.95	17.12	17.31	
								Frequency (MHz) / Channel		
								1855	1880	1910
								371000	376500	382000
	10	DFS-s OFDM	QPSK	1RB Low	0	17.50	16.71	16.94	17.01	
				50% RB Low	0	17.50	16.69	16.95	17.17	
								Frequency (MHz) / Channel		
								1852.5	1882.5	1912.5
								370500	376500	382500
5	DFS-s OFDM	QPSK	1RB Low	0	17.50	16.82	17.09	17.14		
			50% RB Low	0	17.50	16.88	17.18	17.27		

(v) 5G NR (FR1) Band 30 FDD – Antenna 5

Band	BW (MHz)	Modulation	Mode	RB Allocation	RB Offset	Factory upper tolerance (dBm)	Measured Output Power (dBm)								
							Frequency (MHz) / Channel								
NR30	10	DFS-s OFDM	PI/2 BPSK	1RB Low	0	17.00	2310	46200	16.55						
			QPSK	1RB Low	0	17.00				16.60					
				1RB Mid	25	17.00				16.44					
				1RB High	49	17.00				16.39					
				50% RB Low	0	17.00				16.44					
				50% RB Mid	12	17.00				16.49					
				50% RB High	25	17.00				16.29					
				100% RB	0	17.00				16.39					
			16QAM	1RB Low	0	17.00				16.77					
			64QAM	1RB Low	0	17.00				16.43					
			256QAM	1RB Low	0	17.00				16.82					
			CP-OFDM	QPSK	1RB Low	0				17.00	16.60				
										Frequency (MHz) / Channel					
										2310					
								46200							
5	DFS-s OFDM	QPSK	1RB Low	0	17.00	16.67									
			50% RB Low	0	17.00	16.75									

(vi) 5G NR (FR1) Band 38 TDD – Antenna 5

SAR Measurement for 5G NR Band 38 TDD (Frequency range: 2570 – 2620MHz) is covered by 5G NR Band 41 TDD (Frequency range: 2496 – 2690MHz) due to overlapping frequency range, same maximum tune-up, and same bandwidth.

(vii) 5G NR (FR1) Band 38 TDD – Antenna 8

Band	BW	Modulation	Mode	RB Allocation	RB Offset	Factory upper tolerance (dBm)	Measured Output Power (dBm)								
							Frequency (MHz) / Channel								
							2590	2595	2600						
NR38	40	DFS-s OFDM	PI/2 BPSK	1RB Low	0	18.00	518000	519000	520000						
			QPSK	1RB Low	0	18.00				17.15					
				1RB Mid	136	18.00				17.14					
				1RB High	270	18.00				17.72					
				50% RB Low	0	18.00				17.29					
				50% RB Mid	68	18.00				17.62					
				50% RB High	137	18.00				17.69					
				100% RB	0	18.00				17.65					
				16QAM	1RB Low	0				18.00	17.61				
			64QAM	1RB Low	0	18.00				17.42					
			256QAM	1RB Low	0	18.00				17.16					
			CP-OFDM	QPSK	1RB Low	0				18.00	17.29				
										Frequency (MHz) / Channel					
										2590	2595	2600			
								518000	519000	520000					
	20	DFS-s OFDM	QPSK	1RB Low	0	18.00	518000	519000	520000						
				50% RB Low	0	18.00				17.63					
								Frequency (MHz) / Channel							
								2577.5	2595	2612.5					
								515500	519000	522500					
	15	DFS-s OFDM	QPSK	1RB Low	0	18.00	515500	519000	522500						
				50% RB Low	0	18.00				17.69					
								Frequency (MHz) / Channel							
								2575	2595	2615					
								515000	519000	523000					
	10	DFS-s OFDM	QPSK	1RB Low	0	18.00	515000	519000	523000						
				50% RB Low	0	18.00				17.75					
								Frequency (MHz) / Channel							
							2572.5	2595	2617.5						
							514500	519000	523500						
5	DFS-s OFDM	QPSK	1RB Low	0	18.00	514500	519000	523500							
			50% RB Low	0	18.00				17.64						
							Frequency (MHz) / Channel								
							2572.5	2595	2617.5						
							514500	519000	523500						

(viii) 5G NR (FR1) Band 41 TDD – Antenna 5

Band	BW	Modulation	Mode	RB Allocation	RB Offset	Factory upper tolerance (dBm)	Measured Output Power (dBm) Antenna 8					
							Frequency (MHz) / Channel					
							2546	2569.5	2593	2616.5	2640	
							509200	513900	518600	523300	528000	
NR41	100	DFS-s OFDM	PI/2 BPSK	1RB Low	0	19.50			18.20			
			QPSK	1RB Low	0	19.50			18.26			
				1RB Mid	136	19.50			19.14			
				1RB High	270	19.50			19.36			
				50% RB Low	0	19.50			18.99			
				50% RB Mid	68	19.50			19.37			
				50% RB High	137	19.50			19.50			
				100% RB	0	19.50			19.16			
			16QAM	1RB Low	0	19.50			18.30			
			64QAM	1RB Low	0	19.50			18.18			
	256QAM	1RB Low	0	19.50			18.31					
	CP-OFDM	QPSK	1RB Low	0	19.50			18.13				
								Frequency (MHz) / Channel				
								2541	2567	2593	2619	19.50
								508200	513400	518600	523800	19.50
	90	DFS-s OFDM	QPSK	1RB Low	0	19.50			18.23			
				50% RB Low	0	19.50			18.83			
								Frequency (MHz) / Channel				
								2536	2564.5	2593	2621.5	19.50
								507200	512900	518600	524300	19.50
	80	DFS-s OFDM	QPSK	1RB Low	0	19.50			18.27			
				50% RB Low	0	19.50			18.75			
								Frequency (MHz) / Channel				
								2526	2559.5	2593	2626.5	19.50
								505200	511900	518600	525300	19.50
	60	DFS-s OFDM	QPSK	1RB Low	0	19.50			18.20			
				50% RB Low	0	19.50			18.86			
								Frequency (MHz) / Channel				
								2521	2557	2593	2629	19.50
								504200	511400	518600	525800	19.50
50	DFS-s OFDM	QPSK	1RB Low	0	19.50			18.34				
			50% RB Low	0	19.50			18.83				
							Frequency (MHz) / Channel					
							2516	2554.5	2593	2631.5	19.50	
							503200	510900	518600	526300	19.50	
40	DFS-s OFDM	QPSK	1RB Low	0	19.50			18.34				
			50% RB Low	0	19.50			18.68				
							Frequency (MHz) / Channel					
							2506	2549.5	2593	2636.5	19.50	
							501200	509900	518600	527300	19.50	
20	DFS-s OFDM	QPSK	1RB Low	0	19.50			19.50				
			50% RB Low	0	19.50			18.94				

(ix) 5G NR (FR1) Band 41 TDD – Antenna 8

Band	BW	Modulation	Mode	RB Allocation	RB Offset	Factory upper tolerance (dBm)	Measured Output Power (dBm) Antenna 8					
							Frequency (MHz) / Channel					
							2546	2569.5	2593	2616.5	2640	
NR41	100	DFS-s OFDM	PI/2 BPSK	1RB Low	0	17.50			16.66			
			QPSK	1RB Low	0	17.50			16.68			
				1RB Mid	136	17.50			17.48			
				1RB High	270	17.50			16.78			
				50% RB Low	0	17.50			17.43			
				50% RB Mid	68	17.50			17.50			
				50% RB High	137	17.50			17.41			
				100% RB	0	17.50			17.37			
			16QAM	1RB Low	0	17.50			16.90			
			64QAM	1RB Low	0	17.50			16.81			
	256QAM	1RB Low	0	17.50			16.80					
	CP-OFDM	QPSK	1RB Low	0	17.50			16.88				
								Frequency (MHz) / Channel				
								2541	2567	2593	2619	2645
								508200	513400	518600	523800	529000
	90	DFS-s OFDM	QPSK	1RB Low	0	17.50			16.91			
				50% RB Low	0	17.50			17.42			
								Frequency (MHz) / Channel				
								2536	2564.5	2593	2621.5	2650
								507200	512900	518600	524300	530000
	80	DFS-s OFDM	QPSK	1RB Low	0	17.50			16.97			
				50% RB Low	0	17.50			17.34			
								Frequency (MHz) / Channel				
								2526	2559.5	2593	2626.5	2660
								505200	511900	518600	525300	532000
	60	DFS-s OFDM	QPSK	1RB Low	0	17.50			17.17			
				50% RB Low	0	17.50			17.47			
								Frequency (MHz) / Channel				
							2521	2557	2593	2629	2665	
							504200	511400	518600	525800	5330000	
50	DFS-s OFDM	QPSK	1RB Low	0	17.50			17.04				
			50% RB Low	0	17.50			17.22				
							Frequency (MHz) / Channel					
							2516	2554.5	2593	2631.5	2670	
							503200	510900	518600	526300	534000	
40	DFS-s OFDM	QPSK	1RB Low	0	17.50			16.74				
			50% RB Low	0	17.50			17.19				
							Frequency (MHz) / Channel					
							2506	2549.5	2593	2636.5	2680	
							501200	509900	518600	527300	536000	
20	DFS-s OFDM	QPSK	1RB Low	0	17.50			17.30				
			50% RB Low	0	17.50			17.39				

(x) 5G NR (FR1) Band 66 FDD – Antenna 5

Band	BW	Modulation	Mode	RB Allocation	RB Offset	Factory upper tolerance (dBm)	Measured Output Power (dBm)			
							Frequency (MHz) / Channel			
							1730	1745	1760	
NR66	40	DFS-s OFDM	PI/2 BPSK	1RB Low	0	20.00	346000	349000	352000	
			QPSK	1RB Low	0	20.00				19.08
				1RB Mid	136	20.00				19.13
				1RB High	270	20.00				19.43
				50% RB Low	0	20.00				18.97
				50% RB Mid	68	20.00				19.30
				50% RB High	137	20.00				19.42
				100% RB	0	20.00				19.21
			16QAM	1RB Low	0	20.00				19.19
			64QAM	1RB Low	0	20.00				19.34
			256QAM	1RB Low	0	20.00				18.98
			CP-OFDM	QPSK	1RB Low	0				20.00
								19.09		
								Frequency (MHz) / Channel		
								1720	1745	1770
								344000	349000	354000
		20	DFS-s OFDM	QPSK	1RB Low	0	20.00			
					50% RB Low	0	20.00			
										19.53
								Frequency (MHz) / Channel		
								1717.5	1745	1772.5
								343500	349000	354500
		15	DFS-s OFDM	QPSK	1RB Low	0	20.00			
					50% RB Low	0	20.00			
										19.63
								Frequency (MHz) / Channel		
								1715	1745	1775
								343000	349000	355000
		10	DFS-s OFDM	QPSK	1RB Low	0	20.00			
					50% RB Low	0	20.00			
									19.44	
							Frequency (MHz) / Channel			
							1712.5	1745	1745	
							342500	349000	355500	
	5	DFS-s OFDM	QPSK	1RB Low	0	20.00				
				50% RB Low	0	20.00				19.52
									19.56	

(xi) 5G NR (FR1) Band 66 FDD – Antenna 8

Band	BW	Modulation	Mode	RB Allocation	RB Offset	Factory upper tolerance (dBm)	Measured Output Power (dBm)			
							Frequency (MHz) / Channel			
							1730	1745	1760	
NR66	40	DFS-s OFDM	PI/2 BPSK	1RB Low	0	16.00	346000	349000	352000	
			QPSK	1RB Low	0	16.00				15.32
				1RB Mid	136	16.00				15.35
				1RB High	270	16.00				15.64
				50% RB Low	0	16.00				15.07
				50% RB Mid	68	16.00				15.43
				50% RB High	137	16.00				15.65
				100% RB	0	16.00				15.39
			16QAM	1RB Low	0	16.00				15.38
			64QAM	1RB Low	0	16.00				15.52
			256QAM	1RB Low	0	16.00				15.37
			CP-OFDM	QPSK	1RB Low	0				16.00
								Frequency (MHz) / Channel		
								1720	1745	1770
								344000	349000	354000
	20	DFS-s OFDM	QPSK	1RB Low	0	16.00				15.81
				50% RB Low	0	16.00				15.74
								Frequency (MHz) / Channel		
								1717.5	1745	1772.5
								343500	349000	354500
	15	DFS-s OFDM	QPSK	1RB Low	0	16.00				15.80
				50% RB Low	0	16.00				15.79
								Frequency (MHz) / Channel		
								1715	1745	1775
								343000	349000	355000
	10	DFS-s OFDM	QPSK	1RB Low	0	16.00				15.60
				50% RB Low	0	16.00				15.62
							Frequency (MHz) / Channel			
							1712.5	1745	1745	
							342500	349000	355500	
5	DFS-s OFDM	QPSK	1RB Low	0	16.00				15.72	
			50% RB Low	0	16.00				15.73	

(xii) 5G NR (FR1) Band 77 TDD – Antenna 5

Band	B W	Modulation	Mode	RB Allocation	RB Offset	Factory upper tolerance (dBm)	Measured Output Power (dBm) Antenna 8						
							Frequency (MHz) / Channel						
							3840	3795	3750	3885	3930		
NR77	10 0	DFS-s OFDM	PI/2 BPSK	1RB Low	0	15.50	656600	653000	650000	659000	662000	14.86	
			QPSK	1RB Low	0	15.50						14.92	
				1RB Mid	136	15.50						15.25	
				1RB High	270	15.50						14.53	
				50% RB Low	0	15.50						15.39	
				50% RB Mid	68	15.50						15.48	
				50% RB High	137	15.50						15.22	
				100% RB	0	15.50						15.19	
			16QAM	1RB Low	0	15.50						15.03	
			64QAM	1RB Low	0	15.50						14.79	
		256QAM	1RB Low	0	15.50	15.08							
		CP-OFDM	QPSK	1RB Low	0	15.50	14.89						
									Frequency (MHz) / Channel				
								3840	3795	3750	3885	3930	
								656600	653000	650000	659000	662000	
	90	DFS-s OFDM	QPSK	1RB Low	0	15.50						15.08	
				50% RB Low	0	15.50						15.46	
								Frequency (MHz) / Channel					
								3840	3795	3750	3885	3930	
								656600	653000	650000	659000	662000	
	80	DFS-s OFDM	QPSK	1RB Low	0	15.50						15.16	
				50% RB Low	0	15.50						15.48	
								Frequency (MHz) / Channel					
								3840	3795	3750	3885	3930	
								656600	653000	650000	659000	662000	
	60	DFS-s OFDM	QPSK	1RB Low	0	15.50						14.99	
				50% RB Low	0	15.50						15.18	
								Frequency (MHz) / Channel					
							3840	3795	3750	3885	3930		
							656600	653000	650000	659000	662000		
50	DFS-s OFDM	QPSK	1RB Low	0	15.50						14.89		
			50% RB Low	0	15.50						15.14		
							Frequency (MHz) / Channel						
							3840	3795	3750	3885	3930		
							656600	653000	650000	659000	662000		
40	DFS-s OFDM	QPSK	1RB Low	0	15.50						14.66		
			50% RB Low	0	15.50						15.05		
							Frequency (MHz) / Channel						
							3840	3795	3750	3885	3930		
							656600	653000	650000	659000	662000		
20	DFS-s OFDM	QPSK	1RB Low	0	15.50						15.11		
			50% RB Low	0	15.50						15.30		

(xiii) 5G NR (FR1) Band 77 TDD – Antenna 8

Band	BW	Modulation	Mode	RB Allocation	RB Offset	Factory upper tolerance (dBm)	Measured Output Power (dBm) Antenna 8						
							Frequency (MHz) / Channel						
							3840	3795	3750	3885	3930		
NR77	100	DFS-s OFDM	PI/2 BPSK	1RB Low	0	14.00	656600	653000	650000	659000	662000	13.37	
			QPSK	1RB Low	0	14.00						13.39	
				1RB Mid	136	14.00						13.94	
				1RB High	270	14.00						13.20	
				50% RB Low	0	14.00						13.93	
				50% RB Mid	68	14.00						13.96	
				50% RB High	137	14.00						13.78	
				100% RB	0	14.00						13.91	
			16QAM	1RB Low	0	14.00						13.68	
			64QAM	1RB Low	0	14.00						13.36	
	256QAM	1RB Low	0	14.00	13.53								
	CP-OFDM	QPSK	1RB Low	0	14.00	13.42							
								Frequency (MHz) / Channel					
								3840	3795	3750	3885	3930	
								656600	653000	650000	659000	662000	
	90	DFS-s OFDM	QPSK	1RB Low	0	14.00						13.52	
				50% RB Low	0	14.00						13.99	
								Frequency (MHz) / Channel					
								3840	3795	3750	3885	3930	
								656600	653000	650000	659000	662000	
80	DFS-s OFDM	QPSK	1RB Low	0	14.00						13.62		
			50% RB Low	0	14.00						14.00		
							Frequency (MHz) / Channel						
							3840	3795	3750	3885	3930		
							656600	653000	650000	659000	662000		
60	DFS-s OFDM	QPSK	1RB Low	0	14.00						13.56		
			50% RB Low	0	14.00						13.74		
							Frequency (MHz) / Channel						
							3840	3795	3750	3885	3930		
							656600	653000	650000	659000	662000		
50	DFS-s OFDM	QPSK	1RB Low	0	14.00								
			50% RB Low	0	14.00								
							Frequency (MHz) / Channel						
							3840	3795	3750	3885	3930		
							656600	653000	650000	659000	662000		
40	DFS-s OFDM	QPSK	1RB Low	0	14.00						13.44		
			50% RB Low	0	14.00						13.63		
							Frequency (MHz) / Channel						
							3840	3795	3750	3885	3930		
							656600	653000	650000	659000	662000		
20	DFS-s OFDM	QPSK	1RB Low	0	14.00						13.64		
			50% RB Low	0	14.00						13.80		

(xiv) 5G NR (FR1) Band 78 TDD – Antenna 5

Band	BW	Modulation	Mode	RB Allocation	RB Offset	Factory upper tolerance (dBm)	Measured Output Power (dBm) Antenna 8					
							Frequency (MHz) / Channel					
							3840	3795	3750	3885	3930	
							656600	653000	650000	659000	662000	
NR78	100	DFS-s OFDM	PI/2 BPSK	1RB Low	0	16.00			14.67			
			QPSK	1RB Low	0	16.00			14.63			
				1RB Mid	136	16.00			14.78			
				1RB High	270	16.00			14.57			
				50% RB Low	0	16.00			15.07			
				50% RB Mid	68	16.00			15.15			
				50% RB High	137	16.00			15.19			
				100% RB	0	16.00			14.98			
			16QAM	1RB Low	0	16.00			14.80			
			64QAM	1RB Low	0	16.00			14.48			
	256QAM	1RB Low	0	16.00			14.94					
	CP-OFDM	QPSK	1RB Low	0	16.00			14.58				
								Frequency (MHz) / Channel				
								3840	3795	3750	3885	3930
							656600	653000	650000	659000	662000	
	90	DFS-s OFDM	QPSK	1RB Low	0	16.00			14.76			
				50% RB Low	0	16.00			15.04			
							Frequency (MHz) / Channel					
							3840	3795	3750	3885	3930	
							656600	653000	650000	659000	662000	
	80	DFS-s OFDM	QPSK	1RB Low	0	16.00			14.82			
				50% RB Low	0	16.00			15.05			
							Frequency (MHz) / Channel					
							3840	3795	3750	3885	3930	
							656600	653000	650000	659000	662000	
	60	DFS-s OFDM	QPSK	1RB Low	0	16.00			14.85			
				50% RB Low	0	16.00			15.02			
							Frequency (MHz) / Channel					
							3840	3795	3750	3885	3930	
							656600	653000	650000	659000	662000	
	50	DFS-s OFDM	QPSK	1RB Low	0	16.00			14.73			
				50% RB Low	0	16.00			14.92			
							Frequency (MHz) / Channel					
							3840	3795	3750	3885	3930	
							656600	653000	650000	659000	662000	
	40	DFS-s OFDM	QPSK	1RB Low	0	16.00			14.45			
				50% RB Low	0	16.00			14.82			
							Frequency (MHz) / Channel					
							3840	3795	3750	3885	3930	
							656600	653000	650000	659000	662000	
	20	DFS-s OFDM	QPSK	1RB Low	0	16.00			14.78			
				50% RB Low	0	16.00			15.03			

(xv) 5G NR (FR1) Band 78 TDD – Antenna 8

Band	BW	Modulation	Mode	RB Allocation	RB Offset	Factory upper tolerance (dBm)	Measured Output Power (dBm) Antenna 8						
							Frequency (MHz) / Channel						
							3840	3795	3750	3885	3930		
NR78	100	DFS-s OFDM	PI/2 BPSK	1RB Low	0	13.50	656600	653000	650000	659000	662000	13.15	
			QPSK	1RB Low	0	13.50						13.11	
				1RB Mid	136	13.50						13.32	
				1RB High	270	13.50						13.03	
				50% RB Low	0	13.50						13.35	
				50% RB Mid	68	13.50						13.49	
				50% RB High	137	13.50						13.38	
				100% RB	0	13.50						13.34	
			16QAM	1RB Low	0	13.50						13.32	
			64QAM	1RB Low	0	13.50						13.03	
			256QAM	1RB Low	0	13.50						13.11	
			CP-OFDM	QPSK	1RB Low	0						13.50	13.09
								Frequency (MHz) / Channel					
								3840	3795	3750	3885	3930	
								656600	653000	650000	659000	662000	
	90	DFS-s OFDM	QPSK	1RB Low	0	13.50	656600	653000	650000	659000	662000	13.28	
				50% RB Low	0	13.50						13.41	
									Frequency (MHz) / Channel				
									3840	3795	3750	3885	3930
									656600	653000	650000	659000	662000
		80	DFS-s OFDM	QPSK	1RB Low	0	13.50	656600	653000	650000	659000	662000	13.19
					50% RB Low	0	13.50						13.44
									Frequency (MHz) / Channel				
									3840	3795	3750	3885	3930
									656600	653000	650000	659000	662000
		60	DFS-s OFDM	QPSK	1RB Low	0	13.50	656600	653000	650000	659000	662000	13.22
					50% RB Low	0	13.50						13.36
								Frequency (MHz) / Channel					
							3840	3795	3750	3885	3930		
							656600	653000	650000	659000	662000		
50	DFS-s OFDM	QPSK	1RB Low	0	13.50	656600	653000	650000	659000	662000	13.07		
			50% RB Low	0	13.50						13.22		
							Frequency (MHz) / Channel						
							3840	3795	3750	3885	3930		
							656600	653000	650000	659000	662000		
40	DFS-s OFDM	QPSK	1RB Low	0	13.50	656600	653000	650000	659000	662000	12.80		
			50% RB Low	0	13.50						13.17		
							Frequency (MHz) / Channel						
							3840	3795	3750	3885	3930		
							656600	653000	650000	659000	662000		
20	DFS-s OFDM	QPSK	1RB Low	0	13.50	656600	653000	650000	659000	662000	12.80		
			50% RB Low	0	13.50						13.17		

(xvi) 5G NR (FR1) UL Carrier Aggregation

For NR ULCA mode, each carrier transmits on separate antennas. Each exposure has been measured separately. For each, the highest standalone SAR conditions are added to derive the Total SAR. Refer to paragraph A.4.5

A.2 Tissue Parameters Measurement

Body TSL SAR System 2

Body TSL	Target TSL		Measured TSL		Deviation %		Date
Freq (MHz)	ϵ' (F/m)	σ (S/m)	ϵ' (F/m)	σ (S/m)	Deviation ϵ'	Deviation σ	
750	55.53	0.96	55.59	0.91	0.11	-5.21	2022-08-16
835	55.15	0.99	55.36	0.95	0.38	-4.04	2022-08-16
	55.15	0.99	57.32	0.97	3.93	-2.02	2022-08-23
1750	53.43	1.49	52.3	1.4	-2.11	-6.04	2022-08-10
	53.43	1.49	53.95	1.44	0.97	-3.36	2022-08-16
1900	53.3	1.52	52.13	1.5	-2.2	-1.32	2022-08-10
	53.3	1.52	53.75	1.54	0.84	1.32	2022-08-16
2300	52.9	1.81	53.22	1.87	0.6	3.31	2022-08-16
2600	52.51	2.16	51.13	2.1	-2.63	-2.78	2022-08-10
3700	51.05	3.55	50.68	3.35	-0.72	-5.63	2022-08-10

Body TSL SAR System 3

Body TSL	Target TSL		Measured TSL		Deviation %		Date
Freq (MHz)	ϵ' (F/m)	σ (S/m)	ϵ' (F/m)	σ (S/m)	Deviation ϵ'	Deviation σ	
835	53.43	1.49	53.22	1.50	-0.39	0.67	2022-08-29
1750	53.30	1.52	53.01	1.60	-0.54	5.26	2022-08-29
1900	52.90	1.81	52.42	1.92	-0.91	6.08	2022-08-29
2300	52.51	2.16	51.86	2.23	-1.24	3.24	2022-08-29
2600	51.05	3.55	49.05	3.42	-3.92	-3.66	2022-08-29
3700	50.78	3.78	48.69	3.66	-4.12	-3.17	2022-08-29

See *Annex C* below for more details.

A.3 System Check Measurements

Body Measurements SAR System #2

Frequency (MHz)	Average	Target SAR (W/kg)	Measured SAR (W/kg)	Deviation to target (%)	Limit (%)	Date	
750	1g	8.75	8.64	-1.26	±10	2022-08-16	
	10g	5.72	5.80	1.40			
835	1g	9.65	10.08	4.46		2022-08-16	
	10g	6.32	6.60	4.43			
	1g	9.65	9.62	-0.31			2022-08-25
	10g	6.32	6.36	0.63			
1750	1g	37.10	34.00	-8.36		2022-08-10	
	10g	19.60	18.16	-7.35			
	1g	37.10	33.80	-8.89			2022-08-17
	10g	19.60	18.16	-7.35			
1900	1g	40.30	38.40	-4.71		2022-08-10	
	10g	21.00	20.20	-3.81			
	1g	40.30	39.80	-1.24			2022-08-16
	10g	21.00	20.80	-0.95			
2300	1g	47.90	47.20	-1.46		2022-08-16	
	10g	23.20	22.80	-1.72			
2600	1g	54.10	51.20	-5.36	2022-08-11		
	10g	24.10	23.00	-4.56			
3700	1g	62.10	64.60	4.03	2022-08-11		
	10g	22.20	23.80	7.21			

Body Measurements SAR System #3

Frequency (MHz)	Average	Target SAR (W/kg)	Measured SAR (W/kg)	Deviation to target (%)	Limit (%)	Date	
835	1g	9.65	10.60	9.84	±10	2022-08-29	
	10g	6.32	6.80	7.59			
1750	1g	37.10	36.80	-0.81		2022-08-29	
	10g	19.60	19.48	-0.61			
1900	1g	40.30	42.60	5.71		2022-08-29	
	10g	21.00	22.00	4.76			
	1g	40.30	42.20	4.71			2022-08-30
	10g	21.00	21.80	3.81			
2300	1g	47.90	46.40	-3.13		2022-08-29	
	10g	23.20	22.00	-5.17			
2600	1g	54.10	52.40	-3.14		2022-08-29	
	10g	24.10	23.20	-3.73			
	1g	54.10	51.40	-4.99			2022-08-30
	10g	24.10	22.60	-6.22			
	1g	54.10	51.00	-5.73			2022-08-31
	10g	24.10	22.40	-7.05			
3700	1g	62.10	60.60	-2.42	2022-08-30		
	10g	22.20	22.00	-0.90			

A.4 SAR Test Results

A.4.1 WCDMA

(i) WCDMA Band II

Band	Antenna	BW (MHz)	Mod.	Channel Number	Freq (MHz)	Position	Scaling Factor (dB)	Measured SAR 1g (W/kg)	Reported SAR 1g (W/kg)	Plot #
Band II	Ant 5	5	RMC 12.2kbps	9400	1880	Back Face	0.46	0.51	0.56	
						Top Edge	0.46	0.52	0.58	1

(ii) WCDMA Band IV

Band	Antenna	BW (MHz)	Mod.	Channel Number	Freq (MHz)	Position	Scaling Factor (dB)	Measured SAR 1g (W/kg)	Reported SAR 1g (W/kg)	Plot #
Band IV	Ant 5	5	RMC 12.2kbps	1413	1732.5	Back Face	0.21	0.29	0.30	
						Top Edge	0.21	0.34	0.35	2

(iii) WCDMA Band V

Band	Antenna	BW (MHz)	Mod.	Channel Number	Freq (MHz)	Position	Scaling Factor (dB)	Measured SAR 1g (W/kg)	Reported SAR 1g (W/kg)	Plot #
Band V	Ant 5	5	RMC 12.2kbps	4183	836.6	Back Face	0.51	0.69	0.77	3
						Top Edge	0.51	0.24	0.27	

A.4.2 LTE

LTE UL CA 5B

UL CA shall be tested based on the worst-case SAR configuration determined from non-CA SAR testing result. The channel BW, channel number, RB allocation, etc. would be selected to allow contiguous CA of PCC and SCC. Uplink output power for UL CA is the total power measured across the PCC and SCC.

From table on standalone testing on LTE Band 26, which on standalone covers band LTE 5, back face position was chosen as the configurations that give the highest SAR, thus, the same is used for UL CA testing.

Band	Ant.	Modulation / BW	PCC			SCC			Position	Scaling Factor (dB)	Measured SAR 1g (W/Kg)	Reported SAR 1g (W/Kg)
			Ch	Freq (MHz)	RB Allocation	Ch	Freq (MHz)	RB Allocation				
LTE 5B	Ant 5	QPSK / 10MHz	20850	2510	1RB High	21100	2535	1RB Low	Back face	0.15	0.32	0.33

PCC RB allocation settings for UL CA have been adjusted based on the worst-case power

(i) LTE Band 7 FDD

Band	Antenna	BW (MHz)	Mod.	Channel Number	Freq (MHz)	Position	% RB Allocation	Scaling Factor (dB)	Measured SAR 1g (W/kg)	Reported SAR 1g (W/kg)	Plot #
LTE 7	Ant 5	20	QPSK	21100	2535	Back Face	1RB Mid	0.58	0.61	0.70	
						Back Face	50RB Mid	0.56	0.47	0.54	
						Top Edge	1RB Mid	0.58	0.57	0.65	
						Top Edge	50RB Mid	0.56	0.45	0.51	
	Ant 8	20	QPSK	20850	2510	Top Edge	1RB Mid	0.97	0.70	0.88	
						Top Edge	50RB Mid	0.95	0.56	0.70	
				21100	2535	Back Face	1RB Mid	0.80	0.43	0.52	
						Back Face	50RB Mid	0.77	0.35	0.41	
						Top Edge	1RB Mid	0.80	0.74	0.89	
						Top Edge	50RB Mid	0.77	0.59	0.70	
						Top Edge	100RB Mid	0.98	0.58	0.73	
						Top Edge	1RB Mid	0.82	0.75	0.90	4
						Top Edge	50RB Mid	0.78	0.60	0.72	
						Top Edge	50RB Mid	0.78	0.60	0.72	

LTE UL CA 7C

UL CA shall be tested based on the worst-case SAR configuration determined from non-CA SAR testing result. The channel BW, channel number, RB allocation, etc. would be selected to allow contiguous CA of PCC and SCC. Uplink output power for UL CA is the total power measured across the PCC and SCC.

From the above table on standalone testing on LTE Band 7, back face position on antenna 8, was chosen as the configurations that give the highest SAR, thus, the same is used for UL CA testing.

Band	Ant.	Modulation / BW	PCC			SCC			Position	Scaling Factor (dB)	Measured SAR 1g (W/Kg)	Reported SAR 1g (W/Kg)
			Ch	Freq (MHz)	RB Allocation	Ch	Freq (MHz)	RB Allocation				
LTE 7C	Ant 8	QPSK / 20MHz	20850	2510	1RB High	21100	2535	1RB Low	Back face	0.63	0.38	0.43

PCC RB allocation settings for UL CA have been adjusted based on the worst-case power

(ii) LTE Band 12 FDD

Band	Antenna	BW (MHz)	Mod.	Channel Number	Freq (MHz)	Position	% RB Allocation	Scaling Factor (dB)	Measured SAR 1g (W/kg)	Reported SAR 1g (W/kg)	Plot #
LTE 12	Ant 5	10	QPSK	23095	707.5	Back Face	1RB Mid	0.81	0.85	1.02	
						Back Face	50RB Mid	0.91	0.84	1.04	
						Back Face	100RB Mid	0.93	0.88	1.09	5
						Top Edge	1RB Mid	0.81	0.59	0.71	
						Top Edge	50RB Mid	0.91	0.47	0.58	

(iii) LTE Band 13 FDD

Band	Antenna	BW (MHz)	Mod.	Channel Number	Freq (MHz)	Position	% RB Allocation	Scaling Factor (dB)	Measured SAR 1g (W/kg)	Reported SAR 1g (W/kg)	Plot #
LTE 13	Ant 5	10	QPSK	23230	782	Back Face	1RB Mid	1.00	0.62	0.78	6
						Back Face	50RB Mid	1.17	0.49	0.64	
						Top Edge	1RB Mid	1.00	0.28	0.36	
						Top Edge	50RB Mid	1.17	0.24	0.32	

(iv) LTE Band 14 FDD

Band	Antenna	BW (MHz)	Mod.	Channel Number	Freq (MHz)	Position	% RB Allocation	Scaling Factor (dB)	Measured SAR 1g (W/kg)	Reported SAR 1g (W/kg)	Plot #
LTE 14	Ant 5	10	QPSK	23330	793	Back Face	1RB Mid	1.56	0.47	0.68	7
						Back Face	50RB Mid	1.63	0.37	0.54	
						Top Edge	1RB Mid	1.56	0.22	0.32	
						Top Edge	50RB Mid	1.63	0.18	0.25	

(v) LTE Band 25 FDD

Band	Antenna	BW (MHz)	Mod.	Channel Number	Freq (MHz)	Position	% RB Allocation	Scaling Factor (dB)	Measured SAR 1g (W/kg)	Reported SAR 1g (W/kg)	Plot #
LTE 25	Ant 5	20	QPSK	26140	1860	Back Face	1RB Mid	0.42	0.87	0.96	
						Back Face	50RB Mid	0.46	0.72	0.80	
						Top Edge	1RB Mid	0.42	0.63	0.69	
						Top Edge	50RB Mid	0.46	0.64	0.71	
				26365	1882.5	Back Face	1RB Mid	0.56	0.96	1.09	
						Back Face	50RB Mid	0.46	0.74	0.82	
						Back Face	100RB Mid	0.48	0.75	0.84	
						Top Edge	1RB Mid	0.56	0.81	0.92	
				26590	1905	Top Edge	50RB Mid	0.46	0.65	0.72	
						Top Edge	100RB Mid	0.48	0.61	0.68	
						Back Face	1RB Mid	0.37	1.05	1.14	8
						Back Face	50RB Mid	0.39	0.81	0.88	
	Ant 8	20	QPSK	26365	1882.5	Top Edge	1RB Mid	0.37	0.56	0.61	
						Top Edge	50RB Mid	0.39	0.55	0.60	
						Back Face	1RB Mid	0.16	0.16	0.17	
						Back Face	50RB Mid	0.14	0.13	0.14	
						Top Edge	1RB Mid	0.16	0.36	0.38	
						Top Edge	50RB Mid	0.14	0.29	0.30	

(vi) LTE Band 26 FDD

Band	Antenna	BW (MHz)	Mod.	Channel Number	Freq (MHz)	Position	% RB Allocation	Scaling Factor (dB)	Measured SAR 1g (W/kg)	Reported SAR 1g (W/kg)	Plot #
LTE 26	Ant 5	15	QPSK	26865	831.5	Back Face	1RB Mid	0.00	0.40	0.40	9
						Back Face	50RB Mid	0.00	0.32	0.32	
						Top Edge	1RB Mid	0.00	0.17	0.17	
						Top Edge	50RB Mid	0.00	0.12	0.12	

(vii) LTE Band 30 FDD

Band	Antenna	BW (MHz)	Mod.	Channel Number	Freq (MHz)	Position	% RB Allocation	Scaling Factor (dB)	Measured SAR 1g (W/kg)	Reported SAR 1g (W/kg)	Plot #
LTE 30	Ant 5	10	QPSK	27710	2310	Back Face	1RB Mid	0.64	0.88	1.02	10
						Back Face	50RB Mid	0.75	0.66	0.79	
						Back Face	100RB Mid	0.75	0.67	0.79	
						Top Edge	1RB Mid	0.64	0.66	0.77	
						Top Edge	50RB Mid	0.75	0.52	0.62	
	Ant 8	10	QPSK	27710	2310	Back Face	1RB Mid	0.47	0.29	0.33	
						Back Face	50RB Mid	0.54	0.23	0.26	
						Top Edge	1RB Mid	0.47	0.61	0.67	
					Top Edge	50RB Mid	0.54	0.47	0.53		

(viii) LTE Band 41 TDD

Band	Antenna	BW (MHz)	Mod.	Channel Number	Freq (MHz)	Position	% RB Allocation	Scaling Factor (dB)	Measured SAR 1g (W/kg)	Reported SAR 1g (W/kg)	Plot #
LTE 41	Ant 5	20	QPSK	40620	2593	Back Face	1RB Mid	0.79	0.21	0.25	
						Back Face	50RB Mid	0.89	0.16	0.20	
						Right Edge	1RB Mid	0.79	0.02	0.02	
						Right Edge	50RB Mid	0.89	0.02	0.02	
						Top Edge	1RB Mid	0.79	0.28	0.34	
						Top Edge	50RB Mid	0.89	0.22	0.27	
	Ant 8	20	QPSK	40620	2593	Back Face	1RB Mid	0.88	0.24	0.29	
						Back Face	50RB Mid	0.90	0.19	0.24	
						Top Edge	1RB Mid	0.88	0.41	0.51	11
						Top Edge	50RB Mid	0.90	0.33	0.40	

UL CA 41C

UL CA shall be tested based on the worst-case SAR configuration determined from non-CA SAR testing result. The channel BW, channel number, RB allocation, etc. would be selected to allow contiguous CA of PCC and SCC. Uplink output power for UL CA is the total power measured across the PCC and SCC.

From the above table on standalone testing on LTE Band41, top edge position on antenna8 was chosen as the configurations that give the highest SAR, thus, the same is used for UL CA testing.

Band	Ant.	Modulation / BW	PCC			SCC			Position	Scaling Factor (dB)	Measured SAR 1g (W/Kg)	Reported SAR 1g (W/Kg)
			Ch	Freq (MHz)	RB Allocation	Ch	Freq (MHz)	RB Allocation				
LTE 41C	8	QPSK / 20MHz	40521	2583.1	1RB High	40719	2602.9	1RB Low	Top edge	0.00	0.14	0.14

PCC RB allocation settings for UL CA have been adjusted based on the worst-case power

(ix) LTE Band 48 TDD

Band	Antenna	BW (MHz)	Mod.	Channel Number	Freq (MHz)	Position	% RB Allocation	Scaling Factor (dB)	Measured SAR 1g (W/kg)	Reported SAR 1g (W/kg)	Plot #
LTE 48	Ant 8	20	QPSK	55990	3625	Back Face	1RB Mid	1.16	0.10	0.14	
						Back Face	50RB Mid	1.18	0.07	0.10	
						Top Edge	1RB Mid	1.16	0.46	0.60	12
						Top Edge	50RB Mid	1.18	0.38	0.49	

LTE UL CA 48C

UL CA shall be tested based on the worst-case SAR configuration determined from non-CA SAR testing result.

The channel BW, channel number, RB allocation, etc. would be selected to allow contiguous CA of PCC and SCC.

Uplink output power for UL CA is the total power measured across the PCC and SCC.

From the above table on standalone testing on LTE Band48, back face position on antenna8 was chosen as the configurations that give the highest SAR, thus, the same is used for UL CA testing.

Band	Ant.	Modulation / BW	PCC			SCC			Position	Scaling Factor (dB)	Measured SAR 1g (W/kg)	Reported SAR 1g (W/kg)
			Ch	Freq (MHz)	RB Allocation	Ch	Freq (MHz)	RB Allocation				
LTE 48C	Ant 8	QPSK / 20MHz	55891	3615.1	1RB High	56089	3634.9	1RB Low	Top Edge	0.49	0.45	0.50

PCC RB allocation settings for UL CA have been adjusted based on the worst-case power

(x) LTE Band66 FDD

Band	Antenna	BW (MHz)	Mod.	Channel Number	Freq (MHz)	Position	% RB Allocation	Scaling Factor (dB)	Measured SAR 1g (W/kg)	Reported SAR 1g (W/kg)	Plot #
LTE 66	Ant 5	20	QPSK	132072	1720	Back Face	1RB Mid	0.90	0.84	1.03	
						Back Face	50RB Mid	0.91	0.67	0.83	
						Top Edge	1RB Mid	0.90	0.76	0.93	
						Top Edge	50RB Mid	0.91	0.60	0.74	
				132322	1745	Back Face	1RB Mid	1.04	1.11	1.41	
						Back Face	50RB Mid	1.07	0.87	1.11	
						Back Face	100RB Mid	1.06	0.86	1.10	
						Right Edge	1RB Mid	1.04	0.02	0.03	
						Right Edge	50RB Mid	1.07	0.02	0.02	
						Top Edge	1RB Mid	1.04	0.82	1.04	
						Top Edge	50RB Mid	1.07	0.68	0.88	
						Top Edge	100RB Mid	1.06	0.65	0.83	
	132572	1770	Back Face	1RB Mid	1.02	1.13	1.43	13			
			Back Face	50RB Mid	1.10	0.92	1.19				
			Top Edge	1RB Mid	1.02	1.03	1.30				
			Top Edge	50RB Mid	1.10	0.84	1.09				
	Ant 8	20	QPSK	132322	1745	Back Face	1RB Mid	0.30	0.18	0.19	
						Back Face	50RB Mid	0.18	0.14	0.15	
						Top Edge	1RB Mid	0.30	0.28	0.30	
						Top Edge	50RB Mid	0.18	0.24	0.25	

UL CA 66B, 66C

UL CA shall be tested based on the worst-case SAR configuration determined from non-CA SAR testing result. The channel BW, channel number, RB allocation, etc. would be selected to allow contiguous CA of PCC and SCC. Uplink output power for UL CA is the total power measured across the PCC and SCC.

From the above table on standalone testing on LTE Band66, Back Face on Ant 5 position was chosen as the configurations that give the highest SAR, thus, the same is used for UL CA testing.

Band	Ant	Modulation / BW	PCC			SCC			Position	Scaling Factor (dB)	Measured SAR 1g (W/Kg)	Reported SAR 1g (W/Kg)
			Ch	Freq (MHz)	RB Allocation	Ch	Freq (MHz)	RB Allocation				
LTE 66B	5	QPSK / 20MHz	132373	1750.1	1RB High	132472	1760	1RB Low	Back Face	0.97	0.85	1.06
LTE 66C		QPSK / 20MHz	132323	2145.1	1RB High	132521	1764.9	1RB Low	Back Face	0.17	1.09	1.13

PCC RB allocation settings for UL CA have been adjusted based on the worst-case power

A.4.3 5G NR

(i) 5G NR 2 FDD for ENDC Only

Band	Antenna	BW (MHz)	Mod.	Channel Number	Freq (MHz)	Position	% RB Allocation	Scaling Factor (dB)	Measured SAR 1g (W/kg)	Reported SAR 1g (W/kg)	Plot #
NR2	Ant 8	20	QPSK	376000	1880	Back Face	1RB Mid	0.08	0.13	0.13	
						Back Face	50RB Mid	0.13	0.14	0.14	
						Top Edge	1RB Mid	0.08	0.24	0.25	
						Top Edge	50RB Mid	0.13	0.25	0.25	14

(ii) 5G NR 5 FDD

Band	Antenna	BW (MHz)	Mod.	Channel Number	Freq (MHz)	Position	% RB Allocation	Scaling Factor (dB)	Measured SAR 1g (W/kg)	Reported SAR 1g (W/kg)	Plot #
NR5	Ant 5	20	QPSK	167300	836.5	Back Face	1RB Mid	0.69	0.32	0.38	
						Back Face	50RB Mid	0.59	0.33	0.38	15
						Top Edge	1RB Mid	0.69	0.19	0.22	
						Top Edge	50RB Mid	0.59	0.21	0.24	

(iii) 5G NR 7 FDD

Band	Antenna	BW (MHz)	Mod.	Channel Number	Freq (MHz)	Position	% RB Allocation	Scaling Factor (dB)	Measured SAR 1g (W/kg)	Reported SAR 1g (W/kg)	Plot #
NR7	Ant 5	20	QPSK	507000	2535.0	Back Face	1RB Mid	0.48	0.60	0.67	
						Back Face	50RB Mid	0.41	0.62	0.68	16
						Top Edge	1RB Mid	0.48	0.34	0.38	
						Top Edge	50RB Mid	0.41	0.35	0.38	

(iv) 5G NR 25 FDD

Band	Antenna	BW (MHz)	Mod.	Channel Number	Freq (MHz)	Position	% RB Allocation	Scaling Factor (dB)	Measured SAR 1g (W/kg)	Reported SAR 1g (W/kg)	Plot #
NR25	Ant 5	20	QPSK	376500	1882.5	Back Face	1RB Mid	0.39	0.41	0.45	
						Back Face	50RB Mid	0.33	0.40	0.43	
						Top Edge	1RB Mid	0.39	0.44	0.48	17
						Top Edge	50RB Mid	0.33	0.43	0.46	

(v) 5G NR 30 FDD

Band	Antenna	BW (MHz)	Mod.	Channel Number	Freq (MHz)	Position	% RB Allocation	Scaling Factor (dB)	Measured SAR 1g (W/kg)	Reported SAR 1g (W/kg)	Plot #
NR30	Ant 5	10	QPSK	46200	2310.0	Back Face	1RB Mid	0.56	0.69	0.78	
						Back Face	50RB Mid	0.51	0.81	0.91	18
						Back Face	100RB Mid	0.61	0.72	0.83	
						Top Edge	1RB Mid	0.56	0.70	0.80	
						Top Edge	50RB Mid	0.51	0.69	0.78	

(vi) 5G NR 38 TDD

Band	Antenna	BW (MHz)	Mod.	Channel Number	Freq (MHz)	Position	% RB Allocation	Scaling Factor (dB)	Measured SAR 1g (W/kg)	Reported SAR 1g (W/kg)	Plot #
NR38	Ant 8	40	QPSK	519000	2595	Back Face	1RB Mid	0.28	0.04	0.04	
						Back Face	50RB Mid	0.31	0.04	0.04	
						Top Edge	1RB Mid	0.28	0.07	0.08	19
						Top Edge	50RB Mid	0.31	0.07	0.08	

(vii) 5G NR 41 TDD

Band	Antenna	BW (MHz)	Mod.	Channel Number	Freq (MHz)	Position	% RB Allocation	Scaling Factor (dB)	Measured SAR 1g (W/kg)	Reported SAR 1g (W/kg)	Plot #
NR 41	Ant 5	100	QPSK	518598	2593	Back Face	1RB Mid	0.36	0.03	0.03	
						Back Face	50RB Mid	0.13	0.03	0.03	
						Top Edge	1RB Mid	0.36	0.08	0.09	20
						Top Edge	50RB Mid	0.13	0.08	0.08	
						Right Edge	1RB Mid	0.36	0.00	0.00	
						Right Edge	50RB Mid	0.13	0.00	0.00	
	Ant 8	100	QPSK	518598	2593	Back Face	1RB Mid	0.02	0.04	0.04	
						Back Face	50RB Mid	0.00	0.04	0.04	
						Top Edge	1RB Mid	0.02	0.07	0.07	
						Top Edge	50RB Mid	0.00	0.08	0.08	

(viii) 5G NR 66 FDD

Band	Antenna	BW (MHz)	Mod.	Channel Number	Freq (MHz)	Position	% RB Allocation	Scaling Factor (dB)	Measured SAR 1g (W/kg)	Reported SAR 1g (W/kg)	Plot #
NR 66	Ant 5	40	QPSK	349000	1745.0	Back Face	1RB Mid	0.57	0.33	0.37	
						Back Face	50RB Mid	0.58	0.32	0.36	
						Top Edge	1RB Mid	0.57	0.21	0.24	
						Top Edge	50RB Mid	0.58	0.22	0.25	
						Right Edge	1RB Mid	0.57	0.03	0.04	
						Right Edge	50RB Mid	0.58	0.04	0.05	
	Ant 8	40	QPSK	349000	1745.0	Back Face	1RB Mid	0.36	0.37	0.40	
						Back Face	50RB Mid	0.35	0.36	0.40	
						Top Edge	1RB Mid	0.36	0.58	0.63	21
						Top Edge	50RB Mid	0.35	0.57	0.62	

5G NR 77 TDD

Band	Antenna	BW (MHz)	Mod.	Channel Number	Freq (MHz)	Position	% RB Allocation	Scaling Factor (dB)	Measured SAR 1g (W/kg)	Reported SAR 1g (W/kg)	Plot #
NR 77	Ant 5	100	QPSK	650000	3750.0	Back Face	1RB Mid	0.25	0.05	0.05	
						Back Face	50RB Mid	0.02	0.05	0.05	
						Top Edge	1RB Mid	0.25	0.06	0.06	
						Top Edge	50RB Mid	0.02	0.07	0.07	
	Ant 8	100	QPSK	650000	3750.0	Back Face	1RB Mid	0.06	0.05	0.05	
						Back Face	50RB Mid	0.04	0.05	0.05	
						Top Edge	1RB Mid	0.06	0.14	0.14	22
						Top Edge	50RB Mid	0.04	0.14	0.14	

5G NR 78 TDD

Band	Antenna	BW (MHz)	Mod.	Channel Number	Freq (MHz)	Position	% RB Allocation	Scaling Factor (dB)	Measured SAR 1g (W/kg)	Reported SAR 1g (W/kg)	Plot #
NR 78	Ant 5	100	QPSK	650000	3750.0	Back Face	1RB Mid	1.22	0.05	0.06	
						Back Face	50RB Mid	0.85	0.05	0.06	
						Top Edge	1RB Mid	1.22	0.13	0.16	
						Top Edge	50RB Mid	0.85	0.13	0.17	23

A.4.4 ENDC

For EN-DC mode, the 4G and 5G carriers transmit on separate antennas. Each exposure has been measured separately. For both LTE and 5G-NR, the highest standalone SAR conditions are added to derive the Total SAR. Refer to paragraph A.4.7

A.4.5 SAR Measurement Variability

According to FCC OET KDB 865664, SAR Measurement variability is assessed when the maximum initial measured SAR is ≥ 0.8 W/kg for a certain band/mode. If the measured SAR value of the initial repeated measurement is < 1.45 W/kg with $< 20\%$ variation, only one repeated measurement is required to confirm that the results are not expected to have substantial variations.

A second repeated measurement is required only if the measured results for the initial repeated measurement are within 10% of the SAR limit or vary by more than 20%.

A third repeated measurement is required only if the original, first or second repeated measurement ≥ 1.5 W/Kg and the ratio of largest to smallest SAR for the original, first and second repeated measurement is > 1.2 .

Band / Mode	Position	Ch #	Freq. (MHz)	Measured SAR 1g (W/kg)	1 st Repeated SAR 1g (W/kg)	2 nd Repeated SAR 1g (W/kg)	Highest Ratio
LTE 12 / QPSK 10MHz	Back Face	23095	707.5	0.88	0.87		1.01
LTE 30 / QPSK 10MHz	Back Face	27710	2310	0.88	0.82		1.02
LTE 25 / QPSK 20MHz	Back Face	19150	1905	1.05	1.02		1.03
LTE 66 / QPSK 20MHz	Back Face	27710	2310	1.13	1.13		1.00

A.4.7 Simultaneous Transmission SAR Evaluation

According to FCC OET KDB 447498, when the sum of 1g SAR for all simultaneously transmitting antennas in an operating mode and exposure condition combination is within the SAR limit, SAR test exclusion applies to that simultaneous transmission configuration.

As commented on section 6, this report only evaluates SAR for cellular transmission on the module, nevertheless in order to consider all possible simultaneous transmissions on the device for compliance, WLAN SAR and NFC values reported on document [1] and [2] are considered.

[1] 220720-01.TR03 - HP HSC-I006R AX201D2W, SAR, FCC - Rev01

[2] Operation description_20221031

All the values stated in the table below are the worst case found for standalone measurement with disregard of the transmission mode or channel where the worst case was found

Antenna	Position	Highest Reported SAR (1g) (W/kg)				
		WWAN	WLAN 2.4GHz[1]	WLAN 5/6GHz[1]	Bluetooth[1]	**NFC[2]
Ant.5 WWAN	Back Face	1.43				
	Bottom Edge	0.40*				
	Left Edge	0.40*				
	Right Edge	0.02				
	Top Edge	1.30				
Ant.8 WWAN	Back Face	0.52				
	Bottom Edge	0.40*				
	Left Edge	0.40*				
	Right Edge	0.40*				
	Top Edge	0.90				
Main WLAN	Back Face		0.49	0.45		
	Bottom Edge		0.40*	0.40*		
	Left Edge		0.67	0.27		
	Right Edge		0.40*	0.40*		
	Top Edge		0.13	0.06		
Aux WLAN	Back Face		0.55	0.88	0.11	
	Bottom Edge		0.12	0.09	0.01	
	Left Edge		0.49	0.39	0.11	
	Right Edge		0.40*	0.40*	0.40*	
	Top Edge		0.40*	0.40*	0.40*	
NFC	Back Face					<0.002
	Bottom Edge					<0.002
	Left Edge					<0.002
	Right Edge					<0.002
	Top Edge					<0.002

*According to FCC OET KDB 447498 D01, when standalone test exclusion is applied to an antenna that transmits simultaneously with other antennas, the standalone SAR must be estimated to 0.4 W/Kg for 1-g SAR when the test separation is > 50mm in order to determine simultaneous transmission test exclusion.

** Please refer to Annex  NFC SAR test exclusion details
SAR simultaneous combinations eschewed the NFC SAR estimated values as per their low values.

Position	Simultaneous Tx Antenna Combination					Σ SAR 1g (W/Kg)	Limit (W/kg)
	#	WWAN Ant5	WWAN Ant8	Main Antenna	Aux Antenna		
Back Face	1	Cellular	Cellular	WLAN 5/6GHz	WLAN 5/6GHz	3.28	1.6
	2	Cellular	Cellular	WLAN 5/6GHz	WLAN 5/6GHz+ BT	3.39	
	3	Cellular	Cellular	WLAN 5/6GHz	BT	2.51	
	4	Cellular	Cellular	WLAN 2.4GHz	WLAN 2.4GHz	2.47	
	5	Cellular	Cellular	WLAN 2.4GHz	BT	2.55	
Bottom	1	Cellular	Cellular	WLAN 5/6GHz	WLAN 5/6GHz	1.29	
	2	Cellular	Cellular	WLAN 5/6GHz	WLAN 5/6GHz+ BT	1.30	
	3	Cellular	Cellular	WLAN 5/6GHz	BT	1.21	
	4	Cellular	Cellular	WLAN 2.4GHz	WLAN 2.4GHz	1.32	
	5	Cellular	Cellular	WLAN 2.4GHz	BT	1.21	
Left Edge	1	Cellular	Cellular	WLAN 5/6GHz	WLAN 5/6GHz	1.46	
	2	Cellular	Cellular	WLAN 5/6GHz	WLAN 5/6GHz+ BT	1.57	
	3	Cellular	Cellular	WLAN 5/6GHz	BT	1.18	
	4	Cellular	Cellular	WLAN 2.4GHz	WLAN 2.4GHz	1.96	
	5	Cellular	Cellular	WLAN 2.4GHz	BT	1.58	
Right Edge	1	Cellular	Cellular	WLAN 5/6GHz	WLAN 5/6GHz	1.22	
	2	Cellular	Cellular	WLAN 5/6GHz	WLAN 5/6GHz+ BT	1.62	
	3	Cellular	Cellular	WLAN 5/6GHz	BT	1.22	
	4	Cellular	Cellular	WLAN 2.4GHz	WLAN 2.4GHz	1.22	
	5	Cellular	Cellular	WLAN 2.4GHz	BT	1.22	
Top Edge	1	Cellular	Cellular	WLAN 5/6GHz	WLAN 5/6GHz	2.66	
	2	Cellular	Cellular	WLAN 5/6GHz	WLAN 5/6GHz+ BT	3.06	
	3	Cellular	Cellular	WLAN 5/6GHz	BT	2.66	
	4	Cellular	Cellular	WLAN 2.4GHz	WLAN 2.4GHz	2.73	
	5	Cellular	Cellular	WLAN 2.4GHz	BT	2.73	

In case the sum of SAR is larger than the limit, SAR test exclusion is determined by the SAR to peak location separation ratio (SPLSR). According to the last table possible simultaneous transmission combinations are identified for each position from 1 to 5, each combination will be analyzed by antenna pairs. Antenna pairs considered in one configuration won't be performed again in case they are repeated on the next simultaneous configuration:

Position	Ant. Pair case	Antenna	Reported SAR 1g (W/kg)	Σ SAR 1g (W/Kg)	Peak Location (mm) (x,y,z)	SAR to peak location separation ratio	Limit
Back Face	1a	WWAN (Ant5)	1.43	1.95	(42.9,109.1,-177)	0.02	0.04
		WWAN (Ant8)	0.52		(165.5,107.5,-177)		
	1b	WWAN (Ant5)	1.43	1.88	(42.9,109.1,-177)	0.02	
		Main WLAN 5/6GHz	0.45		(-72.3,-13.7,-177)		
	1c	WWAN (Ant5)	1.43	2.31	(42.9,109.1,-177)	0.03	
		Aux WLAN 5/6GHz	0.88		(69,-19,-174)		
	1d	WWAN (Ant8)	0.52	0.97			
		Main WLAN 5/6GHz	0.45				
	1e	WWAN (Ant8)	0.52	1.40			
		Aux WLAN 5/6GHz	0.88				
	1f	Main WLAN 5GHz	0.45	1.33			
		Aux WLAN 5/6GHz	0.88				
	2a	WWAN (Ant5)	1.43	1.54			
		Aux BT	0.11				
	2b	WWAN (Ant8)	0.52	0.63			
		Aux BT	0.11				
	4a	WWAN (Ant5)	1.43	1.92	(42.9,109.1,-177)	0.02	
		Main WLAN 2.4GHz	0.49		(-13.7,-19.5,-177)		
	4b	WWAN (Ant5)	1.43	2.31	(42.9,109.1,-177)	0.02	
		Aux WLAN 2.4GHz	0.88		(-13.7,-19.5,-177)		
4c	WWAN (Ant8)	0.52	1.01				
	Main WLAN 2.4GHz	0.49					
4d	WWAN (Ant8)	0.52	1.07				
	Aux WLAN 2.4GHz	0.55					
4e	Main WLAN 2.4GHz	0.49	1.04				
	Aux WLAN 2.4GHz	0.55					

Position	Ant. Pair case	Antenna	Reported SAR 1g (W/kg)	Σ SAR 1g (W/Kg)	Peak Location (mm) (x,y,z)	SAR to peak location separation ratio	Limit
Bottom Edge	1a	WWAN (Ant5)	0.40	0.80			0.04
		WWAN (Ant8)	0.40				
	1b	WWAN (Ant5)	0.40	0.80			
		Main WLAN 5/6GHz	0.40				
	1c	WWAN (Ant5)	0.40	0.49			
		Aux WLAN 5/6GHz	0.09				
	1d	WWAN (Ant8)	0.40	0.80			
		Main WLAN 5/6GHz	0.40				
	1e	WWAN (Ant8)	0.40	0.49			
		Aux WLAN 5/6GHz	0.09				
	1f	Main WLAN 5GHz	0.40	0.49			
		Aux WLAN 5/6GHz	0.09				
	2a	WWAN (Ant5)	0.40	0.41			
		Aux BT	0.01				
	2b	WWAN (Ant8)	0.40	0.41			
		Aux BT	0.01				
	4a	WWAN (Ant5)	0.40	0.80			
		Main WLAN 2.4GHz	0.40				
	4b	WWAN (Ant5)	0.40	0.52			
		Aux WLAN 2.4GHz	0.12				
4c	WWAN (Ant8)	0.40	0.80				
	Main WLAN 2.4GHz	0.40					
4d	WWAN (Ant8)	0.40	0.52				
	Aux WLAN 2.4GHz	0.12					
4e	Main WLAN 2.4GHz	0.40	0.52				
	Aux WLAN1 2.4GHz	0.12					

Position	Ant. Pair case	Antenna	Reported SAR 1g (W/kg)	Σ SAR 1g (W/Kg)	Peak Location (mm) (x,y,z)	SAR to peak location separation ratio	Limit
Left Edge	1a	WWAN (Ant5)	0.40	0.80			0.04
		WWAN (Ant8)	0.40				
	1b	WWAN (Ant5)	0.40	0.67			
		Main WLAN 5/6GHz	0.27				
	1c	WWAN (Ant5)	0.40	1.07			
		Aux WLAN 5/6GHz	0.67				
	1d	WWAN (Ant8)	0.40	0.67			
		Main WLAN 5/6GHz	0.27				
	1e	WWAN (Ant8)	0.40	0.79			
		Aux WLAN 5/6GHz	0.39				
	1f	Main WLAN 5GHz	0.27	0.66			
		Aux WLAN 5/6GHz	0.39				
	2a	WWAN (Ant5)	0.40	0.51			
		Aux BT	0.11				
	2b	WWAN (Ant8)	0.40	0.51			
		Aux BT	0.11				
	4a	WWAN (Ant5)	0.40	1.07			
		Main WLAN 2.4GHz	0.67				
	4b	WWAN (Ant5)	0.40	0.89			
		Aux WLAN 2.4GHz	0.49				
4c	WWAN (Ant8)	0.40	1.07				
	Main WLAN 2.4GHz	0.67					
4d	WWAN (Ant8)	0.40	0.89				
	Aux WLAN 2.4GHz	0.49					
4e	Main WLAN 2.4GHz	0.67	1.16				
	Aux WLAN1 2.4GHz	0.49					

Position	Ant. Pair case	Antenna	Reported SAR 1g (W/kg)	Σ SAR 1g (W/Kg)	Peak Location (mm) (x,y,z)	SAR to peak location separation ratio	Limit
Right Edge	1a	WWAN (Ant5)	0.02	0.42			0.04
		WWAN (Ant8)	0.40				
	1b	WWAN (Ant5)	0.02	0.42			
		Main WLAN 5/6GHz	0.40				
	1c	WWAN (Ant5)	0.02	0.42			
		Aux WLAN 5/6GHz	0.40				
	1d	WWAN (Ant8)	0.40	0.80			
		Main WLAN 5/6GHz	0.40				
	1e	WWAN (Ant8)	0.40	0.80			
		Aux WLAN 5/6GHz	0.40				
	1f	Main WLAN 5GHz	0.40	0.80			
		Aux WLAN 5/6GHz	0.40				
	2a	WWAN (Ant5)	0.02	0.42			
		Aux WLAN BT	0.40				
	2b	WWAN (Ant8)	0.40	0.80			
		Aux WLAN1 BT	0.40				
	4a	WWAN (Ant5)	0.02	0.42			
		Main WLAN 2.4GHz	0.40				
	4b	WWAN (Ant5)	0.02	0.42			
		Aux WLAN 2.4GHz	0.40				
4c	WWAN (Ant8)	0.40	0.80				
	Main WLAN 2.4GHz	0.40					
4d	WWAN (Ant8)	0.40	0.80				
	Aux WLAN 2.4GHz	0.40					
4e	Main WLAN 2.4GHz	0.40	0.80				
	Aux WLAN1 2.4GHz	0.40					

Position	Ant. Pair case	Antenna	Reported SAR 1g (W/kg)	Σ SAR 1g (W/Kg)	Peak Location (mm) (x,y,z)	SAR to peak location separation ratio	Limit
Top Edge	1a	WWAN (Ant5)	1.30	1.39			0.04
		WWAN (Ant8)	0.90				
	1b	WWAN (Ant5)	1.30	1.36			
		Main WLAN 5/6GHz	0.06				
	1c	WWAN (Ant5)	1.30	1.70	(2.6,92.6,-177)	0.01	
		Aux WLAN 5/6GHz	0.40		(-2,-122,-177)		
	1d	WWAN (Ant8)	0.90	0.96			
		Main WLAN 5/6GHz	0.06				
	1e	WWAN (Ant8)	0.90	1.30			
		Aux WLAN 5/6GHz	0.40				
	1f	Main WLAN 5GHz	0.06	0.46			
		Aux WLAN 5/6GHz	0.40				
	2a	WWAN (Ant5)	1.30	1.70	(2.6,92.6,-177)	0.01	
		Aux WLAN BT	0.40		(-2,-122,-177)		
	2b	WWAN (Ant8)	0.90	1.30			
		Aux WLAN1 BT	0.40				
	4a	WWAN (Ant5)	1.30	1.43			
		Main WLAN 2.4GHz	0.13				
	4b	WWAN (Ant5)	1.30	1.70	(2.6,92.6,-177)	0.01	
		Aux WLAN 2.4GHz	0.40		(-2,-122,-177)		
4c	WWAN (Ant8)	0.90	1.03				
	Main WLAN 2.4GHz	0.13					
4d	WWAN (Ant8)	0.90	1.30				
	Aux WLAN 2.4GHz	0.40					
4e	Main WLAN 2.4GHz	0.13	0.53				
	Aux WLAN1 2.4GHz	0.40					

Considering the results described above and according to the simultaneous transmission evaluation exclusions described in FCC OET KDB 447498, no SPLSR nor enlarged zoom scan measurements are required.

Annex B. Test System Plots

1. WCDMA II, RMC 12.2kbps, 5MHz, CH9400, Antenna Ant 5, Top edge.....	101
2. WCDMA IV, RMC 12.2kbps, 5MHz, CH1762, Antenna Ant 5, Top edge	102
3. WCDMA V, RMC 12.2kbps, 5MHz, CH4183, Antenna Ant 5, Top edge	103
4. LTE Band 7, QPSK - 20MHz, CH21350, Antenna Ant 8, Top Edge	104
5. LTE Band 12, QPSK - 10MHz, CH23130, Antenna Ant 5, Back face	105
6. LTE Band 13, QPSK - 10MHz, CH23230, Antenna Ant 5, Back face	106
7. LTE Band 14, QPSK - 10MHz, CH23330, Antenna Ant 5, Back face	107
8. LTE Band 25, QPSK - 20MHz, CH26590, Antenna Ant 5, Back Face	108
9. LTE Band 26, QPSK - 15MHz, CH26865, Antenna Ant 5, Back face	109
10. LTE Band 30 - 10MHz, CH27710, Antenna Ant 5, Back face	110
11. LTE Band 41, QPSK - 20MHz, CH40620, Antenna Ant 8, Top edge.....	111
12. LTE Band 48, QPSK - 20MHz, CH55990, Antenna Ant 8, Top edge.....	112
13. LTE Band 66, QPSK - 20MHz, CH132572, Antenna Ant 5, Back Face.....	113
14. 5G NR FR1 Band 2, QPSK - 20MHz, CH376000, Antenna 8, Top Edge	114
15. 5G NR FR1 Band 5, QPSK - 10MHz, CH167300, Antenna 5, Back Face.....	115
16. 5G NR FR1 Band 7, QPSK - 20MHz, CH167300, Antenna 5, Back Face.....	116
17. 5G NR FR1 Band 25, QPSK - 20MHz, CH376500, Antenna 5, Top Edge	117
18. 5G NR FR1 Band 30, QPSK - 20MHz, CH462000, Antenna 5, Back Face.....	118
19. 5G NR FR1 Band 38, QPSK - 40MHz, CH519000, Antenna 8, Top Edge	119
20. 5G NR FR1 Band 41, QPSK - 100MHz, CH518598, Antenna 5, Top Edge	120
21. 5G NR FR1 Band 66, QPSK - 40MHz, CH349000, Antenna 8, Top Edge	121
22. 5G NR FR1 Band 77, QPSK - 100MHz, CH650000, Antenna 8, Top Edge	122
23. 5G NR FR1 Band 78, QPSK - 100MHz, CH650000, Antenna 5, Top Edge	123
24. System Check Body Liquid 750MHz – 2022-08-16 – System2.....	124
25. System Check Body Liquid 835MHz – 2022-08-17 – System2.....	125
26. System Check Body Liquid 835MHz – 2022-08-26 – System2.....	126
27. System Check Body Liquid 835MHz – 2022-08-29 – System3.....	127
28. System Check Body Liquid 1750MHz – 2022-08-17 – System2.....	128
29. System Check Body Liquid 1750MHz – 2022-08-10 – System2.....	129
30. System Check Body Liquid 1750MHz – 2022-08-29 – System3.....	130
31. System Check Body Liquid 1900MHz – 2022-08-17 - System2.....	131
32. System Check Body Liquid 1900MHz – 2022-08-10 - System2.....	132
33. System Check Body Liquid 1900MHz – 2022-08-29 – System3.....	133
34. System Check Body Liquid 1900MHz – 2022-08-30 – System3.....	134
35. System Check Body Liquid 2300MHz – 2022-08-16 –System2.....	135
36. System Check Body Liquid 2300MHz – 2022-08-29 - System3.....	136
37. System Check Body Liquid 2600MHz – 2022-08-29 – System3.....	137
38. System Check Body Liquid 2600MHz – 2022-08-30 – System3.....	138
39. System Check Body Liquid 2600MHz – 2022-08-11 – System2.....	139

40.	System Check Body Liquid 2600MHz – 2022-08-31 – System 3	140
41.	System Check Body Liquid 3700MHz – 2022-08-30 – System3	141
42.	System Check Body Liquid 3700MHz – 2022-08-11 – System2	142

1. WCDMA II, RMC 12.2kbps, 5MHz, CH9400, Antenna Ant 5, Top edge

Device under Test Properties

Model, Manufacturer	Dimensions [mm]	S/N	DUT Type
HSC-I006R	300.0 x 220.0 x 17.0	C902NE00HT	Tablet

Exposure Conditions

Phantom Section, TSL	Position, Test Distance [mm]	Band	Group, UID	Frequency [MHz], Channel Number	Conversion Factor	TSL Conductivity [S/m]	TSL Permittivity
Flat, MSL	EDGE TOP, 0.00	Band 2, UTRA/FDD	WCDMA, 10011-CAB	1880.0, 9400	8.06	1.49	52.2

Hardware Setup

Phantom	TSL, Measured Date	Probe, Calibration Date	DAE, Calibration Date
ELI V8.0 (20deg probe tilt) -	MBBL-600-6000, 2022-Aug-10	EX3DV4 - SN3978, 2022-05-17	DAE4ip Sn1703, 2022-04-28

Scan Setup

	Area Scan	Zoom Scan
Grid Extents [mm]	60.0 x 330.0	30.0 x 30.0 x 30.0
Grid Steps [mm]	15.0 x 15.0	6.0 x 6.0 x 1.5
Sensor Surface [mm]	3.0	1.4
Graded Grid	Yes	Yes
Grading Ratio	1.5	1.5
MAIA	Confirmed by MAIA	Confirmed by MAIA
Surface Detection	VMS + 6p	VMS + 6p
Scan Method	Measured	Measured

Measurement Results

	Area Scan	Zoom Scan
Date	2022-08-10, 15:26	2022-08-10, 15:32
psSAR1g [W/Kg]	0.464	0.522
psSAR10g [W/Kg]	0.225	0.251
Power Drift [dB]	-0.04	0.02
Power Scaling	Disabled	Disabled
Scaling Factor [dB]		
TSL Correction	Positive Only	Positive Only
M2/M1 [%]		79.7
Dist 3dB Peak [mm]		6.1

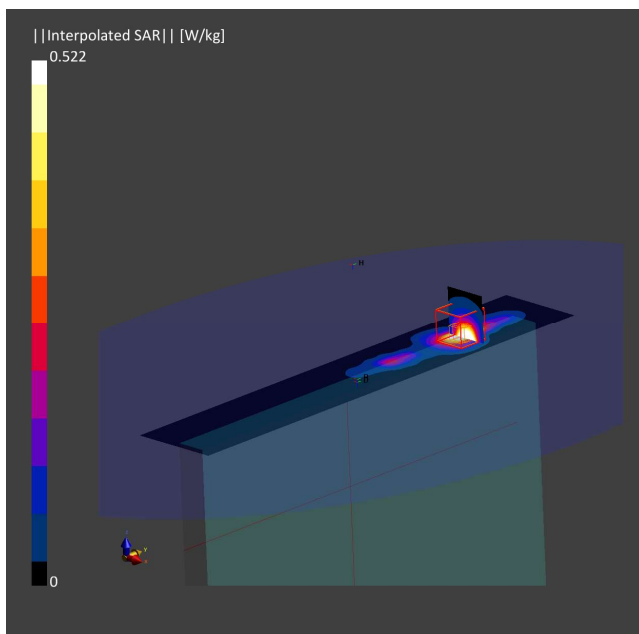

2. WCDMA IV, RMC 12.2kbps, 5MHz, CH1762, Antenna Ant 5, Top edge

Device under Test Properties

Model, Manufacturer	Dimensions [mm]	S/N	DUT Type
HSC-I006R	300.0 x 220.0 x 17.0	C902NE00HT	Tablet

Exposure Conditions

Phantom Section, TSL	Position, Test Distance [mm]	Band	Group, UID	Frequency [MHz], Channel Number	Conversion Factor	TSL Conductivity [S/m]	TSL Permittivity
Flat, MSL	EDGE TOP, 0.00	Band 4, UTRA/FDD	WCDMA, 10011-CAB	1732.5, 1762	8.42	1.39	52.3

Hardware Setup

Phantom	TSL, Measured Date	Probe, Calibration Date	DAE, Calibration Date
ELI V8.0 (20deg probe tilt) -	MABL-600-6000 , 2022-Aug-10	EX3DV4 - SN3978, 2022-05-17	DAE4ip Sn1703, 2022-04-28

Scan Setup

	Area Scan	Zoom Scan
Grid Extents [mm]	60.0 x 330.0	30.0 x 30.0 x 30.0
Grid Steps [mm]	15.0 x 15.0	6.0 x 6.0 x 1.5
Sensor Surface [mm]	3.0	1.4
Graded Grid	Yes	Yes
Grading Ratio	1.5	1.5
MAIA	Confirmed by MAIA	Confirmed by MAIA
Surface Detection	VMS + 6p	VMS + 6p
Scan Method	Measured	Measured

Measurement Results

	Area Scan	Zoom Scan
Date	2022-08-10, 15:38	2022-08-10, 15:44
psSAR1g [W/Kg]	0.319	0.338
psSAR10g [W/Kg]	0.156	0.166
Power Drift [dB]	-0.04	-0.06
Power Scaling	Disabled	Disabled
Scaling Factor		
TSL Correction	Positive Only	Positive Only
M2/M1 [%]		80.7
Dist 3dB Peak [mm]		7.0

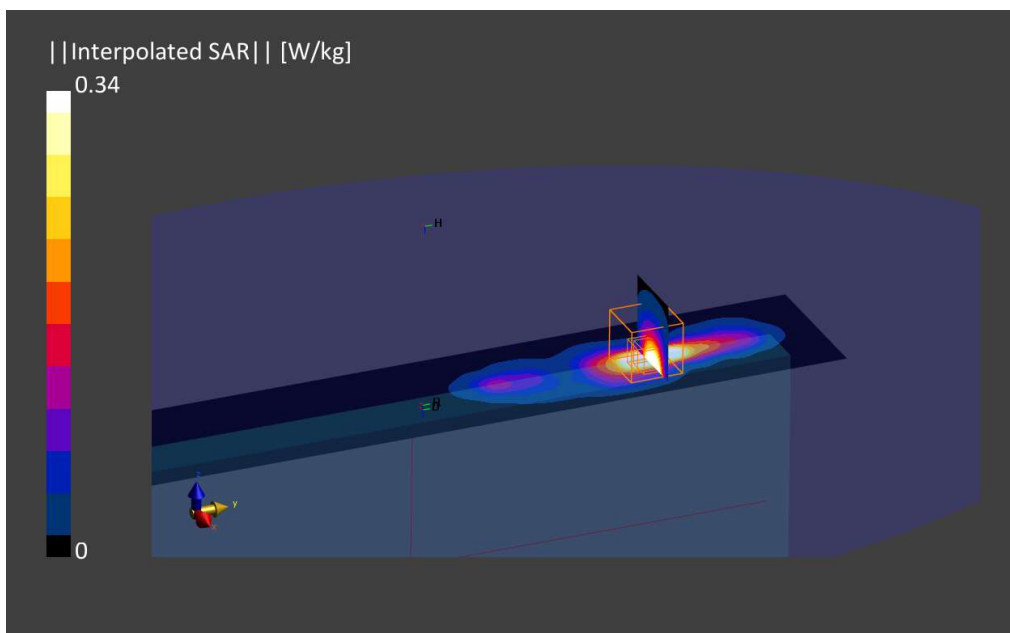

3. WCDMA V, RMC 12.2kbps, 5MHz, CH4183, Antenna Ant 5, Top edge

Device under Test Properties

Model, Manufacturer	Dimensions [mm]	S/N	DUT Type
HSC-I006R	300.0 x 220.0 x 17.0	C902NE00HT	Tablet

Exposure Conditions

Phantom Section, TSL	Position, Test Distance [mm]	Band	Group, UID	Frequency [MHz], Channel Number	Conversion Factor	TSL Conductivity [S/m]	TSL Permittivity
Flat, MSL	BACK, 0.00	Band 5, UTRA/FDD	WCDMA, 10011-CAB	836.6, 4183	9.25	0.96	57.4

Hardware Setup

Phantom	TSL, Measured Date	Probe, Calibration Date	DAE, Calibration Date
ELI V8.0 (20deg probe tilt)	MBBL-600-6000, 2022-Aug-23	EX3DV4 - SN3978, 2022-05-17	DAE Sn1703, 2022-04-28

Scan Setup

	Area Scan	Zoom Scan
Grid Extents [mm]	120.0 x 90.0	30.0 x 30.0 x 30.0
Grid Steps [mm]	15.0 x 15.0	6.0 x 6.0 x 1.5
Sensor Surface [mm]	3.0	1.4
Graded Grid	Yes	Yes
Grading Ratio	1.5	1.5
MAIA	Confirmed by MAIA	Confirmed by MAIA
Surface Detection	VMS + 6p	VMS + 6p
Scan Method	Measured	Measured

Measurement Results

	Area Scan	Zoom Scan
Date	2022-08-25, 10:14	2022-08-25, 10:20
psSAR1g [W/Kg]	0.676	0.689
psSAR10g [W/Kg]	0.430	0.367
Power Drift [dB]	-0.07	-0.06
Power Scaling	Disabled	Disabled
Scaling Factor [dB]		
TSL Correction	Positive Only	Positive Only
M2/M1 [%]		78.0
Dist 3dB Peak [mm]		9.7

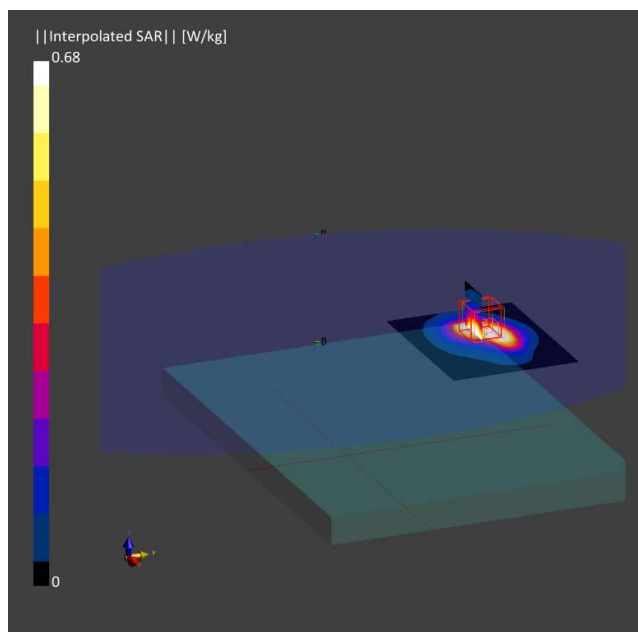

4. LTE Band 7, QPSK - 20MHz, CH21350, Antenna Ant 8, Top Edge

Device under Test Properties

Name, Manufacturer	Dimensions [mm]	S/N	DUT Type
HSC-I006R	300.0 x 220.0 x 17.0	C902NE00HT	Tablet

Exposure Conditions

Phantom Section, TSL	Position, Test Distance [mm]	Band	Group, UID	Frequency [MHz], Channel Number	Conversion Factor	TSL Conductivity [S/m]	TSL Permittivity
Flat, MSL	EDGE TOP, 0.00	Band 7, E-UTRA/FDD	LTE-FDD, 10169-CAE	2560.0, 21350	7.23	2.06	51.2

Hardware Setup

Phantom	TSL, Measured Date	Probe, Calibration Date	DAE, Calibration Date
ELI V8.0 (20deg probe tilt)	MABL-600-6000, 2022-Aug-10	EX3DV4 - SN3978, 2022-05-17	DAE4ip Sn1703, 2022-04-28

Scan Setup

	Area Scan	Zoom Scan
Grid Extents [mm]	60.0 x 340.0	30.0 x 30.0 x 30.0
Grid Steps [mm]	10.0 x 10.0	5.0 x 5.0 x 1.5
Sensor Surface [mm]	3.0	1.4
Graded Grid	Yes	Yes
Grading Ratio	1.5	1.5
MAIA	Confirmed by MAIA	Confirmed by MAIA
Surface Detection	VMS + 6p	VMS + 6p
Scan Method	Measured	Measured

Measurement Results

	Area Scan	Zoom Scan
Date	2022-08-11, 15:33	2022-08-11, 15:40
psSAR1g [W/Kg]	0.701	0.747
psSAR10g [W/Kg]	0.292	0.301
Power Drift [dB]	0.03	0.02
Power Scaling	Disabled	Disabled
Scaling Factor		
TSL Correction	Positive Only	Positive Only
M2/M1 [%]		71.6
Dist 3dB Peak [mm]		7.1

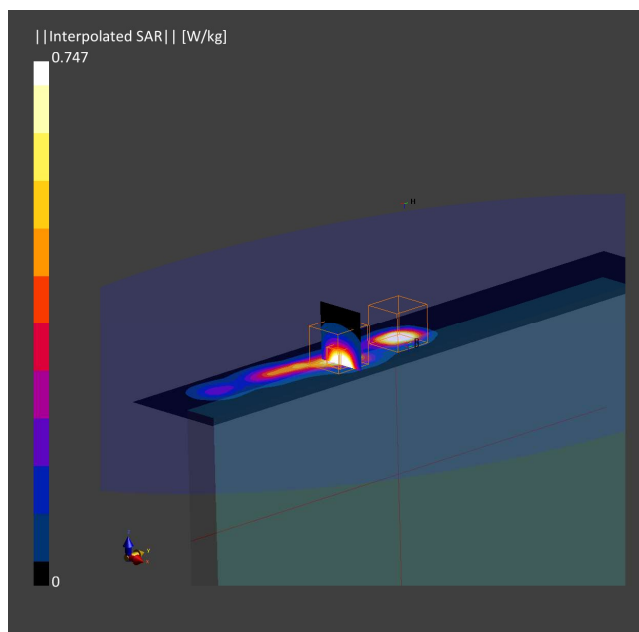

5. LTE Band 12, QPSK - 10MHz, CH23130, Antenna Ant 5, Back face

Device under Test Properties

Name, Manufacturer	Dimensions [mm]	S/N	DUT Type
HSC-I006R	300.0 x 220.0 x 17.0	C902NE00HT	Tablet

Exposure Conditions

Phantom Section, TSL	Position, Test Distance [mm]	Band	Group, UID	Frequency [MHz], Channel Number	Conversion Factor	TSL Conductivity [S/m]	TSL Permittivity
Flat, MSL	BACK, 0.00	Band 12, E-UTRA/FDD	LTE-FDD, 10175-CAG	711.0, 23130	9.65	0.895	55.7

Hardware Setup

Phantom	TSL, Measured Date	Probe, Calibration Date	DAE, Calibration Date
ELI V8.0 (20deg probe tilt)	MBBL-600-6000, 2022-Aug-16	EX3DV4 - SN3978, 2022-05-17	DAE4 Sn1703, 2022-04-28

Scan Setup

	Area Scan	Zoom Scan
Grid Extents [mm]	150.0 x 90.0	30.0 x 30.0 x 30.0
Grid Steps [mm]	15.0 x 15.0	6.0 x 6.0 x 1.5
Sensor Surface [mm]	3.0	1.4
Graded Grid	Yes	Yes
Grading Ratio	1.5	1.5
MAIA	Confirmed by MAIA	Confirmed by MAIA
Surface Detection	VMS + 6p	VMS + 6p
Scan Method	Measured	Measured

Measurement Results

	Area Scan	Zoom Scan
Date	2022-08-16, 12:56	2022-08-16, 13:02
psSAR1g [W/Kg]	0.880	0.877
psSAR10g [W/Kg]	0.546	0.495
Power Drift [dB]	0.01	0.02
Power Scaling	Disabled	Disabled
Scaling Factor [dB]		
TSL Correction	Positive Only	Positive Only
M2/M1 [%]		78.2
Dist 3dB Peak [mm]		9.7

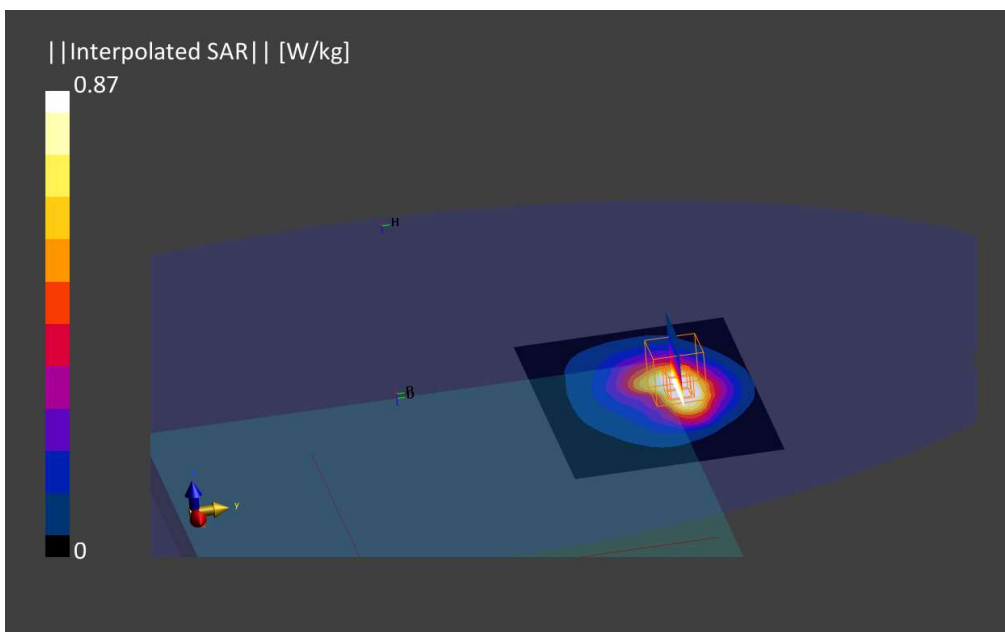

6. LTE Band 13, QPSK - 10MHz, CH23230, Antenna Ant 5, Back face

Device under Test Properties

Name, Manufacturer	Dimensions [mm]	S/N	DUT Type
HSC-I006R	300.0 x 220.0 x 17.0	C902NE00HT	Tablet

Exposure Conditions

Phantom Section, TSL	Position, Test Distance [mm]	Band	Group, UID	Frequency [MHz], Channel Number	Conversion Factor	TSL Conductivity [S/m]	TSL Permittivity
Flat, MSL	BACK, 0.00	Band 13, E-UTRA/FDD	LTE-FDD, 10175-CAG	782.0, 23230	9.65	0.921	55.5

Hardware Setup

Phantom	TSL, Measured Date	Probe, Calibration Date	DAE, Calibration Date
ELI V8.0 (20deg probe tilt)	MBBL-600-6000, 2022-Aug-16	EX3DV4 - SN3978, 2022-05-17	DAE4ip Sn1703, 2022-04-28

Scan Setup

	Area Scan	Zoom Scan
Grid Extents [mm]	150.0 x 90.0	30.0 x 30.0 x 30.0
Grid Steps [mm]	15.0 x 15.0	6.0 x 6.0 x 1.5
Sensor Surface [mm]	3.0	1.4
Graded Grid	Yes	Yes
Grading Ratio	1.5	1.5
MAIA	Confirmed by MAIA	Confirmed by MAIA
Surface Detection	VMS + 6p	VMS + 6p
Scan Method	Measured	Measured

Measurement Results

	Area Scan	Zoom Scan
Date	2022-08-16, 13:55	2022-08-16, 14:01
psSAR1g [W/Kg]	0.600	0.616
psSAR10g [W/Kg]	0.373	0.346
Power Drift [dB]	0.00	0.01
Power Scaling	Disabled	Disabled
Scaling Factor [dB]		
TSL Correction	Positive Only	Positive Only
M2/M1 [%]		78.5
Dist 3dB Peak [mm]		10.3

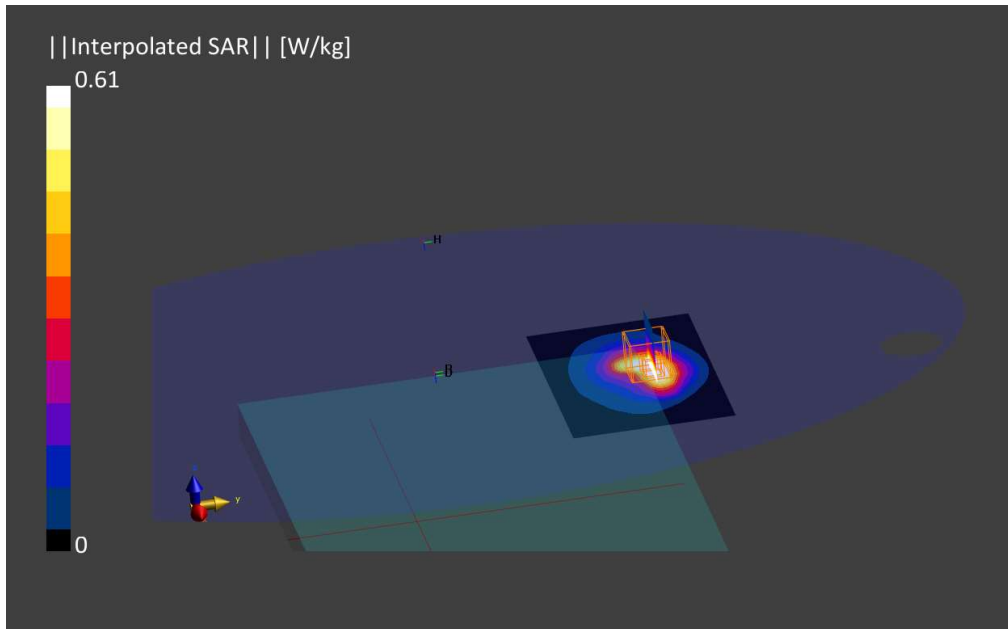

7. LTE Band 14, QPSK - 10MHz, CH23330, Antenna Ant 5, Back face

Device under Test Properties

Name, Manufacturer	Dimensions [mm]	S/N	DUT Type
HSC-I006R	300.0 x 220.0 x 17.0	C902NE00HT	Tablet

Exposure Conditions

Phantom Section, TSL	Position, Test Distance [mm]	Band	Group, UID	Frequency [MHz], Channel Number	Conversion Factor	TSL Conductivity [S/m]	TSL Permittivity
Flat, MSL	BACK, 0.00	Band 14, E-UTRA/FDD	LTE-FDD, 10175-CAG	793.0, 23330	9.65	0.926	55.5

Hardware Setup

Phantom	TSL, Measured Date	Probe, Calibration Date	DAE, Calibration Date
ELI V8.0 (20deg probe tilt)	MBBL-600-6000, 2022-Aug-16	EX3DV4 - SN3978, 2022-05-17	DAE4 Sn1703, 2022-04-28

Scan Setup

	Area Scan	Zoom Scan
Grid Extents [mm]	150.0 x 90.0	30.0 x 30.0 x 30.0
Grid Steps [mm]	15.0 x 15.0	6.0 x 6.0 x 1.5
Sensor Surface [mm]	3.0	1.4
Graded Grid	Yes	Yes
Grading Ratio	1.5	1.5
MAIA	Confirmed by MAIA	Confirmed by MAIA
Surface Detection	VMS + 6p	VMS + 6p
Scan Method	Measured	Measured

Measurement Results

	Area Scan	Zoom Scan
Date	2022-08-16, 14:35	2022-08-16, 14:41
psSAR1g [W/Kg]	0.456	0.472
psSAR10g [W/Kg]	0.284	0.266
Power Drift [dB]	-0.02	0.02
Power Scaling	Disabled	Disabled
Scaling Factor [dB]		
TSL Correction	Positive Only	Positive Only
M2/M1 [%]		78.7
Dist 3dB Peak [mm]		10.3

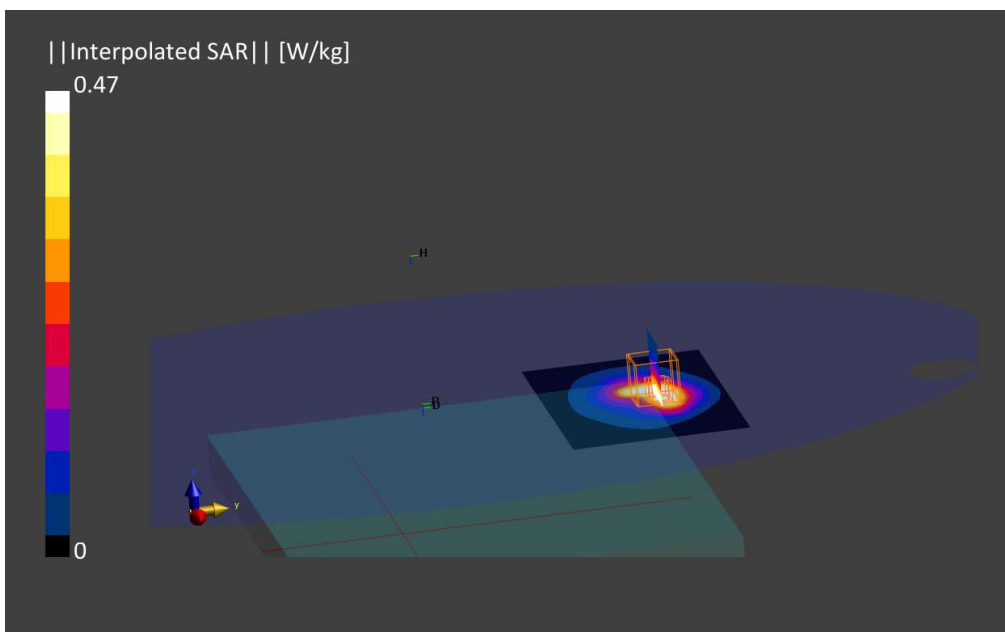

8. LTE Band 25, QPSK - 20MHz, CH26590, Antenna Ant 5, Back Face

Device under Test Properties

Model, Manufacturer	Dimensions [mm]	S/N	DUT Type
HSC-I006R	300.0 x 220.0 x 17.0	C902NE00HT	Tablet

Exposure Conditions

Phantom Section, TSL	Position, Test Distance [mm]	Band	Group, UID	Frequency [MHz], Channel Number	Conversion Factor	TSL Conductivity [S/m]	TSL Permittivity
Flat, MSL	BACK, 0.00	Band 25, E-UTRA/FDD	LTE-FDD, 10169-CAE	1905.0, 26590	8.06	1.54	53.7

Hardware Setup

Phantom	TSL, Measured Date	Probe, Calibration Date	DAE, Calibration Date
ELI V8.0 (20deg probe tilt)	MABL-600-6000, 2022-Aug-16	EX3DV4 - SN3978, 2022-05-17	DAE4 Sn1703, 2022-04-28

Scan Setup

	Area Scan	Zoom Scan
Grid Extents [mm]	120.0 x 90.0	30.0 x 30.0 x 30.0
Grid Steps [mm]	15.0 x 15.0	6.0 x 6.0 x 1.5
Sensor Surface [mm]	3.0	1.4
Graded Grid	Yes	Yes
Grading Ratio	1.5	1.5
MAIA	Confirmed by MAIA	Confirmed by MAIA
Surface Detection	VMS + 6p	VMS + 6p
Scan Method	Measured	Measured

Measurement Results

	Area Scan	Zoom Scan
Date	2022-08-16, 17:23	2022-08-16, 17:29
psSAR1g [W/Kg]	0.864	1.05
psSAR10g [W/Kg]	0.454	0.515
Power Drift [dB]	-0.10	-0.00
Power Scaling	Disabled	Disabled
Scaling Factor		
TSL Correction	Positive Only	Positive Only
M2/M1 [%]		81.9
Dist 3dB Peak [mm]		8.7

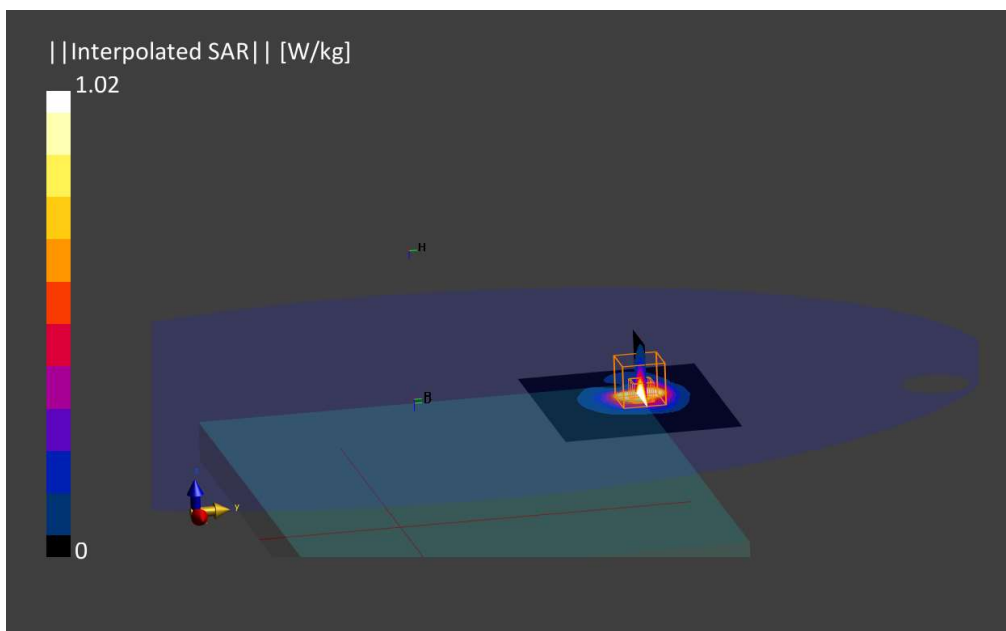

9. LTE Band 26, QPSK - 15MHz, CH26865, Antenna Ant 5, Back face

Device under Test Properties

Model, Manufacturer	Dimensions [mm]	S/N	DUT Type
HSC-I006R	300.0 x 220.0 x 17.0	C902NE00HT	Tablet

Exposure Conditions

Phantom Section, TSL	Position, Test Distance [mm]	Band	Group, UID	Frequency [MHz], Channel Number	Conversion Factor	TSL Conductivity [S/m]	TSL Permittivity
Flat, MSL	BACK, 0.00	Band 26 E-UTRA/FDD	LTE-FDD, 10181-CAE	831.5, 26865	9.25	0.941	55.4

Hardware Setup

Phantom	TSL, Measured Date	Probe, Calibration Date	DAE, Calibration Date
ELI V8.0 (20deg probe tilt)	MABL-600-6000, 2022-Aug-16	EX3DV4 - SN3978, 2022-05-17	DAE4ip Sn1703, 2022-04-28

Scan Setup

	Area Scan	Zoom Scan
Grid Extents [mm]	120.0 x 90.0	30.0 x 30.0 x 30.0
Grid Steps [mm]	15.0 x 15.0	6.0 x 6.0 x 1.5
Sensor Surface [mm]	3.0	1.4
Graded Grid	Yes	Yes
Grading Ratio	1.5	1.5
MAIA	Confirmed by MAIA	Confirmed by MAIA
Surface Detection	VMS + 6p	VMS + 6p
Scan Method	Measured	Measured

Measurement Results

	Area Scan	Zoom Scan
Date	2022-08-16, 15:06	2022-08-16, 15:12
psSAR1g [W/Kg]	0.380	0.402
psSAR10g [W/Kg]	0.240	0.221
Power Drift [dB]	-0.02	-0.01
Power Scaling	Disabled	Disabled
Scaling Factor [dB]		
TSL Correction	Positive Only	Positive Only
M2/M1 [%]		80.3
Dist 3dB Peak [mm]		10.3

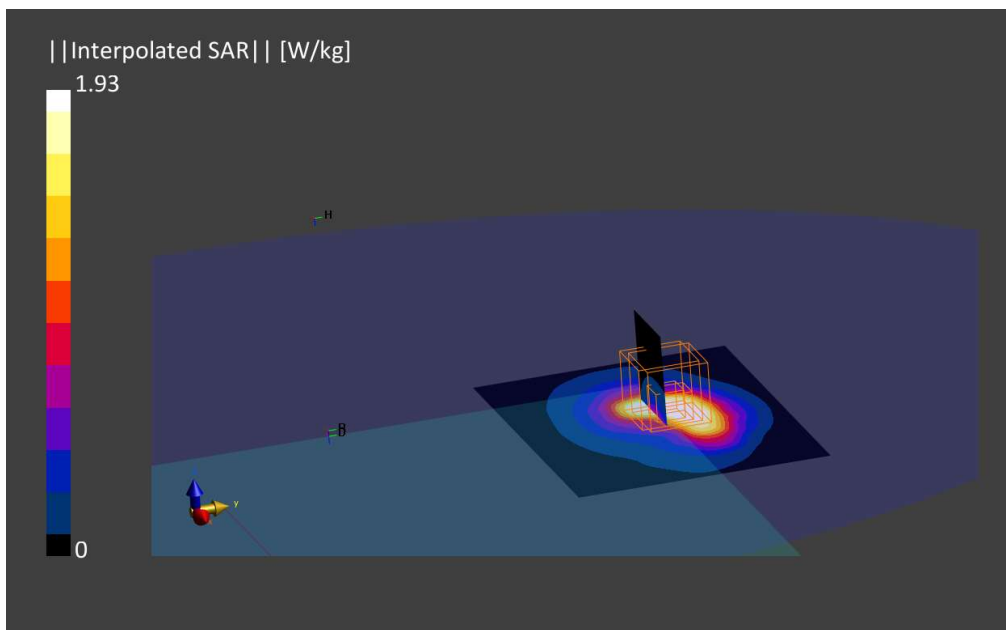

10. LTE Band 30 - 10MHz, CH27710, Antenna Ant 5, Back face

Device under Test Properties

Model, Manufacturer	Dimensions [mm]	S/N	DUT Type
HSC-I006R	300.0 x 220.0 x 17.0	C902NE00HT	Tablet

Exposure Conditions

Phantom Section, TSL	Position, Test Distance [mm]	Band	Group, UID	Frequency [MHz], Channel Number	Conversion Factor	TSL Conductivity [S/m]	TSL Permittivity
Flat, MSL	BACK, 0.00	Band 30, E-UTRA/FDD	LTE-FDD, 10175-CAG	2310.0, 27710	7.43	1.87	53.2

Hardware Setup

Phantom	TSL, Measured Date	Probe, Calibration Date	DAE, Calibration Date
ELI V8.0 (20deg probe tilt)	MABL-600-6000, 2022-Aug-16	EX3DV4 - SN3978, 2022-05-17	DAE4ip Sn1703, 2022-04-28

Scan Setup

	Area Scan	Zoom Scan
Grid Extents [mm]	120.0 x 80.0	30.0 x 30.0 x 30.0
Grid Steps [mm]	10.0 x 10.0	5.0 x 5.0 x 1.5
Sensor Surface [mm]	3.0	1.4
Graded Grid	Yes	Yes
Grading Ratio	1.5	1.5
MAIA	Confirmed by MAIA	Confirmed by MAIA
Surface Detection	VMS + 6p	VMS + 6p
Scan Method	Measured	Measured

Measurement Results

	Area Scan	Zoom Scan
Date	2022-08-16, 18:02	2022-08-16, 18:09
psSAR1g [W/Kg]	0.819	0.877
psSAR10g [W/Kg]	0.392	0.409
Power Drift [dB]	0.03	0.03
Power Scaling	Disabled	Disabled
Scaling Factor		
TSL Correction	Positive Only	Positive Only
M2/M1 [%]		80.8
Dist 3dB Peak [mm]		9.0

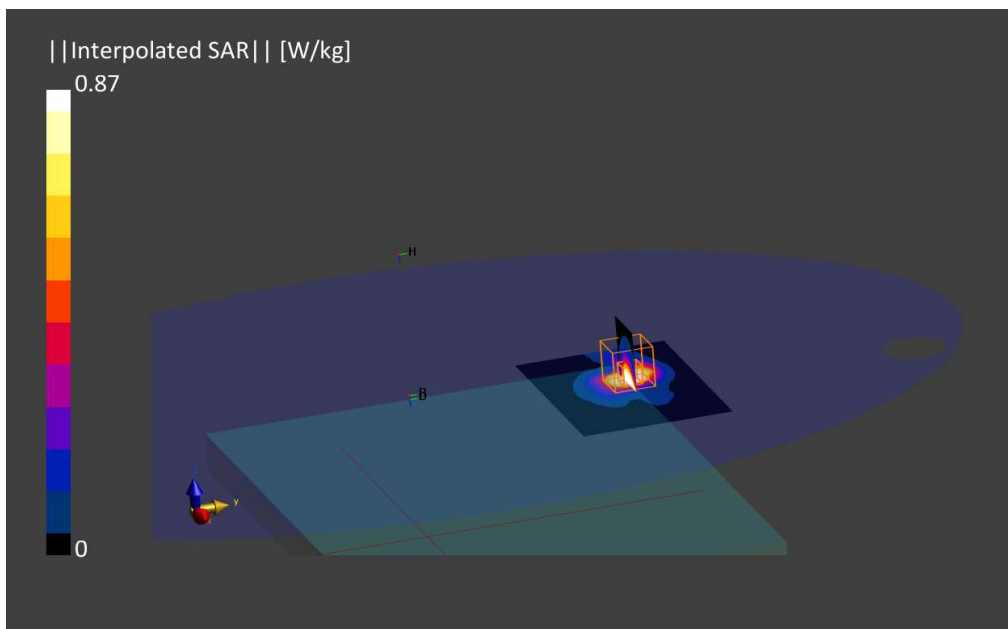

11. LTE Band 41, QPSK - 20MHz, CH40620, Antenna Ant 8, Top edge

Device under Test Properties

Model, Manufacturer	Dimensions [mm]	S/N	DUT Type
HSC-I006R	300.0 x 220.0 x 17.0	C902NE00HT	Tablet

Exposure Conditions

Phantom Section, TSL	Position, Test Distance [mm]	Band	Group, UID	Frequency [MHz], Channel Number	Conversion Factor	TSL Conductivity [S/m]	TSL Permittivity
Flat, MSL	EDGE TOP, 0.00	Band 41, E-UTRA/TDD	LTE-TDD, 10435-AAF	2593.0, 40620	7.23	2.09	51.1

Hardware Setup

Phantom	TSL, Measured Date	Probe, Calibration Date	DAE, Calibration Date
ELI V8.0 (20deg probe tilt)	MABL-600-6000, 2022-Aug-10	EX3DV4 - SN3978, 2022-05-17	DAE4ip Sn1703, 2022-04-28

Scan Setup

	Area Scan	Zoom Scan
Grid Extents [mm]	60.0 x 340.0	30.0 x 30.0 x 30.0
Grid Steps [mm]	10.0 x 10.0	5.0 x 5.0 x 1.5
Sensor Surface [mm]	3.0	1.4
Graded Grid	Yes	Yes
Grading Ratio	1.5	1.5
MAIA	Confirmed by MAIA	Confirmed by MAIA
Surface Detection	VMS + 6p	VMS + 6p
Scan Method	Measured	Measured

Measurement Results

	Area Scan	Zoom Scan
Date	2022-08-11, 13:19	2022-08-11, 13:26
psSAR1g [W/kg]	0.389	0.414
psSAR10g [W/kg]	0.161	0.168
Power Drift [dB]	0.03	0.02
Power Scaling	Disabled	Disabled
Scaling Factor [dB]		
TSL Correction	Positive Only	Positive Only
M2/M1 [%]		72.1
Dist 3dB Peak [mm]		7.3

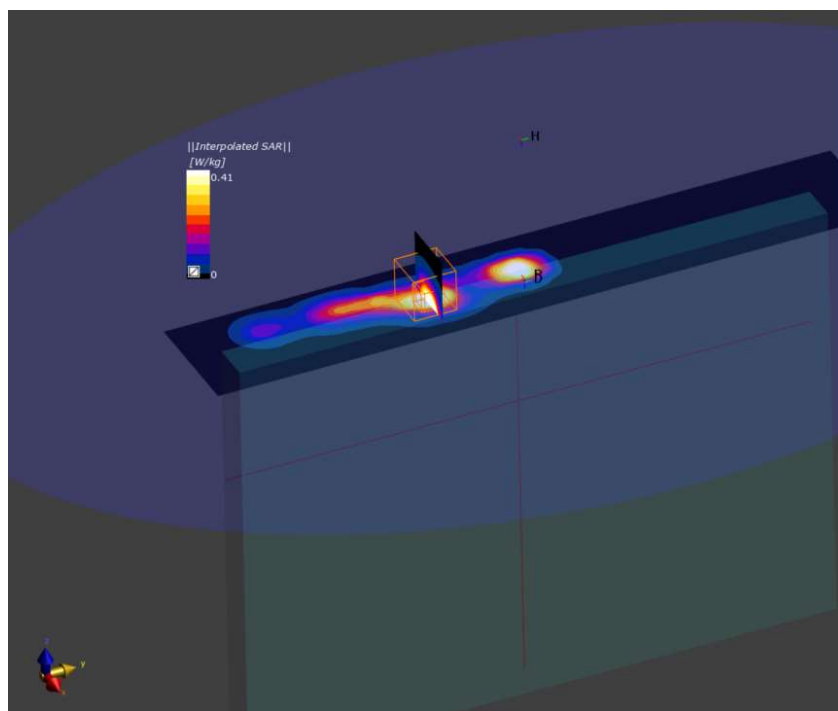

12. LTE Band 48, QPSK - 20MHz, CH55990, Antenna Ant 8, Top edge

Device under Test Properties

Model, Manufacturer	Dimensions [mm]	S/N	DUT Type
HSC-I006R	300.0 x 220.0 x 17.0	C902NE00HT	Tablet

Exposure Conditions

Phantom Section, TSL	Position, Test Distance [mm]	Band	Group, UID	Frequency [MHz], Channel Number	Conversion Factor	TSL Conductivity [S/m]	TSL Permittivity
Flat, MSL	EDGE TOP, 0.00	Band 48, E-UTRA/TDD	LTE-TDD, 10435-AAF	3625.0, 55990	6.03	3.20	49.1

Hardware Setup

Phantom	TSL, Measured Date	Probe, Calibration Date	DAE, Calibration Date
ELI V8.0 (20deg probe tilt)	MABL-600-6000, 2022-Aug-10	EX3DV4 - SN3978, 2022-05-17	DAE4ip Sn1703, 2022-04-28

Scan Setup

	Area Scan	Zoom Scan
Grid Extents [mm]	60.0 x 340.0	28.0 x 28.0 x 28.0
Grid Steps [mm]	10.0 x 10.0	5.0 x 5.0 x 1.4
Sensor Surface [mm]	3.0	1.4
Graded Grid	Yes	Yes
Grading Ratio	1.5	1.5
MAIA	Confirmed by MAIA	Confirmed by MAIA
Surface Detection	VMS + 6p	VMS + 6p
Scan Method	Measured	Measured

Measurement Results

	Area Scan	Zoom Scan
Date	2022-08-11, 14:29	2022-08-11, 14:36
psSAR1g [W/Kg]	0.424	0.460
psSAR10g [W/Kg]	0.144	0.155
Power Drift [dB]	-0.01	0.01
Power Scaling	Disabled	Disabled
Scaling Factor [dB]		
TSL Correction	Positive Only	Positive Only
M2/M1 [%]		75.7
Dist 3dB Peak [mm]		6.7

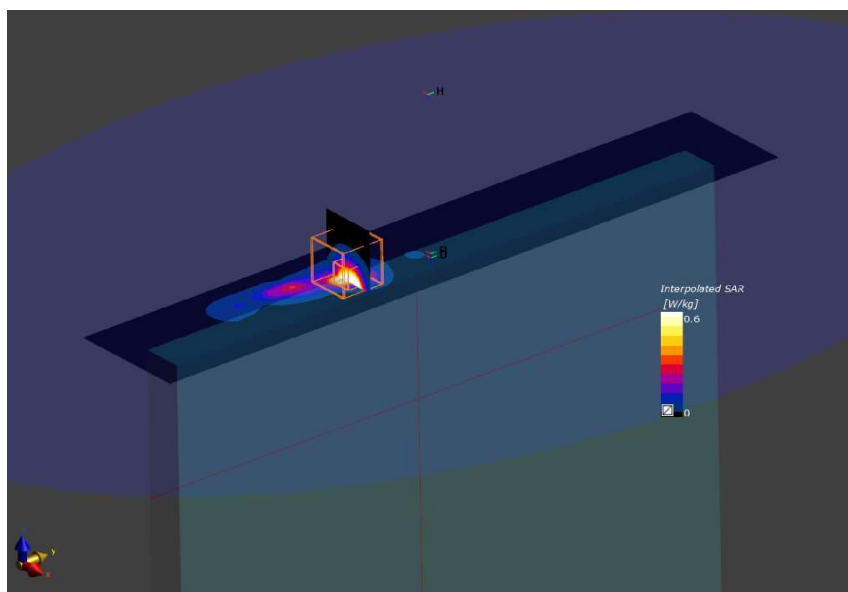

13. LTE Band 66, QPSK - 20MHz, CH132572, Antenna Ant 5, Back Face

Device under Test Properties

Model, Manufacturer	Dimensions [mm]	S/N	DUT Type
HSC-I006R	300.0 x 220.0 x 17.0	C902NE00HT	Tablet

Exposure Conditions

Phantom Section, TSL	Position, Test Distance [mm]	Band	Group, UID	Frequency [MHz], Channel Number	Conversion Factor	TSL Conductivity [S/m]	TSL Permittivity
Flat, MSL	BACK, 0.00	Band 66, E-UTRA/FDD	LTE-FDD, 10169-CAE	1770.0, 132572	8.42	1.45	53.9

Hardware Setup

Phantom	TSL, Measured Date	Probe, Calibration Date	DAE, Calibration Date
ELI V8.0 (20deg probe tilt)	MBBL-600-6000, 2022-Aug-16	EX3DV4 - SN3978, 2022-05-17	DAE4ip Sn1703, 2022-04-28

Scan Setup

	Area Scan	Zoom Scan
Grid Extents [mm]	120.0 x 90.0	30.0 x 30.0 x 30.0
Grid Steps [mm]	15.0 x 15.0	6.0 x 6.0 x 1.5
Sensor Surface [mm]	3.0	1.4
Graded Grid	Yes	Yes
Grading Ratio	1.5	1.5
MAIA	Confirmed by MAIA	Confirmed by MAIA
Surface Detection	VMS + 6p	VMS + 6p
Scan Method	Measured	Measured

Measurement Results

	Area Scan	Zoom Scan
Date	2022-08-17, 08:25	2022-08-17, 08:32
psSAR1g [W/Kg]	0.903	1.13
psSAR10g [W/Kg]	0.503	0.598
Power Drift [dB]	0.00	-0.00
Power Scaling	Disabled	Disabled
Scaling Factor [dB]		
TSL Correction	Positive Only	Positive Only
M2/M1 [%]		81.0
Dist 3dB Peak [mm]		9.6

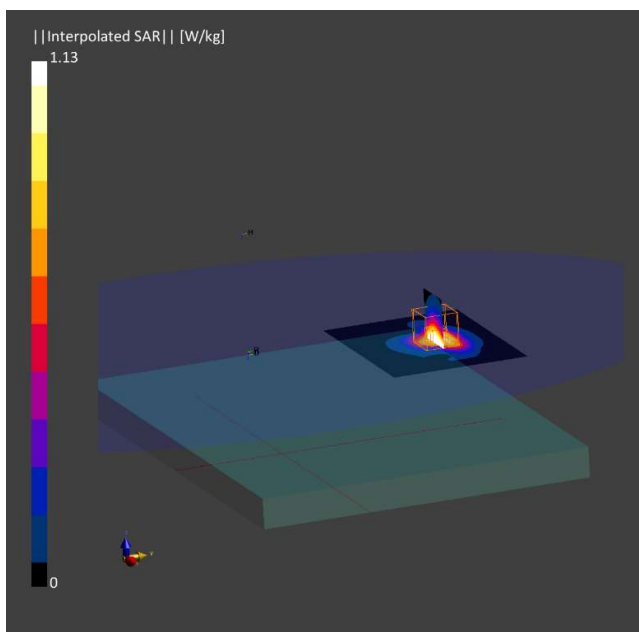

14. 5G NR FR1 Band 2, QPSK - 20MHz, CH376000, Antenna 8, Top Edge

Device under Test Properties

Name, Manufacturer	Dimensions [mm]	S/N	DUT Type
HSC-I006R	300.0 x 220.0 x 17.0	C892NE008Q	Tablet

Exposure Conditions

Phantom Section, TSL	Position, Test Distance [mm]	Band	Group, UID	Frequency [MHz], Channel Number	Conversion Factor	TSL Conductivity [S/m]	TSL Permittivity
Flat, MSL	EDGE TOP, 0.00	Band n2	5G NR FR1 FDD, 10939-AAB	1880.0, 376000	7.59	1.59	53.0

Hardware Setup

Phantom	TSL, Measured Date	Probe, Calibration Date	DAE, Calibration Date
ELI V8.0 (20deg probe tilt) - 2124	MBBL-600-6000,2022-Aug-29	EX3DV4 - SN7455, 2022-03-21	DAE4 Sn1517, 2022-03-17

Scan Setup

	Area Scan	Zoom Scan
Grid Extents [mm]	160.0 x 100.0	30.0 x 30.0 x 30.0
Grid Steps [mm]	10.0 x 10.0	6.0 x 6.0 x 1.5
Sensor Surface [mm]	3.0	1.4
Graded Grid	Yes	Yes
Grading Ratio	1.5	1.5
MAIA	Confirmed by MAIA	Confirmed by MAIA
Surface Detection	Yes	Yes
Scan Method	Measured	Measured

Measurement Results

	Area Scan	Zoom Scan
Date	2022-08-29, 16:15	2022-08-29, 16:22
SAR1g [W/Kg]	0.239	0.245
SAR10g [W/Kg]	0.123	0.120
Power Drift [dB]	0.06	-0.05
Power Scaling	Disabled	Disabled
Scaling Factor [dB]		
TSL Correction	Positive Only	Positive Only

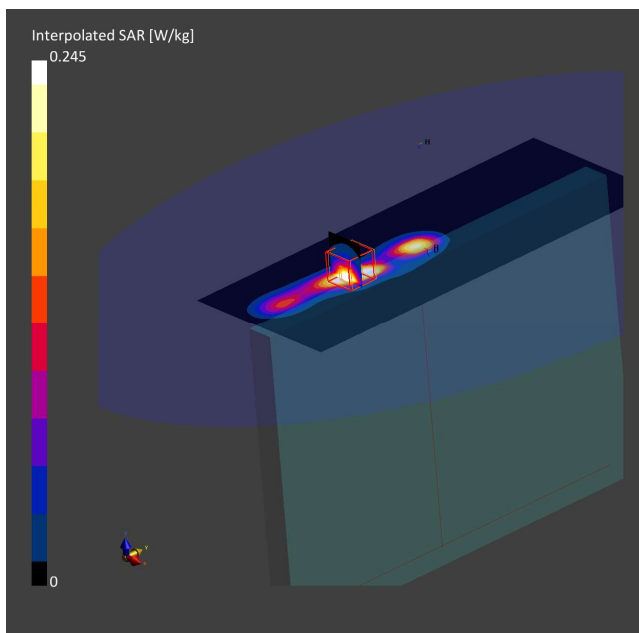

15. 5G NR FR1 Band 5, QPSK - 10MHz, CH167300, Antenna 5, Back Face

Device under Test Properties

Name, Manufacturer	Dimensions [mm]	S/N	DUT Type
HSC-I006R	300.0 x 220.0 x 17.0	C892NE008Q	Tablet

Exposure Conditions

Phantom Section, TSL	Position, Test Distance [mm]	Band	Group, UID	Frequency [MHz], Channel Number	Conversion Factor	TSL Conductivity [S/m]	TSL Permittivity
Flat MSL	BACK, 0.00	Band n5	5G NR FR1 FDD, 10939-AAB	836.5, 167300	9.34	0.997	53.8

Hardware Setup

Phantom	TSL, Measured Date	Probe, Calibration Date	DAE, Calibration Date
ELI V8.0 (20deg probe tilt) - 2124	MBBL-600-6000,2022-Aug-29	EX3DV4 - SN7455, 2022-03-21	DAE4 Sn1517, 2022-03-17

Scan Setup

	Area Scan	Zoom Scan
Grid Extents [mm]	100.0 x 160.0	30.0 x 30.0 x 30.0
Grid Steps [mm]	10.0 x 10.0	6.0 x 6.0 x 1.5
Sensor Surface [mm]	3.0	1.4
Graded Grid	Yes	Yes
Grading Ratio	1.5	1.5
MAIA	Confirmed by MAIA	Confirmed by MAIA
Surface Detection	Yes	Yes
Scan Method	Measured	Measured

Measurement Results

	Area Scan	Zoom Scan
Date	2022-08-29, 12:02	2022-08-29, 12:10
SAR1g [W/Kg]	0.336	0.328
SAR10g [W/Kg]	0.207	0.182
Power Drift [dB]	0.08	0.03
Power Scaling	Disabled	Disabled
Scaling Factor [dB]		
TSL Correction	Positive Only	Positive Only

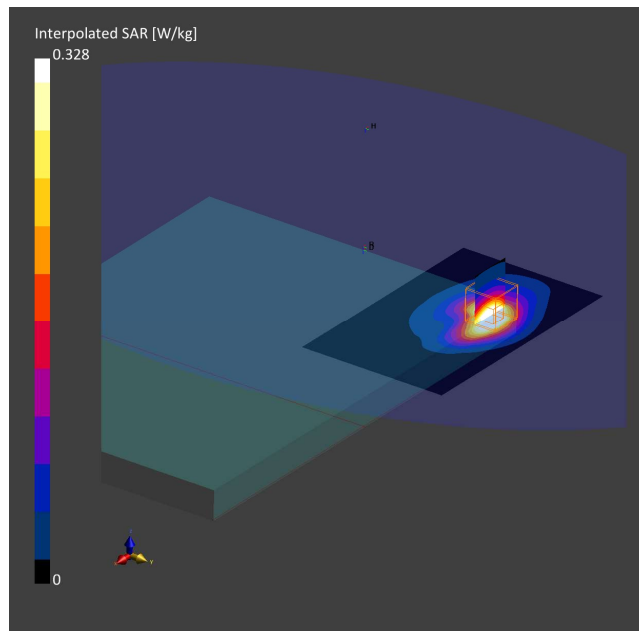

16. 5G NR FR1 Band 7, QPSK - 20MHz, CH167300, Antenna 5, Back Face

Device under Test Properties

Name, Manufacturer	Dimensions [mm]	S/N	DUT Type
HSC-I006R	300.0 x 220.0 x 17.0	C892NE008Q	Tablet

Exposure Conditions

Phantom Section, TSL	Position, Test Distance [mm]	Band	Group, UID	Frequency [MHz], Channel Number	Conversion Factor	TSL Conductivity [S/m]	TSL Permittivity
Flat MSL	BACK, 0.00	Band n7	5G NR FR1 FDD, 10939-AAB	2535.0, 507000	7.3	2.17	52.0

Hardware Setup

Phantom	TSL, Measured Date	Probe, Calibration Date	DAE, Calibration Date
ELI V8.0 (20deg probe tilt) - 2124	MABL-600-6000,2022-Aug-29	EX3DV4 - SN7455, 2022-03-21	DAE4 Sn1517, 2022-03-17

Scan Setup

	Area Scan	Zoom Scan
Grid Extents [mm]	80.0 x 300.0	30.0 x 30.0 x 30.0
Grid Steps [mm]	10.0 x 10.0	4.8 x 4.8 x 1.5
Sensor Surface [mm]	3.0	1.4
Graded Grid	Yes	Yes
Grading Ratio	1.5	1.5
MAIA	Confirmed by MAIA	Confirmed by MAIA
Surface Detection	Yes	Yes
Scan Method	Measured	Measured

Measurement Results

	Area Scan	Zoom Scan
Date	2022-08-29, 10:21	2022-08-29, 10:30
SAR1g [W/Kg]	0.618	0.616
SAR10g [W/Kg]	0.295	0.275
Power Drift [dB]	-0.11	-0.03
Power Scaling	Disabled	Disabled
Scaling Factor [dB]		
TSL Correction	Positive Only	Positive Only

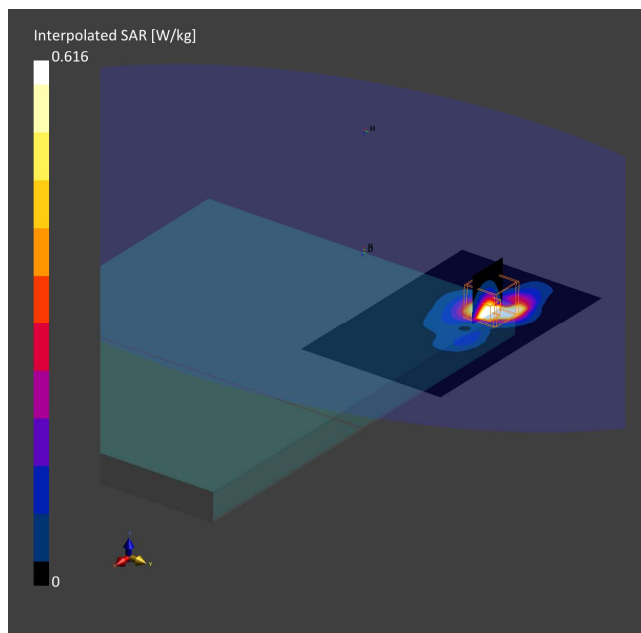

17. 5G NR FR1 Band 25, QPSK - 20MHz, CH376500, Antenna 5, Top Edge

Device under Test Properties

Name, Manufacturer	Dimensions [mm]	S/N	DUT Type
HSC-I006R	300.0 x 220.0 x 17.0	C892NE008Q	Tablet

Exposure Conditions

Phantom Section, TSL	Position, Test Distance [mm]	Band	Group, UID	Frequency [MHz], Channel Number	Conversion Factor	TSL Conductivity [S/m]	TSL Permittivity
Flat MSL	EDGE TOP, 0.00	Band n25	5G NR FR1 FDD, 10931-AAB	1882.5, 376000	7.59	1.59	53.0

Hardware Setup

Phantom	TSL, Measured Date	Probe, Calibration Date	DAE, Calibration Date
ELI V8.0 (20deg probe tilt) - 2124	MABL-600-6000,2022-Aug-29	EX3DV4 - SN7455, 2022-03-21	DAE4 Sn1517, 2022-03-17

Scan Setup

	Area Scan	Zoom Scan
Grid Extents [mm]	80.0 x 300.0	30.0 x 30.0 x 30.0
Grid Steps [mm]	10.0 x 10.0	4.8 x 4.8 x 1.5
Sensor Surface [mm]	3.0	1.4
Graded Grid	Yes	Yes
Grading Ratio	1.5	1.5
MAIA	Confirmed by MAIA	Confirmed by MAIA
Surface Detection	Yes	Yes
Scan Method	Measured	Measured

Measurement Results

	Area Scan	Zoom Scan
Date	2022-08-30, 09:55	2022-08-30, 10:02
SAR1g [W/Kg]	0.445	0.436
SAR10g [W/Kg]	0.225	0.222
Power Drift [dB]	-0.00	0.03
Power Scaling	Disabled	Disabled
Scaling Factor [dB]		
TSL Correction	Positive Only	Positive Only

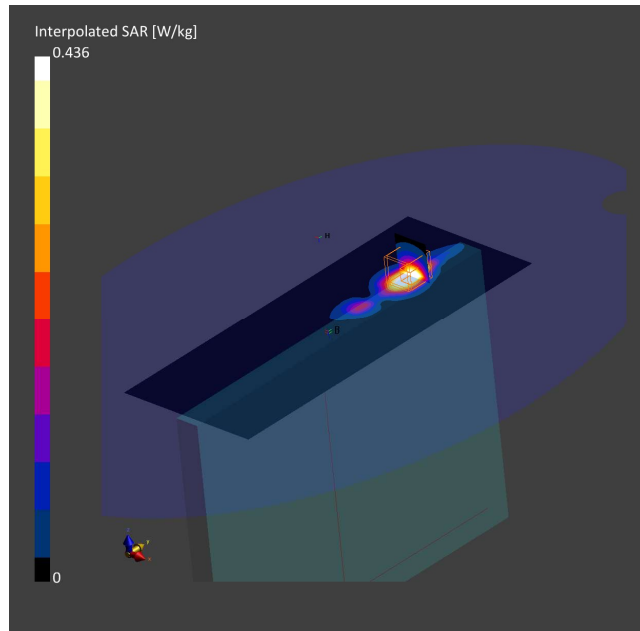

18. 5G NR FR1 Band 30, QPSK - 20MHz, CH462000, Antenna 5, Back Face

Device under Test Properties

Name, Manufacturer	Dimensions [mm]	S/N	DUT Type
HSC-I006R	300.0 x 220.0 x 17.0	C892NE008Q	Tablet

Exposure Conditions

Phantom Section, TSL	Position, Test Distance [mm]	Band	Group, UID	Frequency [MHz], Channel Number	Conversion Factor	TSL Conductivity [S/m]	TSL Permittivity
Flat MSL	BACK, 0.00	Band n30	5G NR FR1 FDD, 10937-AAB	2310.0, 462000	7.51	1.93	52.4

Hardware Setup

Phantom	TSL, Measured Date	Probe, Calibration Date	DAE, Calibration Date
ELI V8.0 (20deg probe tilt) - 2124	MBBL-600-6000,2022-Aug-29	EX3DV4 - SN7455, 2022-03-21	DAE4 Sn1517, 2022-03-17

Scan Setup

	Area Scan	Zoom Scan
Grid Extents [mm]	80.0 x 300.0	30.0 x 30.0 x 30.0
Grid Steps [mm]	10.0 x 10.0	4.8 x 4.8 x 1.5
Sensor Surface [mm]	3.0	1.4
Graded Grid	Yes	Yes
Grading Ratio	1.5	1.5
MAIA	Confirmed by MAIA	Confirmed by MAIA
Surface Detection	Yes	Yes
Scan Method	Measured	Measured

Measurement Results

	Area Scan	Zoom Scan
Date	2022-08-29, 15:07	2022-08-29, 15:23
SAR1g [W/Kg]	0.810	0.809
SAR10g [W/Kg]	0.354	0.344
Power Drift [dB]	0.02	-0.02
Power Scaling	Disabled	Disabled
Scaling Factor [dB]		
TSL Correction	Positive Only	Positive Only

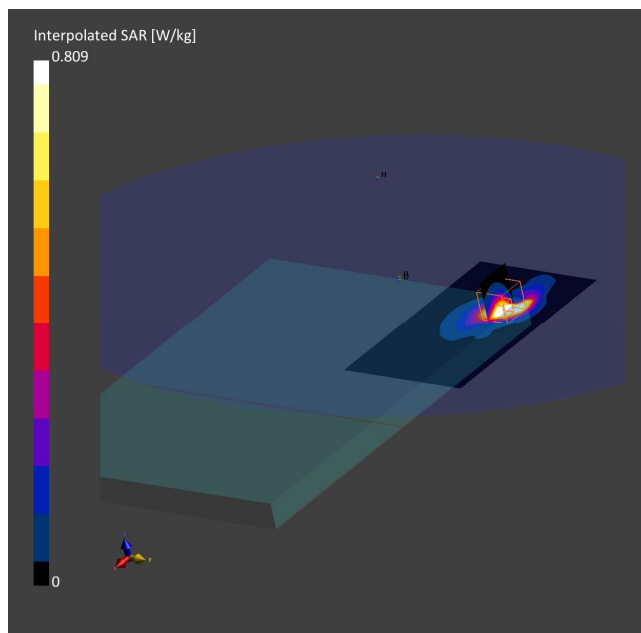

19. 5G NR FR1 Band 38, QPSK - 40MHz, CH519000, Antenna 8, Top Edge

Device under Test Properties

Name, Manufacturer	Dimensions [mm]	S/N	DUT Type
HSC-I006R	300.0 x 220.0 x 17.0	C892NE008Q	Tablet

Exposure Conditions

Phantom Section, TSL	Position, Test Distance [mm]	Band	Group, UID	Frequency [MHz], Channel Number	Conversion Factor	TSL Conductivity [S/m]	TSL Permittivity
Flat MSL	EDGE TOP, 0.00	Band n38	5G NR FR1 TDD, 10903-AAB	2595.0, 519000	7.3	2.23	51.9

Hardware Setup

Phantom	TSL, Measured Date	Probe, Calibration Date	DAE, Calibration Date
ELI V8.0 (20deg probe tilt) - 2124	MABL-600-6000,2022-Aug-29	EX3DV4 - SN7455, 2022-03-21	DAE4 Sn1517, 2022-03-17

Scan Setup

	Area Scan	Zoom Scan
Grid Extents [mm]	80.0 x 300.0	30.0 x 30.0 x 30.0
Grid Steps [mm]	10.0 x 10.0	4.8 x 4.8 x 1.5
Sensor Surface [mm]	3.0	1.4
Graded Grid	Yes	Yes
Grading Ratio	1.5	1.5
MAIA	Confirmed by MAIA	Confirmed by MAIA
Surface Detection	Yes	Yes
Scan Method	Measured	Measured

Measurement Results

	Area Scan	Zoom Scan
Date	2022-08-31, 08:50	2022-08-31, 08:59
SAR1g [W/Kg]	0.072	0.074
SAR10g [W/Kg]	0.031	0.029
Power Drift [dB]	0.14	-0.17
Power Scaling	Disabled	Disabled
Scaling Factor [dB]		
TSL Correction	Positive Only	Positive Only

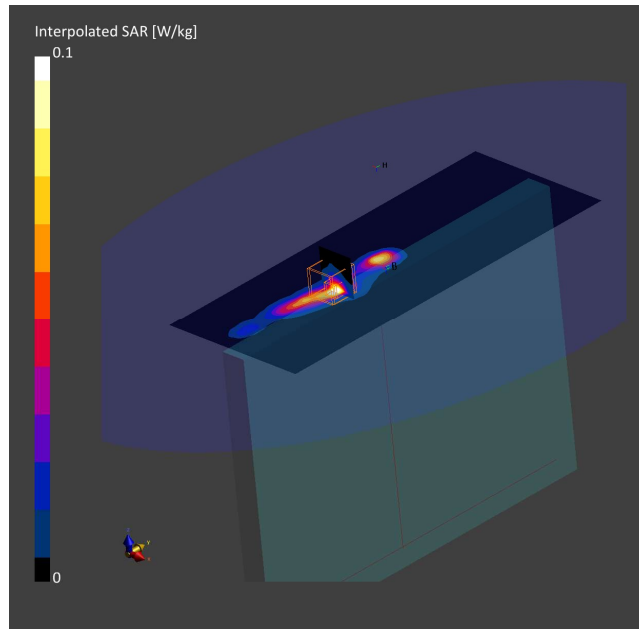

20. 5G NR FR1 Band 41, QPSK - 100MHz, CH518598, Antenna 5, Top Edge

Device under Test Properties

Name, Manufacturer	Dimensions [mm]	S/N	DUT Type
HSC-I006R	300.0 x 220.0 x 17.0	C892NE008Q	Tablet

Exposure Conditions

Phantom Section, TSL	Position, Test Distance [mm]	Band	Group, UID	Frequency [MHz], Channel Number	Conversion Factor	TSL Conductivity [S/m]	TSL Permittivity
Flat MSL	EDGE TOP, 0.00	Band n41	5G NR FR1 TDD, 10973-AAA	2593.0, 518598	7.3	2.22	51.9

Hardware Setup

Phantom	TSL, Measured Date	Probe, Calibration Date	DAE, Calibration Date
ELI V8.0 (20deg probe tilt) - 2124	MBBL-600-6000,2022-Aug-29	EX3DV4 - SN7455, 2022-03-21	DAE4 Sn1517, 2022-03-17

Scan Setup

	Area Scan	Zoom Scan
Grid Extents [mm]	100.0 x 100.0	30.0 x 30.0 x 30.0
Grid Steps [mm]	10.0 x 10.0	5.0 x 5.0 x 1.5
Sensor Surface [mm]	3.0	1.4
Graded Grid	Yes	Yes
Grading Ratio	1.5	1.5
MAIA	Confirmed by MAIA	Confirmed by MAIA
Surface Detection	Yes	Yes
Scan Method	Measured	Measured

Measurement Results

	Area Scan	Zoom Scan
Date	2022-08-30, 21:22	2022-08-30, 21:32
SAR1g [W/Kg]	0.072	0.077
SAR10g [W/Kg]	0.028	0.024
Power Drift [dB]	-0.07	-0.12
Power Scaling	Disabled	Disabled
Scaling Factor [dB]		
TSL Correction	Positive Only	Positive Only

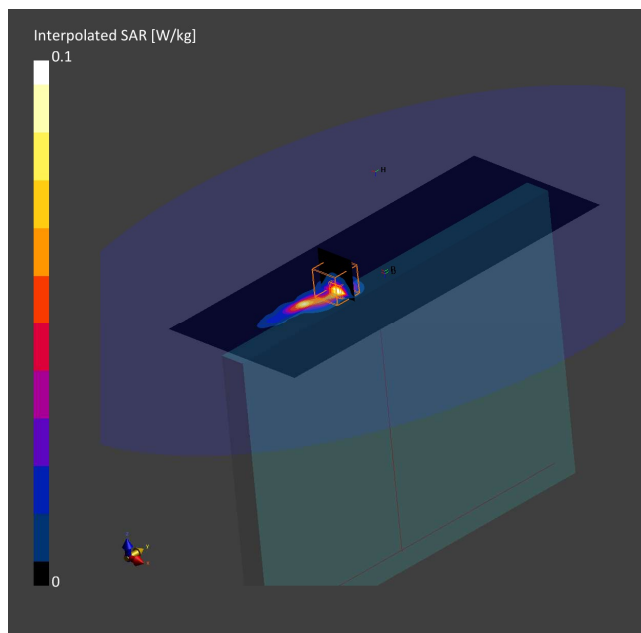

21. 5G NR FR1 Band 66, QPSK - 40MHz, CH349000, Antenna 8, Top Edge

Device under Test Properties

Name, Manufacturer	Dimensions [mm]	S/N	DUT Type
HSC-I006R	300.0 x 220.0 x 17.0	C892NE008Q	Tablet

Exposure Conditions

Phantom Section, TSL	Position, Test Distance [mm]	Band	Group, UID	Frequency [MHz], Channel Number	Conversion Factor	TSL Conductivity [S/m]	TSL Permittivity
Flat MSL	EDGE TOP, 0.00	Band n66	5G NR FR1 FDD, 10942-AAB	1745.0, 349000	7.91	1.50	53.2

Hardware Setup

Phantom	TSL, Measured Date	Probe, Calibration Date	DAE, Calibration Date
ELI V8.0 (20deg probe tilt) - 2124	MABL-600-6000,2022-Aug-29	EX3DV4 - SN7455, 2022-03-21	DAE4 Sn1517, 2022-03-17

Scan Setup

	Area Scan	Zoom Scan
Grid Extents [mm]	80.0 x 400.0	30.0 x 30.0 x 30.0
Grid Steps [mm]	10.0 x 10.0	6.0 x 6.0 x 1.5
Sensor Surface [mm]	3.0	1.4
Graded Grid	Yes	Yes
Grading Ratio	1.5	1.5
MAIA	Confirmed by MAIA	Confirmed by MAIA
Surface Detection	Yes	Yes
Scan Method	Measured	Measured

Measurement Results

	Area Scan	Zoom Scan
Date	2022-08-29, 17:21	2022-08-29, 17:38
SAR1g [W/Kg]	0.566	0.583
SAR10g [W/Kg]	0.300	0.274
Power Drift [dB]	-0.08	0.06
Power Scaling	Disabled	Disabled
Scaling Factor [dB]		
TSL Correction	Positive Only	Positive Only

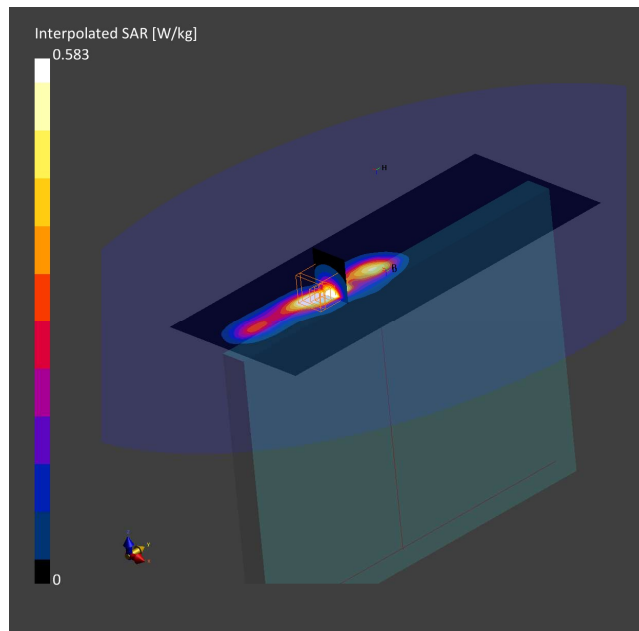

22. 5G NR FR1 Band 77, QPSK - 100MHz, CH650000, Antenna 8, Top Edge

Device under Test Properties

Name, Manufacturer	Dimensions [mm]	S/N	DUT Type
HSC-I006R	300.0 x 220.0 x 17.0	C892NE008Q	Tablet

Exposure Conditions

Phantom Section, TSL	Position, Test Distance [mm]	Band	Group, UID	Frequency [MHz], Channel Number	Conversion Factor	TSL Conductivity [S/m]	TSL Permittivity
Flat MSL	EDGE TOP, 0.00	Band n77	5G NR FR1 TDD, 10973-AAA	3750.0, 650000	6.13	3.48	48.9

Hardware Setup

Phantom	TSL, Measured Date	Probe, Calibration Date	DAE, Calibration Date
ELI V8.0 (20deg probe tilt) - 2124	MABL-600-6000,2022-Aug-29	EX3DV4 - SN7455, 2022-03-21	DAE4 Sn1517, 2022-03-17

Scan Setup

	Area Scan	Zoom Scan
Grid Extents [mm]	80.0 x 80.0	28.0 x 28.0 x 28.0
Grid Steps [mm]	10.0 x 10.0	5.0 x 5.0 x 1.4
Sensor Surface [mm]	3.0	1.4
Graded Grid	Yes	Yes
Grading Ratio	1.5	1.5
MAIA	Confirmed by MAIA	Confirmed by MAIA
Surface Detection	Yes	Yes
Scan Method	Measured	Measured

Measurement Results

	Area Scan	Zoom Scan
Date	2022-08-30, 18:44	2022-08-30, 18:55
SAR1g [W/Kg]	0.127	0.140
SAR10g [W/Kg]	0.044	0.044
Power Drift [dB]	0.02	0.01
Power Scaling	Disabled	Disabled
Scaling Factor [dB]		
TSL Correction	Positive Only	Positive Only

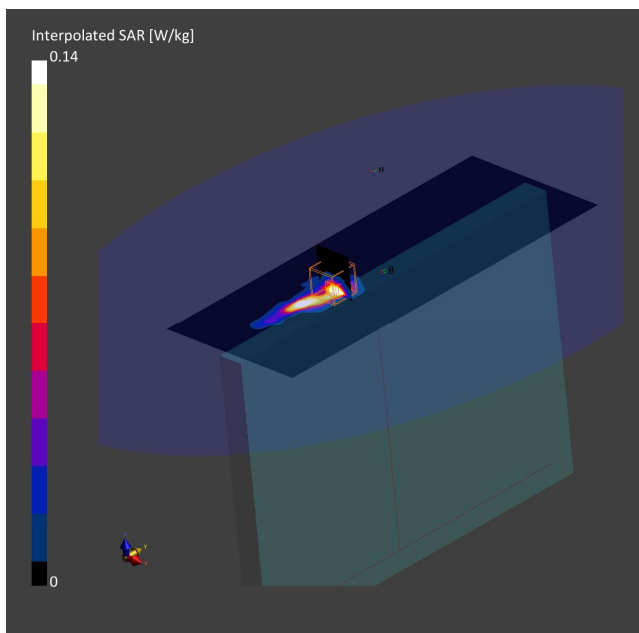

23. 5G NR FR1 Band 78, QPSK - 100MHz, CH650000, Antenna 5, Top Edge

Device under Test Properties

Name, Manufacturer	Dimensions [mm]	S/N	DUT Type
HSC-I006R	300.0 x 220.0 x 17.0	C892NE008Q	Tablet

Exposure Conditions

Phantom Section, TSL	Position, Test Distance [mm]	Band	Group, UID	Frequency [MHz], Channel Number	Conversion Factor	TSL Conductivity [S/m]	TSL Permittivity
Flat MSL	EDGE TOP, 0.00	Band n78	5G NR FR1 TDD, 10917-AAB	3550.0, 636666	6.15	3.25	49.4

Hardware Setup

Phantom	TSL, Measured Date	Probe, Calibration Date	DAE, Calibration Date
ELI V8.0 (20deg probe tilt) - 2124	MBBL-600-6000,2022-Aug-29	EX3DV4 - SN7455, 2022-03-21	DAE4 Sn1517, 2022-03-17

Scan Setup

	Area Scan	Zoom Scan
Grid Extents [mm]	120.0 x 100.0	28.0 x 28.0 x 28.0
Grid Steps [mm]	10.0 x 10.0	5.0 x 5.0 x 1.4
Sensor Surface [mm]	3.0	1.4
Graded Grid	Yes	Yes
Grading Ratio	1.5	1.5
MAIA	Confirmed by MAIA	Confirmed by MAIA
Surface Detection	Yes	Yes
Scan Method	Measured	Measured

Measurement Results

	Area Scan	Zoom Scan
Date	2022-08-30, 19:11	2022-08-30, 19:21
SAR1g [W/Kg]	0.118	0.130
SAR10g [W/Kg]	0.042	0.040
Power Drift [dB]	0.02	-0.03
Power Scaling	Disabled	Disabled
Scaling Factor [dB]		
TSL Correction	Positive Only	Positive Only

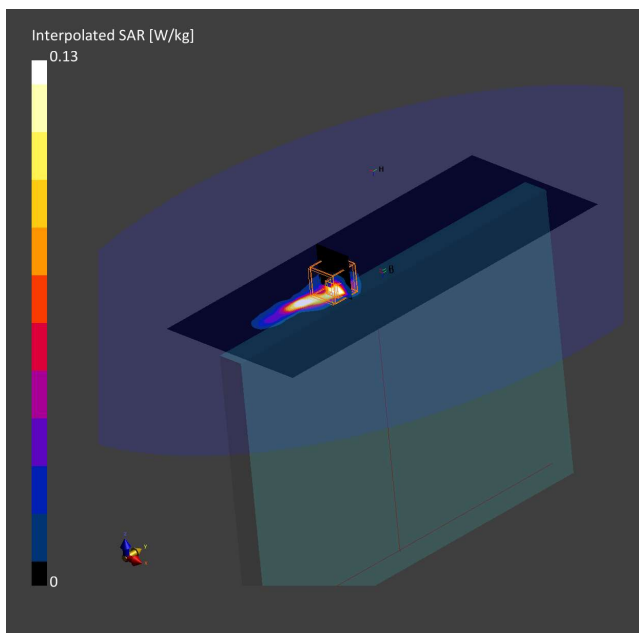

24. System Check Body Liquid 750MHz – 2022-08-16 – System2

Device under Test Properties

Name, Manufacturer	Dimensions [mm]	Serial Number	DUT Type
Dipole 750MHz, SPEAG	50.0 x 10.0 x 8.0	1136	Validation Dipole

Exposure Conditions

Phantom Section, TSL	Position, Test Distance [mm]	Band	Group, UID	Frequency [MHz], Channel Number	Conversion Factor	TSL Conductivity [S/m]	TSL Permittivity
Flat, MSL	,		, 0--	750.0, 0	9.65	0.909	55.6

Hardware Setup

Phantom	TSL, Measured Date	Probe, Calibration Date	DAE, Calibration Date
ELI V8.0 (20deg probe tilt)	MABL-600-6000 , 2022-Aug-16	EX3DV4 - SN3978, 2022-05-17	DAE4ip Sn1703, 2022-04-28

Scan Setup

	Area Scan	Zoom Scan
Grid Extents [mm]	40.0 x 90.0	30.0 x 30.0 x 30.0
Grid Steps [mm]	10.0 x 15.0	6.0 x 6.0 x 1.5
Sensor Surface [mm]	3.0	1.4
Graded Grid	Yes	Yes
Grading Ratio	1.5	1.5
MAIA	Confirmed by MAIA	Confirmed by MAIA
Surface Detection	VMS + 6p	VMS + 6p
Scan Method	Measured	Measured

Measurement Results

	Area Scan	Zoom Scan
Date	2022-08-16, 09:12	2022-08-16, 09:17
psSAR1g [W/Kg]	0.443	0.432
psSAR10g [W/Kg]	0.298	0.290
Power Drift [dB]	-0.14	-0.14
Power Scaling	Disabled	Disabled
Scaling Factor [dB]		
TSL Correction	Positive Only	Positive Only
M2/M1 [%]		85.0
Dist 3dB Peak [mm]		19.5

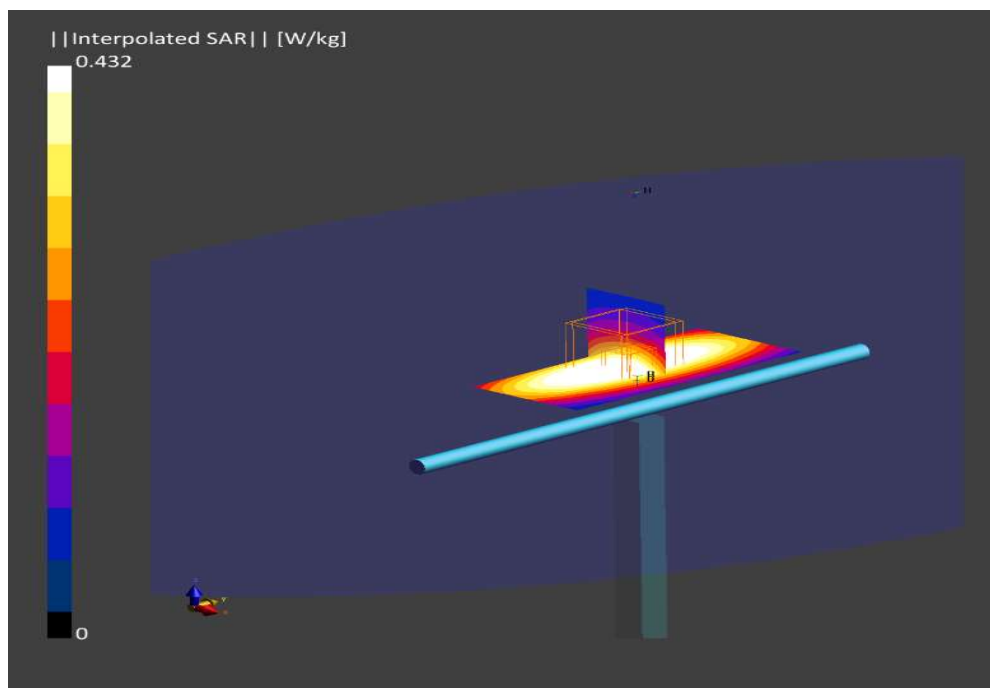

25. System Check Body Liquid 835MHz – 2022-08-17 – System2

Device under Test Properties

Name, Manufacturer	Dimensions [mm]	Serial Number	DUT Type
Dipole 835MHz, SPEAG	50.0 x 10.0 x 8.0	4d192	Validation Dipole

Exposure Conditions

Phantom Section, TSL	Position, Test Distance [mm]	Band	Group, UID	Frequency [MHz], Channel Number	Conversion Factor	TSL Conductivity [S/m]	TSL Permittivity
Flat, MSL	,		0--	835.0, 0	9.25	0.942	55.4

Hardware Setup

Phantom	TSL, Measured Date	Probe, Calibration Date	DAE, Calibration Date
ELI V8.0 (20deg probe tilt) -	MBBL-600-6000, 2022-Aug-16	EX3DV4 - SN3978, 2022-05-17	DAE4ip Sn1703, 2022-04-28

Scan Setup

	Area Scan	Zoom Scan
Grid Extents [mm]	40.0 x 90.0	30.0 x 30.0 x 30.0
Grid Steps [mm]	10.0 x 15.0	6.0 x 6.0 x 1.5
Sensor Surface [mm]	3.0	1.4
Graded Grid	Yes	Yes
Grading Ratio	1.5	1.5
MAIA	Confirmed by MAIA	Confirmed by MAIA
Surface Detection	VMS + 6p	VMS + 6p
Scan Method	Measured	Measured

Measurement Results

	Area Scan	Zoom Scan
Date	2022-08-17, 15:05	2022-08-17, 15:10
psSAR1g [W/Kg]	0.497	0.504
psSAR10g [W/Kg]	0.326	0.330
Power Drift [dB]	0.01	0.01
Power Scaling	Disabled	Disabled
Scaling Factor [dB]		
TSL Correction	Positive Only	Positive Only
M2/M1 [%]		84.7
Dist 3dB Peak [mm]		15.6

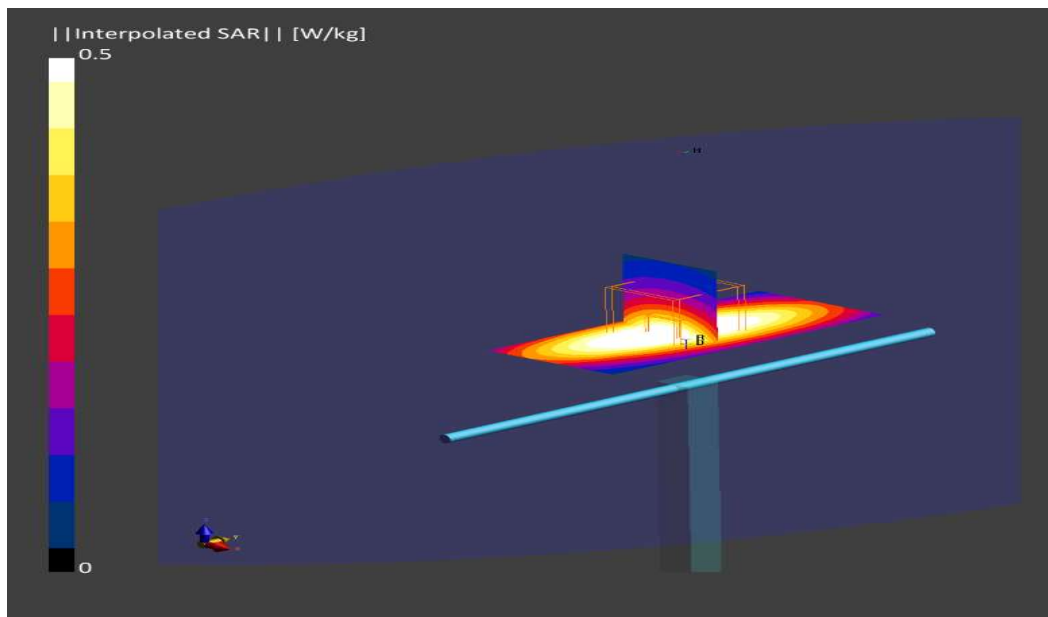

26. System Check Body Liquid 835MHz – 2022-08-26 – System2

Device under Test Properties

Name, Manufacturer	Dimensions [mm]	Serial Number	DUT Type
Dipole 835MHz, SPEAG	50.0 x 10.0 x 8.0	4d192	Validation Dipole

Exposure Conditions

Phantom Section, TSL	Position, Test Distance [mm]	Band	Group, UID	Frequency [MHz], Channel Number	Conversion Factor	TSL Conductivity [S/m]	TSL Permittivity
Flat, MSL	,		0--	835.0, 0	9.25	0.962	57.3

Hardware Setup

Phantom	TSL, Measured Date	Probe, Calibration Date	DAE, Calibration Date
ELI V8.0 (20deg probe tilt)	MBSL-600-6000 , 2022-Aug-23	EX3DV4 - SN3978, 2022-05-17	DAE4ip Sn1703, 2022-04-28

Scan Setup

	Area Scan	Zoom Scan
Grid Extents [mm]	40.0 x 90.0	30.0 x 30.0 x 30.0
Grid Steps [mm]	10.0 x 15.0	6.0 x 6.0 x 1.5
Sensor Surface [mm]	3.0	1.4
Graded Grid	Yes	Yes
Grading Ratio	1.5	1.5
MAIA	Confirmed by MAIA	Confirmed by MAIA
Surface Detection	VMS + 6p	VMS + 6p
Scan Method	Measured	Measured

Measurement Results

	Area Scan	Zoom Scan
Date	2022-08-26, 14:05	2022-08-26, 14:10
psSAR1g [W/Kg]	0.474	0.481
psSAR10g [W/Kg]	0.313	0.318
Power Drift [dB]	0.00	0.00
Power Scaling	Disabled	Disabled
Scaling Factor [dB]		
TSL Correction	Positive Only	Positive Only
M2/M1 [%]		86.9
Dist 3dB Peak [mm]		16.3

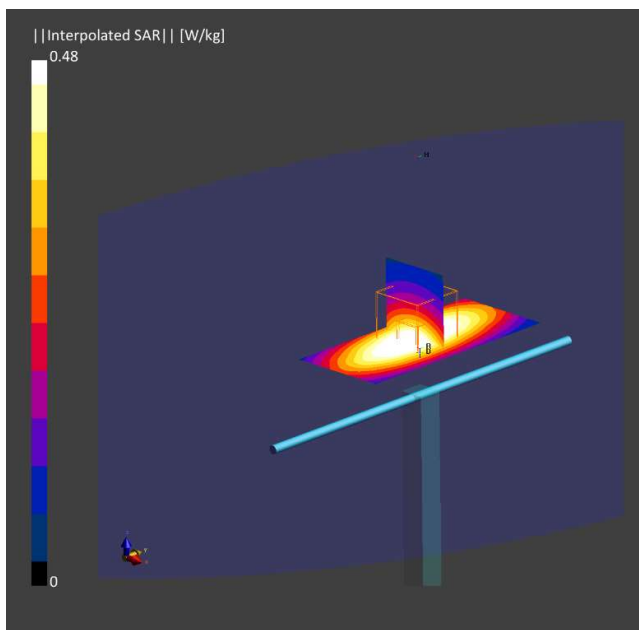

27. System Check Body Liquid 835MHz – 2022-08-29 – System3

Device under Test Properties

Name, Manufacturer	Dimensions [mm]	Serial Number	DUT Type
Dipole 835MHz, SPEAG	50.0 x 10.0 x 8.0	4d192	Validation Dipole

Exposure Conditions

Phantom Section, TSL	Position, Test Distance [mm]	Band	Group, UID	Frequency [MHz], Channel Number	Conversion Factor	TSL Conductivity [S/m]	TSL Permittivity
Flat, MSL	,	,	0--	835.0, 0	9.34	0.996	53.8

Hardware Setup

Phantom	TSL, Measured Date	Probe, Calibration Date	DAE, Calibration Date
ELI V8.0 (20deg probe tilt)	MBBL-600-6000, 2022-Aug-29	EX3DV4 - SN7455, 2022-03-21	DAE4 Sn1517, 2022-03-17

Scan Setup

	Area Scan	Zoom Scan
Grid Extents [mm]	40.0 x 90.0	30.0 x 30.0 x 30.0
Grid Steps [mm]	10.0 x 15.0	6.0 x 6.0 x 1.5
Sensor Surface [mm]	3.0	1.4
Graded Grid	Yes	Yes
Grading Ratio	1.5	1.5
MAIA	Confirmed by MAIA	Confirmed by MAIA
Surface Detection	VMS + 6p	VMS + 6p
Scan Method	Measured	Measured

Measurement Results

	Area Scan	Zoom Scan
Date	2022-08-29, 08:32	2022-08-29, 08:37
psSAR1g [W/kg]	0.539	0.532
psSAR10g [W/kg]	0.353	0.348
Power Drift [dB]	-0.02	-0.00
Power Scaling	Disabled	Disabled
Scaling Factor		
TSL Correction	Positive Only	Positive Only
M2/M1 [%]		84.6
Dist 3dB Peak [mm]		15.6

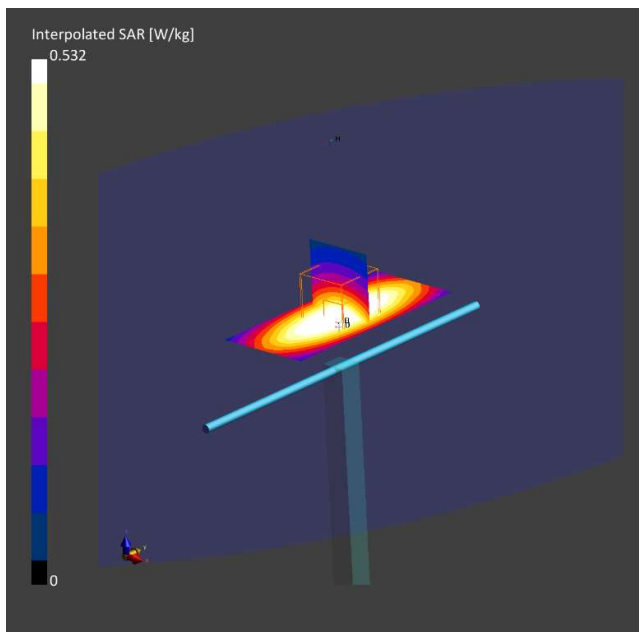

28. System Check Body Liquid 1750MHz – 2022-08-17 – System2

Device under Test Properties

Name, Manufacturer	Dimensions [mm]	Serial Number	DUT Type
Dipole 1750MHz, SPEAG	50.0 x 10.0 x 8.0	1133	Validation Dipole

Exposure Conditions

Phantom Section, TSL	Position, Test Distance [mm]	Band	Group, UID	Frequency [MHz], Channel Number	Conversion Factor	TSL Conductivity [S/m]	TSL Permittivity
Flat, MSL	,		, 0--	1750.0, 0	8.42	1.44	54.0

Hardware Setup

Phantom	TSL, Measured Date	Probe, Calibration Date	DAE, Calibration Date
ELI V8.0 (20deg probe tilt) -	MABL-600-6000, 2022-Aug-16	EX3DV4 - SN3978, 2022-05-17	DAE4ip Sn1703, 2022-04-28

Scan Setup

	Area Scan	Zoom Scan
Grid Extents [mm]	40.0 x 90.0	30.0 x 30.0 x 30.0
Grid Steps [mm]	10.0 x 15.0	6.0 x 6.0 x 1.5
Sensor Surface [mm]	3.0	1.4
Graded Grid	Yes	Yes
Grading Ratio	1.5	1.5
MAIA	Confirmed by MAIA	Confirmed by MAIA
Surface Detection	VMS + 6p	VMS + 6p
Scan Method	Measured	Measured

Measurement Results

	Area Scan	Zoom Scan
Date	2022-08-17, 13:59	2022-08-17, 14:04
psSAR1g [W/Kg]	1.66	1.69
psSAR10g [W/Kg]	0.886	0.908
Power Drift [dB]	-0.00	-0.01
Power Scaling	Disabled	Disabled
Scaling Factor [dB]		
TSL Correction	Positive Only	Positive Only
M2/M1 [%]		82.2
Dist 3dB Peak [mm]		9.6

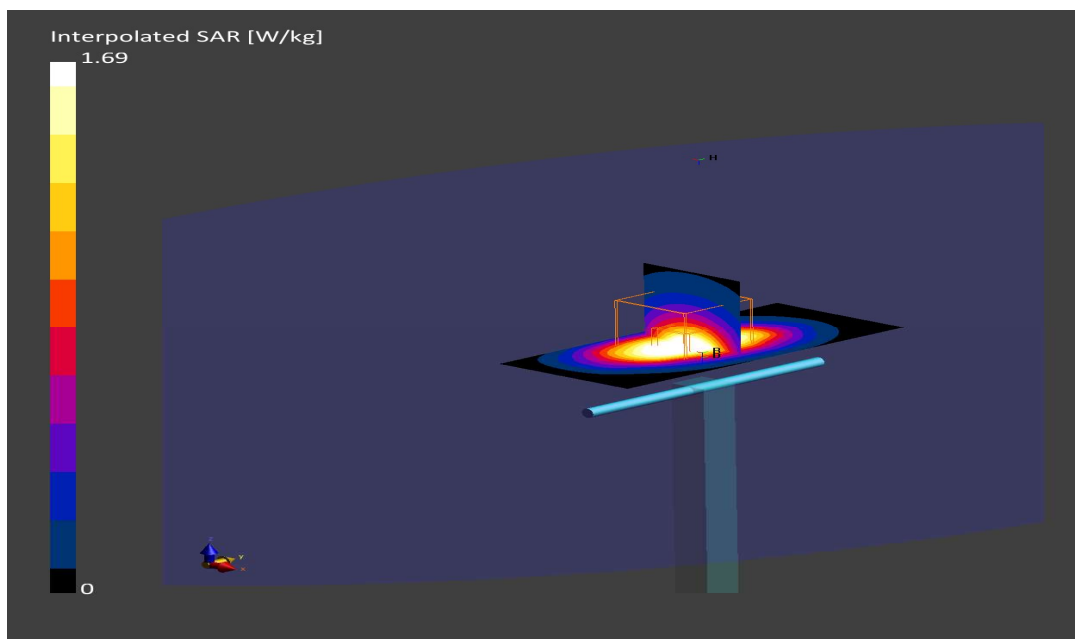

29. System Check Body Liquid 1750MHz – 2022-08-10 – System2

Device under Test Properties

Model, Manufacturer	Dimensions [mm]	IMEI	DUT Type
Device,	50.0 x 10.0 x 20.0		Phone

Exposure Conditions

Phantom Section, TSL	Position, Test Distance [mm]	Band	Group, UID	Frequency [MHz], Channel Number	Conversion Factor	TSL Conductivity [S/m]	TSL Permittivity
Flat, MSL	,		0--	1750.0, 0	8.42	1.40	52.3

Hardware Setup

Phantom	TSL, Measured Date	Probe, Calibration Date	DAE, Calibration Date
ELI V8.0 (20deg probe tilt)	MABL-600-6000, 2022-Aug-10	EX3DV4 - SN3978, 2022-05-17	DAE4ip Sn1703, 2022-04-28

Scan Setup

	Area Scan	Zoom Scan
Grid Extents [mm]	40.0 x 90.0	30.0 x 30.0 x 30.0
Grid Steps [mm]	10.0 x 15.0	6.0 x 6.0 x 1.5
Sensor Surface [mm]	3.0	1.4
Graded Grid	Yes	Yes
Grading Ratio	1.5	1.5
MAIA	Confirmed by MAIA	Confirmed by MAIA
Surface Detection	VMS + 6p	VMS + 6p
Scan Method	Measured	Measured

Measurement Results

	Area Scan	Zoom Scan
Date	2022-08-10, 11:09	2022-08-10, 11:14
psSAR1g [W/Kg]	1.65	1.70
psSAR10g [W/Kg]	0.877	0.908
Power Drift [dB]	0.03	0.03
Power Scaling	Disabled	Disabled
Scaling Factor [dB]		
TSL Correction	Positive Only	Positive Only
M2/M1 [%]		81.9
Dist 3dB Peak [mm]		9.6

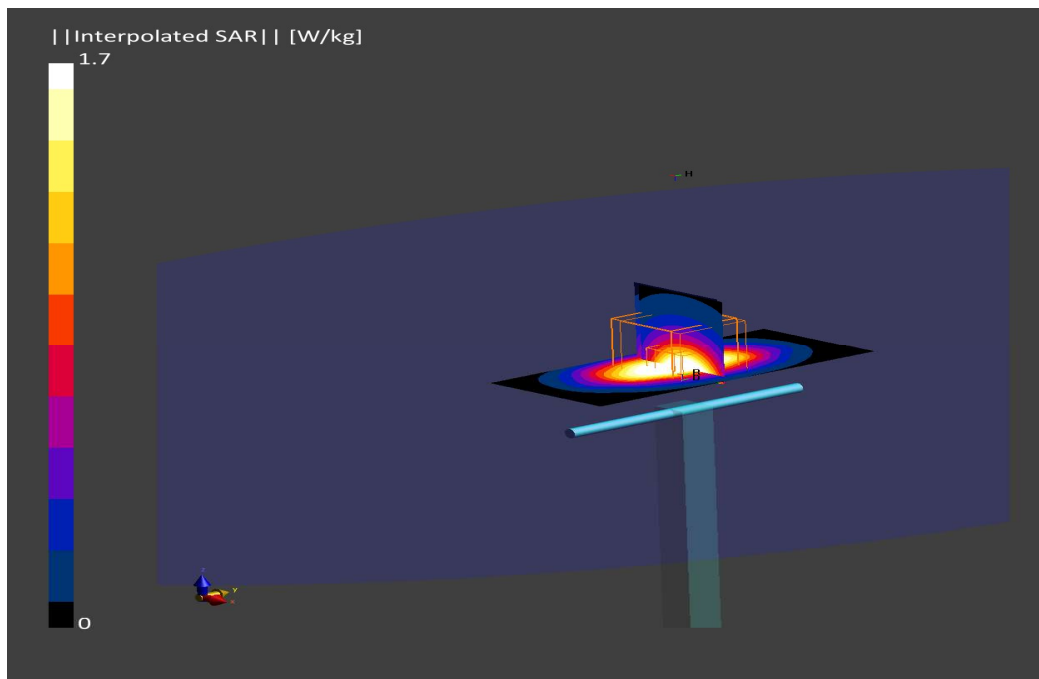

30. System Check Body Liquid 1750MHz – 2022-08-29 – System3

Device under Test Properties

Name, Manufacturer	Dimensions [mm]	Serial Number	DUT Type
Dipole 1750MHz, SPEAG	50.0 x 10.0 x 20.0	1133	Validation Dipole

Exposure Conditions

Phantom Section, TSL	Position, Test Distance [mm]	Band	Group, UID	Frequency [MHz], Channel Number	Conversion Factor	TSL Conductivity [S/m]	TSL Permittivity
Flat MSL			,	1750.0, 0	7.91	1.50	53.2

Hardware Setup

Phantom	TSL, Measured Date	Probe, Calibration Date	DAE, Calibration Date
ELI V8.0 (20deg probe tilt) - 2124	MABL-600-6000, 2022-Aug-29	EX3DV4 - SN7455, 2022-03-21	DAE4 Sn1517, 2022-03-17

Scan Setup

	Area Scan	Zoom Scan
Grid Extents [mm]	40.0 x 90.0	30.0 x 30.0 x 30.0
Grid Steps [mm]	10.0 x 15.0	6.0 x 6.0 x 1.5
Sensor Surface [mm]	3.0	1.4
Graded Grid	Yes	Yes
Grading Ratio	1.5	1.5
MAIA	Confirmed by MAIA	Confirmed by MAIA
Surface Detection	Yes	Yes
Scan Method	Measured	Measured

Measurement Results

	Area Scan	Zoom Scan
Date	2022-08-29, 09:19	2022-08-29, 09:24
psSAR1g [W/Kg]	1.87	1.84
psSAR10g [W/Kg]	0.980	0.974
Power Drift [dB]	0.01	-0.00
Power Scaling	Disabled	Disabled
Scaling Factor [dB]		
TSL Correction	Positive Only	Positive Only

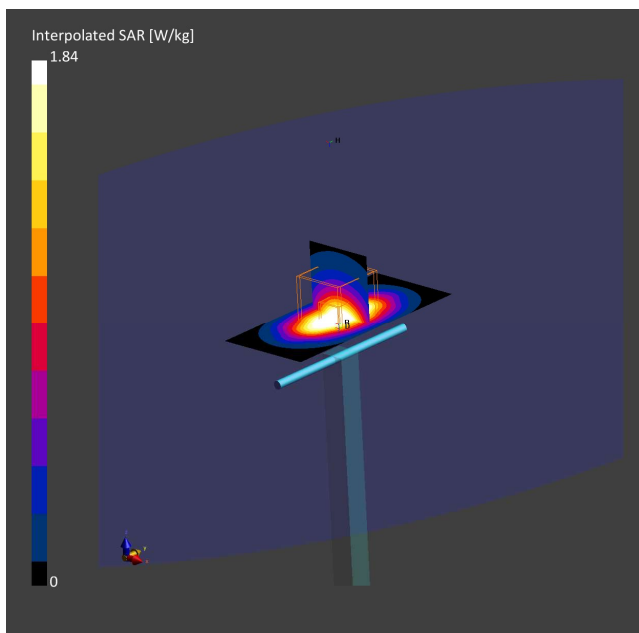

31. System Check Body Liquid 1900MHz – 2022-08-17 - System2

Device under Test Properties

Name, Manufacturer	Dimensions [mm]	S/N	DUT Type
Dipole 1900MHz, SPEAG	50.0 x 10.0 x 8.0	5d197	Validation Dipole

Exposure Conditions

Phantom Section, TSL	Position, Test Distance [mm]	Band	Group, UID	Frequency [MHz], Channel Number	Conversion Factor	TSL Conductivity [S/m]	TSL Permittivity
Flat, MSL	,	,	0--	1900.0, 0	8.06	1.54	53.7

Hardware Setup

Phantom	TSL, Measured Date	Probe, Calibration Date	DAE, Calibration Date
ELI V8.0 (20deg probe tilt)	MABL-600-6000, 2022-Aug-16	EX3DV4 - SN3978, 2022-05-17	DAE4ip Sn1703, 2022-04-28

Scan Setup

	Area Scan	Zoom Scan
Grid Extents [mm]	40.0 x 90.0	30.0 x 30.0 x 30.0
Grid Steps [mm]	10.0 x 15.0	6.0 x 6.0 x 1.5
Sensor Surface [mm]	3.0	1.4
Graded Grid	Yes	Yes
Grading Ratio	1.5	1.5
MAIA	N/A	N/A
Surface Detection	VMS + 6p	VMS + 6p
Scan Method	Measured	Measured

Measurement Results

	Area Scan	Zoom Scan
Date	2022-08-17, 15:33	2022-08-17, 15:38
psSAR1g [W/Kg]	1.91	1.99
psSAR10g [W/Kg]	1.02	1.04
Power Drift [dB]	-0.01	0.00
Power Scaling	Disabled	Disabled
Scaling Factor [dB]		
TSL Correction	No correction	No correction
M2/M1 [%]		81.6
Dist 3dB Peak [mm]		9.6

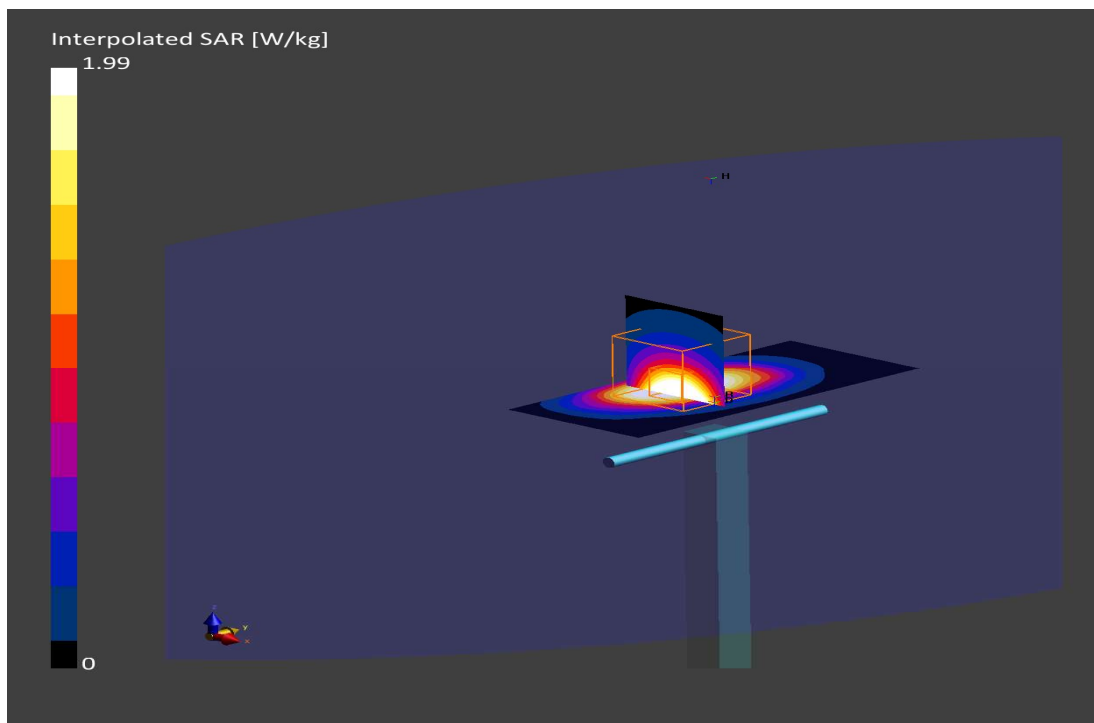

32. System Check Body Liquid 1900MHz – 2022-08-10 - System2

Device under Test Properties

Name, Manufacturer	Dimensions [mm]	Serial Number	DUT Type
Dipole 1900MHz, SPEAG	50.0 x 10.0 x 20.0	5d197	Validation Dipole

Exposure Conditions

Phantom Section, TSL	Position, Test Distance [mm]	Band	Group, UID	Frequency [MHz], Channel Number	Conversion Factor	TSL Conductivity [S/m]	TSL Permittivity
Flat, MSL	,		0--	1900.0, 0	8.06	1.50	52.1

Hardware Setup

Phantom	TSL, Measured Date	Probe, Calibration Date	DAE, Calibration Date
ELI V8.0 (20deg probe tilt)	MABL-600-6000 , 2022-Aug-10	EX3DV4 - SN3978, 2022-05-17	DAE4ip Sn1703, 2022-04-28

Scan Setup

	Area Scan	Zoom Scan
Grid Extents [mm]	40.0 x 90.0	30.0 x 30.0 x 30.0
Grid Steps [mm]	10.0 x 15.0	6.0 x 6.0 x 1.5
Sensor Surface [mm]	3.0	1.4
Graded Grid	Yes	Yes
Grading Ratio	1.5	1.5
MAIA	Confirmed by MAIA	Confirmed by MAIA
Surface Detection	VMS + 6p	VMS + 6p
Scan Method	Measured	Measured

Measurement Results

	Area Scan	Zoom Scan
Date	2022-08-10, 12:13	2022-08-10, 12:18
psSAR1g [W/Kg]	1.89	1.92
psSAR10g [W/Kg]	0.969	1.01
Power Drift [dB]	0.01	-0.02
Power Scaling	Disabled	Disabled
Scaling Factor [dB]		
TSL Correction	Positive Only	Positive Only
M2/M1 [%]		81.7
Dist 3dB Peak [mm]		9.6

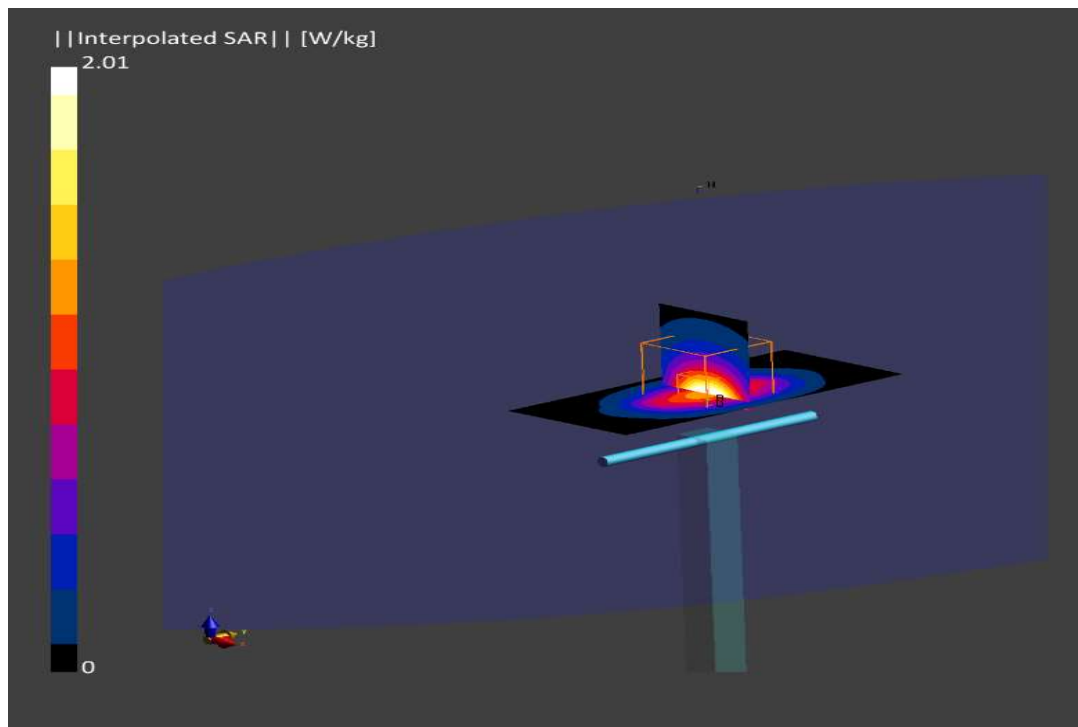

33. System Check Body Liquid 1900MHz – 2022-08-29 – System3

Device under Test Properties

Name, Manufacturer	Dimensions [mm]	Serial Number	DUT Type
Dipole 1900MHz, SPEAG	50.0 x 10.0 x 20.0	5d197	Validation Dipole

Exposure Conditions

Phantom Section, TSL	Position, Test Distance [mm]	Band	Group, UID	Frequency [MHz], Channel Number	Conversion Factor	TSL Conductivity [S/m]	TSL Permittivity
Flat MSL			,	1900.0, 0	7.59	1.60	53.0

Hardware Setup

Phantom	TSL, Measured Date	Probe, Calibration Date	DAE, Calibration Date
ELI V8.0 (20deg probe tilt) - 2124	MABL-600-6000, 2022-Aug-29	EX3DV4 - SN7455, 2022-03-21	DAE4 Sn1517, 2022-03-17

Scan Setup

	Area Scan	Zoom Scan
Grid Extents [mm]	40.0 x 90.0	30.0 x 30.0 x 30.0
Grid Steps [mm]	10.0 x 15.0	6.0 x 6.0 x 1.5
Sensor Surface [mm]	3.0	1.4
Graded Grid	Yes	Yes
Grading Ratio	1.5	1.5
MAIA	Confirmed by MAIA	Confirmed by MAIA
Surface Detection	Yes	Yes
Scan Method	Measured	Measured

Measurement Results

	Area Scan	Zoom Scan
Date	2022-08-29, 08:42	2022-08-29, 08:47
psSAR1g [W/Kg]	2.13	2.13
psSAR10g [W/Kg]	1.09	1.10
Power Drift [dB]	-0.01	-0.18
Power Scaling	Disabled	Disabled
Scaling Factor [dB]		
TSL Correction	Positive Only	Positive Only

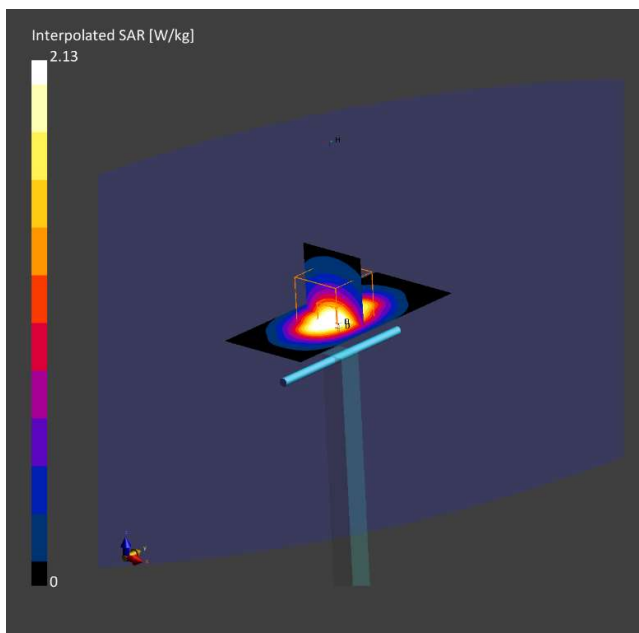

34. System Check Body Liquid 1900MHz – 2022-08-30 – System3

Device under Test Properties

Name, Manufacturer	Dimensions [mm]	Serial Number	DUT Type
Dipole 1900MHz, SPEAG	50.0 x 10.0 x 20.0	5d197	Validation Dipole

Exposure Conditions

Phantom Section, TSL	Position, Test Distance [mm]	Band	Group, UID	Frequency [MHz], Channel Number	Conversion Factor	TSL Conductivity [S/m]	TSL Permittivity
Flat MSL			,	1900.0, 0	7.59	1.60	53.0

Hardware Setup

Phantom	TSL, Measured Date	Probe, Calibration Date	DAE, Calibration Date
ELI V8.0 (20deg probe tilt) - 2124	MABL-600-6000, 2022-Aug-29	EX3DV4 - SN7455, 2022-03-21	DAE4 Sn1517, 2022-03-17

Scan Setup

	Area Scan	Zoom Scan
Grid Extents [mm]	40.0 x 90.0	30.0 x 30.0 x 30.0
Grid Steps [mm]	10.0 x 15.0	6.0 x 6.0 x 1.5
Sensor Surface [mm]	3.0	1.4
Graded Grid	Yes	Yes
Grading Ratio	1.5	1.5
MAIA	Confirmed by MAIA	Confirmed by MAIA
Surface Detection	Yes	Yes
Scan Method	Measured	Measured

Measurement Results

	Area Scan	Zoom Scan
Date	2022-08-30, 16:02	2022-08-30, 16:07
psSAR1g [W/Kg]	2.16	2.11
psSAR10g [W/Kg]	1.10	1.09
Power Drift [dB]	0.01	-0.01
Power Scaling	Disabled	Disabled
Scaling Factor [dB]		
TSL Correction	Positive Only	Positive Only

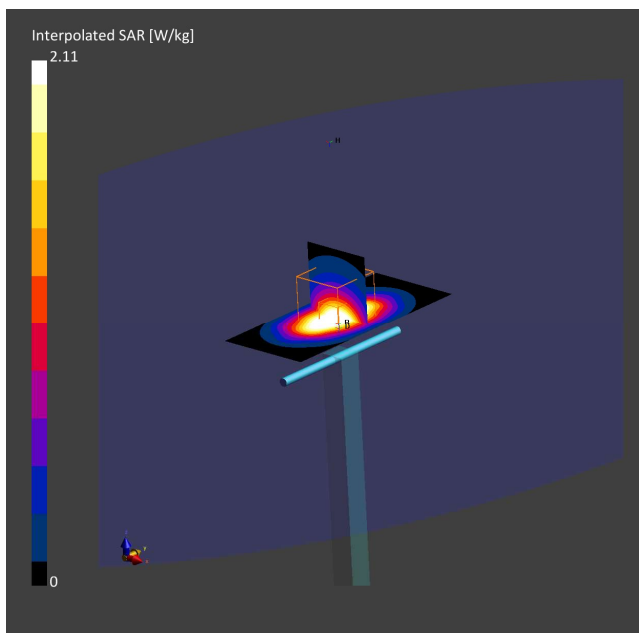

35. System Check Body Liquid 2300MHz – 2022-08-16 –System2

Device under Test Properties

Name, Manufacturer	Dimensions [mm]	Serial Number	DUT Type
D2300MHz, SPEAG	50.0 x 10.0 x 8.0	1046	Validation Dipole

Exposure Conditions

Phantom Section, TSL	Position, Test Distance [mm]	Band	Group, UID	Frequency [MHz], Channel Number	Conversion Factor	TSL Conductivity [S/m]	TSL Permittivity
Flat, MSL	,	,	0--	2300.0, 0	7.43	1.87	53.2

Hardware Setup

Phantom	TSL, Measured Date	Probe, Calibration Date	DAE, Calibration Date
ELI V8.0 (20deg probe tilt)	MABL-600-6000, 2022-Aug-16	EX3DV4 - SN3978, 2022-05-17	DAE4ip Sn1703, 2022-04-28

Scan Setup

	Area Scan	Zoom Scan
Grid Extents [mm]	40.0 x 80.0	30.0 x 30.0 x 30.0
Grid Steps [mm]	10.0 x 10.0	5.0 x 5.0 x 1.5
Sensor Surface [mm]	3.0	1.4
Graded Grid	Yes	Yes
Grading Ratio	1.5	1.5
MAIA	Confirmed by MAIA	Confirmed by MAIA
Surface Detection	VMS + 6p	VMS + 6p
Scan Method	Measured	Measured

Measurement Results

	Area Scan	Zoom Scan
Date	2022-08-16, 09:41	2022-08-16, 09:47
psSAR1g [W/Kg]	2.26	2.36
psSAR10g [W/Kg]	1.12	1.14
Power Drift [dB]	0.01	-0.00
Power Scaling	Disabled	Disabled
Scaling Factor [dB]		
TSL Correction	Positive Only	Positive Only
M2/M1 [%]		80.6
Dist 3dB Peak [mm]		8.9

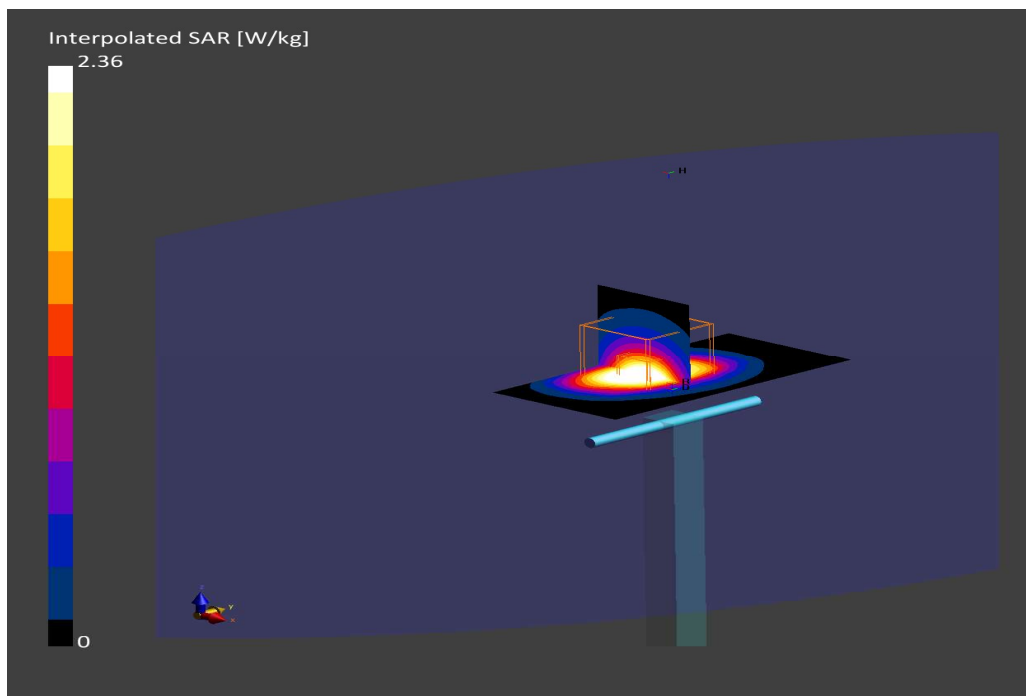

36. System Check Body Liquid 2300MHz – 2022-08-29 - System3

Device under Test Properties

Name, Manufacturer	Dimensions [mm]	Serial Number	DUT Type
D2300MHZ, SPEAG	50.0 x 10.0 x 8.0	1046	Validation Dipole

Exposure Conditions

Phantom Section, TSL	Position, Test Distance [mm]	Band	Group, UID	Frequency [MHz], Channel Number	Conversion Factor	TSL Conductivity [S/m]	TSL Permittivity
Flat, MSL	,	,	0--	2300.0, 0	7.51	1.92	52.4

Hardware Setup

Phantom	TSL, Measured Date	Probe, Calibration Date	DAE, Calibration Date
ELI V8.0 (20deg probe tilt)	MABL-600-6000, 2022-Aug-29	EX3DV4 - SN7455, 2022-03-21	DAE4 Sn1517, 2022-03-17

Scan Setup

	Area Scan	Zoom Scan
Grid Extents [mm]	40.0 x 80.0	30.0 x 30.0 x 30.0
Grid Steps [mm]	10.0 x 10.0	5.0 x 5.0 x 1.5
Sensor Surface [mm]	3.0	1.4
Graded Grid	Yes	Yes
Grading Ratio	1.5	1.5
MAIA	Confirmed by MAIA	Confirmed by MAIA
Surface Detection	VMS + 6p	VMS + 6p
Scan Method	Measured	Measured

Measurement Results

	Area Scan	Zoom Scan
Date	2022-08-29, 08:20	2022-08-29, 08:27
psSAR1g [W/kg]	2.33	2.32
psSAR10g [W/kg]	1.09	1.10
Power Drift [dB]	-0.11	-0.10
Power Scaling	Disabled	Disabled
Scaling Factor		
TSL Correction	Positive Only	Positive Only
M2/M1 [%]		81.7
Dist 3dB Peak [mm]		8.9

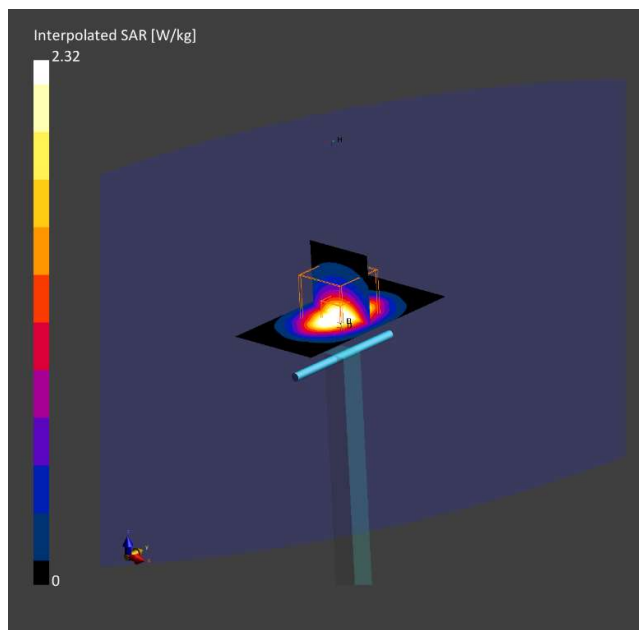

37. System Check Body Liquid 2600MHz – 2022-08-29 – System3

Device under Test Properties

Name, Manufacturer	Dimensions [mm]	Serial Number	DUT Type
D2600MHz, SPEAG	50.0 x 10.0 x 8.0	1100	Validation Dipole

Exposure Conditions

Phantom Section, TSL	Position, Test Distance [mm]	Band	Group, UID	Frequency [MHz], Channel Number	Conversion Factor	TSL Conductivity [S/m]	TSL Permittivity
Flat, MSL	,	,	0--	2600.0, 0	7.3	2.23	51.9

Hardware Setup

Phantom	TSL, Measured Date	Probe, Calibration Date	DAE, Calibration Date
ELI V8.0 (20deg probe tilt)	MABL-600-6000, 2022-Aug-29	EX3DV4 - SN7455, 2022-03-21	DAE4 Sn1517, 2022-03-17

Scan Setup

	Area Scan	Zoom Scan
Grid Extents [mm]	40.0 x 80.0	30.0 x 30.0 x 30.0
Grid Steps [mm]	10.0 x 10.0	5.0 x 5.0 x 1.5
Sensor Surface [mm]	3.0	1.4
Graded Grid	Yes	Yes
Grading Ratio	1.5	1.5
MAIA	Confirmed by MAIA	Confirmed by MAIA
Surface Detection	VMS + 6p	VMS + 6p
Scan Method	Measured	Measured

Measurement Results

	Area Scan	Zoom Scan
Date	2022-08-29, 09:08	2022-08-29, 09:14
psSAR1g [W/kg]	2.68	2.62
psSAR10g [W/kg]	1.17	1.16
Power Drift [dB]	-0.01	-0.02
Power Scaling	Disabled	Disabled
Scaling Factor		
TSL Correction	Positive Only	Positive Only
M2/M1 [%]		81.0
Dist 3dB Peak [mm]		8.2

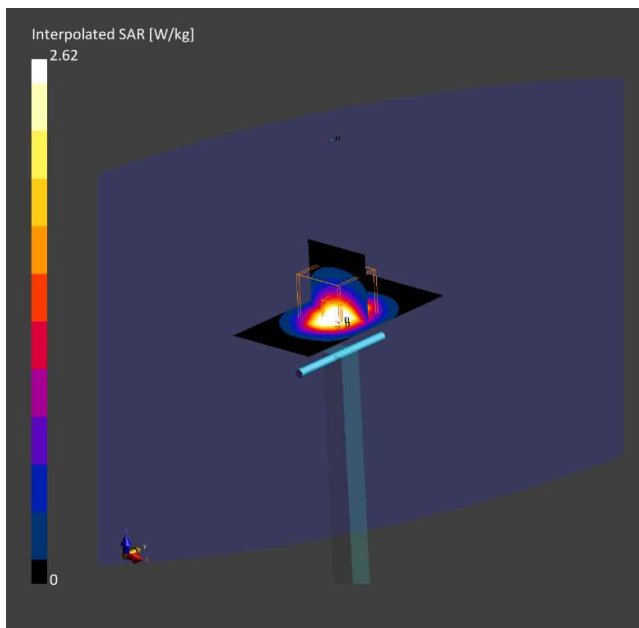

38. System Check Body Liquid 2600MHz – 2022-08-30 – System3

Device under Test Properties

Name, Manufacturer	Dimensions [mm]	Serial Number	DUT Type
D2600MHz, SPEAG	50.0 x 10.0 x 8.0	1100	Validation Dipole

Exposure Conditions

Phantom Section, TSL	Position, Test Distance [mm]	Band	Group, UID	Frequency [MHz], Channel Number	Conversion Factor	TSL Conductivity [S/m]	TSL Permittivity
Flat, MSL	,		0--	2600.0, 0	7.3	2.23	51.9

Hardware Setup

Phantom	TSL, Measured Date	Probe, Calibration Date	DAE, Calibration Date
ELI V8.0 (20deg probe tilt)	MABL-600-6000, 2022-Aug-29	EX3DV4 - SN7455, 2022-03-21	DAE4 Sn1517, 2022-03-17

Scan Setup

	Area Scan	Zoom Scan
Grid Extents [mm]	40.0 x 80.0	30.0 x 30.0 x 30.0
Grid Steps [mm]	10.0 x 10.0	5.0 x 5.0 x 1.5
Sensor Surface [mm]	3.0	1.4
Graded Grid	Yes	Yes
Grading Ratio	1.5	1.5
MAIA	Confirmed by MAIA	Confirmed by MAIA
Surface Detection	VMS + 6p	VMS + 6p
Scan Method	Measured	Measured

Measurement Results

	Area Scan	Zoom Scan
Date	2022-08-30, 15:50	2022-08-30, 15:57
psSAR1g [W/kg]	2.62	2.57
psSAR10g [W/kg]	1.15	1.13
Power Drift [dB]	0.01	-0.05
Power Scaling	Disabled	Disabled
Scaling Factor		
TSL Correction	Positive Only	Positive Only
M2/M1 [%]		81.0
Dist 3dB Peak [mm]		8.2

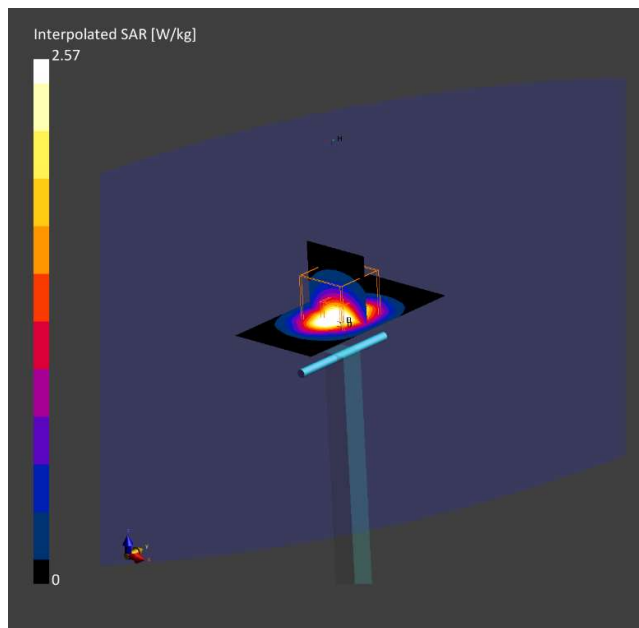

39. System Check Body Liquid 2600MHz – 2022-08-11 – System2

Device under Test Properties

Name, Manufacturer	Dimensions [mm]	Serial Number	DUT Type
Dipole 2600MHz, SPEAG	50.0 x 10.0 x 20.0	1100	Validation Dipole

Exposure Conditions

Phantom Section, TSL	Position, Test Distance [mm]	Band	Group, UID	Frequency [MHz], Channel Number	Conversion Factor	TSL Conductivity [S/m]	TSL Permittivity
Flat, MSL	,		0--	2600.0, 0	7.23	2.10	51.1

Hardware Setup

Phantom	TSL, Measured Date	Probe, Calibration Date	DAE, Calibration Date
ELI V8.0 (20deg probe tilt)	MABL-600-6000, 2022-Aug-10	EX3DV4 - SN3978, 2022-05-17	DAE Sn1703, 2022-04-28

Scan Setup

	Area Scan	Zoom Scan
Grid Extents [mm]	40.0 x 80.0	30.0 x 30.0 x 30.0
Grid Steps [mm]	10.0 x 10.0	5.0 x 5.0 x 1.5
Sensor Surface [mm]	3.0	1.4
Graded Grid	Yes	Yes
Grading Ratio	1.5	1.5
MAIA	Confirmed by MAIA	Confirmed by MAIA
Surface Detection	VMS + 6p	VMS + 6p
Scan Method	Measured	Measured

Measurement Results

	Area Scan	Zoom Scan
Date	2022-08-11, 09:13	2022-08-11, 09:19
psSAR1g [W/Kg]	2.41	2.56
psSAR10g [W/Kg]	1.12	1.15
Power Drift [dB]	-0.01	-0.01
Power Scaling	Disabled	Disabled
Scaling Factor [dB]		
TSL Correction	Positive Only	Positive Only
M2/M1 [%]		77.4
Dist 3dB Peak [mm]		9.0

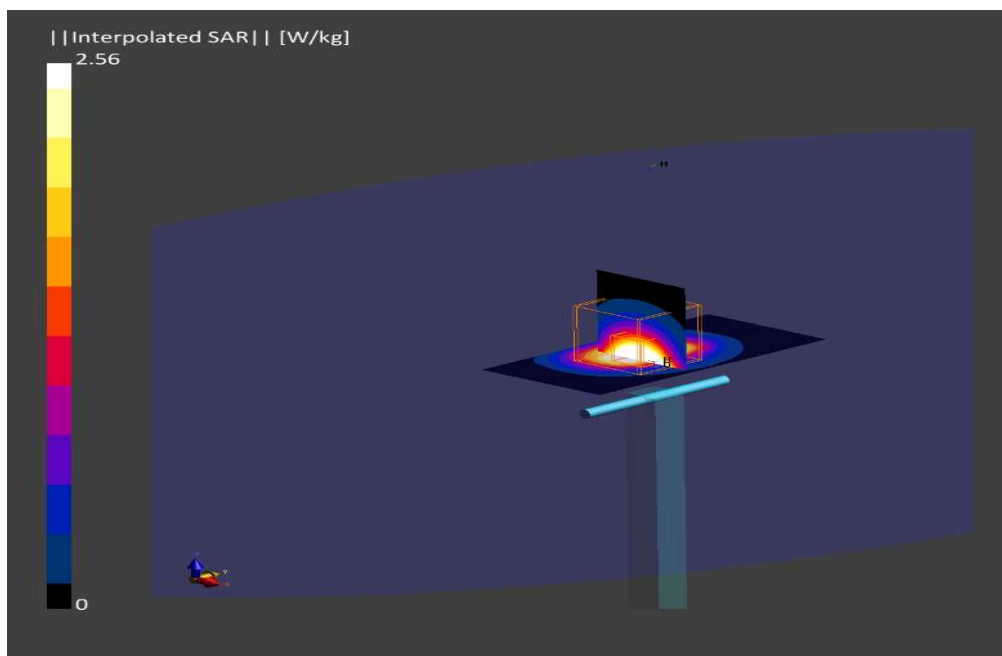

40. System Check Body Liquid 2600MHz – 2022-08-31 – System 3

Device under Test Properties

Name, Manufacturer	Dimensions [mm]	Serial Number	DUT Type
Dipole 2600MHz, SPEAG	50.0 x 10.0 x 20.0	1100	Validation Dipole

Exposure Conditions

Phantom Section, TSL	Position, Test Distance [mm]	Band	Group, UID	Frequency [MHz], Channel Number	Conversion Factor	TSL Conductivity [S/m]	TSL Permittivity
Flat MSL			,	2600.0, 0	7.3	2.23	51.9

Hardware Setup

Phantom	TSL, Measured Date	Probe, Calibration Date	DAE, Calibration Date
ELI V8.0 (20deg probe tilt) - 2124	MABL-600-6000, 2022-Aug-29	EX3DV4 - SN7455, 2022-03-21	DAE4 Sn1517, 2022-03-17

Scan Setup

	Area Scan	Zoom Scan
Grid Extents [mm]	40.0 x 80.0	30.0 x 30.0 x 30.0
Grid Steps [mm]	10.0 x 10.0	5.0 x 5.0 x 1.5
Sensor Surface [mm]	3.0	1.4
Graded Grid	Yes	Yes
Grading Ratio	1.5	1.5
MAIA	Confirmed by MAIA	Confirmed by MAIA
Surface Detection	Yes	Yes
Scan Method	Measured	Measured

Measurement Results

	Area Scan	Zoom Scan
Date	2022-08-31, 16:17	2022-08-31, 16:24
psSAR1g [W/Kg]	2.61	2.54
psSAR10g [W/Kg]	1.14	1.12
Power Drift [dB]	-0.00	-0.03
Power Scaling	Disabled	Disabled
Scaling Factor [dB]		
TSL Correction	Positive Only	Positive Only

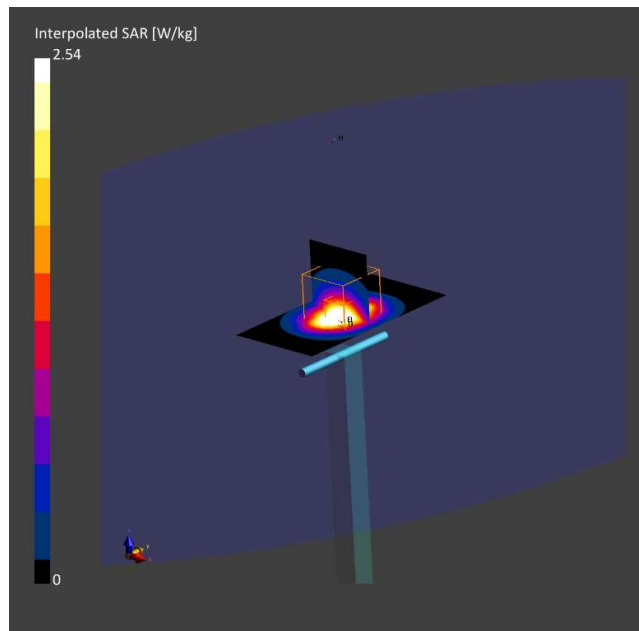

41. System Check Body Liquid 3700MHz – 2022-08-30 – System3

Device under Test Properties

Name, Manufacturer	Dimensions [mm]	Serial Number	DUT Type
Dipole 3700MHz, SPEAG	50.0 x 10.0 x 17.0	1093	Validation Dipole

Exposure Conditions

Phantom Section, TSL	Position, Test Distance [mm]	Band	Group, UID	Frequency [MHz], Channel Number	Conversion Factor	TSL Conductivity [S/m]	TSL Permittivity
Flat, MSL	,		, 0--	3700.0, 0	6.13	3.42	49.0

Hardware Setup

Phantom	TSL, Measured Date	Probe, Calibration Date	DAE, Calibration Date
ELI V8.0 (20deg probe tilt) -	MBBL-600-6000, 2022-Aug-29	EX3DV4 - SN7455, 2022-03-21	DAE4 Sn1517, 2022-03-17

Scan Setup

	Area Scan	Zoom Scan
Grid Extents [mm]	40.0 x 80.0	28.0 x 28.0 x 28.0
Grid Steps [mm]	10.0 x 10.0	5.0 x 5.0 x 1.4
Sensor Surface [mm]	3.0	1.4
Graded Grid	Yes	Yes
Grading Ratio	1.5	1.5
MAIA	Confirmed by MAIA	Confirmed by MAIA
Surface Detection	VMS + 6p	VMS + 6p
Scan Method	Measured	Measured

Measurement Results

	Area Scan	Zoom Scan
Date	2022-08-30, 16:45	2022-08-30, 16:51
psSAR1g [W/kg]	3.10	3.03
psSAR10g [W/kg]	1.12	1.10
Power Drift [dB]	-0.00	-0.02
Power Scaling	Disabled	Disabled
Scaling Factor [dB]		
TSL Correction	Positive Only	Positive Only
M2/M1 [%]		76.6
Dist 3dB Peak [mm]		8.5

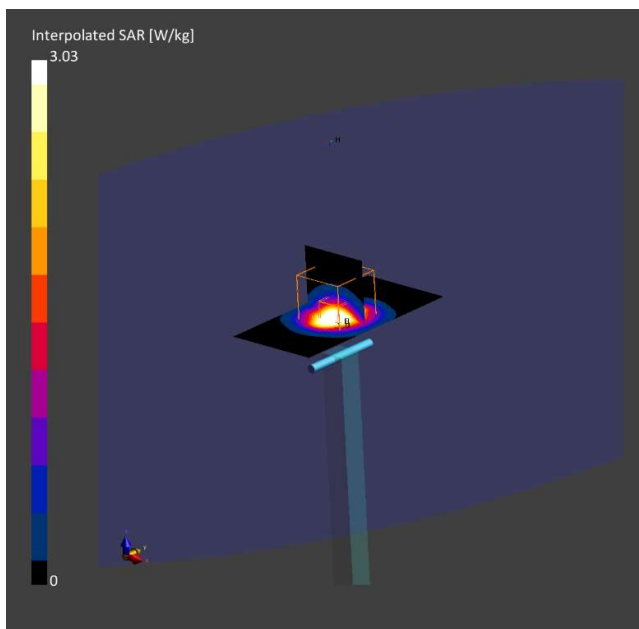

42. System Check Body Liquid 3700MHz – 2022-08-11 – System2

Name, Manufacturer	Dimensions [mm]	Serial Number	DUT Type
Dipole 3700MHz, SPEAG	50.0 x 10.0 x 20.0	1093	Validation Dipole

Exposure Conditions

Phantom Section, TSL	Position, Test Distance [mm]	Band	Group, UID	Frequency [MHz], Channel Number	Conversion Factor	TSL Conductivity [S/m]	TSL Permittivity
Flat, MSL	,	,	0--	3700.0, 0	6.03	3.25	49.0

Hardware Setup

Phantom	TSL, Measured Date	Probe, Calibration Date	DAE, Calibration Date
ELI V8.0 (20deg probe tilt) -	MABL-600-6000, 2022-Aug-10	EX3DV4 - SN3978, 2022-05-17	DAE4ip Sn1703, 2022-04-28

Scan Setup

	Area Scan	Zoom Scan
Grid Extents [mm]	40.0 x 80.0	28.0 x 28.0 x 28.0
Grid Steps [mm]	10.0 x 10.0	5.0 x 5.0 x 1.4
Sensor Surface [mm]	3.0	1.4
Graded Grid	Yes	Yes
Grading Ratio	1.5	1.5
MAIA	Confirmed by MAIA	Confirmed by MAIA
Surface Detection	VMS + 6p	VMS + 6p
Scan Method	Measured	Measured

Measurement Results

	Area Scan	Zoom Scan
Date	2022-08-11, 10:00	2022-08-11, 10:07
psSAR1g [W/Kg]	2.89	3.23
psSAR10g [W/Kg]	1.14	1.19
Power Drift [dB]	0.01	0.04
Power Scaling	Disabled	Disabled
Scaling Factor [dB]		
TSL Correction	Positive Only	Positive Only
M2/M1 [%]		75.7
Dist 3dB Peak [mm]		8.0

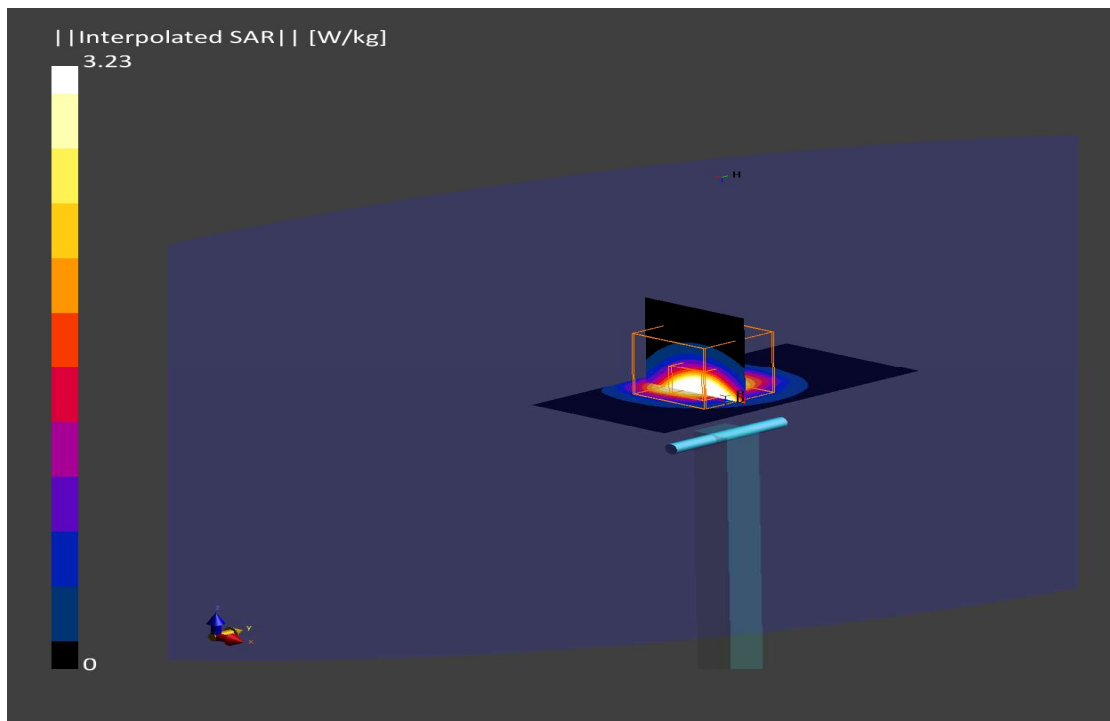

Annex C. TSL Dielectric Parameters

C.1 Body 700MHz-900MHz SAR System 2

Freq. (MHz)	Target		2022-08-16		2022-08-23	
	ϵ' (F/m)	σ (S/m)	Measured			
			ϵ'_1 (F/m)	σ_1 (S/m)	ϵ'_2 (F/m)	σ_2 (S/m)
700.0	55.73	0.96	55.73	0.89	57.66	0.91
750.0	55.53	0.96	55.59	0.91	57.53	0.93
800.0	55.34	0.97	55.47	0.93	57.42	0.95
850.0	55.15	0.99	55.36	0.95	57.32	0.97
900.0	55.0	1.05	55.27	0.97	57.23	0.99

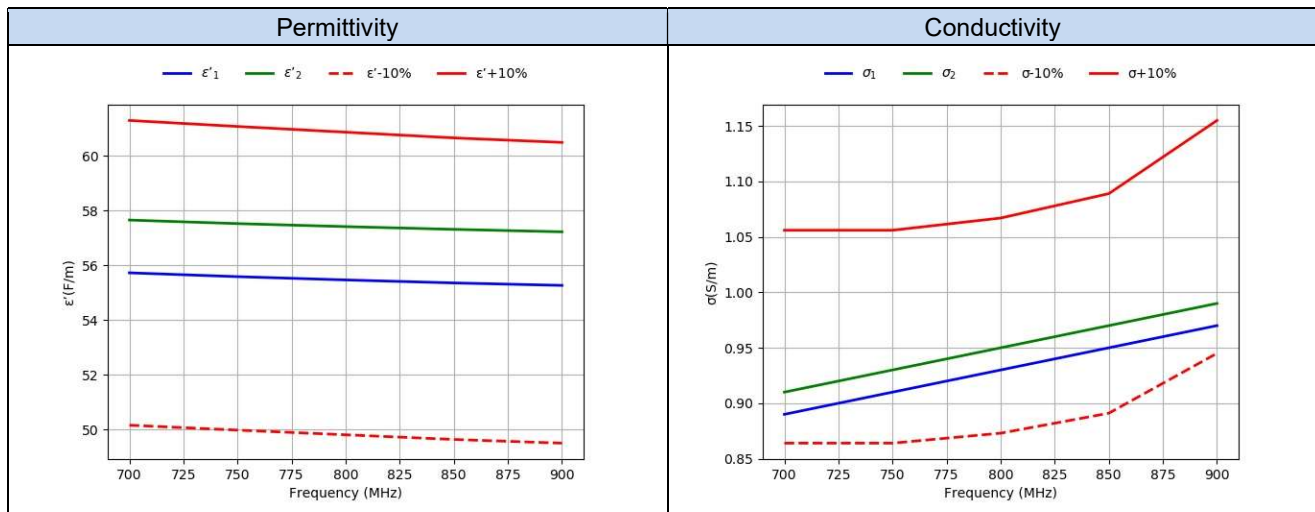

C.2 Body 1700MHz-3700MHz SAR System 2

Freq. (MHz)	Target		2022-08-10		2022-08-16	
			Measured			
	ϵ' (F/m)	σ (S/m)	ϵ'_1 (F/m)	σ_1 (S/m)	ϵ'_2 (F/m)	σ_2 (S/m)
1700.0	53.56	1.46	52.36	1.37	54.02	1.4
1750.0	53.43	1.49	52.3	1.4	53.95	1.44
1800.0	53.3	1.52	52.24	1.43	53.89	1.47
1850.0	53.3	1.52	52.19	1.47	53.82	1.51
1900.0	53.3	1.52	52.13	1.5	53.75	1.54
1950.0	53.3	1.52	52.07	1.54	53.68	1.58
2000.0	53.3	1.52	52.01	1.57	53.61	1.62
2050.0	53.23	1.57	51.97	1.61	53.55	1.66
2100.0	53.17	1.62	51.92	1.65	53.48	1.7
2150.0	53.1	1.66	51.86	1.69	53.42	1.74
2200.0	53.03	1.71	51.8	1.73	53.36	1.78
2250.0	52.97	1.76	51.73	1.77	53.29	1.82
2300.0	52.9	1.81	51.65	1.82	53.22	1.87
2350.0	52.83	1.85	51.57	1.86	53.14	1.91
2400.0	52.77	1.9	51.49	1.91	53.07	1.96
2450.0	52.7	1.95	51.41	1.96	53.0	2.01
2500.0	52.64	2.02	51.32	2.0	52.92	2.06
2550.0	52.57	2.09	51.23	2.05	52.83	2.11
2600.0	52.51	2.16	51.13	2.1	52.74	2.16
2650.0	52.45	2.23	51.02	2.15	52.65	2.21
2700.0	52.38	2.3	50.91	2.2	52.55	2.26
2750.0	52.32	2.38	50.79	2.25	52.45	2.31
2800.0	52.25	2.45	50.68	2.3	52.36	2.36
2850.0	52.19	2.52	50.57	2.35	52.26	2.41
2900.0	52.13	2.59	50.46	2.4	52.16	2.46
2950.0	52.06	2.66	50.36	2.45	52.06	2.52
3000.0	52.0	2.73	50.26	2.5	51.96	2.57
3050.0	51.93	2.79	50.16	2.55	51.86	2.62
3100.0	51.86	2.85	50.07	2.6	51.76	2.67
3150.0	51.8	2.91	49.97	2.65	51.66	2.73
3200.0	51.73	2.96	49.88	2.71	51.56	2.78
3250.0	51.66	3.02	49.78	2.76	51.46	2.84
3300.0	51.59	3.08	49.7	2.82	51.37	2.89
3350.0	51.52	3.14	49.61	2.87	51.28	2.95
3400.0	51.46	3.2	49.53	2.92	51.19	3.0
3450.0	51.39	3.26	49.44	2.98	51.1	3.06
3500.0	51.32	3.31	49.36	3.03	51.01	3.11
3550.0	51.25	3.37	49.27	3.08	50.93	3.17
3600.0	51.19	3.43	49.19	3.14	50.84	3.23
3650.0	51.12	3.49	49.1	3.2	50.76	3.29
3700.0	51.05	3.55	49.01	3.25	50.68	3.35

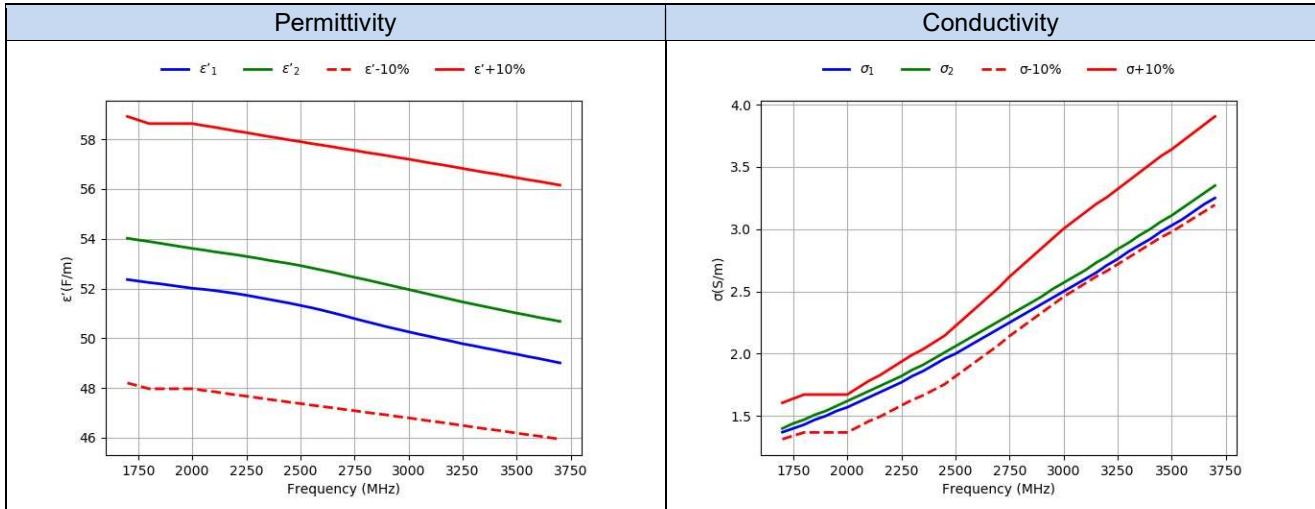

C.3 800MHz-3900MHz SAR System 3

			2022-08-29	
			Measured	
Target				
Freq.(MHz)	e' (F/m)	s (S/m)	e'1 (F/m)	s1 (S/m)
800.0	55.34	0.97	53.88	0.98
850.0	55.15	0.99	53.76	1.00
900.0	55.00	1.05	53.67	1.02
950.0	54.93	1.08	53.6	1.04
1000.0	54.84	1.10	53.55	1.07
1050.0	54.75	1.12	53.52	1.09
1100.0	54.65	1.14	53.49	1.11
1150.0	54.56	1.17	53.46	1.14
1200.0	54.47	1.19	53.44	1.16
1250.0	54.37	1.21	53.43	1.19
1300.0	54.28	1.23	53.42	1.22
1350.0	54.19	1.26	53.43	1.25
1400.0	54.09	1.28	53.44	1.28
1450.0	54.00	1.30	53.43	1.31
1500.0	53.94	1.33	53.42	1.34
1550.0	53.88	1.36	53.39	1.37
1600.0	53.81	1.39	53.35	1.40
1650.0	53.69	1.43	53.31	1.43
1700.0	53.56	1.46	53.26	1.47
1750.0	53.43	1.49	53.22	1.50
1800.0	53.30	1.52	53.16	1.53
1850.0	53.30	1.52	53.09	1.57
1900.0	53.30	1.52	53.01	1.60
1950.0	53.30	1.52	52.92	1.63
2000.0	53.30	1.52	52.85	1.67
2050.0	53.23	1.57	52.80	1.71
2100.0	53.17	1.62	52.76	1.75
2150.0	53.10	1.66	52.70	1.79
2200.0	53.03	1.71	52.62	1.83
2250.0	52.97	1.76	52.53	1.88
2300.0	52.90	1.81	52.42	1.92
2350.0	52.83	1.85	52.33	1.97
2400.0	52.77	1.9	52.24	2.03
2450.0	52.70	1.95	52.16	2.08
2500.0	52.64	2.02	52.08	2.13
2550.0	52.57	2.09	51.98	2.18
2600.0	52.51	2.16	51.86	2.23
2650.0	52.45	2.23	51.71	2.28
2700.0	52.38	2.3	51.54	2.33
2750.0	52.32	2.38	51.37	2.38
2800.0	52.25	2.45	51.20	2.44
2850.0	52.19	2.52	51.04	2.50
2900.0	52.13	2.59	50.90	2.56

2950.0	52.06	2.66	50.77	2.62
3000.0	52.00	2.73	50.65	2.67
3050.0	51.93	2.79	50.52	2.72
3100.0	51.86	2.85	50.39	2.77
3150.0	51.80	2.91	50.26	2.82
3200.0	51.73	2.96	50.14	2.88
3250.0	51.66	3.02	50.02	2.94
3300.0	51.59	3.08	49.91	3.00
3350.0	51.52	3.14	49.81	3.05
3400.0	51.46	3.20	49.71	3.11
3450.0	51.39	3.26	49.60	3.16
3500.0	51.32	3.31	49.50	3.20
3550.0	51.25	3.37	49.40	3.25
3600.0	51.19	3.43	49.28	3.31
3650.0	51.12	3.49	49.17	3.36
3700.0	51.05	3.55	49.05	3.42
3750.0	50.98	3.61	48.94	3.48
3800.0	50.91	3.66	48.85	3.55
3850.0	50.85	3.72	48.77	3.61
3900.0	50.78	3.78	48.69	3.66

