

TEST REPORT

TAS ALGORITHM COMPLIANCE

EUT Description	Convertible PC
Brand Name	HP
Model Name	TPN-W155
FCC ID	B94-TNW155GP2KV
Date of Test Start/End	2022-05-13 / 2022-06-02
Features	NR, LTE, WCDMA

Applicant	HP Inc.
Address	1501 Page Mill Road, Palo Alto CA 94304 USA
Contact Person	Sam Lin
Telephone/Fax/ Email	+886 2 37896331/sam.lin2@hp.com

Test Report identification	220425-01.TR03
Revision Control	Rev. 00 This test report revision replaces any previous test report revision

TABLE OF CONTENTS

1. Test Setup Description	3
1.1. Measurement System	3
1.2. Equipments List	4
1.3. Test Samples	4
1.4. Software / Firmware	4
2. Test Results	5
2.1. Summary of Test Cases	5
2.2. TAS Parameters Range Compliance - NR	6
2.3. TAS Parameters Range Compliance - LTE	14
2.4. TAS Parameters Range Compliance - WCDMA	22
2.5. Bands Validation - NR	30
2.6. Bands Validation - LTE	39
2.7. Bands Validation - WCDMA	54
2.8. Time Varying Test Sequence - NR	58
2.9. Time Varying Test Sequence - LTE	60
2.10. Time Varying Test Sequence - WCDMA	62
2.11. Handover - LTE-LTE	64
2.12. Handover - LTE-WCDMA	65
2.13. Call Drop and Reboot - NR	66
3. Conclusion	68

1. Test Setup Description

1.1. Measurement System

The conducted power measurement test setup is described in the following and illustrated in Figure 1

- a. The DUT is a Fibocom M2 FM350-GL Cellular Modem installed inside HP model TPN-W155 convertible PC HP.
- b. The control PC is used to configure the Call Box to send power control test sequences to the FM350-GL
- c. Uplink signal power is monitored by the Spectrum Analyzer and record by the PC with a time resolution of 25 msec which is substantially less than the power adjustment interval (Avg_SAR_Check_Period) of 0.05 sec used for FM350-GL .
- d. The values of Avg_SAR_Power are read from the FM350-GL by the PC at each Avg_SAR_Check_Period
- e. In addition to power results, the time sequence of power control commands and power samples are also recorded by the PC to enable results to be correlated and plotted. Uplink signal from the FM350-GL is fed through a 3 dB Power Splitter, which delivers an equal amount of signal to the Spectrum Analyser and the Call Box. The Splitter has high isolation between the Spectrum Analyser and the Call Box. Due to different Uplink/Downlink frequencies and the zero span time-domain measurement used, interference of Uplink and Downlink sigals is avoided.
- f. Path loss in the power measurement setup from the FM350-GL Main Antenna port to either the Call Box or the Spectrum Analyser is taken into account

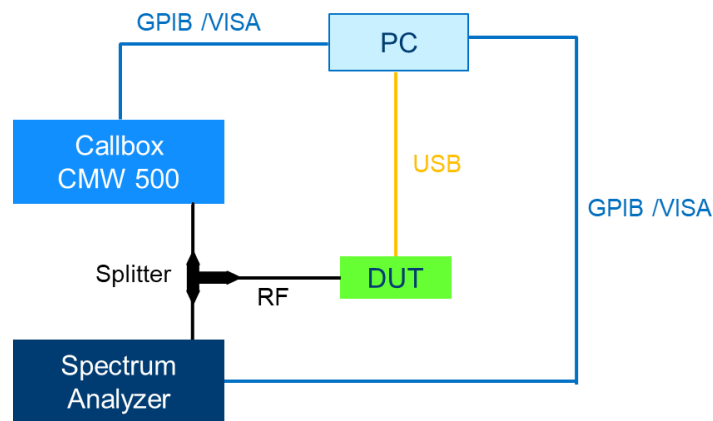

Figure 1 - Test Setup

1.2. Equipments List

The Equipments used for the conducted power measurement test setup are listed in Table below.

ID	Device	Model	Serial	Manufacturer	Cal. Date	Cal. Due Date	Comment
135-000	Communication Tester	CMW500	152721	Rohde & Schwarz	2022-03-29	2024-03-29	Used for LTE and WCDMA
121-000	Spectrum Analyzer	FSU67	100092	Rohde & Schwarz	2021-01-26	2023-01-26	
024	Cable Setup	-	-	-	Attenuation and loss verified before use		
R117	Communication Tester	CMX500	101624	Rohde & Schwarz	-	-	Used for NR
424-000	Spectrum Analyzer	FSVA30	101102	Rohde & Schwarz	2021-06-28	2023-06-28	
453	Setup Cable	-	-	-	Attenuation and loss verified before use		

1.3. Test Samples

Sample	ID	Description	Model	PC Serial	Module Serial	Note
#1	220425-01.S06	Convertible PC	TPN-W155	2021101409484	C202MJ1CCN	Used for all case except LTE48
#2	220425-01.S08	Convertible PC	TPN-W155	2021101409484	C892MY006R	Used for Band Validation LTE48

1.4. Software / Firmware

Sample	Firmware	Version
#1	Fibocom	81600.0000.00.29.18.16 v1.0.6
#2	Fibocom	81600.0000.00.29.19.16 v1.0.6

2. Test Results

2.1. Summary of Test Cases

The following table lists the types of TAS algorithm validation tests performed and the corresponding Tables describing the test configurations and validation results.

Validation type	RAT	Configurations	Results	Verdict
TAS Parameters Range Compliance	NR	Table 1	Section 2.2	Pass
	LTE	Table 2	Section 2.3	Pass
	WCDMA	Table 3	Section 2.4	Pass
Bands Compliance	NR	Table 4	Section 2.5	Pass
	LTE	Table 5	Section 2.6	Pass
	WCDMA	Table 6	Section 2.7	Pass
Time Varying Test Sequence	NR	Table 7	Section 2.8	Pass
	LTE	Table 8	Section 2.9	Pass
	WCDMA	Table 9	Section 2.10	Pass
Handover	LTE-LTE	Table 10	Section 2.11	Pass
	LTE-WCDMA	Table 11	Section 2.12	Pass
Call Drop and Reboot	NR	Table 12	Section 2.13	Pass

2.2. TAS Parameters Range Compliance - NR

Table 1 - Test Cases for TAS Parameters Range Compliance of NR bands

Case	RAT	Band	Max_Power_DP R_OFF_dBm	Roll_Period_s	Check_Period_s	Avg_SAR_UppT hresh_dBm	Avg_SAR_Low Thresh_dBm	Max_Power_DP R_ON_dBm
1	NR	5	23	100	0.05	22	21	20
2	NR	5	23	100	0.05	22	21	18
3	NR	5	23	100	0.05	22	19	18
4	NR	5	23	100	0.05	22	19	16
5	NR	5	23	100	0.05	18	17	16
6	NR	5	23	100	0.05	18	17	14
7	NR	5	23	100	0.05	18	15	14
8	NR	5	23	100	0.05	18	15	12
9	NR	5	23	100	0.05	13	12	11
10	NR	5	23	100	0.05	13	12	9
11	NR	5	23	100	0.05	13	10	9
12	NR	5	23	100	0.05	13	10	7
13	NR	5	23	360	0.05	18	17	14

Note: The Average power is calculated using the measured instantaneous power and compared to the UpperThreshold Plus Tune-Up Tolerance. This is applied for all the test cases in this report.

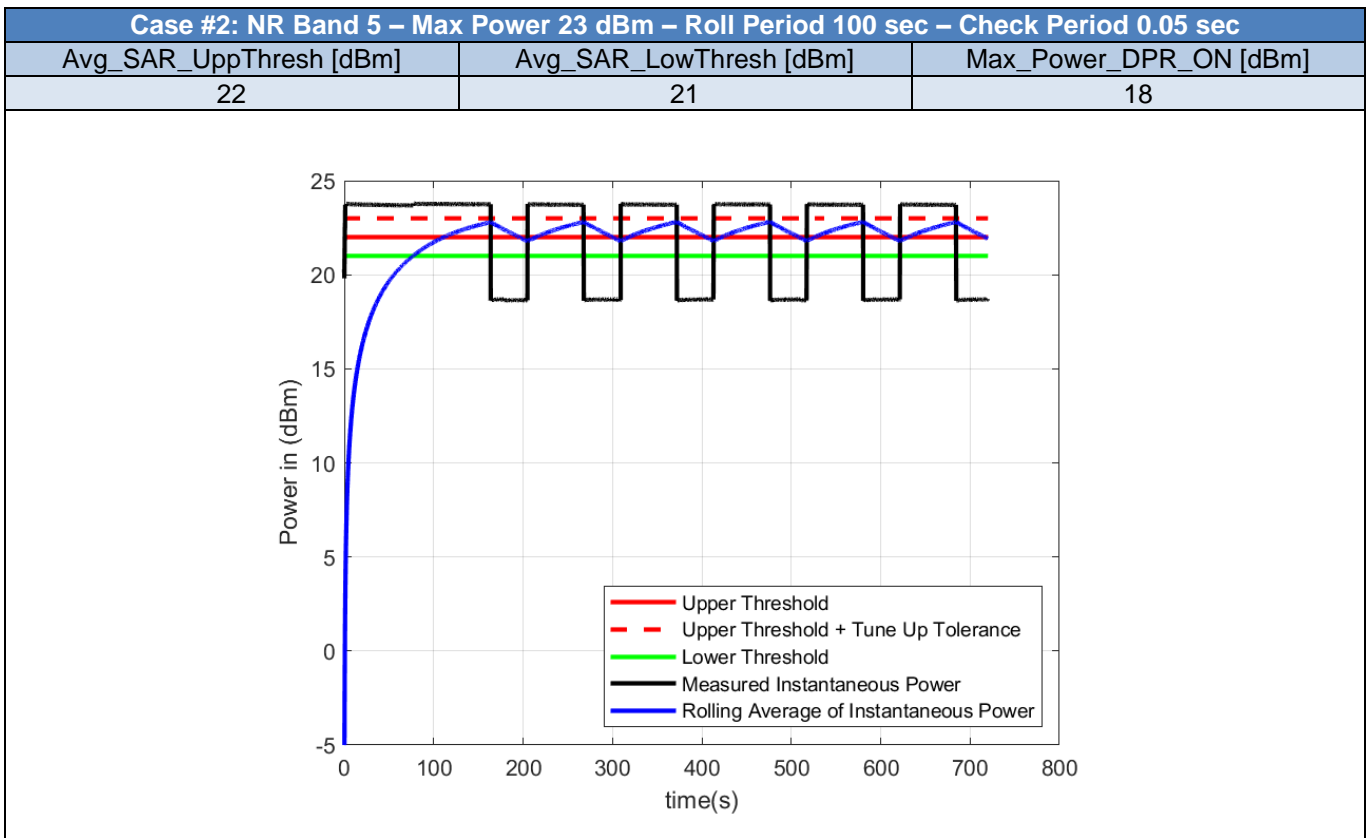
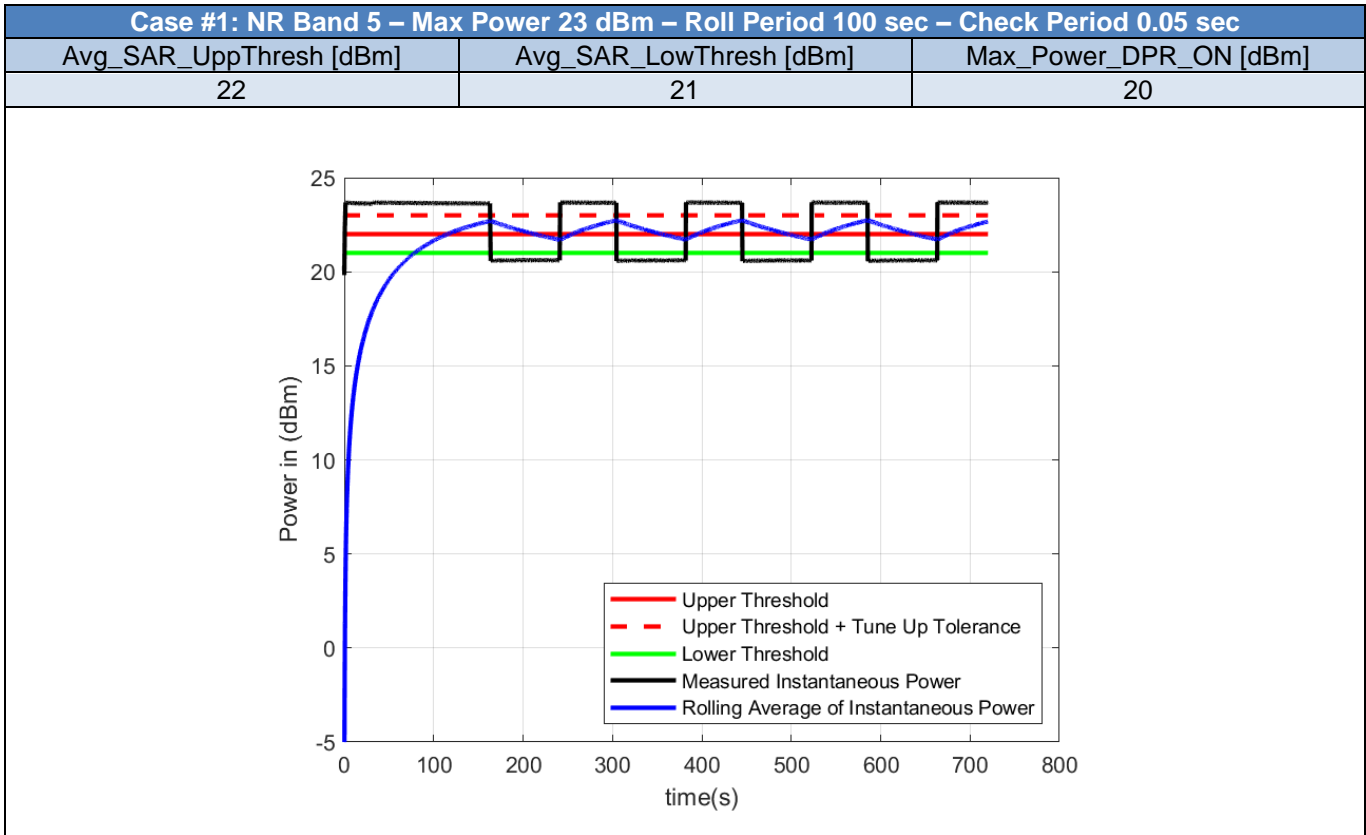

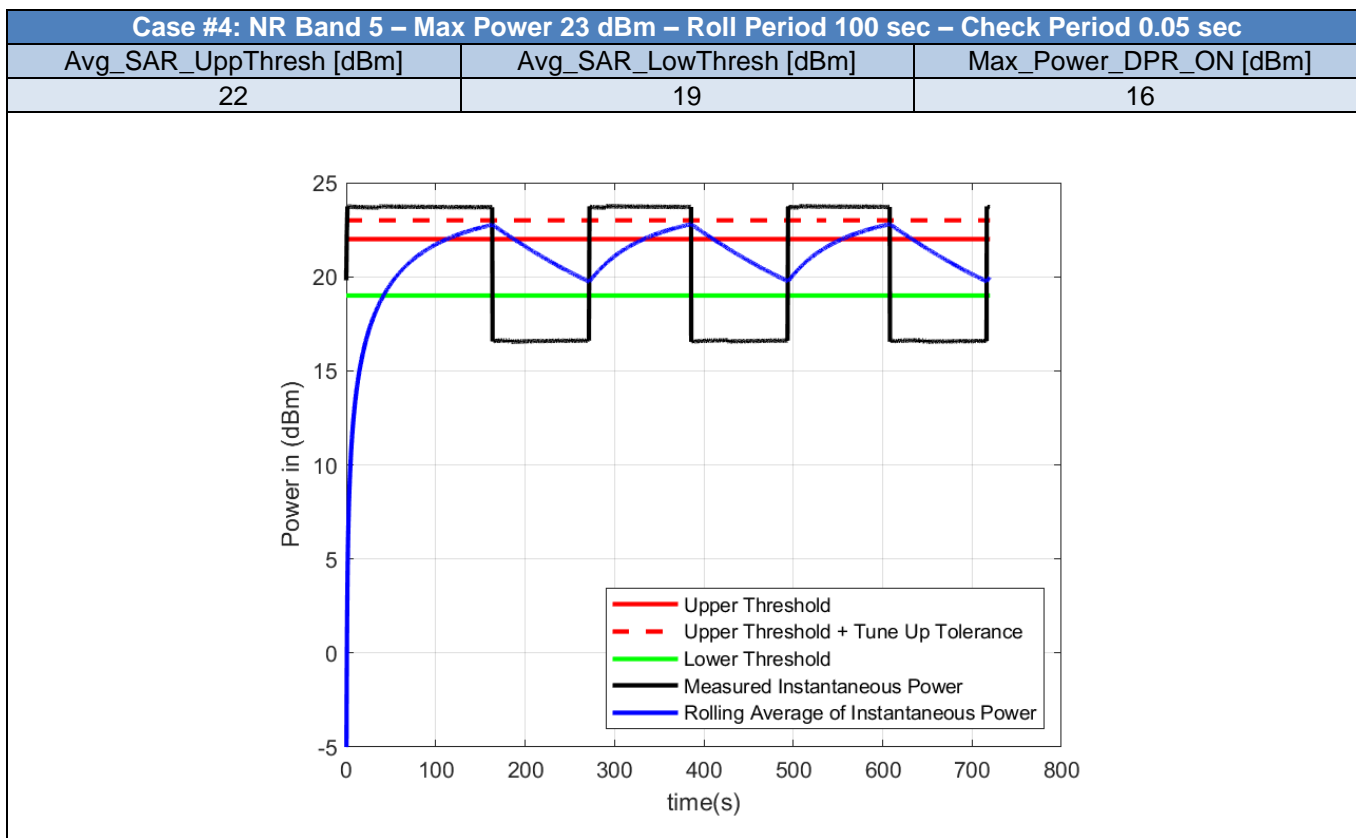
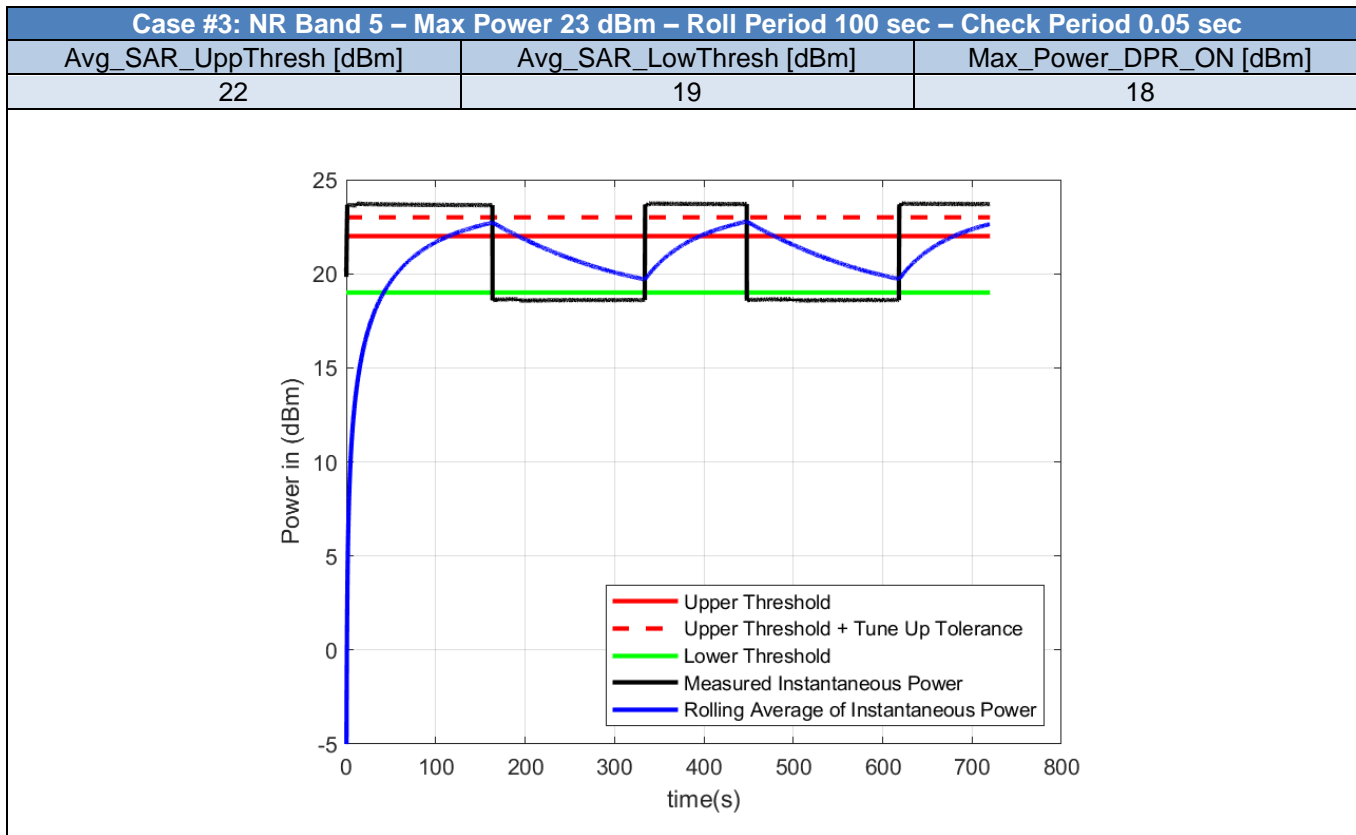

Case #5: NR Band 5 – Max Power 23 dBm – Roll Period 100 sec – Check Period 0.05 sec		
Avg_SAR_UppThresh [dBm]	Avg_SAR_LowThresh [dBm]	Max_Power_DPR_ON [dBm]
18	17	16

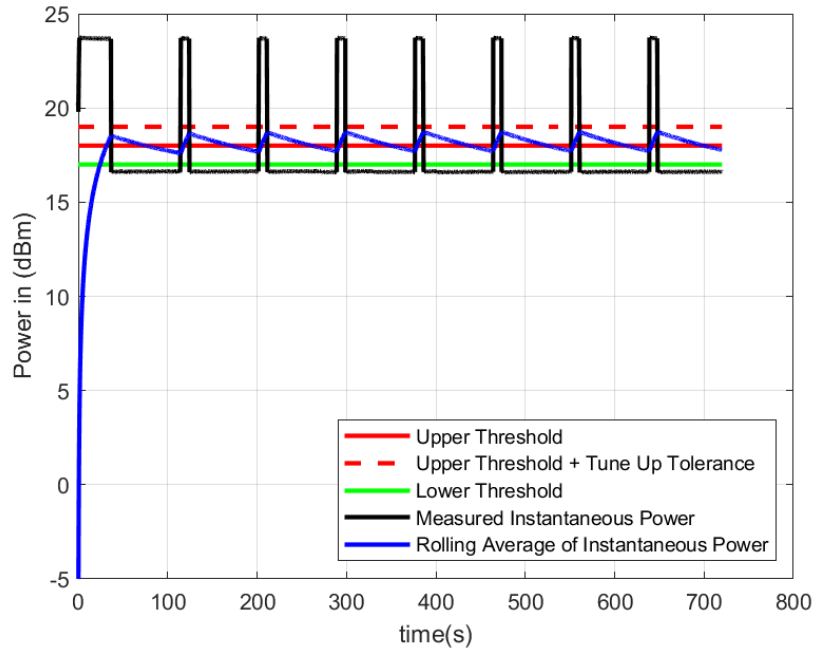

Case #6: NR Band 5 – Max Power 23 dBm – Roll Period 100 sec – Check Period 0.05 sec		
Avg_SAR_UppThresh [dBm]	Avg_SAR_LowThresh [dBm]	Max_Power_DPR_ON [dBm]
18	17	14

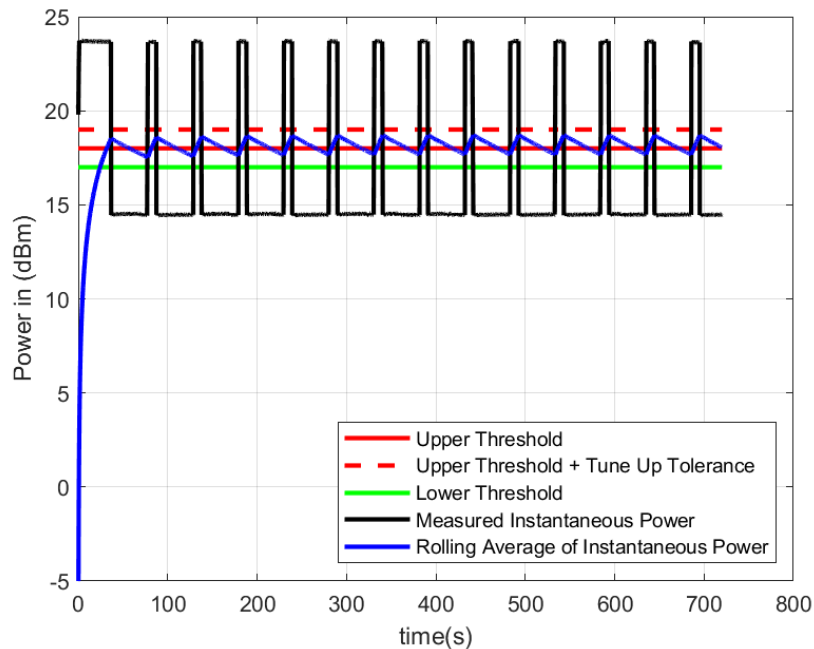

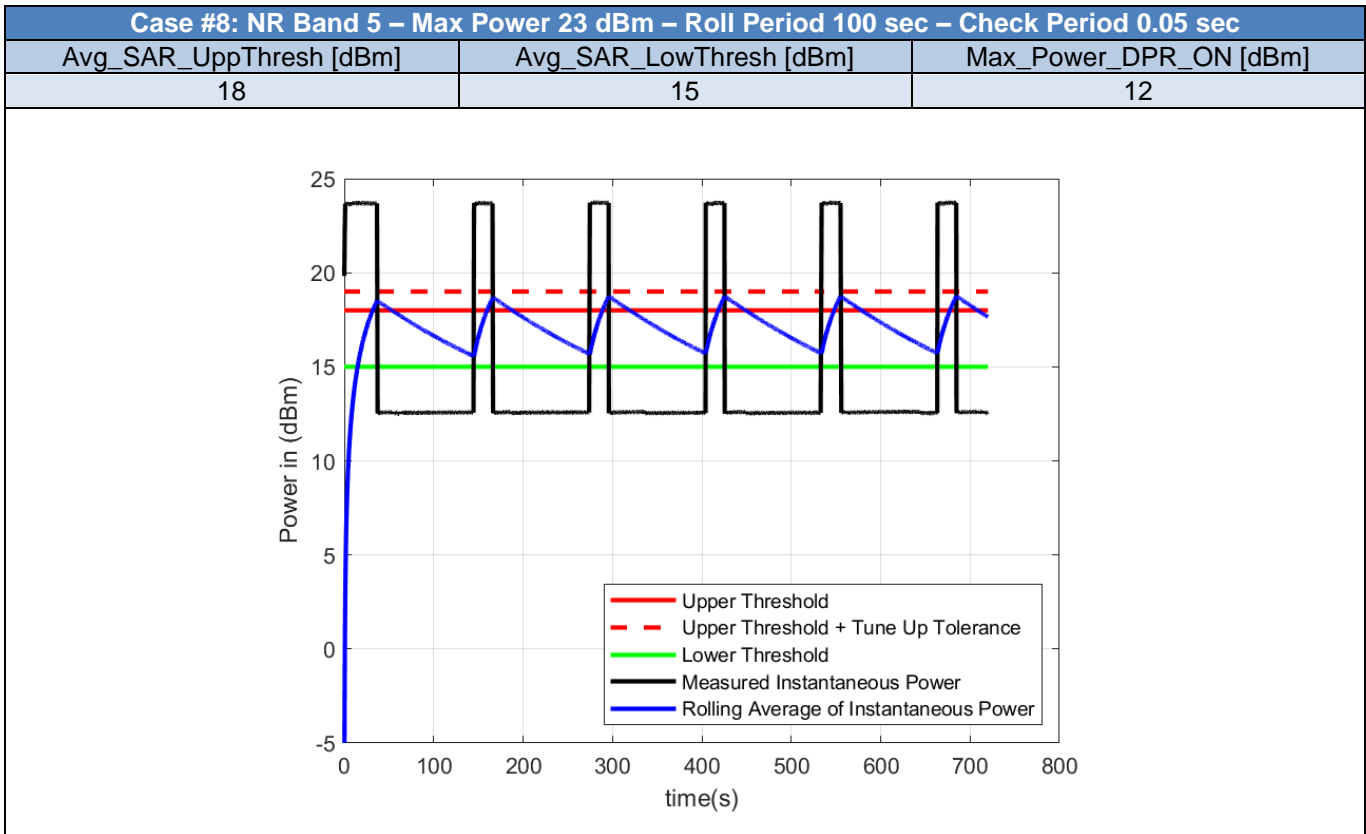
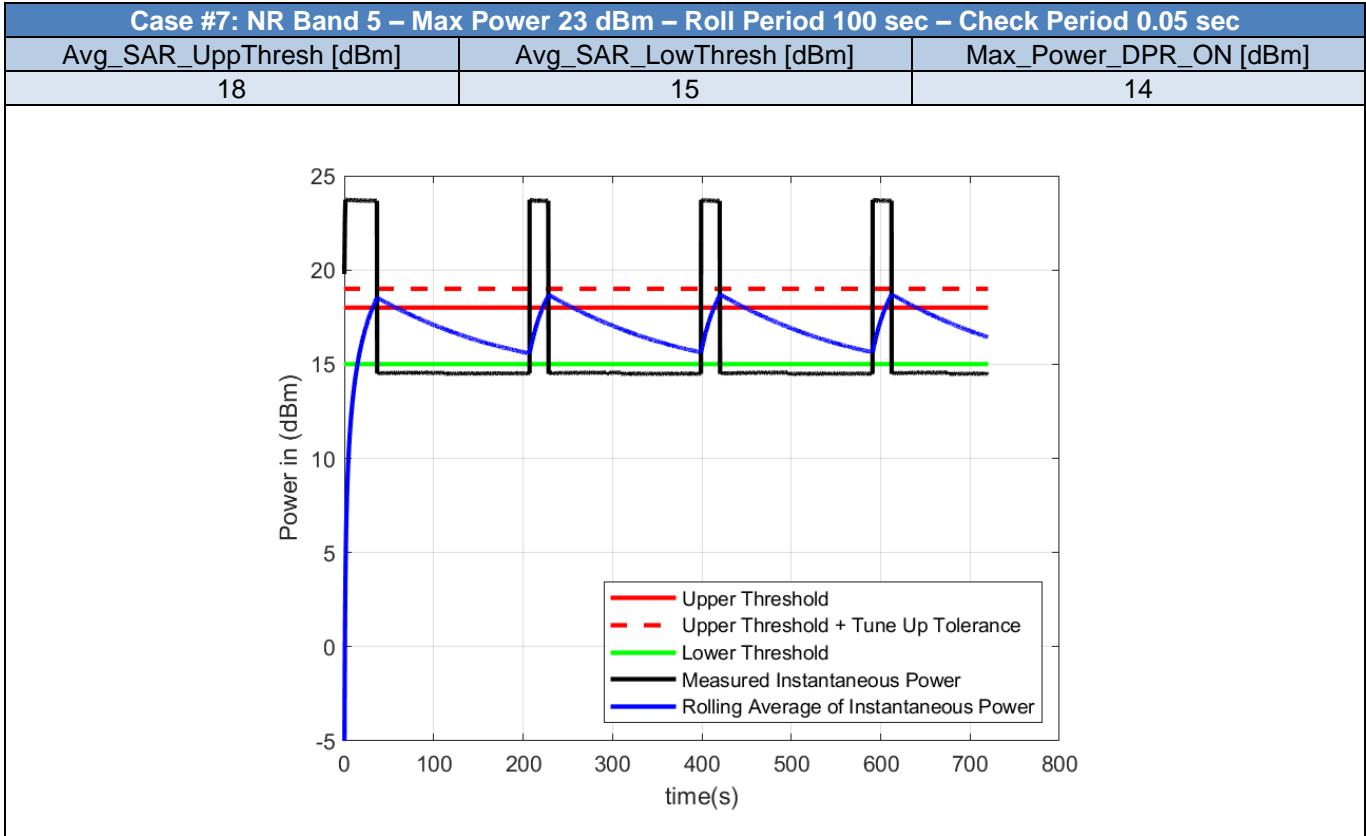

Case #9: NR Band 5 – Max Power 23 dBm – Roll Period 100 sec – Check Period 0.05 sec		
Avg_SAR_UppThresh [dBm]	Avg_SAR_LowThresh [dBm]	Max_Power_DPR_ON [dBm]
13	12	11

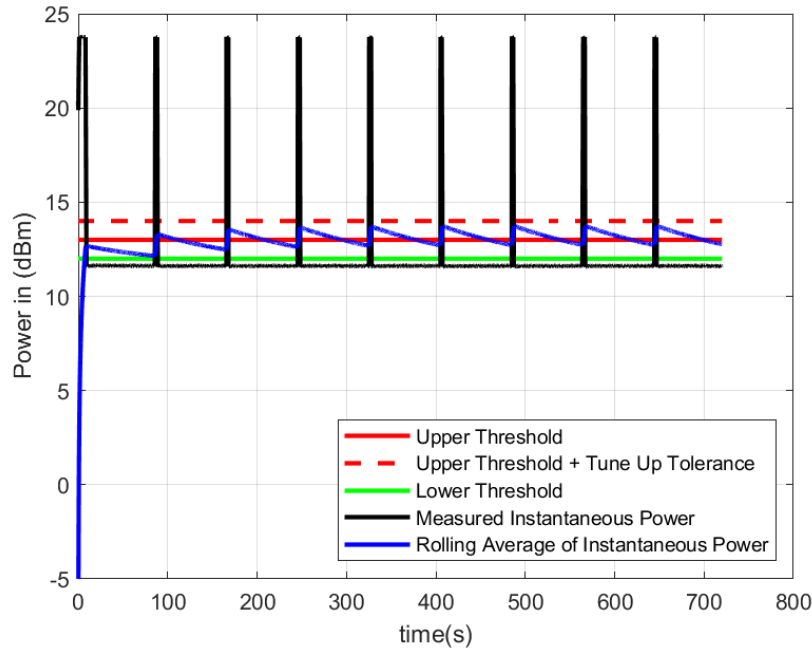

Case #10: NR Band 5 – Max Power 23 dBm – Roll Period 100 sec – Check Period 0.05 sec		
Avg_SAR_UppThresh [dBm]	Avg_SAR_LowThresh [dBm]	Max_Power_DPR_ON [dBm]
13	12	9

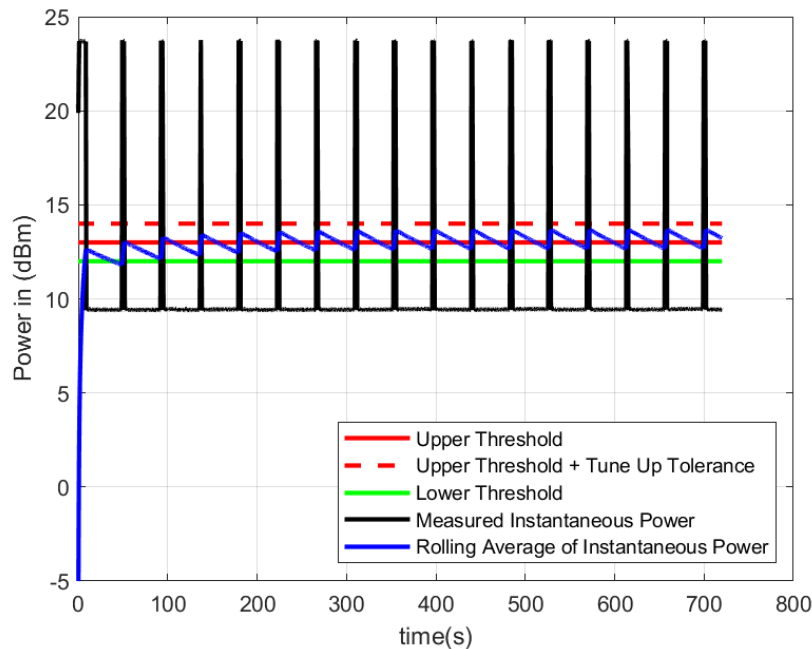

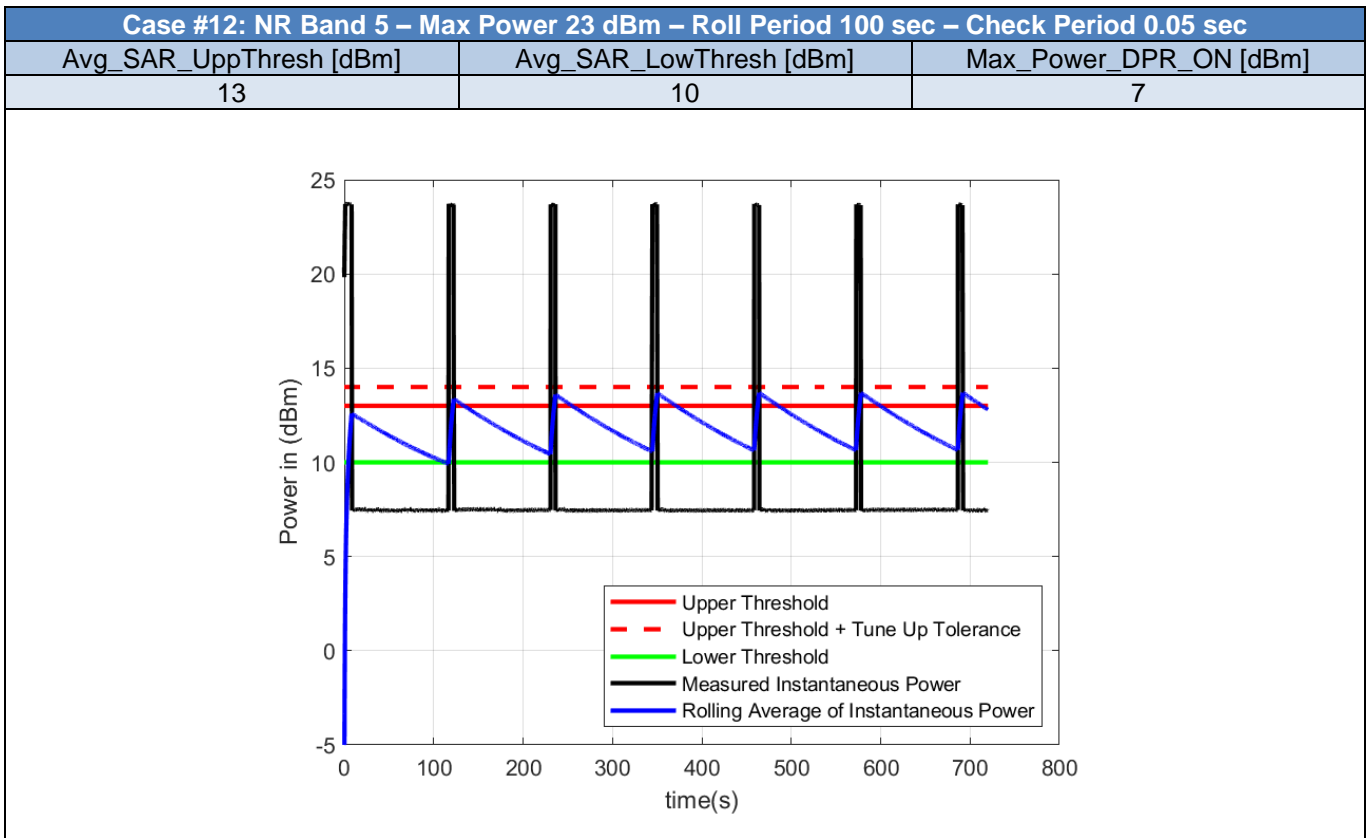
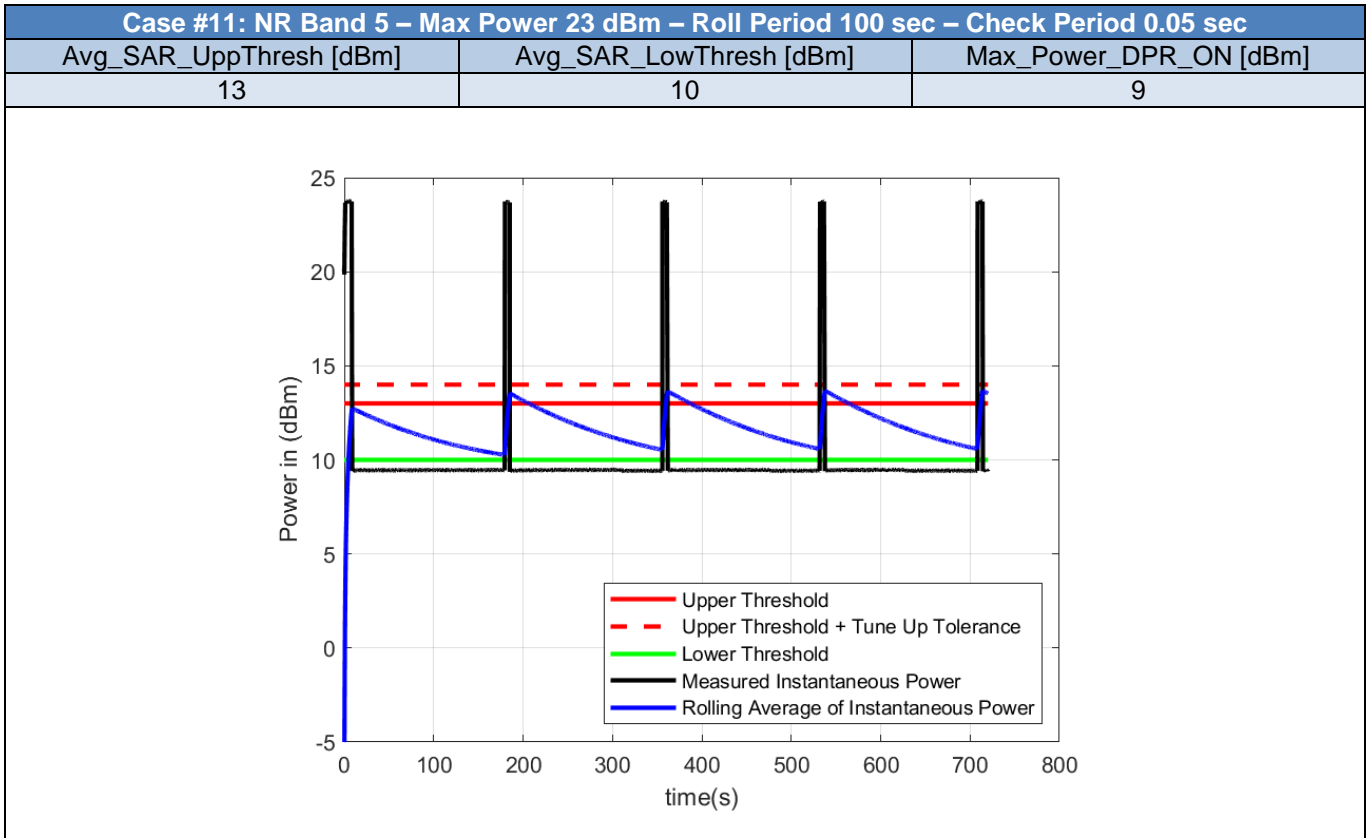

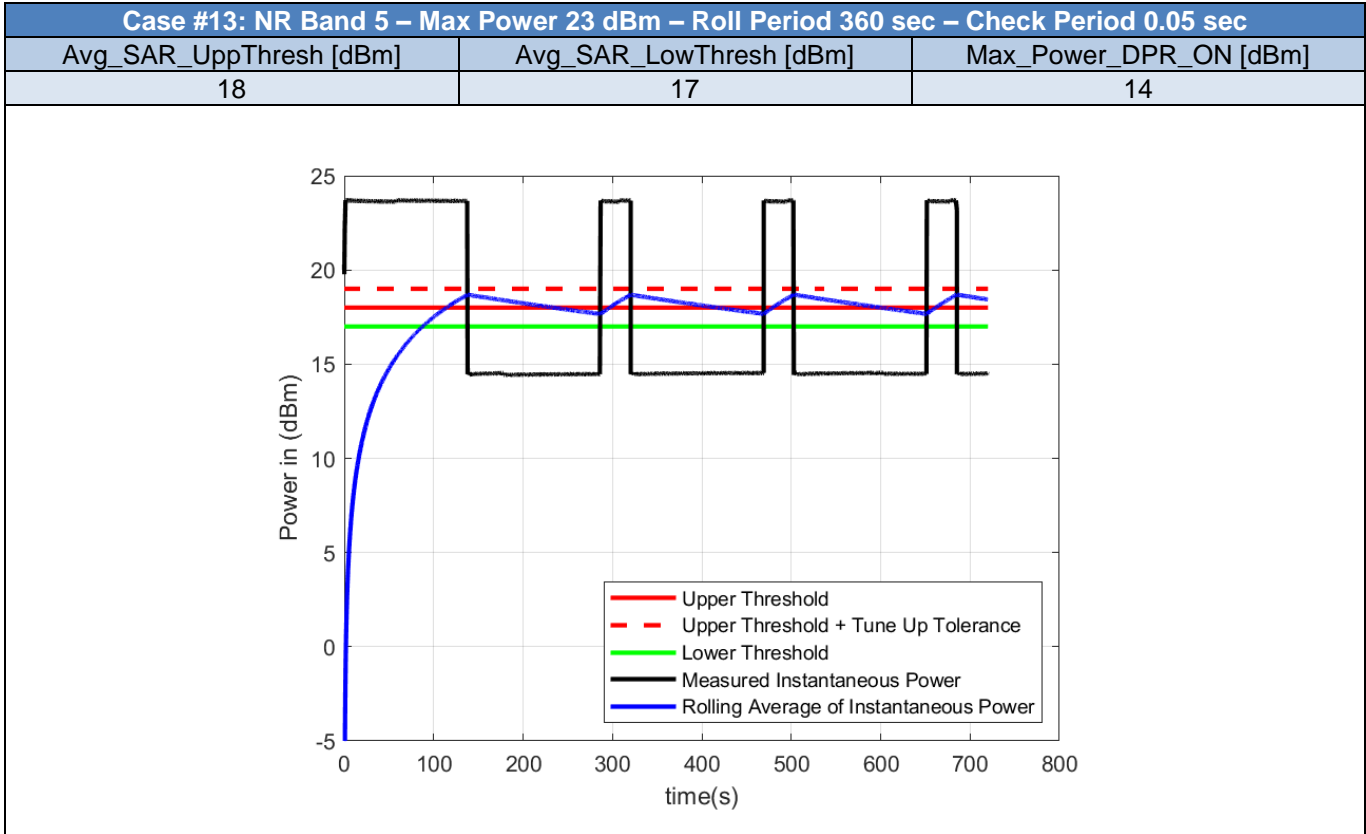

2.3. TAS Parameters Range Compliance - LTE

Table 2 - Test Cases for TAS Parameters Range Compliance of LTE bands

Case	RAT	Band	Max_Power_DP R_OFF_dBm	Roll_Period_s	Check_Period_s	Avg_SAR_UppT hresh_dBm	Avg_SAR_Low Thresh_dBm	Max_Power_DP R_ON_dBm
1	LTE	2	23	100	0.05	22	21	20
2	LTE	2	23	100	0.05	22	21	18
3	LTE	2	23	100	0.05	22	19	18
4	LTE	2	23	100	0.05	22	19	16
5	LTE	2	23	100	0.05	20	19	18
6	LTE	2	23	100	0.05	20	19	16
7	LTE	2	23	100	0.05	20	17	16
8	LTE	2	23	100	0.05	20	17	14
9	LTE	2	23	100	0.05	13	12	11
10	LTE	2	23	100	0.05	13	12	9
11	LTE	2	23	100	0.05	13	10	9
12	LTE	2	23	100	0.05	13	10	7
13	LTE	2	23	360	0.05	18	17	14

Note: The Average power is calculated using the measured instantaneous power and compared to the UpperThreshold Plus Tune-Up Tolerance. This is applied for all the test cases in this report.

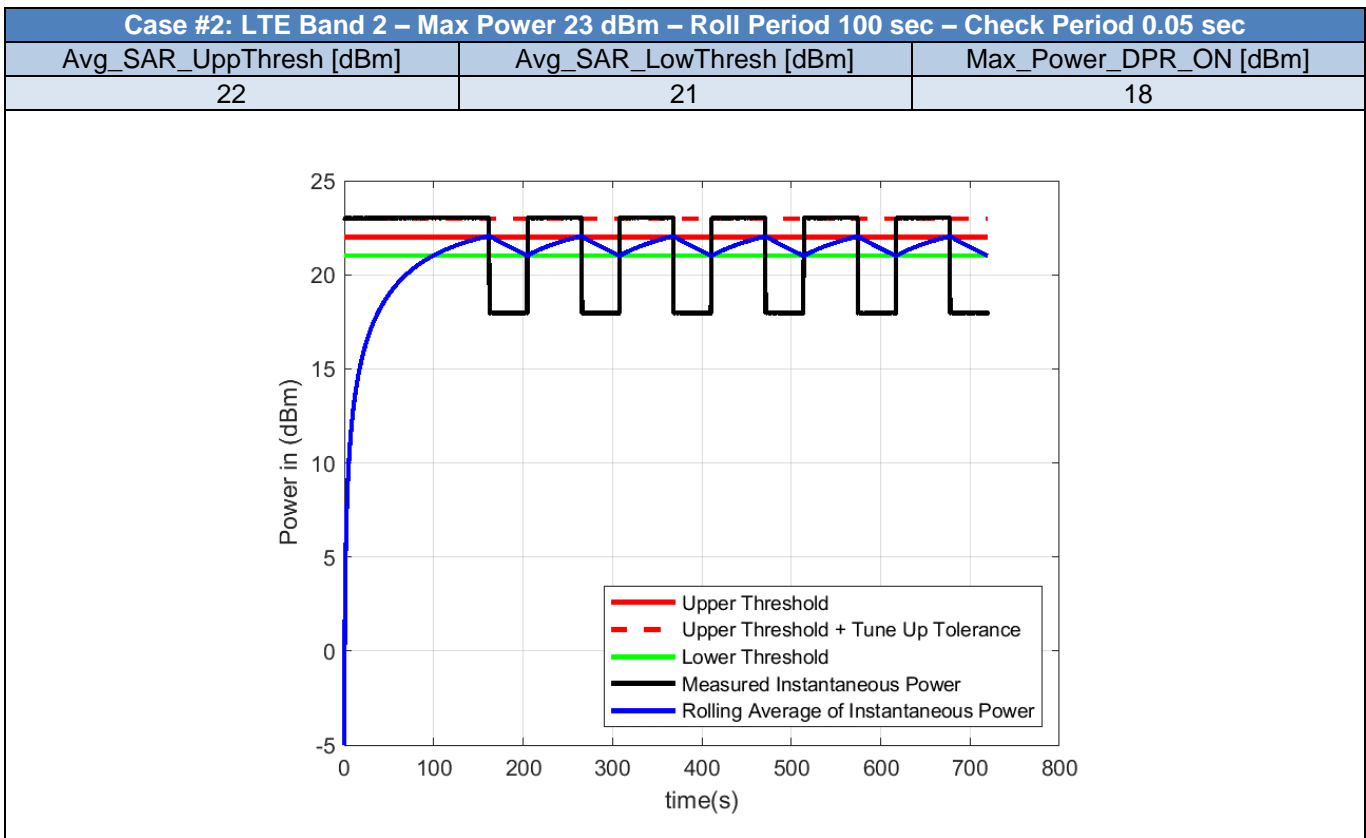
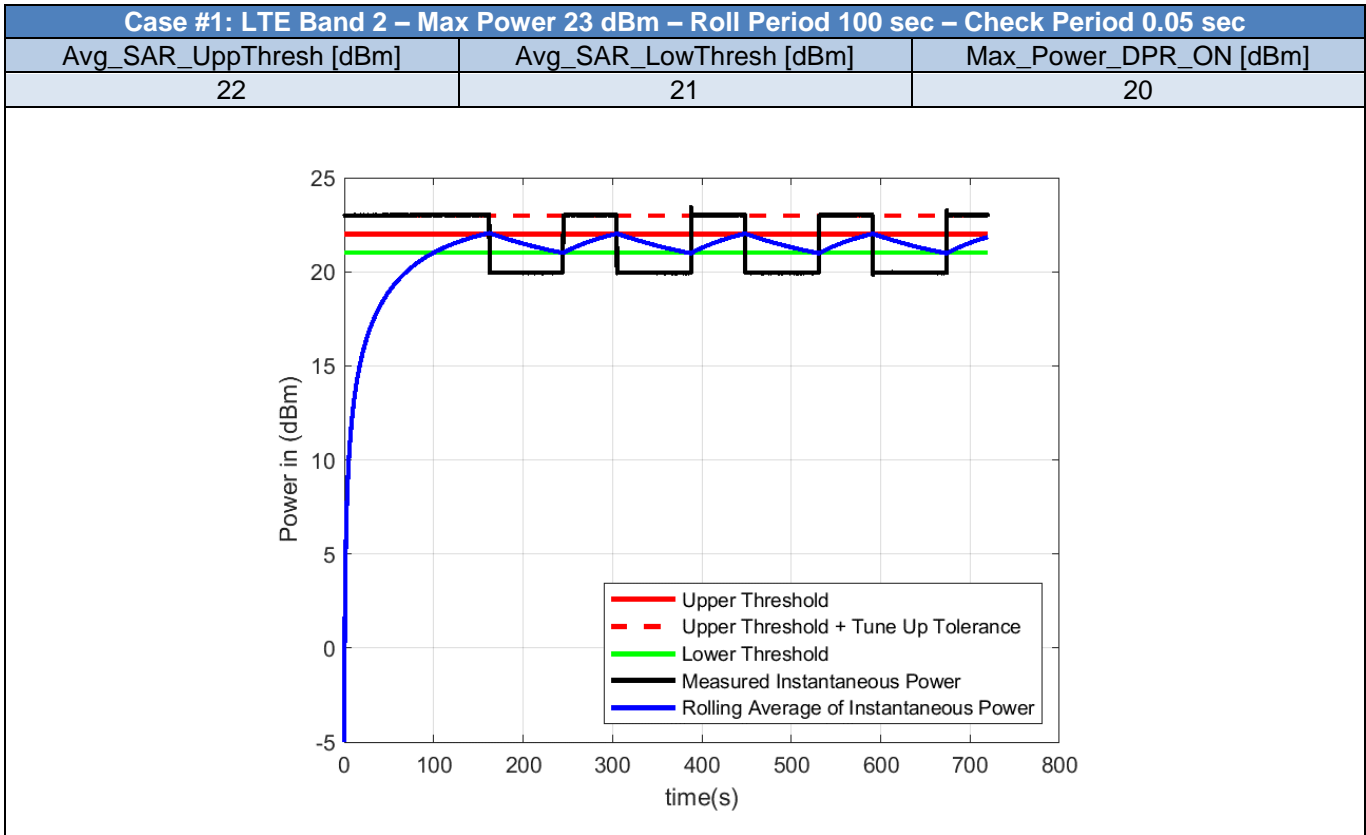

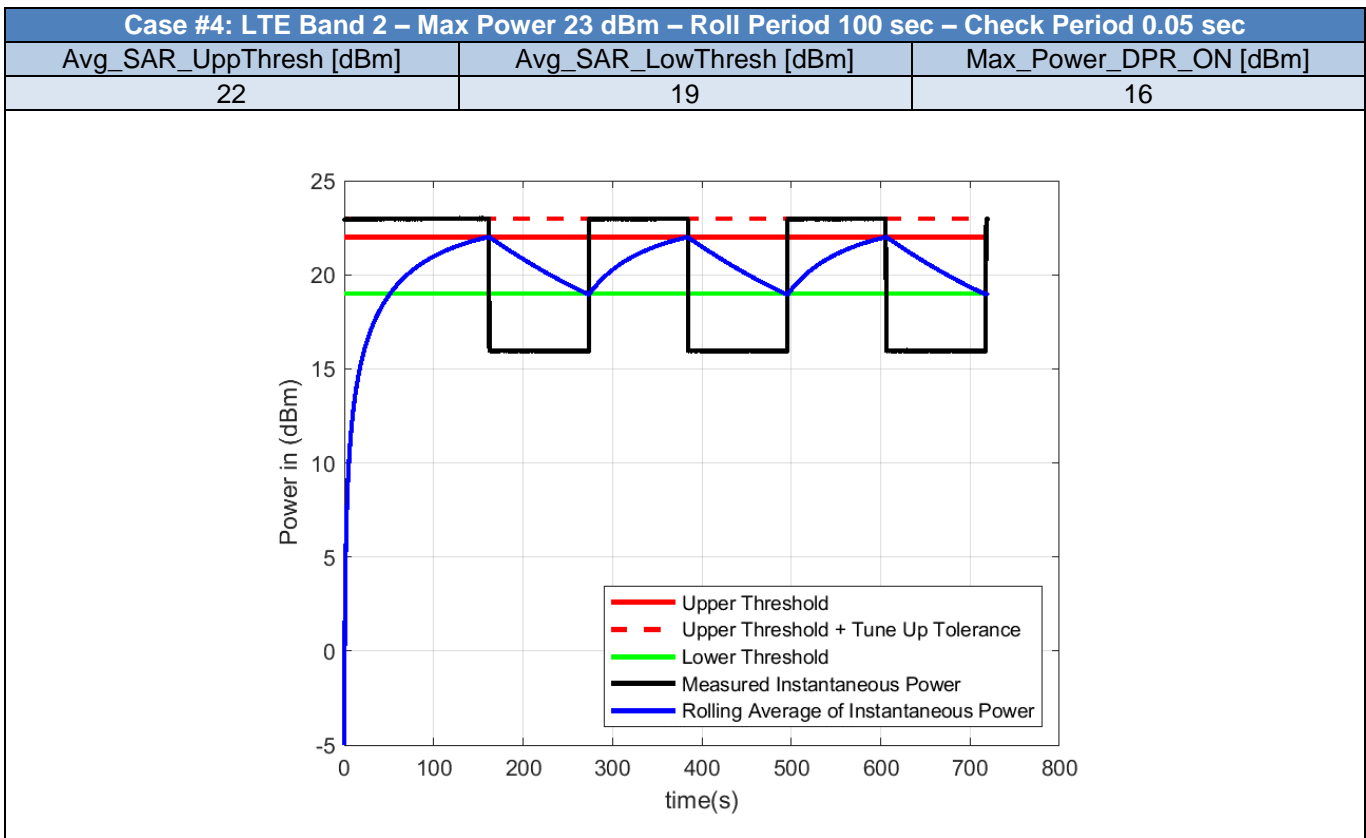
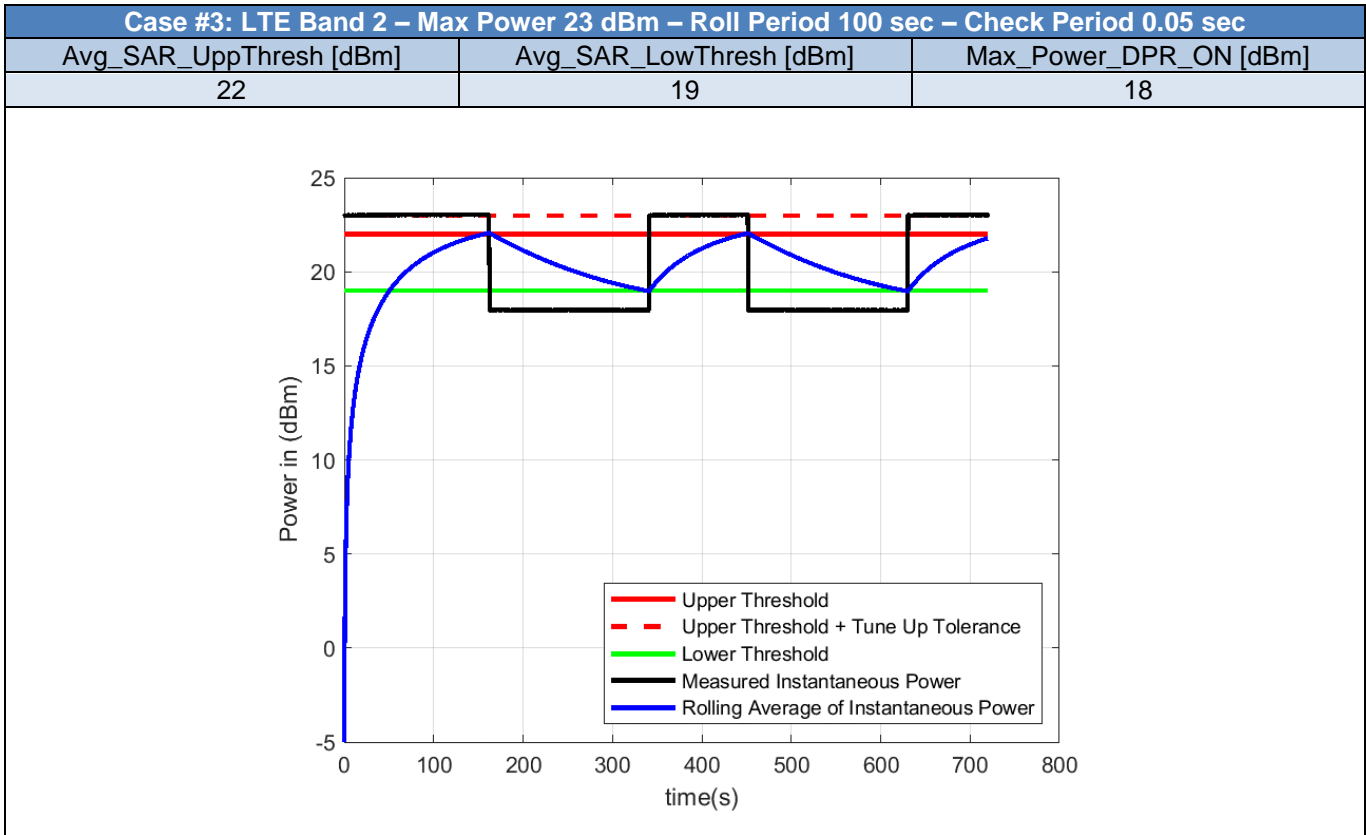

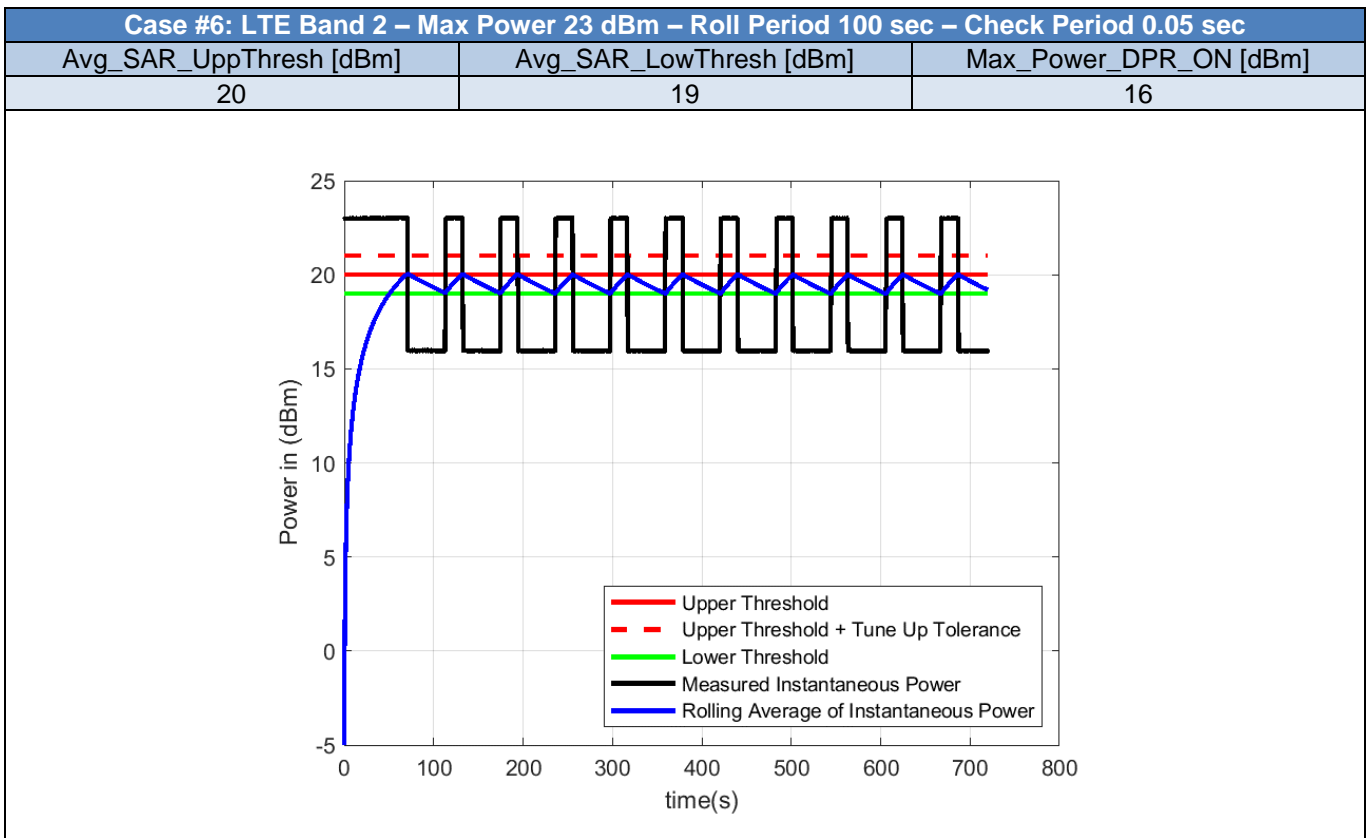
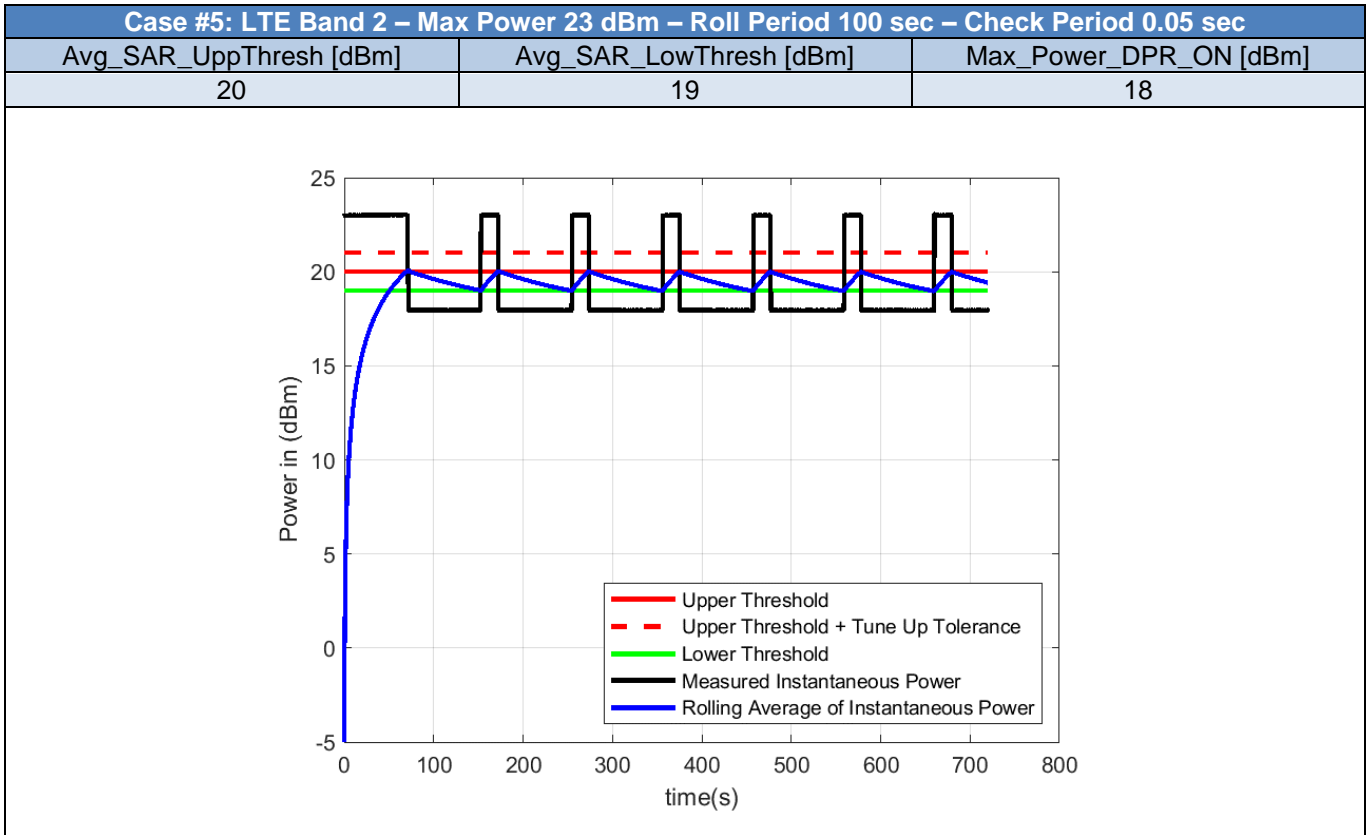

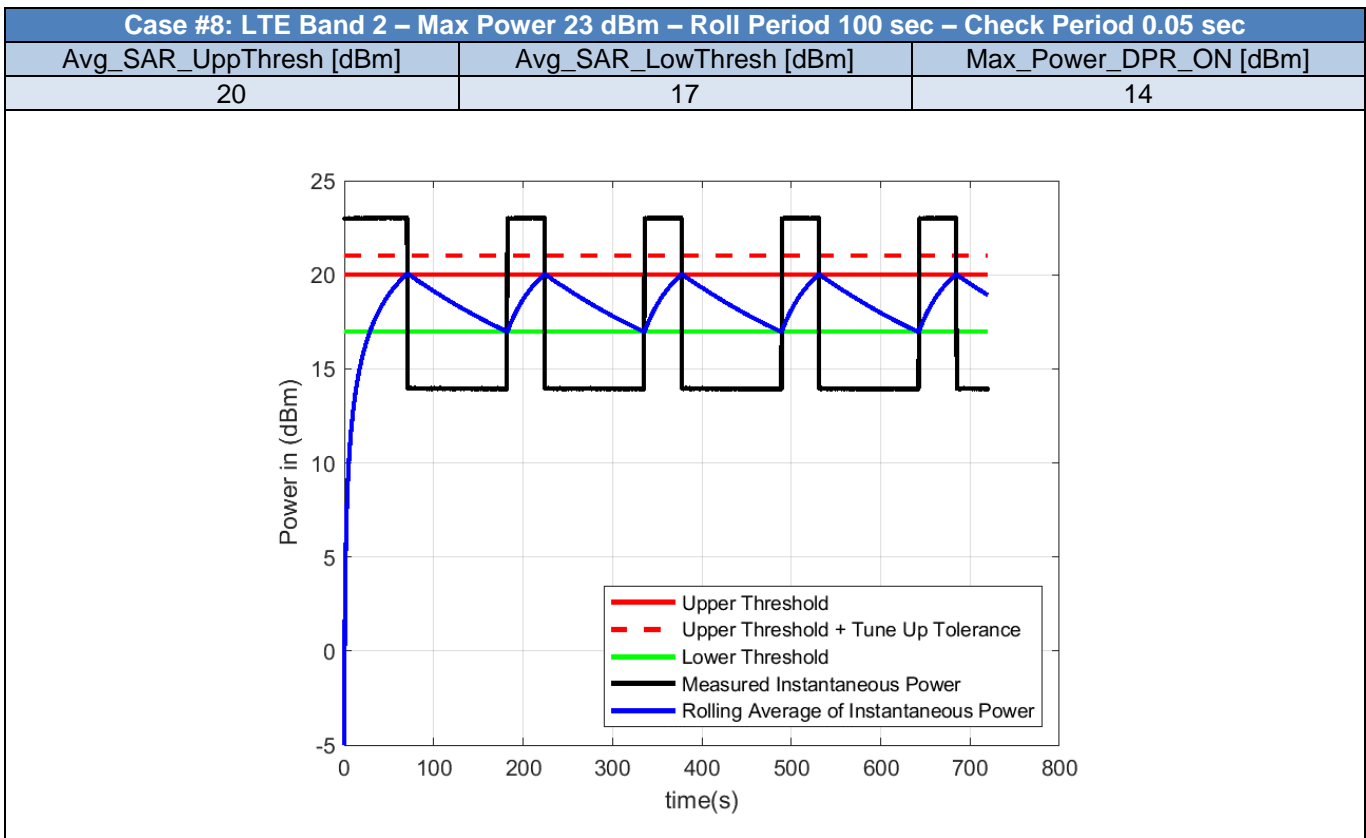
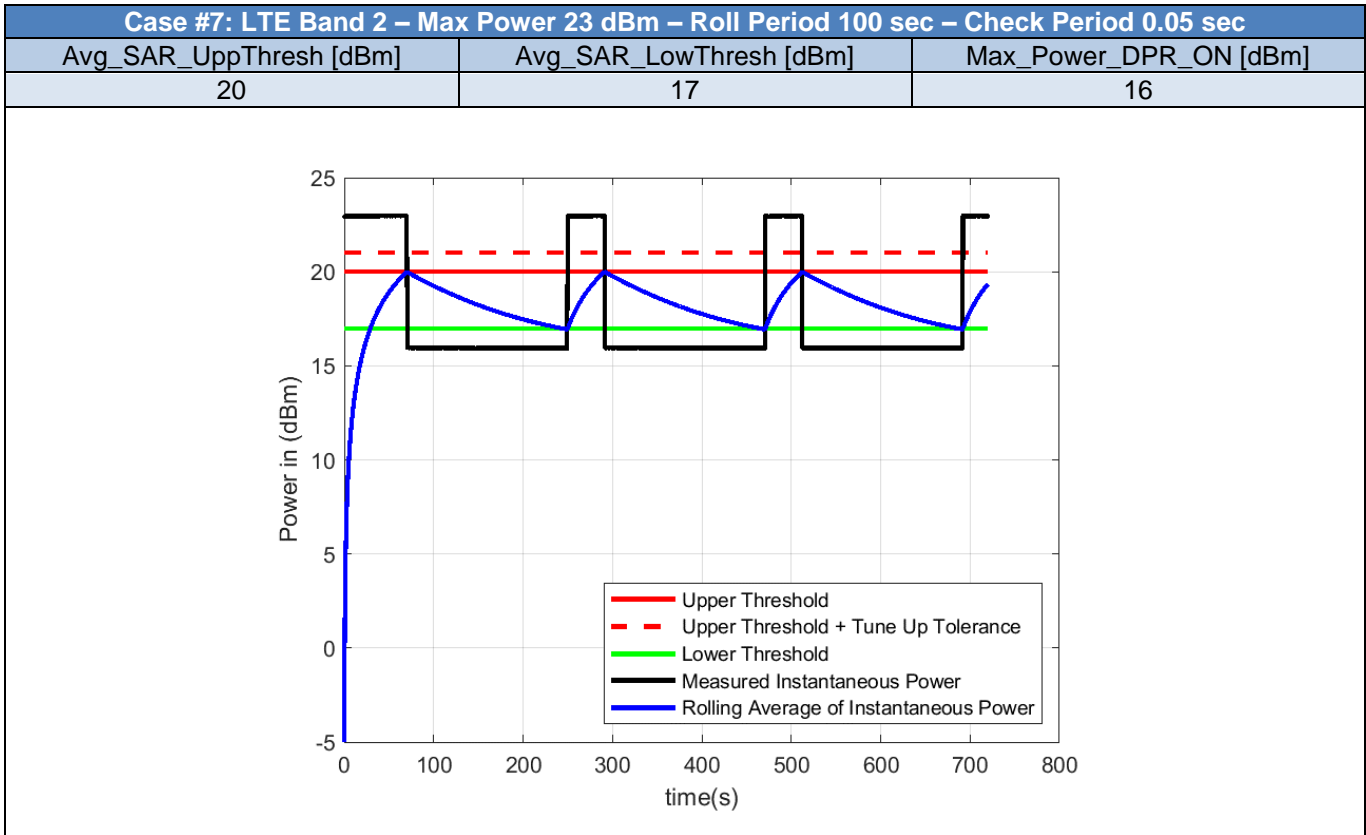

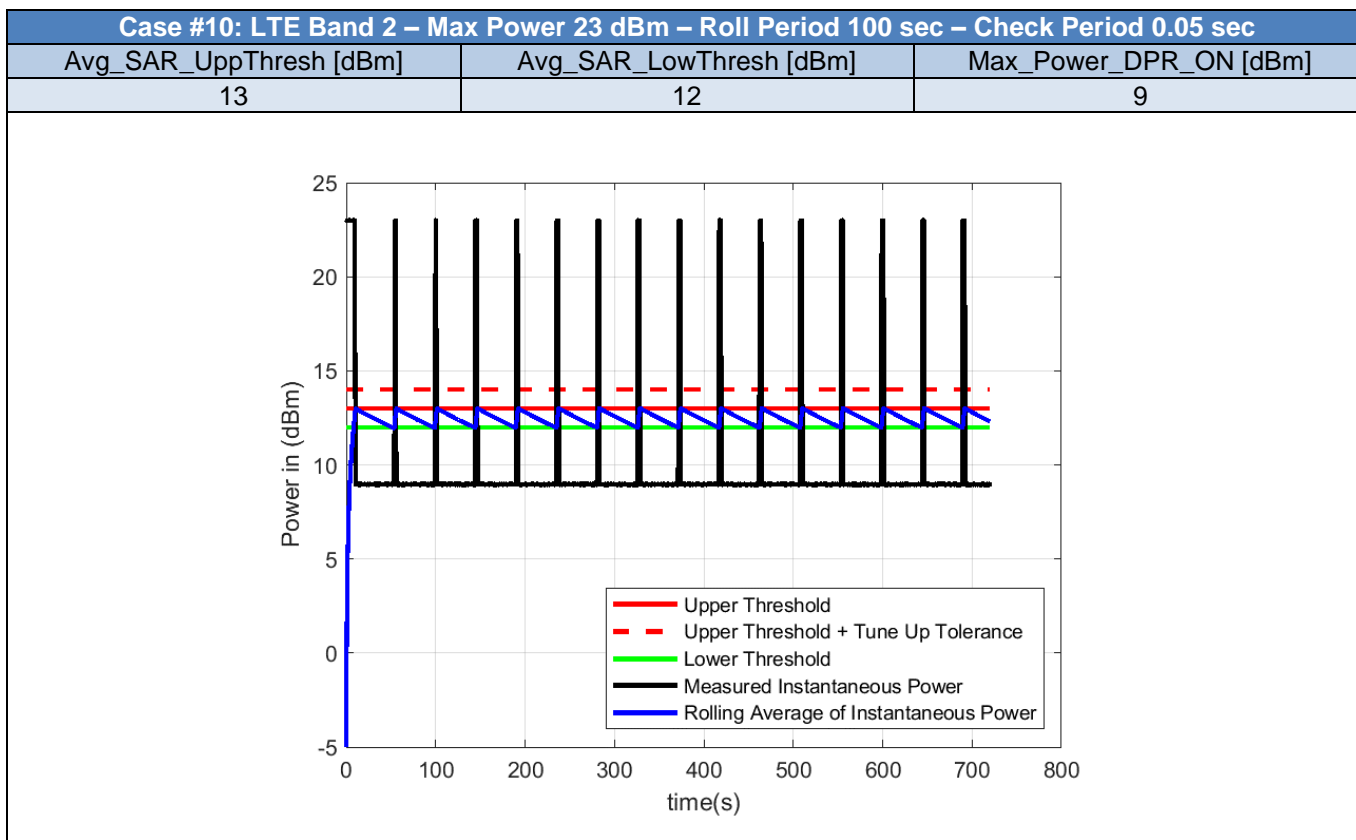
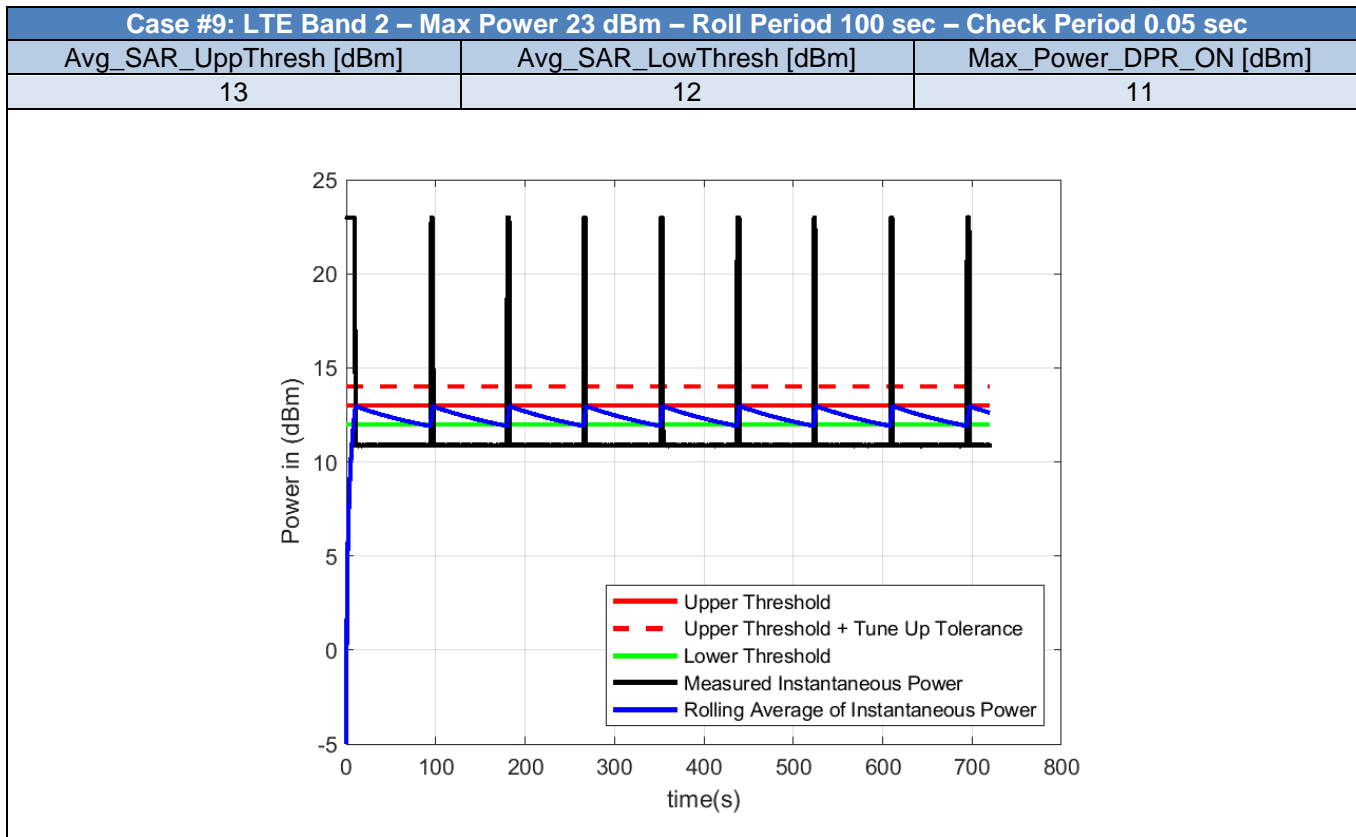

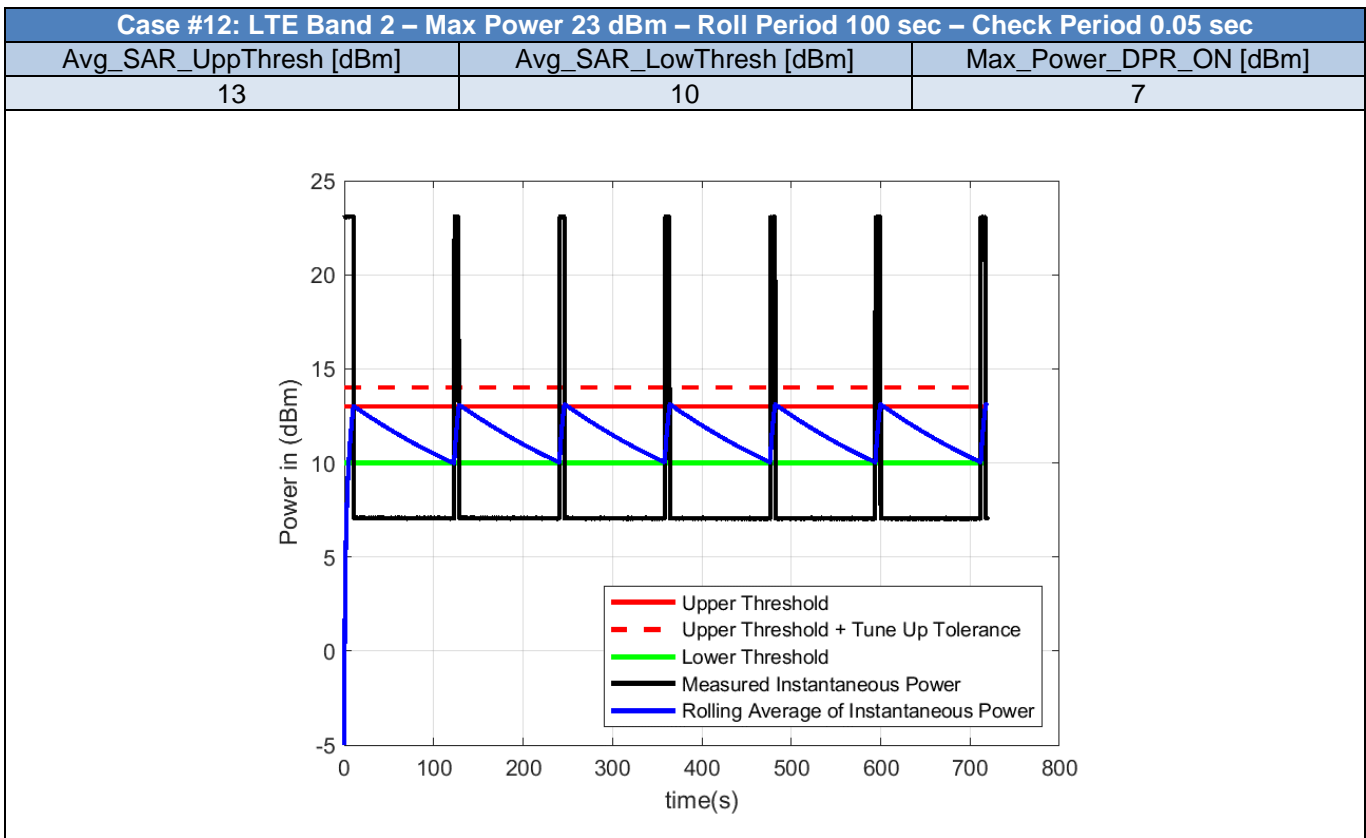
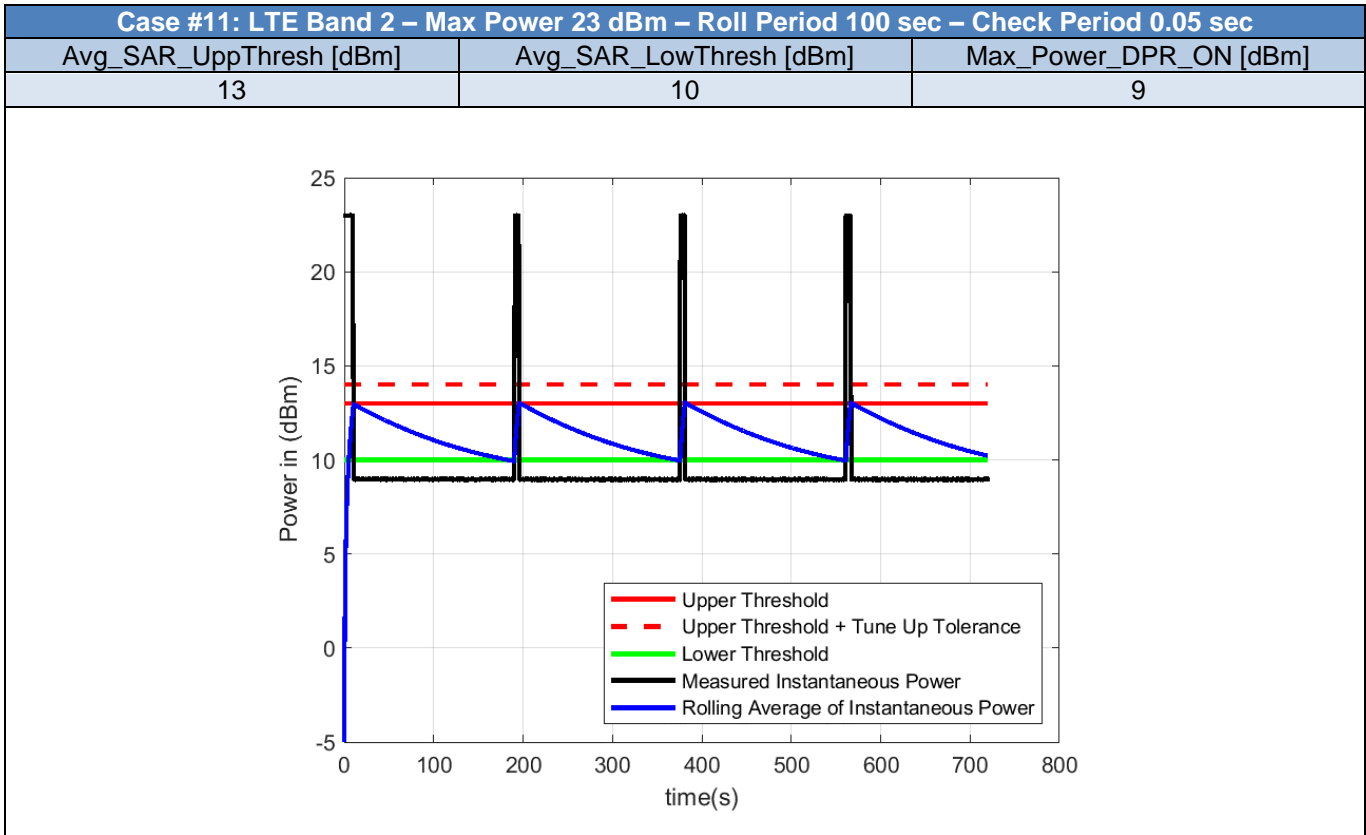

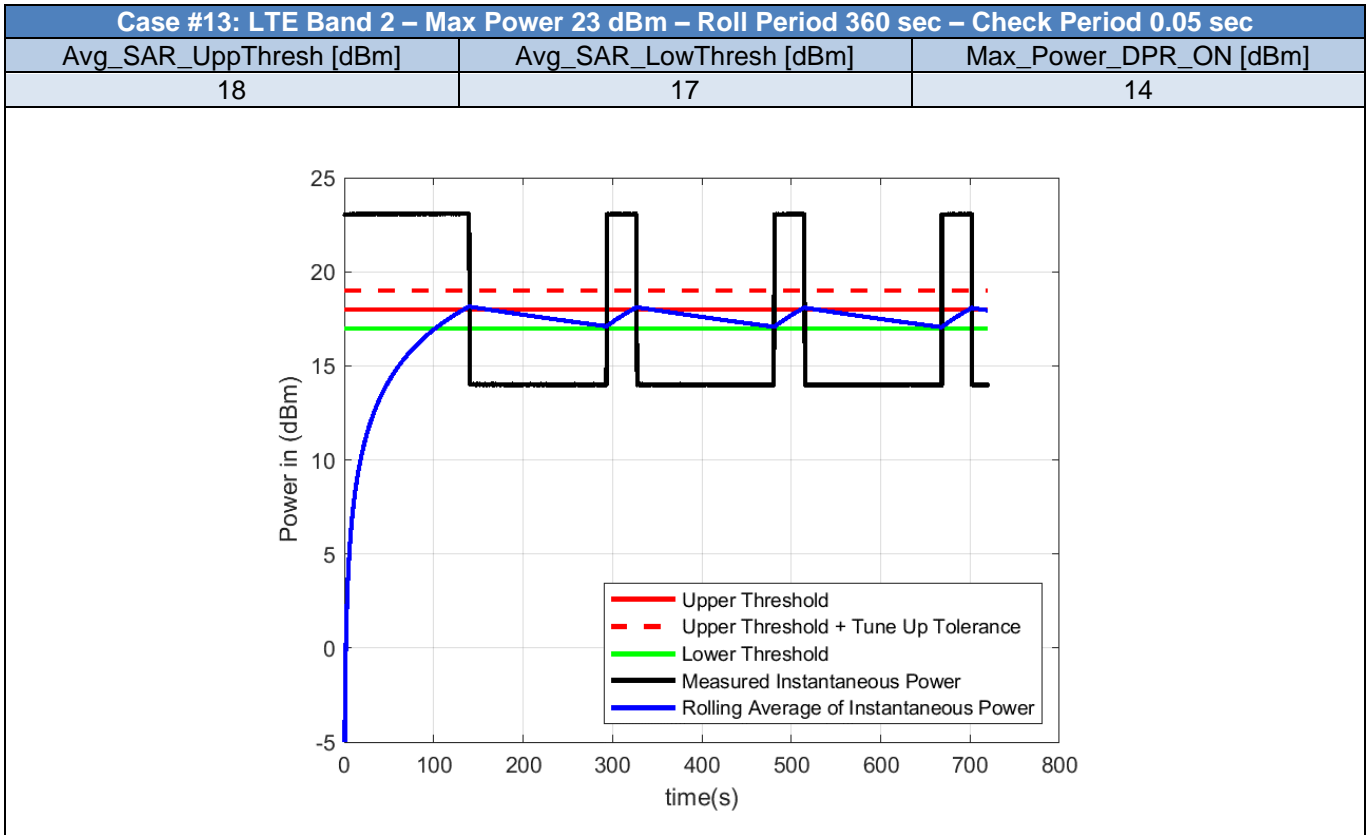

2.4. TAS Parameters Range Compliance - WCDMA

Table 3 - Test Cases for TAS Parameters Range Compliance of WCDMA bands

Case	RAT	Band	Max_Power_DPR_OFF_dBm	Roll_Period_s	Check_Period_s	Avg_SAR_Upper_Threshold_dBm	Avg_SAR_Lower_Threshold_dBm	Max_Power_DPR_ON_dBm
1	WCDMA	2	23.5	100	0.05	22	21	20
2	WCDMA	2	23.5	100	0.05	22	21	18
3	WCDMA	2	23.5	100	0.05	22	19	18
4	WCDMA	2	23.5	100	0.05	22	19	16
5	WCDMA	2	23.5	100	0.05	18	17	16
6	WCDMA	2	23.5	100	0.05	18	17	14
7	WCDMA	2	23.5	100	0.05	18	15	14
8	WCDMA	2	23.5	100	0.05	18	15	12
9	WCDMA	2	23.5	100	0.05	13	12	11
10	WCDMA	2	23.5	100	0.05	13	12	9
11	WCDMA	2	23.5	100	0.05	13	10	9
12	WCDMA	2	23.5	100	0.05	13	10	7
13	WCDMA	2	23.5	360	0.05	18	17	14

Note: The Average power is calculated using the measured instantaneous power and compared to the UpperThreshold Plus Tune-Up Tolerance. This is applied for all the test cases in this report.

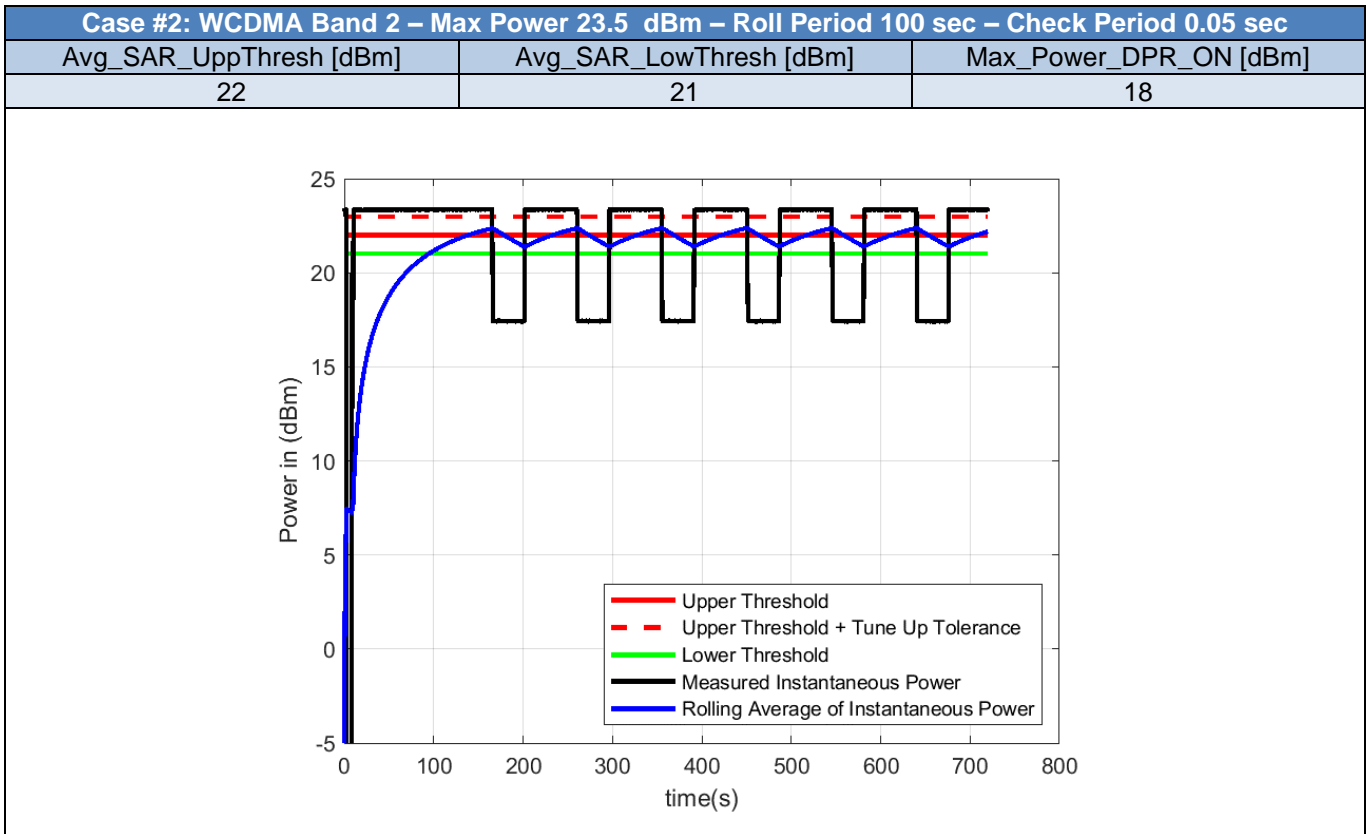
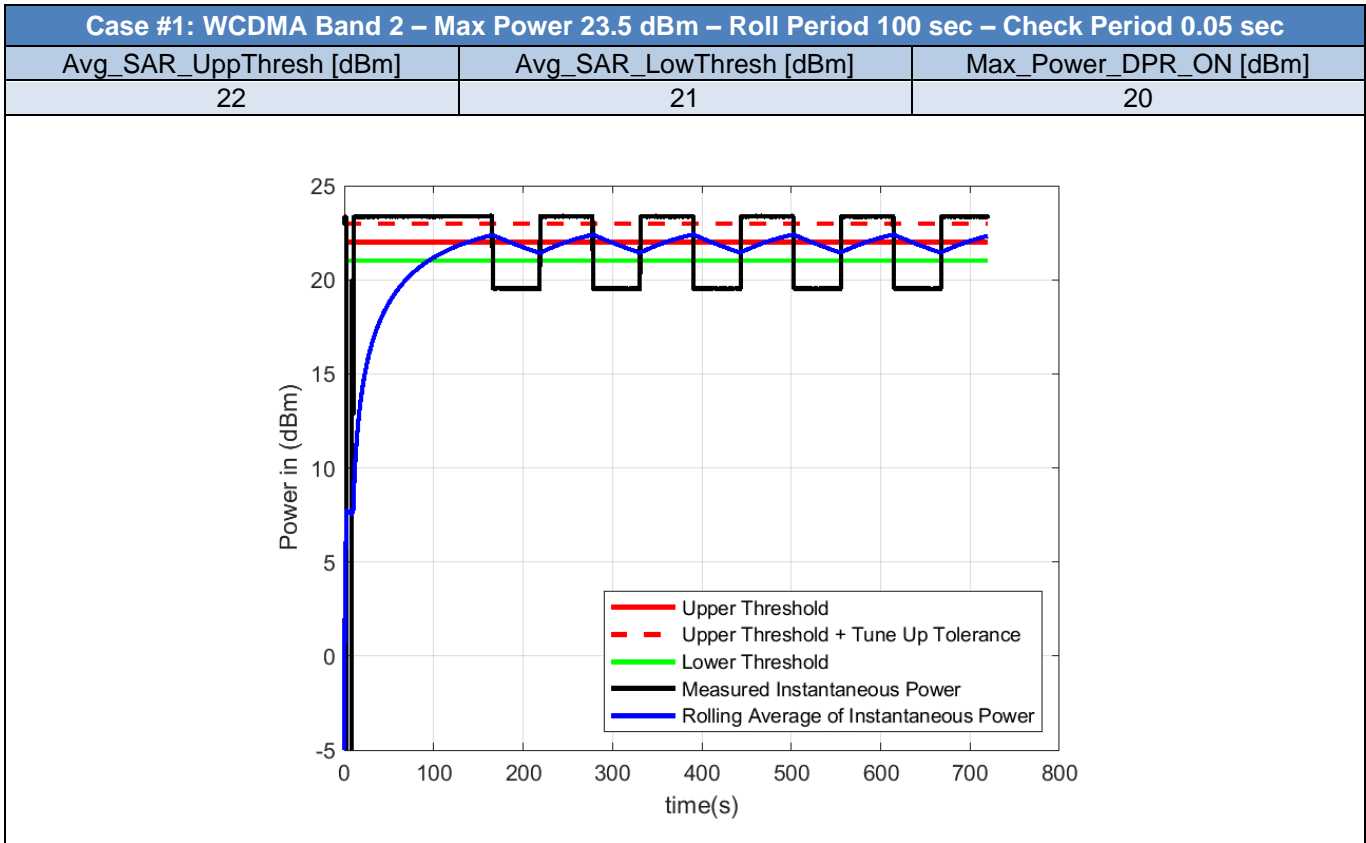

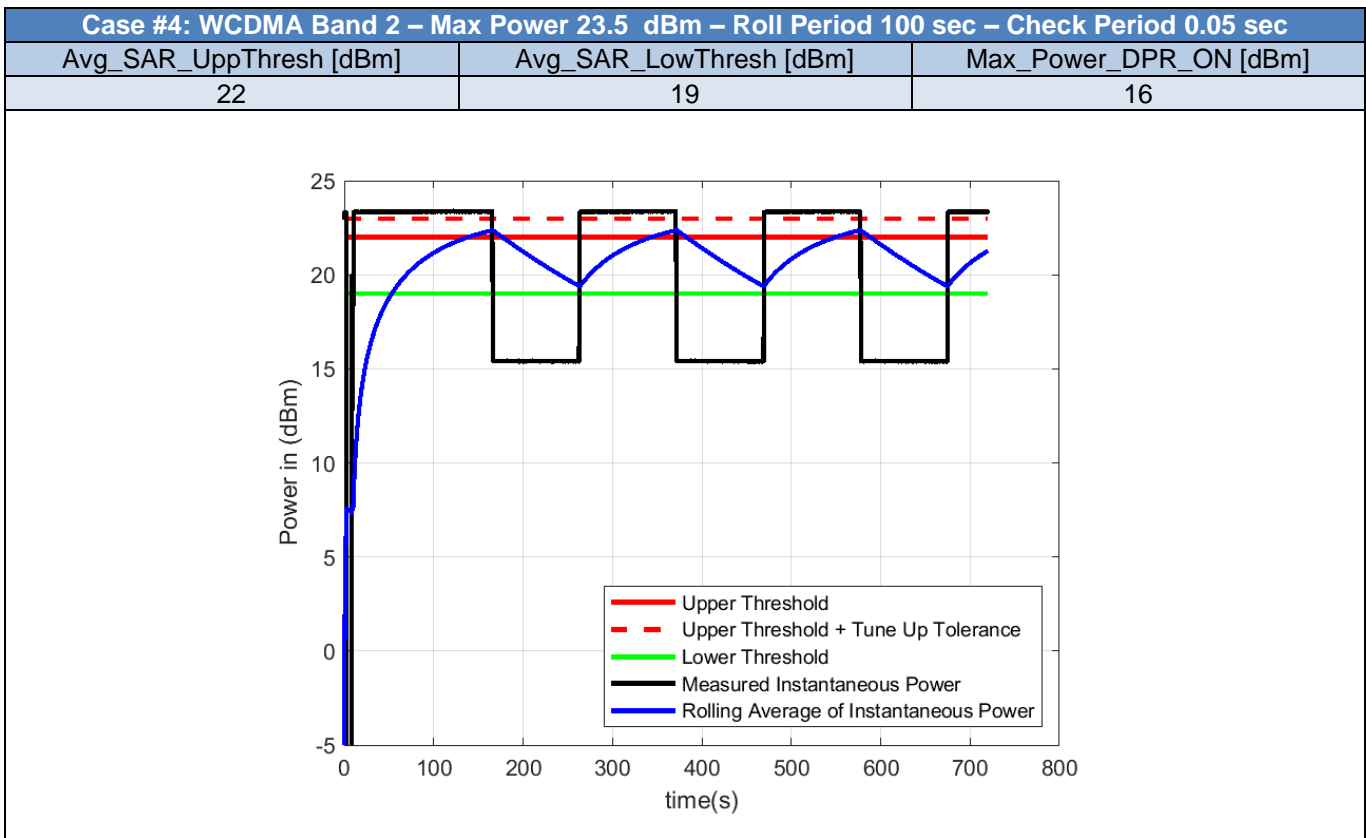
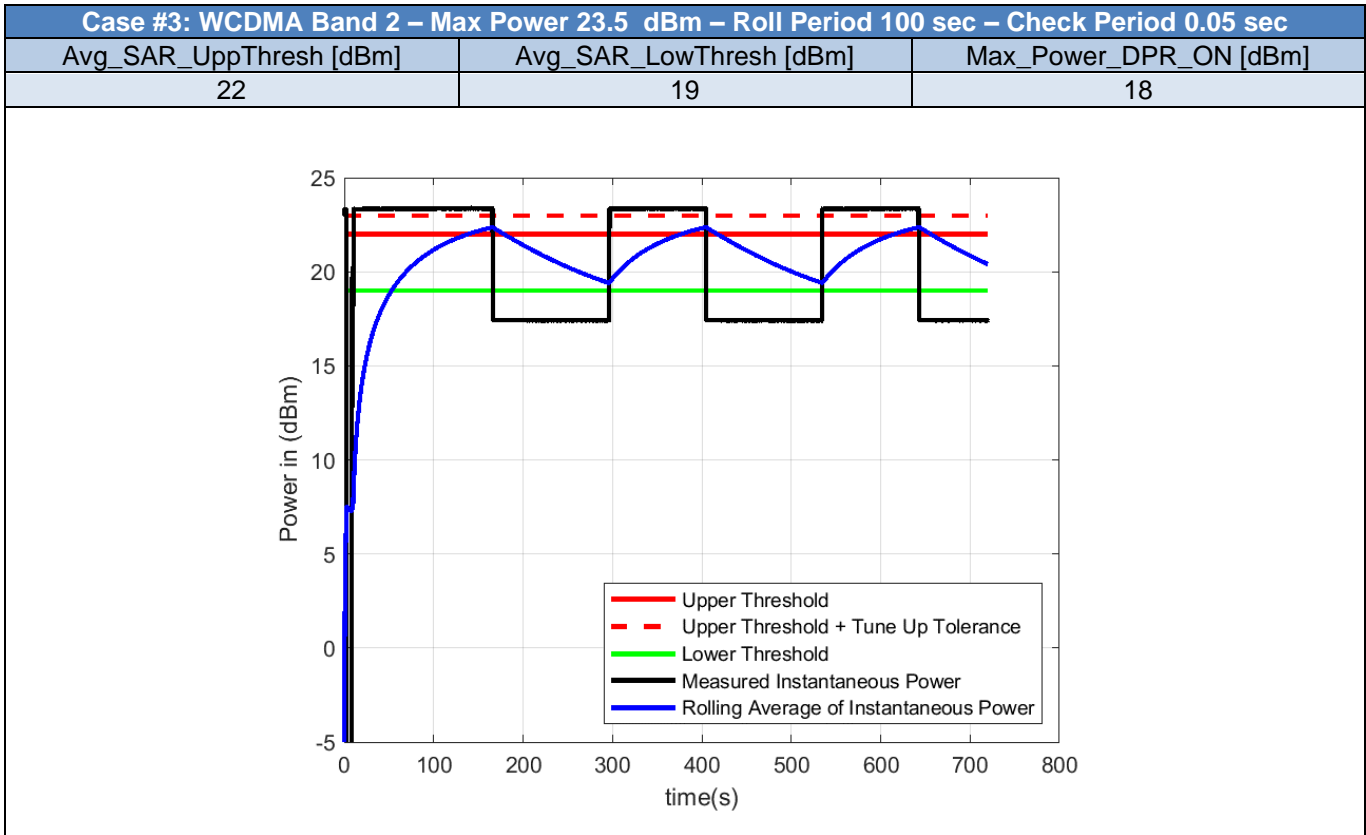

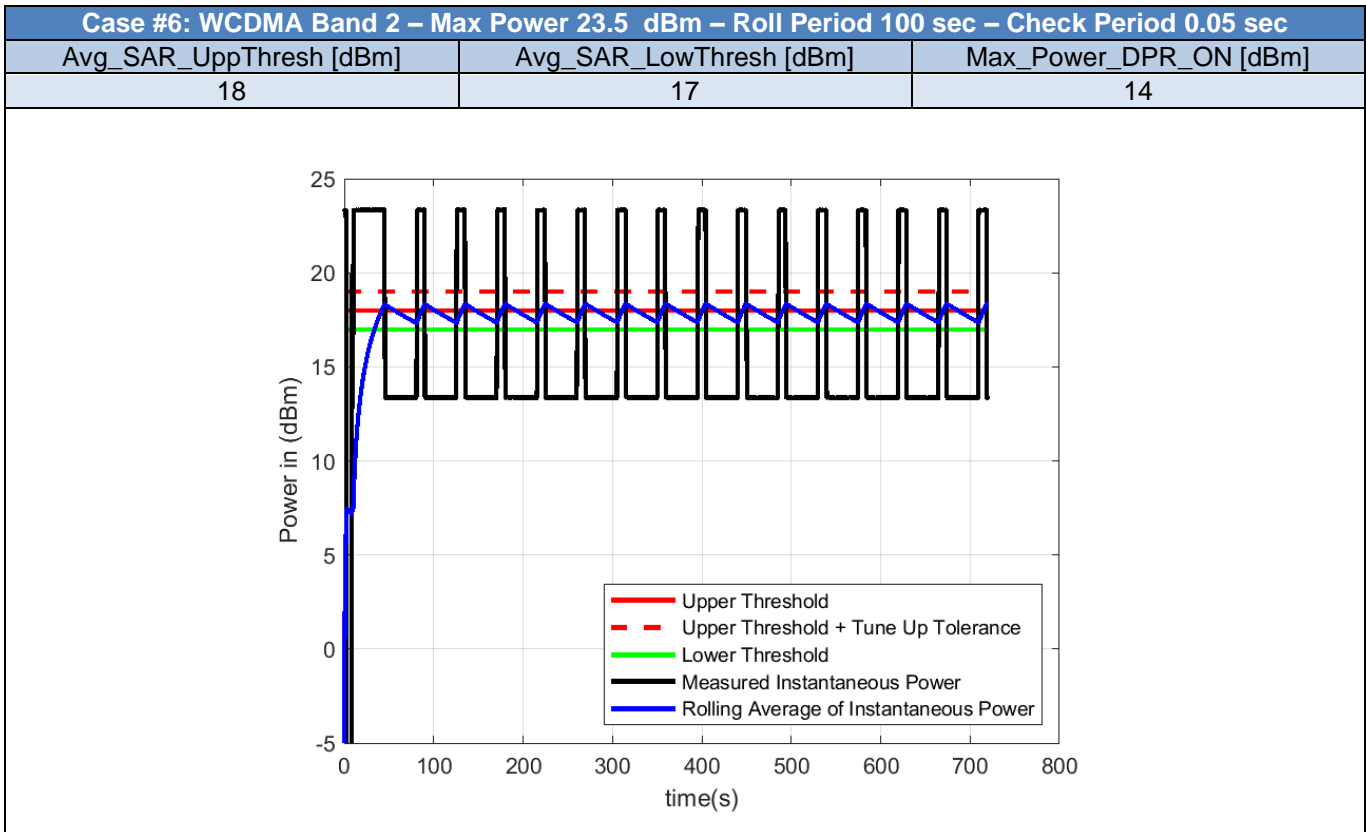
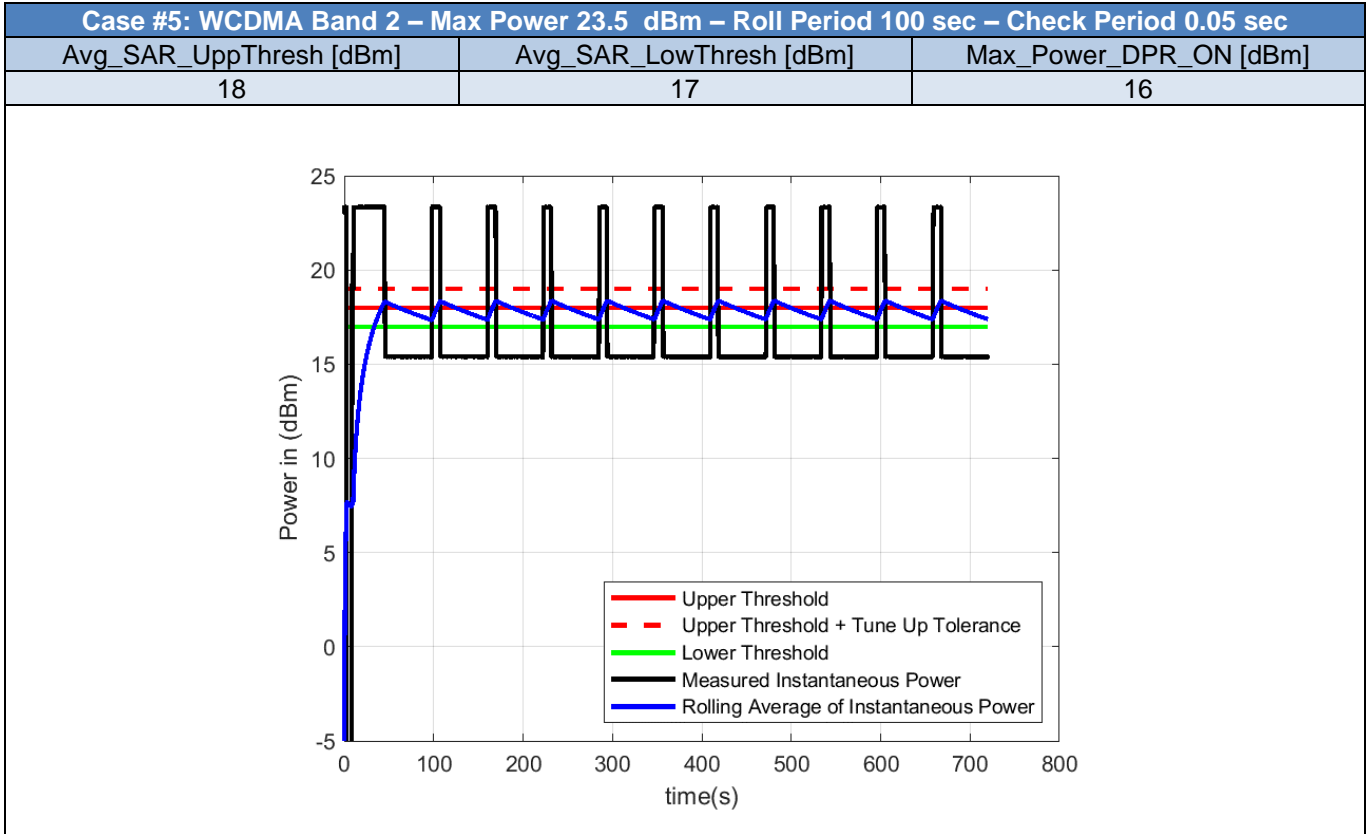

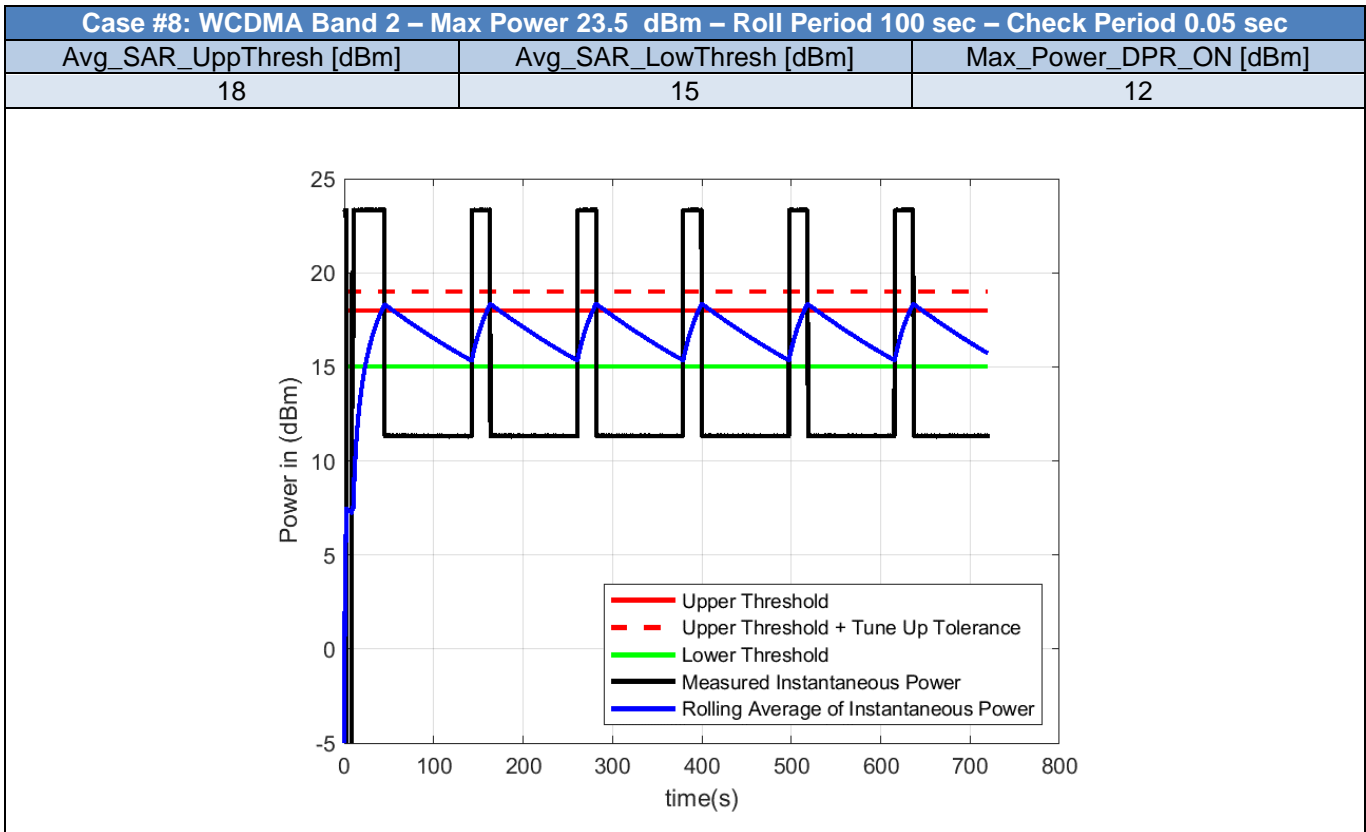
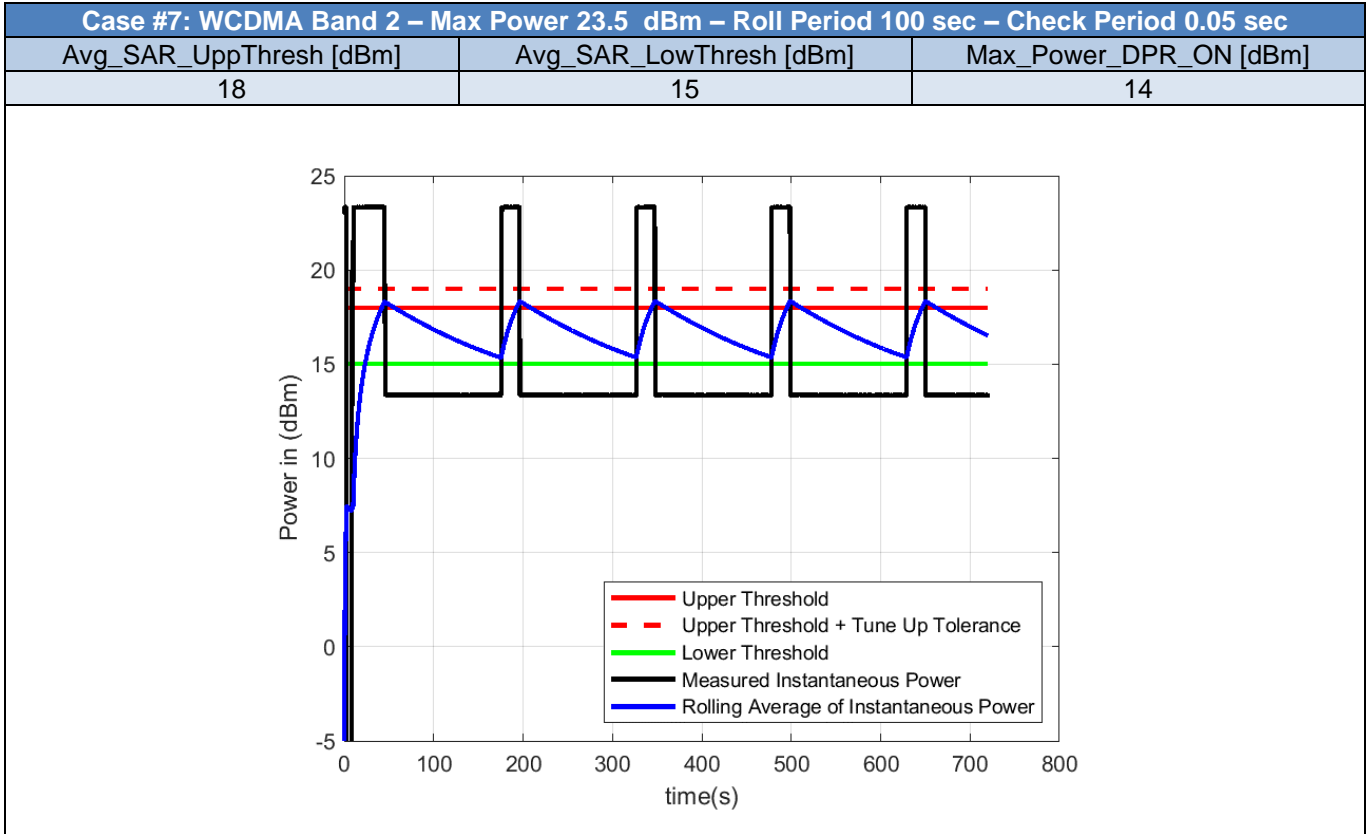

Case #9: WCDMA Band 2 – Max Power 23.5 dBm – Roll Period 100 sec – Check Period 0.05 sec		
Avg_SAR_UppThresh [dBm]	Avg_SAR_LowThresh [dBm]	Max_Power_DPR_ON [dBm]
13	12	11

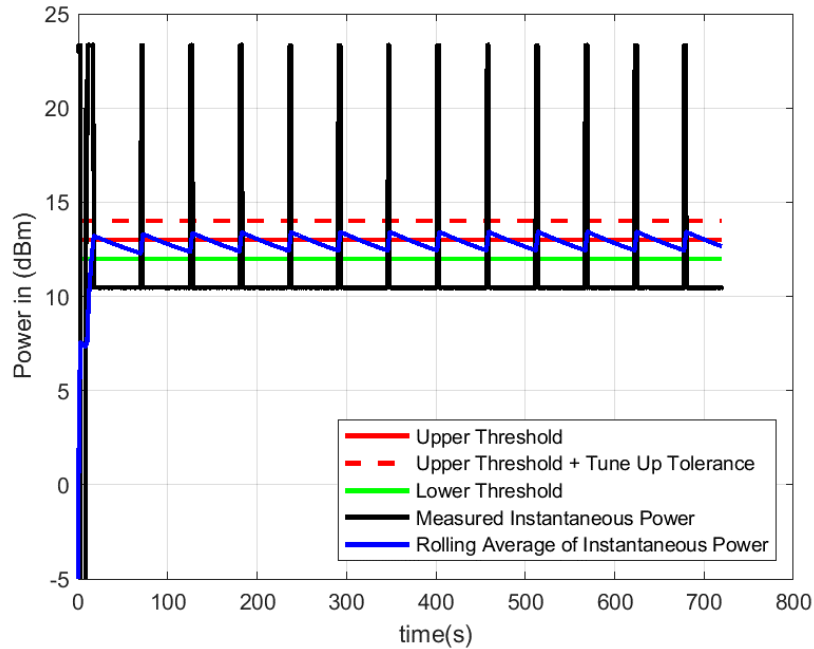

Case #10: WCDMA Band 2 – Max Power 23.5 dBm – Roll Period 100 sec – Check Period 0.05 sec		
Avg_SAR_UppThresh [dBm]	Avg_SAR_LowThresh [dBm]	Max_Power_DPR_ON [dBm]
13	12	9

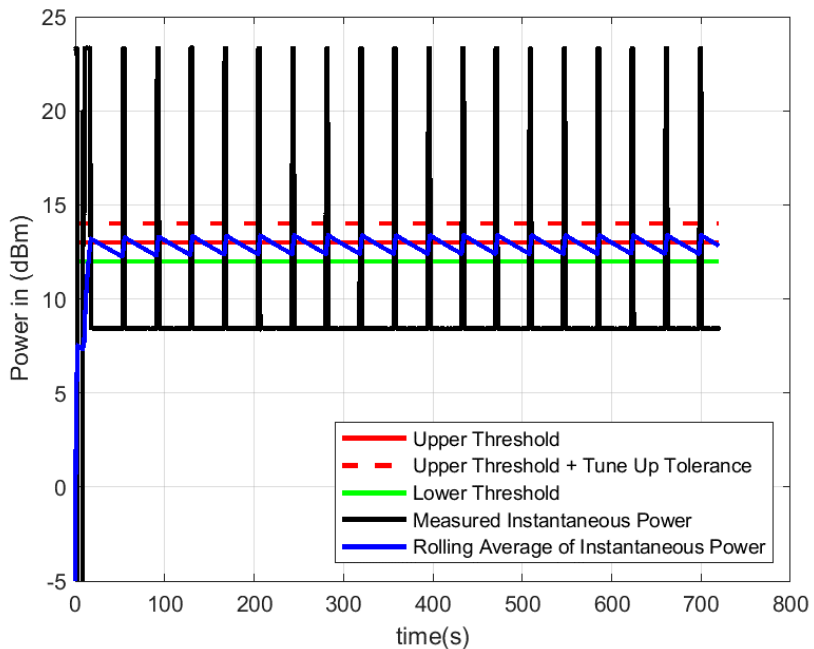

Case #11: WCDMA Band 2 – Max Power 23.5 dBm – Roll Period 100 sec – Check Period 0.05 sec		
Avg_SAR_UppThresh [dBm]	Avg_SAR_LowThresh [dBm]	Max_Power_DPR_ON [dBm]
13	10	9

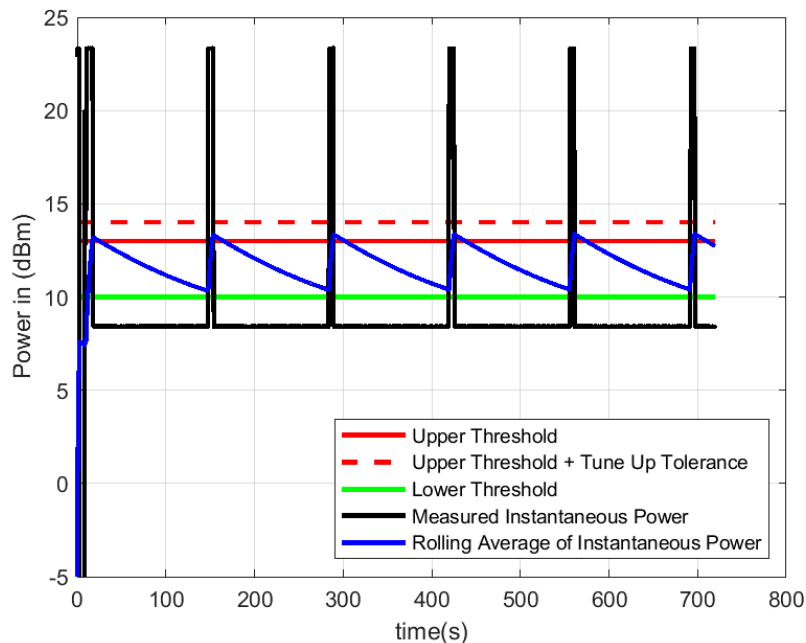

Case #12: WCDMA Band 2 – Max Power 23.5 dBm – Roll Period 100 sec – Check Period 0.05 sec		
Avg_SAR_UppThresh [dBm]	Avg_SAR_LowThresh [dBm]	Max_Power_DPR_ON [dBm]
13	10	7

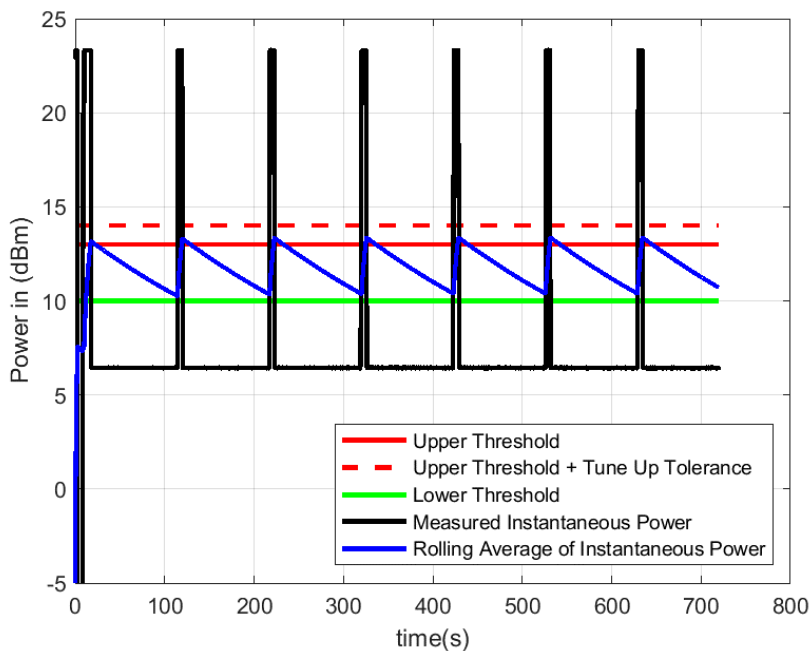

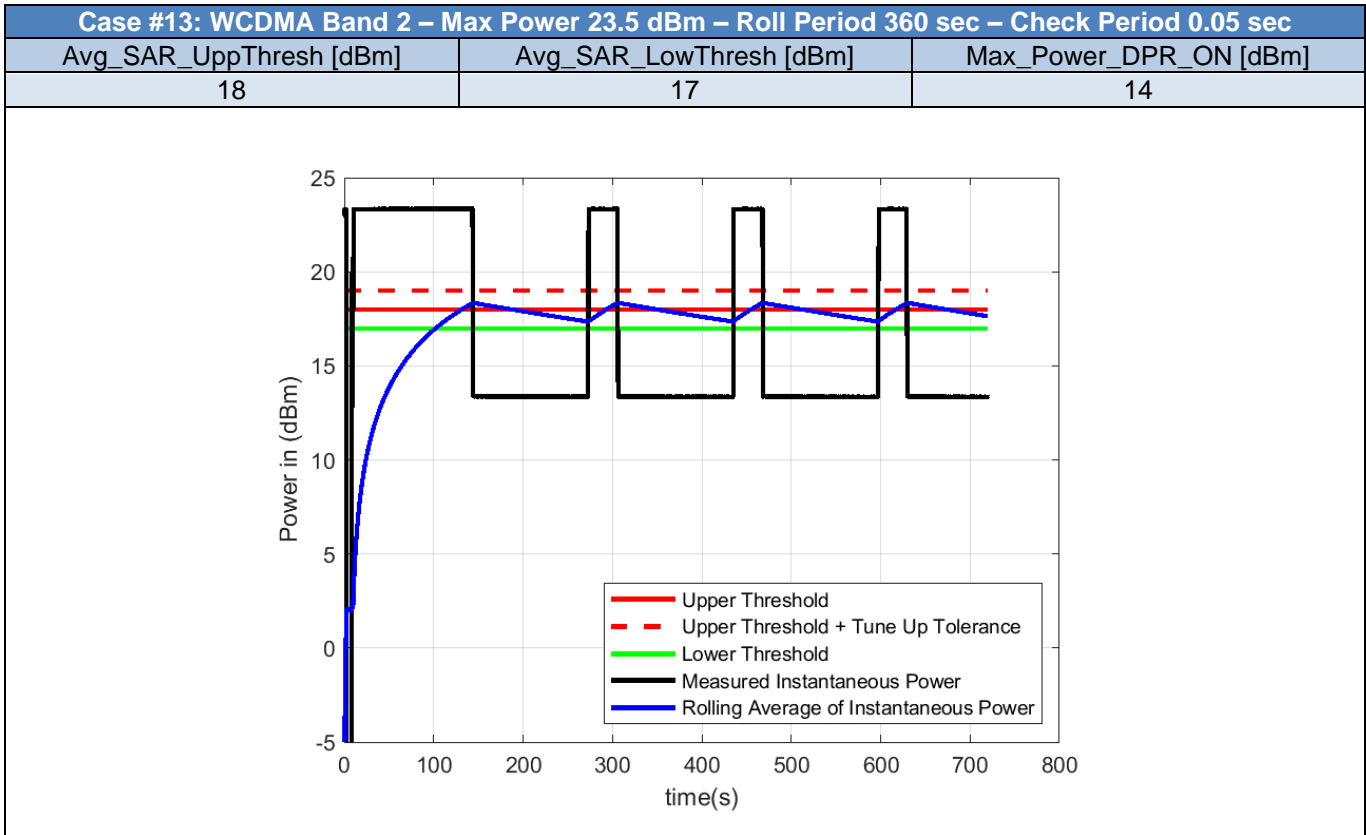

2.5. Bands Validation - NR

Table 4 - Test Cases for Bands Compliance of NR bands

Case	RAT	Band	Max_Power_DPR_OFF_dBm	Roll_Period_s	Check_Period_s	Avg_SAR_Upper_Threshold_dBm	Avg_SAR_Lower_Threshold_dBm	Max_Power_DPR_ON_dBm
1	NR	1	23	100	0.05	20	19	18
2	NR	2	23	100	0.05	20	19	18
3	NR	3	23	100	0.05	20	19	18
4	NR	5	23	100	0.05	20	19	18
5	NR	7	23	100	0.05	20	19	18
6	NR	8	23	100	0.05	20	19	18
7	NR	20	23	100	0.05	20	19	18
8	NR	25	23	100	0.05	20	19	18
9	NR	28	23	100	0.05	20	19	18
10	NR	30	22	100	0.05	20	19	18
11	NR	38	23	100	0.05	16	15	14
12	NR	40	23	100	0.05	16	15	14
13	NR	41	26	100	0.05	16	15	14
14	NR	66	23	100	0.05	20	19	18
15	NR	77	25	100	0.05	16	15	14
16	NR	78	26	100	0.05	16	15	14

Note: The Average power is calculated using the measured instantaneous power and compared to the UpperThreshold Plus Tune-Up Tolerance. This is applied for all the test cases in this report.

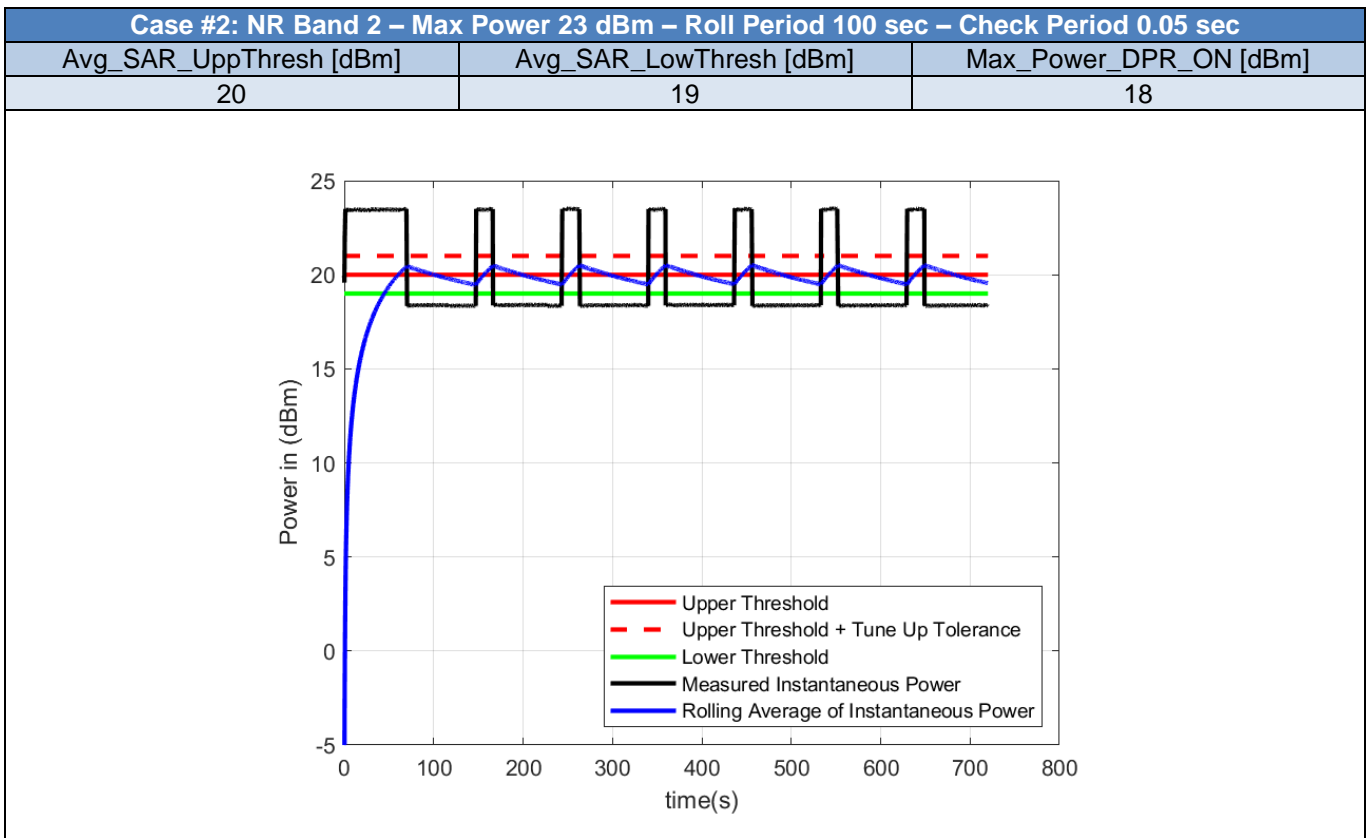
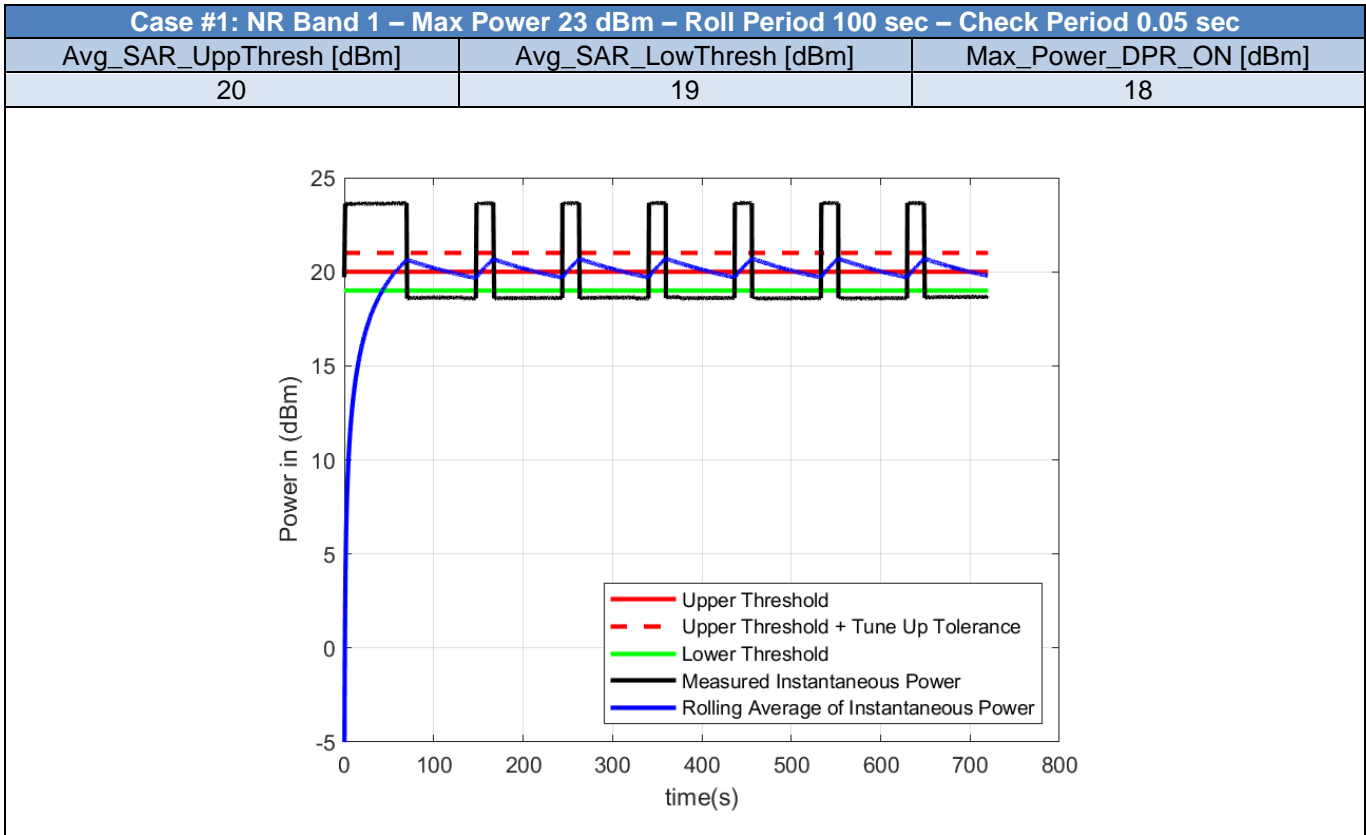

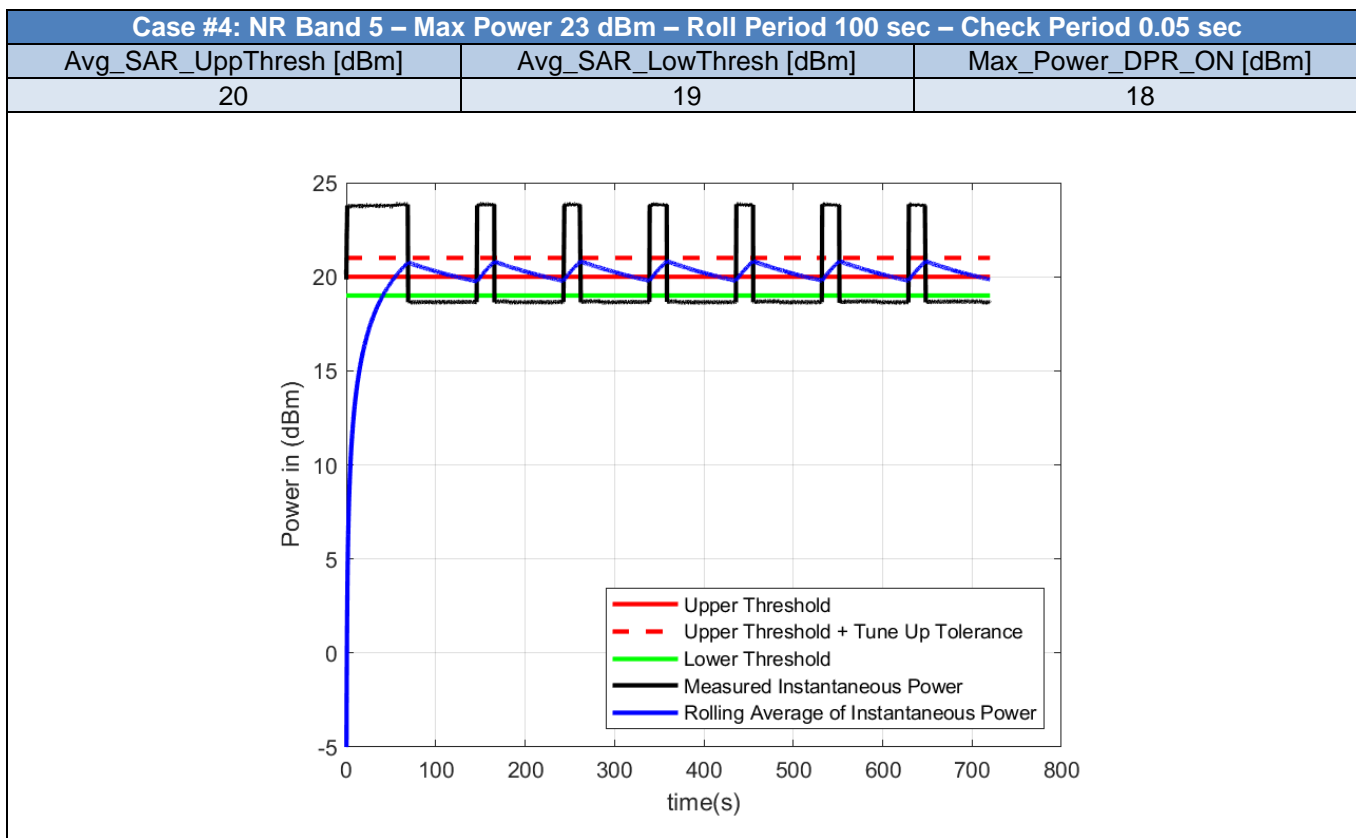
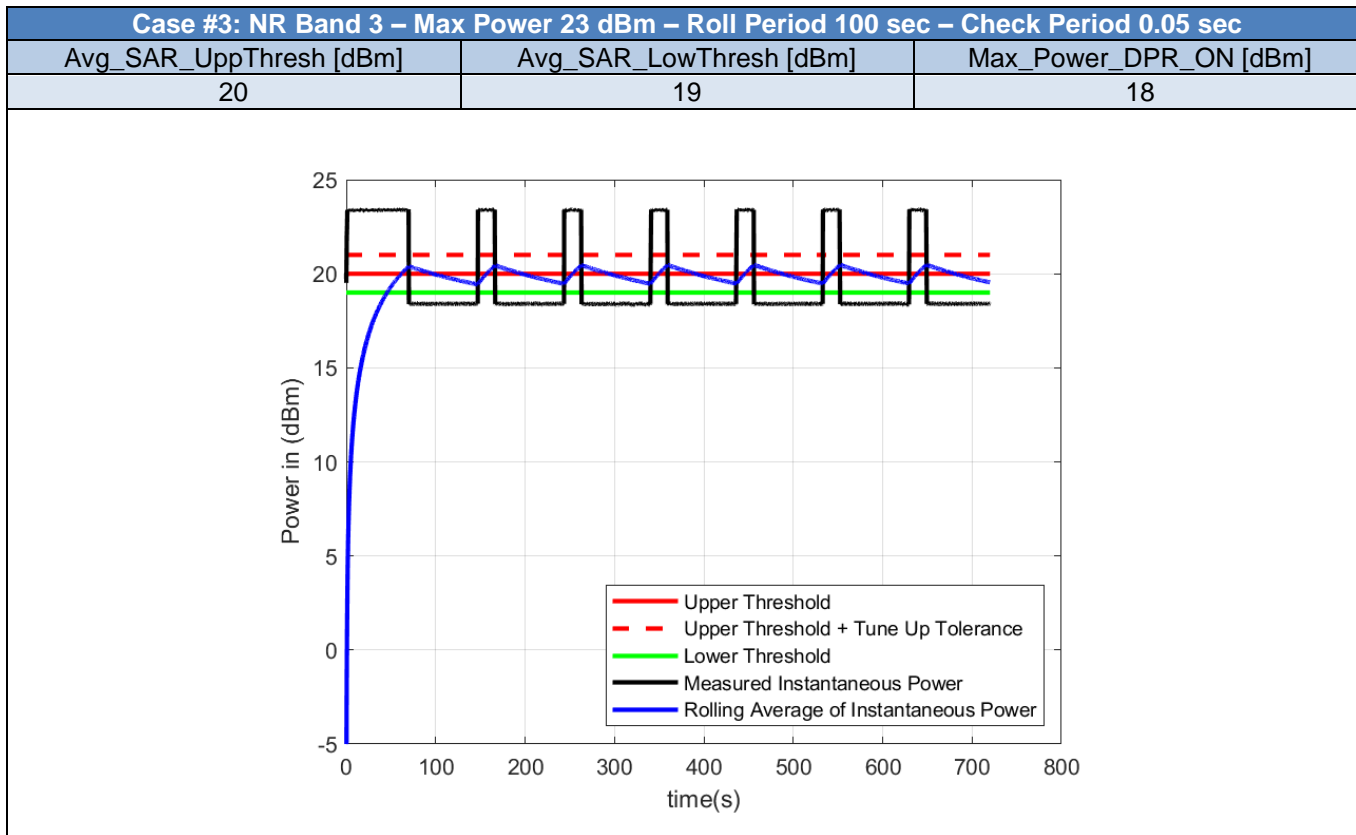

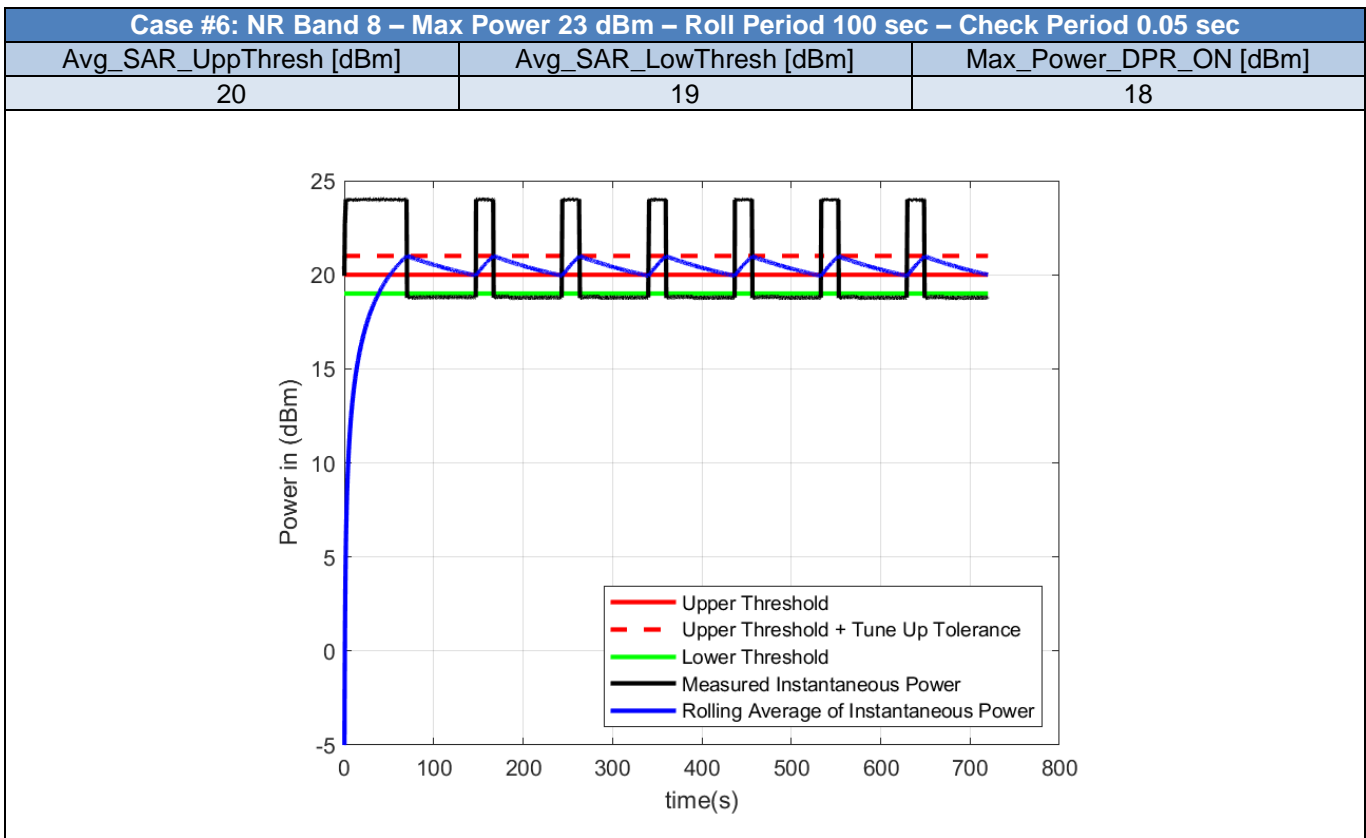
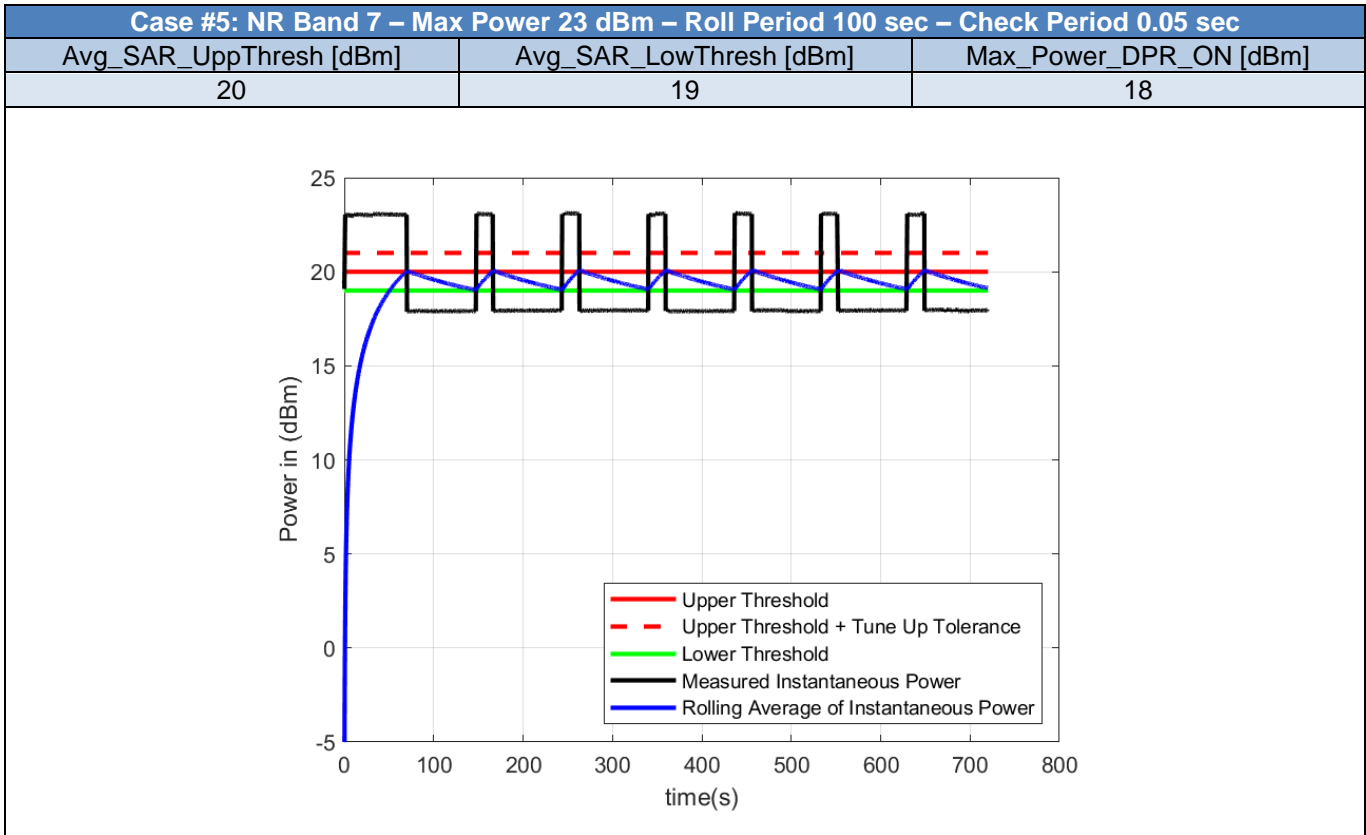

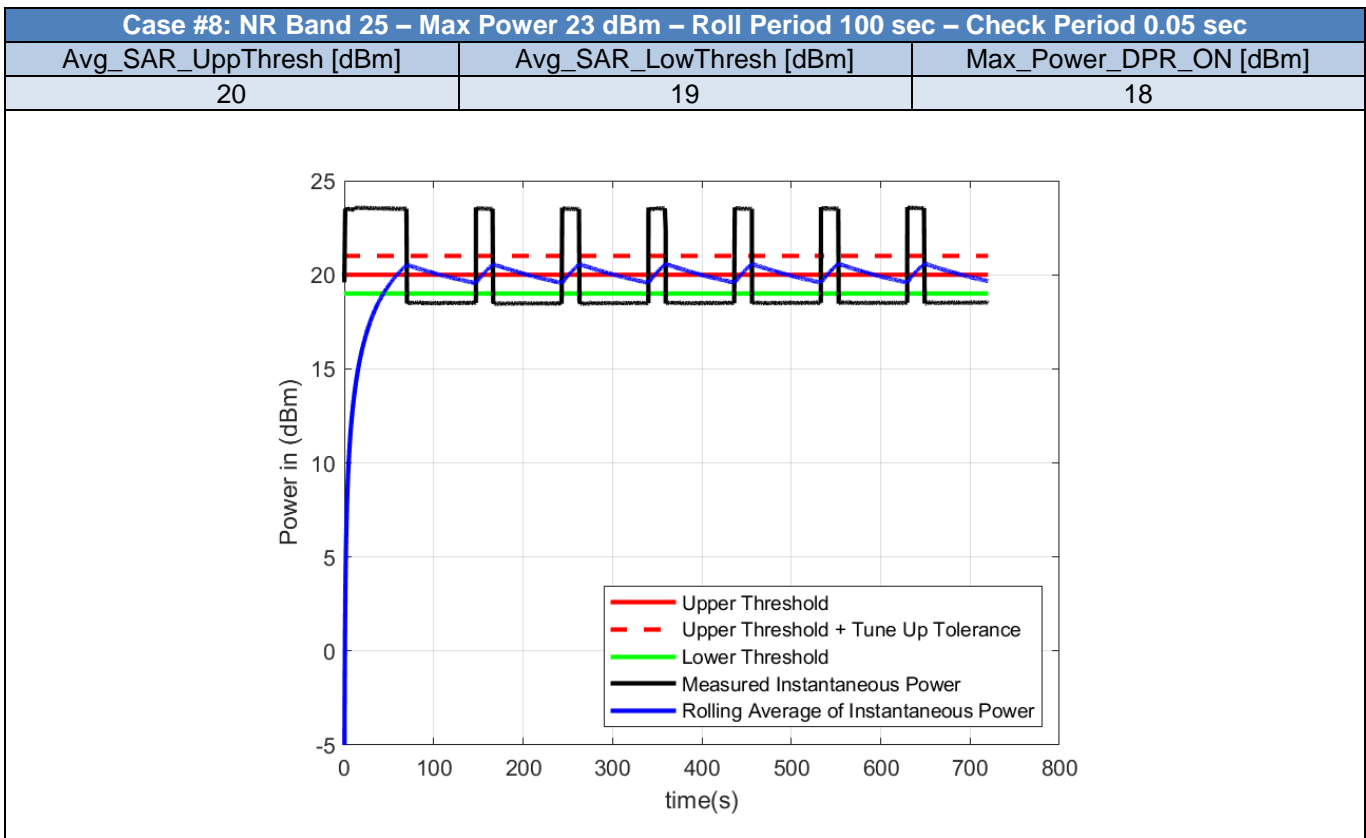
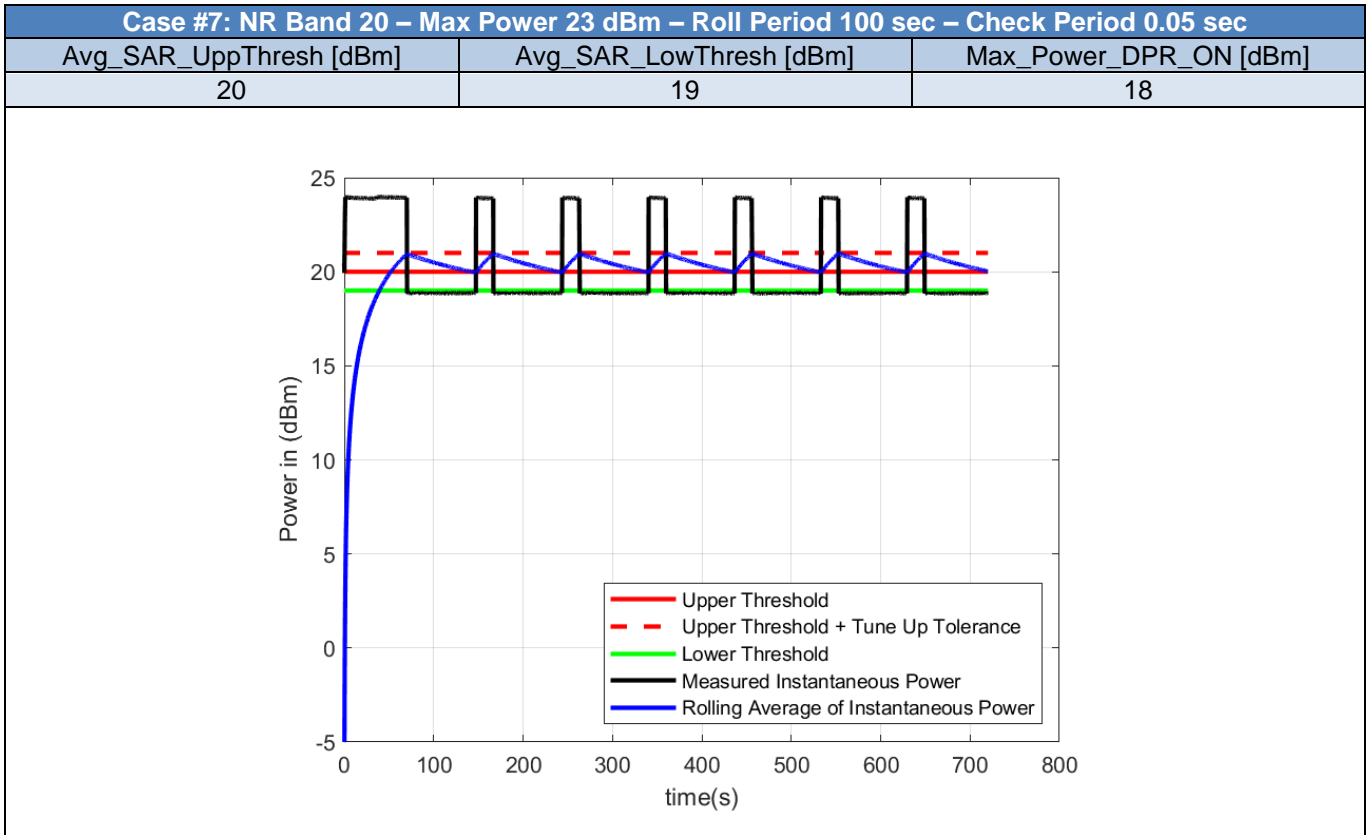

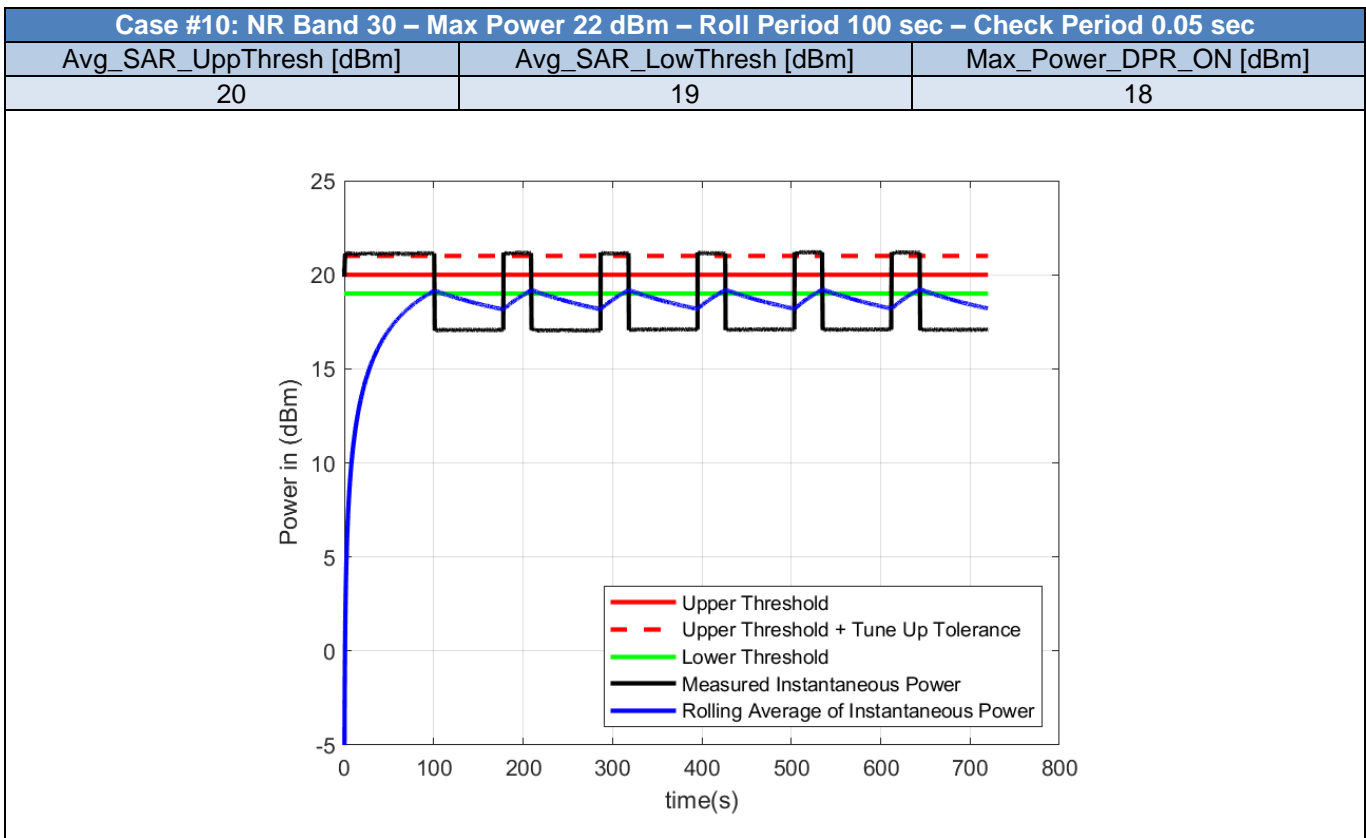
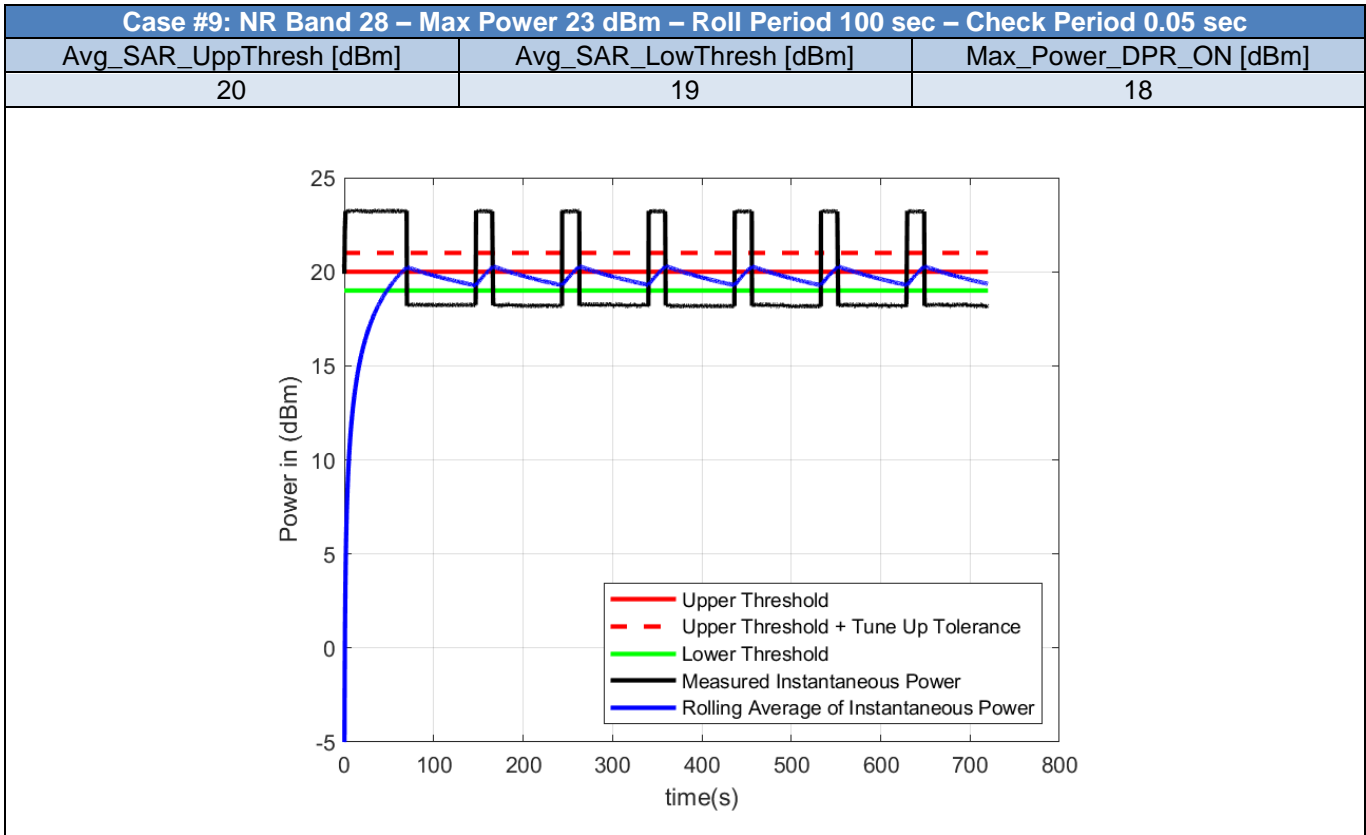

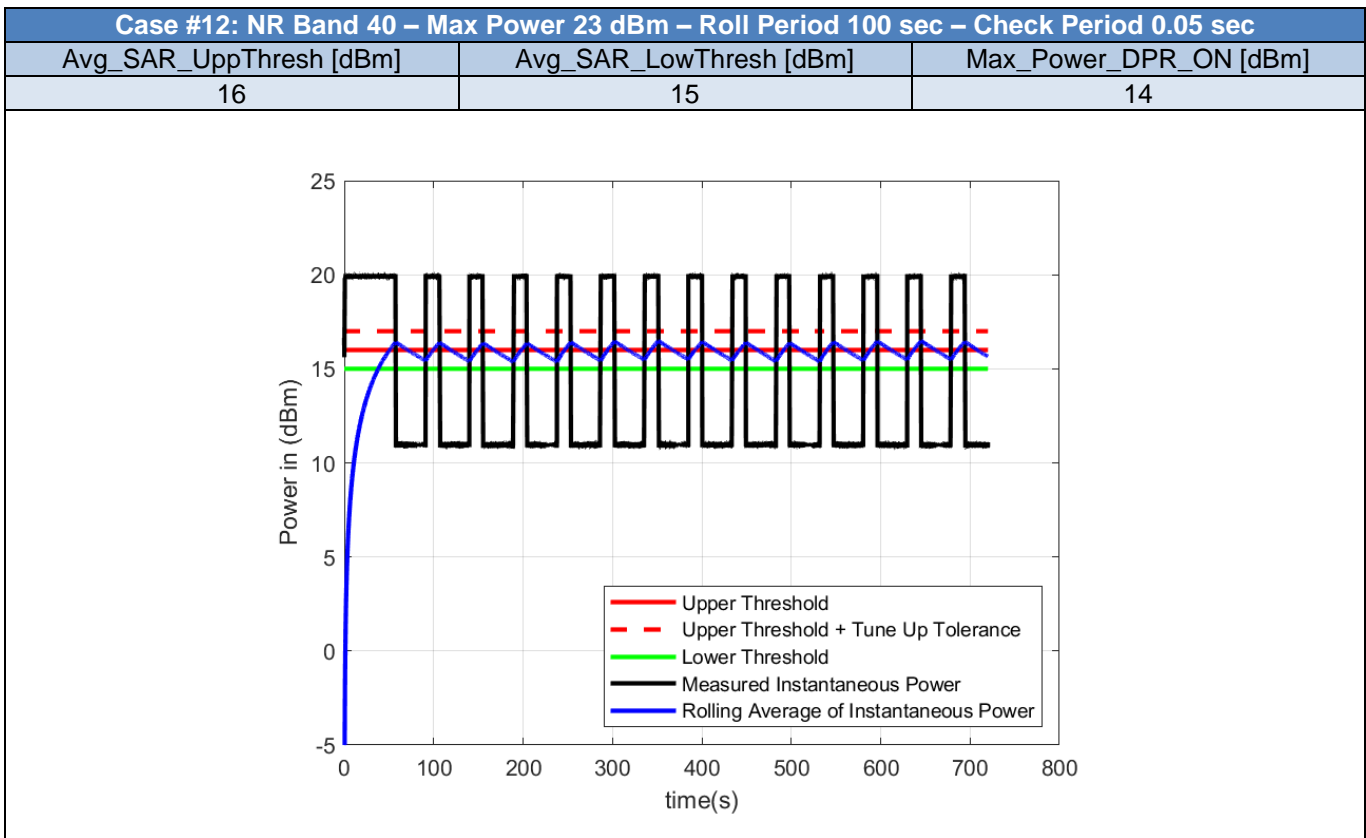
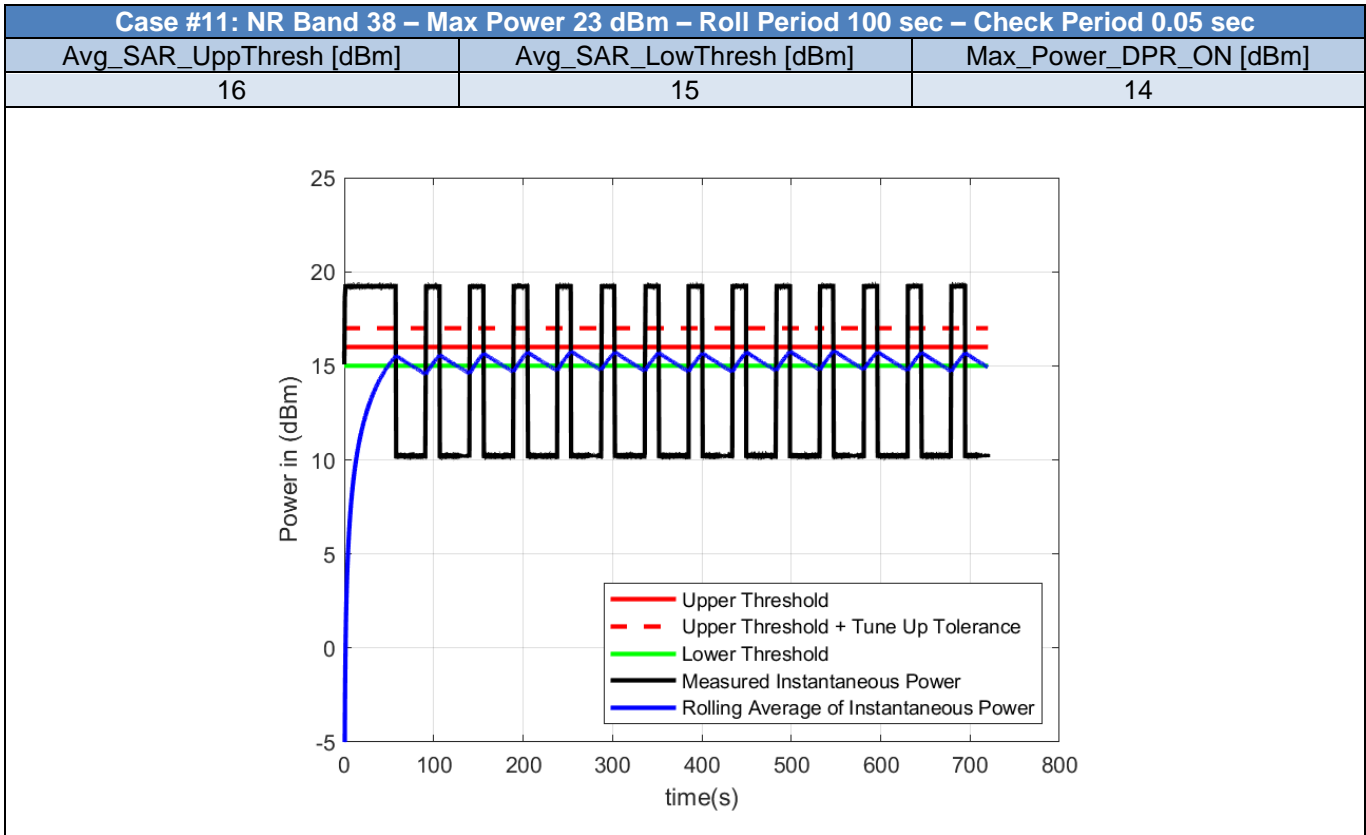

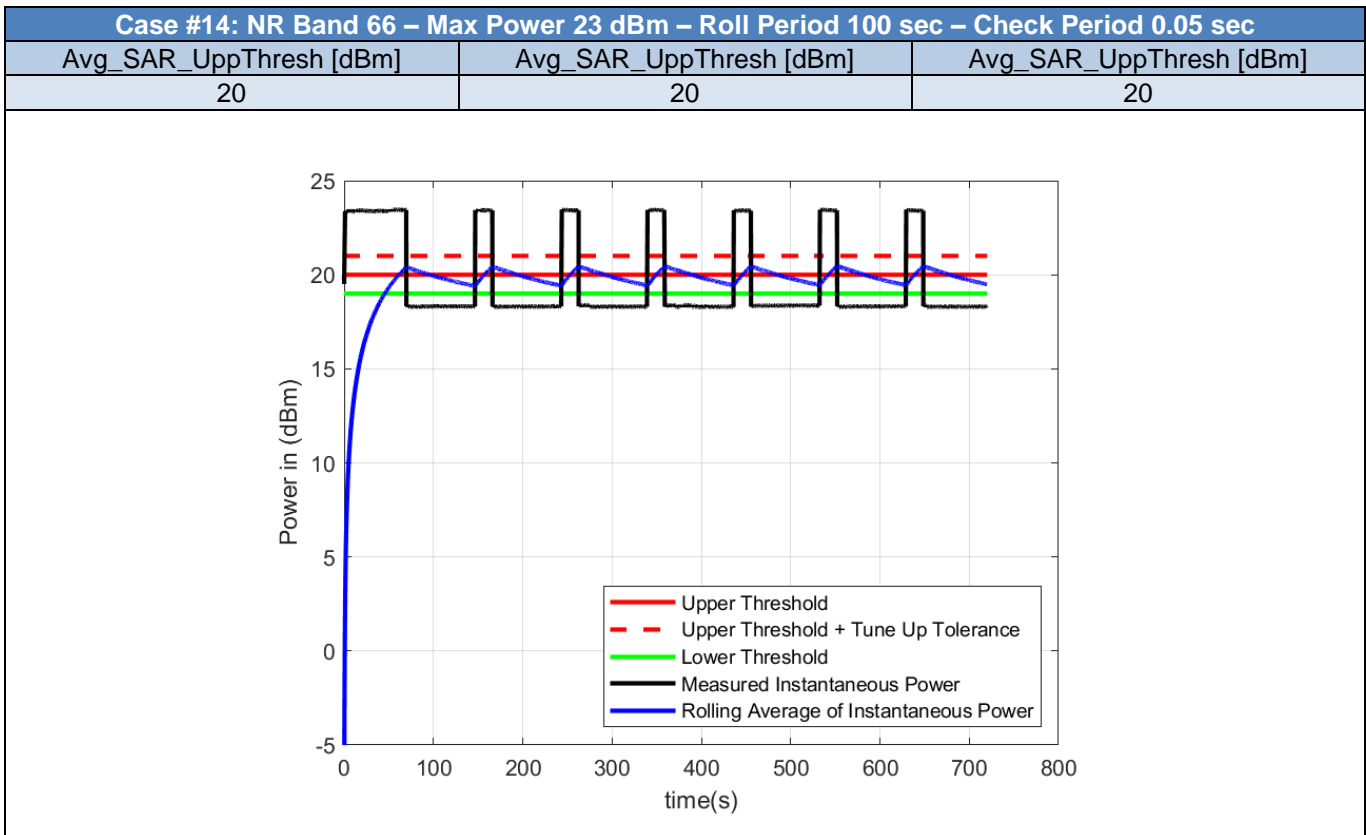
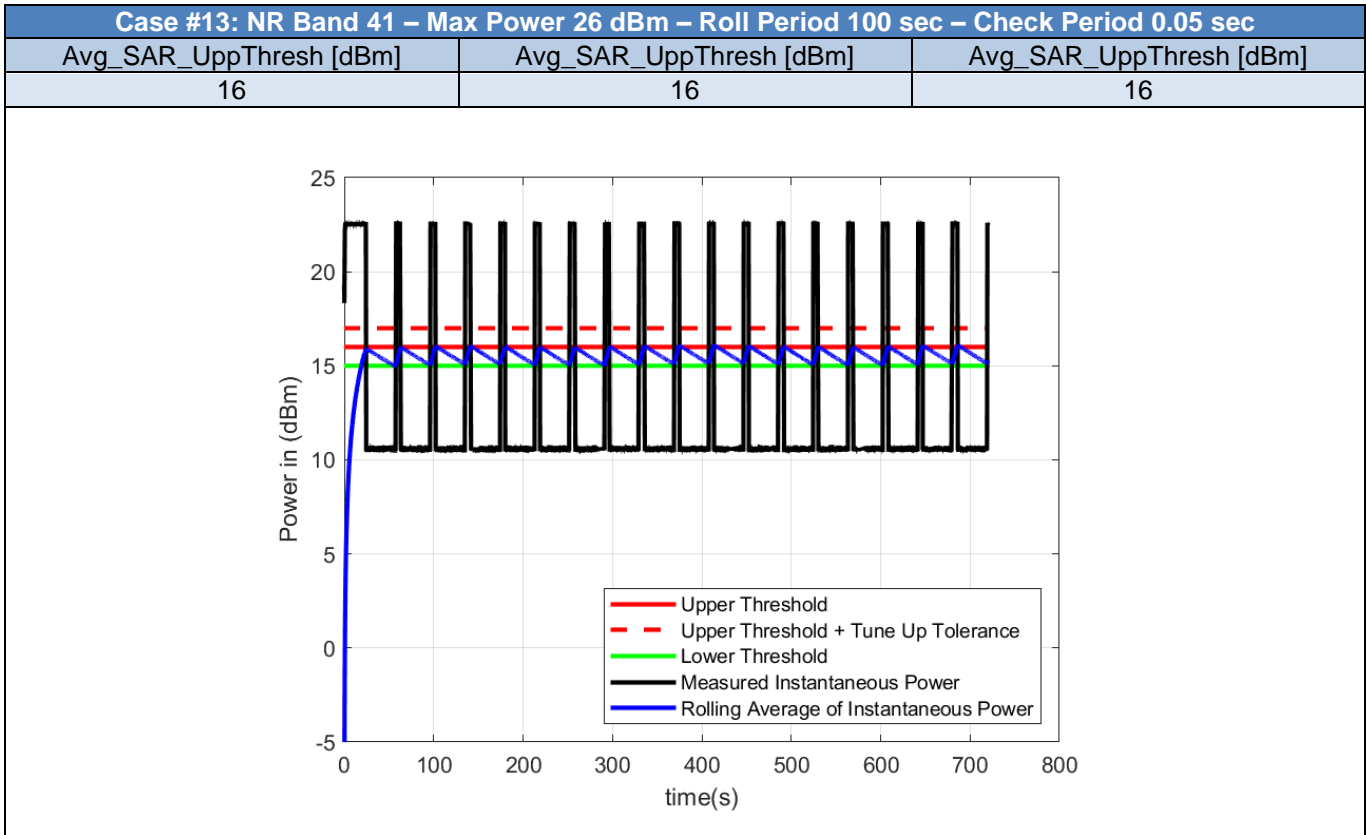

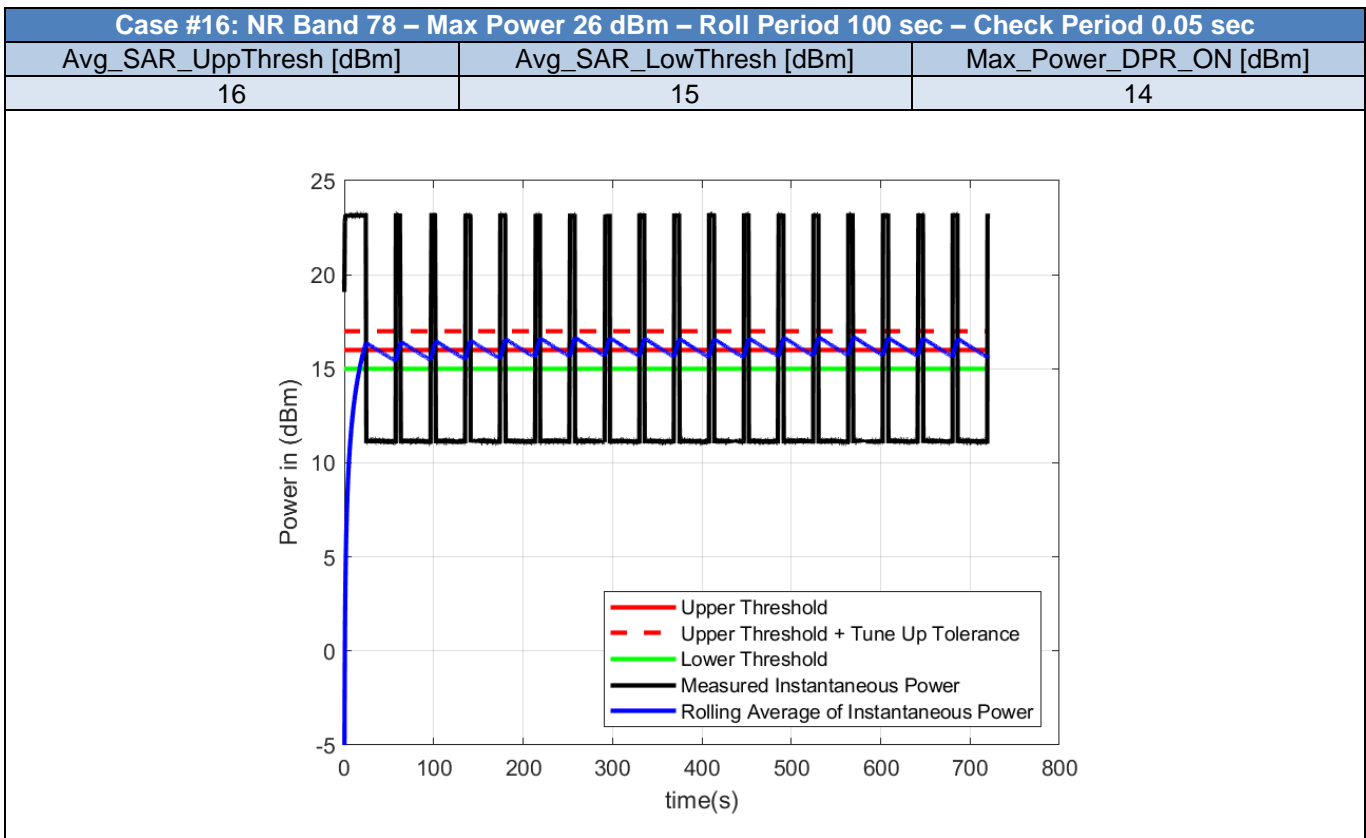
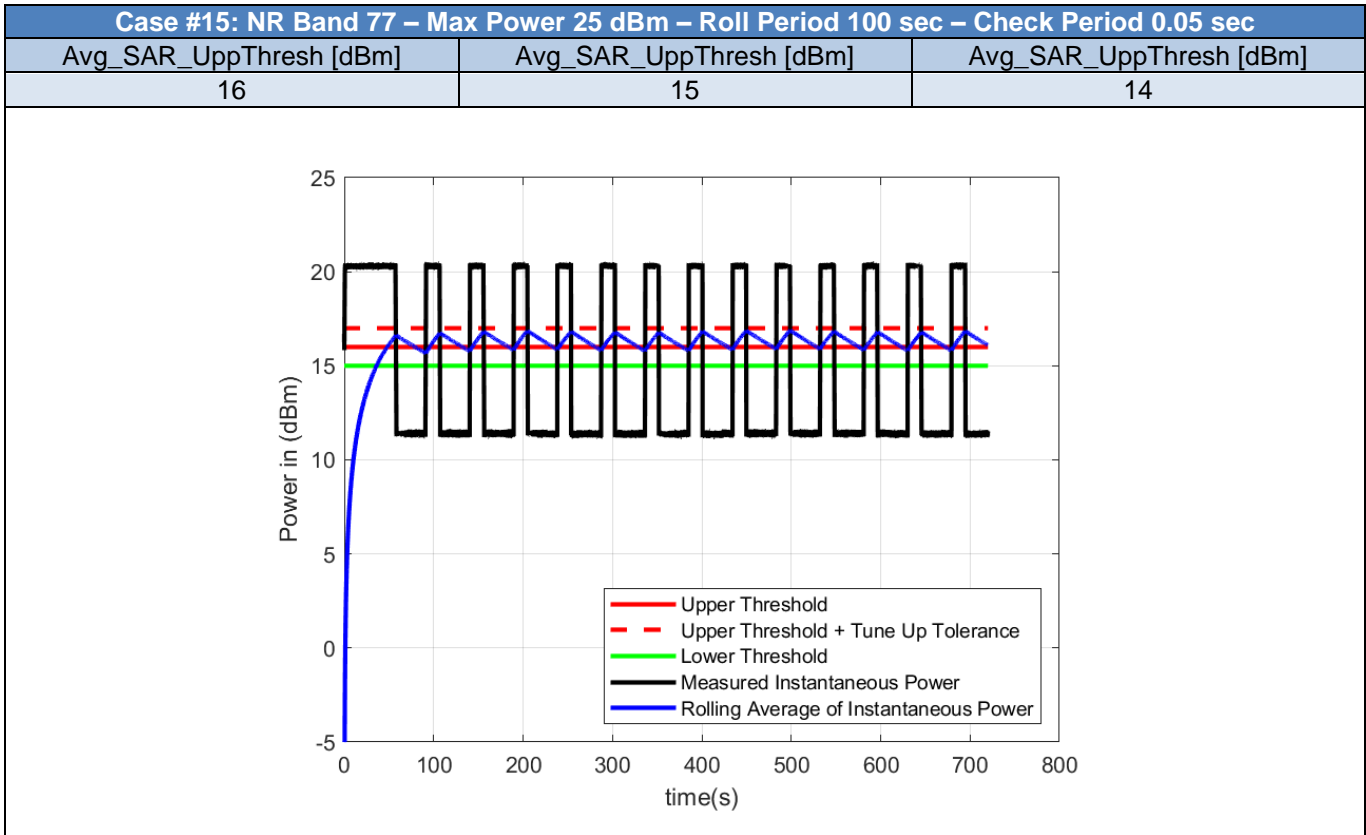

2.6. Bands Validation - LTE

Table 5 - Test Cases for Bands Compliance of LTE bands

Case	RAT	Band	Max_Power_DPR_OFF_dBm	Roll_Period_s	Check_Period_s	Avg_SAR_UpThresh_dBm	Avg_SAR_LoThresh_dBm	Max_Power_DPR_ON_dBm
1	LTE	1	23	100	0.05	20	19	18
2	LTE	2	23	100	0.05	20	19	18
3	LTE	3	23	100	0.05	20	19	18
4	LTE	4	23	100	0.05	20	19	18
5	LTE	5	23	100	0.05	20	19	18
6	LTE	7	23	100	0.05	20	19	18
7	LTE	8	23	100	0.05	20	19	18
8	LTE	12	23	100	0.05	20	19	18
9	LTE	13	23	100	0.05	20	19	18
10	LTE	14	23	100	0.05	20	19	18
11	LTE	17	23	100	0.05	20	19	18
12	LTE	18	23	100	0.05	20	19	18
13	LTE	19	23	100	0.05	20	19	18
14	LTE	20	23	100	0.05	20	19	18
15	LTE	25	23	100	0.05	20	19	18
16	LTE	26	23	100	0.05	20	19	18
17	LTE	28	23	100	0.05	20	19	18
18	LTE	30	23	100	0.05	20	19	18
19	LTE	34	23	100	0.05	20	19	18
20	LTE	38	23	100	0.05	16	15	14
21	LTE	39	23	100	0.05	16	15	14
22	LTE	40	23	100	0.05	16	15	14
23	LTE	41	23	100	0.05	16	15	14
24	LTE	42	23	100	0.05	16	15	14
25	LTE	43	23	100	0.05	16	15	14
26	LTE	48	23	100	0.05	16	15	14
27	LTE	66	23	100	0.05	20	19	18
28	LTE	71	23	100	0.05	20	19	18

Note: The Average power is calculated using the measured instantaneous power and compared to the UpperThreshold Plus Tune-Up Tolerance. This is applied for all the test cases in this report.

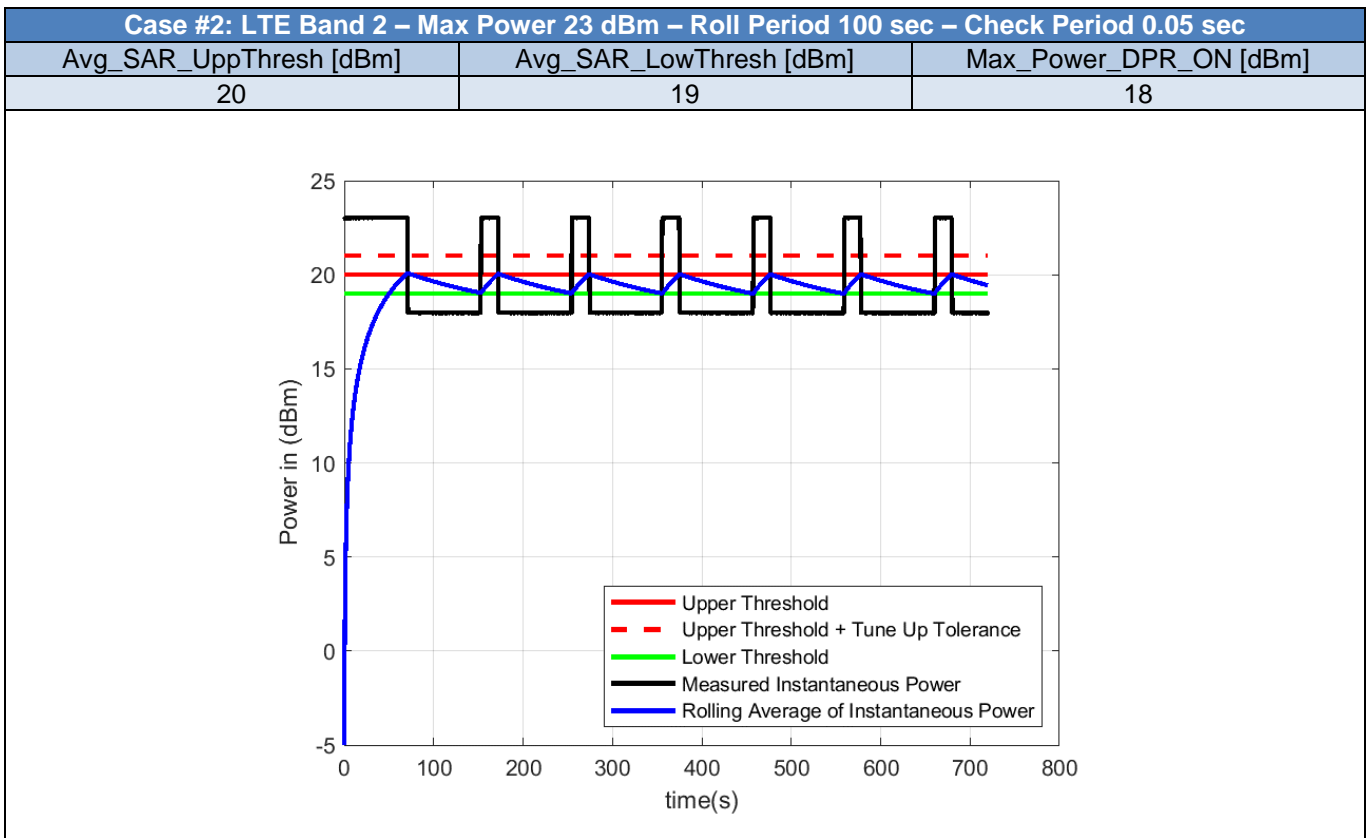
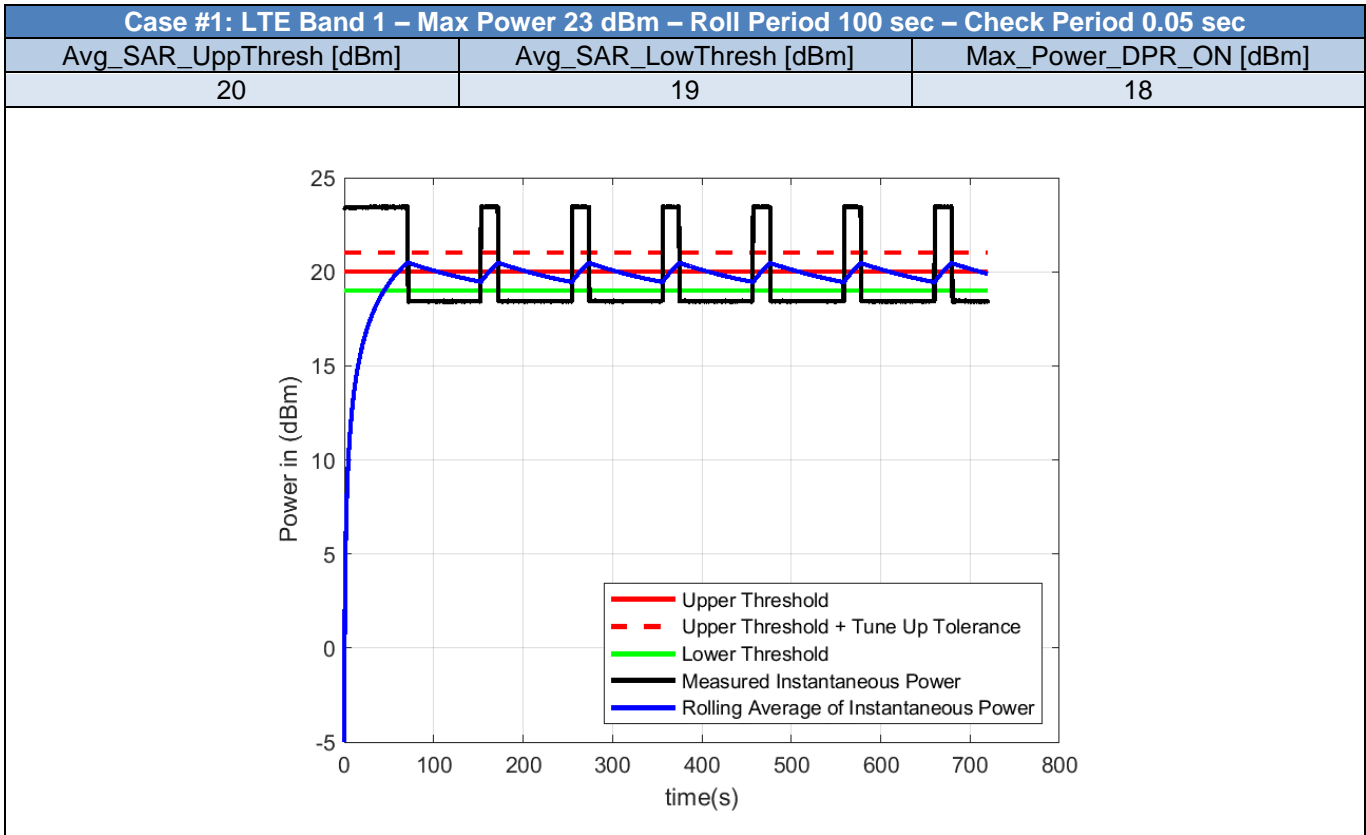

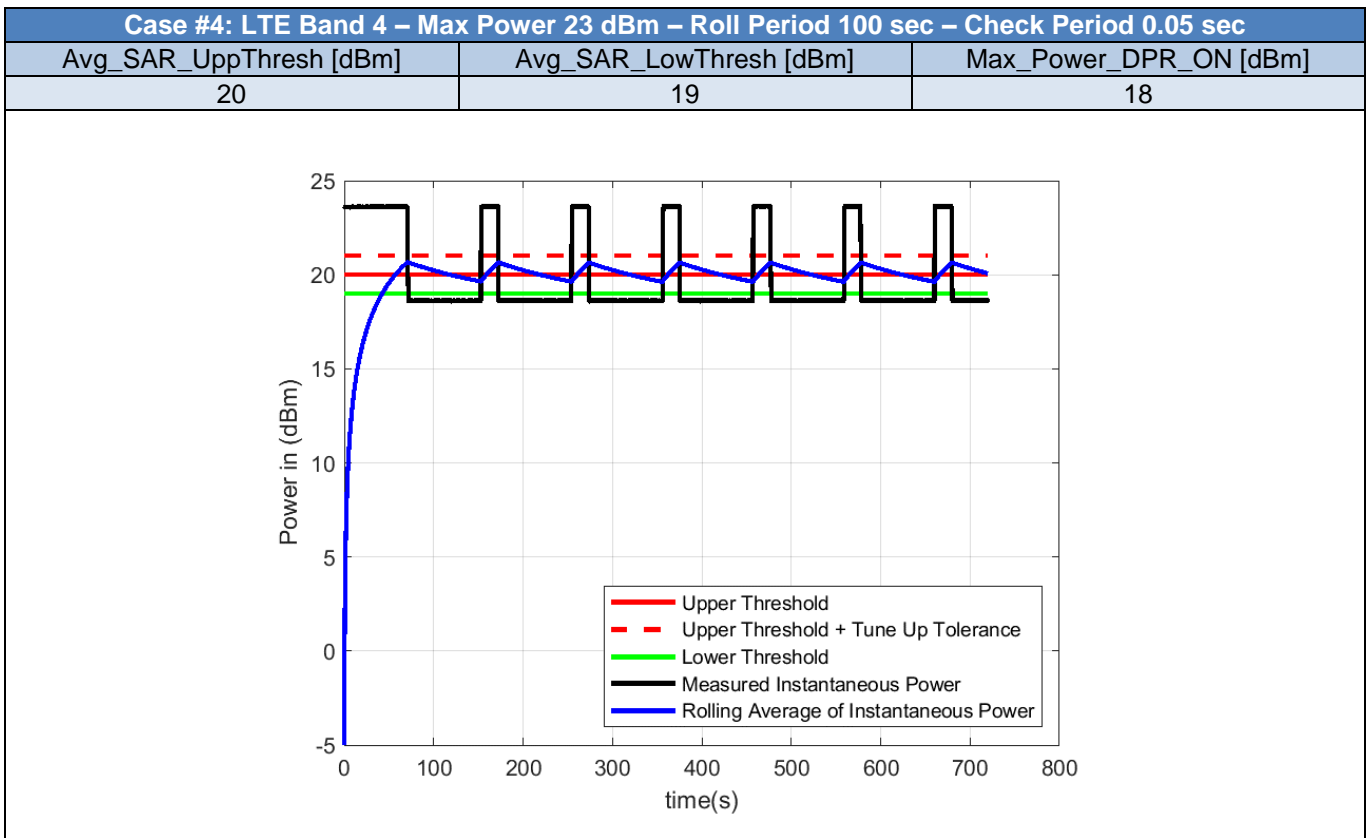
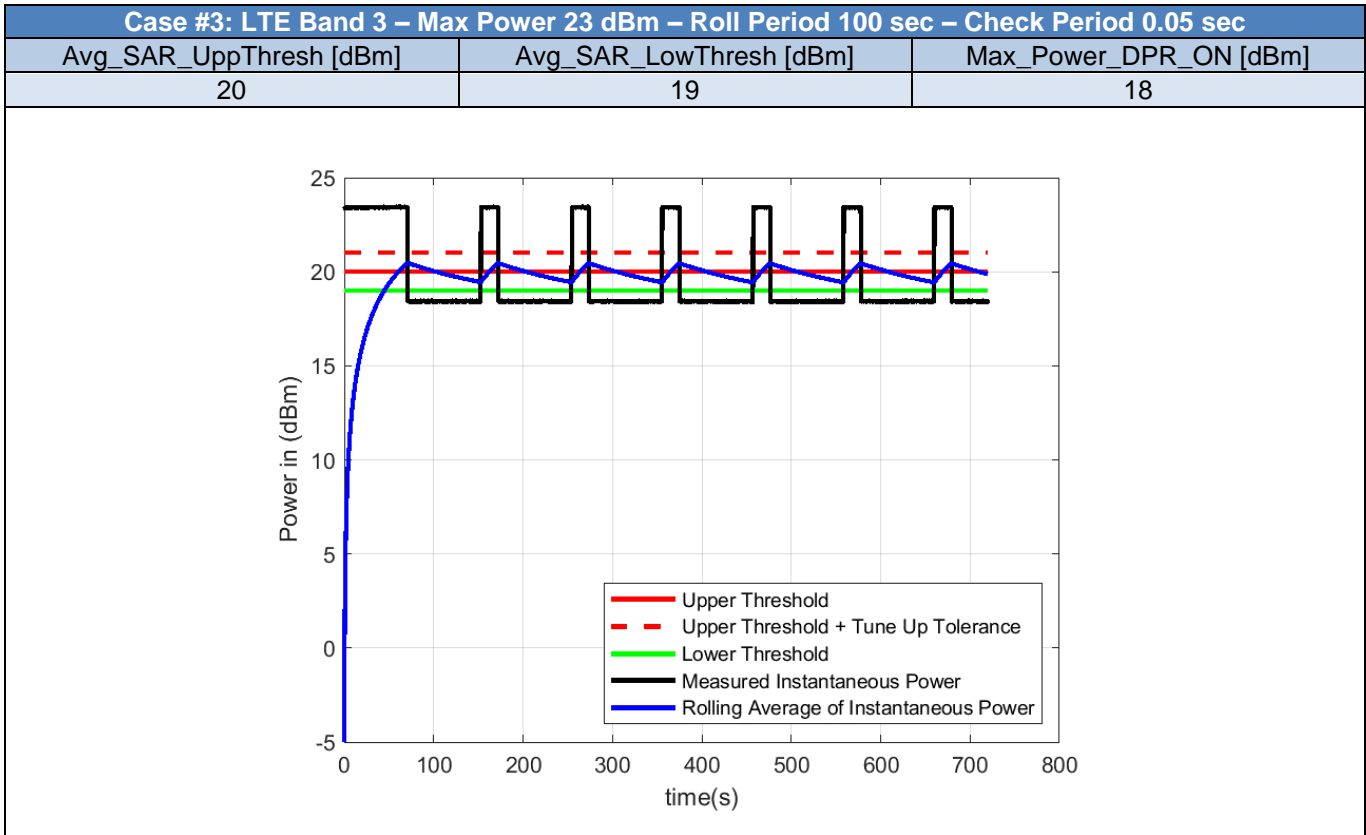

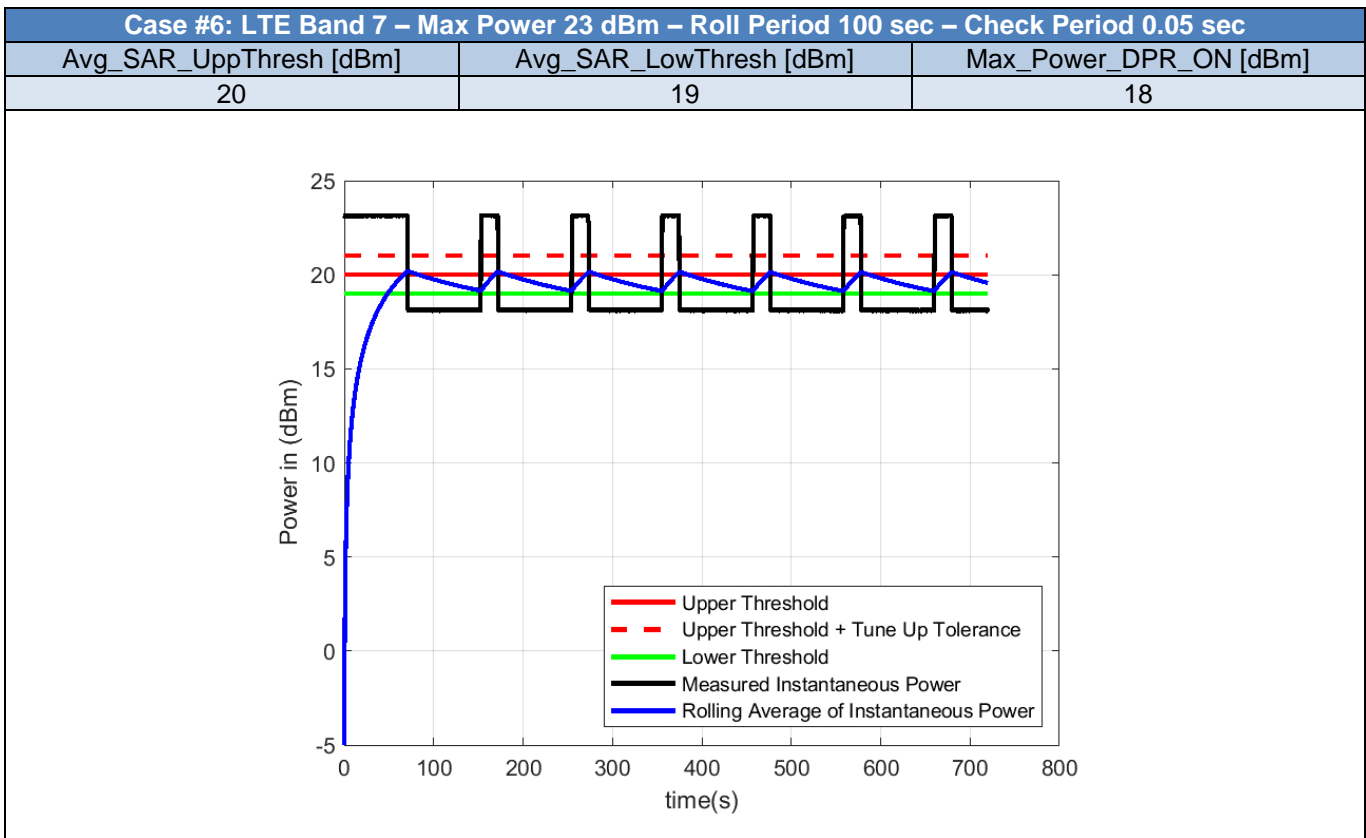
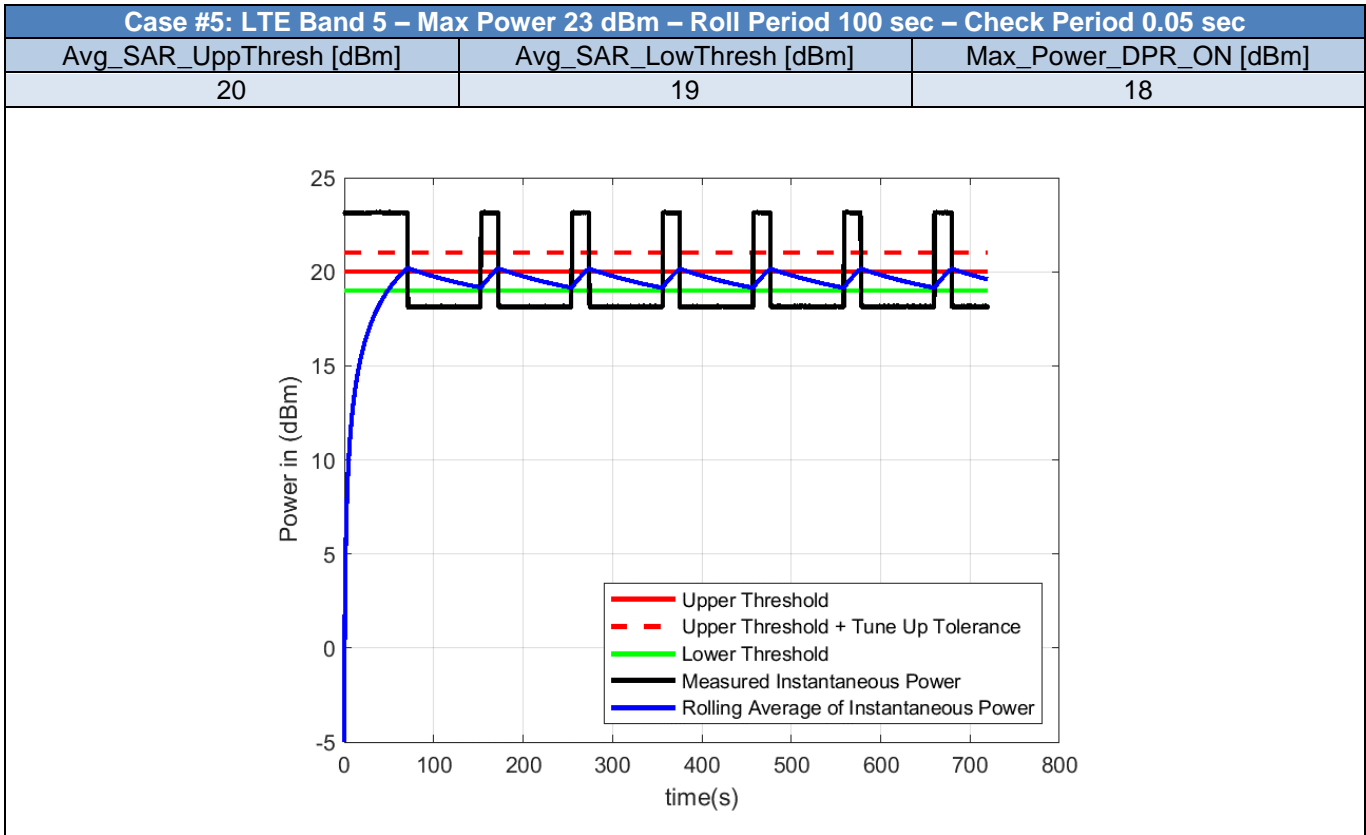

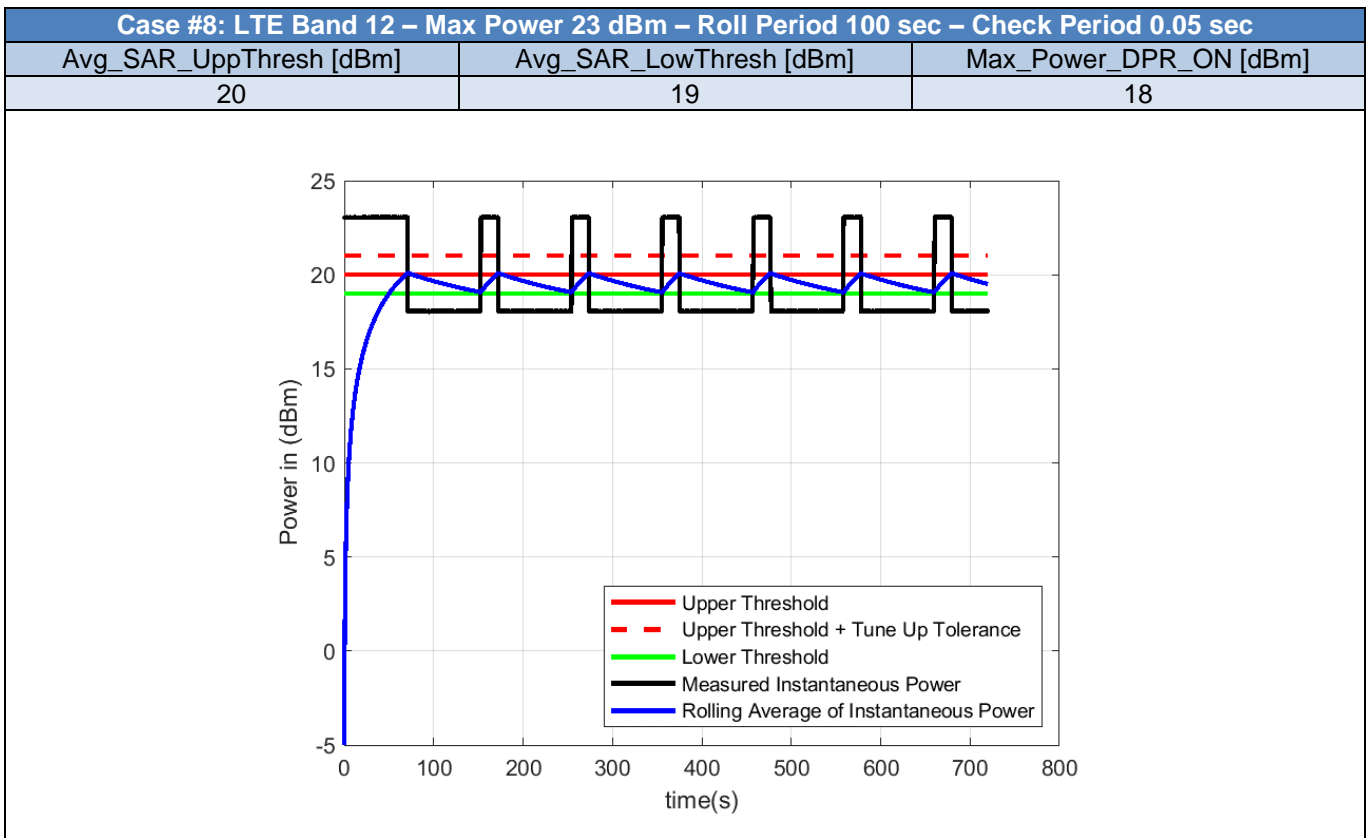
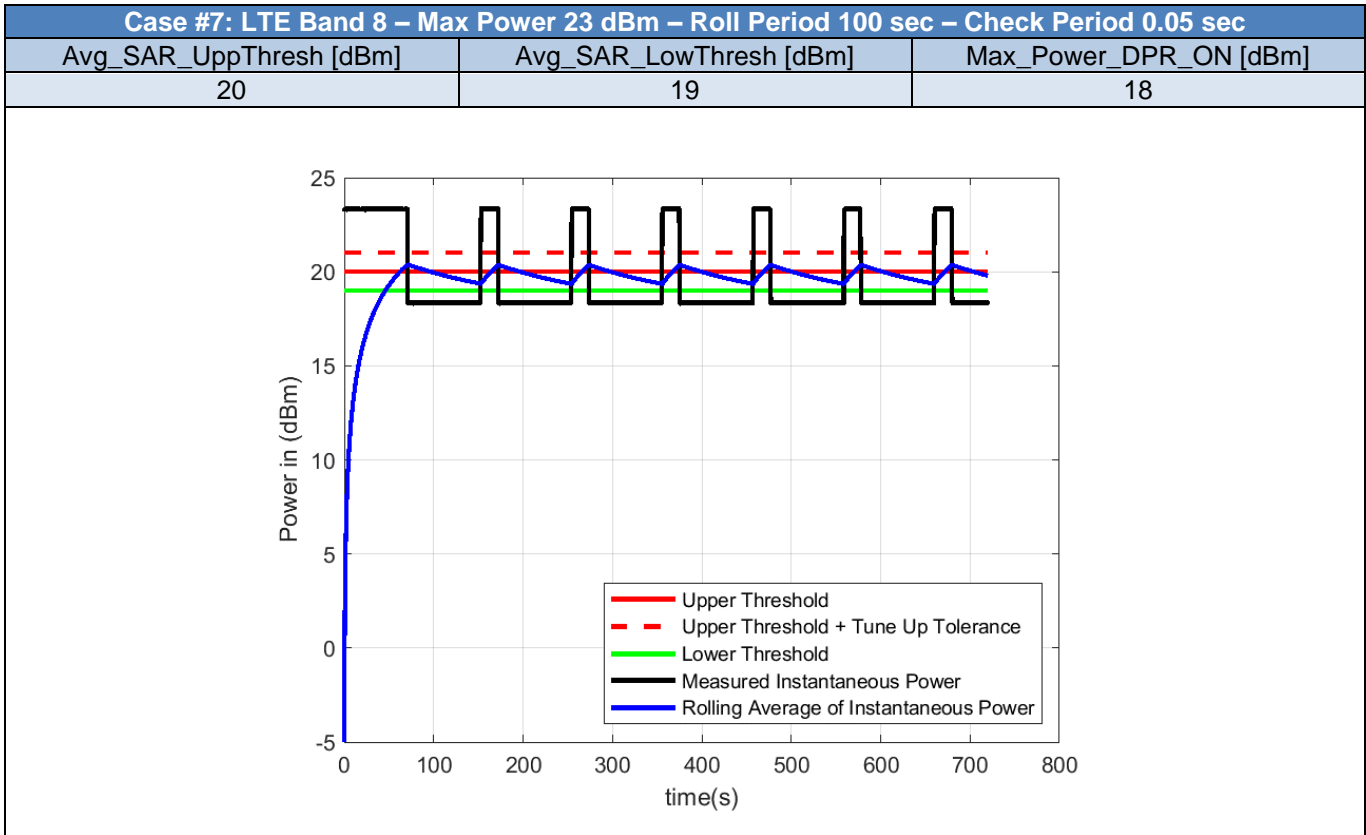

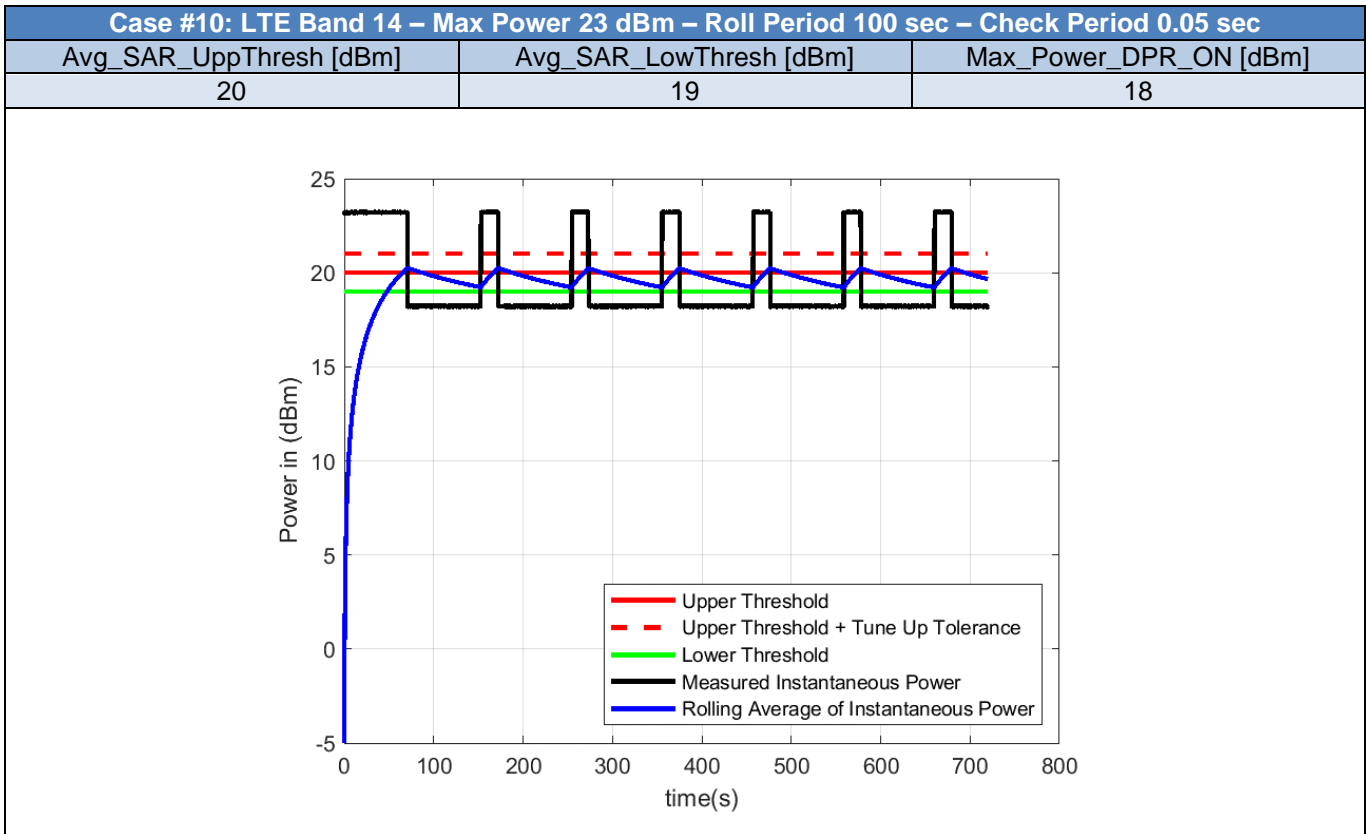
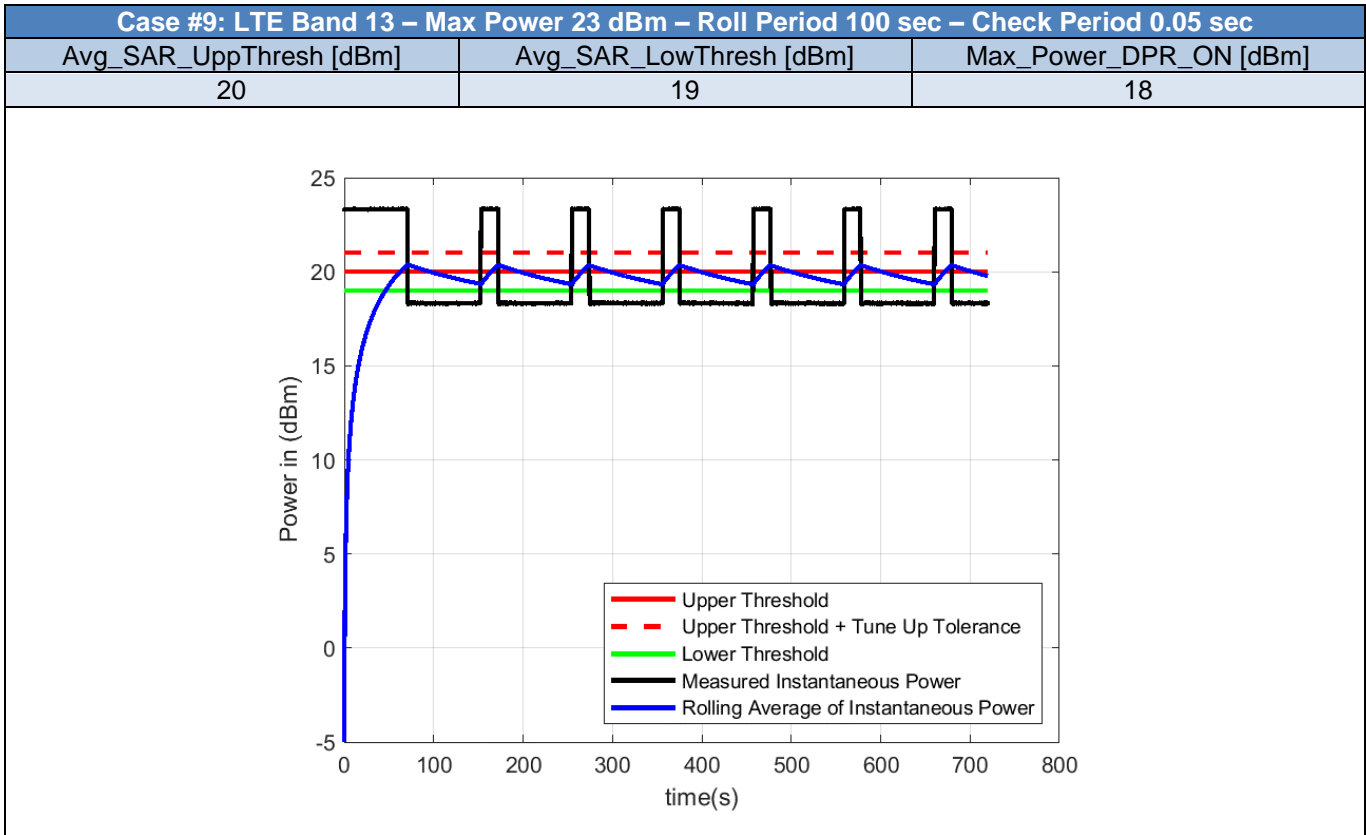

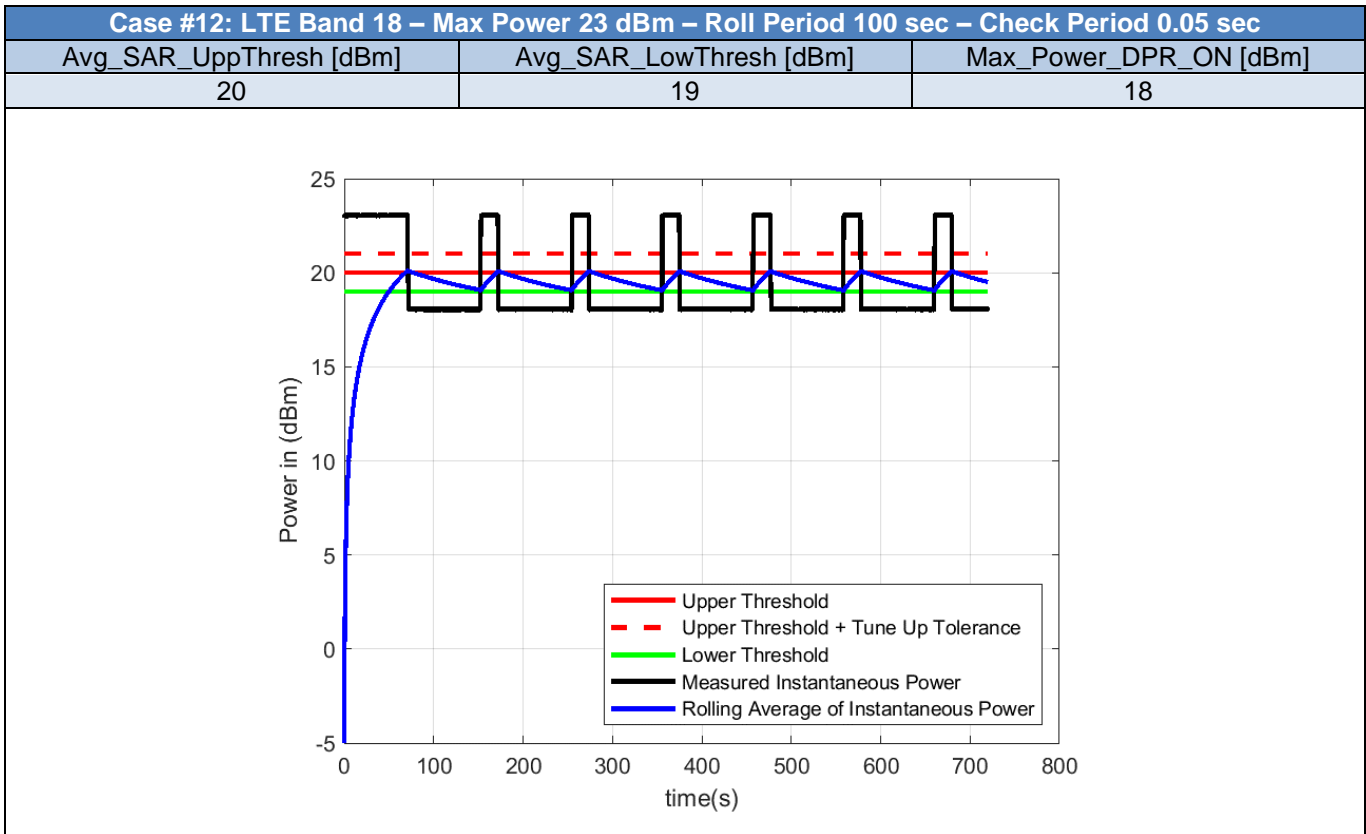
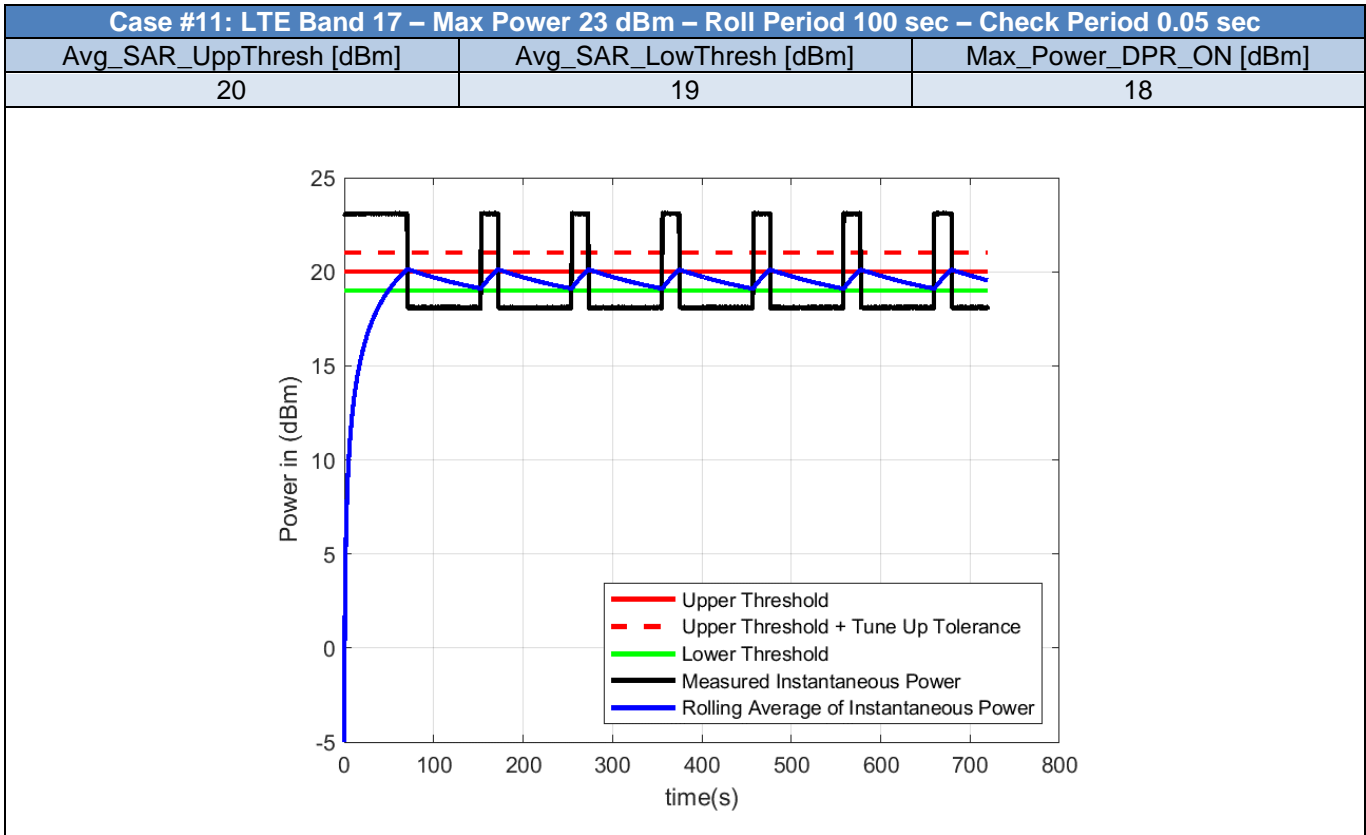

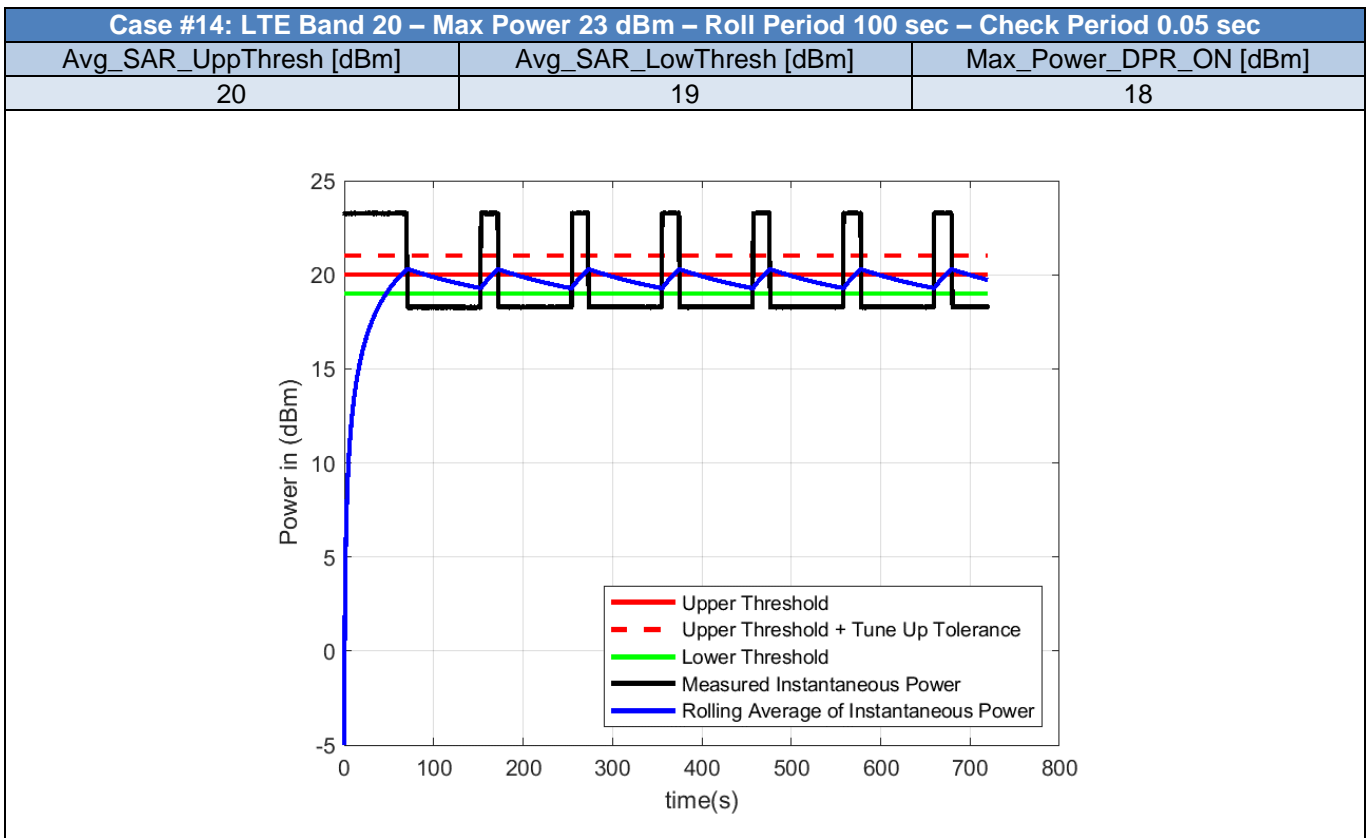
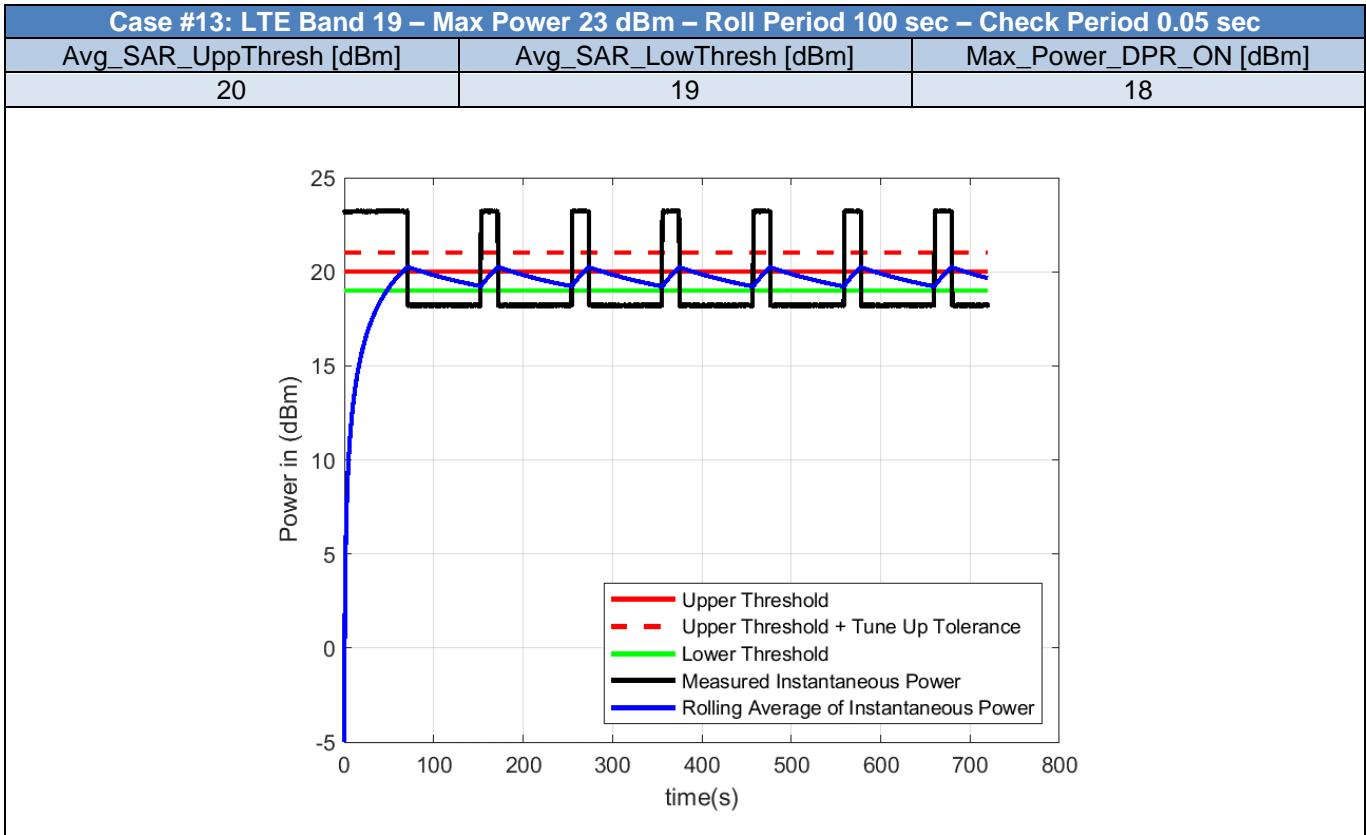

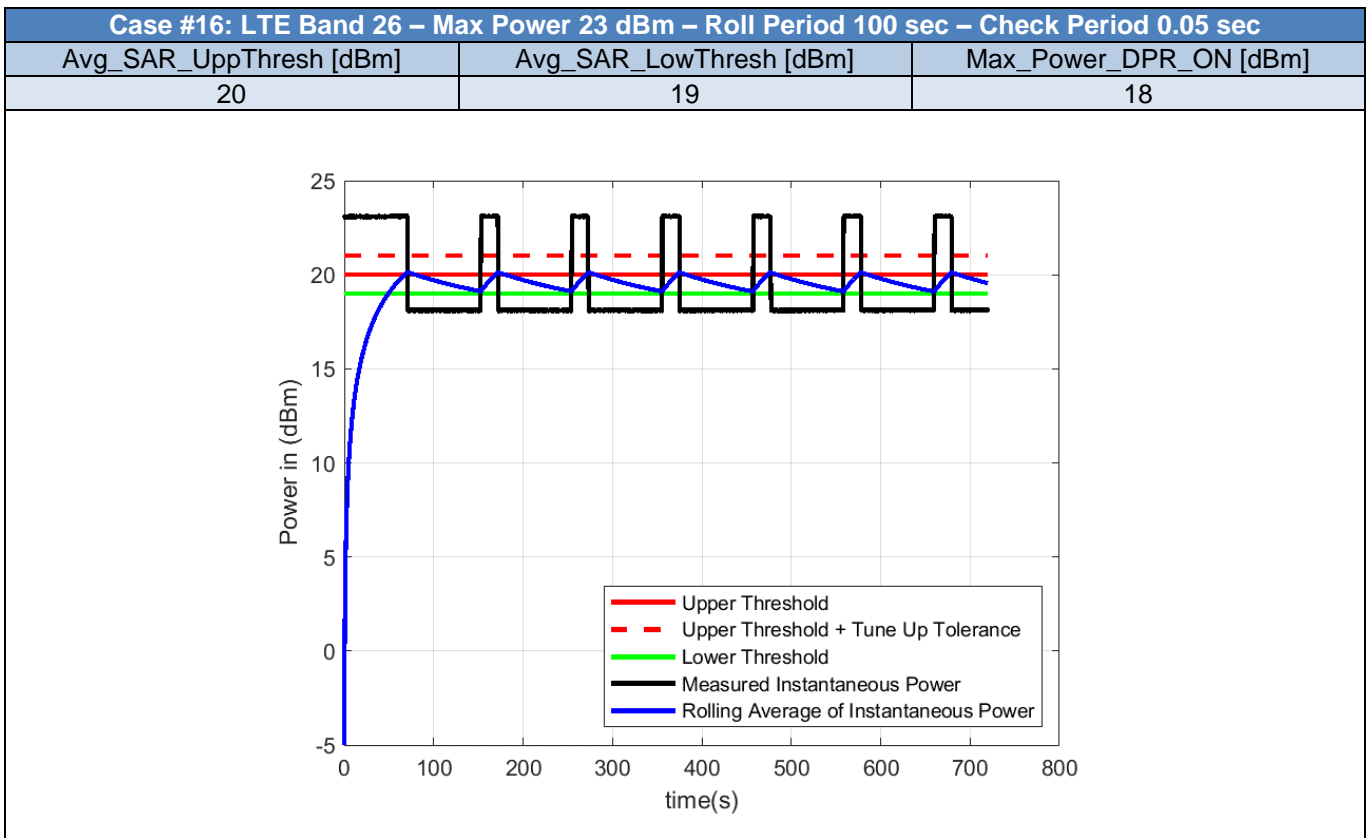
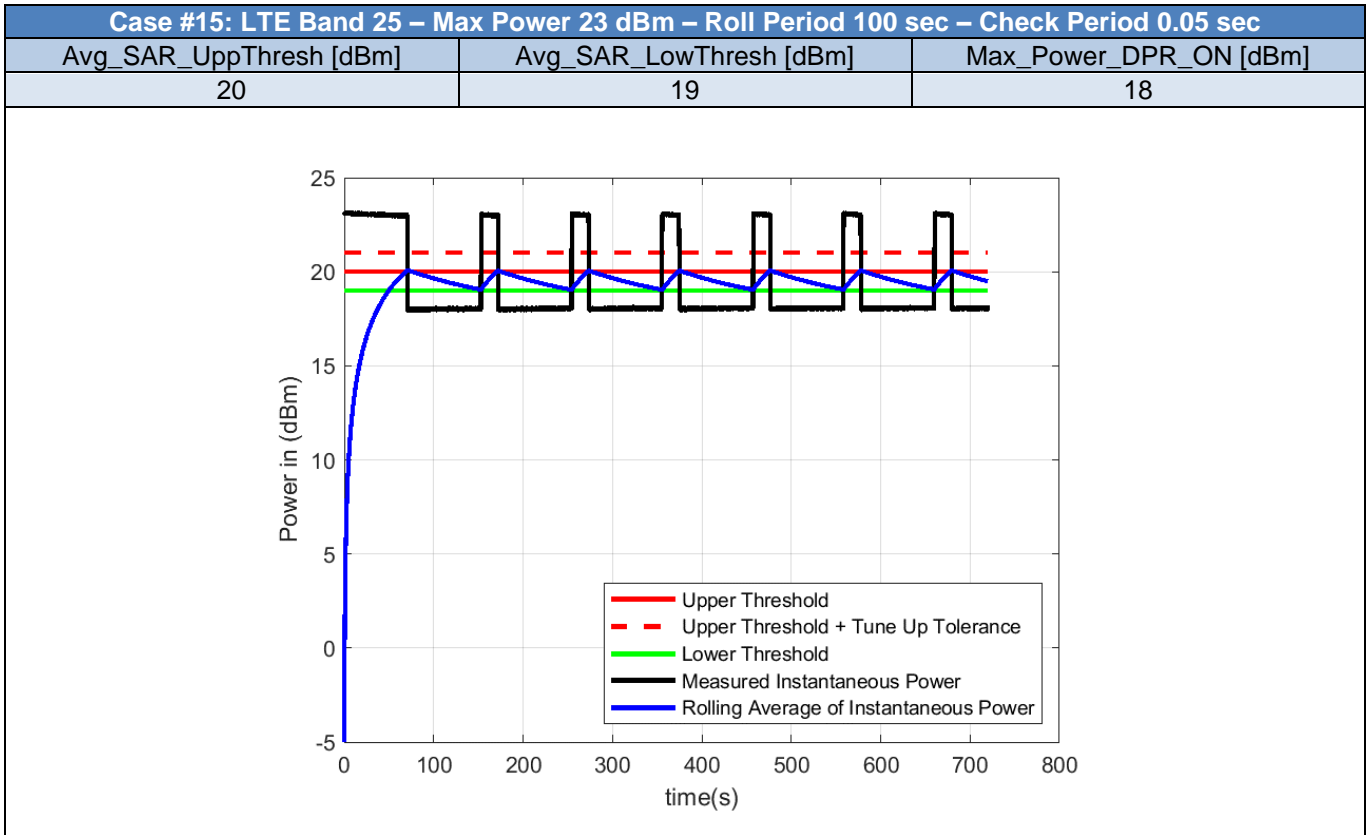

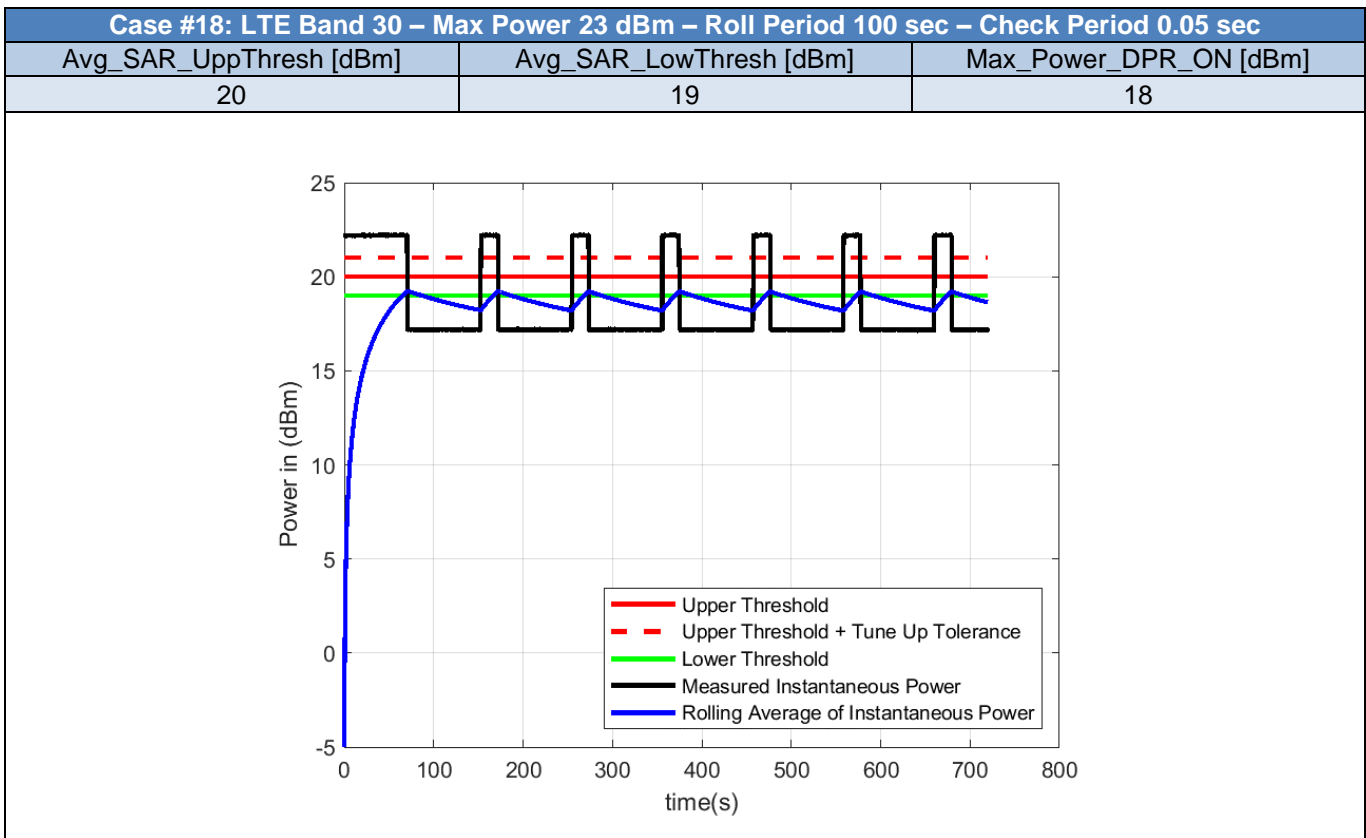
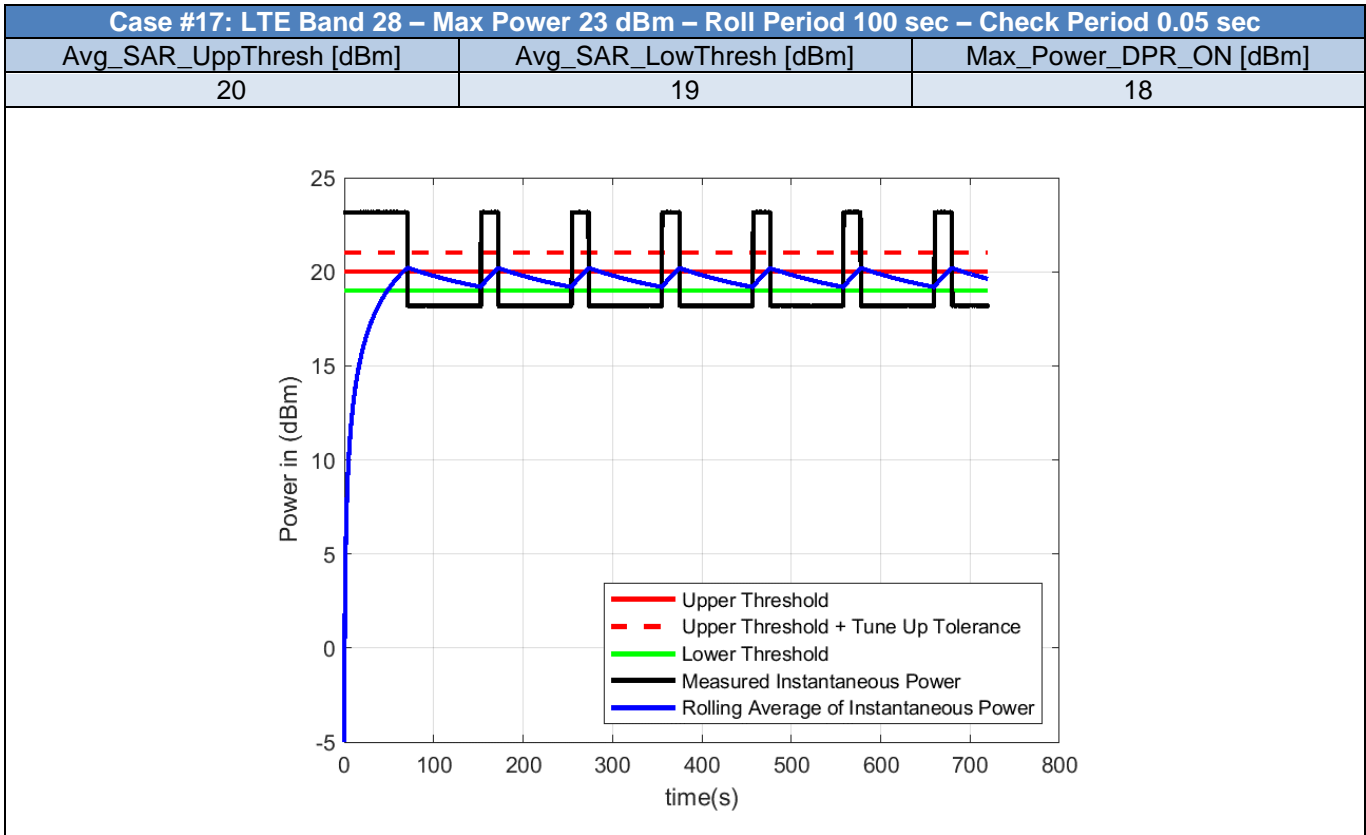

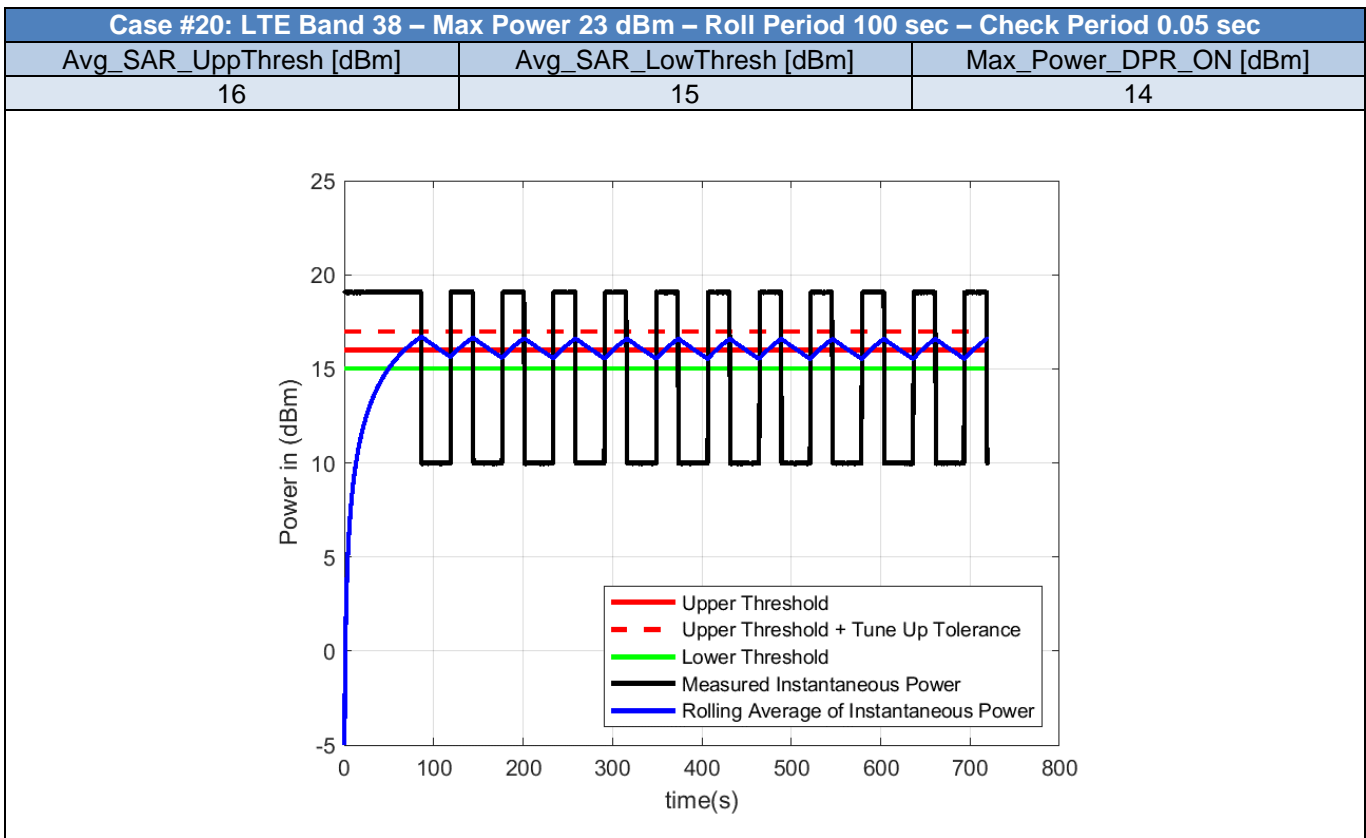
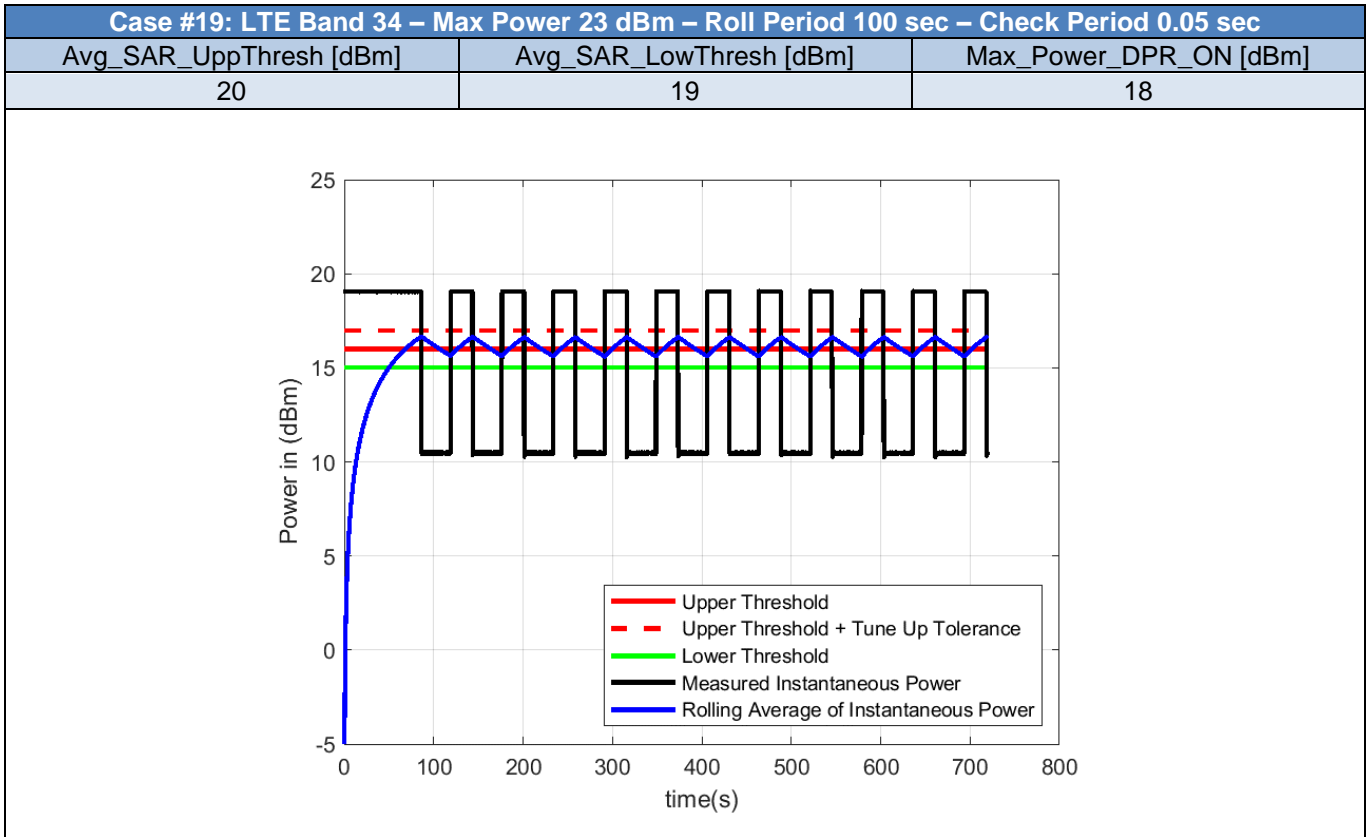

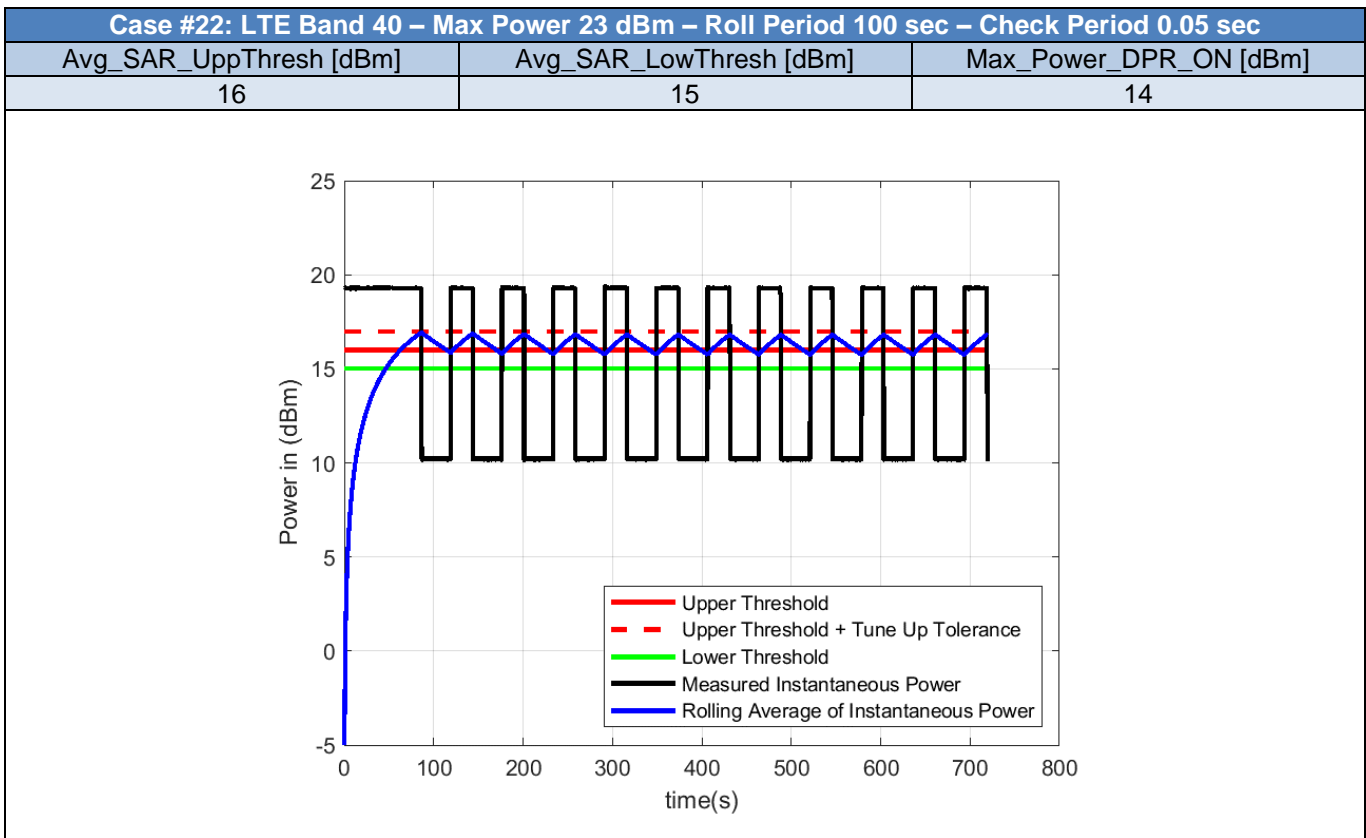
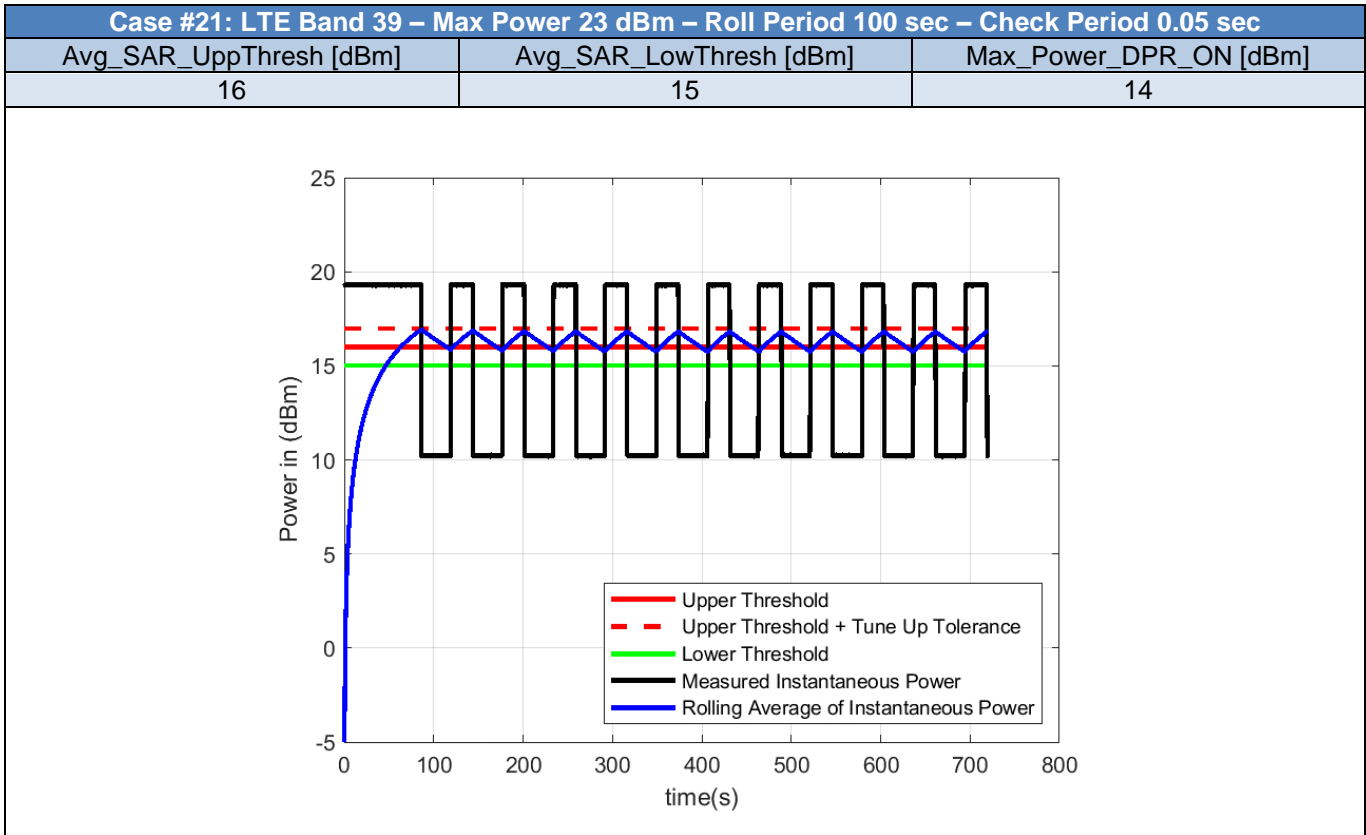

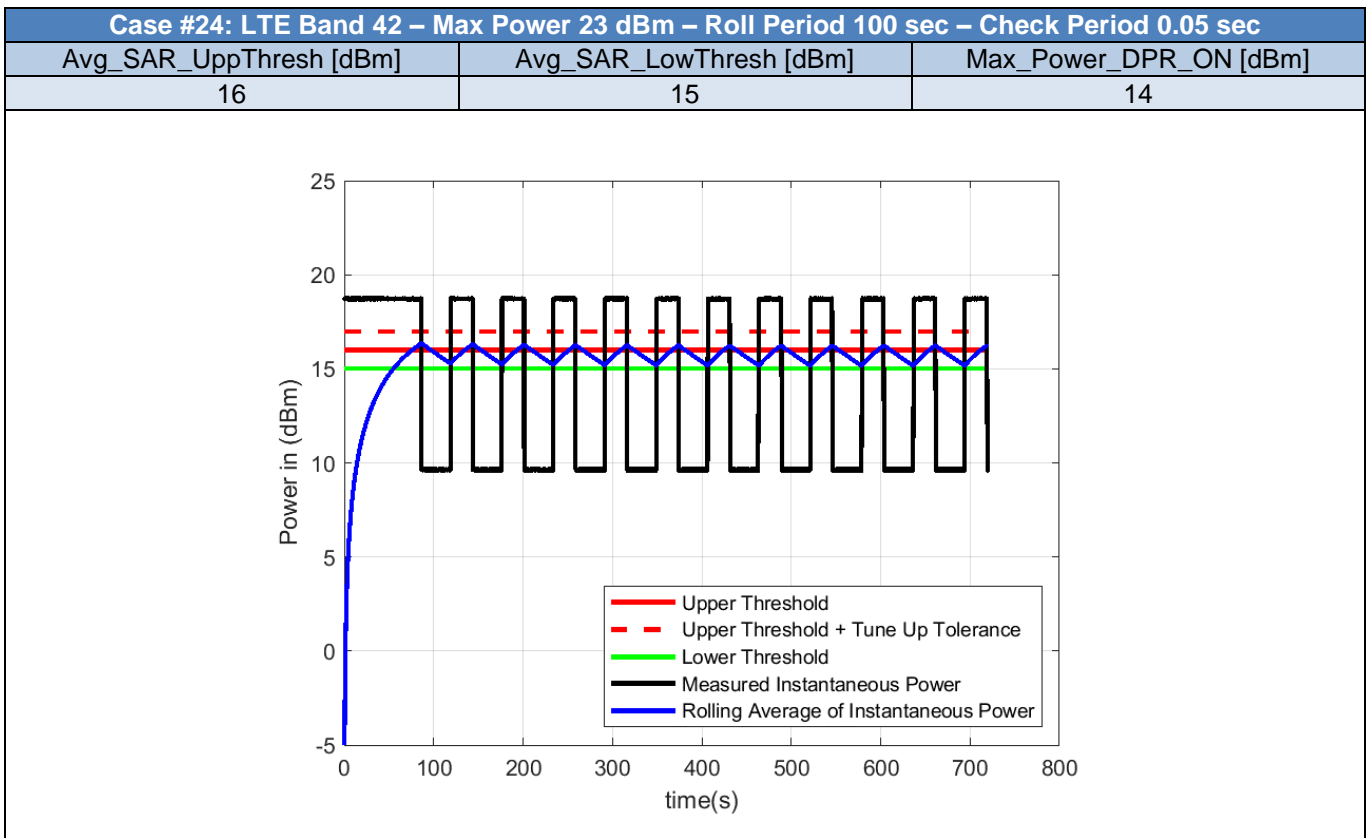
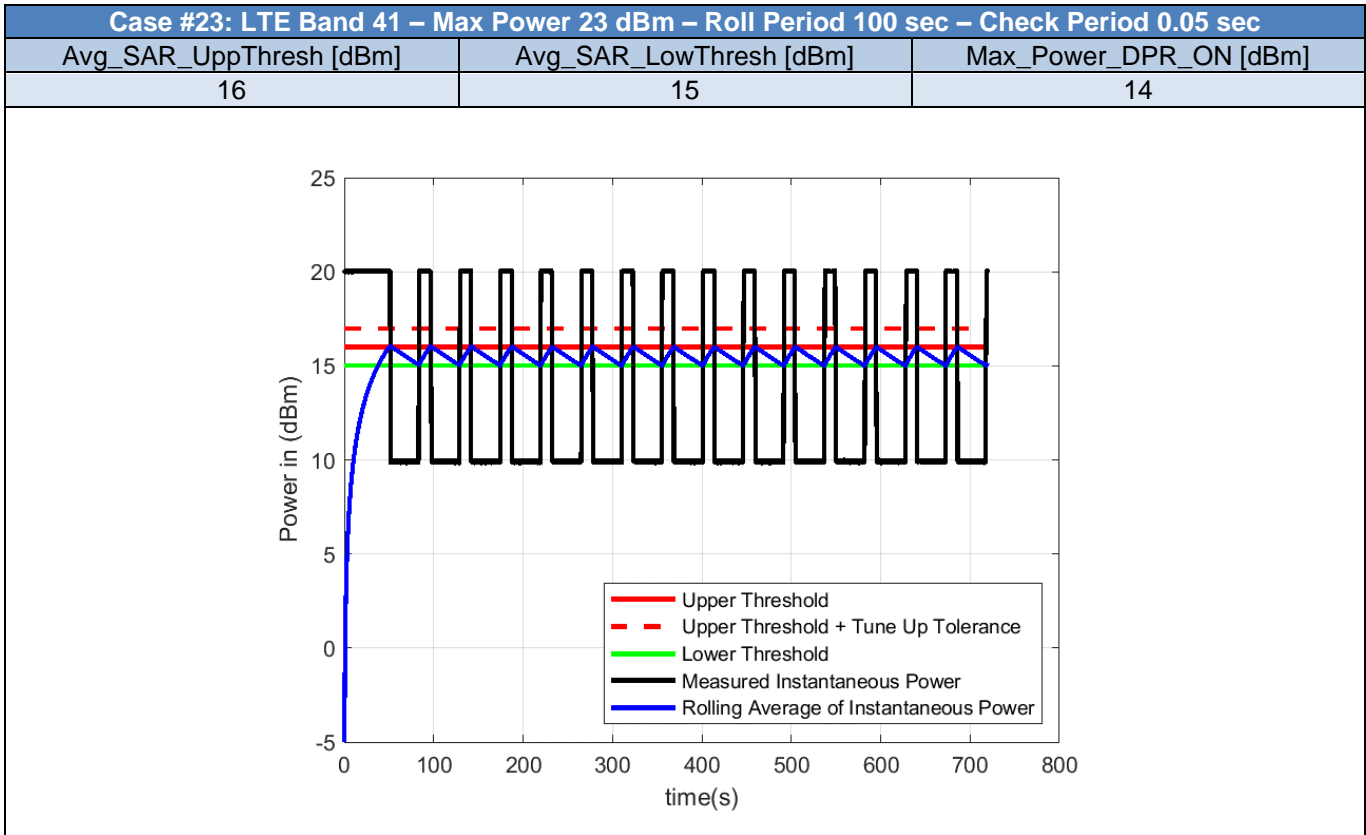

Case #25: LTE Band 43 – Max Power 23 dBm – Roll Period 100 sec – Check Period 0.05 sec		
Avg_SAR_UpThresh [dBm]	Avg_SAR_LowThresh [dBm]	Max_Power_DPR_ON [dBm]
16	15	14

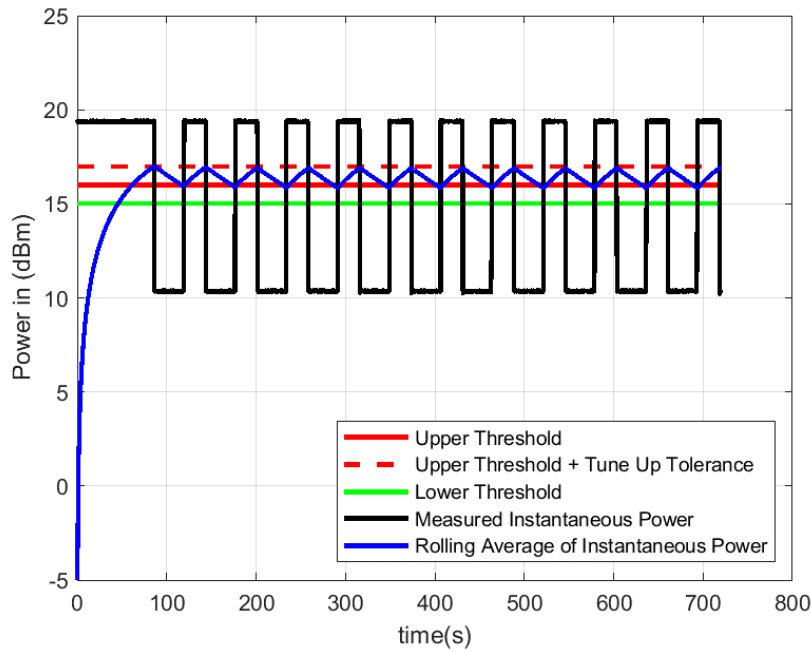

Case #26: LTE Band 48 – Max Power 23 dBm – Roll Period 100 sec – Check Period 0.05 sec		
Avg_SAR_UpThresh [dBm]	Avg_SAR_LowThresh [dBm]	Max_Power_DPR_ON [dBm]
16	15	14

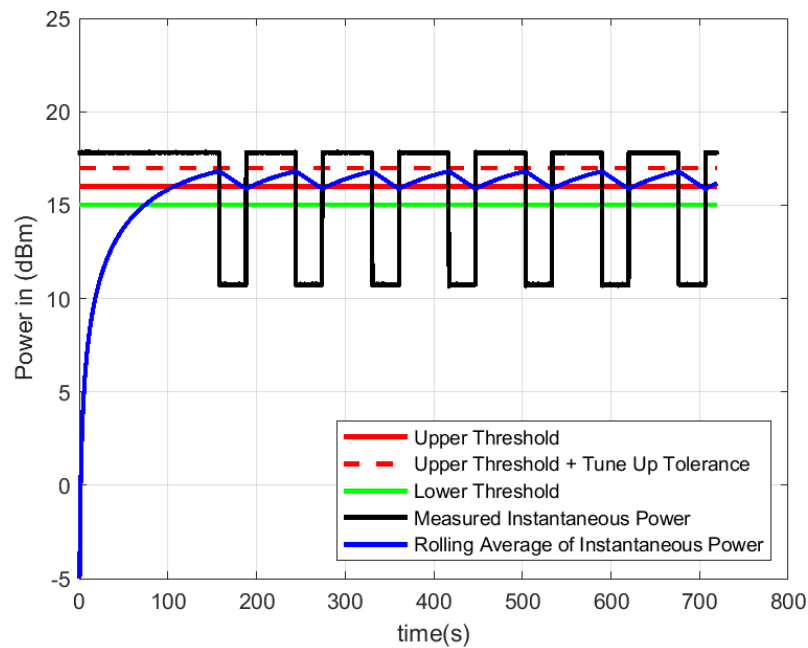

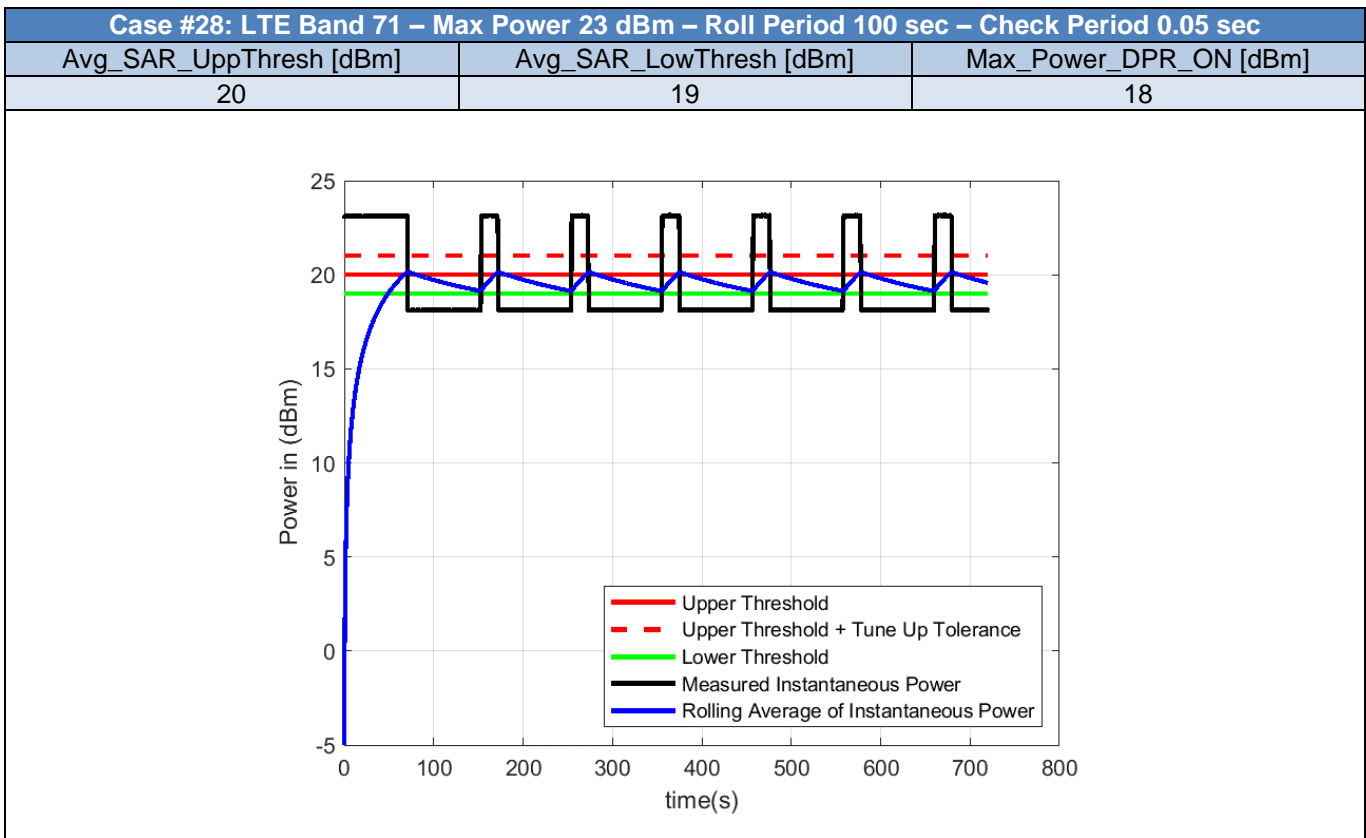
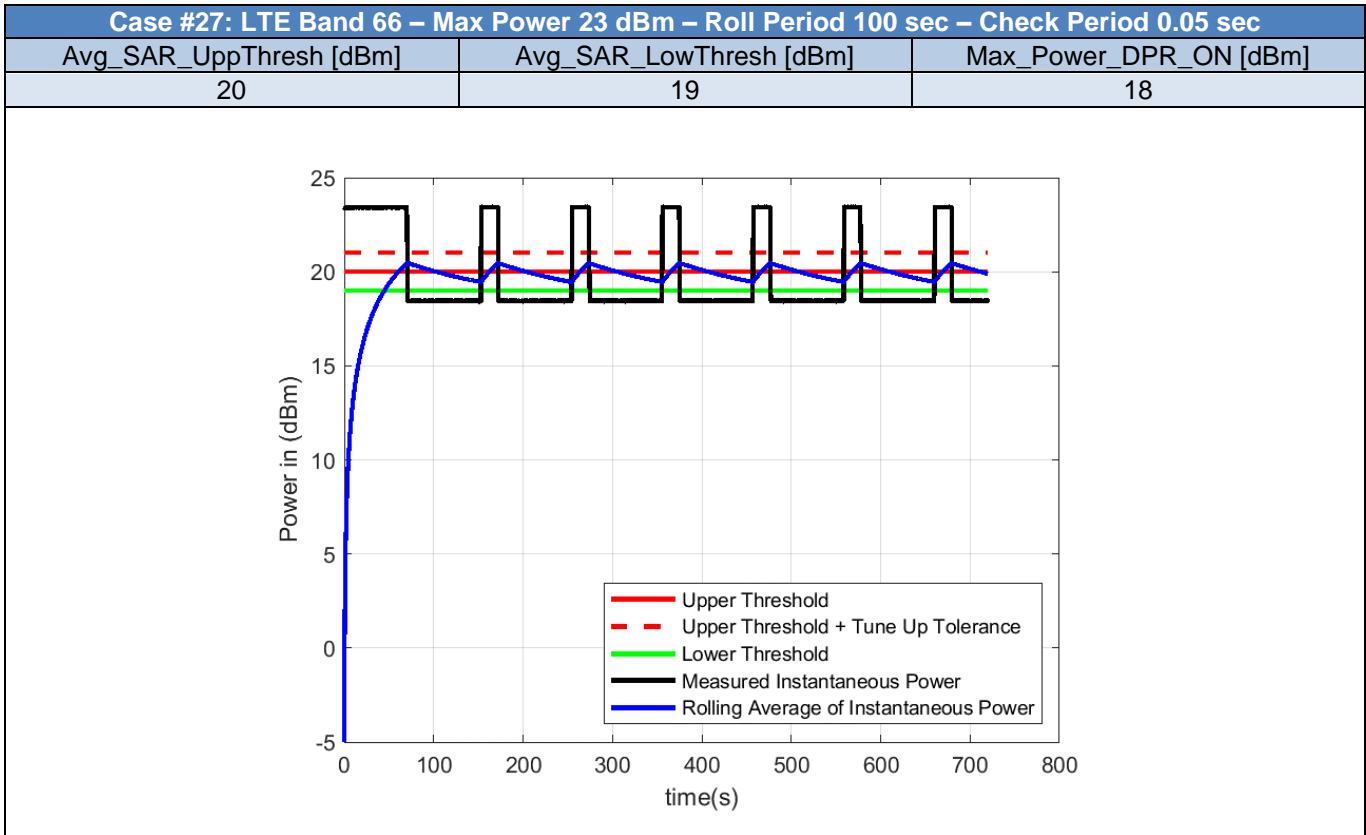

2.7. Bands Validation - WCDMA

Table 6 - Test Cases for Bands Compliance of WCDMA bands

Case	RAT	Band	Max_Power_DPR_OFF_dBm	Roll_Period_s	Check_Period_s	Avg_SAR_Upper_Threshold_dBm	Avg_SAR_Lower_Threshold_dBm	Max_Power_DPR_ON_dBm
29	WCDMA	1	23.5	100	0.05	20	19	18
30	WCDMA	2	23.5	100	0.05	20	19	18
31	WCDMA	4	23.5	100	0.05	20	19	18
32	WCDMA	5	23.5	100	0.05	20	19	18
33	WCDMA	8	23.5	100	0.05	20	19	18

Note: The Average power is calculated using the measured instantaneous power and compared to the UpperThreshold Plus Tune-Up Tolerance. This is applied for all the test cases in this report.

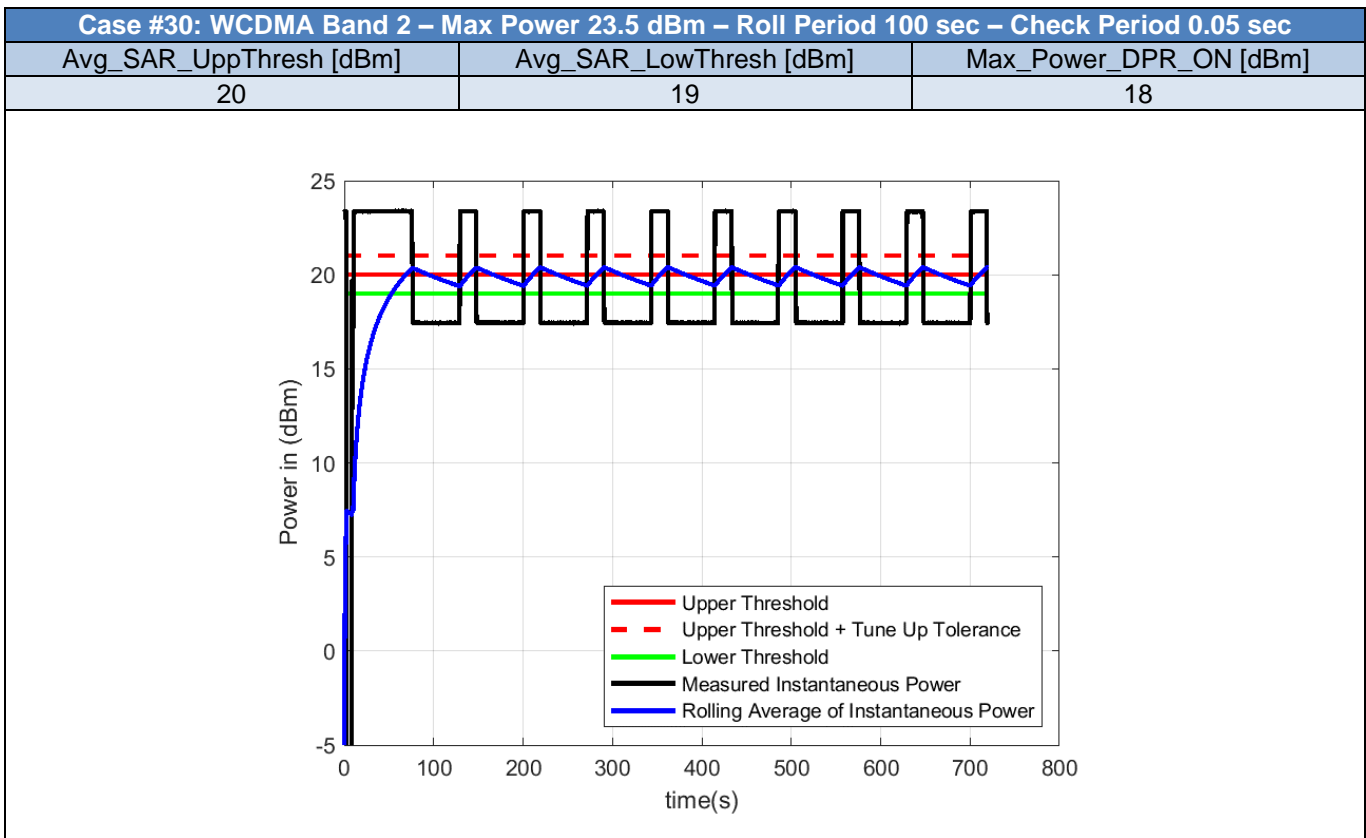
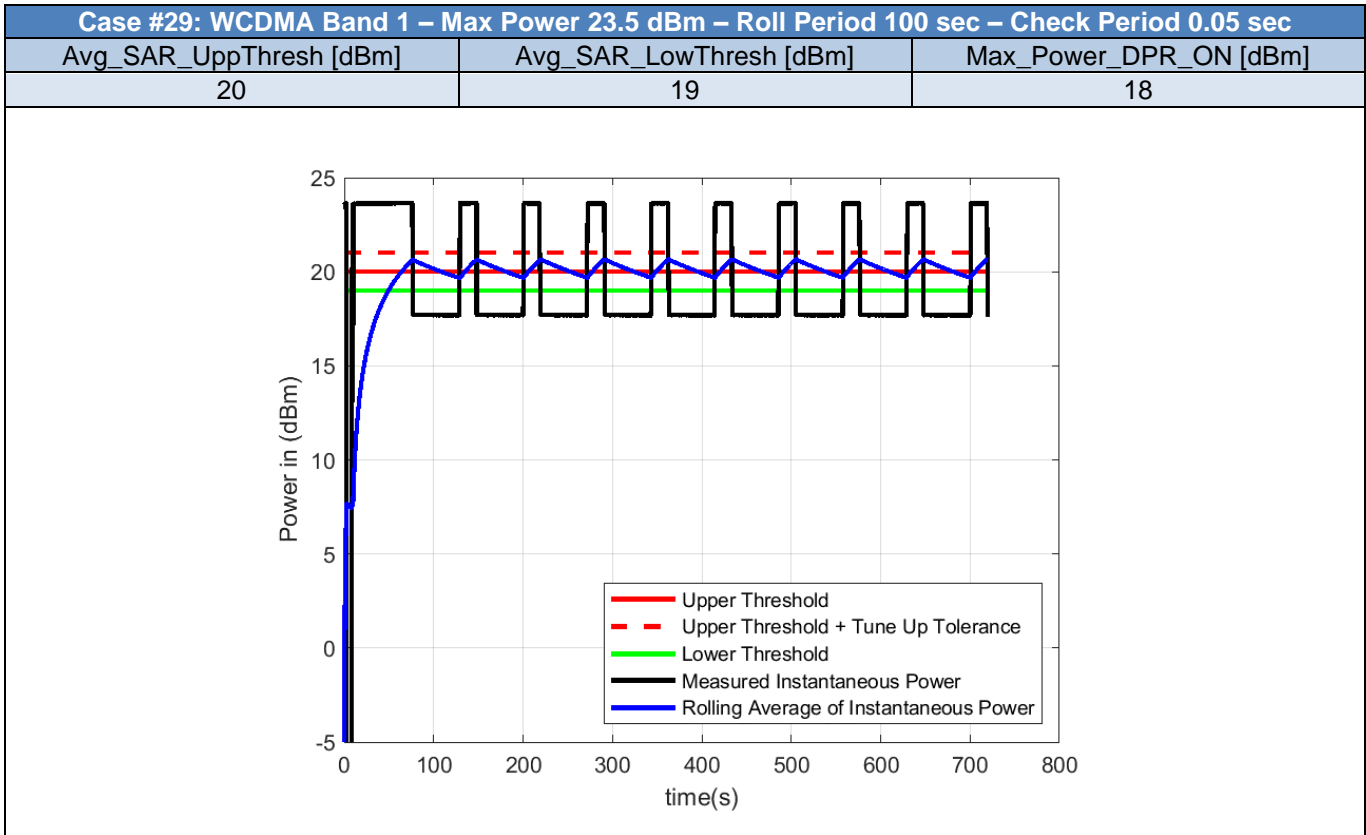

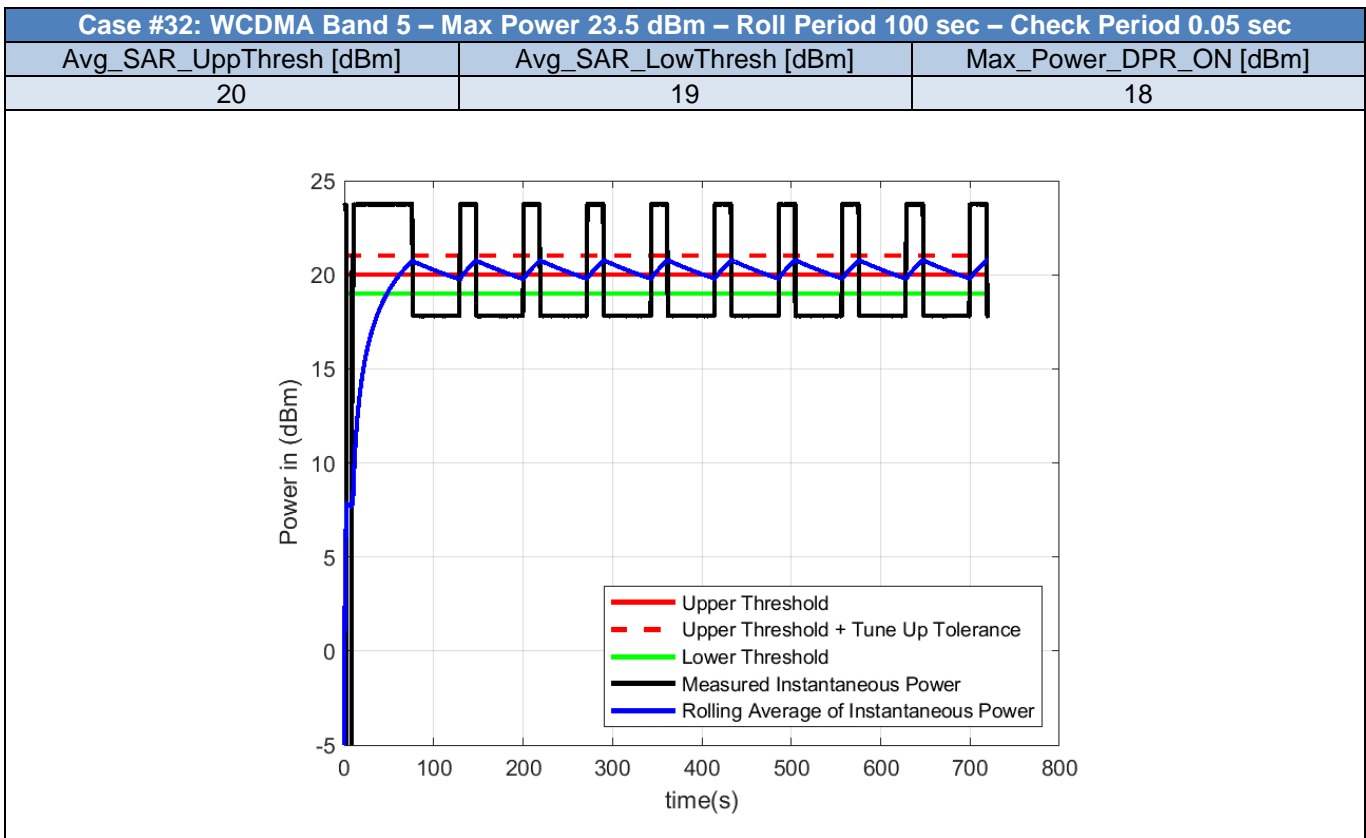
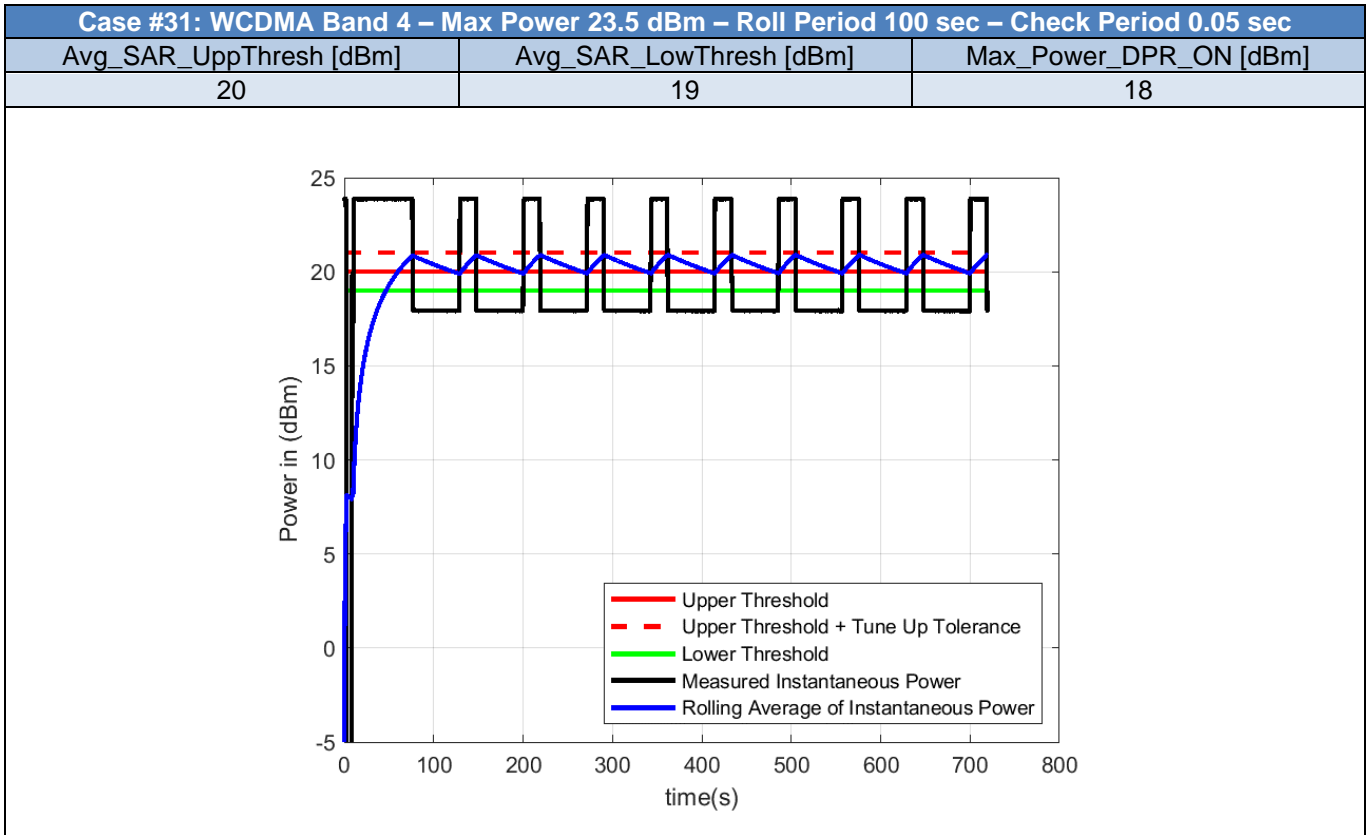

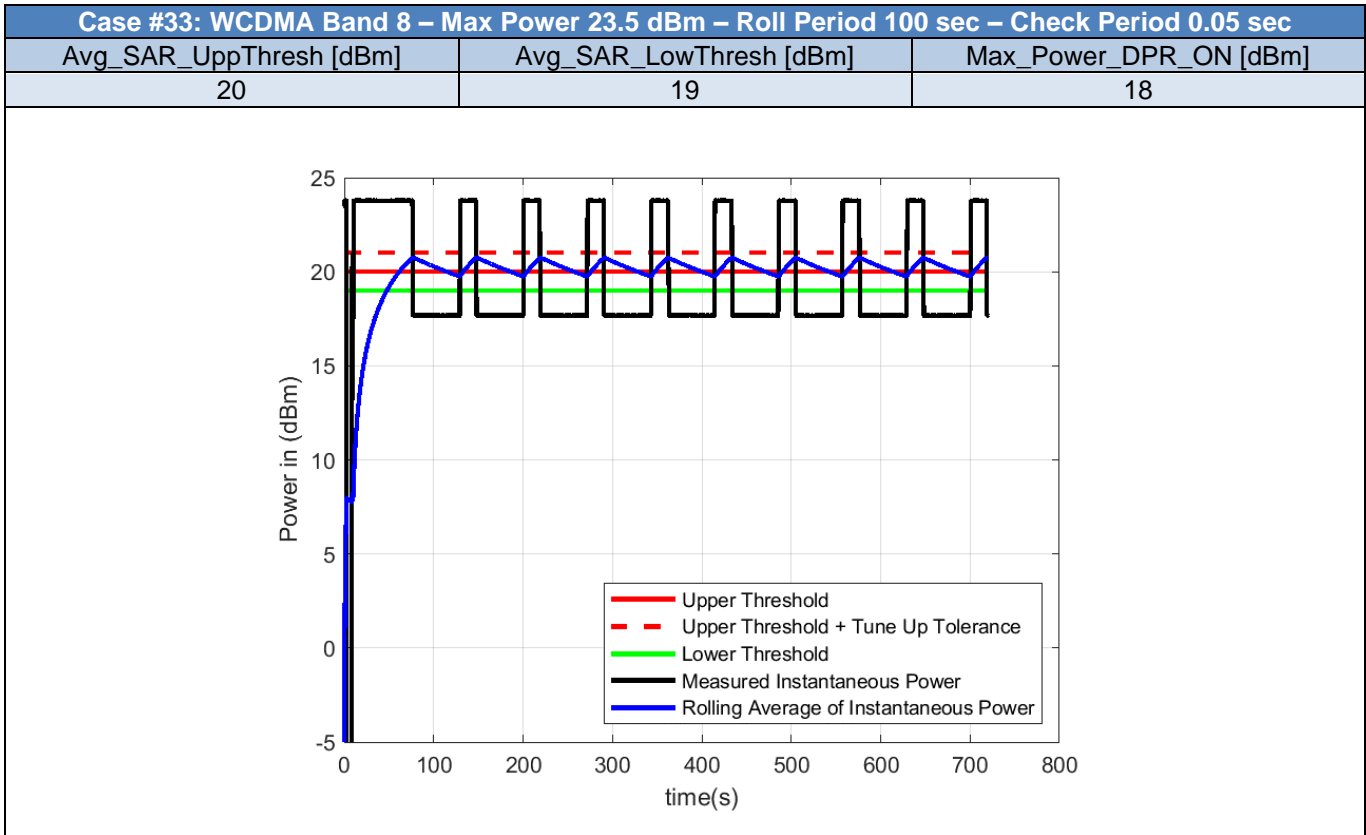

2.8. Time Varying Test Sequence - NR

Table 7 - Test Cases for Time Varying Test Sequence of NR bands

Case	RAT	Band	Max_Power_ DPR_OFF	Roll_Period	Check_Perio d	Avg_SAR_Up pThresh	Avg_SAR_Lo wThresh	Max_Power_ DPR_ON
1	NR	5	23	100	0.05	18	15	14
2	NR	5	23	100	0.05	18	15	14

Note: The Average power is calculated using the measured instantaneous power and compared to the UpperThreshold Plus Tune-Up Tolerance. This is applied for all the test cases in this report.

Case #1: Sequence 1 - NR Band 5 – Max Power 23 dBm – Roll Period 100 sec – Check Period 0.05 sec

Avg_SAR_UppThresh [dBm]	Avg_SAR_LowThresh [dBm]	Max_Power_DPR_ON [dBm]
18	15	14

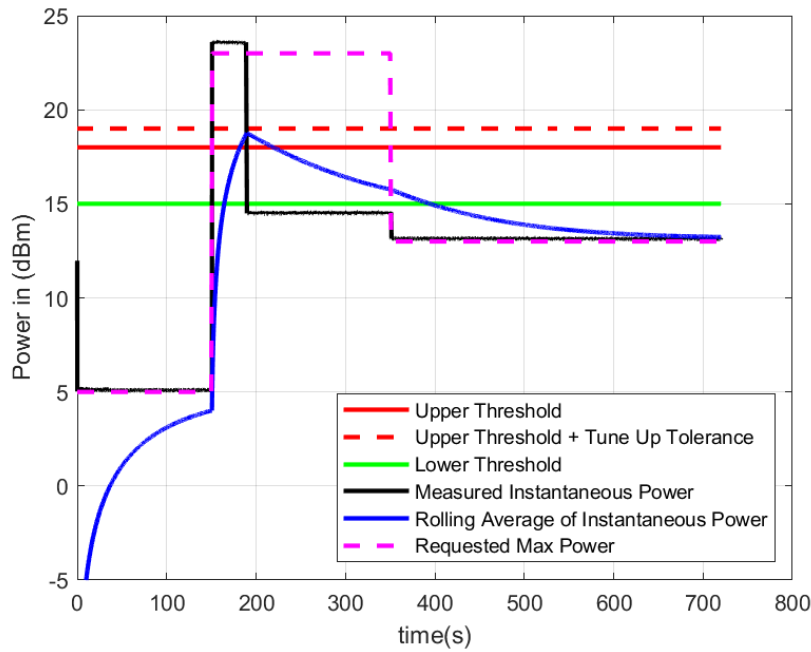

Case #2: Sequence 2 - NR Band 5 – Max Power 23 dBm – Roll Period 100 sec – Check Period 0.05 sec

Avg_SAR_UppThresh [dBm]	Avg_SAR_LowThresh [dBm]	Max_Power_DPR_ON [dBm]
18	15	14

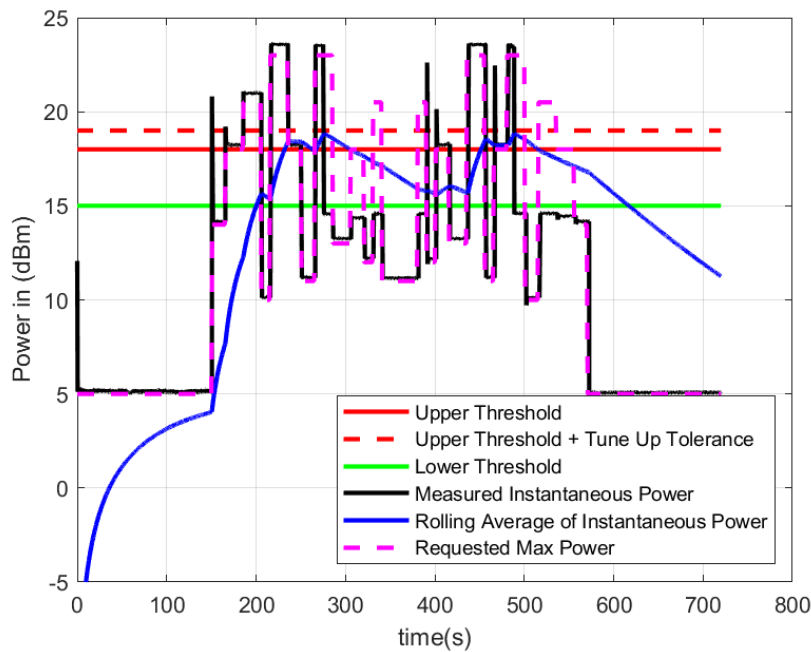

2.9. Time Varying Test Sequence - LTE

Table 8 - Test Cases for Time Varying Test Sequence of LTE bands

Case	RAT	Band	Max_Power_ DPR_OFF	Roll_Period	Check_Perio d	Avg_SAR_Up pThresh	Avg_SAR_Lo wThresh	Max_Power_ DPR_ON
1	LTE	2	23	100	0.05	18	15	14
2	LTE	2	23	100	0.05	18	15	14

Note: The Average power is calculated using the measured instantaneous power and compared to the UpperThreshold Plus Tune-Up Tolerance. This is applied for all the test cases in this report.

Case #1: Sequence 1 - LTE Band 2 – Max Power 23 dBm – Roll Period 100 sec – Check Period 0.05 sec

Avg_SAR_UppThresh [dBm]	Avg_SAR_LowThresh [dBm]	Max_Power_DPR_ON [dBm]
18	15	14

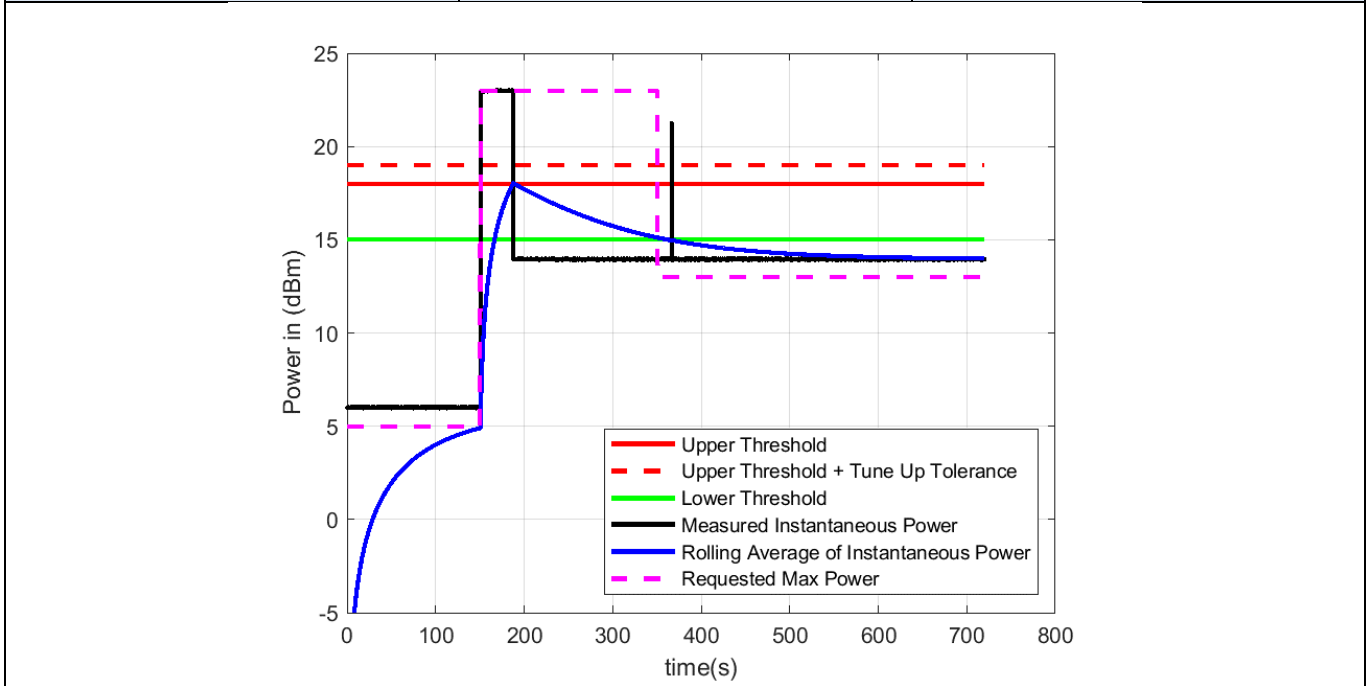

Case #2: Sequence 2 - LTE Band 2 – Max Power 23 dBm – Roll Period 100 sec – Check Period 0.05 sec

Avg_SAR_UppThresh [dBm]	Avg_SAR_LowThresh [dBm]	Max_Power_DPR_ON [dBm]
18	15	14

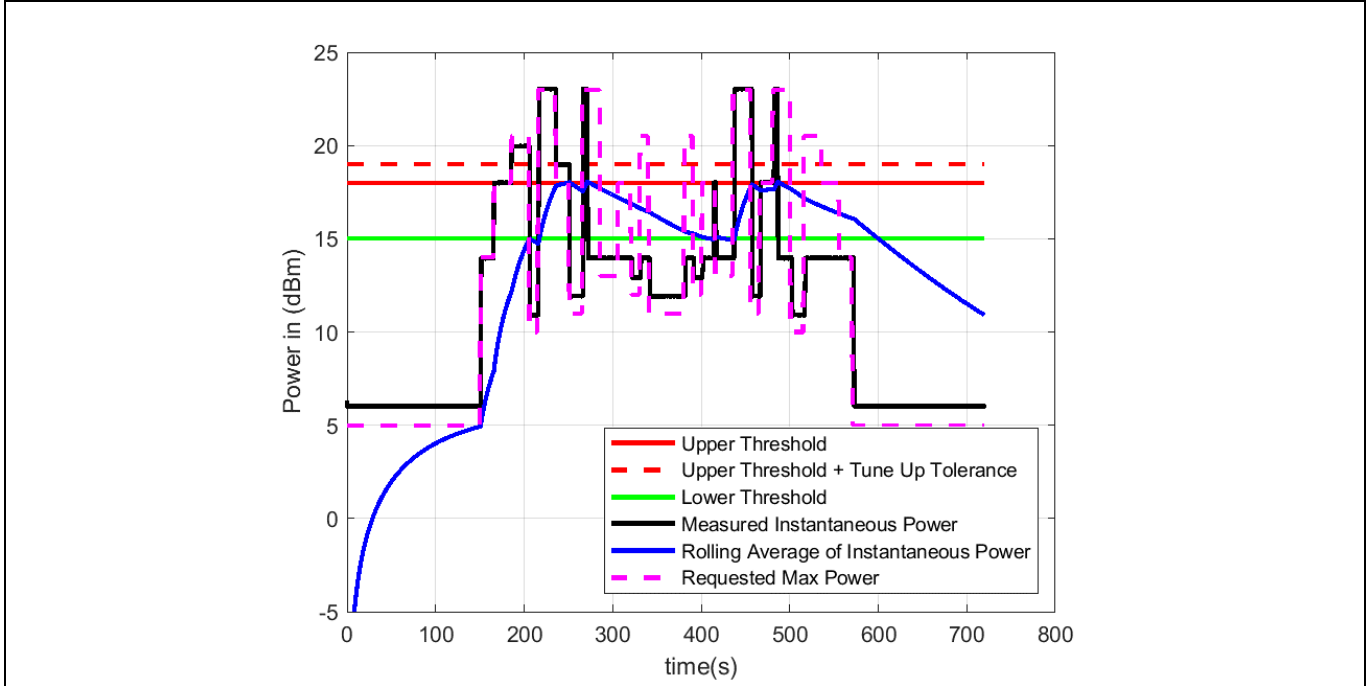

2.10. Time Varying Test Sequence - WCDMA

Table 9 - Test Cases for Time Varying Test Sequence of WCDMA bands

Case	RAT	Band	Max_Power_ DPR_OFF	Roll_Period	Check_Perio d	Avg_SAR_Up pThresh	Avg_SAR_Lo wThresh	Max_Power_ DPR_ON
1	WCDMA	2	23.5	100	0.05	18	15	14
2	WCDMA	2	23.5	100	0.05	18	15	14

Note: The Average power is calculated using the measured instantaneous power and compared to the UpperThreshold Plus Tune-Up Tolerance. This is applied for all the test cases in this report.

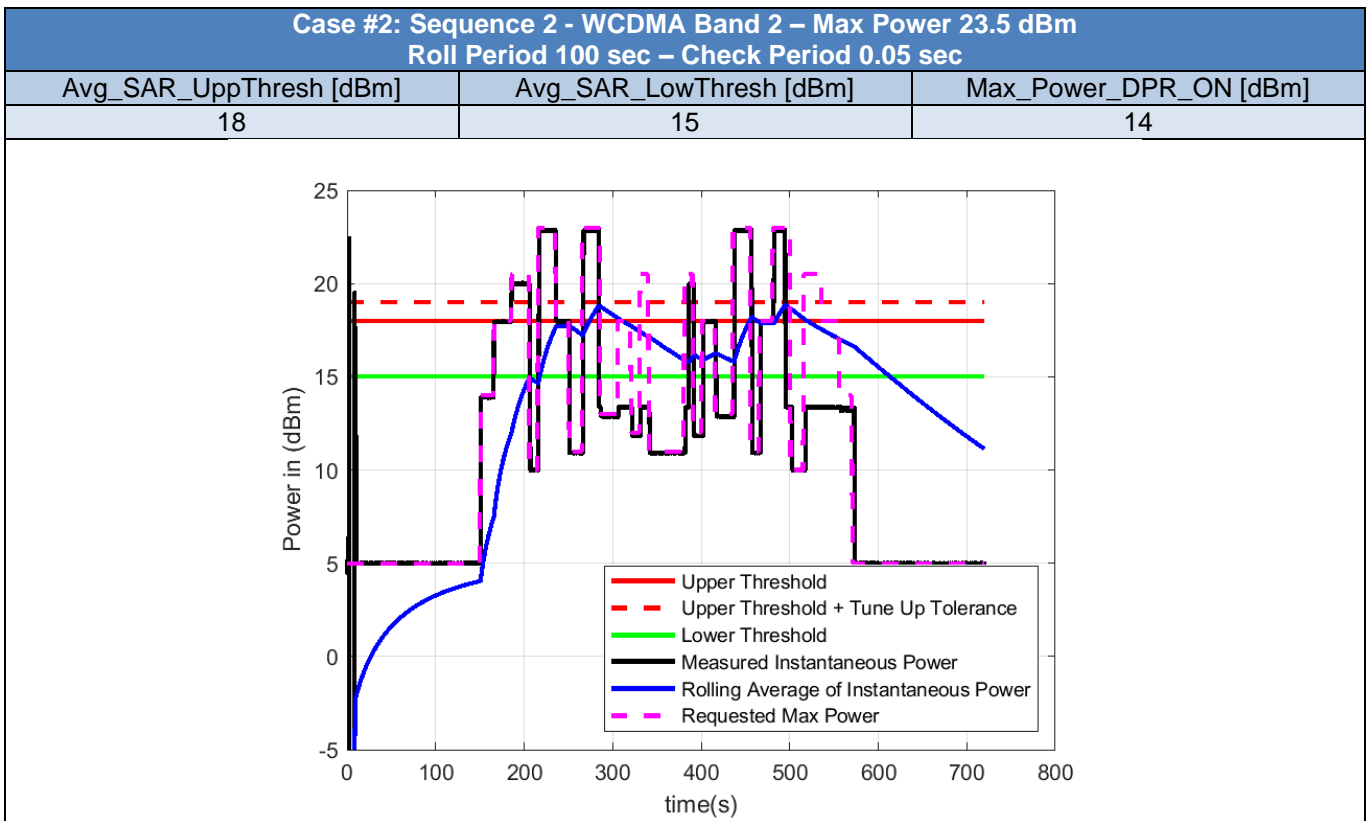
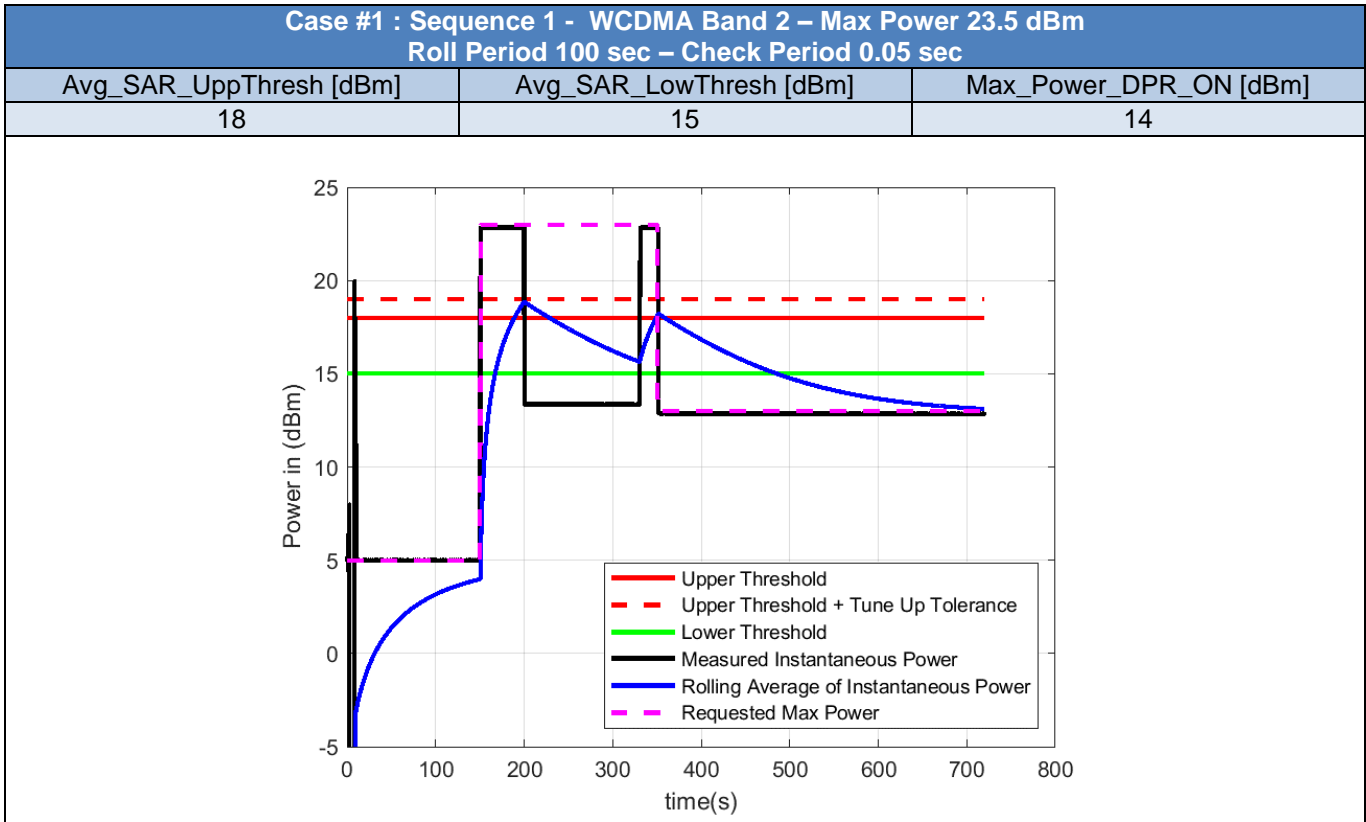

2.11. Handover - LTE-LTE

Table 10 - Test Cases for Handover of LTE-LTE bands

Case	RAT	Band	Max_Power_DPR_OFF_dBm	Roll_Period_s	Check_Period_s	Avg_SAR_UppThresh_dBm	Avg_SAR_LowThresh_dBm	Max_Power_DPR_ON_dBm
1	LTE	2	23	100	0.05	20	17	16
	LTE	4	23	100	0.05	20	17	16

Note: The Average power is calculated using the measured instantaneous power and compared to the UpperThreshold Plus Tune-Up Tolerance. This is applied for all the test cases in this report.

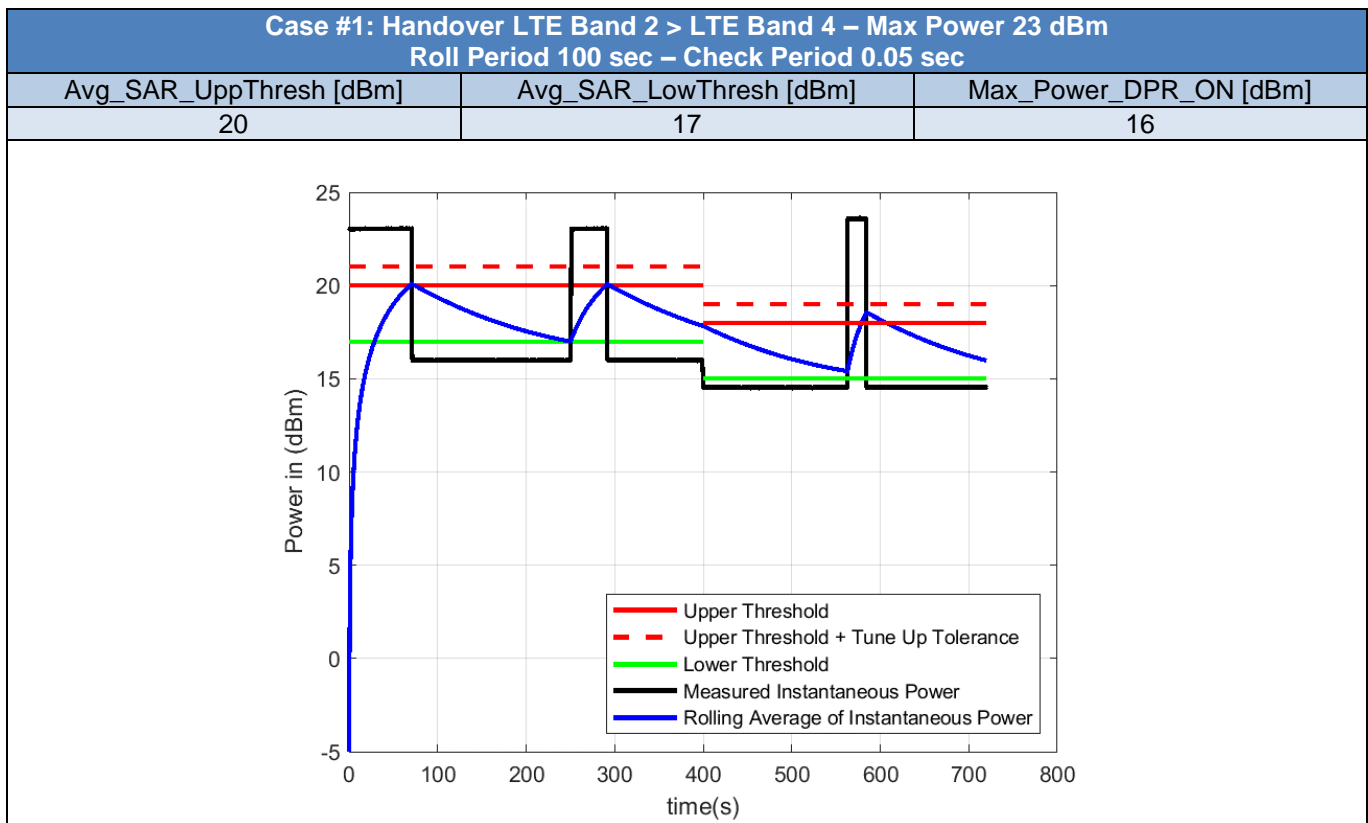

2.12. Handover - LTE-WCDMA

Table 11 - Test Cases for Handover of LTE-WCDMA bands

Case	RAT	Band	Max_Power_DPR_OFF_dBm	Roll_Period_s	Check_Period_s	Avg_SAR_UppThresh_dBm	Avg_SAR_LowThresh_dBm	Max_Power_DPR_ON_dBm
1	LTE	2	23.5	100	0.05	20	17	16
	WCDMA	4	23.5	100	0.05	18	15	14

Note: The Average power is calculated using the measured instantaneous power and compared to the UpperThreshold Plus Tune-Up Tolerance. This is applied for all the test cases in this report.

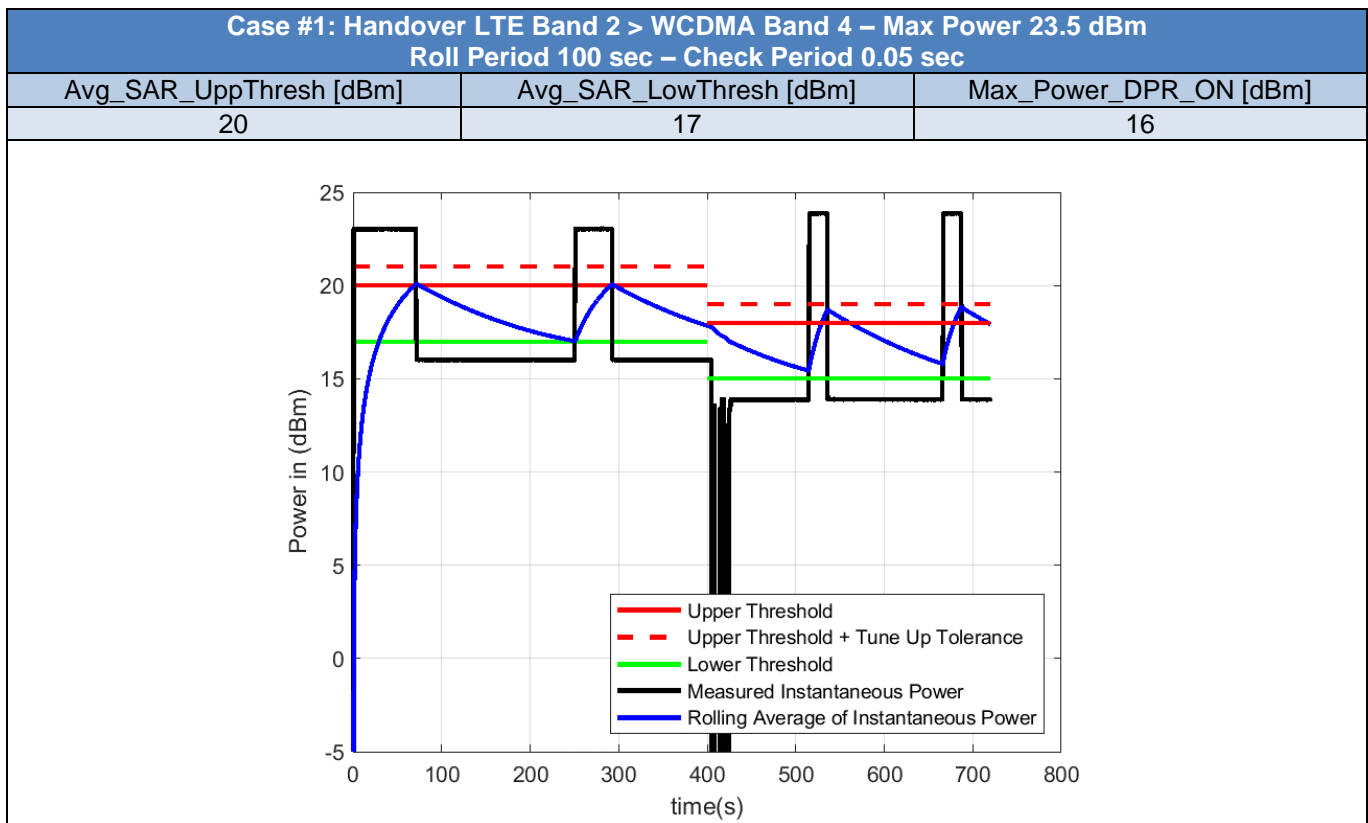

2.13. Call Drop and Reboot - NR

Table 12 - Test Cases for Call Drop and Reboot of NR bands

Case	RAT	Band	Max_Power_ DPR_OFF	Roll_Period	Check_Perio d	Avg_SAR_Up pThresh	Avg_SAR_Lo wThresh	Max_Power_ DPR_ON
1	NR	5	23	100	0.05	18	15	14
2	NR	5	23	100	0.05	18	15	14

Note: The Average power is calculated using the measured instantaneous power and compared to the UpperThreshold Plus Tune-Up Tolerance. This is applied for all the test cases in this report.

Case #1: Call Drop - NR Band 5 – Max Power 23 dBm – Roll Period 100 sec – Check Period 0.05 sec		
Avg_SAR_UppThresh [dBm]	Avg_SAR_LowThresh [dBm]	Max_Power_DPR_ON [dBm]
18	15	14

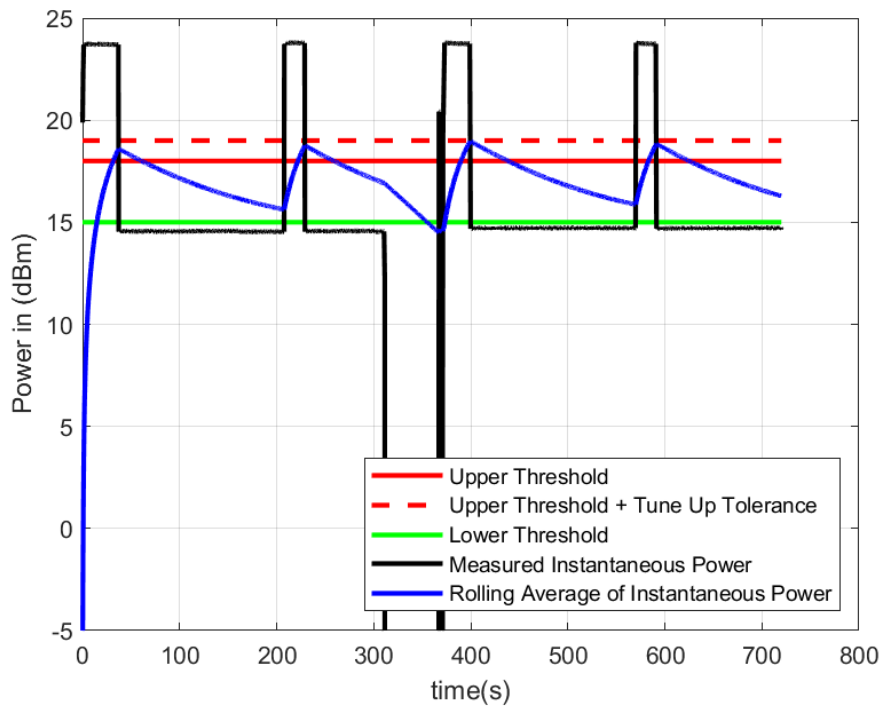

Case #2: Reboot - NR Band 5 – Max Power 23 dBm – Roll Period 100 sec – Check Period 0.05 sec		
Avg_SAR_UppThresh [dBm]	Avg_SAR_LowThresh [dBm]	Max_Power_DPR_ON [dBm]
18	15	14

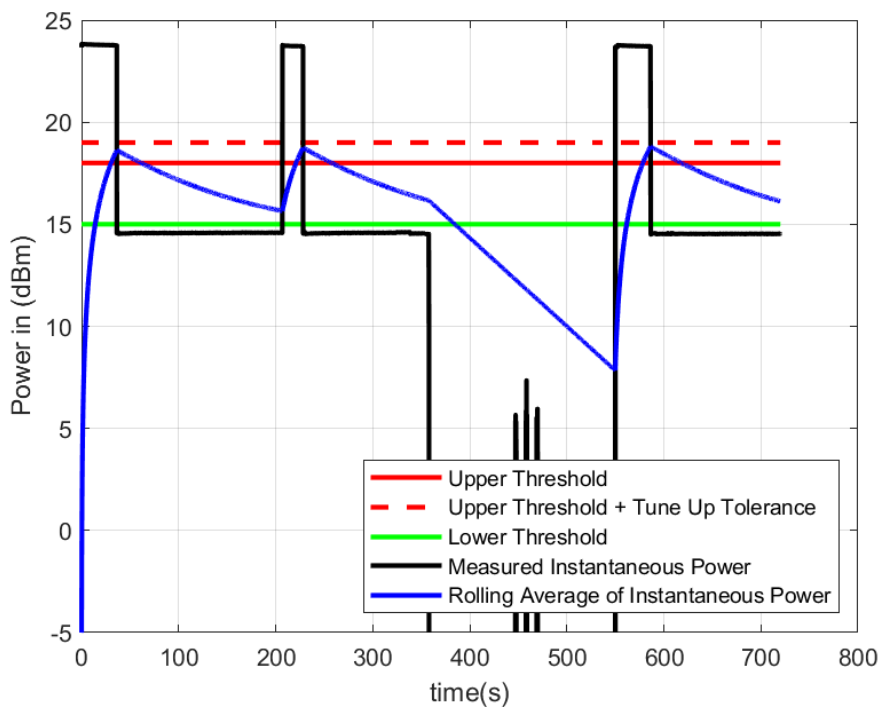

3. Conclusion

The TAS functionality of FM350-GL Module Integrated inside HP Model TPN-W155 convertible is tested. All test cases and corresponding test configurations work properly.