



FCC SAR TEST REPORT

FCC ID : B94-MT7921F
Equipment : 2TX 11ax (WiFi6) + BLE Combo Card
Brand Name : HP
Model Name : MT7921
Applicant : HP Inc.
1501 Page Mill Road, Palo Alto CA, 94304, USA
Standard : FCC 47 CFR Part 2 (2.1093)

The product was installed into Convertible PC (Brand Name HP, Model Name: TPN-C154) during test.

The product was received on Jan. 12, 2022 and testing was started from Jan. 16, 2022 and completed on Jan. 20, 2022. We, SPORTON INTERNATIONAL INC., would like to declare that the tested sample provide by manufacturer and the test data has been evaluated in accordance with the test procedures given in 47 CFR Part 2.1093 and FCC KDB and has been pass the FCC requirement.

The test results in this report apply exclusively to the tested model / sample. Without written approval of SPORTON INTERNATIONAL INC. EMC & Wireless Communications Laboratory, the test report shall not be reproduced except in full.

Approved by: Cona Huang / Deputy Manager



Sporton International Inc. EMC & Wireless Communications Laboratory
No.52, Huaya 1st Rd., Guishan Dist., Taoyuan City 333, Taiwan



Table of Contents

1. Statement of Compliance 4

2. Guidance Applied..... 4

3. Equipment Under Test (EUT) Information..... 5

 3.1 General Information 5

 3.2 Sensor Triggering angle and power verification 6

4. RF Exposure Limits.....14

 4.1 Uncontrolled Environment.....14

 4.2 Controlled Environment.....14

5. Specific Absorption Rate (SAR).....15

 5.1 Introduction15

 5.2 SAR Definition.....15

6. System Description and Setup16

 6.1 Test Site Location.....16

 6.2 E-Field Probe17

 6.3 Data Acquisition Electronics (DAE)17

 6.4 Phantom.....18

 6.5 Device Holder.....19

7. Measurement Procedures20

 7.1 Spatial Peak SAR Evaluation20

 7.2 Power Reference Measurement.....21

 7.3 Area Scan21

 7.4 Zoom Scan.....22

 7.5 Volume Scan Procedures.....22

 7.6 Power Drift Monitoring.....22

8. Test Equipment List23

9. System Verification24

 9.1 Tissue Verification24

 9.2 System Performance Check Results.....25

10. RF Exposure Positions25

 10.1 SAR Testing for Tablet.....25

11. WiFi/Bluetooth Output Power (Unit: dBm)26

12. Antenna Location39

13. SAR Test Results42

 13.1 Body SAR43

14. Simultaneous Transmission Analysis44

 14.1 Body Exposure Conditions44

15. Uncertainty Assessment45

16. References.....45

Appendix A. Plots of System Performance Check

Appendix B. Plots of High SAR Measurement

Appendix C. DASYS Calibration Certificate

Appendix D. Test Setup Photos



1. Statement of Compliance

The maximum results of Specific Absorption Rate (SAR) found during testing for HP Inc., 2TX 11ax (WiFi6) + BLE Combo Card, MT7921, are as follows.

Equipment Class	Frequency Band		Highest SAR Summary		
			Body		Highest Simultaneous Transmission 1g SAR (W/kg)
			1g SAR (W/kg)		
DTS	WLAN	2.4GHz WLAN	0.30	0.30	
NII		5GHz WLAN	0.88	0.92	
DSS	2.4GHz Band	Bluetooth	0.05	0.92	
Date of Testing:			2022/1/16 ~ 2022/1/20		

Sporton Lab is accredited to ISO 17025 by Taiwan Accreditation Foundation (TAF code: 1190) and the FCC designation No. TW1190 under the FCC 2.948(e) by Mutual Recognition Agreement (MRA) in FCC test. This device is in compliance with Specific Absorption Rate (SAR) for general population/uncontrolled exposure limits (1.6 W/kg for Partial-Body 1g SAR) specified in FCC 47 CFR part 2 (2.1093) and ANSI/IEEE C95.1-1992, and had been tested in accordance with the measurement methods and procedures specified in IEEE 1528-2013 and FCC KDB publications

Reviewed by: Jason Wang
Report Producer: Daisy Peng

2. Guidance Applied

The Specific Absorption Rate (SAR) testing specification, method, and procedure for this device is in accordance with the following standards, the below KDB standard may not including in the TAF code without accreditation.

- FCC 47 CFR Part 2 (2.1093)
- ANSI/IEEE C95.1-1992
- IEEE 1528-2013
- FCC KDB 865664 D01 SAR Measurement 100 MHz to 6 GHz v01r04
- FCC KDB 865664 D02 SAR Reporting v01r02
- FCC KDB 447498 D01 General RF Exposure Guidance v06
- FCC KDB 248227 D01 802.11 Wi-Fi SAR v02r02
- FCC KDB 616217 D04 SAR for laptop and tablets v01r02



3. Equipment Under Test (EUT) Information

3.1 General Information

Product Feature & Specification	
Equipment Name	2TX 11ax (WiFi6) + BLE Combo Card
Brand Name	HP
Model Name	MT7921
FCC ID	B94-MT7921F
Wireless Technology and Frequency Range	WLAN 2.4 GHz Band: 2400 MHz ~ 2483.5 MHz WLAN 5.2 GHz Band: 5150 MHz ~ 5250 MHz WLAN 5.3 GHz Band: 5250 MHz ~ 5350 MHz WLAN 5.6 GHz Band: 5470 MHz ~ 5725 MHz WLAN 5.8 GHz Band: 5725 MHz ~ 5850 MHz Bluetooth: 2400 MHz ~ 2483.5 MHz
Mode	WLAN: 802.11a/b/g/n/ac/ax HT20/HT40/VHT20/VHT40/VHT80/VHT160/HE20/HE40/HE80/HE160 Bluetooth BR/EDR/LE
Remark:	
1. This device is convertible type notebook PC, and there have Laptop and Tablet two usage way, when end user is used different mode which the device will according current mode to limit different maximum power.	

Host Information	
Equipment Name	Convertible PC
Brand Name	HP
Model Name	TPN-C154
EUT Stage	Production Unit

WLAN Antenna Information									
	Ant. Type	PIFA	connector	I-PEX MHF-4L		Ant. Type	PIFA	connector	I-PEX MHF-4L
	1 TB	Model No.	Main: DC33002JZ00 (WA-P-LBLB-02-128) Aux: DC33002JZ00 (WA-P-LBLB-02-128)			2 NB	Model No.	Main: DC33002JZ00 (WA-P-LBLB-02-128) Aux: DC33002JZ00 (WA-P-LBLB-02-128)	
Peak Gain (dBi)				Peak Gain (dBi)					
2400~2483.5MHz		Main:-1.77 Aux:-1.74	5470~5725MHz	Main:-1.61 Aux:-1.49	2400~2483.5MHz		Main:2.77 Aux:2.68	5470~5725MHz	Main:2.49 Aux:2.66
5150~5250MHz		Main:-0.89 Aux:1.6	5725~5850MHz	Main:-1.74 Aux:-1.67	5150~5250MHz		Main:2.75 Aux:2.77	5725~5850MHz	Main:2.62 Aux:2.66
5250~5350MHz		Main:-0.89 Aux:1.6	5925~7125MHz	Main:-0.09 Aux:-1.25	5250~5350MHz		Main:2.75 Aux:2.49	5925~7125MHz	Main:2.72 Aux:2.72



3.2 Sensor Triggering angle and power verification

General Note:

- The following guidance should be applied to laptops/tablets that use Hall Effect or gravity sensors to detect lid angle for the purpose of power reduction:

- Step 1: With the lid is in closed mode (0 degrees), open the screen in 10 degree steps until laptop mode is obtained
- Step 2: Lower the screen 5 degrees. Closed mode should be reobtained. If not keep lowering in 5 degree steps
- Step 3: Open the screen in 1 degree steps until laptop mode is reobtained
- Step 4: Continue opening the screen in 1 degree steps until at least 5 degrees past where laptop mode was obtained
- Step 5: Then continue opening the screen in 10 degree steps until tablet mode is obtained
- Step 6: Power measurements should be taken at each step
- Step 7: Reverse this procedure going from tablet mode back down to closed mode

when the screen angle is from 0 degree to 360 degree									
Screen angle (degree) v.s. power	Wireless		WLAN Ant 1+2				Ant 1		
	Band		2.4GHz WLAN	5.2GHz WLAN	5.3GHz WLAN	5.5GHz WLAN	5.8GHz WLAN	Bluetooth	
Lid Close	0	standby	standby	standby	standby	standby	standby	standby	
	10	standby	standby	standby	standby	standby	standby	standby	
	20	standby	standby	standby	standby	standby	standby	standby	
	30	standby	standby	standby	standby	standby	standby	standby	
	31	standby	standby	standby	standby	standby	standby	standby	
	32	standby	standby	standby	standby	standby	standby	standby	
	33	standby	standby	standby	standby	standby	standby	standby	
	34	standby	standby	standby	standby	standby	standby	standby	
	Laptop	35	22.0	20.0	21.5	21.5	21.5	21.5	11.5
		36	22.0	20.0	21.5	21.5	21.5	21.5	11.5
		37	22.0	20.0	21.5	21.5	21.5	21.5	11.5
		38	22.0	20.0	21.5	21.5	21.5	21.5	11.5
		39	22.0	20.0	21.5	21.5	21.5	21.5	11.5
		40	22.0	20.0	21.5	21.5	21.5	21.5	11.5
		50	22.0	20.0	21.5	21.5	21.5	21.5	11.5
		60	22.0	20.0	21.5	21.5	21.5	21.5	11.5
		70	22.0	20.0	21.5	21.5	21.5	21.5	11.5
		80	22.0	20.0	21.5	21.5	21.5	21.5	11.5
		90	22.0	20.0	21.5	21.5	21.5	21.5	11.5
		100	22.0	20.0	21.5	21.5	21.5	21.5	11.5
		110	22.0	20.0	21.5	21.5	21.5	21.5	11.5
120		22.0	20.0	21.5	21.5	21.5	21.5	11.5	
130		22.0	20.0	21.5	21.5	21.5	21.5	11.5	
140	22.0	20.0	21.5	21.5	21.5	21.5	11.5		
Tablet	150	22.0	20.0	21.5	21.5	21.5	21.5	11.5	
	155	22.0	20.0	21.5	21.5	21.5	21.5	11.5	
	156	22.0	20.0	21.5	21.5	21.5	21.5	11.5	
	157	22.0	20.0	21.5	21.5	21.5	21.5	11.5	
	158	22.0	20.0	21.5	21.5	21.5	21.5	11.5	
	159	22.0	20.0	21.5	21.5	21.5	21.5	11.5	
	160	19.0	16.0	16.0	16.0	16.0	16.0	6.0	
	161	19.0	16.0	16.0	16.0	16.0	16.0	6.0	
	162	19.0	16.0	16.0	16.0	16.0	16.0	6.0	
	163	19.0	16.0	16.0	16.0	16.0	16.0	6.0	
210	19.0	16.0	16.0	16.0	16.0	16.0	6.0		



		220	19.0	16.0	16.0	16.0	16.0	6.0	
		230	19.0	16.0	16.0	16.0	16.0	6.0	
		240	19.0	16.0	16.0	16.0	16.0	6.0	
		250	19.0	16.0	16.0	16.0	16.0	6.0	
		260	19.0	16.0	16.0	16.0	16.0	6.0	
		270	19.0	16.0	16.0	16.0	16.0	6.0	
		280	19.0	16.0	16.0	16.0	16.0	6.0	
		290	19.0	16.0	16.0	16.0	16.0	6.0	
		300	19.0	16.0	16.0	16.0	16.0	6.0	
		310	19.0	16.0	16.0	16.0	16.0	6.0	
		320	19.0	16.0	16.0	16.0	16.0	6.0	
		330	19.0	16.0	16.0	16.0	16.0	6.0	
		340	19.0	16.0	16.0	16.0	16.0	6.0	
		350	19.0	16.0	16.0	16.0	16.0	6.0	
		360	19.0	16.0	16.0	16.0	16.0	6.0	
			Tablet	195	19.0	16.0	16.0	16.0	16.0
		196		19.0	16.0	16.0	16.0	16.0	6.0
		197		19.0	16.0	16.0	16.0	16.0	6.0
		198		19.0	16.0	16.0	16.0	16.0	6.0
		199		19.0	16.0	16.0	16.0	16.0	6.0
			200	19.0	16.0	16.0	16.0	16.0	6.0
		Stand mode (Screen orientation is set to 0° and base is horizontal)	201	22.0	20.0	21.5	21.5	21.5	11.5
			202	22.0	20.0	21.5	21.5	21.5	11.5
			203	22.0	20.0	21.5	21.5	21.5	11.5
			204	22.0	20.0	21.5	21.5	21.5	11.5
			205	22.0	20.0	21.5	21.5	21.5	11.5
			210	22.0	20.0	21.5	21.5	21.5	11.5
			220	22.0	20.0	21.5	21.5	21.5	11.5
			230	22.0	20.0	21.5	21.5	21.5	11.5
			240	22.0	20.0	21.5	21.5	21.5	11.5
			250	22.0	20.0	21.5	21.5	21.5	11.5
			260	22.0	20.0	21.5	21.5	21.5	11.5
			270	22.0	20.0	21.5	21.5	21.5	11.5
			280	22.0	20.0	21.5	21.5	21.5	11.5
			290	22.0	20.0	21.5	21.5	21.5	11.5
			300	22.0	20.0	21.5	21.5	21.5	11.5
			310	22.0	20.0	21.5	21.5	21.5	11.5
			320	22.0	20.0	21.5	21.5	21.5	11.5
			330	22.0	20.0	21.5	21.5	21.5	11.5
			335	22.0	20.0	21.5	21.5	21.5	11.5
			336	22.0	20.0	21.5	21.5	21.5	11.5
		337	22.0	20.0	21.5	21.5	21.5	11.5	
		338	22.0	20.0	21.5	21.5	21.5	11.5	
		339	22.0	20.0	21.5	21.5	21.5	11.5	
		340	22.0	20.0	21.5	21.5	21.5	11.5	
	Tablet	341	19.0	16.0	16.0	16.0	16.0	6.0	
		342	19.0	16.0	16.0	16.0	16.0	6.0	
		343	19.0	16.0	16.0	16.0	16.0	6.0	
		344	19.0	16.0	16.0	16.0	16.0	6.0	
		345	19.0	16.0	16.0	16.0	16.0	6.0	
		350	19.0	16.0	16.0	16.0	16.0	6.0	
	360	19.0	16.0	16.0	16.0	16.0	6.0		
	Tablet	195	19.0	16.0	16.0	16.0	16.0	6.0	
		196	19.0	16.0	16.0	16.0	16.0	6.0	
		197	19.0	16.0	16.0	16.0	16.0	6.0	
		198	19.0	16.0	16.0	16.0	16.0	6.0	



Tent mode (Screen orientation is set to 180° and base is not horizontal)	199	19.0	16.0	16.0	16.0	16.0	6.0	
	200	19.0	16.0	16.0	16.0	16.0	6.0	
	201	19.0	16.0	16.0	16.0	16.0	6.0	
	202	19.0	16.0	16.0	16.0	16.0	6.0	
	203	19.0	16.0	16.0	16.0	16.0	6.0	
	204	19.0	16.0	16.0	16.0	16.0	6.0	
	205	19.0	16.0	16.0	16.0	16.0	6.0	
	210	19.0	16.0	16.0	16.0	16.0	6.0	
	220	19.0	16.0	16.0	16.0	16.0	6.0	
	230	19.0	16.0	16.0	16.0	16.0	6.0	
	240	19.0	16.0	16.0	16.0	16.0	6.0	
	250	19.0	16.0	16.0	16.0	16.0	6.0	
	260	19.0	16.0	16.0	16.0	16.0	6.0	
	270	19.0	16.0	16.0	16.0	16.0	6.0	
	280	19.0	16.0	16.0	16.0	16.0	6.0	
	290	19.0	16.0	16.0	16.0	16.0	6.0	
	300	19.0	16.0	16.0	16.0	16.0	6.0	
	310	19.0	16.0	16.0	16.0	16.0	6.0	
	320	19.0	16.0	16.0	16.0	16.0	6.0	
	330	19.0	16.0	16.0	16.0	16.0	6.0	
	335	19.0	16.0	16.0	16.0	16.0	6.0	
	336	19.0	16.0	16.0	16.0	16.0	6.0	
	337	19.0	16.0	16.0	16.0	16.0	6.0	
	338	19.0	16.0	16.0	16.0	16.0	6.0	
	339	19.0	16.0	16.0	16.0	16.0	6.0	
	340	19.0	16.0	16.0	16.0	16.0	6.0	
	Tablet	341	19.0	16.0	16.0	16.0	16.0	6.0
		342	19.0	16.0	16.0	16.0	16.0	6.0
		343	19.0	16.0	16.0	16.0	16.0	6.0
		344	19.0	16.0	16.0	16.0	16.0	6.0
		345	19.0	16.0	16.0	16.0	16.0	6.0
		350	19.0	16.0	16.0	16.0	16.0	6.0
		360	19.0	16.0	16.0	16.0	16.0	6.0
	Lid Close	0	standby	standby	standby	standby	standby	standby
		10	standby	standby	standby	standby	standby	standby
		20	standby	standby	standby	standby	standby	standby
		30	standby	standby	standby	standby	standby	standby
		31	standby	standby	standby	standby	standby	standby
		32	standby	standby	standby	standby	standby	standby
		33	standby	standby	standby	standby	standby	standby
		34	standby	standby	standby	standby	standby	standby
	Book (screen orientation is 90° or 270°)	35	19.0	16.0	16.0	16.0	16.0	6.0
		36	19.0	16.0	16.0	16.0	16.0	6.0
		37	19.0	16.0	16.0	16.0	16.0	6.0
38		19.0	16.0	16.0	16.0	16.0	6.0	
39		19.0	16.0	16.0	16.0	16.0	6.0	
40		19.0	16.0	16.0	16.0	16.0	6.0	
50		19.0	16.0	16.0	16.0	16.0	6.0	
60		19.0	16.0	16.0	16.0	16.0	6.0	
70		19.0	16.0	16.0	16.0	16.0	6.0	
80		19.0	16.0	16.0	16.0	16.0	6.0	
90		19.0	16.0	16.0	16.0	16.0	6.0	
100		19.0	16.0	16.0	16.0	16.0	6.0	
110		19.0	16.0	16.0	16.0	16.0	6.0	
120	19.0	16.0	16.0	16.0	16.0	6.0		
120	19.0	16.0	16.0	16.0	16.0	6.0		



Tablet	130	19.0	16.0	16.0	16.0	16.0	6.0
	140	19.0	16.0	16.0	16.0	16.0	6.0
	150	19.0	16.0	16.0	16.0	16.0	6.0
	160	19.0	16.0	16.0	16.0	16.0	6.0
	170	19.0	16.0	16.0	16.0	16.0	6.0
	180	19.0	16.0	16.0	16.0	16.0	6.0
	190	19.0	16.0	16.0	16.0	16.0	6.0
	195	19.0	16.0	16.0	16.0	16.0	6.0
	196	19.0	16.0	16.0	16.0	16.0	6.0
	197	19.0	16.0	16.0	16.0	16.0	6.0
	198	19.0	16.0	16.0	16.0	16.0	6.0
	199	19.0	16.0	16.0	16.0	16.0	6.0
	200	19.0	16.0	16.0	16.0	16.0	6.0
	201	19.0	16.0	16.0	16.0	16.0	6.0
	202	19.0	16.0	16.0	16.0	16.0	6.0
	203	19.0	16.0	16.0	16.0	16.0	6.0
	204	19.0	16.0	16.0	16.0	16.0	6.0
	205	19.0	16.0	16.0	16.0	16.0	6.0
	210	19.0	16.0	16.0	16.0	16.0	6.0
	220	19.0	16.0	16.0	16.0	16.0	6.0
	230	19.0	16.0	16.0	16.0	16.0	6.0
	240	19.0	16.0	16.0	16.0	16.0	6.0
	250	19.0	16.0	16.0	16.0	16.0	6.0
	260	19.0	16.0	16.0	16.0	16.0	6.0
	270	19.0	16.0	16.0	16.0	16.0	6.0
	280	19.0	16.0	16.0	16.0	16.0	6.0
	290	19.0	16.0	16.0	16.0	16.0	6.0
	300	19.0	16.0	16.0	16.0	16.0	6.0
	310	19.0	16.0	16.0	16.0	16.0	6.0
	320	19.0	16.0	16.0	16.0	16.0	6.0
	330	19.0	16.0	16.0	16.0	16.0	6.0
	340	19.0	16.0	16.0	16.0	16.0	6.0
	350	19.0	16.0	16.0	16.0	16.0	6.0
	360	19.0	16.0	16.0	16.0	16.0	6.0



when the screen angle is from 0 degree to 360 degree								
Screen angle (degree) v.s. power	Wireless		WLAN Ant 1+2					Ant 1
	Band		2.4GHz WLAN	5.2GHz WLAN	5.3GHz WLAN	5.5GHz WLAN	5.8GHz WLAN	Bluetooth
	Tablet Mode							
	360	19.0	16.0	16.0	16.0	16.0	16.0	6.0
	350	19.0	16.0	16.0	16.0	16.0	16.0	6.0
	340	19.0	16.0	16.0	16.0	16.0	16.0	6.0
	330	19.0	16.0	16.0	16.0	16.0	16.0	6.0
	320	19.0	16.0	16.0	16.0	16.0	16.0	6.0
	310	19.0	16.0	16.0	16.0	16.0	16.0	6.0
	300	19.0	16.0	16.0	16.0	16.0	16.0	6.0
	290	19.0	16.0	16.0	16.0	16.0	16.0	6.0
	280	19.0	16.0	16.0	16.0	16.0	16.0	6.0
	270	19.0	16.0	16.0	16.0	16.0	16.0	6.0
	260	19.0	16.0	16.0	16.0	16.0	16.0	6.0
	250	19.0	16.0	16.0	16.0	16.0	16.0	6.0
	240	19.0	16.0	16.0	16.0	16.0	16.0	6.0
	230	19.0	16.0	16.0	16.0	16.0	16.0	6.0
	220	19.0	16.0	16.0	16.0	16.0	16.0	6.0
	210	19.0	16.0	16.0	16.0	16.0	16.0	6.0
	200	19.0	16.0	16.0	16.0	16.0	16.0	6.0
	190	19.0	16.0	16.0	16.0	16.0	16.0	6.0
	180	19.0	16.0	16.0	16.0	16.0	16.0	6.0
	170	19.0	16.0	16.0	16.0	16.0	16.0	6.0
	165	19.0	16.0	16.0	16.0	16.0	16.0	6.0
	164	19.0	16.0	16.0	16.0	16.0	16.0	6.0
	163	19.0	16.0	16.0	16.0	16.0	16.0	6.0
	162	19.0	16.0	16.0	16.0	16.0	16.0	6.0
	161	19.0	16.0	16.0	16.0	16.0	16.0	6.0
	160	19.0	16.0	16.0	16.0	16.0	16.0	6.0
	159	22.0	20.0	21.5	21.5	21.5	21.5	11.5
	158	22.0	20.0	21.5	21.5	21.5	21.5	11.5
	157	22.0	20.0	21.5	21.5	21.5	21.5	11.5
	156	22.0	20.0	21.5	21.5	21.5	21.5	11.5
	155	22.0	20.0	21.5	21.5	21.5	21.5	11.5
	150	22.0	20.0	21.5	21.5	21.5	21.5	11.5
	140	22.0	20.0	21.5	21.5	21.5	21.5	11.5
	130	22.0	20.0	21.5	21.5	21.5	21.5	11.5
	120	22.0	20.0	21.5	21.5	21.5	21.5	11.5
	110	22.0	20.0	21.5	21.5	21.5	21.5	11.5
	100	22.0	20.0	21.5	21.5	21.5	21.5	11.5
	90	22.0	20.0	21.5	21.5	21.5	21.5	11.5
	80	22.0	20.0	21.5	21.5	21.5	21.5	11.5
	70	22.0	20.0	21.5	21.5	21.5	21.5	11.5
	60	22.0	20.0	21.5	21.5	21.5	21.5	11.5
	50	22.0	20.0	21.5	21.5	21.5	21.5	11.5
	40	22.0	20.0	21.5	21.5	21.5	21.5	11.5
	39	22.0	20.0	21.5	21.5	21.5	21.5	11.5
	38	22.0	20.0	21.5	21.5	21.5	21.5	11.5
	37	22.0	20.0	21.5	21.5	21.5	21.5	11.5
	36	22.0	20.0	21.5	21.5	21.5	21.5	11.5
	Laptop							



SPORTON LAB.	Lid Close	35	22.0	20.0	21.5	21.5	21.5	11.5	
		34	standby	standby	standby	standby	standby	standby	standby
		33	standby	standby	standby	standby	standby	standby	standby
		32	standby	standby	standby	standby	standby	standby	standby
		31	standby	standby	standby	standby	standby	standby	standby
		30	standby	standby	standby	standby	standby	standby	standby
		20	standby	standby	standby	standby	standby	standby	standby
		10	standby	standby	standby	standby	standby	standby	standby
		0	standby	standby	standby	standby	standby	standby	standby
	Tablet	360	19.0	16.0	16.0	16.0	16.0	16.0	6.0
		350	19.0	16.0	16.0	16.0	16.0	16.0	6.0
		345	19.0	16.0	16.0	16.0	16.0	16.0	6.0
		344	19.0	16.0	16.0	16.0	16.0	16.0	6.0
		343	19.0	16.0	16.0	16.0	16.0	16.0	6.0
		342	19.0	16.0	16.0	16.0	16.0	16.0	6.0
		341	19.0	16.0	16.0	16.0	16.0	16.0	6.0
	Stand mode (Screen orientation is set to 0° and base is horizontal)	340	22.0	20.0	21.0	21.5	21.5	21.5	11.5
		339	22.0	20.0	21.0	21.5	21.5	21.5	11.5
		338	22.0	20.0	21.0	21.5	21.5	21.5	11.5
		337	22.0	20.0	21.0	21.5	21.5	21.5	11.5
		336	22.0	20.0	21.0	21.5	21.5	21.5	11.5
		335	22.0	20.0	21.0	21.5	21.5	21.5	11.5
		330	22.0	20.0	21.5	21.5	21.5	21.5	11.5
		320	22.0	20.0	21.5	21.5	21.5	21.5	11.5
		310	22.0	20.0	21.5	21.5	21.5	21.5	11.5
		300	22.0	20.0	21.5	21.5	21.5	21.5	11.5
		290	22.0	20.0	21.5	21.5	21.5	21.5	11.5
		280	22.0	20.0	21.5	21.5	21.5	21.5	11.5
		270	22.0	20.0	21.5	21.5	21.5	21.5	11.5
		260	22.0	20.0	21.5	21.5	21.5	21.5	11.5
		250	22.0	20.0	21.5	21.5	21.5	21.5	11.5
		240	22.0	20.0	21.5	21.5	21.5	21.5	11.5
		230	22.0	20.0	21.5	21.5	21.5	21.5	11.5
		220	22.0	20.0	21.5	21.5	21.5	21.5	11.5
	210	22.0	20.0	21.5	21.5	21.5	21.5	11.5	
	205	22.0	20.0	21.5	21.5	21.5	21.5	11.5	
	204	22.0	20.0	21.5	21.5	21.5	21.5	11.5	
	203	22.0	20.0	21.5	21.5	21.5	21.5	11.5	
	202	22.0	20.0	21.5	21.5	21.5	21.5	11.5	
	201	22.0	20.0	21.5	21.5	21.5	21.5	11.5	
	Tablet	200	19.0	16.0	16.0	16.0	16.0	16.0	6.0
		199	19.0	16.0	16.0	16.0	16.0	16.0	6.0
198		19.0	16.0	16.0	16.0	16.0	16.0	6.0	
197		19.0	16.0	16.0	16.0	16.0	16.0	6.0	
196		19.0	16.0	16.0	16.0	16.0	16.0	6.0	
195		19.0	16.0	16.0	16.0	16.0	16.0	6.0	
Tablet	360	19.0	16.0	16.0	16.0	16.0	16.0	6.0	
	350	19.0	16.0	16.0	16.0	16.0	16.0	6.0	
	345	19.0	16.0	16.0	16.0	16.0	16.0	6.0	
	344	19.0	16.0	16.0	16.0	16.0	16.0	6.0	
	343	19.0	16.0	16.0	16.0	16.0	16.0	6.0	
342	19.0	16.0	16.0	16.0	16.0	16.0	6.0		



FCC SAR TEST REPORT

Report No. : FA1D0413

Tent mode (Screen orientation is set to 180° and base is not horizontal)	341	19.0	16.0	16.0	16.0	16.0	6.0	
	340	19.0	16.0	16.0	16.0	16.0	6.0	
	339	19.0	16.0	16.0	16.0	16.0	6.0	
	338	19.0	16.0	16.0	16.0	16.0	6.0	
	337	19.0	16.0	16.0	16.0	16.0	6.0	
	336	19.0	16.0	16.0	16.0	16.0	6.0	
	335	19.0	16.0	16.0	16.0	16.0	6.0	
	330	19.0	16.0	16.0	16.0	16.0	6.0	
	320	19.0	16.0	16.0	16.0	16.0	6.0	
	310	19.0	16.0	16.0	16.0	16.0	6.0	
	300	19.0	16.0	16.0	16.0	16.0	6.0	
	290	19.0	16.0	16.0	16.0	16.0	6.0	
	280	19.0	16.0	16.0	16.0	16.0	6.0	
	270	19.0	16.0	16.0	16.0	16.0	6.0	
	260	19.0	16.0	16.0	16.0	16.0	6.0	
	250	19.0	16.0	16.0	16.0	16.0	6.0	
	240	19.0	16.0	16.0	16.0	16.0	6.0	
	230	19.0	16.0	16.0	16.0	16.0	6.0	
	220	19.0	16.0	16.0	16.0	16.0	6.0	
	210	19.0	16.0	16.0	16.0	16.0	6.0	
	205	19.0	16.0	16.0	16.0	16.0	6.0	
	204	19.0	16.0	16.0	16.0	16.0	6.0	
	203	19.0	16.0	16.0	16.0	16.0	6.0	
	202	19.0	16.0	16.0	16.0	16.0	6.0	
	201	19.0	16.0	16.0	16.0	16.0	6.0	
	Tablet	200	19.0	16.0	16.0	16.0	16.0	6.0
		199	19.0	16.0	16.0	16.0	16.0	6.0
		198	19.0	16.0	16.0	16.0	16.0	6.0
		197	19.0	16.0	16.0	16.0	16.0	6.0
		196	19.0	16.0	16.0	16.0	16.0	6.0
	Tablet	195	19.0	16.0	16.0	16.0	16.0	6.0
		360	19.0	16.0	16.0	16.0	16.0	6.0
		350	19.0	16.0	16.0	16.0	16.0	6.0
		340	19.0	16.0	16.0	16.0	16.0	6.0
		330	19.0	16.0	16.0	16.0	16.0	6.0
		320	19.0	16.0	16.0	16.0	16.0	6.0
310		19.0	16.0	16.0	16.0	16.0	6.0	
300		19.0	16.0	16.0	16.0	16.0	6.0	
290		19.0	16.0	16.0	16.0	16.0	6.0	
280		19.0	16.0	16.0	16.0	16.0	6.0	
270		19.0	16.0	16.0	16.0	16.0	6.0	
260		19.0	16.0	16.0	16.0	16.0	6.0	
250		19.0	16.0	16.0	16.0	16.0	6.0	
240		19.0	16.0	16.0	16.0	16.0	6.0	
230		19.0	16.0	16.0	16.0	16.0	6.0	
220		19.0	16.0	16.0	16.0	16.0	6.0	
210	19.0	16.0	16.0	16.0	16.0	6.0		
205	19.0	16.0	16.0	16.0	16.0	6.0		
204	19.0	16.0	16.0	16.0	16.0	6.0		
203	19.0	16.0	16.0	16.0	16.0	6.0		
202	19.0	16.0	16.0	16.0	16.0	6.0		
201	19.0	16.0	16.0	16.0	16.0	6.0		



	Book (screen orientation is 90° or 270°)	200	19.0	16.0	16.0	16.0	16.0	6.0	
		199	19.0	16.0	16.0	16.0	16.0	16.0	6.0
		198	19.0	16.0	16.0	16.0	16.0	16.0	6.0
		197	19.0	16.0	16.0	16.0	16.0	16.0	6.0
		196	19.0	16.0	16.0	16.0	16.0	16.0	6.0
		195	19.0	16.0	16.0	16.0	16.0	16.0	6.0
		190	19.0	16.0	16.0	16.0	16.0	16.0	6.0
		180	19.0	16.0	16.0	16.0	16.0	16.0	6.0
		170	19.0	16.0	16.0	16.0	16.0	16.0	6.0
		160	19.0	16.0	16.0	16.0	16.0	16.0	6.0
		150	19.0	16.0	16.0	16.0	16.0	16.0	6.0
		140	19.0	16.0	16.0	16.0	16.0	16.0	6.0
		130	19.0	16.0	16.0	16.0	16.0	16.0	6.0
		120	19.0	16.0	16.0	16.0	16.0	16.0	6.0
		110	19.0	16.0	16.0	16.0	16.0	16.0	6.0
		100	19.0	16.0	16.0	16.0	16.0	16.0	6.0
		90	19.0	16.0	16.0	16.0	16.0	16.0	6.0
		80	19.0	16.0	16.0	16.0	16.0	16.0	6.0
		70	19.0	16.0	16.0	16.0	16.0	16.0	6.0
		60	19.0	16.0	16.0	16.0	16.0	16.0	6.0
	50	19.0	16.0	16.0	16.0	16.0	16.0	6.0	
	40	19.0	16.0	16.0	16.0	16.0	16.0	6.0	
	39	19.0	16.0	16.0	16.0	16.0	16.0	6.0	
	38	19.0	16.0	16.0	16.0	16.0	16.0	6.0	
	37	19.0	16.0	16.0	16.0	16.0	16.0	6.0	
	36	19.0	16.0	16.0	16.0	16.0	16.0	6.0	
	35	19.0	16.0	16.0	16.0	16.0	16.0	6.0	
	Lid Close	34	standby	standby	standby	standby	standby	standby	standby
		33	standby	standby	standby	standby	standby	standby	standby
		32	standby	standby	standby	standby	standby	standby	standby
		31	standby	standby	standby	standby	standby	standby	standby
		30	standby	standby	standby	standby	standby	standby	standby
		20	standby	standby	standby	standby	standby	standby	standby
		10	standby	standby	standby	standby	standby	standby	standby
	0	standby	standby	standby	standby	standby	standby	standby	



4. RF Exposure Limits

4.1 Uncontrolled Environment

Uncontrolled Environments are defined as locations where there is the exposure of individuals who have no knowledge or control of their exposure. The general population/uncontrolled exposure limits are applicable to situations in which the general public may be exposed or in which persons who are exposed as a consequence of their employment may not be made fully aware of the potential for exposure or cannot exercise control over their exposure. Members of the general public would come under this category when exposure is not employment-related; for example, in the case of a wireless transmitter that exposes persons in its vicinity.

4.2 Controlled Environment

Controlled Environments are defined as locations where there is exposure that may be incurred by persons who are aware of the potential for exposure, (i.e. as a result of employment or occupation). In general, occupational/controlled exposure limits are applicable to situations in which persons are exposed as a consequence of their employment, who have been made fully aware of the potential for exposure and can exercise control over their exposure. The exposure category is also applicable when the exposure is of a transient nature due to incidental passage through a location where the exposure levels may be higher than the general population/uncontrolled limits, but the exposed person is fully aware of the potential for exposure and can exercise control over his or her exposure by leaving the area or by some other appropriate means.

Limits for Occupational/Controlled Exposure (W/kg)

Whole-Body	Partial-Body	Hands, Wrists, Feet and Ankles
0.4	8.0	20.0

Limits for General Population/Uncontrolled Exposure (W/kg)

Whole-Body	Partial-Body	Hands, Wrists, Feet and Ankles
0.08	1.6	4.0

1. Whole-Body SAR is averaged over the entire body, partial-body SAR is averaged over any 1gram of tissue defined as a tissue volume in the shape of a cube. SAR for hands, wrists, feet and ankles is averaged over any 10 grams of tissue defined as a tissue volume in the shape of a cube.



5. Specific Absorption Rate (SAR)

5.1 Introduction

SAR is related to the rate at which energy is absorbed per unit mass in an object exposed to a radio field. The SAR distribution in a biological body is complicated and is usually carried out by experimental techniques or numerical modeling. The standard recommends limits for two tiers of groups, occupational/controlled and general population/uncontrolled, based on a person's awareness and ability to exercise control over his or her exposure. In general, occupational/controlled exposure limits are higher than the limits for general population/uncontrolled.

5.2 SAR Definition

The SAR definition is the time derivative (rate) of the incremental energy (dW) absorbed by (dissipated in) an incremental mass (dm) contained in a volume element (dv) of a given density (ρ). The equation description is as below:

$$SAR = \frac{d}{dt} \left(\frac{dW}{dm} \right) = \frac{d}{dt} \left(\frac{dW}{\rho dv} \right)$$

SAR is expressed in units of Watts per kilogram (W/kg)

$$SAR = \frac{\sigma |E|^2}{\rho}$$

Where: σ is the conductivity of the tissue, ρ is the mass density of the tissue and E is the RMS electrical field strength.

6. System Description and Setup

The DASY system used for performing compliance tests consists of the following items:

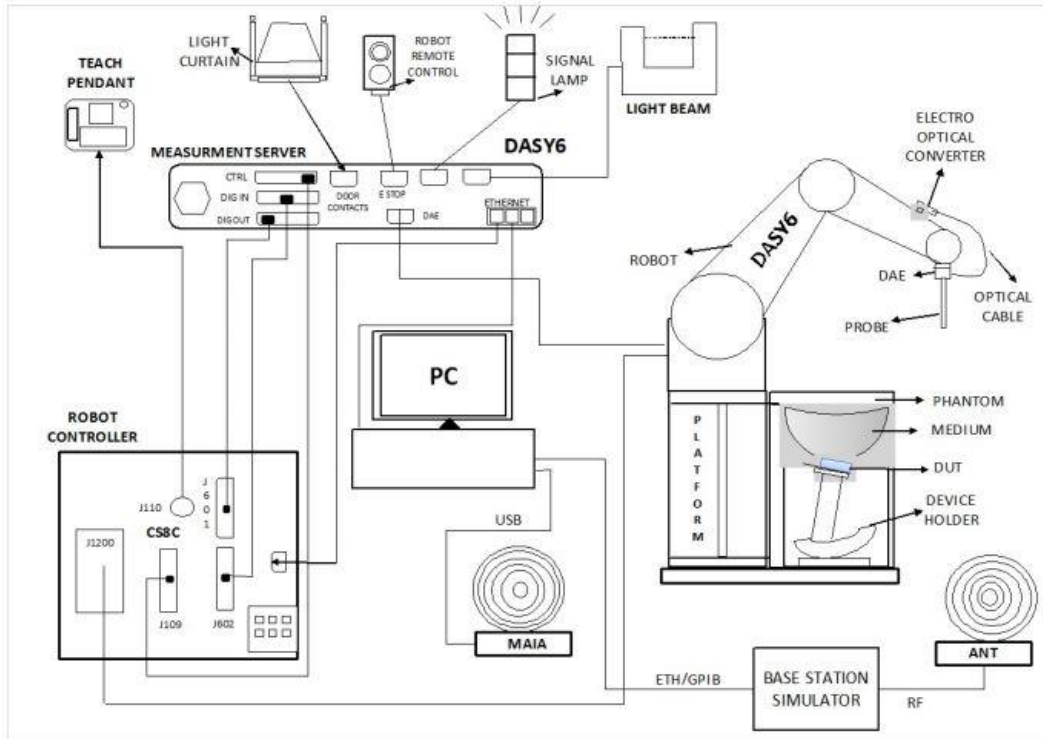

- The DASY system in DASY6/DASY5 V5.2 SAR Configuration is shown above
- A standard high precision 6-axis robot with controller, teach pendant and software. An arm extension for accommodating the data acquisition electronics (DAE).
- An isotropic Field probe optimized and calibrated for the targeted measurement.
- A data acquisition electronics (DAE) which performs the signal amplification, signal multiplexing, AD-conversion, offset measurements, mechanical surface detection, collision detection, etc. The unit is battery powered with standard or rechargeable batteries. The signal is optically transmitted to the EOC.
- The Electro-optical converter (EOC) performs the conversion from optical to electrical signals for the digital communication to the DAE. To use optical surface detection, a special version of the EOC is required. The EOC signal is transmitted to the measurement server.
- The function of the measurement server is to perform the time critical tasks such as signal filtering, control of the robot operation and fast movement interrupts.
- The Light Beam used is for probe alignment. This improves the (absolute) accuracy of the probe positioning.
- A computer running windows software and the DASY5/DASY6 software.
- Remote control and teach pendant as well as additional circuitry for robot safety such as warning lamps, etc.
- The phantom, the device holder and other accessories according to the targeted measurement.

6.1 Test Site Location

The SAR measurement facilities used to collect data are within both Sporton Lab list below test site location are accredited to ISO 17025 by Taiwan Accreditation Foundation (TAF code: 1190 and 3786) and the FCC designation No. TW1190 and TW3786 under the FCC 2.948(e) by Mutual Recognition Agreement (MRA) in FCC test.

Test Site	EMC & Wireless Communications Laboratory		Wensan Laboratory		
Test Site Location	TW1190 No.52, Huaya 1st Rd., Guishan Dist., Taoyuan City 333, Taiwan		TW3786 No.58, Aly. 75, Ln. 564, Wenhua 3rd, Rd., Guishan Dist., Taoyuan City 333010, Taiwan		
Test Site No.	SAR01-HY	SAR03-HY	SAR08-HY	SAR09-HY	SAR15-HY
	SAR04-HY	SAR05-HY	SAR11-HY	SAR12-HY	
	SAR06-HY	SAR10-HY	SAR13-HY	SAR14-HY	

6.2 E-Field Probe

The SAR measurement is conducted with the dosimetric probe (manufactured by SPEAG).The probe is specially designed and calibrated for use in liquid with high permittivity. The dosimetric probe has special calibration in liquid at different frequency. This probe has a built in optical surface detection system to prevent from collision with phantom.

<ES3DV3 Probe>

Construction	Symmetric design with triangular core Interleaved sensors Built-in shielding against static charges PEEK enclosure material (resistant to organic solvents, e.g., DGBE)	
Frequency	10 MHz – 4 GHz; Linearity: ± 0.2 dB (30 MHz – 4 GHz)	
Directivity	± 0.2 dB in TSL (rotation around probe axis) ± 0.3 dB in TSL (rotation normal to probe axis)	
Dynamic Range	5 μ W/g – >100 mW/g; Linearity: ± 0.2 dB	
Dimensions	Overall length: 337 mm (tip: 20 mm) Tip diameter: 3.9 mm (body: 12 mm) Distance from probe tip to dipole centers: 3.0 mm	

<EX3DV4 Probe>

Construction	Symmetric design with triangular core Built-in shielding against static charges PEEK enclosure material (resistant to organic solvents, e.g., DGBE)	
Frequency	10 MHz – >6 GHz Linearity: ± 0.2 dB (30 MHz – 6 GHz)	
Directivity	± 0.3 dB in TSL (rotation around probe axis) ± 0.5 dB in TSL (rotation normal to probe axis)	
Dynamic Range	10 μ W/g – >100 mW/g Linearity: ± 0.2 dB (noise: typically <1 μ W/g)	
Dimensions	Overall length: 337 mm (tip: 20 mm) Tip diameter: 2.5 mm (body: 12 mm) Typical distance from probe tip to dipole centers: 1 mm	

6.3 Data Acquisition Electronics (DAE)

The data acquisition electronics (DAE) consists of a highly sensitive electrometer-grade preamplifier with auto-zeroing, a channel and gain-switching multiplexer, a fast 16 bit AD-converter and a command decoder and control logic unit. Transmission to the measurement server is accomplished through an optical downlink for data and status information as well as an optical uplink for commands and the clock.

The input impedance of the DAE is 200 MOhm; the inputs are symmetrical and floating. Common mode rejection is above 80 dB.

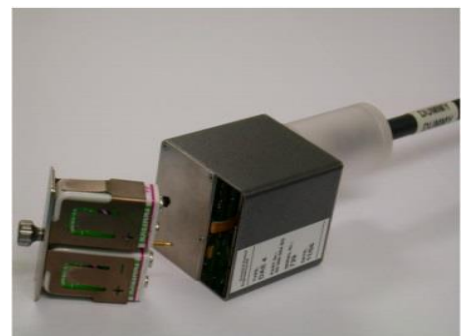



Fig 5.1 Photo of DAE

6.4 Phantom

<SAM Twin Phantom>

Shell Thickness	2 ± 0.2 mm; Center ear point: 6 ± 0.2 mm	
Filling Volume	Approx. 25 liters	
Dimensions	Length: 1000 mm; Width: 500 mm; Height: adjustable feet	
Measurement Areas	Left Hand, Right Hand, Flat Phantom	

The bottom plate contains three pair of bolts for locking the device holder. The device holder positions are adjusted to the standard measurement positions in the three sections. A white cover is provided to tap the phantom during off-periods to prevent water evaporation and changes in the liquid parameters. On the phantom top, three reference markers are provided to identify the phantom position with respect to the robot.

<ELI Phantom>

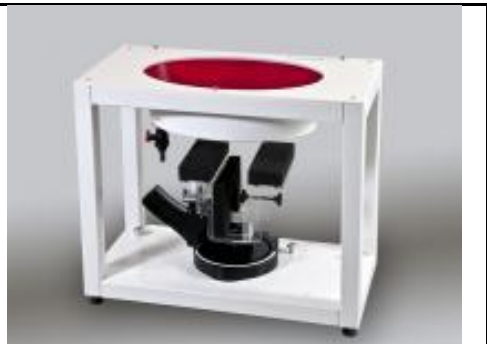
Shell Thickness	2 ± 0.2 mm (sagging: <1%)	
Filling Volume	Approx. 30 liters	
Dimensions	Major ellipse axis: 600 mm Minor axis: 400 mm	

The ELI phantom is intended for compliance testing of handheld and body-mounted wireless devices in the frequency range of 30 MHz to 6 GHz. ELI4 is fully compatible with standard and all known tissue simulating liquids.

6.5 Device Holder

<Mounting Device for Hand-Held Transmitter>

In combination with the Twin SAM V5.0/V5.0c or ELI phantoms, the Mounting Device for Hand-Held Transmitters enables rotation of the mounted transmitter device to specified spherical coordinates. At the heads, the rotation axis is at the ear opening. Transmitter devices can be easily and accurately positioned according to IEC 62209-1, IEEE 1528, FCC, or other specifications. The device holder can be locked for positioning at different phantom sections (left head, right head, flat). And upgrade kit to Mounting Device to enable easy mounting of wider devices like big smart-phones, e-books, small tablets, etc. It holds devices with width up to 140 mm.



Mounting Device for Hand-Held Transmitters



Mounting Device Adaptor for Wide-Phones

<Mounting Device for Laptops and other Body-Worn Transmitters>

The extension is lightweight and made of POM, acrylic glass and foam. It fits easily on the upper part of the mounting device in place of the phone positioned. The extension is fully compatible with the SAM Twin and ELI phantoms.



Mounting Device for Laptops

7. Measurement Procedures

The measurement procedures are as follows:

<Conducted power measurement>

- (a) For WWAN power measurement, use base station simulator to configure EUT WWAN transmission in conducted connection with RF cable, at maximum power in each supported wireless interface and frequency band.
- (b) Read the WWAN RF power level from the base station simulator.
- (c) For WLAN/BT power measurement, use engineering software to configure EUT WLAN/BT continuously transmission, at maximum RF power in each supported wireless interface and frequency band
- (d) Connect EUT RF port through RF cable to the power meter, and measure WLAN/BT output power

<SAR measurement>

- (a) Use base station simulator to configure EUT WWAN transmission in radiated connection, and engineering software to configure EUT WLAN/BT continuously transmission, at maximum RF power, in the highest power channel.
- (b) Place the EUT in the positions as Appendix D demonstrates.
- (c) Set scan area, grid size and other setting on the DASY software.
- (d) Measure SAR results for the highest power channel on each testing position.
- (e) Find out the largest SAR result on these testing positions of each band
- (f) Measure SAR results for other channels in worst SAR testing position if the reported SAR of highest power channel is larger than 0.8 W/kg

According to the test standard, the recommended procedure for assessing the peak spatial-average SAR value consists of the following steps:

- (a) Power reference measurement
- (b) Area scan
- (c) Zoom scan
- (d) Power drift measurement

7.1 Spatial Peak SAR Evaluation

The procedure for spatial peak SAR evaluation has been implemented according to the test standard. It can be conducted for 1g and 10g, as well as for user-specific masses. The DASY software includes all numerical procedures necessary to evaluate the spatial peak SAR value.

The base for the evaluation is a "cube" measurement. The measured volume must include the 1g and 10g cubes with the highest averaged SAR values. For that purpose, the center of the measured volume is aligned to the interpolated peak SAR value of a previously performed area scan.

The entire evaluation of the spatial peak values is performed within the post-processing engine (SEMCAD). The system always gives the maximum values for the 1g and 10g cubes. The algorithm to find the cube with highest averaged SAR is divided into the following stages:

- (a) Extraction of the measured data (grid and values) from the Zoom Scan
- (b) Calculation of the SAR value at every measurement point based on all stored data (A/D values and measurement parameters)
- (c) Generation of a high-resolution mesh within the measured volume
- (d) Interpolation of all measured values from the measurement grid to the high-resolution grid
- (e) Extrapolation of the entire 3-D field distribution to the phantom surface over the distance from sensor to surface
- (f) Calculation of the averaged SAR within masses of 1g and 10g

7.2 Power Reference Measurement

The Power Reference Measurement and Power Drift Measurements are for monitoring the power drift of the device under test in the batch process. The minimum distance of probe sensors to surface determines the closest measurement point to phantom surface. This distance cannot be smaller than the distance of sensor calibration points to probe tip as defined in the probe properties.

7.3 Area Scan

The area scan is used as a fast scan in two dimensions to find the area of high field values, before doing a fine measurement around the hot spot. The sophisticated interpolation routines implemented in DASY software can find the maximum found in the scanned area, within a range of the global maximum. The range (in dB0 is specified in the standards for compliance testing. For example, a 2 dB range is required in IEEE standard 1528 and IEC 62209 standards, whereby 3 dB is a requirement when compliance is assessed in accordance with the ARIB standard (Japan), if only one zoom scan follows the area scan, then only the absolute maximum will be taken as reference. For cases where multiple maximums are detected, the number of zoom scans has to be increased accordingly.

Area scan parameters extracted from FCC KDB 865664 D01v01r04 SAR measurement 100 MHz to 6 GHz.

	≤ 3 GHz	> 3 GHz
Maximum distance from closest measurement point (geometric center of probe sensors) to phantom surface	5 ± 1 mm	$\frac{1}{2} \cdot \delta \cdot \ln(2) \pm 0.5$ mm
Maximum probe angle from probe axis to phantom surface normal at the measurement location	30° ± 1°	20° ± 1°
Maximum area scan spatial resolution: $\Delta x_{Area}, \Delta y_{Area}$	≤ 2 GHz: ≤ 15 mm 2 – 3 GHz: ≤ 12 mm	3 – 4 GHz: ≤ 12 mm 4 – 6 GHz: ≤ 10 mm
	When the x or y dimension of the test device, in the measurement plane orientation, is smaller than the above, the measurement resolution must be ≤ the corresponding x or y dimension of the test device with at least one measurement point on the test device.	

7.4 Zoom Scan

Zoom scans are used assess the peak spatial SAR values within a cubic averaging volume containing 1 gram and 10 gram of simulated tissue. The zoom scan measures points (refer to table below) within a cube shoes base faces are centered on the maxima found in a preceding area scan job within the same procedure. When the measurement is done, the zoom scan evaluates the averaged SAR for 1 gram and 10 gram and displays these values next to the job's label.

Zoom scan parameters extracted from FCC KDB 865664 D01v01r04 SAR measurement 100 MHz to 6 GHz.

		≤ 3 GHz	> 3 GHz	
Maximum zoom scan spatial resolution: $\Delta x_{Zoom}, \Delta y_{Zoom}$		≤ 2 GHz: ≤ 8 mm 2 – 3 GHz: ≤ 5 mm*	3 – 4 GHz: ≤ 5 mm* 4 – 6 GHz: ≤ 4 mm*	
Maximum zoom scan spatial resolution, normal to phantom surface	uniform grid: $\Delta z_{Zoom}(n)$	≤ 5 mm	3 – 4 GHz: ≤ 4 mm 4 – 5 GHz: ≤ 3 mm 5 – 6 GHz: ≤ 2 mm	
	graded grid	$\Delta z_{Zoom}(1)$: between 1 st two points closest to phantom surface	≤ 4 mm	3 – 4 GHz: ≤ 3 mm 4 – 5 GHz: ≤ 2.5 mm 5 – 6 GHz: ≤ 2 mm
		$\Delta z_{Zoom}(n>1)$: between subsequent points	$\leq 1.5 \cdot \Delta z_{Zoom}(n-1)$	
Minimum zoom scan volume	x, y, z	≥ 30 mm	3 – 4 GHz: ≥ 28 mm 4 – 5 GHz: ≥ 25 mm 5 – 6 GHz: ≥ 22 mm	
Note: δ is the penetration depth of a plane-wave at normal incidence to the tissue medium; see draft standard IEEE P1528-2011 for details. * When zoom scan is required and the <i>reported</i> SAR from the <i>area scan based 1-g SAR estimation</i> procedures of KDB 447498 is ≤ 1.4 W/kg, ≤ 8 mm, ≤ 7 mm and ≤ 5 mm zoom scan resolution may be applied, respectively, for 2 GHz to 3 GHz, 3 GHz to 4 GHz and 4 GHz to 6 GHz.				

7.5 Volume Scan Procedures

The volume scan is used for assess overlapping SAR distributions for antennas transmitting in different frequency bands. It is equivalent to an oversized zoom scan used in standalone measurements. The measurement volume will be used to enclose all the simultaneous transmitting antennas. For antennas transmitting simultaneously in different frequency bands, the volume scan is measured separately in each frequency band. In order to sum correctly to compute the 1g aggregate SAR, the EUT remain in the same test position for all measurements and all volume scan use the same spatial resolution and grid spacing. When all volume scan were completed, the software, SEMCAD postprocessor can combine and subsequently superpose these measurement data to calculating the multiband SAR.

7.6 Power Drift Monitoring

All SAR testing is under the EUT install full charged battery and transmit maximum output power. In DASy measurement software, the power reference measurement and power drift measurement procedures are used for monitoring the power drift of EUT during SAR test. Both these procedures measure the field at a specified reference position before and after the SAR testing. The software will calculate the field difference in dB. If the power drifts more than 5%, the SAR will be retested.



8. Test Equipment List

Manufacturer	Name of Equipment	Type/Model	Serial Number	Calibration	
				Last Cal.	Due Date
SPEAG	2450MHz System Validation Kit	D2450V2	736	Aug. 17, 2021	Aug. 17, 2022
SPEAG	2450MHz System Validation Kit ⁽²⁾	D2450V2	929	Nov. 21, 2019	Nov. 18, 2022
SPEAG	5GHz System Validation Kit ⁽²⁾	D5GHzV2	1128	Dec. 16, 2019	Dec. 13, 2022
SPEAG	Data Acquisition Electronics	DAE3	528	Jul. 26, 2021	Jul. 25, 2022
SPEAG	Data Acquisition Electronics	DAE4	376	Nov. 22, 2021	Nov. 21, 2022
SPEAG	Dosimetric E-Field Probe	EX3DV4	3578	Jun. 23, 2021	Jun. 22, 2022
SPEAG	Dosimetric E-Field Probe	EX3DV4	7306	Jul. 26, 2021	Jul. 25, 2022
RCPTWN	Thermometer	HTC-1	TM685-1	Oct. 28, 2021	Oct. 27, 2022
RCPTWN	Thermometer	HTC-1	TM560-2	Oct. 28, 2021	Oct. 27, 2022
R&S	BT Base Station	CBT	100815	Feb. 19, 2021	Feb. 18, 2022
SPEAG	Device Holder	N/A	N/A	N/A	N/A
Anritsu	Signal Generator	MG3710A	6201502524	Oct. 24, 2021	Oct. 23, 2022
Keysight	ENA Network Analyzer	E5071C	MY46316648	Jul. 22, 2021	Jul. 21, 2022
SPEAG	Dielectric Probe Kit	DAK-3.5	1126	Sep. 24, 2021	Sep. 23, 2022
LINE SEIKI	Digital Thermometer	DTM3000-spezial	2942	Oct. 26, 2021	Oct. 25, 2022
Anritsu	Power Meter	ML2495A	1419002	Aug. 18, 2021	Aug. 17, 2022
Anritsu	Power Sensor	MA2411B	1911176	Aug. 18, 2021	Aug. 17, 2022
Anritsu	Power Meter	ML2495A	1804003	Oct. 09, 2021	Oct. 08, 2022
Anritsu	Power Sensor	MA2411B	1726150	Oct. 09, 2021	Oct. 08, 2022
Anritsu	Spectrum Analyzer	MS2830A	6201396378	Jul. 16, 2021	Jul. 15, 2022
Agilent	Spectrum Analyzer	E4408B	MY44211028	Aug. 19, 2021	Aug. 18, 2022
Mini-Circuits	Power Amplifier	ZVE-8G+	6418	Oct. 12, 2021	Oct. 11, 2022
Mini-Circuits	Power Amplifier	ZVE-8G+	479102029	Sep. 06, 2021	Sep. 05, 2022
ATM	Dual Directional Coupler	C122H-10	P610410z-02	Note 1	
Woken	Attenuator 1	WK0602-XX	N/A	Note 1	
PE	Attenuator 2	PE7005-10	N/A	Note 1	
PE	Attenuator 3	PE7005- 3	N/A	Note 1	

General Note:

1. Prior to system verification and validation, the path loss from the signal generator to the system check source and the power meter, which includes the amplifier, cable, attenuator and directional coupler, was measured by the network analyzer. The reading of the power meter was offset by the path loss difference between the path to the power meter and the path to the system check source to monitor the actual power level fed to the system check source.
2. The dipole calibration interval can be extended to 3 years with justification according to KDB 865664 D01. The dipoles are also not physically damaged, or repaired during the interval. The justification data in appendix C can be found which the return loss is < -20dB, within 20% of prior calibration, the impedance is within 5 ohm of prior calibration for each dipole.



9. System Verification

9.1 Tissue Verification

The tissue dielectric parameters of tissue-equivalent media used for SAR measurements must be characterized within a temperature range of 18°C to 25°C, measured with calibrated instruments and apparatuses, such as network analyzers and temperature probes. The temperature of the tissue-equivalent medium during SAR measurement must also be within 18°C to 25°C and within ± 2°C of the temperature when the tissue parameters are characterized. The tissue dielectric measurement system must be calibrated before use. The dielectric parameters must be measured before the tissue-equivalent medium is used in a series of SAR measurements.

The liquid tissue depth was at least 15cm in the phantom for all SAR testing

<Tissue Dielectric Parameter Check Results>

Frequency (MHz)	Liquid Temp. (°C)	Conductivity (σ)	Permittivity (ε _r)	Conductivity Target (σ)	Permittivity Target (ε _r)	Delta (σ) (%)	Delta (ε _r) (%)	Limit (%)	Date
2450	22.6	1.801	39.239	1.80	39.20	0.06	0.10	±5	2022/1/16
2450	22.5	1.789	39.616	1.80	39.20	-0.61	1.06	±5	2022/1/20
5250	22.4	4.557	36.502	4.71	35.95	-3.25	1.54	±5	2022/1/16
5600	22.4	4.899	36.029	5.07	35.50	-3.37	1.49	±5	2022/1/16
5750	22.4	5.058	35.825	5.22	35.35	-3.10	1.34	±5	2022/1/16

9.2 System Performance Check Results

Comparing to the original SAR value provided by SPEAG, the verification data should be within its specification of 10 %. Below table shows the target SAR and measured SAR after normalized to 1W input power. The table below indicates the system performance check can meet the variation criterion and the plots can be referred to Appendix A of this report.

Test Site	Date	Frequency (MHz)	Input Power (mW)	Dipole S/N	Probe S/N	DAE S/N	Measured 1g SAR (W/kg)	Targeted 1g SAR (W/kg)	Normalized 1g SAR (W/kg)	Deviation (%)
SAR05-HY	2022/1/16	2450	50	D2450V2-929	EX3DV4 - SN3578	DAE3 Sn528	2.69	53.10	53.8	1.32
SAR03-HY	2022/1/20	2450	50	D2450V2-736	EX3DV4 - SN7306	DAE4 Sn376	2.69	54.20	53.8	-0.74
SAR03-HY	2022/1/16	5250	100	D5GHzV2-1128-5250	EX3DV4 - SN7306	DAE4 Sn376	8.33	80.00	83.3	4.13
SAR03-HY	2022/1/16	5600	100	D5GHzV2-1128-5600	EX3DV4 - SN7306	DAE4 Sn376	8.78	82.40	87.8	6.55
SAR03-HY	2022/1/16	5750	100	D5GHzV2-1128-5750	EX3DV4 - SN7306	DAE4 Sn376	7.82	79.10	78.2	-1.14

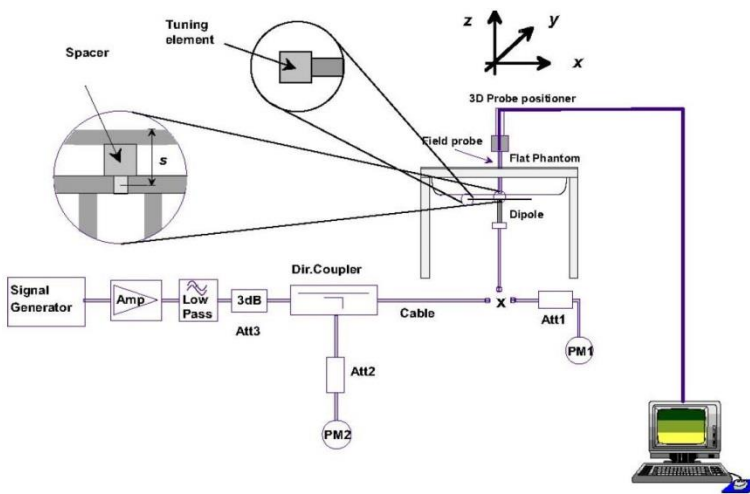

Fig 8.3.1 System Performance Check Setup



Fig 8.3.2 Setup Photo

10. RF Exposure Positions

10.1 SAR Testing for Tablet

This device can be used also in full sized tablet exposure conditions, due to its size. Per FCC KDB 616217, the back surface and edges of the tablet should be tested for SAR compliance with the tablet touching the phantom. The SAR exclusion threshold in KDB 447498 D01v06 can be applied to determine SAR test exclusion for adjacent edge configurations. The closest distance from the antenna to an adjacent tablet edge is used to determine if SAR testing is required for the adjacent edges, with the adjacent edge positioned against the phantom and the edge containing the antenna positioned perpendicular to the phantom.



11. WiFi/Bluetooth Output Power (Unit: dBm)

General Note:

1. All of the wireless technology of this device only supports MIMO mode operation.
2. The maximum output power specified for production units are determined for all applicable 802.11 transmission modes in each standalone and aggregated frequency band. Maximum output power is measured for the highest maximum output power configuration(s) in each frequency band according to the default power measurement procedures. For "Not required", SAR Test reduction was applied from KDB 248227 guidance, Sec. 2.1, b), 1) when the same maximum power is specified for multiple transmission modes in a frequency band, the largest channel bandwidth, lowest order modulation, lowest data rate and lowest order 802.11a/g/n/ac mode is used for SAR measurement, on the highest measured output power channel in the initial test configuration, additional output power measurements were not necessary.
3. Per KDB 248227 D01v02r02, SAR test reduction is determined according to 802.11 transmission mode configurations and certain exposure conditions with multiple test positions. In the 2.4 GHz band, separate SAR procedures are applied to DSSS and OFDM configurations to simplify DSSS test requirements. For OFDM, in both 2.4 and 5 GHz bands, an initial test configuration must be determined for each standalone and aggregated frequency band, according to the transmission mode configuration with the highest maximum output power specified for production units to perform SAR measurements. If the same highest maximum output power applies to different combinations of channel bandwidths, modulations and data rates, additional procedures are applied to determine which test configurations require SAR measurement. When applicable, an initial test position may be applied to reduce the number of SAR measurements required for next to the ear, UMPC mini-tablet or hotspot mode configurations with multiple test positions.
4. For 2.4 GHz 802.11b DSSS, either the initial test position procedure for multiple exposure test positions or the DSSS procedure for fixed exposure position is applied; these are mutually exclusive. For 2.4 GHz and 5 GHz OFDM configurations, the initial test configuration is applied to measure SAR using either the initial test position procedure for multiple exposure test position configurations or the initial test configuration procedures for fixed exposure test conditions. Based on the reported SAR of the measured configurations and maximum output power of the transmission mode configurations that are not included in the initial test configuration, the subsequent test configuration and initial test position procedures are applied to determine if SAR measurements are required for the remaining OFDM transmission configurations. In general, the number of test channels that require SAR measurement is minimized based on maximum output power measured for the test sample(s).
5. For OFDM transmission configurations in the 2.4 GHz and 5 GHz bands, When the same maximum power is specified for multiple transmission modes in a frequency band, the largest channel bandwidth, lowest order modulation, lowest data rate and lowest order 802.11a/g/n/ac mode is used for SAR measurement, on the highest measured output power channel for each frequency band.
6. DSSS and OFDM configurations are considered separately according to the required SAR procedures. SAR is measured in the initial test position using the 802.11 transmission mode configuration required by the DSSS procedure or initial test configuration and subsequent test configuration(s) according to the OFDM procedures. 18 The initial test position procedure is described in the following:
 - a. When the reported SAR of the initial test position is ≤ 0.4 W/kg, further SAR measurement is not required for the other test positions in that exposure configuration and 802.11 transmission mode combinations within the frequency band or aggregated band.
 - b. When the reported SAR of the test position is > 0.4 W/kg, SAR is repeated for the 802.11 transmission mode configuration tested in the initial test position to measure the subsequent next closet/smallest test separation distance and maximum coupling test position on the highest maximum output power channel, until the report SAR is ≤ 0.8 W/kg or all required test position are tested.
 - c. For all positions/configurations, when the reported SAR is > 0.8 W/kg, SAR is measured for these test positions/configurations on the subsequent next highest measured output power channel(s) until the reported SAR is ≤ 1.2 W/kg or all required channels are tested.
7. Per 201904 TCBC workshops, General principles of FCC KDB Publication 248227 D01 can be applied to determine the SAR Initial Test Configurations and test reduction for 802.11ax SAR testing. For the table below the 802.11ax maximum power is SU (non-OFDMA), and the SU maximum power also higher than RU (OFDMA)
8. In applying the test guidance, the IEEE 802.11 mode with the maximum output power (out of all modes) should be considered for testing
9. For modes with the same maximum output power, the guidance from section 5.3.2 a) of FCC KDB Publication 248227 D01 should be applied, with 802.11ax being considered as the highest 802.11 mode for the appropriate frequency bands
10. When SAR testing for 802.11ax is required
 - a. If the maximum output power is highest for OFDMA scenarios, choose the tone size with the maximum number of tones and the highest maximum output power
 - b. Otherwise, consider the fully allocated channel for SAR testing
 - c. When SAR testing is required on RU sizes less than the fully allocated channel, use the RU number closest to the middle of the channel, choosing the higher RU number when two RUs are equidistant to the middle of the channel



For Tablet Mode

<2.4GHz WLAN>

2.4GHz WLAN				Ant 1+2(1)		Ant 1+2(2)		Ant 1+2		
2.4GHz WLAN	Mode	Channel	Frequency (MHz)	Average power (dBm)	Tune-Up Limit	Average power (dBm)	Tune-Up Limit	Average power (dBm)	Tune-Up Limit	Duty Cycle %
	802.11b 1Mbps		1	2412	15.50	16.00	15.80	16.00	18.66	19.00
6			2437	15.50	16.00	15.80	16.00	18.66	19.00	
11			2462	15.80	16.00	16.00	16.00	18.91	19.00	
12			2467	15.40	15.50	15.40	15.50	18.41	18.50	
13			2472	8.90	9.00	8.90	9.00	11.91	12.00	
802.11g 6Mbps		1	2412	Not Required	16.00	Not Required	16.00	Not Required	19.00	
		6	2437		16.00		16.00		19.00	
		11	2462		16.00		16.00		19.00	
		12	2467		10.50		10.50		13.50	
		13	2472		6.00		6.00		9.00	
802.11n-HT20 MCS0		1	2412	Not Required	16.00	Not Required	16.00	Not Required	19.00	
		6	2437		16.00		16.00		19.00	
		11	2462		16.00		16.00		19.00	
		12	2467		10.50		10.50		13.50	
		13	2472		6.00		6.00		9.00	
802.11n-HT40 MCS0		3	2422	Not Required	15.00	Not Required	15.00	Not Required	18.00	
		6	2437		16.00		16.00		19.00	
		9	2452		15.50		15.50		18.50	
		10	2457		8.50		8.50		11.50	
		11	2462		6.50		6.50		9.50	
802.11ac-VHT20 MCS0		1	2412	Not Required	16.00	Not Required	16.00	Not Required	19.00	
		6	2437		16.00		16.00		19.00	
		11	2462		16.00		16.00		19.00	
		12	2467		10.50		10.50		13.50	
		13	2472		6.00		6.00		9.00	
802.11ac-VHT40 MCS0		3	2422	Not Required	15.00	Not Required	15.00	Not Required	18.00	
		6	2437		16.00		16.00		19.00	
		9	2452		15.50		15.50		18.50	
		10	2457		8.50		8.50		11.50	
		11	2462		6.50		6.50		9.50	
802.11ax-HE20 MCS0		1	2412	Not Required	16.00	Not Required	16.00	Not Required	19.00	
		6	2437		16.00		16.00		19.00	
		11	2462		16.00		16.00		19.00	
		12	2467		10.50		10.50		13.50	
		13	2472		6.00		6.00		9.00	
802.11ax-HE40 MCS0		3	2422	Not Required	15.00	Not Required	15.00	Not Required	18.00	
		6	2437		16.00		16.00		19.00	
		9	2452		15.50		15.50		18.50	
		10	2457		8.50		8.50		11.50	
		11	2462		6.50		6.50		9.50	



<5GHz WLAN>

5.2GHz WLAN				Ant 1		Ant 2		Ant 1+2		
	Mode	Channel	Frequency (MHz)	Average power (dBm)	Tune-Up Limit	Average power (dBm)	Tune-Up Limit	Average power (dBm)	Tune-Up Limit	Duty Cycle %
5.2GHz WLAN	802.11a 6Mbps	36	5180	Not Required	13.00	Not Required	13.00	Not Required	16.00	Not Required
		40	5200		13.00		16.00			
		44	5220		13.00		16.00			
		48	5240		13.00		16.00			
	802.11n-HT20 MCS0	36	5180		13.00		13.00		16.00	
		40	5200		13.00		13.00		16.00	
		44	5220		13.00		13.00		16.00	
		48	5240		13.00		13.00		16.00	
	802.11n-HT40 MCS0	38	5190		13.00		13.00		16.00	
		46	5230		13.00		13.00		16.00	
	802.11ac-VHT20 MCS0	36	5180		13.00		13.00		16.00	
		40	5200		13.00		13.00		16.00	
		44	5220		13.00		13.00		16.00	
	802.11ac-VHT40 MCS0	38	5190		13.00		13.00		16.00	
		46	5230		13.00		13.00		16.00	
	802.11ac-VHT80 MCS0	42	5210		13.00		13.00		16.00	
		48	5240		13.00		13.00		16.00	
	802.11ax-HE20 MCS0	36	5180		13.00		13.00		16.00	
		40	5200		13.00		13.00		16.00	
		44	5220		13.00		13.00		16.00	
48		5240	13.00	13.00	16.00					
802.11ax-HE40 MCS0	38	5190	13.00	13.00	16.00					
	46	5230	13.00	13.00	16.00					
802.11ax-HE80 MCS0	42	5210	13.00	13.00	16.00					



5.3GHz WLAN				Ant 1		Ant 2		Ant 1+2		
5.3GHz WLAN	Mode	Channel	Frequency (MHz)	Average power (dBm)	Tune-Up Limit	Average power (dBm)	Tune-Up Limit	Average power (dBm)	Tune-Up Limit	Duty Cycle %
	5.3GHz WLAN	802.11a 6Mbps	52	5260	Not Required	13.00	Not Required	13.00	Not Required	16.00
56			5280	13.00		13.00		16.00		
60			5300	13.00		13.00		16.00		
64			5320	13.00		13.00		16.00		
802.11n-HT20 MCS0		52	5260	13.00		13.00		16.00		
		56	5280	13.00		13.00		16.00		
		60	5300	13.00		13.00		16.00		
		64	5320	13.00		13.00		16.00		
802.11n-HT40 MCS0		54	5270	13.00		13.00		16.00		
		62	5310	13.00		13.00		16.00		
802.11ac-VHT20 MCS0		52	5260	13.00		13.00		16.00		
		56	5280	13.00		13.00		16.00		
		60	5300	13.00		13.00		16.00		
		64	5320	13.00		13.00		16.00		
802.11ac-VHT40 MCS0		54	5270	13.00		13.00		16.00		
		62	5310	13.00		13.00		16.00		
802.11ac-VHT80 MCS0	58	5290	13.00	12.80	15.91	16.00	87.60			
802.11ac-VHT160 MCS0	50	5250	Not Required	13.00	Not Required	13.00	Not Required	16.00		
802.11ax-HE20 MCS0	52	5260		13.00		13.00		16.00		
	56	5280		13.00		13.00		16.00		
	60	5300		13.00		13.00		16.00		
	64	5320		13.00		13.00		16.00		
802.11ax-HE40 MCS0	54	5270		13.00		13.00		16.00		
	62	5310		13.00		13.00		16.00		
802.11ax-HE80 MCS0	58	5290		13.00		13.00		16.00		
802.11ax-HE160 MCS0	50	5250		13.00		13.00		16.00		



5.5GHz WLAN				Ant 1		Ant 2		Ant 1+2		
5.5GHz WLAN	Mode	Channel	Frequency (MHz)	Average power (dBm)	Tune-Up Limit	Average power (dBm)	Tune-Up Limit	Average power (dBm)	Tune-Up Limit	Duty Cycle %
	5.5GHz WLAN	802.11a 6Mbps	100	5500	Not Required	13.00	Not Required	13.00	Not Required	16.00
116			5580	13.00		16.00				
124			5620	13.00		16.00				
132			5660	13.00		16.00				
144			5720	13.00		16.00				
802.11n-HT20 MCS0		100	5500	13.00		13.00		16.00		
		116	5580	13.00		13.00		16.00		
		124	5620	13.00		13.00		16.00		
		132	5660	13.00		13.00		16.00		
		144	5720	13.00		13.00		16.00		
802.11n-HT40 MCS0		102	5510	13.00		13.00		16.00		
		110	5550	13.00		13.00		16.00		
		126	5630	13.00		13.00		16.00		
		134	5670	13.00		13.00		16.00		
		142	5710	13.00		13.00		16.00		
802.11ac-VHT20 MCS0		100	5500	13.00		13.00		16.00		
		116	5580	13.00		13.00		16.00		
		124	5620	13.00		13.00		16.00		
		132	5660	13.00		13.00		16.00		
		144	5720	13.00		13.00		16.00		
802.11ac-VHT40 MCS0	102	5510	13.00	13.00	16.00					
	110	5550	13.00	13.00	16.00					
	126	5630	13.00	13.00	16.00					
	134	5670	13.00	13.00	16.00					
	142	5710	13.00	13.00	16.00					
802.11ac-VHT80 MCS0	106	5530	12.30	13.00	13.00	13.00	15.67	16.00	87.60	
	122	5610	12.60	13.00	12.70	13.00	15.66	16.00		
	138	5690	12.70	13.00	12.50	13.00	15.61	16.00		
802.11ax-HE20 MCS0	100	5500	Not Required	Not Required	Not Required	Not Required	Not Required	16.00	Not Required	
	116	5580						16.00		
	124	5620						16.00		
	132	5660						16.00		
	144	5720						16.00		
802.11ax-HE40 MCS0	102	5510						16.00		
	110	5550						16.00		
	126	5630						16.00		
	134	5670						16.00		
	142	5710						16.00		
802.11ax-HE80 MCS0	106	5530						16.00		
	122	5610						16.00		
	138	5690						16.00		



5.8GHz WLAN				Ant 1		Ant 2		Ant 1+2						
5.8GHz WLAN	Mode	Channel	Frequency (MHz)	Average power (dBm)	Tune-Up Limit	Average power (dBm)	Tune-Up Limit	Average power (dBm)	Tune-Up Limit	Duty Cycle %				
	5.8GHz WLAN	802.11a 6Mbps	149	5745	Not Required	13.00	Not Required	13.00	Not Required	16.00	Not Required			
157			5785	13.00		13.00		16.00						
165			5825	13.00		13.00		16.00						
802.11n-HT20 MCS0		149	5745	13.00		13.00		16.00						
		157	5785	13.00		13.00		16.00						
		165	5825	13.00		13.00		16.00						
802.11n-HT40 MCS0		151	5755	13.00		13.00		16.00						
		159	5795	13.00		13.00		16.00						
802.11ac-VHT20 MCS0		149	5745	13.00		13.00		16.00						
		157	5785	13.00		13.00		16.00						
		165	5825	13.00		13.00		16.00						
802.11ac-VHT40 MCS0		151	5755	13.00		13.00		16.00						
		159	5795	13.00		13.00		16.00						
802.11ac-VHT80 MCS0		155	5775	12.70		13.00		12.50		13.00		15.61	16.00	87.60
802.11ax-HE20 MCS0		149	5745	Not Required		13.00		Not Required		13.00		Not Required	16.00	Not Required
		157	5785			13.00				13.00			16.00	
		165	5825			13.00				13.00			16.00	
802.11ax-HE40 MCS0		151	5755			13.00				13.00			16.00	
	159	5795	13.00		13.00	16.00								
802.11ax-HE80 MCS0	155	5775	13.00		13.00	16.00								



For Laptop Mode

<2.4GHz WLAN>

2.4GHz WLAN				Ant 1+2(1)		Ant 1+2(2)		Ant 1+2		
Mode	Channel	Frequency (MHz)	Average power (dBm)	Tune-Up Limit	Average power (dBm)	Tune-Up Limit	Average power (dBm)	Tune-Up Limit	Duty Cycle %	
802.11b 1Mbps	1	2412	18.60	19.00	18.90	19.00	21.76	22.00	99.70	
	6	2437	18.70	19.00	18.80	19.00	21.76	22.00		
	11	2462	18.20	19.00	18.80	19.00	21.52	22.00		
	12	2467	15.30	15.50	15.40	15.50	18.36	18.50		
	13	2472	8.60	9.00	8.70	9.00	11.66	12.00		
802.11g 6Mbps	1	2412	Not Required	17.00	Not Required	17.00	Not Required	20.00	Not Required	
	6	2437		18.00		18.00		21.00		
	11	2462		16.50		16.50		19.50		
	12	2467		10.50		10.50		13.50		
	13	2472		6.00		6.00		9.00		
802.11n-HT20 MCS0	1	2412	Not Required	17.00	Not Required	17.00	Not Required	20.00	Not Required	
	6	2437		18.00		18.00		21.00		
	11	2462		16.50		16.50		19.50		
	12	2467		10.50		10.50		13.50		
	13	2472		6.00		6.00		9.00		
802.11n-HT40 MCS0	3	2422	Not Required	15.00	Not Required	15.00	Not Required	18.00	Not Required	
	6	2437		16.00		16.00		19.00		
	9	2452		15.00		15.00		18.00		
	10	2457		8.50		8.50		11.50		
	11	2462		6.50		6.50		9.50		
802.11ac-VHT20 MCS0	1	2412	Not Required	17.00	Not Required	17.00	Not Required	20.00	Not Required	
	6	2437		18.00		18.00		21.00		
	11	2462		16.50		16.50		19.50		
	12	2467		10.50		10.50		13.50		
	13	2472		6.00		6.00		9.00		
802.11ac-VHT40 MCS0	3	2422	Not Required	15.00	Not Required	15.00	Not Required	18.00	Not Required	
	6	2437		16.00		16.00		19.00		
	9	2452		15.00		15.00		18.00		
	10	2457		8.50		8.50		11.50		
	11	2462		6.50		6.50		9.50		
802.11ax-HE20 MCS0	1	2412	Not Required	17.00	Not Required	17.00	Not Required	20.00	Not Required	
	6	2437		18.00		18.00		21.00		
	11	2462		16.50		16.50		19.50		
	12	2467		10.50		10.50		13.50		
	13	2472		6.00		6.00		9.00		
802.11ax-HE40 MCS0	3	2422	Not Required	15.00	Not Required	15.00	Not Required	18.00	Not Required	
	6	2437		16.00		16.00		19.00		
	9	2452		15.00		15.00		18.00		
	10	2457		8.50		8.50		11.50		
	11	2462		6.50		6.50		9.50		



<5GHz WLAN>

5.2GHz WLAN				Ant 1+2(1)		Ant 1+2(2)		Ant 1+2		
5.2GHz WLAN	Mode	Channel	Frequency (MHz)	Average power (dBm)	Tune-Up Limit	Average power (dBm)	Tune-Up Limit	Average power (dBm)	Tune-Up Limit	Duty Cycle %
	802.11a 6Mbps		36	5180	15.80	16.00	15.30	16.00	18.57	19.00
40			5200	16.70	17.00	16.00	17.00	19.37	20.00	
44			5220	16.60	17.00	16.20	17.00	19.41	20.00	
48			5240	16.50	17.00	16.20	17.00	19.36	20.00	
802.11n-HT20 MCS0		36	5180	Not Required	16.00	Not Required	16.00	Not Required	19.00	Not Required
		40	5200		17.00		17.00			
		44	5220		17.00		17.00			
		48	5240		17.00		17.00			
802.11n-HT40 MCS0		38	5190	Not Required	15.00	Not Required	15.00	Not Required	18.00	Not Required
		46	5230		17.00		17.00			
802.11ac-VHT20 MCS0		36	5180	Not Required	16.00	Not Required	16.00	Not Required	19.00	Not Required
		40	5200		17.00		17.00			
		44	5220		17.00		17.00			
		48	5240		17.00		17.00			
802.11ac-VHT40 MCS0		38	5190	Not Required	15.00	Not Required	15.00	Not Required	18.00	Not Required
		46	5230		17.00		17.00			
802.11ac-VHT80 MCS0		42	5210	Not Required	14.00	Not Required	14.00	Not Required	17.00	Not Required
802.11ax-HE20 MCS0		36	5180	Not Required	16.00	Not Required	16.00	Not Required	19.00	Not Required
		40	5200		17.00		17.00			
		44	5220		17.00		17.00			
		48	5240		17.00		17.00			
802.11ax-HE40 MCS0		38	5190	Not Required	15.00	Not Required	15.00	Not Required	18.00	Not Required
		46	5230		17.00		17.00			
802.11ax-HE80 MCS0		42	5210	Not Required	14.00	Not Required	14.00	Not Required	17.00	Not Required



5.3GHz WLAN				Ant 1+2(1)		Ant 1+2(2)		Ant 1+2		
5.3GHz WLAN	Mode	Channel	Frequency (MHz)	Average power (dBm)	Tune-Up Limit	Average power (dBm)	Tune-Up Limit	Average power (dBm)	Tune-Up Limit	Duty Cycle %
	5.3GHz WLAN	802.11a 6Mbps	52	5260	18.20	18.50	17.70	18.50	20.97	21.50
56			5280	17.70	18.00	17.60	18.00	20.66	21.00	
60			5300	17.90	18.00	16.90	18.00	20.44	21.00	
64			5320	15.40	15.50	15.00	15.50	18.21	18.50	
802.11n-HT20 MCS0		52	5260	Not Required	18.50	Not Required	18.50	Not Required	21.50	Not Required
		56	5280		18.00		18.00		21.00	
		60	5300		18.00		18.00		21.00	
		64	5320		15.50		15.50		18.50	
802.11n-HT40 MCS0		54	5270		17.50		17.50		20.50	
		62	5310		15.00		15.00		18.00	
802.11ac-VHT20 MCS0		52	5260		18.50		18.50		21.50	
		56	5280		18.00		18.00		21.00	
		60	5300		18.00		18.00		21.00	
802.11ac-VHT40 MCS0		54	5270		17.50		17.50		20.50	
		62	5310		15.00		15.00		18.00	
		58	5290		17.00		17.00		20.00	
802.11ac-VHT80 MCS0	52	5260	18.50		18.50		21.50			
	56	5280	18.00		18.00		21.00			
	60	5300	18.00		18.00		21.00			
	64	5320	15.50		15.50		18.50			
802.11ax-HE20 MCS0	54	5270	17.50	17.50	20.50					
	62	5310	15.00	15.00	18.00					
802.11ax-HE40 MCS0	54	5270	17.50	17.50	20.50					
	62	5310	15.00	15.00	18.00					
802.11ax-HE80 MCS0	54	5270	17.50	17.50	20.50					
	58	5290	17.00	17.00	20.00					



5.5GHz WLAN				Ant 1+2(1)		Ant 1+2(2)		Ant 1+2		
5.5GHz WLAN	Mode	Channel	Frequency (MHz)	Average power (dBm)	Tune-Up Limit	Average power (dBm)	Tune-Up Limit	Average power (dBm)	Tune-Up Limit	Duty Cycle %
	802.11a 6Mbps		100	5500	15.20	16.50	16.30	16.50	18.80	19.50
116			5580	18.20	18.50	18.10	18.50	21.16	21.50	
124			5620	18.40	18.50	17.80	18.50	21.12	21.50	
132			5660	18.30	18.50	18.10	18.50	21.21	21.50	
144			5720	17.90	18.50	18.10	18.50	21.01	21.50	
802.11n-HT20 MCS0		100	5500	Not Required	16.50	Not Required	16.50	Not Required	19.50	Not Required
		116	5580		18.50		18.50		21.50	
		124	5620		18.50		18.50		21.50	
		132	5660		18.50		18.50		21.50	
		144	5720		18.50		18.50		21.50	
802.11n-HT40 MCS0		102	5510	Not Required	16.50	Not Required	16.50	Not Required	19.50	Not Required
		110	5550		17.50		17.50		20.50	
		126	5630		17.50		17.50		20.50	
		134	5670		17.50		17.50		20.50	
		142	5710		17.50		17.50		20.50	
802.11ac-VHT20 MCS0		100	5500	Not Required	16.50	Not Required	16.50	Not Required	19.50	Not Required
		116	5580		18.50		18.50		21.50	
		124	5620		18.50		18.50		21.50	
		132	5660		18.50		18.50		21.50	
		144	5720		18.50		18.50		21.50	
802.11ac-VHT40 MCS0		102	5510	Not Required	16.50	Not Required	16.50	Not Required	19.50	Not Required
		110	5550		17.50		17.50		20.50	
		126	5630		17.50		17.50		20.50	
		134	5670		17.50		17.50		20.50	
		142	5710		17.50		17.50		20.50	
802.11ac-VHT80 MCS0		106	5530	Not Required	14.50	Not Required	14.50	Not Required	17.50	Not Required
		122	5610		16.50		16.50		19.50	
		138	5690		16.50		16.50		19.50	
802.11ax-HE20 MCS0		100	5500	Not Required	16.50	Not Required	16.50	Not Required	19.50	Not Required
		116	5580		18.50		18.50		21.50	
		124	5620		18.50		18.50		21.50	
		132	5660		18.50		18.50		21.50	
		144	5720		18.50		18.50		21.50	
802.11ax-HE40 MCS0		102	5510	Not Required	16.50	Not Required	16.50	Not Required	19.50	Not Required
		110	5550		17.50		17.50		20.50	
		126	5630		17.50		17.50		20.50	
		134	5670		17.50		17.50		20.50	
		142	5710		17.50		17.50		20.50	
802.11ax-HE80 MCS0		106	5530	Not Required	14.50	Not Required	14.50	Not Required	17.50	Not Required
		122	5610		16.50		16.50		19.50	
		138	5690		16.50		16.50		19.50	



5.8GHz WLAN				Ant 1+2(1)		Ant 1+2(2)		Ant 1+2			
5.8GHz WLAN	Mode	Channel	Frequency (MHz)	Average power (dBm)	Tune-Up Limit	Average power (dBm)	Tune-Up Limit	Average power (dBm)	Tune-Up Limit	Duty Cycle %	
	802.11a 6Mbps	149	5745	18.30	18.50	17.90	18.50	21.11	21.50	97.50	
		157	5785	17.90	18.50	18.20	18.50	21.06	21.50		
		165	5825	18.40	18.50	17.60	18.50	21.03	21.50		
	802.11n-HT20 MCS0	149	5745	Not Required	Not Required	Not Required	Not Required	Not Required	Not Required	18.50	21.50
		157	5785							18.50	21.50
		165	5825							18.50	21.50
	802.11n-HT40 MCS0	151	5755							17.50	20.50
		159	5795							17.50	20.50
	802.11ac-VHT20 MCS0	149	5745							18.50	21.50
		157	5785							18.50	21.50
165		5825	18.50							21.50	
802.11ac-VHT40 MCS0	151	5755	17.50							20.50	
	159	5795	17.50							20.50	
802.11ac-VHT80 MCS0	155	5775	16.50							19.50	
802.11ax-HE20 MCS0	149	5745	18.50	21.50							
	157	5785	18.50	21.50							
	165	5825	18.50	21.50							
802.11ax-HE40 MCS0	151	5755	17.50	20.50							
	159	5795	17.50	20.50							
802.11ax-HE80 MCS0	155	5775	16.50	19.50							



For Laptop Mode

<2.4GHz Bluetooth>

Mode	Channel	Frequency (MHz)	Average power (dBm)		
			1Mbps	2Mbps	3Mbps
BR / EDR	CH 00	2402	10.70	Not Required	Not Required
	CH 39	2441	10.60		
	CH 78	2480	10.60		
Tune-up Limit			11.50	8.50	8.50

Mode	Channel	Frequency (MHz)	Average power (dBm)	
			1Mbps	2Mbps
LE	CH 00	2402	Not Required	Not Required
	CH 19	2440		
	CH 39	2480		
Tune-up Limit			11.50	11.50

General Note:

- For 2.4GHz Bluetooth SAR testing was selected 1Mbps due to its highest average power and duty cycle is 76.8% considered in SAR testing, and the duty cycle would be scaled to theoretical 83.3% in reported SAR calculation.

BT Duty cycle

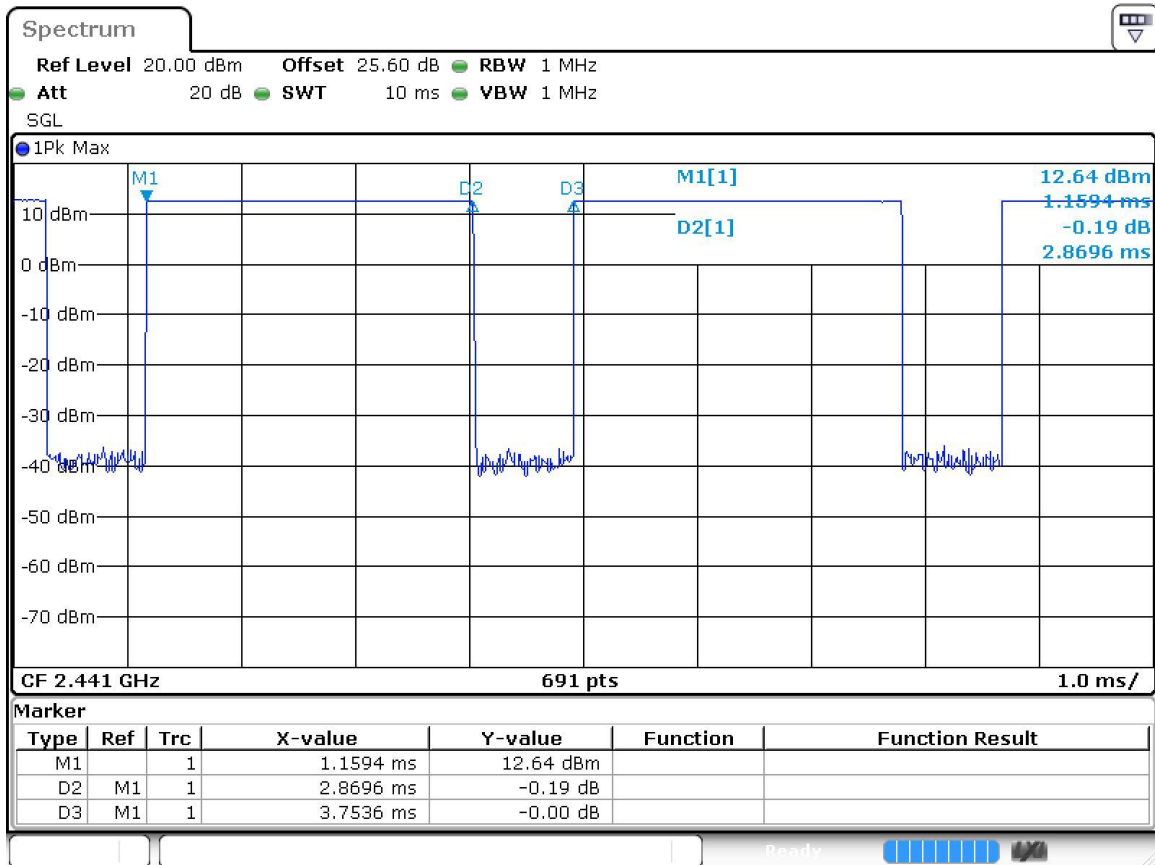

12. Antenna Location

For Tablet

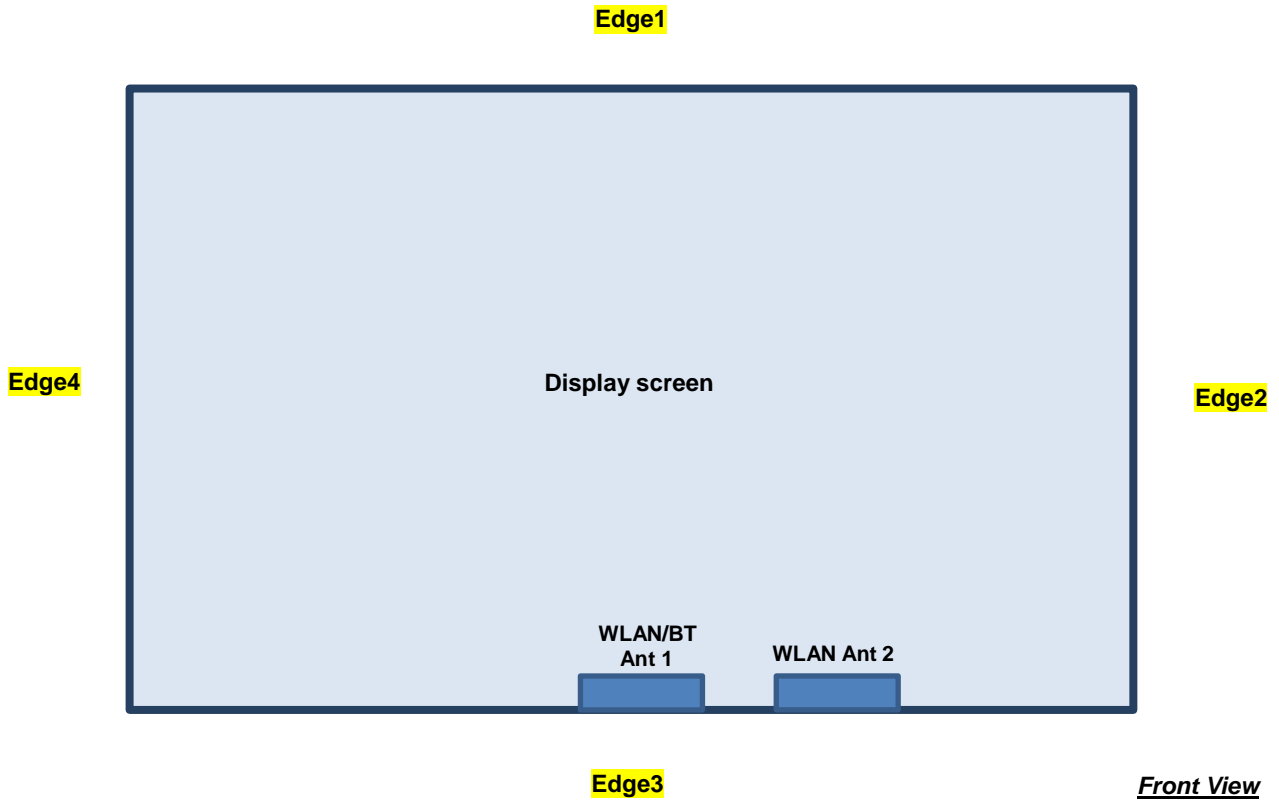

Front View

The separation distance for antenna to edge:

Antenna	To Edge1 (mm)	To Edge2 (mm)	To Edge3 (mm)	To Edge4 (mm)
WLAN Antenna 1+2	240	106.8	< 5	140

For Laptop

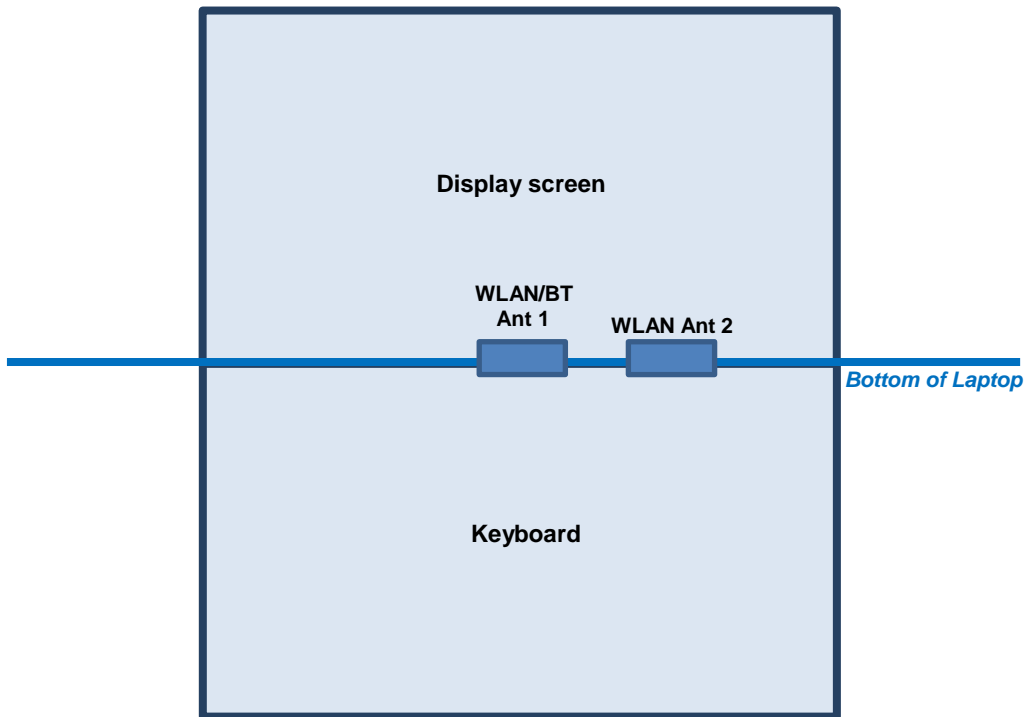

The separation distance for antenna to edge:

Antenna	To Bottom of Laptop (mm)
WLAN/BT Antenna 1	15.52
WLAN Antenna 2	15.52

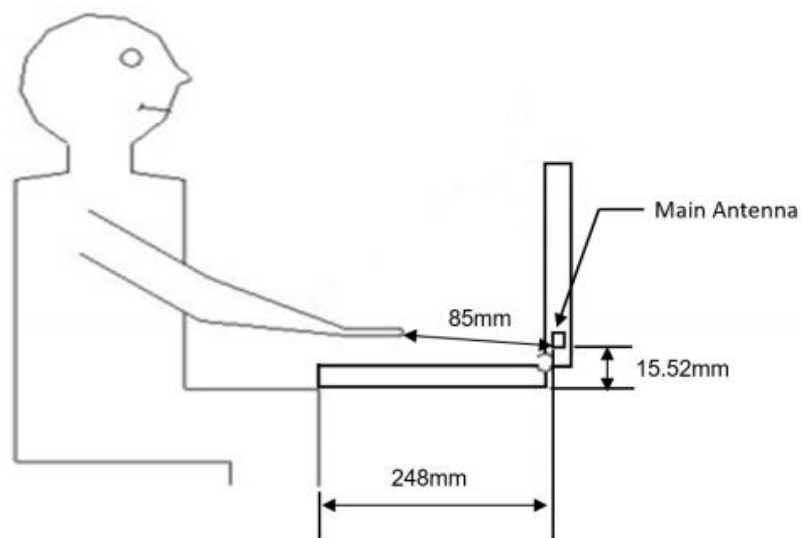



<SAR test exclusion table>

General Note:

1. The below table, when the distance is < 50 mm exclusion threshold is "Ratio", when the distance is > 50 mm exclusion threshold is "mW"
2. Maximum power is the source-based time-average power and represents the maximum RF output power among production units
3. Per KDB 447498 D01v06, for larger devices, the test separation distance of adjacent edge configuration is determined by the closest separation between the antenna and the user.
4. Per KDB 447498 D01v06, standalone SAR test exclusion threshold is applied; If the test separation distance is < 5mm, 5mm is used to determine SAR exclusion threshold.
5. Per KDB 447498 D01v06, the 1-g and 10-g SAR test exclusion thresholds for 100 MHz to 6 GHz at *test separation distances* ≤ 50 mm are determined by:
 - $[(\text{max. power of channel, including tune-up tolerance, mW}) / (\text{min. test separation distance, mm})] \cdot \sqrt{f(\text{GHz})} \leq 3.0$ for 1-g SAR and ≤ 7.5 for 10-g extremity SAR
 - f(GHz) is the RF channel transmit frequency in GHz
 - Power and distance are rounded to the nearest mW and mm before calculation
 - The result is rounded to one decimal place for comparison
6. Per KDB 447498 D01v06, at 100 MHz to 6 GHz and for *test separation distances* > 50 mm, the SAR test exclusion threshold is determined according to the following
 - a) [Threshold at 50 mm in step 1) + (test separation distance - 50 mm) · (f(MHz)/150)] mW, at 100 MHz to 1500 MHz
 - b) [Threshold at 50 mm in step 1) + (test separation distance - 50 mm) · 10] mW at > 1500 MHz and ≤ 6 GHz

Exposure Position	Wireless Interface	2.4GHz WLAN/BT ANT 1+2	5GHz WLAN ANT 1+2
	Calculated Frequency (MHz)	2472	5825
	Maximum power (dBm)	19.0	16.0
	Maximum rated power(mW)	79.43	39.81
Bottom Face	Separation distance(mm)	13.8	13.8
	exclusion threshold	9.1	7.0
	Testing required?	Yes	Yes
Edge 1	Separation distance(mm)	240.0	240.0
	exclusion threshold	1995.0	1962.0
	Testing required?	No	No
Edge 2	Separation distance(mm)	106.8	106.8
	exclusion threshold	663.0	630.0
	Testing required?	No	No
Edge 3	Separation distance(mm)	5.0	5.0
	exclusion threshold	25.0	19.2
	Testing required?	Yes	Yes
Edge 4	Separation distance(mm)	140.0	140.0
	exclusion threshold	995.0	962.0
	Testing required?	No	No

Exposure Position	Wireless Interface	2.4GHz WLAN/BT ANT 1+2	5GHz WLAN ANT 1+2
	Calculated Frequency (MHz)	2472	5825
	Maximum power (dBm)	22.0	21.5
	Maximum rated power(mW)	158.49	141.25
Bottom of Laptop	Separation distance(mm)	15.5	15.5
	exclusion threshold	16.1	22.0
	Testing required?	Yes	Yes



13. SAR Test Results

General Note:

1. Per KDB 447498 D01v06, the reported SAR is the measured SAR value adjusted for maximum tune-up tolerance.
 - a. Tune-up scaling Factor = tune-up limit power (mW) / EUT RF power (mW), where tune-up limit is the maximum rated power among all production units.
 - b. For SAR testing of WLAN signal with non-100% duty cycle, the measured SAR is scaled-up by the duty cycle scaling factor which is equal to "1/(duty cycle)"
 - c. For WLAN/Bluetooth: Reported SAR(W/kg)= Measured SAR(W/kg)* Duty Cycle scaling factor * Tune-up scaling factor
2. Per KDB 447498 D01v06, for each exposure position, testing of other required channels within the operating mode of a frequency band is not required when the *reported* 1-g or 10-g SAR for the mid-band or highest output power channel is:
 - ≤ 0.8 W/kg or 2.0 W/kg, for 1-g or 10-g respectively, when the transmission band is ≤ 100 MHz
 - ≤ 0.6 W/kg or 1.5 W/kg, for 1-g or 10-g respectively, when the transmission band is between 100 MHz and 200 MHz
 - ≤ 0.4 W/kg or 1.0 W/kg, for 1-g or 10-g respectively, when the transmission band is ≥ 200 MHz
3. Per KDB 865664 D01v01r04, for each frequency band, repeated SAR measurement is required only when the measured SAR is ≥ 0.8 W/kg.

WLAN Note:

1. Per KDB 248227 D01v02r02, for 2.4GHz 802.11g/n SAR testing is not required when the highest reported SAR for DSSS is adjusted by the ratio of OFDM to DSSS specified maximum output power and the adjusted SAR is ≤ 1.2 W/kg.
2. Per KDB 248227 D01v02r02, WLAN5.2GHz SAR testing is not required when the WLAN5.3GHz band highest reported SAR for a test configuration is ≤ 1.2 W/kg, SAR is not required for WLAN5.2GHz band.
3. When the reported SAR of the test position is > 0.4 W/kg, SAR is repeated for the 802.11 transmission mode configuration tested in the initial test position to measure the subsequent next closet/smallest test separation distance and maximum coupling test position on the highest maximum output power channel, until the report SAR is ≤ 0.8 W/kg or all required test position are tested.
4. For all positions / configurations, when the reported SAR is > 0.8 W/kg, SAR is measured for these test positions / configurations on the subsequent next highest measured output power channel(s) until the reported SAR is ≤ 1.2 W/kg or all required channels are tested.
5. For determination of the scaling factor for report SAR of MIMO mode, if the hot spots are separated the scaling factors are individually determined from each transmit chain. If the hot spots are not spatially separated, the scaling factor is determined from the worst number of each transmit chain
6. During SAR testing the WLAN transmission was verified using a spectrum analyzer.



13.1 Body SAR

<WLAN SAR>

Plot No.	Band	Mode	Test Position	Gap (mm)	Antenna	Ch.	Freq. (MHz)	Average Power (dBm)	Tune-Up Limit (dBm)	Tune-up Scaling Factor	Duty Cycle %	Duty Cycle Scaling Factor	Power Drift (dB)	Measured 1g SAR (W/kg)	Reported 1g SAR (W/kg)
	WLAN2.4GHz	802.11b 1Mbps	Bottom of Laptop	0mm	Ant 1+2(1)	1	2412	18.60	19.00	1.096	99.7	1.003	-0.12	0.001	0.001
	WLAN2.4GHz	802.11b 1Mbps	Bottom of Laptop	0mm	Ant 1+2(2)	1	2412	18.90	19.00	1.023	99.7	1.003	-0.12	0.001	0.001
	WLAN2.4GHz	802.11b 1Mbps	Bottom Face	0mm	Ant 1+2(1)	11	2462	15.80	16.00	1.047	99.70	1.003	-0.01	0.001	0.001
	WLAN2.4GHz	802.11b 1Mbps	Bottom Face	0mm	Ant 1+2(2)	11	2462	16.00	16.00	1.000	99.70	1.003	-0.01	0.001	0.001
	WLAN2.4GHz	802.11b 1Mbps	Edge 3	0mm	Ant 1+2(1)	11	2462	15.80	16.00	1.047	99.70	1.003	0.09	0.235	0.247
	WLAN2.4GHz	802.11b 1Mbps	Edge 3	0mm	Ant 1+2(2)	11	2462	16.00	16.00	1.000	99.70	1.003	0.09	0.184	0.185
	WLAN2.4GHz	802.11b 1Mbps	Edge 3	0mm	Ant 1+2(1)	1	2412	15.50	16.00	1.122	99.70	1.003	-0.15	0.237	0.267
	WLAN2.4GHz	802.11b 1Mbps	Edge 3	0mm	Ant 1+2(2)	1	2412	15.80	16.00	1.047	99.70	1.003	-0.15	0.174	0.183
01	WLAN2.4GHz	802.11b 1Mbps	Edge 3	0mm	Ant 1+2(1)	6	2437	15.50	16.00	1.122	99.70	1.003	-0.09	0.265	0.298
	WLAN2.4GHz	802.11b 1Mbps	Edge 3	0mm	Ant 1+2(2)	6	2437	15.80	16.00	1.047	99.70	1.003	-0.09	0.181	0.190
	WLAN2.4GHz	802.11b 1Mbps	Edge 3	0mm	Ant 1+2(1)	12	2467	15.40	15.50	1.023	99.70	1.003	-0.01	0.221	0.227
	WLAN2.4GHz	802.11b 1Mbps	Edge 3	0mm	Ant 1+2(2)	12	2467	15.40	15.50	1.023	99.70	1.003	-0.01	0.156	0.160
	WLAN2.4GHz	802.11b 1Mbps	Edge 3	0mm	Ant 1+2(1)	13	2472	8.90	9.00	1.023	99.70	1.003	-0.18	0.059	0.061
	WLAN2.4GHz	802.11b 1Mbps	Edge 3	0mm	Ant 1+2(2)	13	2472	8.90	9.00	1.023	99.70	1.003	-0.18	0.048	0.049
	WLAN5GHz	802.11a 6Mbps	Bottom of Laptop	0mm	Ant 1+2(1)	52	5260	18.20	18.50	1.072	97.5	1.026	-0.13	0.094	0.103
	WLAN5GHz	802.11a 6Mbps	Bottom of Laptop	0mm	Ant 1+2(2)	52	5260	17.70	18.50	1.202	97.5	1.026	-0.13	0.094	0.116
	WLAN5GHz	802.11ac-VHT80 MCS0	Bottom Face	0mm	Ant 1+2(1)	58	5290	13.00	13.00	1.000	87.6	1.142	0.11	0.057	0.065
	WLAN5GHz	802.11ac-VHT80 MCS0	Bottom Face	0mm	Ant 1+2(2)	58	5290	12.80	13.00	1.047	87.6	1.142	0.11	0.063	0.075
02	WLAN5GHz	802.11ac-VHT80 MCS0	Edge 3	0mm	Ant 1+2(1)	58	5290	13.00	13.00	1.000	87.6	1.142	0.11	0.531	0.606
	WLAN5GHz	802.11ac-VHT80 MCS0	Edge 3	0mm	Ant 1+2(2)	58	5290	12.80	13.00	1.047	87.6	1.142	0.11	0.393	0.470
	WLAN5GHz	802.11a 6Mbps	Bottom of Laptop	0mm	Ant 1+2(1)	132	5660	18.30	18.50	1.047	97.5	1.026	-0.07	0.096	0.103
	WLAN5GHz	802.11a 6Mbps	Bottom of Laptop	0mm	Ant 1+2(2)	132	5660	18.10	18.50	1.096	97.5	1.026	-0.07	0.120	0.135
	WLAN5GHz	802.11ac-VHT80 MCS0	Bottom Face	0mm	Ant 1+2(1)	106	5530	12.30	13.00	1.175	87.6	1.142	-0.03	0.057	0.076
	WLAN5GHz	802.11ac-VHT80 MCS0	Bottom Face	0mm	Ant 1+2(2)	106	5530	13.00	13.00	1.000	87.6	1.142	-0.03	0.129	0.147
03	WLAN5GHz	802.11ac-VHT80 MCS0	Edge 3	0mm	Ant 1+2(1)	106	5530	12.30	13.00	1.175	87.6	1.142	0.16	0.653	0.876
	WLAN5GHz	802.11ac-VHT80 MCS0	Edge 3	0mm	Ant 1+2(2)	106	5530	13.00	13.00	1.000	87.6	1.142	0.16	0.496	0.566
	WLAN5GHz	802.11ac-VHT80 MCS0	Edge 3	0mm	Ant 1+2(1)	122	5610	12.60	13.00	1.096	87.6	1.142	0.01	0.658	0.824
	WLAN5GHz	802.11ac-VHT80 MCS0	Edge 3	0mm	Ant 1+2(2)	122	5610	12.70	13.00	1.072	87.6	1.142	0.01	0.356	0.436
	WLAN5GHz	802.11ac-VHT80 MCS0	Edge 3	0mm	Ant 1+2(1)	138	5690	12.70	13.00	1.072	87.6	1.142	0.06	0.677	0.828
	WLAN5GHz	802.11ac-VHT80 MCS0	Edge 3	0mm	Ant 1+2(2)	138	5690	12.50	13.00	1.122	87.6	1.142	0.06	0.363	0.465
	WLAN5GHz	802.11a 6Mbps	Bottom of Laptop	0mm	Ant 1+2(1)	149	5745	18.30	18.50	1.047	97.5	1.026	0.04	0.054	0.058
	WLAN5GHz	802.11a 6Mbps	Bottom of Laptop	0mm	Ant 1+2(2)	149	5745	17.90	18.50	1.148	97.5	1.026	0.04	0.061	0.072
	WLAN5GHz	802.11ac-VHT80 MCS0	Bottom Face	0mm	Ant 1+2(1)	155	5775	12.70	13.00	1.072	87.6	1.142	-0.1	0.048	0.059
	WLAN5GHz	802.11ac-VHT80 MCS0	Bottom Face	0mm	Ant 1+2(2)	155	5775	12.50	13.00	1.122	87.6	1.142	-0.1	0.063	0.081
04	WLAN5GHz	802.11ac-VHT80 MCS0	Edge 3	0mm	Ant 1+2(1)	155	5775	12.70	13.00	1.072	87.6	1.142	0.05	0.614	0.751
	WLAN5GHz	802.11ac-VHT80 MCS0	Edge 3	0mm	Ant 1+2(2)	155	5775	12.50	13.00	1.122	87.6	1.142	0.05	0.360	0.461

<Bluetooth SAR>

Plot No.	Band	Mode	Test Position	Gap (mm)	Antenna	Ch.	Freq. (MHz)	Average Power (dBm)	Tune-Up Limit (dBm)	Tune-up Scaling Factor	Duty Cycle %	Duty Cycle Scaling Factor	Power Drift (dB)	Measured 1g SAR (W/kg)	Reported 1g SAR (W/kg)
	Bluetooth	1Mbps	Bottom of Laptop	0mm	Ant 1	0	2402	10.70	11.50	1.202	76.8	1.302	0.1	0.001	0.002
	Bluetooth	1Mbps	Bottom Face	0mm	Ant 1	0	2402	5.95	6.00	1.012	76.8	1.302	-0.04	0.001	0.002
	Bluetooth	1Mbps	Edge 3	0mm	Ant 1	0	2402	5.95	6.00	1.012	76.8	1.302	0.02	0.032	0.042
05	Bluetooth	1Mbps	Edge 3	0mm	Ant 1	39	2441	5.91	6.00	1.021	76.8	1.302	0.07	0.034	0.045
	Bluetooth	1Mbps	Edge 3	0mm	Ant 1	78	2480	5.88	6.00	1.028	76.8	1.302	-0.08	0.031	0.041

14. Simultaneous Transmission Analysis

NO.	Simultaneous Transmission Configurations	Body
1.	WLAN5GHz Ant 1+2 + Bluetooth Ant 1	Yes

General Note:

1. The Scaled SAR summation is calculated based on the same configuration and test position.
2. Per KDB 447498 D01v06, simultaneous transmission SAR is compliant if,
 - i) Scalar SAR summation < 1.6W/kg.
 - ii) $SPLSR = (SAR1 + SAR2)^{1.5} / (\text{min. separation distance, mm})$, and the peak separation distance is determined from the square root of $[(x1-x2)^2 + (y1-y2)^2 + (z1-z2)^2]$, where (x1, y1, z1) and (x2, y2, z2) are the coordinates of the extrapolated peak SAR locations in the zoom scan.
 - iii) If $SPLSR \leq 0.04$, simultaneously transmission SAR measurement is not necessary.
 - iv) Simultaneously transmission SAR measurement, and the reported multi-band SAR < 1.6W/kg.

14.1 Body Exposure Conditions

Exposure Position	1	2	3	2+3 Summed 1g SAR (W/kg)
	WLAN2.4GHz Ant 1+2 1g SAR (W/kg)	WLAN5GHz Ant 1+2 1g SAR (W/kg)	Bluetooth Ant 1 1g SAR (W/kg)	
Bottom of Laptop at 0mm	0.001	0.135	0.002	0.137
Bottom Face at 0mm	0.001	0.147	0.002	0.149
Edge 3 at 0mm	0.298	0.876	0.045	0.921

Test Engineer : EN Liu and Rain Chiu



15. Uncertainty Assessment

Per KDB 865664 D01 SAR measurement 100MHz to 6GHz, when the highest measured 1-g SAR within a frequency band is < 1.5 W/kg and the measured 10-g SAR within a frequency band is < 3.75 W/kg. The expanded SAR measurement uncertainty must be $\leq 30\%$, for a confidence interval of $k = 2$. If these conditions are met, extensive SAR measurement uncertainty analysis described in IEEE Std 1528-2013 is not required in SAR reports submitted for equipment approval. For this device, the highest measured 1-g SAR is less 1.5W/kg. Therefore, the measurement uncertainty table is not required in this report.

Declaration of Conformity:

The test results with all measurement uncertainty excluded is presented in accordance with the regulation limits or requirements declared by manufacturers.

Comments and Explanations:

The declared of product specification for EUT presented in the report are provided by the manufacturer, and the manufacturer takes all the responsibilities for the accuracy of product specification.

16. References

- [1] FCC 47 CFR Part 2 "Frequency Allocations and Radio Treaty Matters; General Rules and Regulations"
- [2] ANSI/IEEE Std. C95.1-1992, "IEEE Standard for Safety Levels with Respect to Human Exposure to Radio Frequency Electromagnetic Fields, 3 kHz to 300 GHz", September 1992
- [3] IEEE Std. 1528-2013, "IEEE Recommended Practice for Determining the Peak Spatial-Average Specific Absorption Rate (SAR) in the Human Head from Wireless Communications Devices: Measurement Techniques", Sep 2013
- [4] SPEAG DASY System Handbook
- [5] FCC KDB 248227 D01 v02r02, "SAR Guidance for IEEE 802.11 (WiFi) Transmitters", Oct 2015.
- [6] FCC KDB 447498 D01 v06, "Mobile and Portable Device RF Exposure Procedures and Equipment Authorization Policies", Oct 2015
- [7] FCC KDB 616217 D04 v01r02, "SAR Evaluation Considerations for Laptop, Notebook, Netbook and Tablet Computers", Oct 2015
- [8] FCC KDB 865664 D01 v01r04, "SAR Measurement Requirements for 100 MHz to 6 GHz", Aug 2015.
- [9] FCC KDB 865664 D02 v01r02, "RF Exposure Compliance Reporting and Documentation Considerations" Oct 2015.