

TAS ALGORITHM VALIDATION TEST REPORT

EUT Description	XMM 7360 Cellular Modem embedded in Fibocom M2 L850-GL cellular module
Brand Name	Fibocom M2
Model Name	L850-GL
FCC ID	Generic (see note in Section 6)
Date of Test Start/End	2019-02-01 /2019-08-05
Features	LTE, UMTS (see Section 6)

Applicant	Intel Mobile Communications
Address	100 Center Point Circle, Suite 200 Columbia, South Carolina 29210 USA
Contact Person	Steven Hackett
Telephone/Fax/ Email	steven.c.hackett@intel.com

Test Report identification	171110-01.TR02
Revision Control	Rev. 02 This test report revision replaces any previous test report revision (see Section 1)

Intel Corporation S.A.S – Wireless RF Lab (WRF)
425 rue de Goa – Le Cargo B6 - 06600, Antibes, France
Tel. +33493001400 / Fax +33493001401

Table of Contents

1. Document Revision History	4
2. Scope	4
3. General Conditions, Competences and Guarantees	4
4. Environmental Conditions	4
5. Test Sample	4
6. EUT Features	5
7. TAS Algorithm Validation Considerations	5
7.1. ALGORITHM VALIDATION USING CONDUCTED POWER MEASUREMENT	6
7.1.1. PARAMETERS CONSIDERED FOR ALGORITHM VALIDATION	7
7.1.2. TIME VARYING POWER CONTROL TEST SEQUENCES CONSIDERED FOR ALGORITHM VALIDATION	7
7.1.3. CONNECTION DROP AND TECHNOLOGY/BAND HANDOVER VALIDATION	9
7.2. ALGORITHM VALIDATION USING SINGLE-POINT SAR MEASUREMENT	9
7.2.1. SINGLE-POINT SAR TEST PROCEDURES AND POST-PROCESSING REQUIREMENTS	9
7.2.2. CDASY6 TIME-AVERAGE SAR MEASUREMENT PROCEDURES	11
7.2.3. TAS VALIDATION TEST SEQUENCES FOR SINGLE-POINT SAR MEASUREMENT	11
8. Summary of Validation Tests and Results	12
Annex A. Conducted Power and Single-Point SAR Measurement Test Setup	13
A.1 CONDUCTED POWER MEASUREMENT WITH INTEL TEST PLATFORM	13
A.1.1 Test Setup	13
A.1.2 Test Equipment List	14
A.1.3 Conducted Power Test Setup Photos	14
A.2 SINGLE-POINT SAR MEASUREMENT WITH A 2-IN-1 CONVERTIBLE PC	14
A.2.1 2-in-1 Convertible PC Test Platform	14
A.2.2 WWAN Antenna location in the convertible PC platform	15
A.3 TEST SAMPLE AND CONDUCTED POWER TEST PLATFORM	16
Annex B. Conducted Power Validation Test Results	17
B.1 VALIDATION USING CONDUCTED POWER MEASUREMENT WITH INTEL TEST PLATFORM	17
B.2 CONDUCTED POWER TAS VALIDATION TESTS AND RESULTS WITH INTEL TEST PLATFORM	18
B.2.1 Fundamental Algorithm Validation for a Range Control Parameters	18
B.2.1.1 Validation for LTE in Band 2	18
B.2.1.2 Validation of UMTS/WCDMA Band 2	22
B.2.2 Algorithm Validation According to Time Varying Power Control Test Sequences	26
B.2.3 Algorithm Validation for Drop Connection and Technology/Band Handover	28
B.2.3.1 Connection Drop and Reboot Scenario Validation	28
B.2.3.2 Handover Validation from LTE Band 2 to LTE Band 4	30
B.2.3.3 Handover Validation from LTE Band 2 to WCDMA Band 4	31
Annex C. Single-Point SAR Measurement Validation Test Results for 2-in-1 Convertible PC	32
C.1 1-G SAR MEASUREMENT AT SAR_TARGET OF 1.0 W/KG	32
C.2 CASE #1: SINGLE-POINT SAR VALIDATION OF TAS AT MAX_POWER_DPR_OFF	34
C.2.1 1-g SAR with TAS disabled (Max_Power_DPR_OFF) to Identify Peak Location for Single-Point SAR Measurement	34
C.2.2 Single-Point SAR Measurement Results for Max_Power_DPR_OFF	34
C.2.3 Conducted Power Measurement	35



- C.2.4 *Comparison of Normalized Single-Point SAR and Normalized Conducted Power Results* 36
- C.3 CASE #2: SINGLE-POINT SAR VALIDATION FOR TAS USING TEST SEQUENCE #1 37
 - C.3.1 *1-g SAR with TAS disabled (Max_Power_DPR_OFF) to Identify Peak Location for Single-Point SAR Measurement* 37
 - C.3.2 *Single-Point SAR Measurement Results for Test Sequence #1* 37
 - C.3.3 *Conducted Power Measurement* 38
 - C.3.4 *Comparison of Normalized Single-Point SAR and Normalized Conducted Power Results* 39

1. Document Revision History

Revision #	Date	Modified by	Revision Details
Rev. 00	2019-08-05	Walid EL HAJJ	First Issue
Rev. 01	2019-08-09	Walid EL HAJJ	Address FCC Comments
Rev. 02	2019-08-23	Walid EL HAJJ	Address FCC Comments

2. Scope

This document describes the Time-Averaging SAR (**TAS**) algorithm validation test setup and measurement results of the XMM 7360 Cellular Modem incorporated in a Fibocom M2 L850-GL cellular module. The implementation details and **TAS** operating characteristics are described in the "Operation Descriptions" document (confidential); therefore, only a brief summary of the **TAS** operating parameters is included in this test report. The validation tests are performed using mainly conducted power measurements. Single-point SAR measurements are also performed using a generic 2-in-1 convertible PC for correlating the conducted power and SAR measurement results. The details of the test procedures are described in Section 7. The conducted power and single-point SAR measurement test setup and validation results are included in Annex A, B and C. The validation results demonstrate that **TAS** can reliably apply dynamic power control to ensure SAR compliance in real-time.

3. General Conditions, Competences and Guarantees

- ✓ Intel Corporation SAS Wireless RF Lab (Intel WRF Lab) is an ISO/IEC 17025:2005 testing laboratory accredited by the American Association for Laboratory Accreditation (A2LA) with the certificate number 3478.01.
- ✓ Intel Corporation SAS Wireless RF Lab (Intel WRF Lab) is an Accredited Test Firm recognized by the FCC, with Designation Number FR0011.
- ✓ Intel WRF Lab only provides testing services and is committed to providing reliable, unbiased test results and interpretations.
- ✓ Intel WRF Lab is liable to its client for maintaining confidentiality of all information and test results relating to the item under test.
- ✓ Intel WRF Lab has developed calibration and proficiency programs to ensure the measurement equipment used are providing correlated and reliable test results to its customers.
- ✓ This report is only relevant to the item that has undergone testing.
- ✓ This report does not imply an approval of the product by the Certification Bodies or competent Authorities.

4. Environmental Conditions

During the tests, the environmental conditions at the site where the measurements were performed are given in the following table:

Temperature	22°C
Humidity	43%

5. Test Sample

Sample	Control #	Description	Model	Serial #	Note
#1	170307-01.S02	Modem Module	M2 7360 PR4.2	D1B3HD00JF	Conducted Power & Single-Point SAR Tests
	180522-03.S03	Extender Board	-	-	Conducted Power Tests
	190131-02.S01	2-in-1 Convertible PC	-	A5CD810001C	Conducted Power & Single-Point SAR Tests

6. EUT Features

Brand Name	Fibocom M2																																																																																																																																																																						
Model Name	L850-GL																																																																																																																																																																						
FCC ID	Generic*																																																																																																																																																																						
Software Version Date	Bender EB165941.1 2018-10-19																																																																																																																																																																						
Supported Wireless Configurations and Operating Modes	The Fibocom M2 L850 GL module supports only UMTS and LTE, without carrier aggregation. The applicable frequency bands and operating modes are identified in the following table, where North America bands are shown in bold.																																																																																																																																																																						
	<table border="1"> <thead> <tr> <th rowspan="2">Mode</th> <th rowspan="2">Bands</th> <th colspan="4">Supported Tx Mode</th> </tr> <tr> <th>WCDMA</th> <th>HSDPA</th> <th>HSUPA</th> <th>DC-HSDPA</th> </tr> </thead> <tbody> <tr> <td rowspan="4">WCDMA / HSPA+</td> <td>FDD II (1850.0 – 1910.0 MHz)</td> <td>✓</td> <td>✓</td> <td>✓</td> <td>✓</td> </tr> <tr> <td>FDD IV (1710.0 – 1755.0 MHz)</td> <td>✓</td> <td>✓</td> <td>✓</td> <td>✓</td> </tr> <tr> <td>FDD V (824.0 – 849.0 MHz)</td> <td>✓</td> <td>✓</td> <td>✓</td> <td>✓</td> </tr> <tr> <td>FDD VIII (880.0 – 915.0 MHz)</td> <td>✓</td> <td>✓</td> <td>✓</td> <td>✓</td> </tr> <tr> <th>Mode</th> <th>Bands</th> <th colspan="5">Supported Channel Bandwidth (MHz)</th> </tr> <tr> <td></td> <td></td> <td>1.4</td> <td>3</td> <td>5</td> <td>10</td> <td>15</td> <td>20</td> </tr> <tr> <td rowspan="14">LTE FDD</td> <td>Band 2 (1850.0 – 1910.0 MHz)</td> <td>✓</td> <td>✓</td> <td>✓</td> <td>✓</td> <td>✓</td> <td>✓</td> </tr> <tr> <td>Band 4 (1710.0 – 1755.0 MHz)</td> <td>✓</td> <td>✓</td> <td>✓</td> <td>✓</td> <td>✓</td> <td>✓</td> </tr> <tr> <td>Band 5 (824.0 – 849.0 MHz)</td> <td>✓</td> <td>✓</td> <td>✓</td> <td>✓</td> <td>✓</td> <td>✓</td> </tr> <tr> <td>Band 7 (2500.0 – 2570.0 MHz)</td> <td></td> <td></td> <td>✓</td> <td>✓</td> <td>✓</td> <td>✓</td> </tr> <tr> <td>Band 12 (699.0 – 716.0 MHz)</td> <td>✓</td> <td>✓</td> <td>✓</td> <td>✓</td> <td>✓</td> <td>✓</td> </tr> <tr> <td>Band 13 (777.0 – 787.0 MHz)</td> <td></td> <td></td> <td>✓</td> <td>✓</td> <td></td> <td></td> </tr> <tr> <td>Band 17 (704.0 – 716.0 MHz)</td> <td></td> <td></td> <td>✓</td> <td>✓</td> <td></td> <td></td> </tr> <tr> <td>Band 18 (815.0 – 830.0 MHz)</td> <td>✓</td> <td>✓</td> <td>✓</td> <td>✓</td> <td>✓</td> <td>✓</td> </tr> <tr> <td>Band 19 (830.0 – 845.0 MHz)</td> <td>✓</td> <td>✓</td> <td>✓</td> <td>✓</td> <td>✓</td> <td>✓</td> </tr> <tr> <td>Band 26 (814.0 – 849.0 MHz)</td> <td>✓</td> <td>✓</td> <td>✓</td> <td>✓</td> <td>✓</td> <td>✓</td> </tr> <tr> <td>Band 28 (703.0 – 748.0 MHz)</td> <td>✓</td> <td>✓</td> <td>✓</td> <td>✓</td> <td>✓</td> <td>✓</td> </tr> <tr> <td>Band 30 (2305.0 – 2315.0 MHz)</td> <td>✓</td> <td>✓</td> <td>✓</td> <td>✓</td> <td>✓</td> <td>✓</td> </tr> <tr> <td>Band 66 (1710.0 – 1780.0 MHz)</td> <td>✓</td> <td>✓</td> <td>✓</td> <td>✓</td> <td>✓</td> <td>✓</td> </tr> <tr> <td rowspan="3">LTE TDD</td> <td>Band 38 (2570.0 – 2620.0 MHz)</td> <td>✓</td> <td>✓</td> <td>✓</td> <td>✓</td> <td>✓</td> <td>✓</td> </tr> <tr> <td>Band 40 (2300.0 – 2400.0 MHz)</td> <td>✓</td> <td>✓</td> <td>✓</td> <td>✓</td> <td>✓</td> <td>✓</td> </tr> <tr> <td>Band 41 (2496.0 – 2690.0 MHz)</td> <td>✓</td> <td>✓</td> <td>✓</td> <td>✓</td> <td>✓</td> <td>✓</td> </tr> </tbody> </table>							Mode	Bands	Supported Tx Mode				WCDMA	HSDPA	HSUPA	DC-HSDPA	WCDMA / HSPA+	FDD II (1850.0 – 1910.0 MHz)	✓	✓	✓	✓	FDD IV (1710.0 – 1755.0 MHz)	✓	✓	✓	✓	FDD V (824.0 – 849.0 MHz)	✓	✓	✓	✓	FDD VIII (880.0 – 915.0 MHz)	✓	✓	✓	✓	Mode	Bands	Supported Channel Bandwidth (MHz)							1.4	3	5	10	15	20	LTE FDD	Band 2 (1850.0 – 1910.0 MHz)	✓	✓	✓	✓	✓	✓	Band 4 (1710.0 – 1755.0 MHz)	✓	✓	✓	✓	✓	✓	Band 5 (824.0 – 849.0 MHz)	✓	✓	✓	✓	✓	✓	Band 7 (2500.0 – 2570.0 MHz)			✓	✓	✓	✓	Band 12 (699.0 – 716.0 MHz)	✓	✓	✓	✓	✓	✓	Band 13 (777.0 – 787.0 MHz)			✓	✓			Band 17 (704.0 – 716.0 MHz)			✓	✓			Band 18 (815.0 – 830.0 MHz)	✓	✓	✓	✓	✓	✓	Band 19 (830.0 – 845.0 MHz)	✓	✓	✓	✓	✓	✓	Band 26 (814.0 – 849.0 MHz)	✓	✓	✓	✓	✓	✓	Band 28 (703.0 – 748.0 MHz)	✓	✓	✓	✓	✓	✓	Band 30 (2305.0 – 2315.0 MHz)	✓	✓	✓	✓	✓	✓	Band 66 (1710.0 – 1780.0 MHz)	✓	✓	✓	✓	✓	✓	LTE TDD	Band 38 (2570.0 – 2620.0 MHz)	✓	✓	✓	✓	✓	✓	Band 40 (2300.0 – 2400.0 MHz)	✓	✓	✓	✓	✓	✓	Band 41 (2496.0 – 2690.0 MHz)	✓	✓	✓	✓	✓	✓
	Mode	Bands	Supported Tx Mode																																																																																																																																																																				
			WCDMA	HSDPA	HSUPA	DC-HSDPA																																																																																																																																																																	
	WCDMA / HSPA+	FDD II (1850.0 – 1910.0 MHz)	✓	✓	✓	✓																																																																																																																																																																	
		FDD IV (1710.0 – 1755.0 MHz)	✓	✓	✓	✓																																																																																																																																																																	
		FDD V (824.0 – 849.0 MHz)	✓	✓	✓	✓																																																																																																																																																																	
		FDD VIII (880.0 – 915.0 MHz)	✓	✓	✓	✓																																																																																																																																																																	
	Mode	Bands	Supported Channel Bandwidth (MHz)																																																																																																																																																																				
			1.4	3	5	10	15	20																																																																																																																																																															
	LTE FDD	Band 2 (1850.0 – 1910.0 MHz)	✓	✓	✓	✓	✓	✓																																																																																																																																																															
		Band 4 (1710.0 – 1755.0 MHz)	✓	✓	✓	✓	✓	✓																																																																																																																																																															
		Band 5 (824.0 – 849.0 MHz)	✓	✓	✓	✓	✓	✓																																																																																																																																																															
		Band 7 (2500.0 – 2570.0 MHz)			✓	✓	✓	✓																																																																																																																																																															
		Band 12 (699.0 – 716.0 MHz)	✓	✓	✓	✓	✓	✓																																																																																																																																																															
		Band 13 (777.0 – 787.0 MHz)			✓	✓																																																																																																																																																																	
		Band 17 (704.0 – 716.0 MHz)			✓	✓																																																																																																																																																																	
		Band 18 (815.0 – 830.0 MHz)	✓	✓	✓	✓	✓	✓																																																																																																																																																															
		Band 19 (830.0 – 845.0 MHz)	✓	✓	✓	✓	✓	✓																																																																																																																																																															
		Band 26 (814.0 – 849.0 MHz)	✓	✓	✓	✓	✓	✓																																																																																																																																																															
		Band 28 (703.0 – 748.0 MHz)	✓	✓	✓	✓	✓	✓																																																																																																																																																															
		Band 30 (2305.0 – 2315.0 MHz)	✓	✓	✓	✓	✓	✓																																																																																																																																																															
		Band 66 (1710.0 – 1780.0 MHz)	✓	✓	✓	✓	✓	✓																																																																																																																																																															
LTE TDD		Band 38 (2570.0 – 2620.0 MHz)	✓	✓	✓	✓	✓	✓																																																																																																																																																															
	Band 40 (2300.0 – 2400.0 MHz)	✓	✓	✓	✓	✓	✓																																																																																																																																																																
	Band 41 (2496.0 – 2690.0 MHz)	✓	✓	✓	✓	✓	✓																																																																																																																																																																

*Note: The algorithm validation is host independent. This report can be used for any host with TAS parameters in the validation range.

7. TAS Algorithm Validation Considerations

As described in the “Operation Descriptions” document, **TAS** has 5 parameters that are accessible to host devices incorporating the XMM 7360 Cellular Modem. There are two additional control and operating parameters that are derived from these 5 accessible parameters. The parameters are identified in Table 1 below. An illustration of **TAS** functionality, according to these parameters, is shown in Figure 1. Since **TAS** is fully contained within the XMM 7360 Cellular Modem, other than allowing a host device to select the accessible parameters, **TAS** operation is fully independent of the host product.

Table 1 – XMM 7360 Operating Parameters

Accessible Parameters	Derived Parameters
<i>Avg_SAR_UppThresh</i>	$Avg_SAR_LowThresh = Avg_SAR_UppThresh - DPR_OFF_SAR_Offset$
<i>DPR_ON_SAR_Offset</i>	$Max_Power_DPR_ON = Avg_SAR_UppThresh - DPR_ON_SAR_Offset$
<i>DPR_OFF_SAR_Offset</i>	
<i>Avg_SAR_Check_Period</i>	
<i>Avg_SAR_Roll_Period</i>	

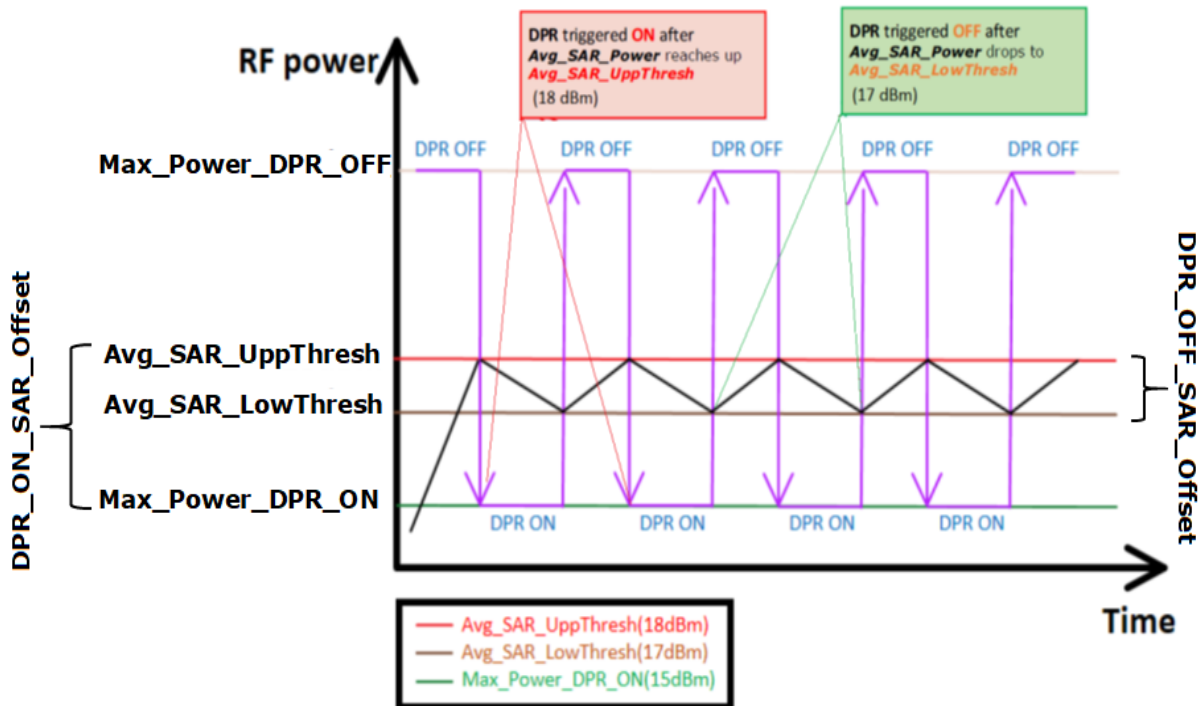

Figure 1 – Power control dynamics of TAS Algorithm for ensuring SAR compliance

When XMM 7360 operates in the end user environment, **TAS** is always enabled; end users do not have the option to disable **TAS**. Therefore, the time-averaged power (**Avg_SAR_Power**) is always kept below the specified upper power threshold (**Avg_SAR_UppThresh**) and SAR compliance is determined in real-time at each **Avg_SAR_Check_Period** according to the time-averaging window **Avg_SAR_Roll_Period**. The required settings of **Avg_SAR_Roll_Period** and **Avg_SAR_Check_Period** for the XMM 7360 Cellular Modem are 100 sec and below 1 sec, respectively.

7.1. Algorithm Validation using Conducted Power Measurement

TAS operating characteristics and algorithm implementation have been validated using conducted power measurement according to parameters that are applicable to the host products. **TAS** is fully self-contained within the XMM 7360 and, other than the power recording time interval used for UMTS and LTE, 10 msec vs. 1 msec, the same power control mechanism is applied to both 3G and 4G. Since **TAS** operations are independent of frequency band and wireless mode, and SAR compliance can be established at the maximum time-averaged power level specified by **Avg_SAR_UppThresh**, validation of the algorithm and implementation using conduct power measurement test configurations is appropriate and acceptable.

The following XMM 7360 operating conditions are used in the conducted power measurement configurations to validate **TAS** algorithm implementation. The conducted power measurement test setup is described in Annex A.1.

1. using a diverse range of **TAS** operating and control parameters under maximum output power conditions specified for UMTS and LTE
2. specific power control test sequences are applied under normal UMTS and LTE operations in Connected states
3. when a connection is dropped and re-established
4. when a handover occurs between frequency bands and modes within LTE or UMTS
5. when a handover occurs between LTE and UMTS

7.1.1. Parameters Considered for Algorithm Validation

TAS algorithm validation has been performed for UMTS and LTE according to cases with different combinations of operating parameters listed in Table 2, see details in Tables B.1 and B.2. All attenuations and offsets are accounted for in uplink power measurements at the Main Antenna port. This is described in Annex A.1.1 and illustrated in the test setup photos in Annex A.1.3. The test results are shown in Annex B.2.1.1 for LTE and Annex B.2.1.2 for UMTS.

Table 2 –Parameters used in Validation

Parameters
<i>Avg_SAR_UppThresh</i>
<i>Avg_SAR_LowThresh</i>
<i>Max_Power_DPR_ON</i>

7.1.2. Time Varying Power Control Test Sequences Considered for Algorithm Validation

Two types of power control test sequences are used in the conducted power measurement test setup for **TAS** algorithm validation in selected mode/band configurations under normal LTE and UMTS operations in Connected State. The first test sequence (#1) is for validating the functionality of **DPR** (Dynamic Power Reduction) according to the values of **Max_Power_DPR_OFF**, **Max_Power_DPR_ON**, **Avg_SAR_UppThresh** and **Avg_SAR_LowThresh** specified for the mode/band. The second test sequence (#2) consists of a pre-determined sequence of random or arbitrary power levels and durations for validating overall **TAS** functionality to ensure SAR compliance through dynamic power control.

1. Sequence #1: Starting at below **Avg_SAR_LowThresh** for a fixed duration, the sequence is followed by a sufficiently long duration of transmission at **Max_Power_DPR_OFF** until **DPR** is turned ON. After it is confirmed that **Avg_SAR_Power** remains between **Avg_SAR_UppThresh** and **Avg_SAR_LowThresh**, the XMM 7360 is commanded to reduce output power to below **Avg_SAR_LowThresh** to ensure **DPR** is subsequently turned OFF.
2. Sequence #2: A power profile consisting of varying levels between **Max_Power_DPR_OFF** and below **Max_Power_DPR_ON**, with varying transmission durations in the range of 1 – 20 seconds, are sent by the Call Box to the XMM 7360. The power levels and intervals used in the tests have been determined according to KDB guidance and preliminary test results.

The time durations and power levels used for the two test sequences are listed in Table 3 and Table 4. These sequences are applied to validate **TAS** in both UMTS and LTE. In Table 3, for sequence #1, the power level is set to an initial level below **Max_Power_DPR_ON** and followed by maximum output power (**Max_Power_DPR_OFF**) requests from the Call Box to verify **DPR** control and **TAS** responses. This is then followed by a Call Box output power request of below **Max_Power_DPR_ON** to ensure proper **TAS** response is observed when **DPR** is disabled. Table 4 consists of the sequence of power levels and time durations sent from the Call Box to XMM 7360 to validate dynamic power control under arbitrary/random conditions, similar to those experienced by typical end users, to demonstrate **DPR** reliability. Both of these sequences are illustrated in Figure 2.

Table 3 – Test Sequence #1

Sequence 1			
Time	Duration	Tx Power	Notes
150	150	5 dBm	< Low Threshold
350	200	23	Max power
720	370	13	Lower -2 dB

Table 4 – Test Sequence #2

Sequence 2			
Time	Duration	Tx Power	Notes
150	150	5 dBm	< Lower
165	15	14	Upper-4dB
185	20	18	Upper
205	20	20,5	(Upper+Pmax)/2
215	10	10	Upper-8dB
235	20	23	Pmax
250	15	18	Upper
265	15	11	Upper-7dB
285	20	23	Pmax
305	20	13	Upper -5dB
320	15	18	Upper
330	10	12	Upper-6dB
340	10	20,5	Upper+max/2
360	20	11	Upper -7 dB
380	20	11	Upper - 7dB
390	10	20,5	Upper+max/2
400	10	12	Upper-6dB
415	15	18	Upper
435	20	13	Upper -5dB
455	20	23	Pmax
465	10	11	Upper-7dB
480	15	18	Upper
500	20	23	Pmax
515	15	10	Upper-8dB
535	20	20,5	(Upper+Pmax)/2
555	20	18	Upper
570	15	14	Upper-4dB
720	150	5	< Lower Threshold

Note: Pmax=Max_Power_DPR_OFF (23 dBm),
 Upper=Avg_SAR_UppThresh (18 dBm) and Lower = Avg_SAR_LowThresh (15 dBm)

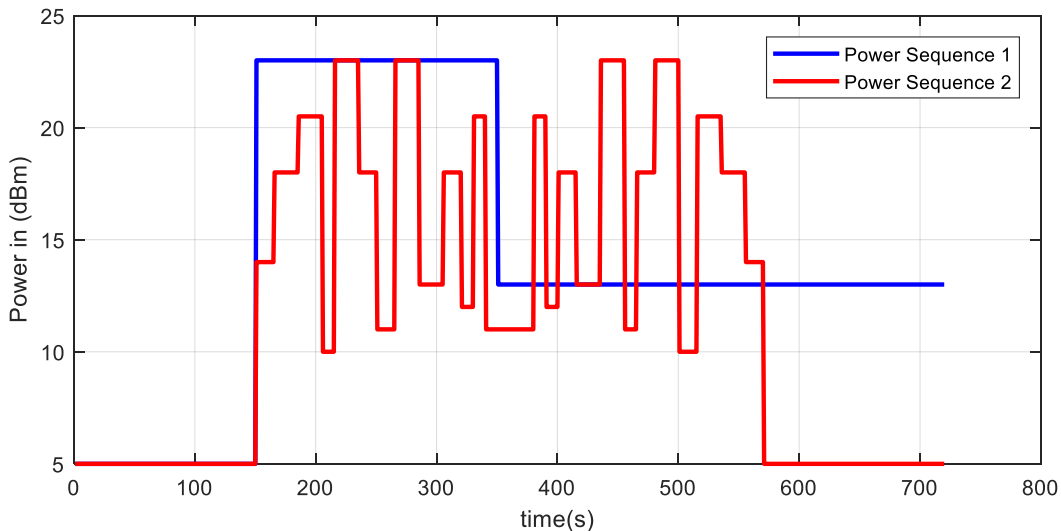
Figure 2 – Plot of Tx power for test sequence #1 and #2

For each test sequence, TAS should respond by maintaining **Avg_SAR_Power** at or below **Avg_SAR_UppThresh** according to **DPR** requirements; therefore, SAR measurement at **Avg_SAR_UppThresh** according to normally required SAR procedures is all that would be necessary to determine compliance. These are demonstrated by the supporting test results in Annex B.2.2.

7.1.3. Connection Drop and Technology/Band Handover Validation

In order to demonstrate that **TAS** functions as expected during a drop connection or handover, the first test sequence (#1) in Section 7.1.2 (Table 3) is adapted to validate algorithm control continuity during such temporarily discontinued transmissions. A connection drop or handover is initiated after **DPR** is turned ON and **Avg_SAR_Power** is maintained between **Avg_SAR_UppThresh** and **Avg_SAR_LowThresh**. When the connection is re-established, maximum output power is requested by the Call Box to ensure **DPR** remains ON and **TAS** response is verified to ensure algorithm control continuity. These are demonstrated by the validation results in Annex B.2.3.

7.2. Algorithm Validation using Single-Point SAR Measurement

For algorithm validation testing purposes, when XMM 7360 is put in Test Mode; power is always monitored and **Avg_SAR_Power** is calculated by the XMM 7360 regardless of whether **TAS** is enabled or disabled. Single-point SAR measurements are performed at the peak SAR location of the corresponding 1-g SAR measurements. In applying the cDASY6 **TAS** SAR measurement procedures described in Section 7.2.2, an initial 1-g SAR measurement is performed at maximum output power (**Max_Power_DPR_OFF**), with **TAS** disabled, to determine the peak location. The XMM 7360 is switched from the **TAS** disabled to **TAS** enabled state at the completion of the 1-g SAR measurement to continue with the single-point SAR measurement. Under such testing circumstances, **DPR** would turn ON immediately after the switch over and instantaneous output is set to **Max_Power_DPR_ON** until **Avg_SAR_Power** falls below **Avg_SAR_LowThresh**. This is normal for the XMM 7360 when it is operating in Test Mode, as compared to a gradual increase of **Avg_SAR_Power** observed from a reboot condition in the end user environment. This switch over is also reflected in the single-point SAR and conducted power validation plots shown in Annex C to demonstrate the correlation between single-point SAR and conducted power measurement results.

Two examples of **TAS** algorithm validation using single-point SAR and conducted power measurements are included in this report to confirm the correspondence between conducted power and SAR, both in time and magnitude. The validation tests are performed with the Fibocom M2 module installed in a generic 2-in-1 convertible PC, where SAR is measured for the pre-installed WWAN antenna in the PC. The antenna location, host device SAR measurement position and wireless mode configurations are described in Annex A.2. The Time-Average SAR Measurement Procedure in the cDASY6 SAR system is used for the single-point SAR measurement at the peak SAR location determined by a 1-g SAR measurement. The measurement and post-processing procedures are explained in this section.

The **TAS** parameters selected for the host PC are based on an upper threshold power level (**Avg_SAR_UppThresh**) corresponding to a targeted 1-g SAR of 1.0 W/kg. The single-point SAR and conducted power validations are performed using two test sequences; where the Call Box is configured to (1) continuously request for maximum output power (**Max_Power_DPR_OFF**), similar to the test cases in Annex B.2.1, and (2) send the predefined test sequence #1 described in Table 3 of Section 7.1.2. The single-point SAR and conducted power measurement results are plotted separately and then normalized for comparison on the same plot, as shown in Annex C. The results show good correlation between conducted power and single-point SAR in both time and magnitude.

7.2.1. Single-Point SAR Test Procedures and Post-Processing Requirements

The criteria used to select **TAS** parameters for the host PC and **TAS** measurement details are described in the following. The Fibocom M2 module is installed in the keyboard section of the convertible PC, as illustrated in Section A.2.2. The validation tests are performed with the PC configured to operate in Tablet mode, where the WWAN Main antenna is located along the top edge of the display and under **TAS** control. Since the XMM 7360 supports only one Tx port, the received only WWAN Aux antenna is not controlled by **TAS**. The validation tests are performed using LTE Band 2, on the low channel, with QPSK, 20 MHz bandwidth and 1 RB. The following steps are applied to determine the **Avg_SAR_UppThresh** at a targeted (predefined) 1-g SAR level and an equivalent upper threshold for the corresponding single-point SAR:

1. A complete 1-g SAR measurement, as required for normal SAR testing, is performed at the maximum output power (**Max_Power_DPR_OFF**) of 23.18 dBm with **TAS** disabled. The measured 1-g SAR is noted (**SAR_ref**).
2. The **Avg_SAR_UppThresh** for a targeted 1-g SAR (**SAR_target**) of 1.0 W/kg is determined by scaling, where:

$$Avg_SAR_UppThresh = Max_Power_DPR_OFF \times \frac{SAR_target}{SAR_ref}$$

For this convertible PC, **DPR_ON_SAR_Offset** and **DPR_OFF_SAR_Offset** are set to 1 dB and 2 dB respectively; therefore, **Avg_SAR_UppThresh**, **Avg_SAR_LowThresh** and **Max_Power_DPR_ON** are 20.5 dBm, 19.5 dBm and 18.5 dBm, respectively. The **Avg_SAR_Check_Period** and **Avg_SAR_Roll_Period** are set to 1 sec and 100 sec respectively.

3. A complete 1-g SAR measurement using the same wireless configuration in step 1 is performed at the power level established for **Avg_SAR_UpperThresh** (20.5 dBm) with **TAS** disabled. This measured 1-g SAR is 1.01 W/kg, as shown in Annex C.1, which closely matches the selected value of **SAR_target** used in step 2 to establish **Avg_SAR_UppThresh**.
4. The “Time-Average SAR Measurement” procedures in cDASY6 is used for the single-point SAR measurements (see Section 7.2.2):

a) The 1-g SAR measurement in step 1, at maximum output power (**Max_Power_DPR_OFF**) with **TAS** disabled, is also used to establish the peak SAR location to perform single-point SAR measurements. The interpolated SAR at the peak location is used to derive the equivalent of **Avg_SAR_UppThresh** for the single-point SAR; see **SSAR_Avg_UppThresh** and **SAR_instantaneous_max** in step 4 b).

b) Single-point SAR is measured at the peak SAR location determined in step 4 a) for 720 sec with **TAS** enabled. The measurement point is fixed at 1.4 mm from the phantom surface. The measurement time resolution is 0.5 sec. The time sequence of single-point SAR values (**SAR_instantaneous(t)**), are averaged to calculate **SAR_average(t)** according to **TAS** algorithm:

The 1-g SAR (**SAR_target** at 1.0 W/kg) established for **Avg_SAR_UppThresh** is used to derive an equivalent upper threshold (**SSAR_Avg_UppThresh**) for correlating single-point SAR with conducted power results:

$$SSAR_Avg_UppThresh = SAR_instantaneous_max \times \frac{SAR_target}{SAR_ref}$$

where **SAR_instantaneous_max** is the highest point SAR at the peak SAR location of the 1-g SAR measurement in step 4 a) at **Max_Power_DPR_OFF** with **TAS** disabled.

5. Step 4 is repeated using conducted power measurement, without the phantom. The same measurement time intervals and durations used in the single-point SAR measurements are used:
 - a) The output power is set to **Max_Power_DPR_OFF**, with **TAS** disabled. In order to apply **TAS** algorithm to the measured power results and calculate time-averaged power (**Avg_SAR_Power**) correctly to match the single-point SAR in step 4 b), power is measured for the same time duration as in step 4 a). At the end of the 1-g SAR measurement in step 4 a), before **TAS** is enabled in step 4 b), **Avg_SAR_Power** is at **Max_Power_DPR_OFF**, which is consistently reflected in the single-point SAR and conducted power plots in Annex C.2 and C.3.
 - b) **TAS** is enabled and power is measured according to the conducted power algorithm validation procedures described in Annex A.1 and Annex B.

Important Note: In an actual end user operating environment, **TAS** is always enabled. End users do not have the option to disable **TAS**. In order to perform 1-g SAR measurement, the XMM 7360 Cellular Modem is put in Test Mode with **TAS** disabled. In Test Mode, power is monitored continuously as long as the transmitter is in a Connected state, regardless of whether **TAS** is enabled or disable. The only time power is not monitored is when the transmitter is in an idle state. Upon completion of the 1-g SAR measurements at the maximum output power (**Max_Power_DPR_OFF**), before **TAS** is enabled for single-point SAR measurement, the XMM 7360 Cellular Modem is not rebooted. At the instance when **TAS** is enabled, the time-averaged power (**Avg_SAR_Power**) is at the maximum level (**Max_Power_DPR_OFF**). **DPR** is triggered ON immediately and instantaneous power is reduced to **Max_Power_DPR_ON**. This is reflected in the single-point SAR and conducted power measurement plots in Annex C.2 and C.3, which are consistent with the intended **TAS** operating characteristics for transition between **TAS** disabled and enabled states. While the results in the plots clearly show this expected Test Mode operating characteristics, in an actual end user environment **Avg_SAR_Power** is never allowed to rise above the power level established for **Avg_SAR_UppThresh** therefore the 1-g SAR will not exceed the **SAR_target** which is the normal SAR level measured at **Avg_SAR_UppThresh** used as continuous power.

The measurement results in step 4 and 5 are plotted separately and then normalized for comparison on the same plot as shown in Annex C.2 and C.3. Conducted power results are normalized to **Max_Power_DPR_OFF** and single-point SAR values are normalized to **SAR_instantaneous_max**.

7.2.2. cDASY6 Time-Average SAR Measurement Procedures

The following is a brief description of the steps take to apply the “Time-Average SAR measurement” procedures available in the cDASY6 system for single-point SAR measurement:

1. **TAS** is initially disabled in the XMM 7360
 - a. A complete 1-g SAR measurement is performed to identify the peak SAR location used for the single-point SAR measurements. The measured 1-g SAR is also used as the reference SAR (**SAR_ref**) for calculating the **Avg_SAR_UppThresh** at **SAR_target** (1.0 W/kg) and to derive the equivalent upper threshold (**SSAR_Avg_UppThresh**) for single-point SAR described in Section 7.2.1.
 - b. The SAR probe is moved to the interpolated maximum peak SAR location of step 1 a) and a reference SAR measurement is performed. This should have the same value as **SAR_instantaneous_max** described in step 4 b) of Section 7.2.1, which is used to calculate time-averaged SAR during post-processing according to procedures in Section 7.2.1.
 - c. cDASY6 alerts the test operator to enable **TAS** in the device and initiates the single-point SAR measurement.
2. After **TAS** is enabled, single-point SAR is measured at the interpolated peak SAR location according to the measurement interval specified by the “scan duration” parameter in cDASY6.

The single-point SAR readings are exported from cDASY6 for post-processing and comparison with the conducted power validation results.

7.2.3. TAS Validation Test Sequences for Single-Point SAR Measurement

The following test cases are used for the single-point SAR validation:

1. Case #1: Call Box requests maximum output power at **Max_Power_DPR_OFF**.
2. Case #2: Call Box sends test sequence #1 described in Table 3 of Section 7.1.2.

For both test cases, the single-point SAR results are exported from the cDASY6 and post-processed according to the steps described in Section 7.2.1. The results demonstrate that, after the transition from **TAS** disabled to enabled state when **Avg_SAR_Power** is reestablished between the upper and lower threshold, **TAS** is able to maintain the time averaged power (**Avg_SAR_Power**) for any **Avg_SAR_Roll_Period** at or below **Avg_SAR_UppThresh** to maintain SAR compliance as expected in the actual end user environment.

The **SAR_target** for the selected **Avg_SAR_UppThresh** used for the test cases is 1.0 W/kg, which has been confirmed by 1-g SAR measurement (see Annex C.1). An equivalent upper threshold (**SSAR_Avg_UppThresh**) for single-point SAR is used to show that the time-averaged SAR in any **Avg_SAR_Roll_Period**, after the transition from **TAS** disable to enable state is completed, is at or below **SSAR_Avg_UppThresh**. The measured single-point SAR values are normalized and compared to conducted power validations in both time and magnitude.

8. Summary of Validation Tests and Results

The following table lists the types of **TAS** algorithm validation tests performed and the corresponding Tables and Annexes describing the test configurations and validation results. Description of the conducted power and single-point SAR measurement test setup and photos are included in Annex A.

Validation Type	Test Configurations	Test Results
Range of TAS Parameter	Table B1 Table B2	LTE: Annex B.2.1.1 UMTS: Annex B.2.1.2
Time Varying Test Sequences	Table B3	LTE & UMTS: Annex B.2.2
Connection Drop	Table B4	Drop connection: Annex B.2.3.1
Handover	Table B5 Table B6	LTE B2 to LTE B4 handover: Annex B.2.3.2 LTE B2 to UMTS B4 handover: Annex B.2.3.3
Single-Point SAR: Case #1	Section 7.2.3	Call Box requesting maximum output power (Max_Power_DPR_OFF): Annex C.2
Single-Point SAR: Case #2	Section 7.2.3	Call Box sending Test Sequence #1 in Table 3 of Section 7.1.2: Annex C.3

Annex A. Conducted Power and Single-Point SAR Measurement Test Setup

A.1 Conducted Power Measurement with Intel Test Platform

A.1.1 Test Setup

The conducted power measurement test setup is described in the following and illustrated in Figure A.1.

- The Fibocom M2 L850-GL module, which contains the XMM 7360 Cellular Modem, is installed in an Intel Test Platform (DUT) to emulate a generic host device and to provide proper interface for the Call Box and test equipment. Photos of the Fibocom module, XMM 7360 and test equipment are included in Annex A.1.3 and A.3.
- A control PC is used to configure the Call Box to send power control test sequences to the XMM 7360, according to those described in Section 7.1.2 and Annex B.
- Uplink signal power is monitored by the Spectrum Analyzer and record by the PC with a time resolution of 25 msec, which is substantially less than the power adjustment interval (**Avg_SAR_Check_Period**) of 1 sec used for XMM 7360.
- The values of **Avg_SAR_Power** are read from the XMM 7360 by the PC at each **Avg_SAR_Check_Period**
- In addition to power results, the time sequence of power control commands and power samples are also recorded by the PC to enable results to be correlated and plotted. Uplink signal from the XMM 7360 is fed through a 3 dB Power Splitter, which delivers an equal amount of signal to the Spectrum Analyzer and the Call Box. The Splitter has high isolation between the Spectrum Analyzer and the Call Box. Due to different Uplink/Downlink frequencies and the zero span time-domain measurement used, interference of Uplink and Downlink signals is avoided.
- Path loss in the power measurement setup from the XMM 7360 Main Antenna port to either the Call Box or the Spectrum Analyzer is 16.5 dB, with less than 0.1 dB difference between Band 2 and Band 4 (used for the tests).

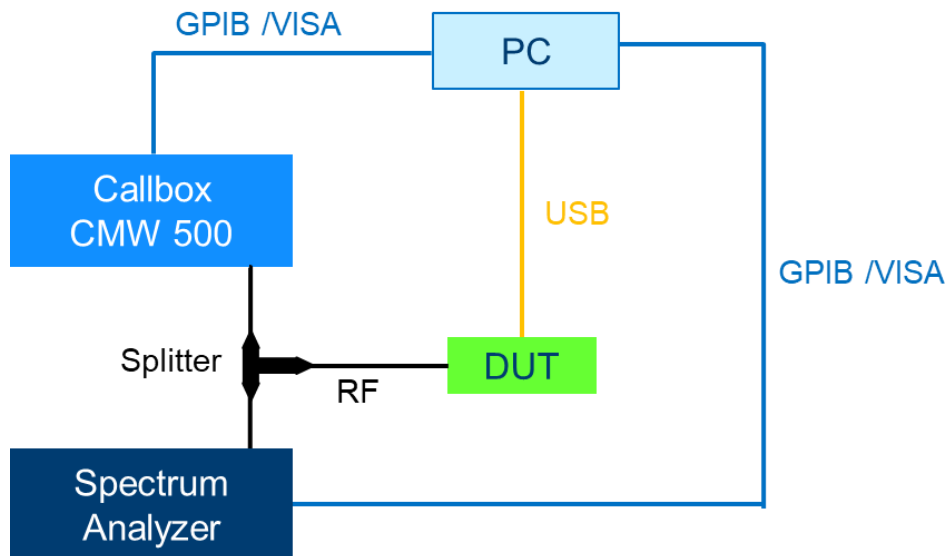

Figure A.1 – Validation using conducted power measurement test setup.

A.1.2 Test Equipment List

Equipment and accessories used for the conducted power measurement test setup are listed below. The Test Platform (DUT), test setup and associated equipment are shown in A.1.3 and A.3.

ID#	Device	Type/Model	Serial #	Manufacturer	Cal. Date	Cal. Due Date
0319	Communication Tester	CMW500	152721	Rohde & Schwarz	2018-04-12	2020-04-12
0322	Spectrum Analyzer	FSL6	102143	Rohde & Schwarz	2018-04-13	2020-04-13
-	Power Divider	PE2083	-	Pasternack	Attenuation and loss verified before use	

A.1.3 Conducted Power Test Setup Photos

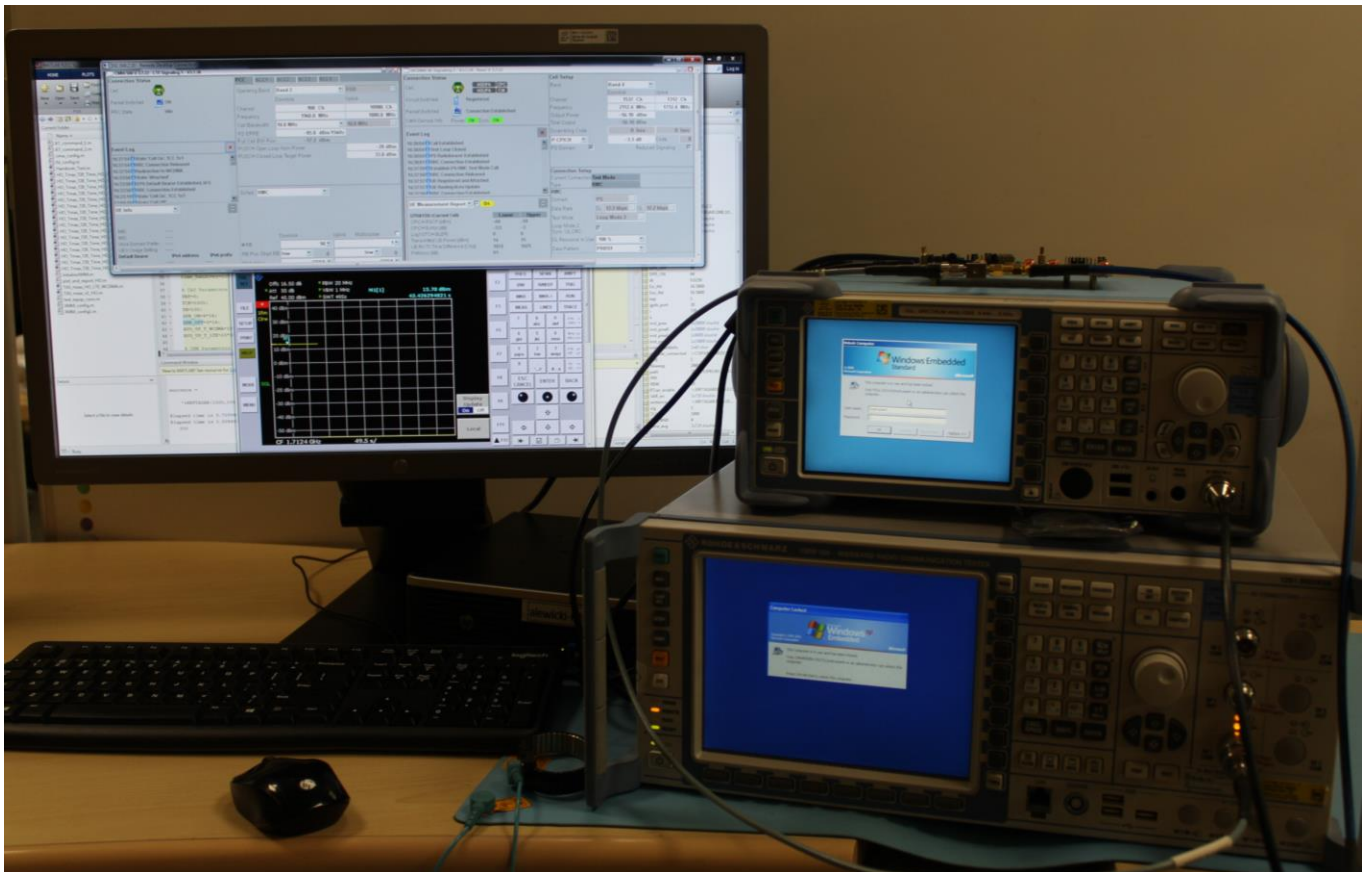

Figure A.1.3 – Fibocom Module with XMM 7360 mounted on the Intel Test Platform, placed on top of the Spectrum Analyzer and Call Box CMW 500, which are under GPIB control through the PC.

A.2 Single-Point SAR Measurement with a 2-in-1 Convertible PC

A.2.1 2-in-1 Convertible PC Test Platform

A 2-in-1 convertible PC with a metal chassis is used as the generic host to perform the validation tests in Tablet operating mode. Images of the generic host are shown Figure A.2.1, where the non-detachable keyboard is folded back behind the display in Tablet mode.

Front Cover: Back of Display	Bottom of Keyboard
	
Display in Tablet Mode	Keyboard Behind Display in Tablet Mode
	
Laptop Mode	Tablet Mode Operating condition
	

Figure A.2.1 – Test Setup photos of the generic host, a 2-in-1 convertible PC

A.2.2 WWAN Antenna location in the convertible PC platform

Both the Fibocom M2 and WLAN modules are located in the keyboard section of the PC. As shown in Figure A.2.2, the WWAN Main antenna is located at the top edge of the display. It is at a distance of 4 mm from the surface of the display housing. Since the XMM 7360 Cellular Modem does not support transmit diversity, the WWAN Aux antenna is for received only and cannot be used for single-point SAR validation. SAR is performed with the top edge of the PC positioned against a flat phantom in Tablet Mode. The WLAN antennas are identified by Tx1 and Tx2, which are not controlled by **TAS**.

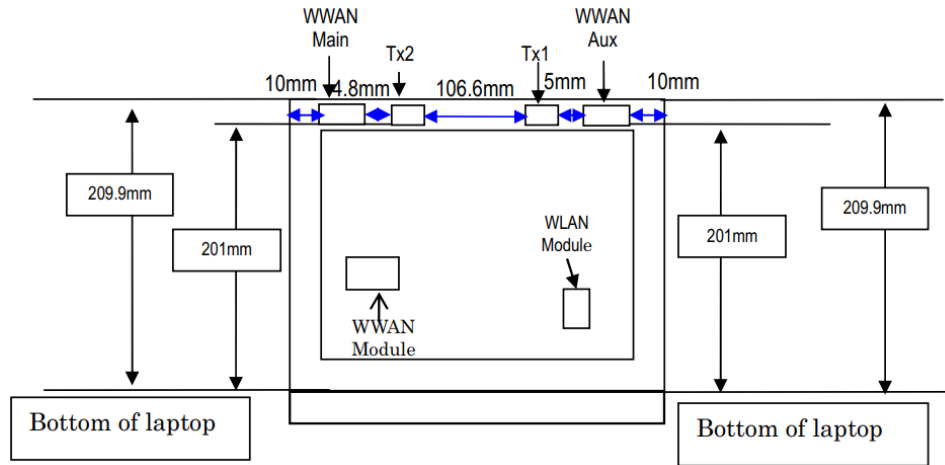
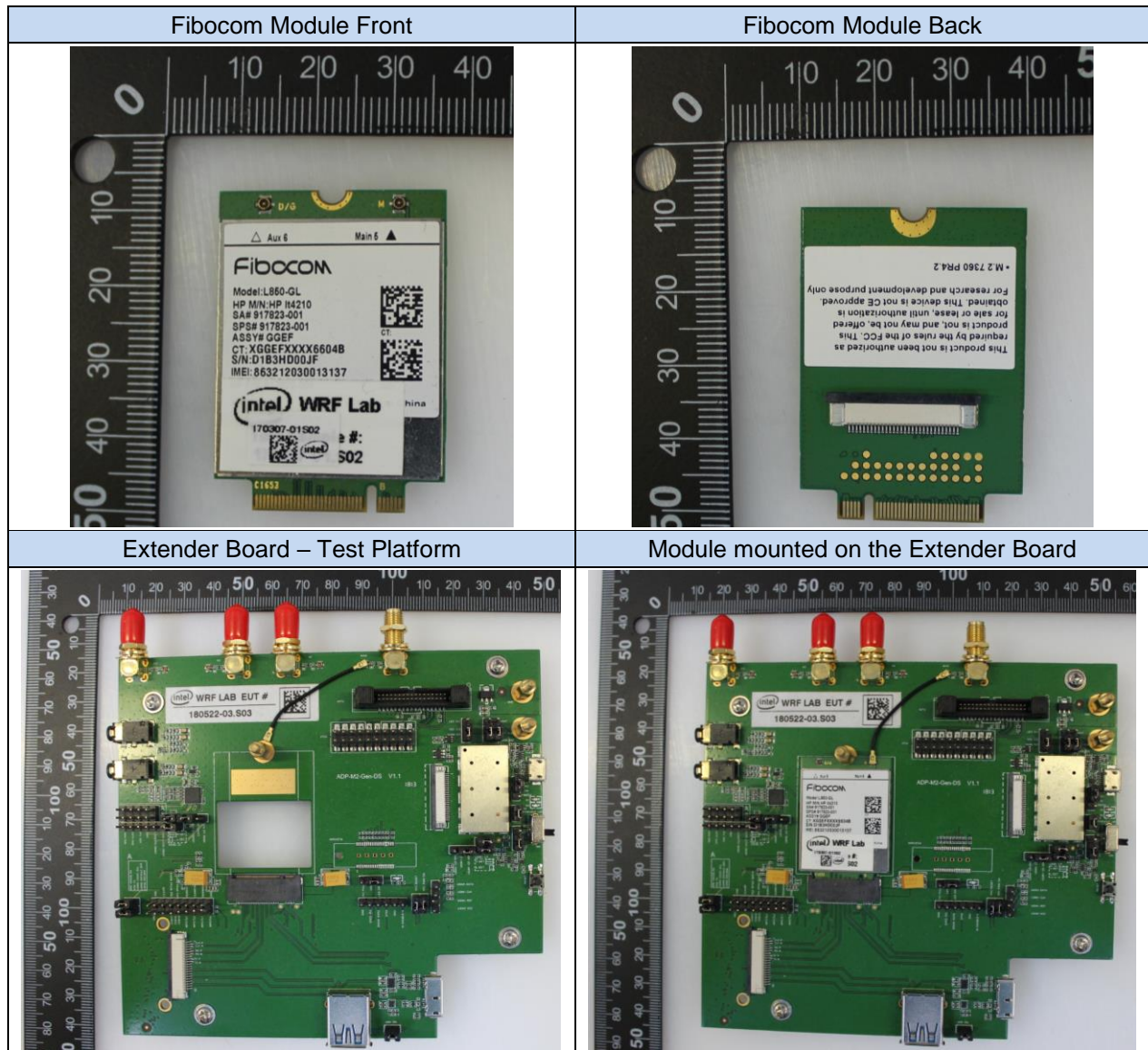

Figure A.2.2 - Antenna locations of convertible PC in Tablet mode

A.3 Test Sample and Conducted Power Test Platform



Annex B. Conducted Power Validation Test Results

B.1 Validation using Conducted Power Measurement with Intel Test Platform

The **TAS** algorithm and its reliability for ensuring SAR compliance have been validated using conducted power measurements, according to the validation procedures described in Section 7.1 of this test report. The validations include both LTE and UMTS. The test configurations and validation results are shown in the sub-sections of this Annex. The wireless operating modes and transmission configurations used for the algorithm validation tests are described in Tables B1 – B6. Following each Table, **TAS** responses according to **Avg_SAR_Power**, which is time averaged over **Avg_SAR_Roll_Period**, and the corresponding (instantaneous) output power transmitted by the XMM 7360 Cellular Modem, measured by the Spectrum Analyzer, are plotted separately for the test configurations after each Table. The results verify that **DPR** is turned ON when **Avg_SAR_Power** reaches **Avg_SAR_UppThresh** and **TAS** is able to maintain **Avg_SAR_Power** between **Avg_SAR_UppThresh** and **Avg_SAR_LowThresh** until **Avg_SAR_Power** falls below **Avg_SAR_LowThresh** and **DPR** is turned OFF.

For the M2 module, XMM 7360 is validated with **Avg_SAR_Check_Period** and **Avg_SAR_Roll_Period** set to 1 sec and 100 sec, respectively. The total duration for each test is 12 minutes (720 sec). The maximum output power available from the specific XMM 7360 Cellular Modem used for the validation tests is about 22 - 23 dBm. The following is a brief description of the test configurations:

- Table B1 and Table B2 – Configurations used to verify **TAS** responses to power control for the operating parameters listed in Table 2 of Section 7.1.1. The test starts from a reboot condition and is followed by maximum output power requests from the Call Box to the XMM 7360. There are 6 cases each for UMTS and LTE.
- Table B3 – Wireless mode configurations used for testing the test sequences listed in Table 3 and Table 4 of Section 7.1.2.
- Table B4 – Wireless mode configurations used for testing a drop-connection, which is introduced after **DPR** is turned ON due to maximum power requests from the Call Box. After the connection is reestablished, maximum output power is again requested to demonstrate **DPR** and **TAS** control continuity with respect to power accumulated before and after the drop-connection condition. In addition, instead of a drop-connection, the test is repeated by replacing the drop-connection with a reboot.
- Table B5 – Wireless mode configurations used for testing handover from LTE B2 to LTE B4, similar to configurations used for drop-connection.
- Table B6 – Wireless mode configurations used for testing handover from LTE B2 to UMTS B4, similar to configurations used for drop-connection.

B.2 Conducted Power TAS Validation Tests and Results with Intel Test Platform

B.2.1 Fundamental Algorithm Validation for a Range Control Parameters

B.2.1.1 Validation for LTE in Band 2

Table B1 – Test Cases for LTE Band 2 using 1 RB and QPSK

Test Case #	Band	Max Power	Roll Period	Check Period	Avg_SAR_UppThresh [dBm]	Avg_SAR_LowThresh [dBm]	Max_Power_DPR_ON [dBm]
1	LTE B2	23 dBm	100 sec	1 sec	22	21	20
2					22	19	16
3					20	19	18
4					20	17	14
5					18	17	16
6					18	15	12

Note: Values for **Max Power**, **Avg_SAR_UppThresh**, **Avg_SAR_LowThresh** and **Max_Power_DPR_ON** indicated above are approximated. The exact values for these are set according to the actual **Max Power** at the time of testing, accounting for tolerance, and the range (in dB) for **Avg_SAR_UppThresh**, **Avg_SAR_LowThresh** and **Max_Power_DPR_ON**. These can introduce an apparent shift of the curves relative to **Max Power** shown in the plots. However, they have no impact to **TAS**.

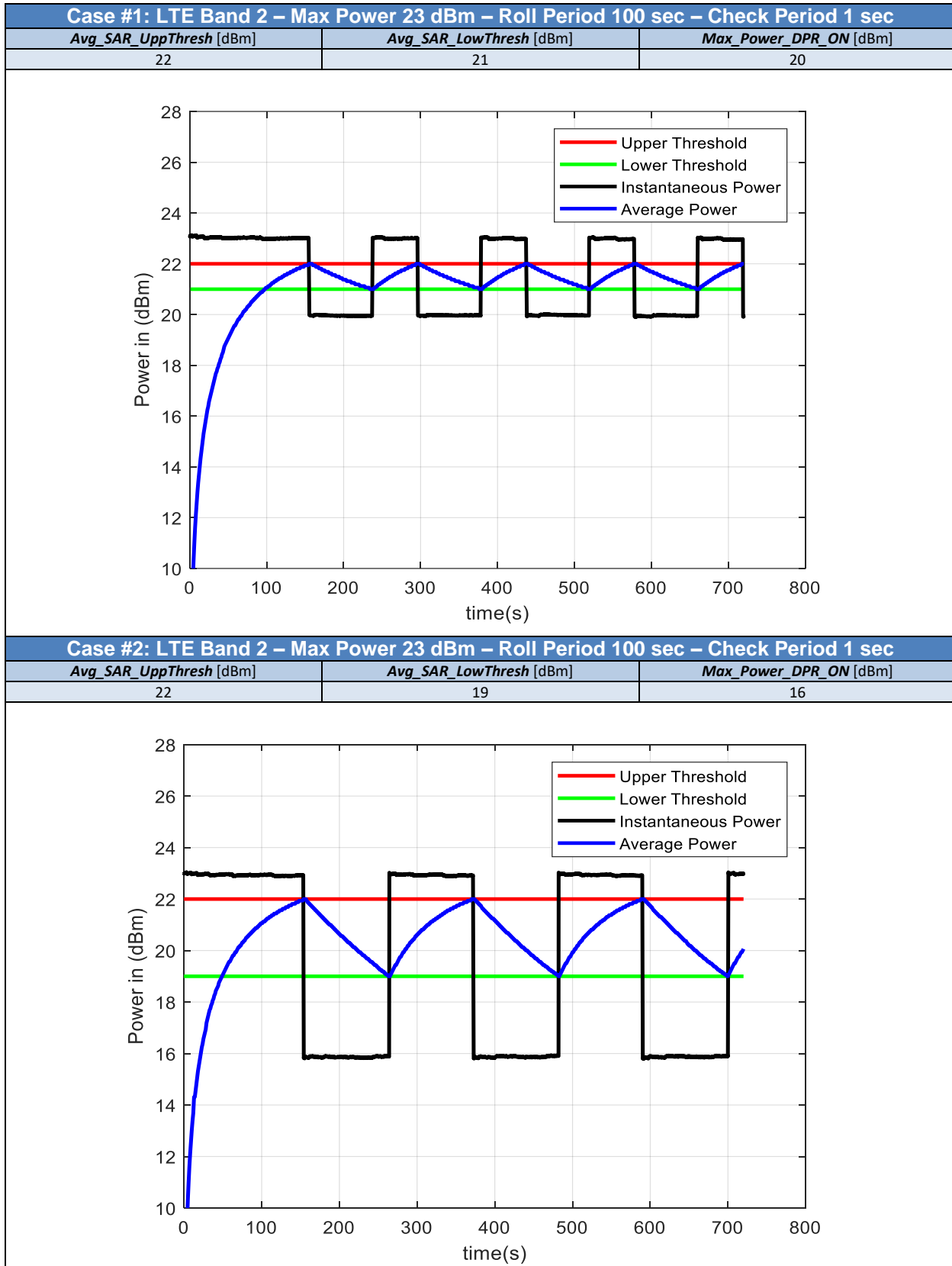
Results of test cases in **Table B1** are shown in the following plots.

Case #3: LTE Band 2 – Max Power 23 dBm – Roll Period 100 sec – Check Period 1 sec

<i>Avg_SAR_UppThresh</i> [dBm]	<i>Avg_SAR_LowThresh</i> [dBm]	<i>Max_Power_DPR_ON</i> [dBm]
20	19	18

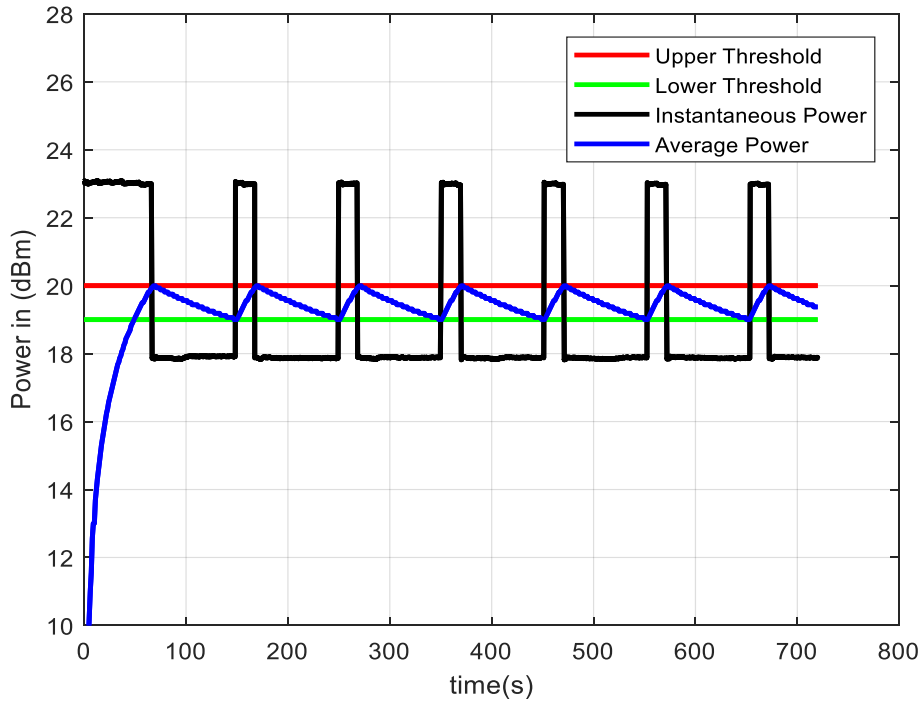

Case #4: LTE Band 2 – Max Power 23 dBm – Roll Period 100 sec – Check Period 1 sec

<i>Avg_SAR_UppThresh</i> [dBm]	<i>Avg_SAR_LowThresh</i> [dBm]	<i>Max_Power_DPR_ON</i> [dBm]
20	17	14

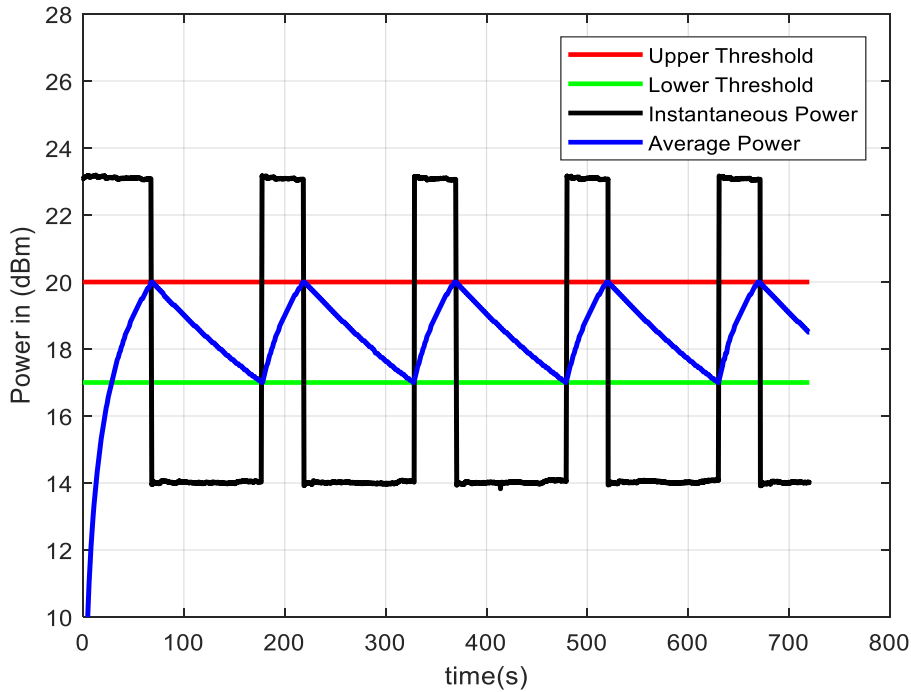

Case #5: LTE Band 2 – Max Power 23 dBm – Roll Period 100 sec – Check Period 1 sec		
Avg_SAR_UppThresh [dBm]	Avg_SAR_LowThresh [dBm]	Max_Power_DPR_ON [dBm]
18	17	16

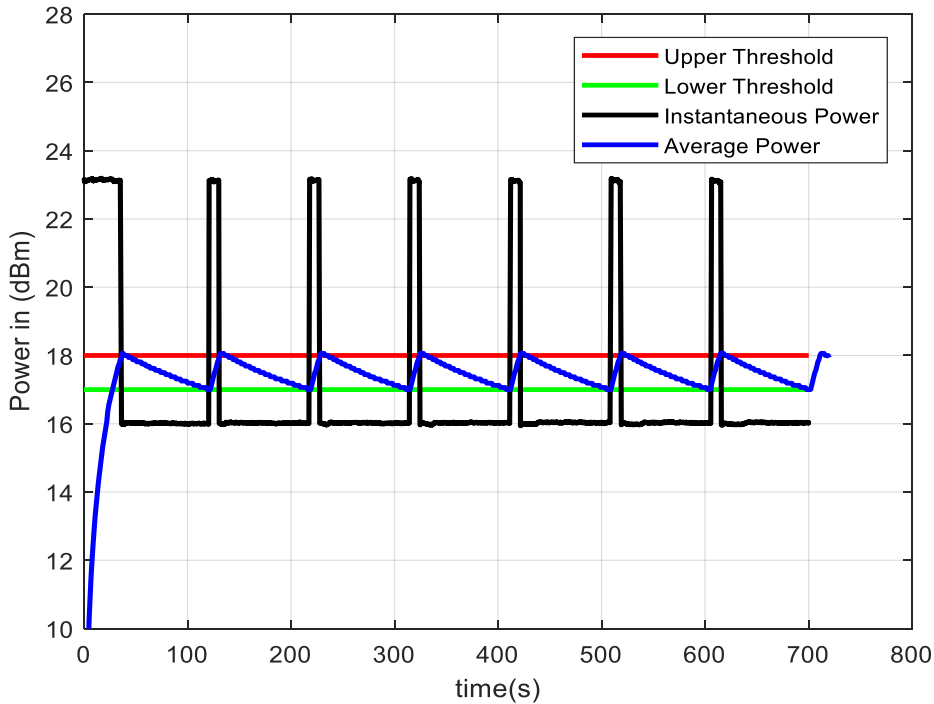

Case #6: LTE Band 2 – Max Power 23 dBm – Roll Period 100 sec – Check Period 1 sec		
Avg_SAR_UppThresh [dBm]	Avg_SAR_LowThresh [dBm]	Max_Power_DPR_ON [dBm]
18	15	12

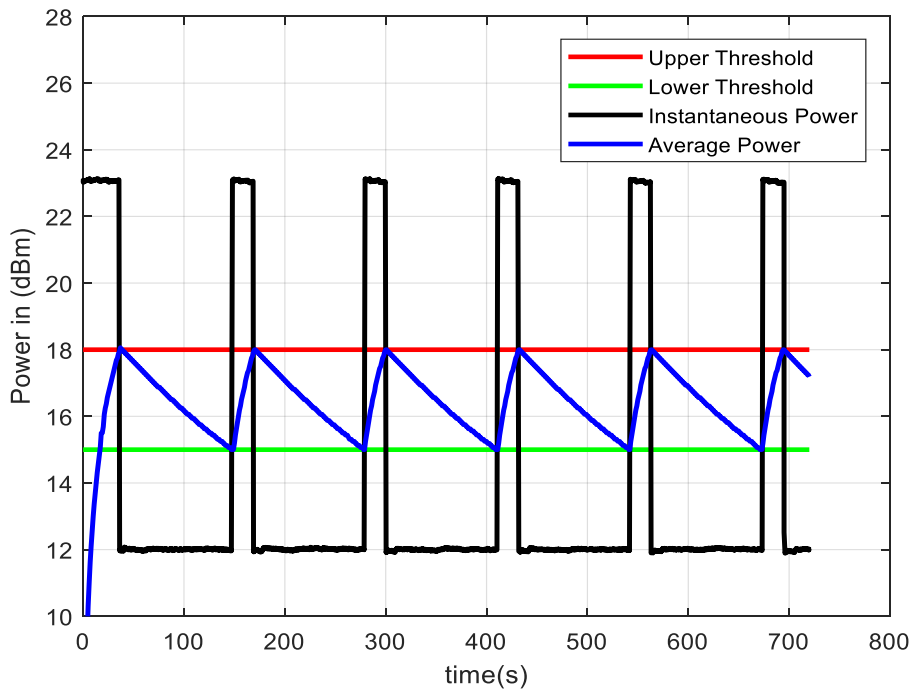

B.2.1.2 Validation of UMTS/WCDMA Band 2
Table B2 – Test Cases for UMTS/WCDMA Band 2 – RMC

Test Case #	Band	Max Power	Roll Period	Check Period	Avg_SAR_UppThresh [dBm]	Avg_SAR_LowThresh [dBm]	Max_Power_DPR_ON [dBm]
1	WCDMA B2	22.5 dBm	100 sec	1 sec	22	21	20
2					22	19	16
3					20	19	18
4					20	17	14
5					18	17	16
6					18	15	12

Note: Values for **Max Power**, **Avg_SAR_UppThresh**, **Avg_SAR_LowThresh** and **Max_Power_DPR_ON** indicated above are approximated. The exact values for these are set according to the actual **Max Power** at the time of testing, accounting for tolerance, and the range (in dB) for **Avg_SAR_UppThresh**, **Avg_SAR_LowThresh** and **Max_Power_DPR_ON**. These can introduce an apparent shift of the curves relative to **Max Power** shown in the plots. However, they have no impact to **TAS**.

Results for the test cases in Table B2 are shown in the following plots.

Note: The maximum output power in WCDMA mode for this test sample was about 22.5 dBm, which was 0.5 dB lower than the 23 dBm specified; therefore, *Max Power DPR_ON* and *Max Power DPR_OFF* are shifted lower by 0.5 dB in plots for all WCDMA test cases. While *Max Power DPR_OFF* was 0.5 dB lower, *Avg_SAR_UppThresh* and *Avg_SAR_LowThresh* were not adjusted. This does not seem to have any noticeable impact to **TAS** control.

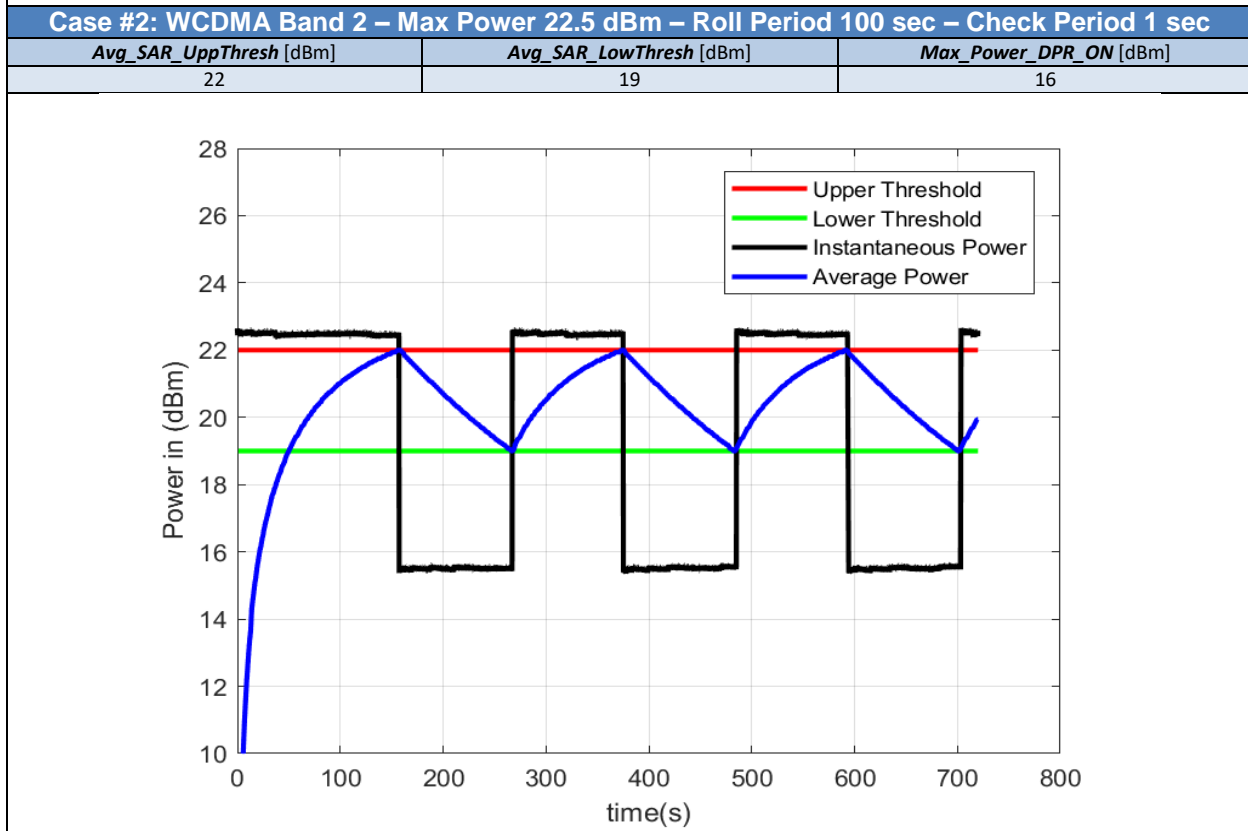
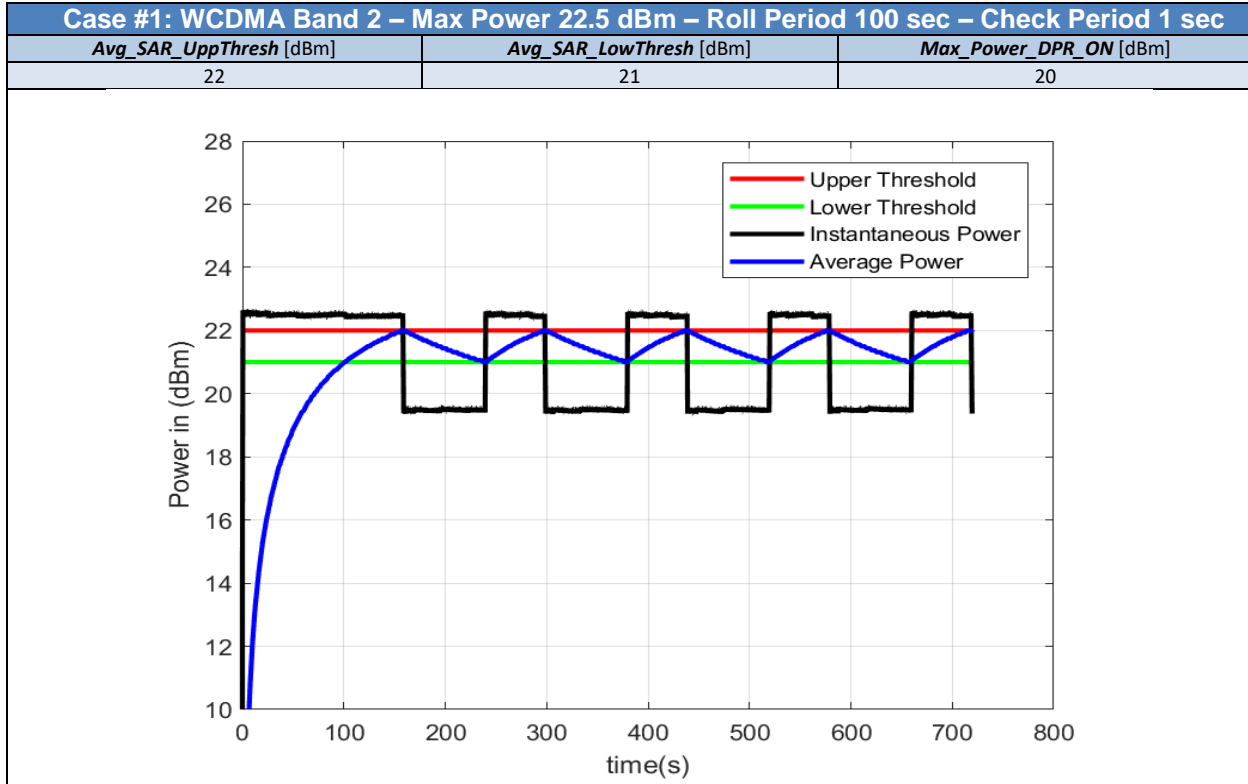

Case #3: WCDMA Band 2 – Max Power 22.5 dBm – Roll Period 100 sec – Check Period 1 sec

<i>Avg_SAR_UppThresh</i> [dBm]	<i>Avg_SAR_LowThresh</i> [dBm]	<i>Max_Power_DPR_ON</i> [dBm]
20	19	18

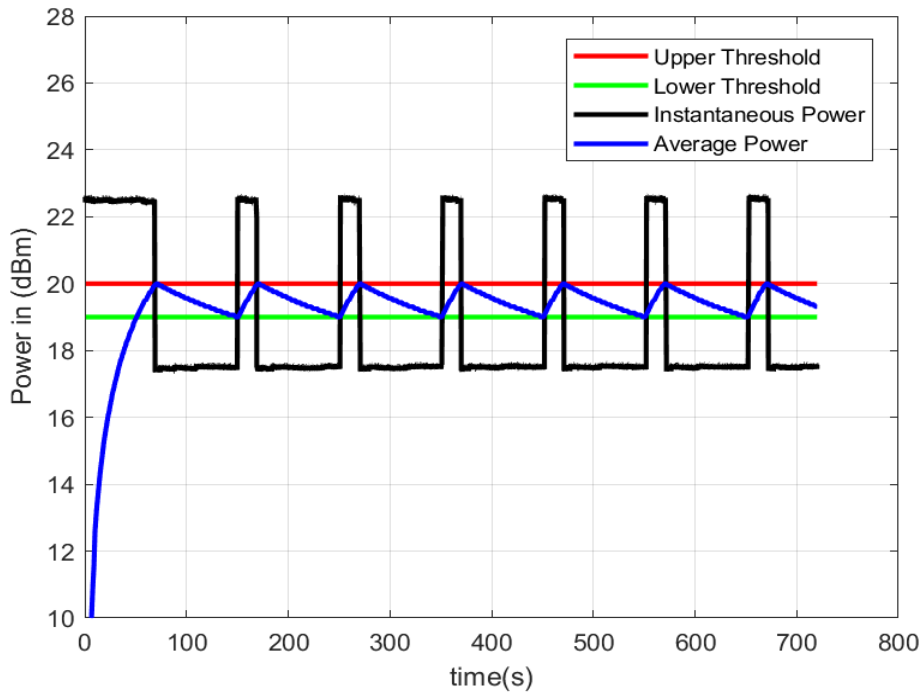

Case #4: WCDMA Band 2 – Max Power 22.5 dBm – Roll Period 100 sec – Check Period 1 sec

<i>Avg_SAR_UppThresh</i> [dBm]	<i>Avg_SAR_LowThresh</i> [dBm]	<i>Max_Power_DPR_ON</i> [dBm]
20	17	14

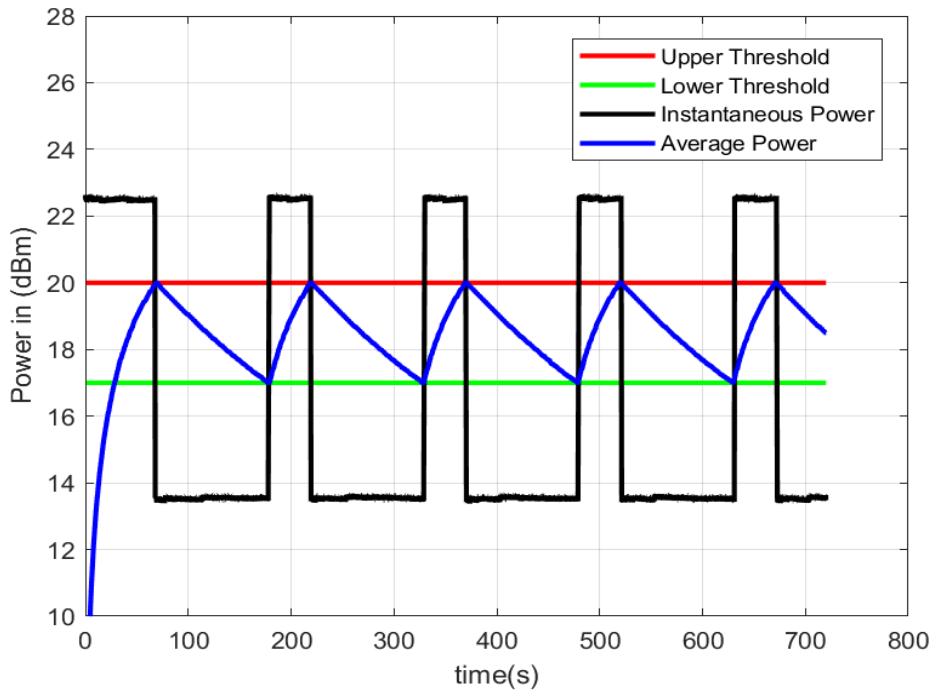

Case #5: WCDMA Band 2 – Max Power 22.5 dBm – Roll Period 100 sec – Check Period 1 sec

<i>Avg_SAR_UppThresh</i> [dBm]	<i>Avg_SAR_LowThresh</i> [dBm]	<i>Max_Power_DPR_ON</i> [dBm]
18	17	16

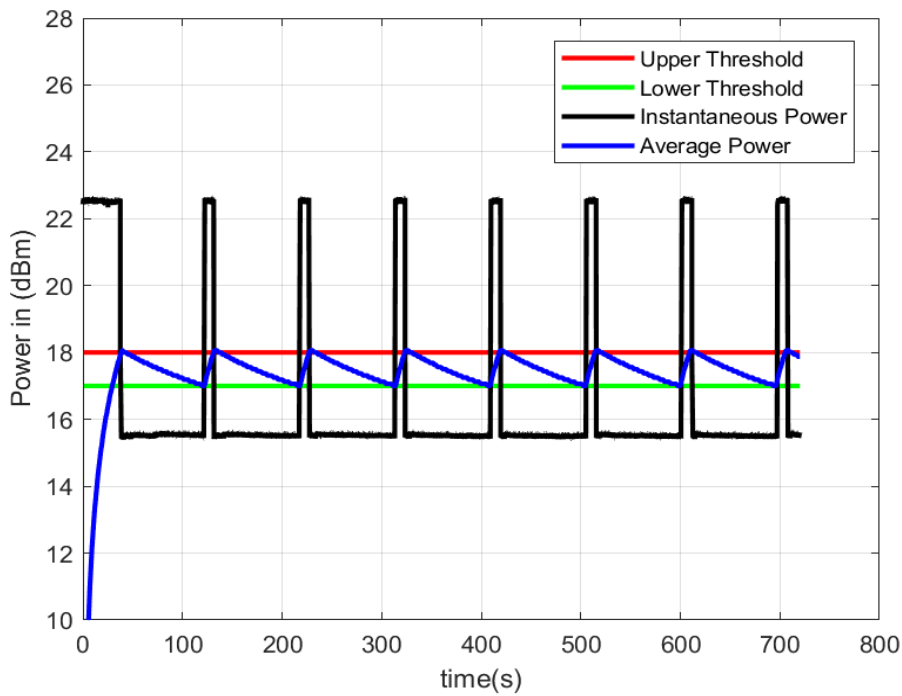

Case #6: WCDMA Band 2 – Max Power 22.5 dBm – Roll Period 100 sec – Check Period 1 sec

<i>Avg_SAR_UppThresh</i> [dBm]	<i>Avg_SAR_LowThresh</i> [dBm]	<i>Max_Power_DPR_ON</i> [dBm]
18	15	12

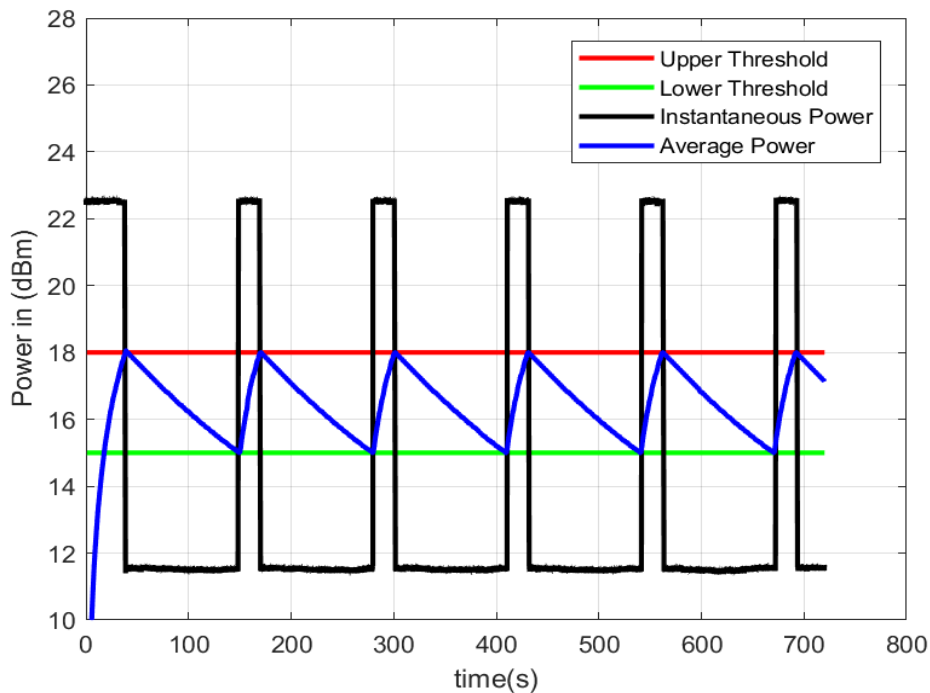

B.2.2 Algorithm Validation According to Time Varying Power Control Test Sequences

Table B3 – Test Cases for Test Sequences in Tables 2 and 3 for LTE and WCDMA - Band 2

Test Case #	Band	Max Power	Roll Period	Check Period	Avg_SAR_UppT hresh [dBm]	Avg_SAR_LowT hresh [dBm]	Max_Power_DPR_ON [dBm]
1	LTE B2	23 dBm	100 sec	1 sec	18	15	14
2					18	15	14
3	WCDMA B2	22.5 dBm			18	15	14
4					18	15	14

Note: Values for **Max Power**, **Avg_SAR_UppThresh**, **Avg_SAR_LowThresh** and **Max_Power_DPR_ON** indicated above are approximated. The exact values for these are set according to the actual **Max Power** at the time of testing, accounting for tolerance, and the range (in dB) for **Avg_SAR_UppThresh**, **Avg_SAR_LowThresh** and **Max_Power_DPR_ON**. These can introduce an apparent shift of the curves relative to **Max Power** shown in the plots. However, they have no impact to **TAS**.

Results for the test cases in Table B3 are shown in the following plots.

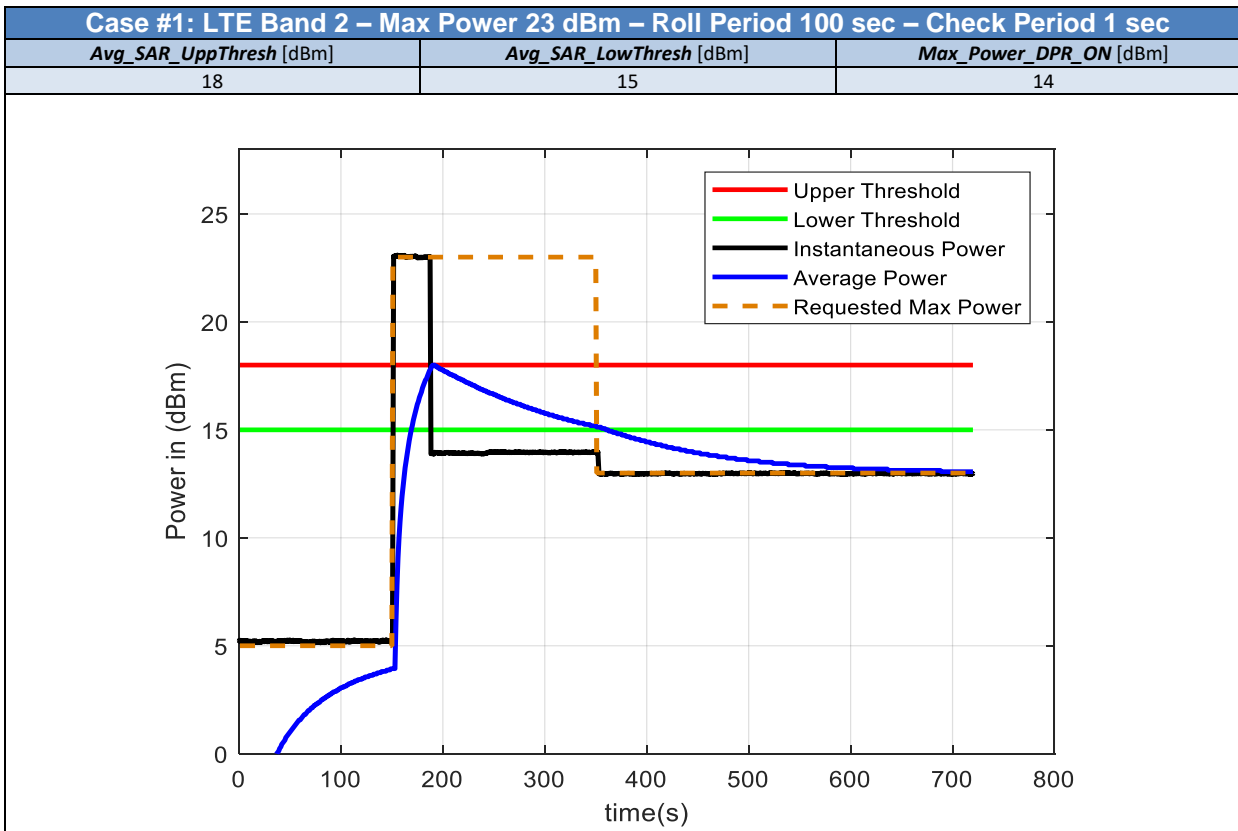

Case #2: LTE Band 2 – Max Power 23 dBm – Roll Period 100 sec – Check Period 1 sec		
Avg_SAR_UppThresh [dBm]	Avg_SAR_LowThresh [dBm]	Max_Power_DPR_ON [dBm]
18	15	14

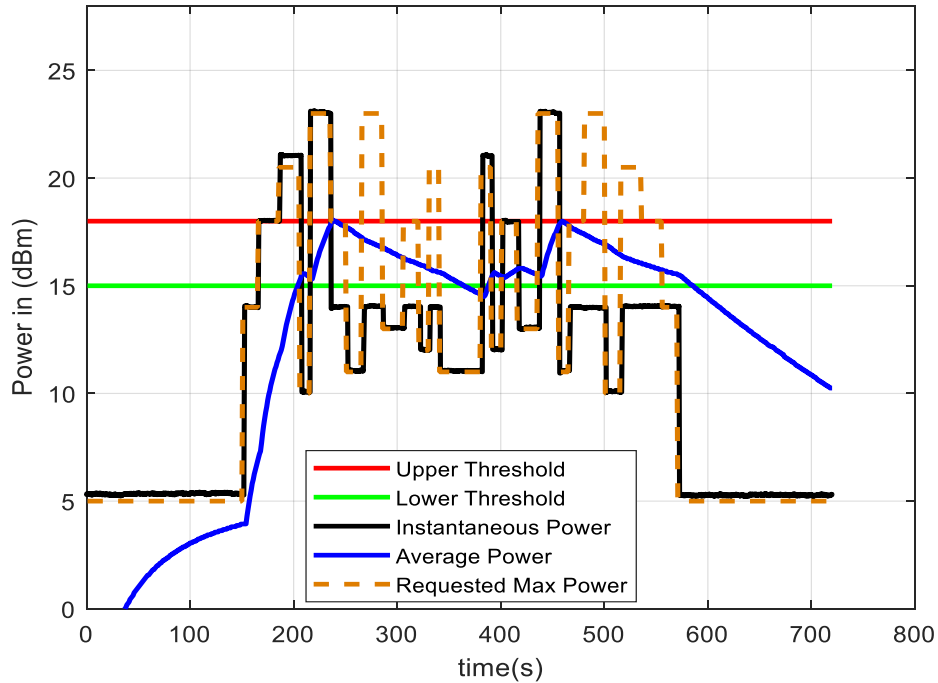

Case #3: WCDMA Band 2 – Max Power 22.5 dBm – Roll Period 100 sec – Check Period 1 sec		
Avg_SAR_UppThresh [dBm]	Avg_SAR_LowThresh [dBm]	Max_Power_DPR_ON [dBm]
18	15	14

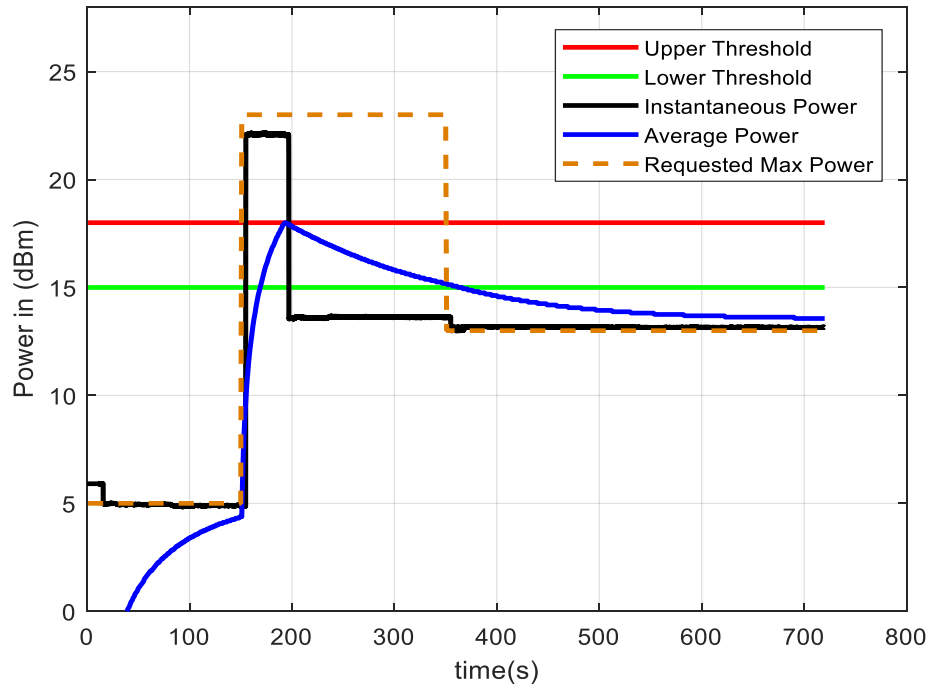

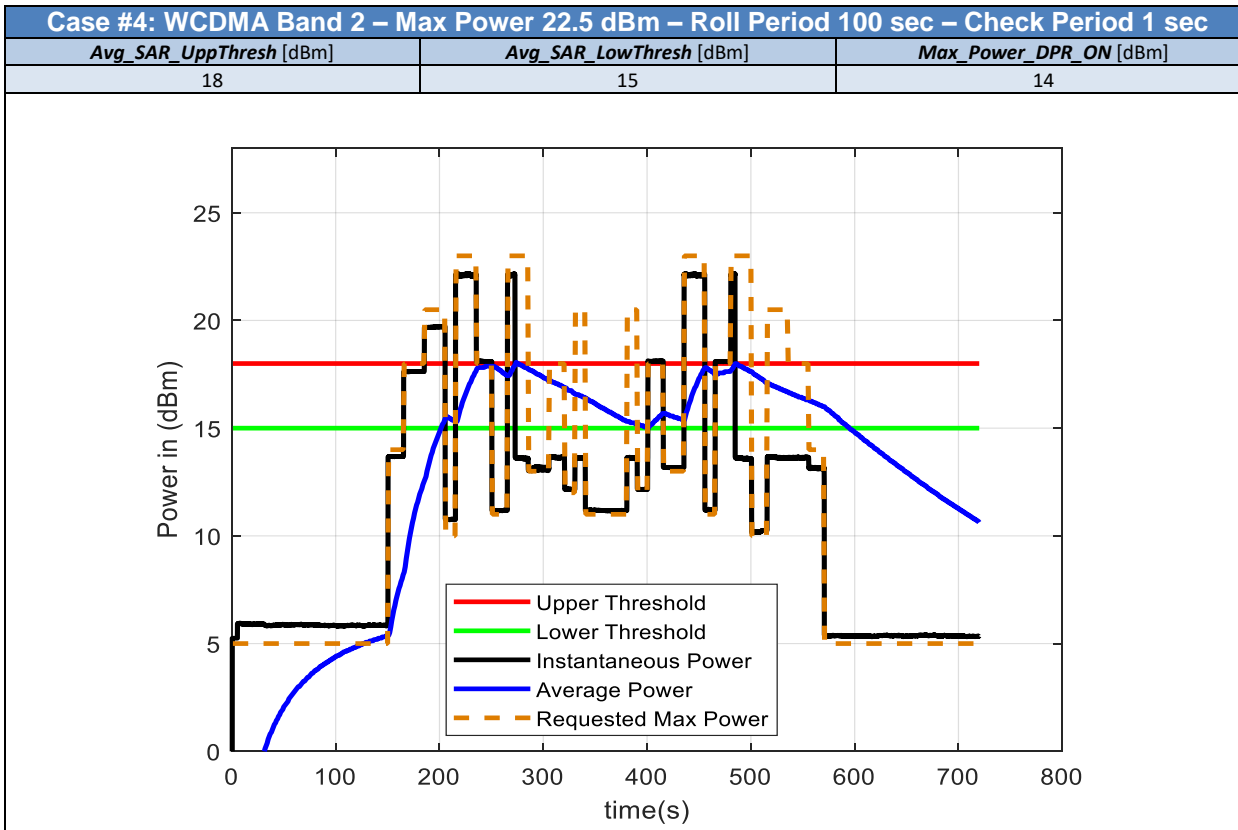

B.2.3 Algorithm Validation for Drop Connection and Technology/Band Handover

B.2.3.1 Connection Drop and Reboot Scenario Validation

Table B4 – Test Cases for LTE connection drop and reboot

Test Case #	Band	Max Power	Roll Period	Check Period	Avg_SAR_UppThresh [dBm]	Avg_SAR_LowThresh [dBm]	Max_Power_DPR_ON [dBm]
1: Drop Connection	LTE B2	23 dBm	100 sec	1 sec	18	17	14
2: Reboot					18	17	14

Results for the test cases in Table B4 are shown in the following plots.

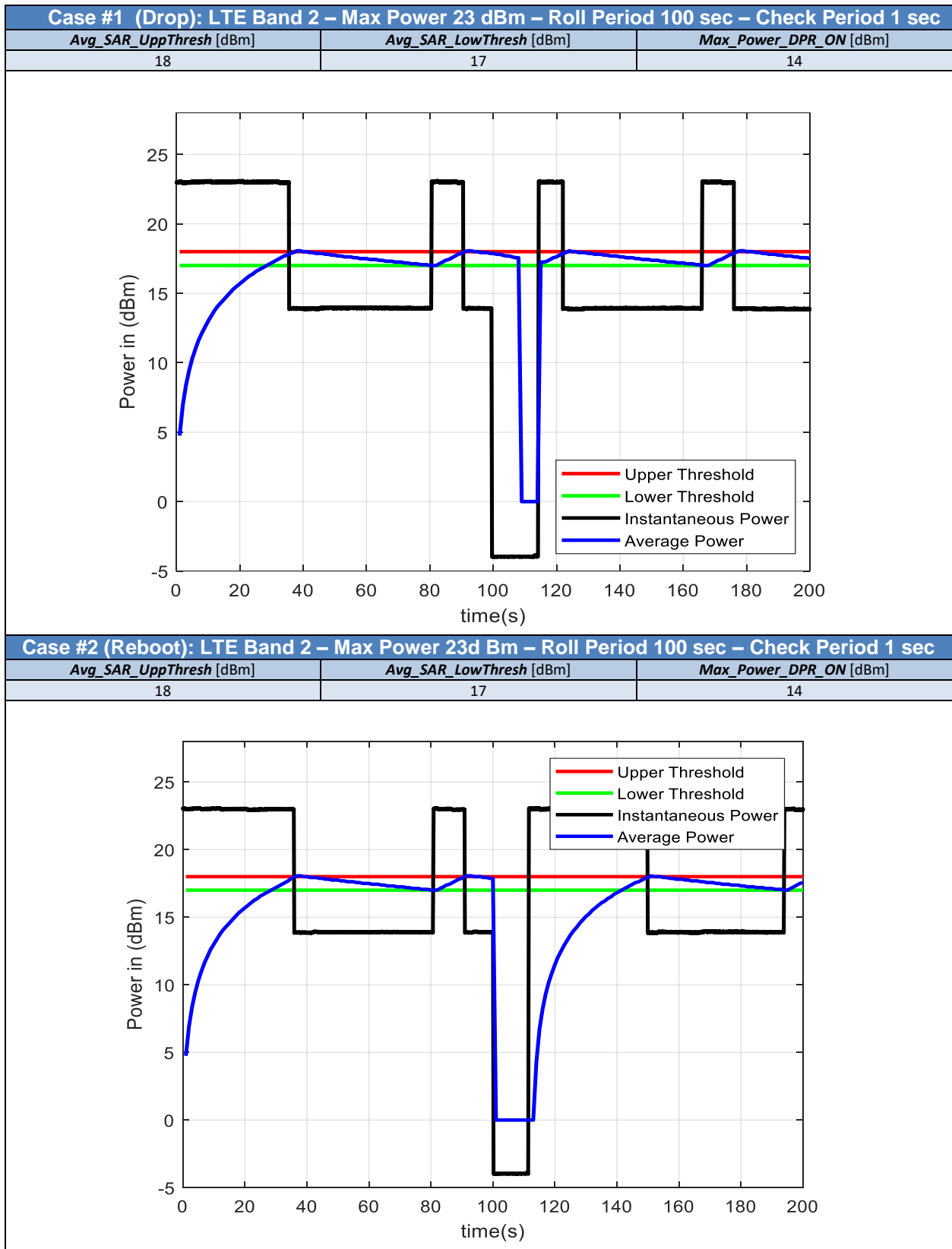

B.2.3.2 Handover Validation from LTE Band 2 to LTE Band 4

Table B5 – Test Case for Handover from LTE Band 2 to LTE Band 4

Test Case #	Band	Max Power	Roll Period	Check Period	Avg_SAR_UppT hresh [dBm]	Avg_SAR_LowT hresh [dBm]	Max_Power_DPR_ON [dBm]
1	LTE B2	23 dBm	100 sec	1 sec	20	17	16
	LTE B4						

Note: Values for **Max Power**, **Avg_SAR_UppThresh**, **Avg_SAR_LowThresh** and **Max_Power_DPR_ON** indicated above are approximated. The exact values for these are set according to the actual **Max Power** at the time of testing, accounting for tolerance, and the range (in dB) for **Avg_SAR_UppThresh**, **Avg_SAR_LowThresh** and **Max_Power_DPR_ON**. These can introduce an apparent shift of the curves relative to **Max Power** shown in the plots. However, they have no impact to **TAS**.

Results for the test case in Table B5 are shown in the following plot.

Note: This handover test was done at a different time from all of the above tests. The LTE **Max_Power_DPR_ON** and **Max_Power_DPR_OFF** levels were about 0.5 dB lower than specified due to tune-up tolerances (± 1 dB) relating to board temperature introduced power drift. This has no impact on **TAS** operations.

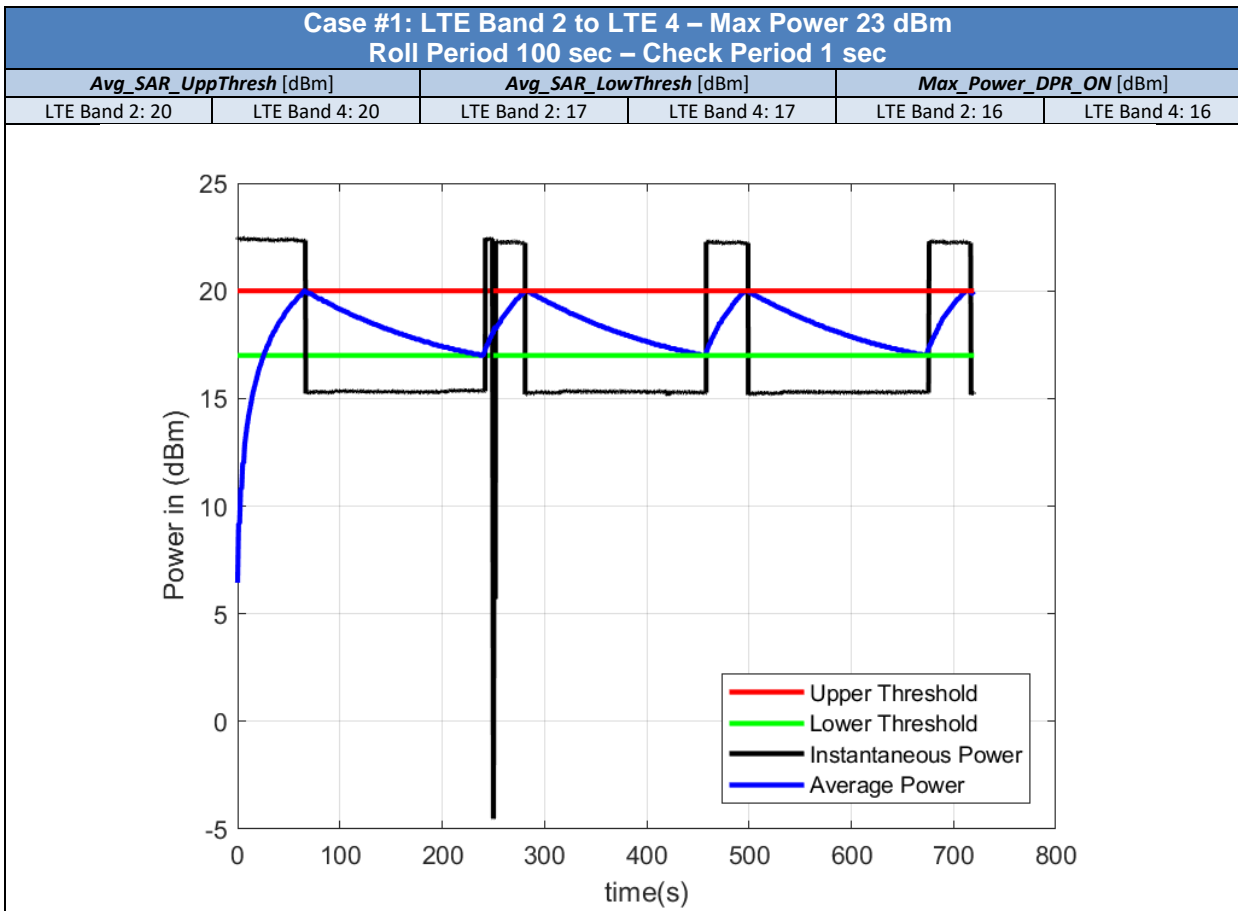

B.2.3.3 Handover Validation from LTE Band 2 to WCDMA Band 4

Table B6 – Test Case for Handover from LTE Band 2 to WCDMA Band 4

Test Case #	Band	Max Power	Roll Period	Check Period	Avg_SAR_UppT hresh [dBm]	Avg_SAR_LowT hresh [dBm]	Max_Power_DPR_ON [dBm]
1	LTE B2	23 dBm	100 sec	1 sec	20	17	16
	WCDMA B4	22.5 dBm			18	15	14

Note: Values for **Max Power**, **Avg_SAR_UppThresh**, **Avg_SAR_LowThresh** and **Max_Power_DPR_ON** indicated above are approximated. The exact values for these are set according to the actual **Max Power** at the time of testing, accounting for tolerance, and the range (in dB) for **Avg_SAR_UppThresh**, **Avg_SAR_LowThresh** and **Max_Power_DPR_ON**. These can introduce an apparent shift of the curves relative to **Max Power** shown in the plots. However, they have no impact to **TAS**.

Results for the test case in Table B6 are shown in the following plot.

Note: This handover test was done at a different time from all of the above tests. The LTE **Max_Power_DPR_ON** and **Max_Power_DPR_OFF** levels were about 0.5 dB lower than specified due to tune-up tolerances (± 1 dB) related to board temperature introduced power drift. This has no impact on **TAS** operations.

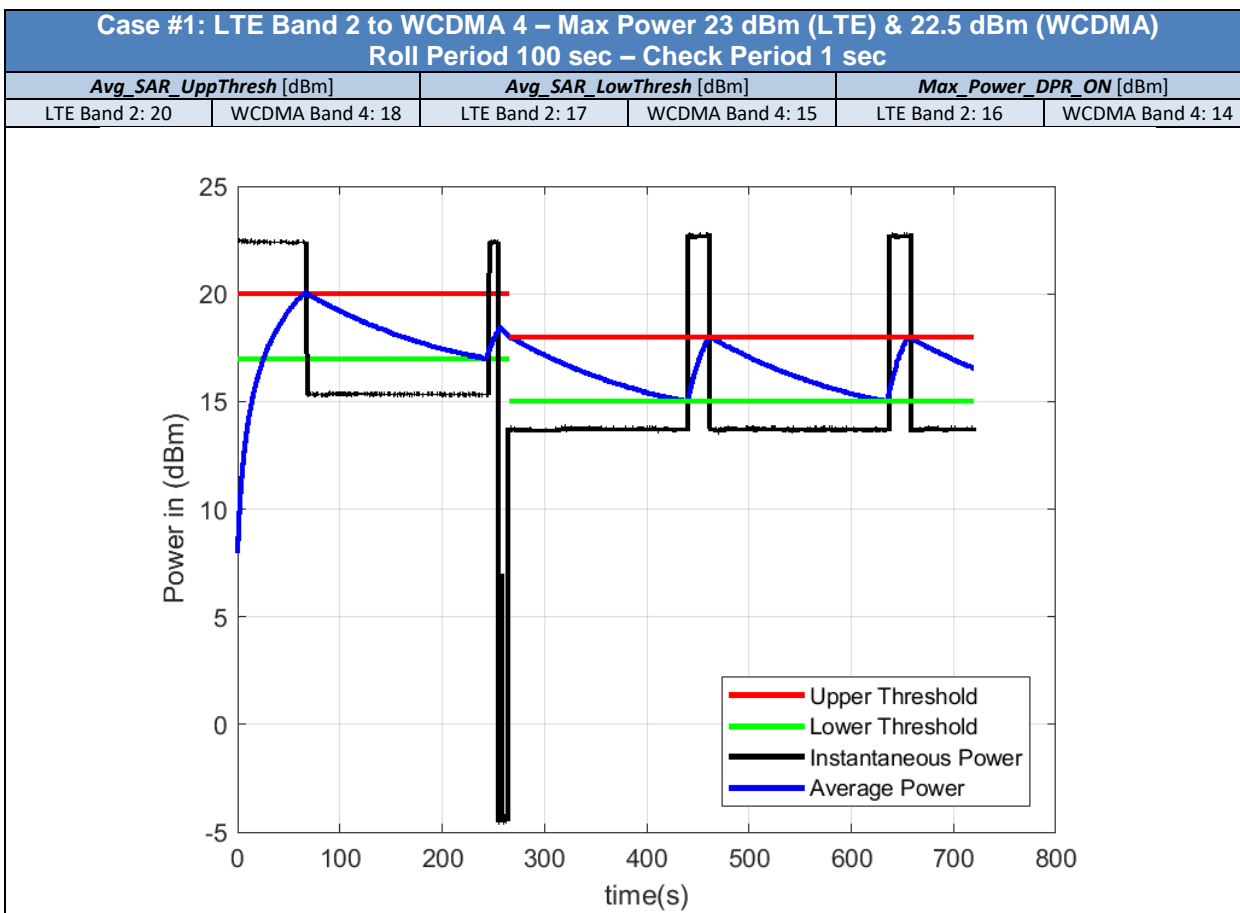

Annex C. Single-Point SAR Measurement Validation Test Results for 2-in-1 Convertible PC

C.1 1-g SAR Measurement at SAR_target of 1.0 W/kg

SAR is measured at the power level of **Avg_SAR_UppThresh** = 20.5 dBm, which is established according to the value of **SAR_target** = 1.0 W/kg described in Section 7.2.1. The measurement setup and cDASY6 SAR results are shown below. The measured 1-g SAR is 1.01 W/kg, which is the same as that calculated for **SAR_target**.

Measurement Report for Device, EDGE TOP, Band 2, E-UTRA/FDD, UID 10169 CAE, Channel 18700 (1860.0 MHz)

Device under Test Properties

Name	Dimensions [mm]	IMEI	DUT Type
Generic PC	213.0 x 305.0 x 15.0		2-in-1 Convertible PC

Exposure Conditions

Phantom Section, TSL	Position, Test Distance [mm]	Band	Group, UID	Frequency [MHz], Channel Number	Conversion Factor	TSL Conductivity [S/m]	TSL Permittivity
Flat, MSL	EDGE TOP, 0.0	Band 2, E-UTRA/FDD	LTE, 10169-CAE	1860.0, 18700	7.52	1.57	51.0

Hardware Setup

Phantom	TSL, Measured Date	Probe, Calibration Date	DAE, Calibration Date
ELI V8.0 (20deg probe tilt) - 2048	MABL-600-6000v5 2019-Apr-29	Charge:xxxx, EX3DV4 - SN3978, 2018-05-18	DAE4 Sn1429, 2018-05-17

Scan Setup

	Area Scan	Zoom Scan
Grid Extents [mm]	60.0 x 360.0	30.0 x 30.0 x 30.0
Grid Steps [mm]	15.0 x 15.0	6.0 x 6.0 x 5.0
Sensor Surface [mm]	3.0	1.4
Graded Grid	No	No
Grading Ratio	n/a	n/a
MAIA	Confirmed by MAIA	Confirmed by MAIA
Surface Detection	Yes	Yes
Scan Method	Measured	Measured
Peak Information	8.74e-08;	135; -173.94

Measurement Results

	Area Scan	Zoom Scan
Date	2019-04-29, 12:28	2019-04-29, 12:40
SAR 1g [W/Kg]	0.658	1.01
SAR 10g [W/Kg]	0.331	0.369
Power Drift [dB]	-0.00	-0.01
Power Scaling	Disabled	Disabled
Scaling Factor [dB]		
TSL Correction	No correction	No correction

Warning(s) / Error(s)

Details	Area Scan	Zoom Scan
Warning(s) Error(s)		

“Peak Information”: coordinate of the Peak SAR Location is **(0; 135; -173.94)**.

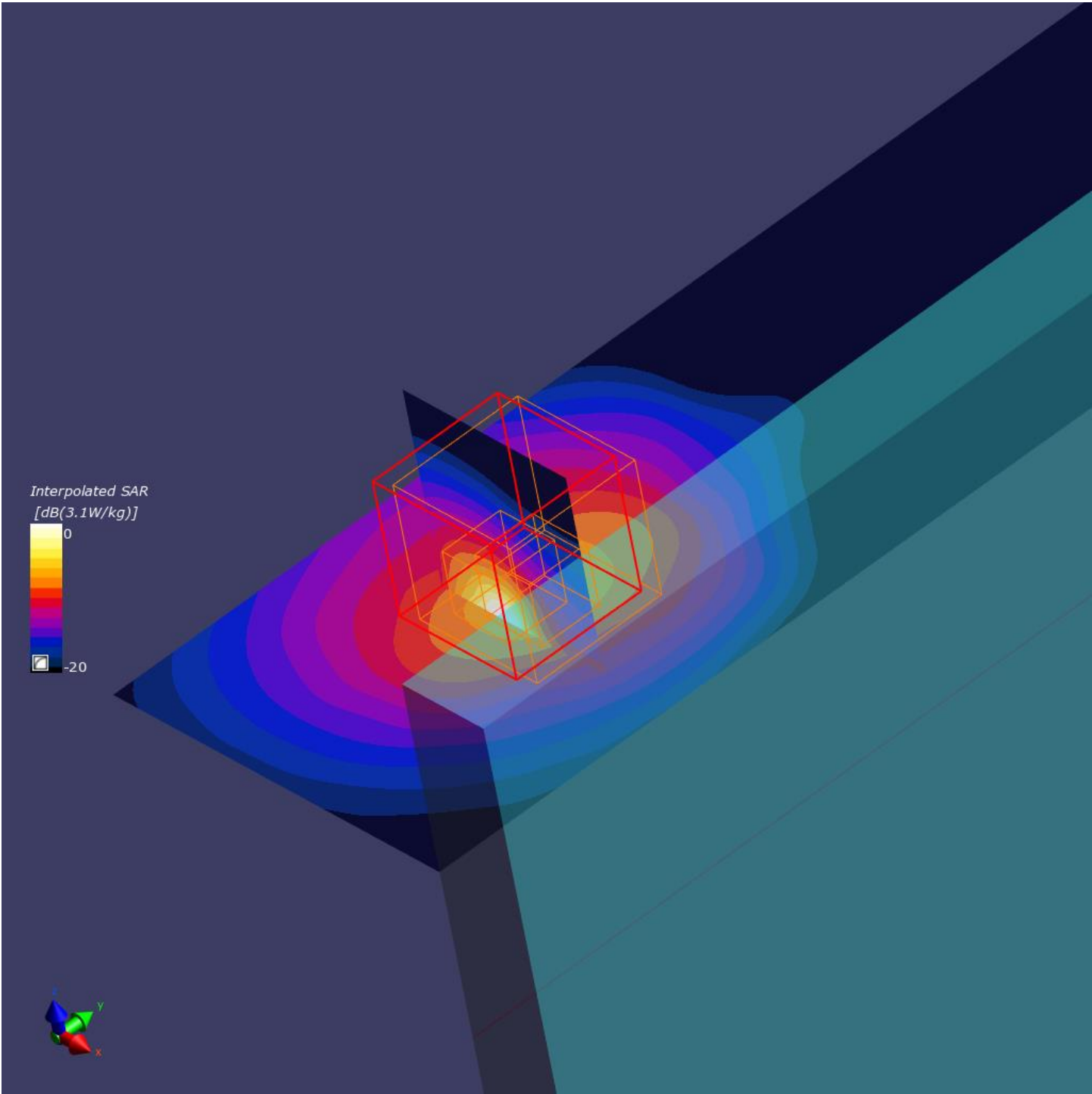

C.2 Case #1: Single-Point SAR validation of TAS at *Max_Power_DPR_OFF*

C.2.1 1-g SAR with TAS disabled (*Max_Power_DPR_OFF*) to Identify Peak Location for Single-Point SAR Measurement

Peak Information: coordinate of the Peak SAR location is (0; 135; -173.94), which corresponds to the same peak location in the 1-g SAR measurement at the power level of *Avg_SAR_UppThresh* in Section C1.

C.2.2 Single-Point SAR Measurement Results for *Max_Power_DPR_OFF*

Figure C.2.2 is a plot of single-point SAR measurement results. **TAS** is enabled after the 1-g SAR measurement at maximum output power (*Max_Power_DPR_OFF*) is completed and the same maximum output power is requested for the single-point SAR measurement with **TAS** enabled. **TAS** is able to maintain the single-point SAR below *SSAR_Avg_UppThresh* (red line) and at the equivalent of *Avg_SAR_LowThresh* (green line) for single-point SAR to remain between these SAR thresholds according to the procedures described in section 7.2.1. *SSAR_Avg_UppThresh* (2.33 W/kg) is calculated according to the interpolated peak (*SAR_instantaneous_max* = 4.27 W/kg) and 1-g SAR (*SAR_ref*), and the measured *SAR_target* (1.01 W/kg) in C.1. The corresponding low threshold for single-point SAR is 1 dB lower.

As explained in the “Important Note” in step 5 b), power is monitored regardless of **TAS** is enabled or disabled; therefore, *Avg_SAR_Power* (blue curve) is at the maximum when **TAS** is enabled (t=0) and **DPR** is turned ON immediately due to the transition from **TAS** disable to enable state in Test Mode i.e. the black curve of instantaneous SAR starts at the level corresponding to *Max_Power_DPR_ON* level. These are reflected in the plot below. The transition from **TAS** disable to enabled state is completed when *Avg_SAR_Power* falls below the low threshold (green line) at t=189s. **TAS** is able to maintain the single-point SAR between the upper and lower threshold as in the end user operating environment.

In the end use case when the **TAS** is enabled directly after boot, the behavior will be similar to Fig.1 and the plots of Annex B.

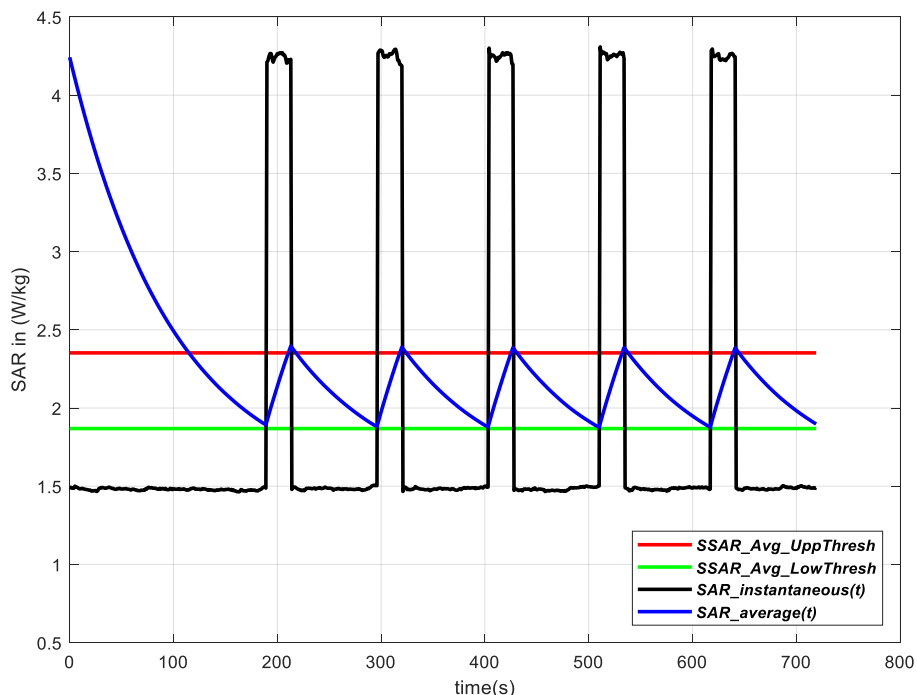

Figure C.2.2 – Single-Point SAR Measurement at *Max_Power_DPR_OFF*

This plot of single-point SAR corresponds to step 2 of cDASY6 Time-Average SAR Measurement Procedures (section 7.2.2). Therefore the SAR metric presented in this plot is the single-point SAR and not the 1-g SAR for which the limit of 1.6W/Kg is defined. However there is a correspondence between both metrics. The single-point SAR average upper threshold i.e. *SSAR_Avg_UppThresh* of 2.33 W/kg is equivalent to 1-g *SAR_target* of 1.01 W/Kg. Therefore in the end use actual 1-g SAR will not exceed the *SAR_target*.

C.2.3 Conducted Power Measurement

The same conditions in C.2.2 are applied to conducted power measurements and the results are shown in Figure C.2.3.

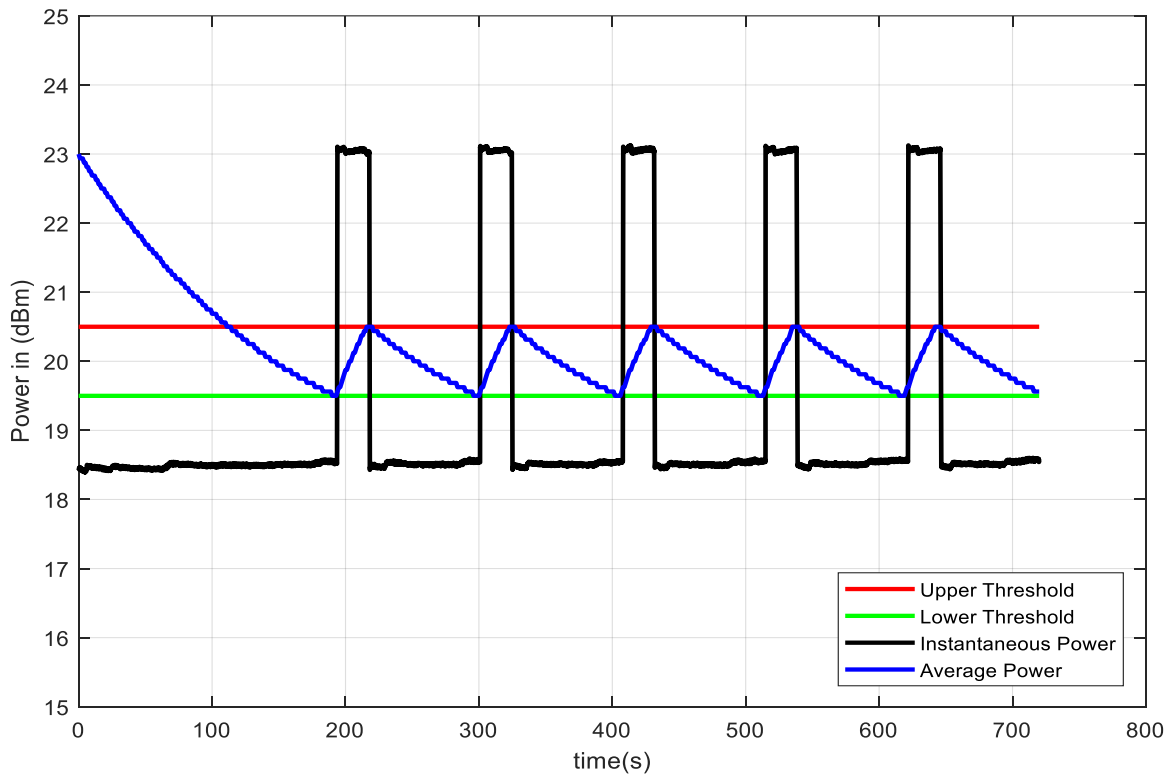

Figure C.2.3 – Conducted Power Measurement at Max_Power_DPR_OFF

C.2.4 Comparison of Normalized Single-Point SAR and Normalized Conducted Power Results

Figure C.2.4 shows the comparison of normalized single-point SAR and normalized conducted power results. The SAR parameters are normalized to the interpolated peak SAR in C.2.2 i.e. 4.27 W/kg, which is the same as **SAR_instantaneous_max** described in C.2.2. The power parameters are normalized to the maximum shown in Figure C.2.3, i.e. 23.1 dBm.

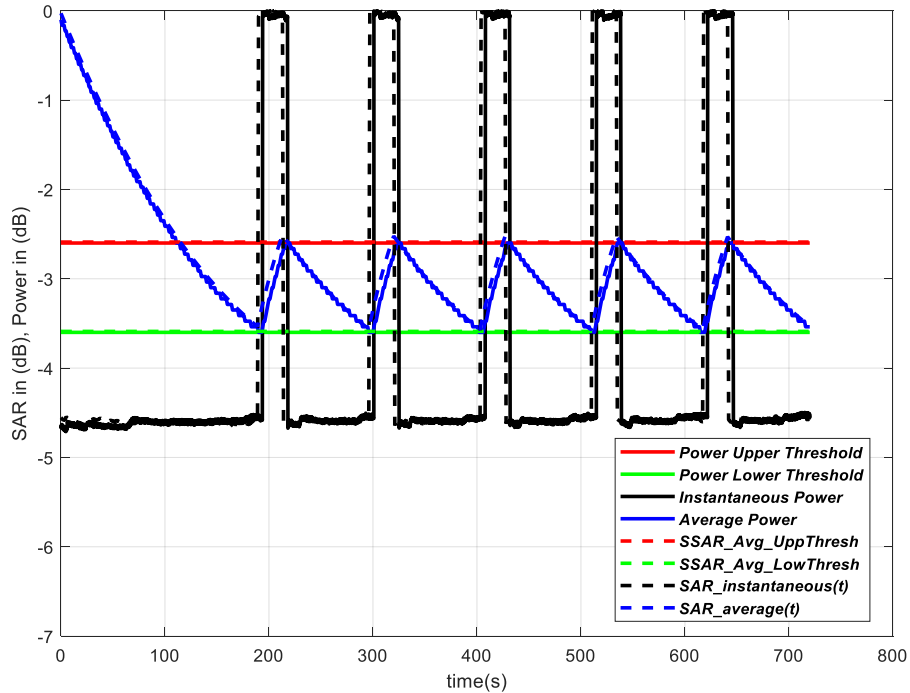

Figure C.2.4 – Normalized Single-Point SAR vs Conducted Values

C.3 Case #2: Single-Point SAR Validation for TAS using Test Sequence #1

C.3.1 1-g SAR with TAS disabled (*Max_Power_DPR_OFF*) to Identify Peak Location for Single-Point SAR Measurement

Peak Information: coordinate of Peak SAR location is **(0; 135; -173.94)**, which corresponds to the same location of the 1-g SAR measurement at the power level of *Avg_SAR_UppThresh* shown in section C.1

C.3.2 Single-Point SAR Measurement Results for Test Sequence #1

Figure C.3.2-1 is a plot of the single-point SAR results for test sequence #1. **TAS** is enabled after the 1-g SAR measurement at maximum output power (*Max_Power_DPR_OFF*) is completed and Test Sequence #1 is sent from the Call Box for single-point SAR measurement with **TAS** enabled. **TAS** is able to maintain the single-point SAR below *SSAR_Avg_UppThresh* (red line) and at the equivalent of *Avg_SAR_LowThresh* (green line) for single-point SAR to remain between these SAR thresholds according to the procedures described in section 7.2.1. *SSAR_Avg_UppThresh* (2.34 W/kg) is calculated according to the interpolated peak (*SAR_instantaneous_max* = 4.24 W/kg) and 1-g SAR (*SAR_ref*), and the measured *SAR_target* (1.01 W/kg) in C.1. The corresponding low threshold for single-point SAR is 1 dB lower.

As explained in the “Important Note” in step 5 b), power is monitored regardless of **TAS** is enabled or disabled; therefore, *Avg_SAR_Power* is at the maximum when **TAS** is enabled and **DPR** is turned ON immediately due to the transition from **TAS** disable to enable state in Test Mode. These are reflected in the plot below. The transition from **TAS** disable to enabled state is completed when *Avg_SAR_Power* falls below the low threshold (green line), **TAS** is able to maintain the single-point SAR between the upper and lower threshold as in the end user operating environment.

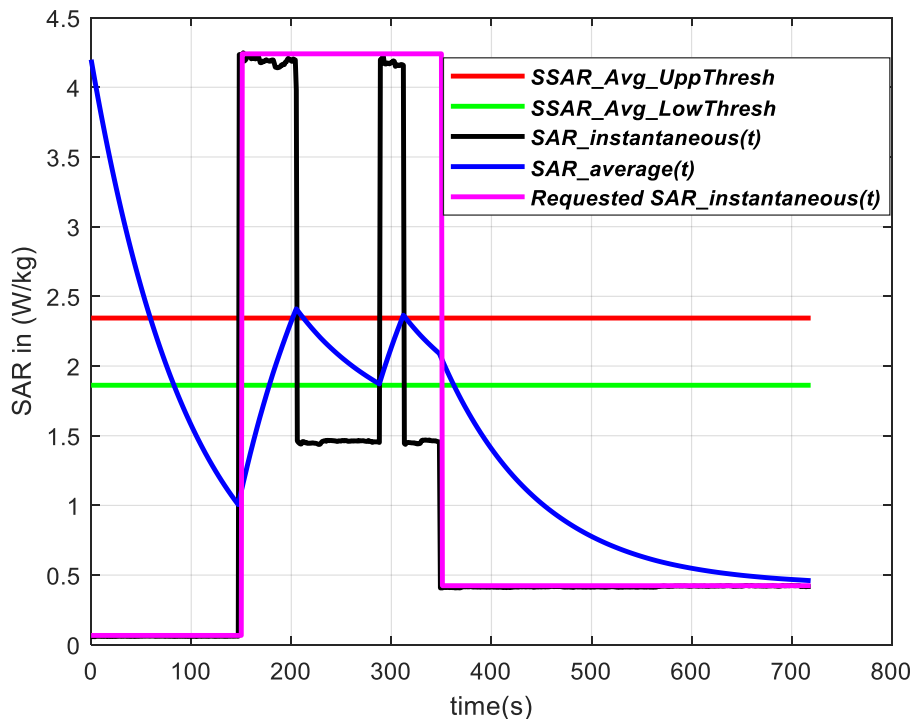

Figure C.3.2 – Single-Point SAR Measurement with Test Sequence #1

This plot of single-point SAR corresponds to step 2 of cDASY6 Time-Average SAR Measurement Procedures (section 7.2.2). Therefore the SAR metric presented in this plot is the single-point SAR and not the 1-g SAR for which the limit of 1.6W/Kg is defined. However there is a correspondence between both metrics. The single-point SAR average upper threshold i.e. *SSAR_Avg_UppThresh* of 2.34 W/kg is equivalent to 1-g *SAR_target* of 1.01 W/Kg. Therefore in the end use actual 1-g SAR will not exceed the *SAR_target*.

C.3.3 Conducted Power Measurement

The same conditions in C.3.2 are applied to conducted power measurements and the results are shown in Figure C.3.3.

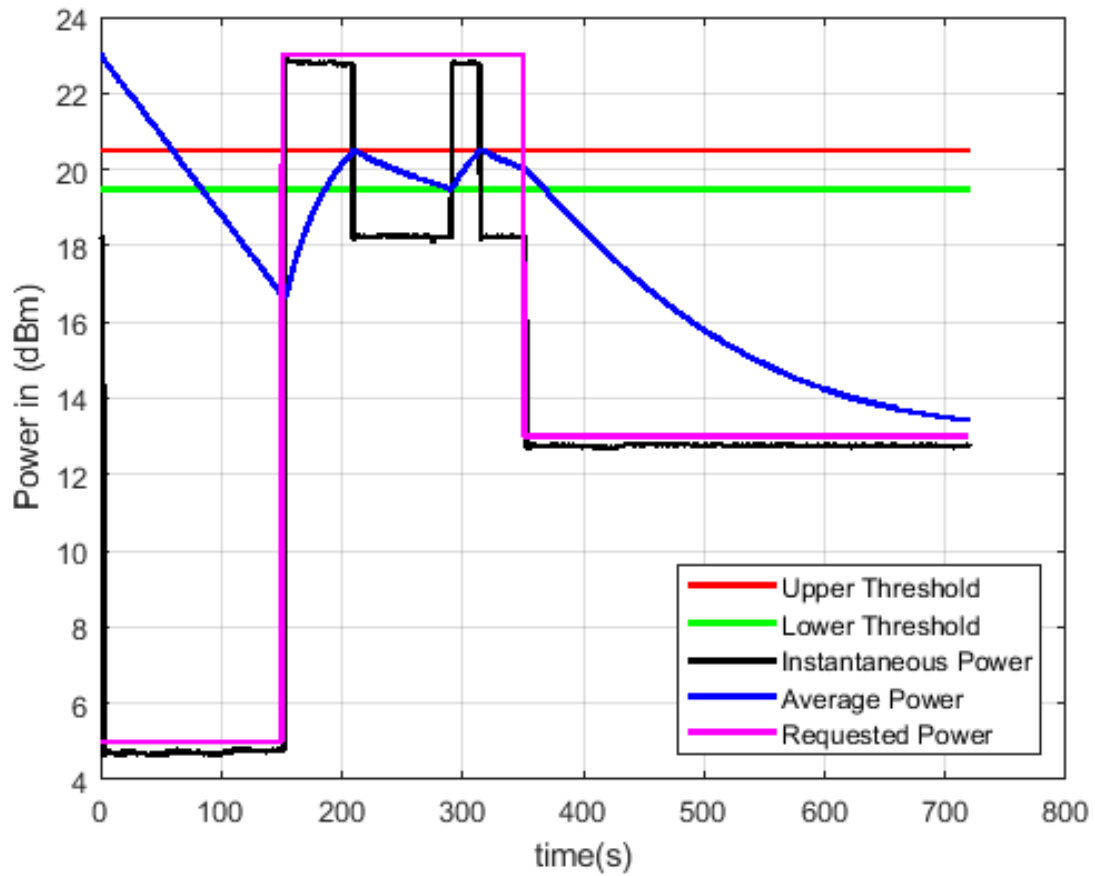

Figure C.3.3 – Conducted Power measurement with Test Sequence #1

C.3.4 Comparison of Normalized Single-Point SAR and Normalized Conducted Power Results

Figure C.3.4 shows the comparison of normalized single-point SAR and normalized conducted power results. The SAR parameters are normalized to the interpolated peak SAR in C.3.2 i.e. 4.24 W/kg, which is the same as **SAR_instantaneous_max** described in C.3.2. The Power parameters are normalized to the maximum shown in Figure C.3.3, i.e. 23.1 dBm.

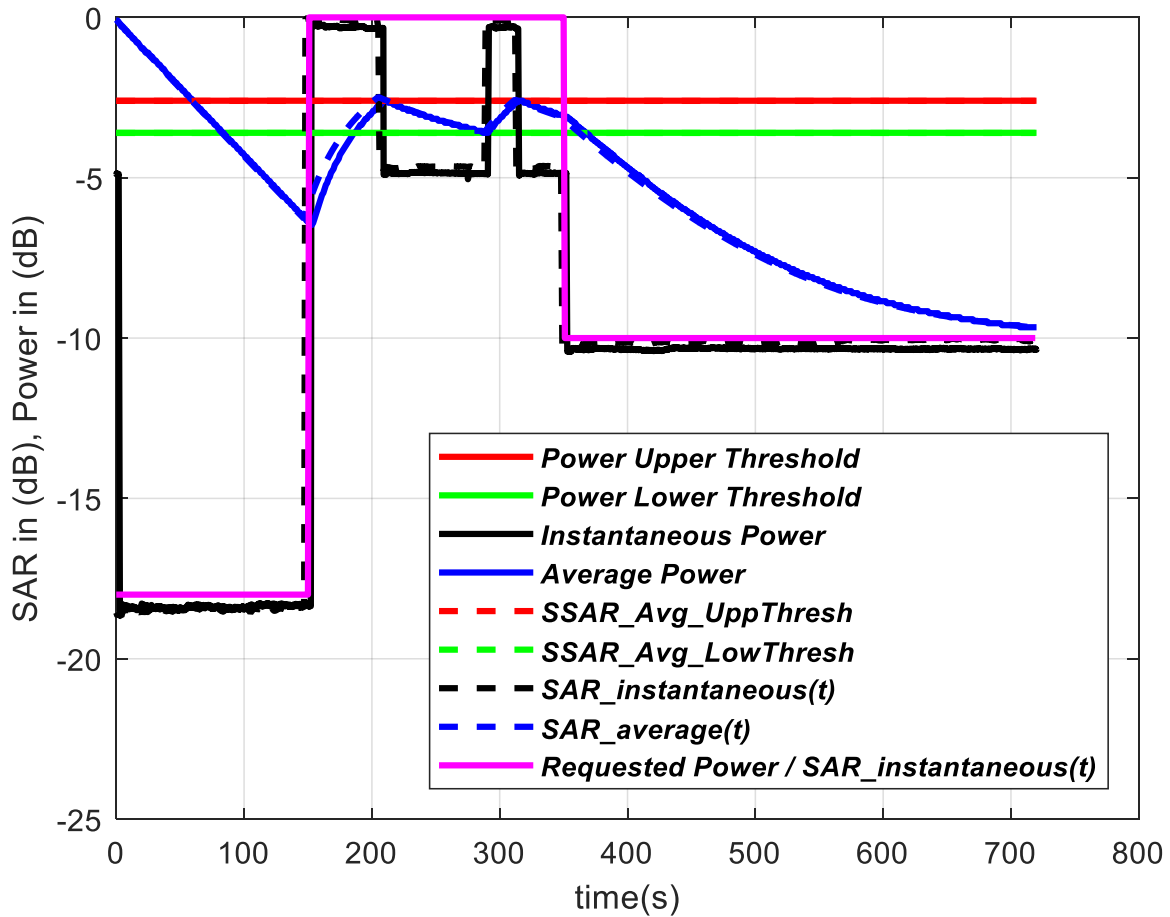

Figure C.3.4 – Normalized Single-Point SAR vs Conducted power