

FCC Test Report

(PART 27)

Report No.: RF180704C01-4

FCC ID: ZMOL850GLD

Test Model: L850-GL

Received Date: Jul. 04, 2018

Test Date: Jul. 10, 2018 ~ Jul. 17, 2018

Issued Date: Jul. 19, 2018

Applicant: Fibocom Wireless Inc.

Address: 5/F, Tower A, Technology Building II, 1057 Nanhai Blvd, Nanshan,
Shenzhen, China

Issued By: Bureau Veritas Consumer Products Services (H.K.) Ltd., Taoyuan Branch

Lab Address: No. 47-2, 14th Ling, Chia Pau Vil., Lin Kou Dist., New Taipei City, Taiwan
(R.O.C)

Test Location: No. 19, Hwa Ya 2nd Rd, Wen Hwa Vil, Kwei Shan Dist., Taoyuan City
33383, Taiwan (R.O.C)

**FCC Registration /
Designation Number:** 788550 / TW0003



This report is for your exclusive use. Any copying or replication of this report to or for any other person or entity, or use of our name or trademark, is permitted only with our prior written permission. This report sets forth our findings solely with respect to the test samples identified herein. The results set forth in this report are not indicative or representative of the quality or characteristics of the lot from which a test sample was taken or any similar or identical product unless specifically and expressly noted. Our report includes all of the tests requested by you and the results thereof based upon the information that you provided to us. You have 60 days from date of issuance of this report to notify us of any material error or omission caused by our negligence, provided, however, that such notice shall be in writing and shall specifically address the issue you wish to raise. A failure to raise such issue within the prescribed time shall constitute your unqualified acceptance of the completeness of this report, the tests conducted and the correctness of the report contents. Unless specific mention, the uncertainty of measurement has been explicitly taken into account to declare the compliance or non-compliance to the specification. The report must not be used by the client to claim product certification, approval, or endorsement by TAF or any government agencies

Table of Contents

Release Control Record	4
1 Certificate of Conformity	5
2 Summary of Test Results	6
2.1 Measurement Uncertainty	9
2.2 Test Site and Instruments	10
3 General Information	11
3.1 General Description of EUT	11
3.2 Configuration of System under Test	13
3.2.1 Description of Support Units	13
3.3 Test Mode Applicability and Tested Channel Detail	13
3.4 EUT Operating Conditions	21
3.5 General Description of Applied Standards	21
4 Test Types and Results	22
4.1 Output Power Measurement	22
4.1.1 Limits of Output Power Measurement	22
4.1.2 Test Procedures	22
4.1.3 Test Setup	22
4.1.4 Test Results	23
4.2 Modulation Characteristics Measurement	34
4.2.1 Limits of Modulation Characteristics	34
4.2.2 Test Setup	34
4.2.3 Test Procedure	34
4.2.4 Test Results	35
4.3 Frequency Stability Measurement	37
4.3.1 Limits of Frequency Stability Measurement	37
4.3.2 Test Procedure	37
4.3.3 Test Setup	37
4.3.4 Test Results	38
4.4 Occupied Bandwidth Measurement	59
4.4.1 Limits of Occupied Bandwidth Measurement	59
4.4.2 Test Procedure	59
4.4.3 Test Setup	59
4.4.4 Test Result	60
4.5 Band Edge Measurement	71
4.5.1 Limits of Band Edge Measurement	71
4.5.2 Test Setup	71
4.5.3 Test Procedures	71
4.5.4 Test Results	72
4.6 Peak to Average Ratio	94
4.6.1 Limits of Peak to Average Ratio Measurement	94
4.6.2 Test Setup	94
4.6.3 Test Procedures	94
4.6.4 Test Results	95
4.7 Conducted Spurious Emissions	106
4.7.1 Limits of Conducted Spurious Emissions Measurement	106
4.7.2 Test Setup	106
4.7.3 Test Procedure	106
4.7.4 Test Results	107
4.8 Radiated Emission Measurement	154
4.8.1 Limits of Radiated Emission Measurement	154
4.8.2 Test Procedure	154
4.8.3 Deviation from Test Standard	154
4.8.4 Test Setup	155

4.8.5 Test Results	156
5 Pictures of Test Arrangements.....	190
Appendix – Information on the Testing Laboratories	191

Release Control Record

Issue No.	Description	Date Issued
RF180704C01-4	Original Release	Jul. 19, 2018

1 Certificate of Conformity

Product: LTE module

Brand: Fibocom

Test Model: L850-GL

Sample Status: Identical Prototype

Applicant: Fibocom Wireless Inc.

Test Date: Jul. 10, 2018 ~ Jul. 17, 2018

Standards: FCC Part 27, Subpart C, H, F, L

The above equipment has been tested by **Bureau Veritas Consumer Products Services (H.K.) Ltd., Taoyuan Branch**, and found compliance with the requirement of the above standards. The test record, data evaluation & Equipment Under Test (EUT) configurations represented herein are true and accurate accounts of the measurements of the sample's RF characteristics under the conditions specified in this report.

Prepared by :

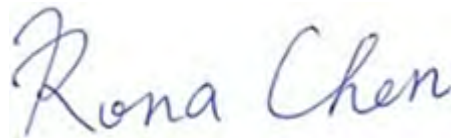

Date:

Jul. 19, 2018

Rona Chen / Specialist

Approved by :



Date:

Jul. 19, 2018

Dylan Chiou / Project Engineer

2 Summary of Test Results

Applied Standard: FCC Part 27 & Part 2 (WCDMA)			
FCC Clause	Test Item	Result	Remarks
2.1046 27.50(d)(4)	Equivalent Isotropic Radiated Power	Pass	Meet the requirement of limit.
2.1047	Modulation Characteristics	Pass	Meet the requirement.
2.1055 27.54	Frequency Stability	Pass	Meet the requirement of limit.
2.1049 27.53(h)	Occupied Bandwidth	Pass	Meet the requirement of limit.
27.50(d)(5)	Peak to Average Ratio	Pass	Meet the requirement of limit.
27.53(h)	Band Edge Measurements	Pass	Meet the requirement of limit.
2.1051 27.53(h)	Conducted Spurious Emissions	Pass	Meet the requirement of limit.
2.1053 27.53(h)	Radiated Spurious Emissions	Pass	Meet the requirement of limit. Minimum passing margin is -26.19 dB at 7010.40 MHz.

Applied Standard: FCC Part 27 & Part 2 (LTE 4)			
FCC Clause	Test Item	Result	Remarks
2.1046 27.50(d)(4)	Maximum Peak Output Power	Pass	Meet the requirement of limit.
2.1047	Modulation Characteristics	Pass	Meet the requirement.
2.1055 27.54	Frequency Stability	Pass	Meet the requirement of limit.
2.1049 27.53(h)	Occupied Bandwidth	Pass	Meet the requirement of limit.
27.50(d)(5)	Peak to Average Ratio	Pass	Meet the requirement of limit.
27.53(h)	Band Edge Measurements	Pass	Meet the requirement of limit.
2.1051 27.53(h)	Conducted Spurious Emissions	Pass	Meet the requirement of limit.
2.1053 27.53(h)	Radiated Spurious Emissions	Pass	Meet the requirement of limit. Minimum passing margin is -20.59 dB at 6980.00 MHz.

Applied Standard: FCC Part 27 & Part 2 (LTE 12)			
FCC Clause	Test Item	Result	Remarks
2.1046 27.50(c)(10)	Maximum Peak Output Power	Pass	Meet the requirement of limit.
2.1047	Modulation Characteristics	Pass	Meet the requirement.
2.1055 27.54	Frequency Stability	Pass	Meet the requirement of limit.
2.1049 27.53(g)	Occupied Bandwidth	Pass	Meet the requirement of limit.
27.50(d)(5)	Peak to Average Ratio	Pass	Meet the requirement of limit.
27.53(g)	Band Edge Measurements	Pass	Meet the requirement of limit.
2.1051 27.53(g)	Conducted Spurious Emissions	Pass	Meet the requirement of limit.
2.1053 27.53(g)	Radiated Spurious Emissions	Pass	Meet the requirement of limit. Minimum passing margin is -30.57 dB at 39.70 MHz.

Applied Standard: FCC Part 27 & Part 2 (LTE 13)			
FCC Clause	Test Item	Result	Remarks
2.1046 27.50(b)(10)	Maximum Peak Output Power	Pass	Meet the requirement of limit.
2.1047	Modulation Characteristics	Pass	Meet the requirement.
2.1055 27.54	Frequency Stability	Pass	Meet the requirement of limit.
2.1049 27.53(g)	Occupied Bandwidth	Pass	Meet the requirement of limit.
27.50(d)(5)	Peak to Average Ratio	Pass	Meet the requirement of limit.
27.53(g)	Band Edge Measurements	Pass	Meet the requirement of limit.
2.1051 27.53(g)	Conducted Spurious Emissions	Pass	Meet the requirement of limit.
2.1053 27.53(g)(f)	Radiated Spurious Emissions	Pass	Meet the requirement of limit. Minimum passing margin is -17.63 dB at 1564.00 MHz.

Applied Standard: FCC Part 27 & Part 2 (LTE 17)			
FCC Clause	Test Item	Result	Remarks
2.1046 27.50(c)(10)	Maximum Peak Output Power	Pass	Meet the requirement of limit.
2.1047	Modulation Characteristics	Pass	Meet the requirement.
2.1055 27.54	Frequency Stability	Pass	Meet the requirement of limit.
2.1049 27.53(g)	Occupied Bandwidth	Pass	Meet the requirement of limit.
27.50(d)(5)	Peak to Average Ratio	Pass	Meet the requirement of limit.
27.53(g)	Band Edge Measurements	Pass	Meet the requirement of limit.
2.1051 27.53(g)	Conducted Spurious Emissions	Pass	Meet the requirement of limit.
2.1053 27.53(g)	Radiated Spurious Emissions	Pass	Meet the requirement of limit. Minimum passing margin is -30.57 dB at 39.70 MHz.

Applied Standard: FCC Part 27 & Part 2 (LTE 66)			
FCC Clause	Test Item	Result	Remarks
2.1046 27.50(d)(4)	Maximum Peak Output Power	Pass	Meet the requirement of limit.
2.1047	Modulation Characteristics	Pass	Meet the requirement.
2.1055 27.54	Frequency Stability	Pass	Meet the requirement of limit.
2.1049 27.53(h)	Occupied Bandwidth	Pass	Meet the requirement of limit.
27.50(d)(5)	Peak to Average Ratio	Pass	Meet the requirement of limit.
27.53(h)	Band Edge Measurements	Pass	Meet the requirement of limit.
2.1051 27.53(h)	Conducted Spurious Emissions	Pass	Meet the requirement of limit.
2.1053 27.53(h)	Radiated Spurious Emissions	Pass	Meet the requirement of limit. Minimum passing margin is -30.01 dB at 39.70 MHz.

2.1 Measurement Uncertainty

Where relevant, the following measurement uncertainty levels have been estimated for tests performed on the EUT as specified in CISPR 16-4-2:

Measurement	Frequency	Expanded Uncertainty (k=2) (\pm)
Radiated Emissions up to 1 GHz	30 MHz ~ 200 MHz	2.93 dB
	200 MHz ~ 1000 MHz	2.95 dB
Radiated Emissions above 1 GHz	1 GHz ~ 18 GHz	2.26 dB
	18 GHz ~ 40 GHz	1.94 dB

2.2 Test Site and Instruments

Description & Manufacturer	Model No.	Serial No.	Date of Calibration	Due Date of Calibration
Test Receiver Agilent	N9038A	MY51210203	Mar. 16, 2018	Mar. 15, 2019
Spectrum Analyzer Agilent	N9010A	MY52220314	Nov. 24, 2017	Nov. 23, 2018
Spectrum Analyzer ROHDE & SCHWARZ	FSU43	101261	Jan. 11, 2018	Jan. 10, 2019
Double Ridge Guide Horn Antenna EMCO	3115	5619	Nov. 30, 2017	Nov. 29, 2018
BILOG Antenna SCHWARZBECK	VULB 9168	9168-153	Dec. 06, 2017	Dec. 05, 2018
Fixed Attenuator Mini-Circuits	MDCS18N-10	MDCS18N-10-01	Apr. 16, 2018	Apr. 15, 2019
Preamplifier EMCI	EMC 012645	980115	Oct. 20, 2017	Oct. 19, 2018
Preamplifier EMCI	EMC 184045	980116	Oct. 20, 2017	Oct. 19, 2018
Preamplifier EMCI	EMC 330H	980112	Oct. 13, 2017	Oct. 12, 2018
Power Meter Anritsu	ML2495A	1012010	Aug. 15, 2017	Aug. 14, 2018
Power Sensor Anritsu	MA2411B	1315050	Aug. 15, 2017	Aug. 14, 2018
RF Coaxial Cable HUBER+SUHNNER	EMC104-SM-SM-800 0&3000	140811+170717	Oct. 20, 2017	Oct. 19, 2018
RF Coaxial Cable HUBER+SUHNNER	SUCOFLEX 104	EMC104-SM-SM- 1000(140807)	Oct. 20, 2017	Oct. 19, 2018
RF Coaxial Cable Worken	8D-FB	Cable-Ch10-01	Oct. 20, 2017	Oct. 19, 2018
Software BV ADT	E3 6.120103	NA	NA	NA
Antenna Tower MF	MFA-440H	NA	NA	NA
Turn Table MF	MFT-201SS	NA	NA	NA
Antenna Tower & Turn Table Controller MF	MF-7802	NA	NA	NA
Radio Communication Analyzer	MT8820C	6201300640	Aug. 16, 2017	Aug. 15, 2019
Temperature & Humidity Chamber	GTH-120-40-CP-AR	MAA1306-019	Sep. 08, 2017	Sep. 07, 2018
DC Power Supply Topward	33010D	807748	Oct. 25, 2016	Oct. 24, 2018
Digital Multimeter Fluke	87-III	70360742	Jun. 29, 2018	Jun. 28, 2019

- Note: 1. The calibration interval of the above test instruments is 12 / 24 months and the calibrations are traceable to NML/ROC and NIST/USA.
2. The test was performed in HwaYa Chamber 10.
3. The horn antenna and preamplifier (model: EMC 184045) are used only for the measurement of emission frequency above 1 GHz if tested.
4. The IC Site Registration No. is IC7450F-10.

3 General Information

3.1 General Description of EUT

Product	LTE module	
Brand	Fibocom	
Test Model	L850-GL	
Status of EUT	Identical Prototype	
Power Supply Rating	3.3 Vdc (Host equipment)	
Modulation Type	WCDMA	QPSK
	LTE	QPSK, 16QAM
Frequency Range	WCDMA	1712.4 ~ 1752.6 MHz
	LTE Band 4 (Channel Bandwidth: 1.4 MHz)	1710.7 ~ 1754.3 MHz
	LTE Band 4 (Channel Bandwidth: 3 MHz)	1711.5 ~ 1753.5 MHz
	LTE Band 4 (Channel Bandwidth: 5 MHz)	1712.5 ~ 1752.5 MHz
	LTE Band 4 (Channel Bandwidth: 10 MHz)	1715.0 ~ 1750.0 MHz
	LTE Band 4 (Channel Bandwidth: 15 MHz)	1717.5 ~ 1747.5 MHz
	LTE Band 4 (Channel Bandwidth: 20 MHz)	1720.0 ~ 1745.0 MHz
	LTE Band 12 (Channel Bandwidth: 1.4 MHz)	699.7 ~ 715.3 MHz
	LTE Band 12 (Channel Bandwidth: 3 MHz)	700.5 ~ 714.5 MHz
	LTE Band 12 (Channel Bandwidth: 5 MHz)	701.5 ~ 713.5 MHz
	LTE Band 12 (Channel Bandwidth: 10 MHz)	704.0 ~ 711.0 MHz
	LTE Band 13 (Channel Bandwidth: 5 MHz)	779.5 ~ 784.5 MHz
	LTE Band 13 (Channel Bandwidth: 10 MHz)	782.0 MHz
	LTE Band 17 (Channel Bandwidth: 5 MHz)	706.5 ~ 713.5 MHz
	LTE Band 17 (Channel Bandwidth: 10 MHz)	709.0 ~ 711.0 MHz
	LTE Band 66 (Channel Bandwidth: 1.4 MHz)	1710.7 ~ 1779.3 MHz
	LTE Band 66 (Channel Bandwidth: 3 MHz)	1711.5 ~ 1778.5 MHz
	LTE Band 66 (Channel Bandwidth: 5 MHz)	1712.5 ~ 1777.5 MHz
	LTE Band 66 (Channel Bandwidth: 10 MHz)	1715.0 ~ 1775.0 MHz
	LTE Band 66 (Channel Bandwidth: 15 MHz)	1717.5 ~ 1772.5 MHz
LTE Band 66 (Channel Bandwidth: 20 MHz)	1720.0 ~ 1770.0 MHz	
Emission Designator	WCDMA	4M08F9W
	LTE Band 4 (Channel Bandwidth: 1.4 MHz)	1M10W7D
	LTE Band 4 (Channel Bandwidth: 3 MHz)	2M70G7D
	LTE Band 4 (Channel Bandwidth: 5 MHz)	4M50G7D
	LTE Band 4 (Channel Bandwidth: 10 MHz)	8M99G7D
	LTE Band 4 (Channel Bandwidth: 15 MHz)	13M48W7D
	LTE Band 4 (Channel Bandwidth: 20 MHz)	17M99W7D
	LTE Band 12 (Channel Bandwidth: 1.4 MHz)	1M10G7D
	LTE Band 12 (Channel Bandwidth: 3 MHz)	2M71W7D
	LTE Band 12 (Channel Bandwidth: 5 MHz)	4M50G7D
	LTE Band 12 (Channel Bandwidth: 10 MHz)	9M00G7D
	LTE Band 13 (Channel Bandwidth: 5 MHz)	4M50G7D
	LTE Band 13 (Channel Bandwidth: 10 MHz)	8M97G7D
	LTE Band 17 (Channel Bandwidth: 5 MHz)	4M50G7D

	LTE Band 17 (Channel Bandwidth: 10 MHz)	8M99G7D
	LTE Band 66 (Channel Bandwidth: 1.4 MHz)	1M10W7D
	LTE Band 66 (Channel Bandwidth: 3 MHz)	2M71W7D
	LTE Band 66 (Channel Bandwidth: 5 MHz)	4M51W7D
	LTE Band 66 (Channel Bandwidth: 10 MHz)	9M00G7D
	LTE Band 66 (Channel Bandwidth: 15 MHz)	13M48W7D
	LTE Band 66 (Channel Bandwidth: 20 MHz)	17M98G7D
Max. ERP Power	LTE Band 12 (Channel Bandwidth: 1.4 MHz)	234.42 mW
	LTE Band 12 (Channel Bandwidth: 3 MHz)	233.35 mW
	LTE Band 12 (Channel Bandwidth: 5 MHz)	238.23 mW
	LTE Band 12 (Channel Bandwidth: 10 MHz)	240.99 mW
	LTE Band 13 (Channel Bandwidth: 5 MHz)	252.35 mW
	LTE Band 13 (Channel Bandwidth: 10 MHz)	252.93 mW
	LTE Band 17 (Channel Bandwidth: 5 MHz)	244.34 mW
	LTE Band 17 (Channel Bandwidth: 10 MHz)	247.17 mW
Max. EIRP Power	WCDMA	859.01 mW
	LTE Band 4 (Channel Bandwidth: 1.4 MHz)	610.94 mW
	LTE Band 4 (Channel Bandwidth: 3 MHz)	616.60 mW
	LTE Band 4 (Channel Bandwidth: 5 MHz)	618.02 mW
	LTE Band 4 (Channel Bandwidth: 10 MHz)	633.87 mW
	LTE Band 4 (Channel Bandwidth: 15 MHz)	638.26 mW
	LTE Band 4 (Channel Bandwidth: 20 MHz)	647.14 mW
	LTE Band 66 (Channel Bandwidth: 1.4 MHz)	641.21 mW
	LTE Band 66 (Channel Bandwidth: 3 MHz)	656.15 mW
	LTE Band 66 (Channel Bandwidth: 5 MHz)	657.66 mW
	LTE Band 66 (Channel Bandwidth: 10 MHz)	669.88 mW
	LTE Band 66 (Channel Bandwidth: 15 MHz)	682.34 mW
	LTE Band 66 (Channel Bandwidth: 20 MHz)	687.07 mW
Antenna Type	External Antenna	
Antenna Gain	WCDMA	5.0 dBi
	LTE Band 4	5.0 dBi
	LTE Band 12	3.0 dBi
	LTE Band 13	3.0 dBi
	LTE Band 17	3.0 dBi
	LTE Band 66	5.0 dBi
Accessory Device	N/A	
Data Cable Supplied	N/A	

Note:

1. The above EUT information is declared by manufacturer and for more detailed features description, please refers to the manufacturer's specifications or user's manual.

3.2 Configuration of System under Test

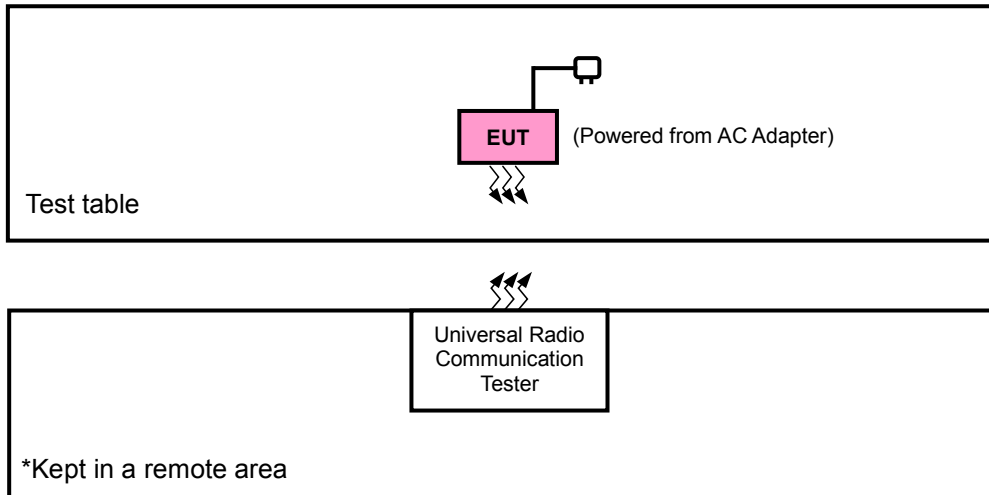

3.2.1 Description of Support Units

The EUT has been tested as an independent unit together with other necessary accessories or support units.

3.3 Test Mode Applicability and Tested Channel Detail

Pre-Scan has been conducted to determine the worst-case mode from all possible combinations between available modulations, data rates, XYZ axis, and antenna ports

The worst case was found when positioned as the table below. Following channel(s) was (were) selected for the final test as listed below:

Band	Radiated Emission
WCDMA	Z-axis
LTE Band 4	Z-axis
LTE Band 12	Z-axis
LTE Band 13	Z-axis
LTE Band 17	Z-axis
LTE Band 66	Z-axis

WCDMA

EUT Configure Mode	Test Item	Available Channel	Tested Channel	Mode
-	EIRP	1312 to 1513	1312, 1413, 1513	WCDMA
-	Modulation Characteristics	1312 to 1513	1413	WCDMA
-	Frequency Stability	1312 to 1513	1312, 1513	WCDMA
-	Occupied Bandwidth	1312 to 1513	1312, 1413, 1513	WCDMA
-	Band Edge	1312 to 1513	1312, 1513	WCDMA
-	Peak to Average Ratio	1312 to 1513	1312, 1413, 1513	WCDMA
-	Conducted Emission	1312 to 1513	1312, 1413, 1513	WCDMA
-	Radiated Emission	1312 to 1513	1312, 1413, 1513	WCDMA

LTE Band 4

EUT Configure Mode	Test Item	Available Channel	Tested Channel	Channel Bandwidth	Modulation	Mode
-	EIRP	19957 to 20393	19957, 20175, 20393	1.4 MHz	QPSK, 16QAM	1 RB / 0 RB Offset
		19965 to 20385	19965, 20175, 20385	3 MHz	QPSK, 16QAM	1 RB / 0 RB Offset
		19975 to 20375	19975, 20175, 20375	5 MHz	QPSK, 16QAM	1 RB / 0 RB Offset
		20000 to 20350	20000, 20175, 20350	10 MHz	QPSK, 16QAM	1 RB / 0 RB Offset
		20025 to 20325	20025, 20175, 20325	15 MHz	QPSK, 16QAM	1 RB / 0 RB Offset
		20050 to 20300	20050, 20175, 20300	20 MHz	QPSK, 16QAM	1 RB / 0 RB Offset
-	Modulation Characteristics	20050 to 20300	20175	5 MHz	QPSK, 16QAM	25 RB / 0 RB Offset
-	Frequency Stability	19957 to 20393	19957, 20393	1.4 MHz	QPSK	1 RB / 5 RB Offset
		19965 to 20385	19965, 20385	3 MHz	QPSK	1 RB / 14 RB Offset
		19975 to 20375	19975, 20375	5 MHz	QPSK	1 RB / 24 RB Offset
		20000 to 20350	20000, 20350	10 MHz	QPSK	1 RB / 49 RB Offset
		20025 to 20325	20025, 20325	15 MHz	QPSK	1 RB / 74 RB Offset
		20050 to 20300	20050, 20300	20 MHz	QPSK	1 RB / 99 RB Offset
-	Occupied Bandwidth	19957 to 20393	19957, 20175, 20393	1.4 MHz	QPSK, 16QAM	6 RB / 0 RB Offset
		19965 to 20385	19965, 20175, 20385	3 MHz	QPSK, 16QAM	15 RB / 0 RB Offset
		19975 to 20375	19975, 20175, 20375	5 MHz	QPSK, 16QAM	25 RB / 0 RB Offset
		20000 to 20350	20000, 20175, 20350	10 MHz	QPSK, 16QAM	50 RB / 0 RB Offset
		20025 to 20325	20025, 20175, 20325	15 MHz	QPSK, 16QAM	75 RB / 0 RB Offset
		20050 to 20300	20050, 20175, 20300	20 MHz	QPSK, 16QAM	100 RB / 0 RB Offset
-	Peak to Average Ratio	19957 to 20393	19957, 20175, 20393	1.4 MHz	QPSK, 16QAM	1 RB / 2 RB Offset
		19965 to 20385	19965, 20175, 20385	3 MHz	QPSK, 16QAM	1 RB / 7 RB Offset
		19975 to 20375	19975, 20175, 20375	5 MHz	QPSK, 16QAM	12 RB / 0 RB Offset
		20000 to 20350	20000, 20175, 20350	10 MHz	QPSK, 16QAM	1 RB / 24 RB Offset
		20025 to 20325	20025, 20175, 20325	15 MHz	QPSK, 16QAM	36 RB / 0 RB Offset
		20050 to 20300	20050, 20175, 20300	20 MHz	QPSK, 16QAM	50 RB / 0 RB Offset

EUT Configure Mode	Test Item	Available Channel	Tested Channel	Channel Bandwidth	Modulation	Mode		
-	Band Edge	19957 to 20393	19957	1.4 MHz	QPSK	1 RB / 0 RB Offset 6 RB / 0 RB Offset		
			20393	1.4 MHz	QPSK	1 RB / 5 RB Offset 6 RB / 0 RB Offset		
		19965 to 20385	19965	3 MHz	QPSK	1 RB / 0 RB Offset 15 RB / 0 RB Offset		
			20385	3 MHz	QPSK	1 RB / 14 RB Offset 15 RB / 0 RB Offset		
		19975 to 20375	19975	5 MHz	QPSK	1 RB / 0 RB Offset 25 RB / 0 RB Offset		
			20375	5 MHz	QPSK	1 RB / 24 RB Offset 25 RB / 0 RB Offset		
		20000 to 20350	20000	10 MHz	QPSK	1 RB / 0 RB Offset 50 RB / 0 RB Offset		
			20350	10 MHz	QPSK	1 RB / 49 RB Offset 50 RB / 0 RB Offset		
		20025 to 20325	20025	15 MHz	QPSK	1 RB / 0 RB Offset 75 RB / 0 RB Offset		
			20325	15 MHz	QPSK	1 RB / 74 RB Offset 75 RB / 0 RB Offset		
		20050 to 20300	20050	20 MHz	QPSK	1 RB / 0 RB Offset 100 RB / 0 RB Offset		
			20300	20 MHz	QPSK	1 RB / 99 RB Offset 100 RB / 0 RB Offset		
		-	Conducted Emission	19957 to 20393	19957, 20175, 20393	1.4 MHz	QPSK	1 RB / 2 RB Offset
				19965 to 20385	19965, 20175, 20385	3 MHz	QPSK	1 RB / 7 RB Offset
				19975 to 20375	19975, 20175, 20375	5 MHz	QPSK	12 RB / 0 RB Offset
				20000 to 20350	20000, 20175, 20350	10 MHz	QPSK	50 RB / 0 RB Offset
				20025 to 20325	20025, 20175, 20325	15 MHz	QPSK	36 RB / 0 RB Offset
				20050 to 20300	20050, 20175, 20300	20 MHz	QPSK	50 RB / 0 RB Offset
-	Radiated Emission	20050 to 20300	20050, 20175, 20300	20 MHz	QPSK	50 RB / 0 RB Offset		

Note: This device was tested under all bandwidths, RB configurations and modulations. The worst case was found in QPSK modulation.

LTE Band 12

EUT Configure Mode	Test Item	Available Channel	Tested Channel	Channel Bandwidth	Modulation	Mode
-	ERP	23017 to 23173	23017, 23095, 23173	1.4 MHz	QPSK, 16QAM	1 RB / 0 RB Offset
		23025 to 23165	23025, 23095, 23165	3 MHz	QPSK, 16QAM	1 RB / 0 RB Offset
		23035 to 23155	23035, 23095, 23155	5 MHz	QPSK, 16QAM	1 RB / 0 RB Offset
		23060 to 23130	23060, 23095, 23130	10 MHz	QPSK, 16QAM	1 RB / 0 RB Offset
-	Modulation Characteristics	23060 to 23130	23095	5 MHz	QPSK, 16QAM	25 RB / 0 RB Offset
-	Frequency Stability	23017 to 23173	23017, 23173	1.4 MHz	QPSK	1 RB / 2 RB Offset
		23025 to 23165	23025, 23165	3 MHz	QPSK	1 RB / 7 RB Offset
		23035 to 23155	23035, 23155	5 MHz	QPSK	1 RB / 12 RB Offset
		23060 to 23130	23060, 23130	10 MHz	QPSK	1 RB / 24 RB Offset
-	Occupied Bandwidth	23017 to 23173	23017, 23095, 23173	1.4 MHz	QPSK, 16QAM	6 RB / 0 RB Offset
		23025 to 23165	23025, 23095, 23165	3 MHz	QPSK, 16QAM	15 RB / 0 RB Offset
		23035 to 23155	23035, 23095, 23155	5 MHz	QPSK, 16QAM	25 RB / 0 RB Offset
		23060 to 23130	23060, 23095, 23130	10 MHz	QPSK, 16QAM	50 RB / 0 RB Offset
-	Peak to Average Ratio	23017 to 23173	23017, 23095, 23173	1.4 MHz	QPSK, 16QAM	1 RB / 0 RB Offset
		23025 to 23165	23025, 23095, 23165	3 MHz	QPSK, 16QAM	1 RB / 0 RB Offset
		23035 to 23155	23035, 23095, 23155	5 MHz	QPSK, 16QAM	1 RB / 0 RB Offset
		23060 to 23130	23060, 23095, 23130	10 MHz	QPSK, 16QAM	1 RB / 0 RB Offset
-	Band Edge	23017 to 23173	23017	1.4 MHz	QPSK	1 RB / 0 RB Offset
			23173	1.4 MHz	QPSK	6 RB / 0 RB Offset
		23025 to 23165	23025	3 MHz	QPSK	1 RB / 5 RB Offset
			23165	3 MHz	QPSK	6 RB / 0 RB Offset
		23035 to 23155	23025	3 MHz	QPSK	1 RB / 0 RB Offset
			23165	3 MHz	QPSK	15 RB / 0 RB Offset
		23035 to 23155	23035	5 MHz	QPSK	1 RB / 14 RB Offset
			23155	5 MHz	QPSK	15 RB / 0 RB Offset
		23060 to 23130	23035	5 MHz	QPSK	1 RB / 0 RB Offset
			23155	5 MHz	QPSK	25 RB / 0 RB Offset
		23060 to 23130	23060	10 MHz	QPSK	1 RB / 24 RB Offset
			23130	10 MHz	QPSK	25 RB / 0 RB Offset
-	Conducted Emission	23017 to 23173	23017, 23095, 23173	1.4 MHz	QPSK	1 RB / 0 RB Offset
		23025 to 23165	23025, 23095, 23165	3 MHz	QPSK	1 RB / 0 RB Offset
		23035 to 23155	23035, 23095, 23155	5 MHz	QPSK	1 RB / 0 RB Offset
		23060 to 23130	23060, 23095, 23130	10 MHz	QPSK	1 RB / 0 RB Offset
-	Radiated Emission	23060 to 23130	23060, 23095, 23130	10 MHz	QPSK	1 RB / 0 RB Offset

Note: This device was tested under all bandwidths, RB configurations and modulations. The worst case was found in QPSK modulation.

LTE Band 13

EUT Configure Mode	Test Item	Available Channel	Tested Channel	Channel Bandwidth	Modulation	Mode
-	ERP	23205 to 23255	23205, 23230, 23255	5 MHz	QPSK, 16QAM	1 RB / 0 RB Offset
		23230	23230	10 MHz	QPSK, 16QAM	1 RB / 0 RB Offset
-	Modulation Characteristics	23230	23230	5 MHz	QPSK, 16QAM	25 RB / 0 RB Offset
-	Frequency Stability	23205 to 23255	23205, 23255	5 MHz	QPSK	1 RB / 0 RB Offset
		23230	23230	10 MHz	QPSK	1 RB / 24 RB Offset
-	Occupied Bandwidth	23205 to 23255	23205, 23230, 23255	5 MHz	QPSK, 16QAM	25 RB / 0 RB Offset
		23230	23230	10 MHz	QPSK, 16QAM	50 RB / 0 RB Offset
-	Peak to Average Ratio	23205 to 23255	23205, 23230, 23255	5 MHz	QPSK, 16QAM	1 RB / 0 RB Offset
		23230	23230	10 MHz	QPSK, 16QAM	1 RB / 0 RB Offset
-	Band Edge	23205 to 23255	23205	5 MHz	QPSK	1 RB / 0 RB Offset
			23255	5 MHz	QPSK	25 RB / 0 RB Offset
		23230	23230	10 MHz	QPSK	1 RB / 24 RB Offset
			23230	10 MHz	QPSK	25 RB / 0 RB Offset
			23230	10 MHz	QPSK	1 RB / 0 RB Offset
			23230	10 MHz	QPSK	50 RB / 0 RB Offset
-	Conducted Emission	23205 to 23255	23205, 23230, 23255	5 MHz	QPSK	1 RB / 0 RB Offset
		23230	23230	10 MHz	QPSK	1 RB / 0 RB Offset
-	Radiated Emission	23230	23230	10 MHz	QPSK	1 RB / 0 RB Offset

Note: This device was tested under all bandwidths, RB configurations and modulations. The worst case was found in QPSK modulation.

LTE Band 17

EUT Configure Mode	Test Item	Available Channel	Tested Channel	Channel Bandwidth	Modulation	Mode
-	ERP	23755 to 23825	23755, 23790, 23825	5 MHz	QPSK, 16QAM	1 RB / 0 RB Offset
		23780 to 23800	23780, 23790, 23800	10 MHz	QPSK, 16QAM	1 RB / 0 RB Offset
-	Modulation Characteristics	23780 to 23800	23790	5 MHz	QPSK, 16QAM	25 RB / 0 RB Offset
-	Frequency Stability	23755 to 23825	23755, 23825	5 MHz	QPSK	1 RB / 12 RB Offset
		23780 to 23800	23780, 23800	10 MHz	QPSK	1 RB / 24 RB Offset
-	Occupied Bandwidth	23755 to 23825	23755, 23790, 23825	5 MHz	QPSK, 16QAM	25 RB / 0 RB Offset
		23780 to 23800	23780, 23790, 23800	10 MHz	QPSK, 16QAM	50 RB / 0 RB Offset
-	Peak to Average Ratio	23755 to 23825	23755, 23790, 23825	5 MHz	QPSK, 16QAM	1 RB / 12 RB Offset
		23780 to 23800	23780, 23790, 23800	10 MHz	QPSK, 16QAM	1 RB / 24 RB Offset
-	Band Edge	23755 to 23825	23755	5 MHz	QPSK	1 RB / 0 RB Offset
			23825	5 MHz	QPSK	25 RB / 0 RB Offset
		23780 to 23800	23780	10 MHz	QPSK	1 RB / 24 RB Offset
			23800	10 MHz	QPSK	25 RB / 0 RB Offset
						1 RB / 0 RB Offset
						50 RB / 0 RB Offset
-	Conducted Emission	23755 to 23825	23755, 23790, 23825	5 MHz	QPSK	1 RB / 12 RB Offset
		23780 to 23800	23780, 23790, 23800	10 MHz	QPSK	1 RB / 24 RB Offset
-	Radiated Emission	23780 to 23800	23780, 23790, 23800	10 MHz	QPSK	1 RB / 24 RB Offset

Note: This device was tested under all bandwidths, RB configurations and modulations. The worst case was found in QPSK modulation.

LTE Band 66

EUT Configure Mode	Test Item	Available Channel	Tested Channel	Channel Bandwidth	Modulation	Mode
-	EIRP	131979 to 132665	131979, 132322, 132665	1.4 MHz	QPSK, 16QAM	1 RB / 0 RB Offset
		131987 to 132657	131987, 132322, 132657	3 MHz	QPSK, 16QAM	1 RB / 0 RB Offset
		131997 to 132647	131997, 132322, 132647	5 MHz	QPSK, 16QAM	1 RB / 0 RB Offset
		132022 to 132622	132022, 132322, 132622	10 MHz	QPSK, 16QAM	1 RB / 0 RB Offset
		132047 to 132597	132047, 132322, 132597	15 MHz	QPSK, 16QAM	1 RB / 0 RB Offset
		132072 to 132572	132072, 132322, 132572	20 MHz	QPSK, 16QAM	1 RB / 0 RB Offset
-	Modulation Characteristics	132072 to 132572	132322	5 MHz	QPSK, 16QAM	25 RB / 0 RB Offset
-	Frequency Stability	131979 to 132665	131979, 132665	1.4 MHz	QPSK	1 RB / 5 RB Offset
		131987 to 132657	131987, 132657	3 MHz	QPSK	1 RB / 14 RB Offset
		131997 to 132647	131997, 132647	5 MHz	QPSK	1 RB / 24 RB Offset
		132022 to 132622	132022, 132622	10 MHz	QPSK	1 RB / 49 RB Offset
		132047 to 132597	132047, 132597	15 MHz	QPSK	1 RB / 74 RB Offset
		132072 to 132572	132072, 132572	20 MHz	QPSK	1 RB / 99 RB Offset
-	Occupied Bandwidth	131979 to 132665	131979, 132322, 132665	1.4 MHz	QPSK, 16QAM	6 RB / 0 RB Offset
		131987 to 132657	131987, 132322, 132657	3 MHz	QPSK, 16QAM	15 RB / 0 RB Offset
		131997 to 132647	131997, 132322, 132647	5 MHz	QPSK, 16QAM	25 RB / 0 RB Offset
		132022 to 132622	132022, 132322, 132622	10 MHz	QPSK, 16QAM	50 RB / 0 RB Offset
		132047 to 132597	132047, 132322, 132597	15 MHz	QPSK, 16QAM	75 RB / 0 RB Offset
		132072 to 132572	132072, 132322, 132572	20 MHz	QPSK, 16QAM	100 RB / 0 RB Offset
-	Peak to Average Ratio	131979 to 132665	131979, 132322, 132665	1.4 MHz	QPSK, 16QAM	1 RB / 2 RB Offset
		131987 to 132657	131987, 132322, 132657	3 MHz	QPSK, 16QAM	1 RB / 7 RB Offset
		131997 to 132647	131997, 132322, 132647	5 MHz	QPSK, 16QAM	12 RB / 0 RB Offset
		132022 to 132622	132022, 132322, 132622	10 MHz	QPSK, 16QAM	1 RB / 24 RB Offset
		132047 to 132597	132047, 132322, 132597	15 MHz	QPSK, 16QAM	36 RB / 0 RB Offset
		132072 to 132572	132072, 132322, 132572	20 MHz	QPSK, 16QAM	50 RB / 0 RB Offset

EUT Configure Mode	Test Item	Available Channel	Tested Channel	Channel Bandwidth	Modulation	Mode		
-	Band Edge	131979 to 132665	131979	1.4 MHz	QPSK	1 RB / 0 RB Offset 6 RB / 0 RB Offset		
			132665	1.4 MHz	QPSK	1 RB / 5 RB Offset 6 RB / 0 RB Offset		
		131987 to 132657	131987	3 MHz	QPSK	1 RB / 0 RB Offset 15 RB / 0 RB Offset		
			132657	3 MHz	QPSK	1 RB / 14 RB Offset 15 RB / 0 RB Offset		
		131997 to 132647	131997	5 MHz	QPSK	1 RB / 0 RB Offset 25 RB / 0 RB Offset		
			132647	5 MHz	QPSK	1 RB / 24 RB Offset 25 RB / 0 RB Offset		
		132022 to 132622	132022	10 MHz	QPSK	1 RB / 0 RB Offset 50 RB / 0 RB Offset		
			132622	10 MHz	QPSK	1 RB / 49 RB Offset 50 RB / 0 RB Offset		
		132047 to 132597	132047	15 MHz	QPSK	1 RB / 0 RB Offset 75 RB / 0 RB Offset		
			132597	15 MHz	QPSK	1 RB / 74 RB Offset 75 RB / 0 RB Offset		
		132072 to 132572	132072	20 MHz	QPSK	1 RB / 0 RB Offset 100 RB / 0 RB Offset		
			132572	20 MHz	QPSK	1 RB / 99 RB Offset 100 RB / 0 RB Offset		
		-	Conducted Emission	131979 to 132665	131979, 132322, 132665	1.4 MHz	QPSK	1 RB / 2 RB Offset
				131987 to 132657	131987, 132322, 132657	3 MHz	QPSK	1 RB / 7 RB Offset
				131997 to 132647	131997, 132322, 132647	5 MHz	QPSK	12 RB / 0 RB Offset
				132022 to 132622	132022, 132322, 132622	10 MHz	QPSK	50 RB / 0 RB Offset
				132047 to 132597	132047, 132322, 132597	15 MHz	QPSK	36 RB / 0 RB Offset
				132072 to 132572	132072, 132322, 132572	20 MHz	QPSK	50 RB / 0 RB Offset
-	Radiated Emission	132072 to 132572	132072, 132322, 132572	20 MHz	QPSK	50 RB / 0 RB Offset		

Test Condition:

Test Item	Environmental Conditions	Input Power	Tested By
ERP / EIRP	25 deg. C, 65 % RH	3.3 Vdc	Getaz Yang
Modulation Characteristics	25 deg. C, 65 % RH	3.3 Vdc	Getaz Yang
Frequency Stability	25 deg. C, 65 % RH	3.3 Vdc	Getaz Yang
Occupied Bandwidth	25 deg. C, 65 % RH	3.3 Vdc	Getaz Yang
Band Edge	25 deg. C, 65 % RH	3.3 Vdc	Getaz Yang
Peak to Average Ratio	25 deg. C, 65 % RH	3.3 Vdc	Getaz Yang
Conducted Emission	25 deg. C, 65 % RH	3.3 Vdc	Getaz Yang
Radiated Emission	25 deg. C, 65 % RH	120 Vac, 60 Hz	Thomas Wei Jisyong Wang

3.4 EUT Operating Conditions

The EUT makes a call to the communication simulator. The communication simulator station system controlled a EUT to export maximum output power under transmission mode and specific channel frequency

3.5 General Description of Applied Standards

The EUT is a RF Product. According to the specifications of the manufacturer, it must comply with the requirements of the following standards:

FCC 47 CFR Part 2

FCC 47 CFR Part 27

KDB 971168 D01 Power Meas License Digital Systems v03r01

ANSI/TIA/EIA-603-E 2016

ANSI 63.26-2015

Note: All test items have been performed and recorded as per the above standards.

4 Test Types and Results

4.1 Output Power Measurement

4.1.1 Limits of Output Power Measurement

Fixed, mobile, and portable (hand-held) stations operating in the 1710–1755 MHz band are limited to 1 watt EIRP.

Portable stations (hand-held devices) operating in the 704-716 MHz band are limited to 3 watts ERP

4.1.2 Test Procedures

Conducted Power Measurement:

- a. The EUT was set up for the maximum power with LTE link data modulation and link up with simulator.
- b. Set the EUT to transmit under low, middle and high channel and record the power level shown on simulator.

EIRP / ERP Measurement:

- a. $EIRP = \text{Conducted Output power level} + \text{Antenna gain}$.
- b. ERP power can be calculated from EIRP power by subtracting the gain of dipole, $ERP \text{ power} = EIPR \text{ power} - 2.15dBi$.
- c. $ERP = \text{Conducted Output power level} + \text{Antenna gain (dBi)} - \text{Isotropically Factor (2.15dB)}$

4.1.3 Test Setup

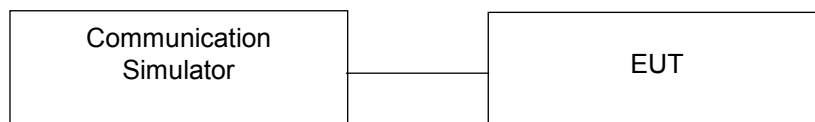

4.1.4 Test Results

Conducted Output Power (dBm)

Band	WCDMA IV		
	Channel	1312	1413
Frequency (MHz)	1712.4	1732.6	1752.6
RMC 12.2K	24.11	24.14	24.34
HSDPA Subtest-1	22.09	22.06	22.23
HSDPA Subtest-2	22.96	23.07	23.20
HSDPA Subtest-3	22.06	22.11	22.23
HSDPA Subtest-4	23.98	23.99	24.23
HSUPA Subtest-1	19.21	19.22	19.41
HSUPA Subtest-2	19.14	19.16	19.37
HSUPA Subtest-3	18.98	18.95	19.22
HSUPA Subtest-4	18.93	18.94	19.20
HSUPA Subtest-5	19.00	18.99	19.29

Band / BW	RB Size	RB Offset	QPSK			3GPP MPR (dB)	16QAM			3GPP MPR (dB)
			Low Ch 19957	Mid Ch 20175	High Ch 20393		Low Ch 19957	Mid Ch 20175	High Ch 20393	
			1710.7 MHz	1732.5 MHz	1754.3 MHz		1710.7 MHz	1732.5 MHz	1754.3 MHz	
4 / 1.4M	1	0	22.86	22.56	22.63	0	21.70	21.56	21.52	1
	1	2	22.74	22.53	22.40	0	21.57	21.33	21.40	1
	1	5	22.53	22.32	22.26	0	21.57	21.22	21.28	1
	3	0	21.74	21.49	21.50	0	20.64	20.39	20.40	1
	3	1	21.55	21.35	21.18	0	20.55	20.23	20.17	1
	3	3	21.44	21.26	21.11	0	20.44	20.07	20.14	1
	6	0	21.62	21.50	21.39	1	20.53	20.39	20.48	2

Band / BW	RB Size	RB Offset	QPSK			3GPP MPR (dB)	16QAM			3GPP MPR (dB)
			Low Ch 19965	Mid Ch 20175	High Ch 20385		Low Ch 19965	Mid Ch 20175	High Ch 20385	
			1711.5 MHz	1732.5 MHz	1753.5 MHz		1711.5 MHz	1732.5 MHz	1753.5 MHz	
4 / 3M	1	0	22.90	22.68	22.66	0	21.77	21.30	21.33	1
	1	7	22.79	22.51	22.57	0	21.65	21.47	21.38	1
	1	14	22.54	22.34	22.49	0	21.55	21.36	21.35	1
	8	0	21.76	21.52	21.55	1	20.58	20.35	20.39	2
	8	3	21.59	21.34	21.34	1	20.51	20.30	20.27	2
	8	7	21.50	21.31	21.19	1	20.47	20.15	20.15	2
	15	0	21.75	21.47	21.51	1	20.64	20.46	20.47	2

Band / BW	RB Size	RB Offset	QPSK			3GPP MPR (dB)	16QAM			3GPP MPR (dB)
			Low Ch 19975	Mid Ch 20175	High Ch 20375		Low CH 19975	Mid CH 20175	High CH 20375	
			1712.5 MHz	1732.5 MHz	1752.5 MHz		1712.5 MHz	1732.5 MHz	1752.5 MHz	
4 / 5M	1	0	22.91	22.69	22.74	0	21.71	21.45	21.48	1
	1	12	22.77	22.58	22.64	0	21.66	21.60	21.51	1
	1	24	22.60	22.41	22.50	0	21.65	21.36	21.31	1
	12	0	21.77	21.58	21.50	1	20.62	20.44	20.53	2
	12	6	21.53	21.39	21.42	1	20.55	20.24	20.40	2
	12	13	21.57	21.28	21.31	1	20.54	20.06	20.33	2
	25	0	21.73	21.60	21.57	1	20.80	20.42	20.45	2

Band / BW	RB Size	RB Offset	QPSK			3GPP MPR (dB)	16QAM			3GPP MPR (dB)
			Low Ch 20000	Mid Ch 20175	High Ch 20350		Low Ch 20000	Mid Ch 20175	High Ch 20350	
			1715.0 MHz	1732.5 MHz	1750.0 MHz		1715.0 MHz	1732.5 MHz	1750.0 MHz	
4 / 10M	1	0	23.02	22.74	22.74	0	21.86	21.48	21.63	1
	1	24	22.93	22.60	22.65	0	21.84	21.56	21.66	1
	1	49	22.70	22.44	22.47	0	21.78	21.45	21.36	1
	25	0	21.91	21.64	21.68	1	20.79	20.55	20.62	2
	25	12	21.74	21.42	21.48	1	20.71	20.36	20.40	2
	25	25	21.59	21.42	21.43	1	20.54	20.20	20.37	2
	50	0	21.86	21.61	21.71	1	20.83	20.63	20.66	2

Band / BW	RB Size	RB Offset	QPSK			3GPP MPR (dB)	16QAM			3GPP MPR (dB)
			Low Ch 20025	Mid Ch 20175	High Ch 20325		Low Ch 20025	Mid Ch 20175	High Ch 20325	
			1717.5 MHz	1732.5 MHz	1747.5 MHz		1717.5 MHz	1732.5 MHz	1747.5 MHz	
4 / 15M	1	0	23.05	22.78	22.84	0	21.95	21.66	21.73	1
	1	37	22.92	22.67	22.71	0	21.91	21.63	21.68	1
	1	74	22.84	22.46	22.48	0	21.82	21.46	21.52	1
	36	0	21.92	21.67	21.68	1	20.91	20.45	20.54	2
	36	19	21.75	21.41	21.47	1	20.67	20.42	20.50	2
	36	39	21.61	21.41	21.43	1	20.65	20.40	20.42	2
	75	0	21.85	21.65	21.66	1	20.83	20.49	20.62	2

Band / BW	RB Size	RB Offset	QPSK			3GPP MPR (dB)	16QAM			3GPP MPR (dB)
			Low Ch 20050	Mid Ch 20175	High Ch 20300		Low Ch 20050	Mid Ch 20175	High Ch 20300	
			1720.0 MHz	1732.5 MHz	1745.0 MHz		1720.0 MHz	1732.5 MHz	1745.0 MHz	
4 / 20M	1	0	23.11	22.85	22.89	0	22.06	21.77	21.83	1
	1	50	22.97	22.74	22.80	0	21.93	21.72	21.74	1
	1	99	22.89	22.56	22.52	0	21.75	21.53	21.57	1
	50	0	21.98	21.72	21.76	1	20.95	20.59	20.63	2
	50	25	21.79	21.51	21.55	1	20.77	20.47	20.48	2
	50	50	21.68	21.40	21.53	1	20.68	20.31	20.43	2
	100	0	21.97	21.74	21.68	1	20.91	20.64	20.67	2

Band / BW	RB Size	RB Offset	QPSK			3GPP MPR (dB)	16QAM			3GPP MPR (dB)
			Low Ch 23017	Mid Ch 23095	High Ch 23173		Low Ch 23017	Mid Ch 23095	High Ch 23173	
			699.7 MHz	707.5 MHz	715.3 MHz		699.7 MHz	707.5 MHz	715.3 MHz	
12 / 1.4M	1	0	22.60	22.85	22.77	0	21.57	21.78	21.70	1
	1	2	22.45	22.64	22.54	0	21.44	21.58	21.52	1
	1	5	22.25	22.58	22.41	0	21.27	21.49	21.26	1
	3	0	21.43	21.65	21.57	0	20.47	20.73	20.53	1
	3	1	21.31	21.50	21.41	0	20.17	20.42	20.35	1
	3	3	21.14	21.40	21.35	0	20.12	20.33	20.16	1
	6	0	21.39	21.71	21.65	1	20.44	20.59	20.65	2

Band / BW	RB Size	RB Offset	QPSK			3GPP MPR (dB)	16QAM			3GPP MPR (dB)
			Low Ch 23025	Mid Ch 23095	High Ch 23165		Low Ch 23025	Mid Ch 23095	High Ch 23165	
			700.5 MHz	707.5 MHz	714.5 MHz		700.5 MHz	707.5 MHz	714.5 MHz	
12 / 3M	1	0	22.62	22.83	22.77	0	21.32	21.70	21.47	1
	1	7	22.47	22.75	22.65	0	21.49	21.53	21.66	1
	1	14	22.32	22.69	22.49	0	21.26	21.47	21.57	1
	8	0	21.52	21.76	21.58	1	20.26	20.60	20.64	2
	8	3	21.31	21.59	21.46	1	20.29	20.48	20.47	2
	8	7	21.20	21.52	21.40	1	20.16	20.37	20.34	2
	15	0	21.47	21.72	21.64	1	20.54	20.67	20.59	2

Band / BW	RB Size	RB Offset	QPSK			3GPP MPR (dB)	16QAM			3GPP MPR (dB)
			Low Ch 23035	Mid Ch 23095	High Ch 23155		Low Ch 23035	Mid Ch 23095	High Ch 23155	
			701.5 MHz	707.5 MHz	713.5 MHz		701.5 MHz	707.5 MHz	713.5 MHz	
12 / 5M	1	0	22.63	22.92	22.85	0	21.40	21.73	21.58	1
	1	12	22.56	22.76	22.70	0	21.48	21.71	21.64	1
	1	24	22.40	22.60	22.62	0	21.40	21.53	21.51	1
	12	0	21.57	21.76	21.74	1	20.39	20.70	20.52	2
	12	6	21.38	21.56	21.55	1	20.33	20.55	20.44	2
	12	13	21.28	21.51	21.42	1	20.24	20.52	20.37	2
	25	0	21.55	21.76	21.71	1	20.54	20.76	20.74	2

Band / BW	RB Size	RB Offset	QPSK			3GPP MPR (dB)	16QAM			3GPP MPR (dB)
			Low Ch 23060	Mid Ch 23095	High Ch 23130		Low Ch 23060	Mid Ch 23095	High Ch 23130	
			704.0 MHz	707.5 MHz	711.0 MHz		704.0 MHz	707.5 MHz	711.0 MHz	
12 / 10M	1	0	22.72	22.97	22.88	0	21.51	21.82	21.77	1
	1	24	22.59	22.83	22.79	0	21.55	21.81	21.76	1
	1	49	22.54	22.77	22.71	0	21.45	21.70	21.58	1
	25	0	21.60	21.85	21.81	1	20.56	20.75	20.63	2
	25	12	21.39	21.60	21.65	1	20.34	20.64	20.55	2
	25	25	21.27	21.58	21.45	1	20.34	20.42	20.37	2
	50	0	21.61	21.78	21.74	1	20.54	20.79	20.68	2

Band / BW	RB Size	RB Offset	QPSK			3GPP MPR (dB)	16QAM			3GPP MPR (dB)
			Low Ch 23205	Mid Ch 23230	High Ch 23255		Low Ch 23205	Mid Ch 23230	High Ch 23255	
			779.5 MHz	782.0 MHz	784.5 MHz		779.5 MHz	782.0 MHz	784.5 MHz	
13 / 5M	1	0	23.17	23.12	23.08	0	22.08	22.10	22.00	1
	1	12	23.07	22.97	22.99	0	21.98	21.99	21.88	1
	1	24	22.79	22.75	22.85	0	21.82	21.74	21.75	1
	12	0	22.01	21.98	21.93	1	20.99	20.92	20.74	2
	12	6	21.81	21.80	21.75	1	20.83	20.74	20.72	2
	12	13	21.78	21.70	21.66	1	20.72	20.64	20.66	2
	25	0	21.99	21.99	21.97	1	21.00	20.89	20.96	2

Band / BW	RB Size	RB Offset	QPSK		3GPP MPR (dB)	16QAM		3GPP MPR (dB)
			Mid Ch 23230	782.0 MHz		Mid Ch 23230	782.0 MHz	
			782.0 MHz	782.0 MHz				
13 / 10M	1	0	23.18	22.15	0	22.15	1	
	1	24	23.06	21.95	0	21.95	1	
	1	49	22.93	21.81	0	21.81	1	
	25	0	22.04	20.92	1	20.92	2	
	25	12	21.87	20.77	1	20.77	2	
	25	25	21.71	20.81	1	20.81	2	
	50	0	22.00	21.01	1	21.01	2	

Band / BW	RB Size	RB Offset	QPSK			3GPP MPR (dB)	16QAM			3GPP MPR (dB)
			Low Ch 23755	Mid Ch 23790	High Ch 23825		Low Ch 23755	Mid Ch 23790	High Ch 23825	
			706.5 MHz	710.0 MHz	713.5 MHz		706.5 MHz	710.0 MHz	713.5 MHz	
17 / 5M	1	0	22.98	22.94	23.03	0	21.89	21.82	21.90	1
	1	12	22.83	22.81	22.91	0	21.79	21.74	21.82	1
	1	24	22.61	22.59	22.81	0	21.59	21.54	21.76	1
	12	0	21.82	21.88	21.91	1	20.65	20.77	20.81	2
	12	6	21.68	21.63	21.74	1	20.62	20.54	20.61	2
	12	13	21.56	21.64	21.60	1	20.61	20.60	20.53	2
	25	0	21.76	21.83	21.79	1	20.84	20.81	20.84	2

Band / BW	RB Size	RB Offset	QPSK			3GPP MPR (dB)	16QAM			3GPP MPR (dB)
			Low Ch 23780	Mid Ch 23790	High Ch 23800		Low Ch 23780	Mid Ch 23790	High Ch 23800	
			709.0 MHz	710.0 MHz	711.0 MHz		709.0 MHz	710.0 MHz	711.0 MHz	
17 / 10M	1	0	23.02	23.01	23.08	0	21.93	22.00	22.06	1
	1	24	22.91	22.89	22.99	0	21.89	21.90	21.84	1
	1	49	22.69	22.77	22.72	0	21.59	21.78	21.73	1
	25	0	21.88	21.89	21.98	1	20.76	20.75	20.92	2
	25	12	21.66	21.69	21.79	1	20.61	20.58	20.75	2
	25	25	21.65	21.55	21.69	1	20.50	20.50	20.66	2
	50	0	21.84	21.83	21.95	1	20.78	20.81	20.93	2

Band / BW	RB Size	RB Offset	QPSK			3GPP MPR (dB)	16QAM			3GPP MPR (dB)
			Low Ch 131979	Mid Ch 132322	High Ch 132665		Low Ch 131979	Mid Ch 132322	High Ch 132665	
			1710.7 MHz	1745.0 MHz	1779.3 MHz		1710.7 MHz	1745.0 MHz	1779.3 MHz	
66 / 1.4M	1	0	22.92	23.07	23.03	0	21.94	21.97	21.92	1
	1	2	22.92	23.01	22.91	0	21.85	21.92	21.85	1
	1	5	22.57	22.79	22.67	0	21.65	21.80	21.60	1
	3	0	21.87	21.93	21.95	0	20.86	20.81	20.82	1
	3	1	21.60	21.74	21.70	0	20.64	20.70	20.62	1
	3	3	21.58	21.69	21.70	0	20.56	20.59	20.50	1
	6	0	21.88	21.99	21.78	1	20.81	20.88	20.71	2

Band / BW	RB Size	RB Offset	QPSK			3GPP MPR (dB)	16QAM			3GPP MPR (dB)
			Low Ch 131987	Mid Ch 132322	High Ch 132657		Low Ch 131987	Mid Ch 132322	High Ch 132657	
			1711.5 MHz	1745.5 MHz	1778.5 MHz		1711.5 MHz	1745.5 MHz	1778.5 MHz	
66 / 3M	1	0	23.06	23.17	23.11	0	21.95	21.84	21.77	1
	1	7	22.97	22.97	22.99	0	21.71	21.90	21.93	1
	1	14	22.70	22.89	22.78	0	21.61	21.80	21.71	1
	8	0	21.90	21.97	21.93	1	20.83	20.99	20.88	2
	8	3	21.72	21.75	21.80	1	20.62	20.79	20.75	2
	8	7	21.68	21.67	21.63	1	20.67	20.73	20.63	2
	15	0	21.99	21.97	21.95	1	20.86	21.04	20.72	2

Band / BW	RB Size	RB Offset	QPSK			3GPP MPR (dB)	16QAM			3GPP MPR (dB)
			Low Ch 131997	Mid Ch 132322	High Ch 132647		Low Ch 131997	Mid Ch 132322	High Ch 132647	
			1712.5 MHz	1745.0 MHz	1777.5 MHz		1712.5 MHz	1745.0 MHz	1777.5 MHz	
66 / 5M	1	0	23.10	23.18	23.13	0	21.87	22.09	21.88	1
	1	12	23.01	23.01	22.94	0	21.85	22.08	22.03	1
	1	24	22.81	22.93	22.84	0	21.61	21.82	21.73	1
	12	0	22.00	22.11	21.95	1	20.84	20.95	20.95	2
	12	6	21.78	21.89	21.79	1	20.80	20.80	20.77	2
	12	13	21.76	21.83	21.72	1	20.58	20.65	20.67	2
	25	0	21.99	22.03	21.88	1	20.87	21.03	20.90	2

Band / BW	RB Size	RB Offset	QPSK			3GPP MPR (dB)	16QAM			3GPP MPR (dB)
			Low Ch 132022	Mid Ch 132322	High Ch 132622		Low Ch 132022	Mid Ch 132322	High Ch 132622	
			1715.0 MHz	1745.0 MHz	1775.0 MHz		1715.0 MHz	1745.0 MHz	1775.0 MHz	
66 / 10M	1	0	23.14	23.26	23.16	0	21.98	22.08	21.95	1
	1	24	23.01	23.09	23.10	0	21.94	22.07	22.06	1
	1	49	22.91	22.99	22.81	0	21.83	21.98	21.82	1
	25	0	22.06	22.17	22.06	1	20.90	21.16	20.92	2
	25	12	21.82	21.96	21.91	1	20.81	20.88	20.76	2
	25	25	21.71	21.81	21.77	1	20.69	20.78	20.83	2
	50	0	22.00	22.10	22.05	1	20.93	21.08	20.98	2

Band / BW	RB Size	RB Offset	QPSK			3GPP MPR (dB)	16QAM			3GPP MPR (dB)
			Low Ch 132047	Mid Ch 132322	High Ch 132597		Low Ch 132047	Mid Ch 132322	High Ch 132597	
			1717.5 MHz	1745.0 MHz	1772.5 MHz		1717.5 MHz	1745.0 MHz	1772.5 MHz	
66 / 15M	1	0	23.21	23.34	23.21	0	22.12	22.24	22.11	1
	1	37	23.11	23.15	23.10	0	22.01	22.16	22.04	1
	1	74	22.88	22.95	23.01	0	21.91	22.01	21.78	1
	36	0	22.03	22.19	22.13	1	20.95	21.13	21.03	2
	36	19	21.84	22.03	21.93	1	20.88	20.98	20.93	2
	36	39	21.80	21.94	21.88	1	20.78	20.83	20.77	2
	75	0	22.07	22.21	22.01	1	21.01	21.10	21.04	2

Band / BW	RB Size	RB Offset	QPSK			3GPP MPR (dB)	16QAM			3GPP MPR (dB)
			Low Ch 132072	Mid Ch 132322	High Ch 132572		Low Ch 132072	Mid Ch 132322	High Ch 132572	
			1720.0 MHz	1745.0 MHz	1770.0 MHz		1720.0 MHz	1745.0 MHz	1770.0 MHz	
66 / 20M	1	0	23.26	23.37	23.29	0	22.24	22.31	22.25	1
	1	50	23.11	23.25	23.13	0	22.05	22.17	22.10	1
	1	99	22.96	23.16	23.01	0	21.79	21.93	21.97	1
	50	0	22.17	22.26	22.15	1	21.10	21.22	20.98	2
	50	25	21.95	22.09	21.93	1	20.84	20.98	20.85	2
	50	50	21.83	21.92	21.84	1	20.80	20.99	20.80	2
	100	0	22.05	22.22	22.07	1	21.00	21.25	21.04	2

ERP Power (dBm)

Note: ERP (dBm) = Max. Conducted Power (dBm) + Gain (dBi) – 2.15

Band 12 / 1.4M, 1RB#0						
Test Mode	QPSK			16QAM		
	Low Ch 23017	Mid Ch 23095	High Ch 23173	Low Ch 23017	Mid Ch 23095	High Ch 23173
	699.7 MHz	707.5 MHz	715.3 MHz	699.7 MHz	707.5 MHz	715.3 MHz
Max. Cond. Power (dBm)	22.60	22.85	22.77	21.57	21.78	21.70
Max. ERP Power (dBm)	23.45	23.70	23.62	22.42	22.63	22.55
Max. ERP Power (mW)	221.31	234.42	230.14	174.58	183.23	179.89

Band 12 / 3M, 1RB#0						
Test Mode	QPSK			16QAM		
	Low Ch 23025	Mid Ch 23095	High Ch 23165	Low Ch 23025	Mid Ch 23095	High Ch 23165
	700.5 MHz	707.5 MHz	714.5 MHz	700.5 MHz	707.5 MHz	714.5 MHz
Max. Cond. Power (dBm)	22.62	22.83	22.77	21.32	21.70	21.47
Max. ERP Power (dBm)	23.47	23.68	23.62	22.17	22.55	22.32
Max. ERP Power (mW)	222.33	233.35	230.14	164.82	179.89	170.61

Band 12 / 5M, 1RB#0						
Test Mode	QPSK			16QAM		
	Low Ch 23035	Mid Ch 23095	High Ch 23155	Low Ch 23035	Mid Ch 23095	High Ch 23155
	701.5 MHz	707.5 MHz	713.5 MHz	701.5 MHz	707.5 MHz	713.5 MHz
Max. Cond. Power (dBm)	22.63	22.92	22.85	21.40	21.73	21.58
Max. ERP Power (dBm)	23.48	23.77	23.70	22.25	22.58	22.43
Max. ERP Power (mW)	222.84	238.23	234.42	167.88	181.13	174.98

Band 12 / 10M, 1RB#0						
Test Mode	QPSK			16QAM		
	Low Ch 23060	Mid Ch 23095	High Ch 23130	Low Ch 23060	Mid Ch 23095	High Ch 23130
	704.0 MHz	707.5 MHz	711.0 MHz	704.0 MHz	707.5 MHz	711.0 MHz
Max. Cond. Power (dBm)	22.72	22.97	22.88	21.51	21.82	21.77
Max. ERP Power (dBm)	23.57	23.82	23.73	22.36	22.67	22.62
Max. ERP Power (mW)	227.51	240.99	236.05	172.19	184.93	182.81

Band 13 / 5M, 1RB#0						
Test Mode	QPSK			16QAM		
	Low Ch 23205	Mid Ch 23230	High Ch 23255	Low Ch 23205	Mid Ch 23230	High Ch 23255
	779.5 MHz	782.0 MHz	784.5 MHz	779.5 MHz	782.0 MHz	784.5 MHz
Max. Cond. Power (dBm)	23.17	23.12	23.08	22.08	22.10	22.00
Max. ERP Power (dBm)	24.02	23.97	23.93	22.93	22.95	22.85
Max. ERP Power (mW)	252.35	249.46	247.17	196.34	197.24	192.75

Band 13 / 10M, 1RB#0						
Test Mode	QPSK			16QAM		
		Mid Ch 23230			Mid Ch 23230	
		782.0 MHz			782.0 MHz	
Max. Cond. Power (dBm)		23.18			22.15	
Max. ERP Power (dBm)		24.03			23.00	
Max. ERP Power (mW)		252.93			199.53	

Band 17 / 5M, 1RB#0						
Test Mode	QPSK			16QAM		
	Low Ch 23755	Mid Ch 23790	High Ch 23825	Low Ch 23755	Mid Ch 23790	High Ch 23825
	706.5 MHz	710.0 MHz	713.5 MHz	706.5 MHz	710.0 MHz	713.5 MHz
Max. Cond. Power (dBm)	22.98	22.94	23.03	21.89	21.82	21.90
Max. ERP Power (dBm)	23.83	23.79	23.88	22.74	22.67	22.75
Max. ERP Power (mW)	241.55	239.33	244.34	187.93	184.93	188.36

Band 17 / 10M, 1RB#0						
Test Mode	QPSK			16QAM		
	Low Ch 23780	Mid Ch 23790	High Ch 23800	Low Ch 23780	Mid Ch 23790	High Ch 23800
	709.0 MHz	710.0 MHz	711.0 MHz	709.0 MHz	710.0 MHz	711.0 MHz
Max. Cond. Power (dBm)	23.02	23.01	23.08	21.93	22.00	22.06
Max. ERP Power (dBm)	23.87	23.86	23.93	22.78	22.85	22.91
Max. ERP Power (mW)	243.78	243.22	247.17	189.67	192.75	195.43

EIRP Power (dBm)

Note: EIRP (dBm) = Max. Conducted Power (dBm) + Gain (dBi)

Band	WCDMA IV		
	RMC 12.2K		
Channel	1312	1413	1513
Frequency (MHz)	1712.4	1732.6	1752.6
Max. Cond. Power (dBm)	24.11	24.14	24.34
Max. EIRP Power (dBm)	29.11	29.14	29.34
Max. EIRP Power (mW)	814.70	820.35	859.01

Band 4 / 1.4M, 1RB#0

Test Mode	QPSK			16QAM		
	Low Ch 19957	Mid Ch 20175	High Ch 20393	Low Ch 19957	Mid Ch 20175	High Ch 20393
	1710.7 MHz	1732.5 MHz	1754.3 MHz	1710.7 MHz	1732.5 MHz	1754.3 MHz
Max. Cond. Power (dBm)	22.86	22.56	22.63	21.70	21.56	21.52
Max. EIRP Power (dBm)	27.86	27.56	27.63	26.70	26.56	26.52
Max. EIRP Power (mW)	610.94	570.16	579.43	467.74	452.90	448.75

Band 4 / 3M, 1RB#0

Test Mode	QPSK			16QAM		
	Low Ch 19965	Mid Ch 20175	High Ch 20385	Low Ch 19965	Mid Ch 20175	High Ch 20385
	1711.5 MHz	1732.5 MHz	1753.5 MHz	1711.5 MHz	1732.5 MHz	1753.5 MHz
Max. Cond. Power (dBm)	22.90	22.68	22.66	21.77	21.30	21.33
Max. EIRP Power (dBm)	27.90	27.68	27.66	26.77	26.30	26.33
Max. EIRP Power (mW)	616.60	586.14	583.45	475.34	426.58	429.54

Band 4 / 5M, 1RB#0

Test Mode	QPSK			16QAM		
	Low Ch 19975	Mid Ch 20175	High Ch 20375	Low Ch 19975	Mid Ch 20175	High Ch 20375
	1712.5 MHz	1732.5 MHz	1752.5 MHz	1712.5 MHz	1732.5 MHz	1752.5 MHz
Max. Cond. Power (dBm)	22.91	22.69	22.74	21.71	21.45	21.48
Max. EIRP Power (dBm)	27.91	27.69	27.74	26.71	26.45	26.48
Max. EIRP Power (mW)	618.02	587.49	594.29	468.81	441.57	444.63

Band 4 / 10M, 1RB#0

Test Mode	QPSK			16QAM		
	Low Ch 20000	Mid Ch 20175	High Ch 20350	Low Ch 20000	Mid Ch 20175	High Ch 20350
	1715.0 MHz	1732.5 MHz	1750.0 MHz	1715.0 MHz	1732.5 MHz	1750.0 MHz
Max. Cond. Power (dBm)	23.02	22.74	22.74	21.86	21.48	21.63
Max. EIRP Power (dBm)	28.02	27.74	27.74	26.86	26.48	26.63
Max. EIRP Power (mW)	633.87	594.29	594.29	485.29	444.63	460.26

Band 4 / 15M, 1RB#0

Test Mode	QPSK			16QAM		
	Low Ch 20025	Mid Ch 20175	High Ch 20325	Low Ch 20025	Mid Ch 20175	High Ch 20325
	1717.5 MHz	1732.5 MHz	1747.5 MHz	1717.5 MHz	1732.5 MHz	1747.5 MHz
Max. Cond. Power (dBm)	23.05	22.78	22.84	21.95	21.66	21.73
Max. EIRP Power (dBm)	28.05	27.78	27.84	26.95	26.66	26.73
Max. EIRP Power (mW)	638.26	599.79	608.14	495.45	463.45	470.98

Band 4 / 20M, 1RB#0

Test Mode	QPSK			16QAM		
	Low Ch 20050	Mid Ch 20175	High Ch 20300	Low Ch 20050	Mid Ch 20175	High Ch 20300
	1720.0 MHz	1732.5 MHz	1745.0 MHz	1720.0 MHz	1732.5 MHz	1745.0 MHz
Max. Cond. Power (dBm)	23.11	22.85	22.89	22.06	21.77	21.83
Max. EIRP Power (dBm)	28.11	27.85	27.89	27.06	26.77	26.83
Max. EIRP Power (mW)	647.14	609.54	615.18	508.16	475.34	481.95

Band 66 / 1.4M, 1RB#0

Test Mode	QPSK			16QAM		
	Low Ch 131979	Mid Ch 132322	High Ch 132665	Low Ch 131979	Mid Ch 132322	High Ch 132665
	1710.7 MHz	1745.0 MHz	1779.3 MHz	1710.7 MHz	1745.0 MHz	1779.3 MHz
Max. Cond. Power (dBm)	22.92	23.07	23.03	21.94	21.97	21.92
Max. EIRP Power (dBm)	27.92	28.07	28.03	26.94	26.97	26.92
Max. EIRP Power (mW)	619.44	641.21	635.33	494.31	497.74	492.04

Band 66 / 3M, 1RB#0

Test Mode	QPSK			16QAM		
	Low Ch 131987	Mid Ch 132322	High Ch 132657	Low Ch 131987	Mid Ch 132322	High Ch 132657
	1711.5 MHz	1745.5 MHz	1778.5 MHz	1711.5 MHz	1745.5 MHz	1778.5 MHz
Max. Cond. Power (dBm)	23.06	23.17	23.11	21.95	21.84	21.77
Max. EIRP Power (dBm)	28.06	28.17	28.11	26.95	26.84	26.77
Max. EIRP Power (mW)	639.73	656.15	647.14	495.45	483.06	475.34

Band 66 / 5M, 1RB#0

Test Mode	QPSK			16QAM		
	Low Ch 131997	Mid Ch 132322	High Ch 132647	Low Ch 131997	Mid Ch 132322	High Ch 132647
	1712.5 MHz	1745.0 MHz	1777.5 MHz	1712.5 MHz	1745.0 MHz	1777.5 MHz
Max. Cond. Power (dBm)	23.10	23.18	23.13	21.87	22.09	21.88
Max. EIRP Power (dBm)	28.10	28.18	28.13	26.87	27.09	26.88
Max. EIRP Power (mW)	645.65	657.66	650.13	486.41	511.68	487.53

Band 66 / 10M, 1RB#0

Test Mode	QPSK			16QAM		
	Low Ch 132022	Mid Ch 132322	High Ch 132622	Low Ch 132022	Mid Ch 132322	High Ch 132622
	1715.0 MHz	1745.0 MHz	1775.0 MHz	1715.0 MHz	1745.0 MHz	1775.0 MHz
Max. Cond. Power (dBm)	23.14	23.26	23.16	21.98	22.08	21.95
Max. EIRP Power (dBm)	28.14	28.26	28.16	26.98	27.08	26.95
Max. EIRP Power (mW)	651.63	669.88	654.64	498.88	510.50	495.45

Band 66 / 15M, 1RB#0

Test Mode	QPSK			16QAM		
	Low Ch 132047	Mid Ch 132322	High Ch 132597	Low Ch 132047	Mid Ch 132322	High Ch 132597
	1717.5 MHz	1745.0 MHz	1772.5 MHz	1717.5 MHz	1745.0 MHz	1772.5 MHz
Max. Cond. Power (dBm)	23.21	23.34	23.21	22.12	22.24	22.11
Max. EIRP Power (dBm)	28.21	28.34	28.21	27.12	27.24	27.11
Max. EIRP Power (mW)	662.22	682.34	662.22	515.23	529.66	514.04

Band 66 / 20M, 1RB#0

Test Mode	QPSK			16QAM		
	Low Ch 132072	Mid Ch 132322	High Ch 132572	Low Ch 132072	Mid Ch 132322	High Ch 132572
	1720.0 MHz	1745.0 MHz	1770.0 MHz	1720.0 MHz	1745.0 MHz	1770.0 MHz
Max. Cond. Power (dBm)	23.26	23.37	23.29	22.24	22.31	22.25
Max. EIRP Power (dBm)	28.26	28.37	28.29	27.24	27.31	27.25
Max. EIRP Power (mW)	669.88	687.07	674.53	529.66	538.27	530.88

4.2 Modulation Characteristics Measurement

4.2.1 Limits of Modulation Characteristics

N/A

4.2.2 Test Setup



4.2.3 Test Procedure

Connect the EUT to Communication Simulator via the antenna connector. The frequency band is set as EUT supported Modulation and Channels, the EUT output is matched with 50 ohm load, the waveform quality and constellation of the EUT was tested.

4.2.4 Test Results

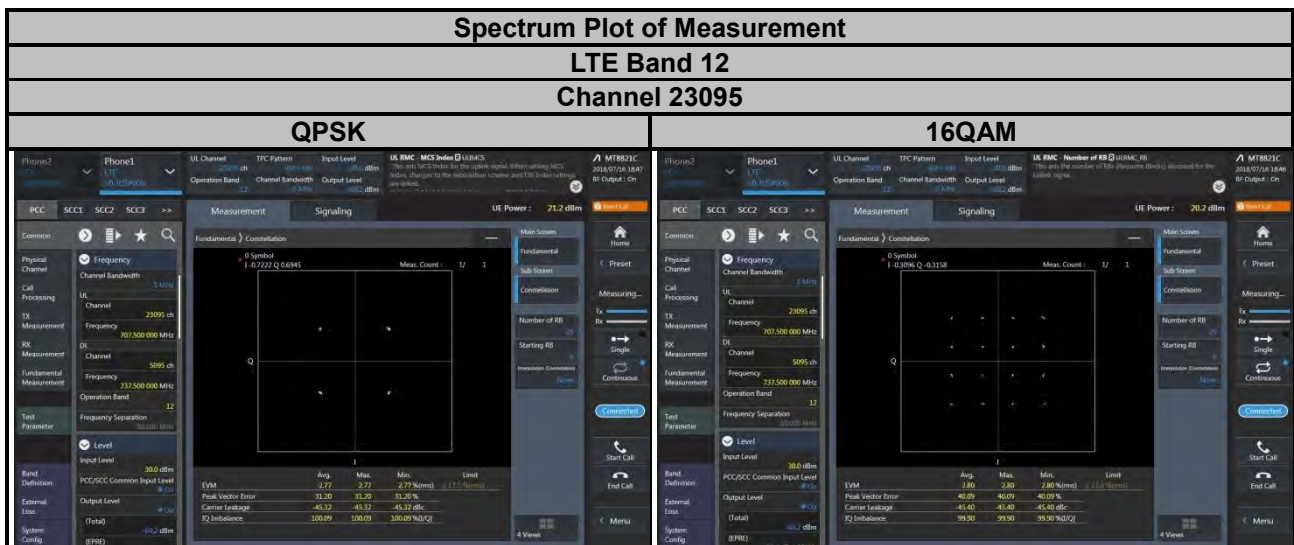
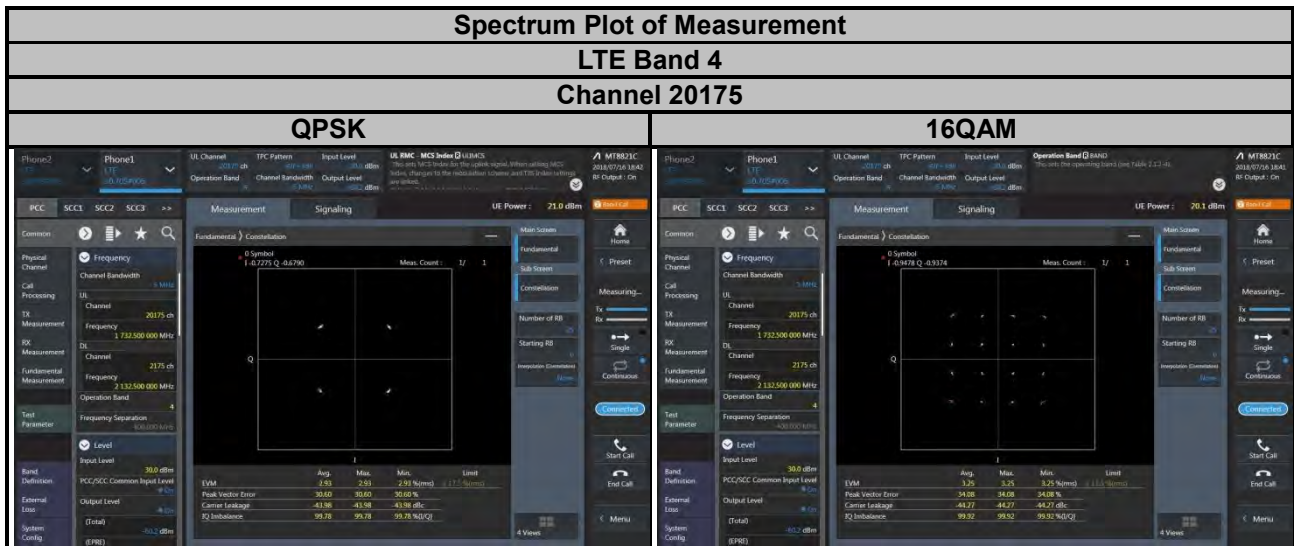
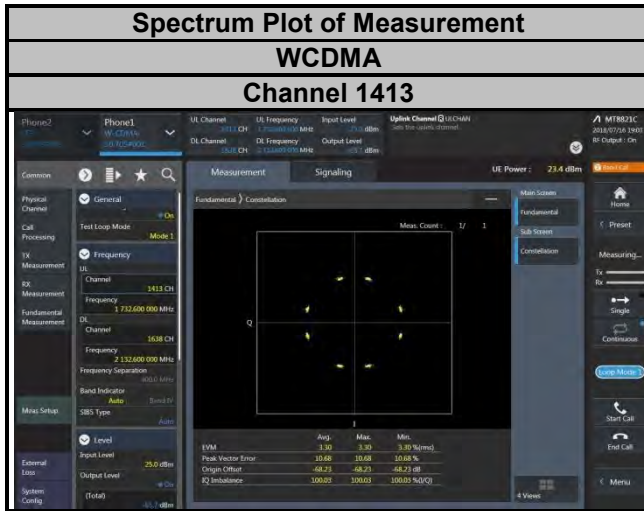

Spectrum Plot of Measurement LTE Band 13 Channel 23230

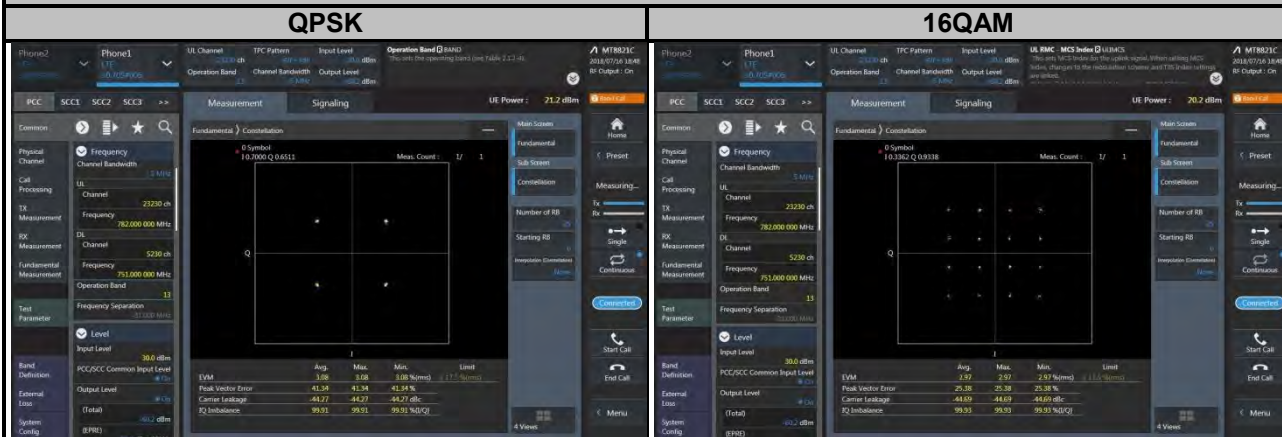

Spectrum Plot of Measurement LTE Band 17 Channel 23790

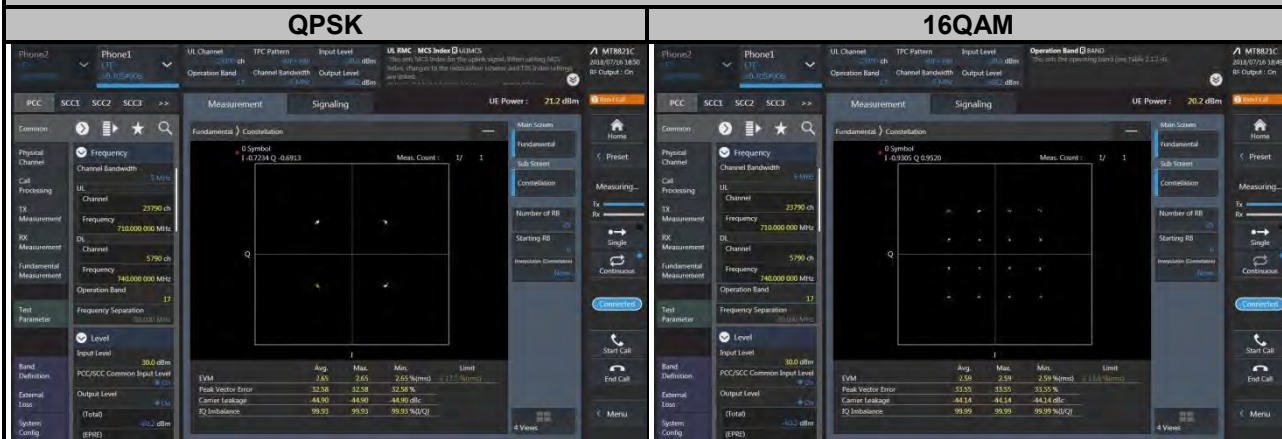

Spectrum Plot of Measurement LTE Band 66 Channel 132322

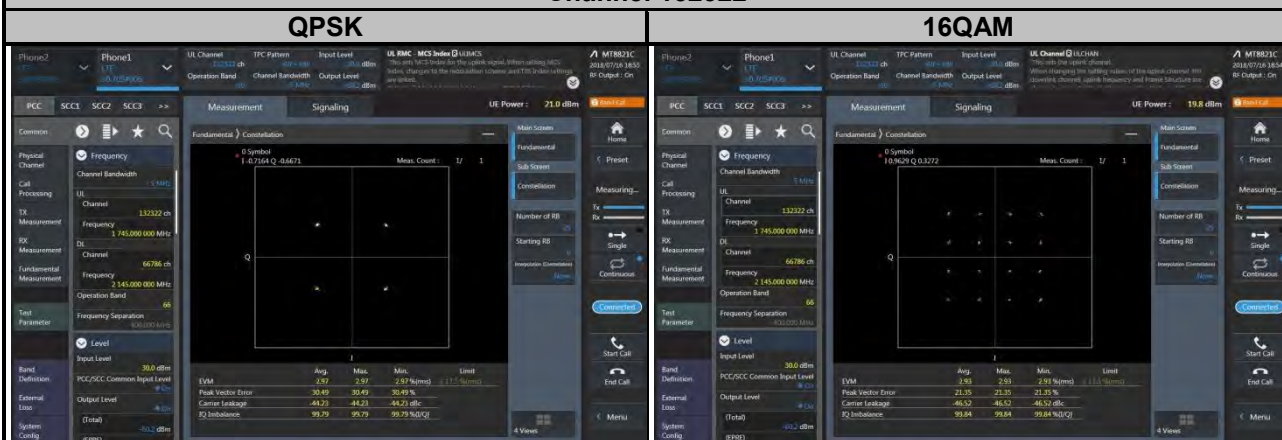

4.3 Frequency Stability Measurement

4.3.1 Limits of Frequency Stability Measurement

The frequency stability shall be sufficient to ensure that the fundamental emissions stay within the authorized bands of operation.

4.3.2 Test Procedure

- Device is placed at the oven room. The oven room could control the temperatures and humidity. Power warm up is at least 15 min and power applied should perform before recording frequency error.
- EUT is connected the external power supply to control the DC input power. The test voltage range is from minimum to maximum working voltage. Each step shall be record the frequency error rate.
- The temperature range step is 10 degrees in this test items. All temperature levels shall be hold the ± 0.5 °C during the measurement testing. The each temperature step shall be at least 0.5 hours, consider the EUT could be test under the stability condition.

Note: The frequency error was recorded frequency error from the communication simulator.

4.3.3 Test Setup

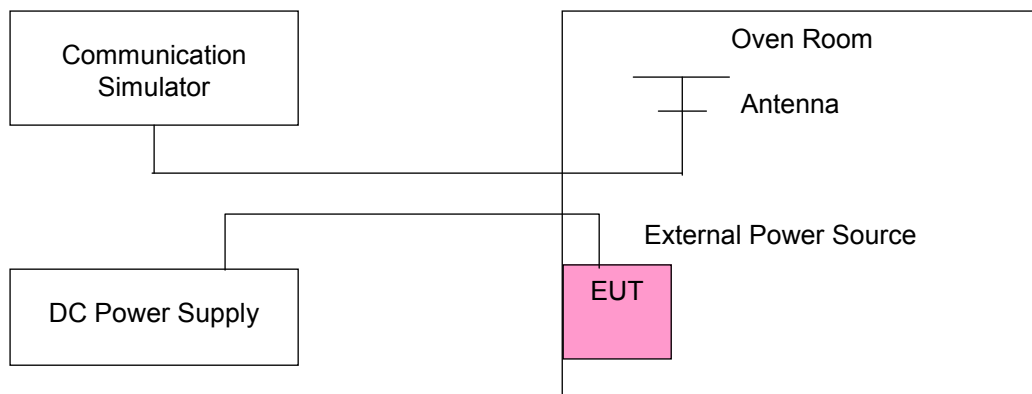

4.3.4 Test Results

Frequency Error vs. Voltage

Voltage (Volts)	WCDMA				Limit (ppm)
	Low Channel		High Channel		
	Frequency (MHz)	Frequency Error (ppm)	Frequency (MHz)	Frequency Error (ppm)	
3.3	1712.400002	0.001	1752.600001	0.001	2.5
3.135	1712.400004	0.002	1752.600002	0.001	2.5
4.4	1712.400003	0.002	1752.600002	0.001	2.5

Note: The applicant defined the normal working voltage of the battery is from 3.135 Vdc to 4.4 Vdc.

Frequency Error vs. Temperature

Temp. (°C)	WCDMA				Limit (ppm)
	Low Channel		High Channel		
	Frequency (MHz)	Frequency Error (ppm)	Frequency (MHz)	Frequency Error (ppm)	
-30	1712.400004	0.002	1752.600004	0.002	2.5
-20	1712.400003	0.002	1752.600002	0.001	2.5
-10	1712.400004	0.002	1752.600001	0.001	2.5
0	1712.400001	0.001	1752.600004	0.002	2.5
10	1712.400002	0.001	1752.600003	0.001	2.5
20	1712.399997	-0.002	1752.599998	-0.001	2.5
30	1712.399998	-0.001	1752.599999	-0.001	2.5
40	1712.399998	-0.001	1752.599998	-0.001	2.5
50	1712.399999	-0.001	1752.599997	-0.002	2.5
55	1712.399996	-0.002	1752.599997	-0.002	2.5

Frequency Error vs. Voltage

Voltage (Volts)	LTE Band 4				Limit (ppm)
	Channel Bandwidth: 1.4 MHz				
	Low Channel		High Channel		
	Frequency (MHz)	Frequency Error (ppm)	Frequency (MHz)	Frequency Error (ppm)	
3.3	1710.700002	0.001	1754.300002	0.001	2.5
3.135	1710.700002	0.001	1754.300002	0.001	2.5
4.4	1710.700003	0.002	1754.300004	0.002	2.5

Note: The applicant defined the normal working voltage of the battery is from 3.135 Vdc to 4.4 Vdc.

Frequency Error vs. Temperature

Temp. (°C)	LTE Band 4				Limit (ppm)
	Channel Bandwidth: 1.4 MHz				
	Low Channel		High Channel		
	Frequency (MHz)	Frequency Error (ppm)	Frequency (MHz)	Frequency Error (ppm)	
-30	1710.700002	0.001	1754.300003	0.002	2.5
-20	1710.700003	0.002	1754.300002	0.001	2.5
-10	1710.700001	0.001	1754.300004	0.002	2.5
0	1710.700003	0.002	1754.300002	0.001	2.5
10	1710.700002	0.001	1754.300001	0.001	2.5
20	1710.699997	-0.002	1754.299996	-0.002	2.5
30	1710.699998	-0.001	1754.299997	-0.002	2.5
40	1710.699998	-0.001	1754.299999	-0.001	2.5
50	1710.699996	-0.002	1754.299997	-0.002	2.5
55	1710.699998	-0.001	1754.299998	-0.001	2.5

Frequency Error vs. Voltage

Voltage (Volts)	LTE Band 4				Limit (ppm)
	Channel Bandwidth: 3 MHz				
	Low Channel		High Channel		
	Frequency (MHz)	Frequency Error (ppm)	Frequency (MHz)	Frequency Error (ppm)	
3.3	1711.500002	0.001	1753.500004	0.002	2.5
3.135	1711.500002	0.001	1753.500001	0.001	2.5
4.4	1711.500004	0.002	1753.500003	0.002	2.5

Note: The applicant defined the normal working voltage of the battery is from 3.135 Vdc to 4.4 Vdc.

Frequency Error vs. Temperature

Temp. (°C)	LTE Band 4				Limit (ppm)
	Channel Bandwidth: 3 MHz				
	Low Channel		High Channel		
	Frequency (MHz)	Frequency Error (ppm)	Frequency (MHz)	Frequency Error (ppm)	
-30	1711.500002	0.001	1753.500003	0.002	2.5
-20	1711.500002	0.001	1753.500001	0.001	2.5
-10	1711.500003	0.002	1753.500002	0.001	2.5
0	1711.500003	0.002	1753.500002	0.001	2.5
10	1711.500003	0.002	1753.500001	0.001	2.5
20	1711.499996	-0.002	1753.499996	-0.002	2.5
30	1711.499999	-0.001	1753.499996	-0.002	2.5
40	1711.499999	-0.001	1753.499997	-0.002	2.5
50	1711.499999	-0.001	1753.499999	-0.001	2.5
55	1711.499997	-0.002	1753.499998	-0.001	2.5

Frequency Error vs. Voltage

Voltage (Volts)	LTE Band 4				Limit (ppm)
	Channel Bandwidth: 5 MHz				
	Low Channel		High Channel		
	Frequency (MHz)	Frequency Error (ppm)	Frequency (MHz)	Frequency Error (ppm)	
3.3	1712.500003	0.001	1752.500003	0.002	2.5
3.135	1712.500001	0.001	1752.500003	0.002	2.5
4.4	1712.500001	0.001	1752.500004	0.002	2.5

Note: The applicant defined the normal working voltage of the battery is from 3.135 Vdc to 4.4 Vdc.

Frequency Error vs. Temperature

Temp. (°C)	LTE Band 4				Limit (ppm)
	Channel Bandwidth: 5 MHz				
	Low Channel		High Channel		
	Frequency (MHz)	Frequency Error (ppm)	Frequency (MHz)	Frequency Error (ppm)	
-30	1712.500003	0.001	1752.500003	0.001	2.5
-20	1712.500004	0.002	1752.500001	0.001	2.5
-10	1712.500002	0.001	1752.500002	0.001	2.5
0	1712.500002	0.001	1752.500002	0.001	2.5
10	1712.500002	0.001	1752.500003	0.002	2.5
20	1712.499998	-0.001	1752.499998	-0.001	2.5
30	1712.499997	-0.002	1752.499997	-0.002	2.5
40	1712.499997	-0.002	1752.499997	-0.002	2.5
50	1712.499998	-0.001	1752.499998	-0.001	2.5
55	1712.499997	-0.002	1752.499997	-0.002	2.5

Frequency Error vs. Voltage

Voltage (Volts)	LTE Band 4				Limit (ppm)
	Channel Bandwidth: 10 MHz				
	Low Channel		High Channel		
	Frequency (MHz)	Frequency Error (ppm)	Frequency (MHz)	Frequency Error (ppm)	
3.3	1715.000003	0.002	1750.000002	0.001	2.5
3.135	1715.000002	0.001	1750.000001	0.001	2.5
4.4	1715.000002	0.001	1750.000001	0.001	2.5

Note: The applicant defined the normal working voltage of the battery is from 3.135 Vdc to 4.4 Vdc.

Frequency Error vs. Temperature

Temp. (°C)	LTE Band 4				Limit (ppm)
	Channel Bandwidth: 10 MHz				
	Low Channel		High Channel		
	Frequency (MHz)	Frequency Error (ppm)	Frequency (MHz)	Frequency Error (ppm)	
-30	1715.000003	0.001	1750.000001	0.001	2.5
-20	1715.000002	0.001	1750.000001	0.001	2.5
-10	1715.000002	0.001	1750.000002	0.001	2.5
0	1715.000003	0.002	1750.000004	0.002	2.5
10	1715.000002	0.001	1750.000003	0.002	2.5
20	1714.999998	-0.001	1749.999996	-0.002	2.5
30	1714.999997	-0.002	1749.999997	-0.002	2.5
40	1714.999997	-0.002	1749.999999	-0.001	2.5
50	1714.999996	-0.002	1749.999998	-0.001	2.5
55	1714.999997	-0.002	1749.999998	-0.001	2.5

Frequency Error vs. Voltage

Voltage (Volts)	LTE Band 4				Limit (ppm)
	Channel Bandwidth: 15 MHz				
	Low Channel		High Channel		
	Frequency (MHz)	Frequency Error (ppm)	Frequency (MHz)	Frequency Error (ppm)	
3.3	1717.500003	0.001	1747.500002	0.001	2.5
3.135	1717.500003	0.002	1747.500002	0.001	2.5
4.4	1717.500001	0.001	1747.500002	0.001	2.5

Note: The applicant defined the normal working voltage of the battery is from 3.135 Vdc to 4.4 Vdc.

Frequency Error vs. Temperature

Temp. (°C)	LTE Band 4				Limit (ppm)
	Channel Bandwidth: 15 MHz				
	Low Channel		High Channel		
	Frequency (MHz)	Frequency Error (ppm)	Frequency (MHz)	Frequency Error (ppm)	
-30	1717.500003	0.002	1747.500002	0.001	2.5
-20	1717.500002	0.001	1747.500001	0.001	2.5
-10	1717.500002	0.001	1747.500002	0.001	2.5
0	1717.500003	0.002	1747.500001	0.001	2.5
10	1717.500004	0.002	1747.500003	0.001	2.5
20	1717.499998	-0.001	1747.499997	-0.002	2.5
30	1717.499997	-0.002	1747.499997	-0.002	2.5
40	1717.499998	-0.001	1747.499999	-0.001	2.5
50	1717.499997	-0.002	1747.499999	-0.001	2.5
55	1717.499997	-0.002	1747.499999	-0.001	2.5

Frequency Error vs. Voltage

Voltage (Volts)	LTE Band 4				Limit (ppm)
	Channel Bandwidth: 20 MHz				
	Low Channel		High Channel		
	Frequency (MHz)	Frequency Error (ppm)	Frequency (MHz)	Frequency Error (ppm)	
3.3	1720.000001	0.001	1745.000002	0.001	2.5
3.135	1720.000002	0.001	1745.000003	0.002	2.5
4.4	1720.000003	0.002	1745.000002	0.001	2.5

Note: The applicant defined the normal working voltage of the battery is from 3.135 Vdc to 4.4 Vdc.

Frequency Error vs. Temperature

Temp. (°C)	LTE Band 4				Limit (ppm)
	Channel Bandwidth: 20 MHz				
	Low Channel		High Channel		
	Frequency (MHz)	Frequency Error (ppm)	Frequency (MHz)	Frequency Error (ppm)	
-30	1720.000004	0.002	1745.000002	0.001	2.5
-20	1720.000003	0.002	1745.000003	0.002	2.5
-10	1720.000002	0.001	1745.000004	0.002	2.5
0	1720.000002	0.001	1745.000002	0.001	2.5
10	1720.000003	0.002	1745.000003	0.001	2.5
20	1719.999997	-0.002	1744.999997	-0.001	2.5
30	1719.999997	-0.002	1744.999997	-0.002	2.5
40	1719.999998	-0.001	1744.999997	-0.002	2.5
50	1719.999999	-0.001	1744.999999	-0.001	2.5
55	1719.999997	-0.002	1744.999997	-0.002	2.5

Frequency Error vs. Voltage

Voltage (Volts)	LTE Band 12				Limit (ppm)
	Channel Bandwidth: 1.4 MHz				
	Low Channel		High Channel		
	Frequency (MHz)	Frequency Error (ppm)	Frequency (MHz)	Frequency Error (ppm)	
3.3	699.700003	0.004	715.300002	0.003	2.5
3.135	699.700002	0.002	715.300002	0.002	2.5
4.4	699.700004	0.006	715.300003	0.004	2.5

Note: The applicant defined the normal working voltage of the battery is from 3.135 Vdc to 4.4 Vdc.

Frequency Error vs. Temperature

Temp. (°C)	LTE Band 12				Limit (ppm)
	Channel Bandwidth: 1.4 MHz				
	Low Channel		High Channel		
	Frequency (MHz)	Frequency Error (ppm)	Frequency (MHz)	Frequency Error (ppm)	
-30	699.700002	0.003	715.300003	0.004	2.5
-20	699.700004	0.006	715.300001	0.001	2.5
-10	699.700003	0.005	715.300003	0.004	2.5
0	699.700003	0.004	715.300001	0.001	2.5
10	699.700004	0.006	715.300004	0.005	2.5
20	699.699998	-0.003	715.299996	-0.005	2.5
30	699.699999	-0.002	715.299997	-0.004	2.5
40	699.699996	-0.006	715.299996	-0.005	2.5
50	699.699997	-0.005	715.299996	-0.006	2.5
55	699.699997	-0.004	715.299998	-0.003	2.5

Frequency Error vs. Voltage

Voltage (Volts)	LTE Band 12				Limit (ppm)
	Channel Bandwidth: 3 MHz				
	Low Channel		High Channel		
	Frequency (MHz)	Frequency Error (ppm)	Frequency (MHz)	Frequency Error (ppm)	
3.3	700.500002	0.003	714.500003	0.003	2.5
3.135	700.500001	0.002	714.500001	0.002	2.5
4.4	700.500004	0.005	714.500004	0.005	2.5

Note: The applicant defined the normal working voltage of the battery is from 3.135 Vdc to 4.4 Vdc.

Frequency Error vs. Temperature

Temp. (°C)	LTE Band 12				Limit (ppm)
	Channel Bandwidth: 3 MHz				
	Low Channel		High Channel		
	Frequency (MHz)	Frequency Error (ppm)	Frequency (MHz)	Frequency Error (ppm)	
-30	700.500002	0.003	714.500004	0.005	2.5
-20	700.500001	0.002	714.500001	0.002	2.5
-10	700.500002	0.003	714.500003	0.004	2.5
0	700.500003	0.005	714.500004	0.006	2.5
10	700.500004	0.005	714.500004	0.006	2.5
20	700.499998	-0.003	714.499996	-0.005	2.5
30	700.499997	-0.004	714.499997	-0.005	2.5
40	700.499997	-0.005	714.499998	-0.003	2.5
50	700.499997	-0.005	714.499998	-0.003	2.5
55	700.499996	-0.006	714.499998	-0.003	2.5

Frequency Error vs. Voltage

Voltage (Volts)	LTE Band 12				Limit (ppm)
	Channel Bandwidth: 5 MHz				
	Low Channel		High Channel		
	Frequency (MHz)	Frequency Error (ppm)	Frequency (MHz)	Frequency Error (ppm)	
3.3	701.500003	0.004	713.500004	0.005	2.5
3.135	701.500003	0.004	713.500003	0.004	2.5
4.4	701.500003	0.004	713.500003	0.004	2.5

Note: The applicant defined the normal working voltage of the battery is from 3.135 Vdc to 4.4 Vdc.

Frequency Error vs. Temperature

Temp. (°C)	LTE Band 12				Limit (ppm)
	Channel Bandwidth: 5 MHz				
	Low Channel		High Channel		
	Frequency (MHz)	Frequency Error (ppm)	Frequency (MHz)	Frequency Error (ppm)	
-30	701.500002	0.003	713.500002	0.003	2.5
-20	701.500003	0.004	713.500002	0.003	2.5
-10	701.500004	0.005	713.500003	0.004	2.5
0	701.500003	0.004	713.500001	0.002	2.5
10	701.500003	0.004	713.500003	0.004	2.5
20	701.499997	-0.005	713.499998	-0.002	2.5
30	701.499997	-0.005	713.499998	-0.002	2.5
40	701.499997	-0.004	713.499999	-0.002	2.5
50	701.499998	-0.003	713.499997	-0.004	2.5
55	701.499998	-0.002	713.499997	-0.005	2.5

Frequency Error vs. Voltage

Voltage (Volts)	LTE Band 12				Limit (ppm)
	Channel Bandwidth: 10 MHz				
	Low Channel		High Channel		
	Frequency (MHz)	Frequency Error (ppm)	Frequency (MHz)	Frequency Error (ppm)	
3.3	704.000004	0.005	711.000002	0.003	2.5
3.135	704.000003	0.005	711.000001	0.002	2.5
4.4	704.000002	0.003	711.000002	0.003	2.5

Note: The applicant defined the normal working voltage of the battery is from 3.135 Vdc to 4.4 Vdc.

Frequency Error vs. Temperature

Temp. (°C)	LTE Band 12				Limit (ppm)
	Channel Bandwidth: 10 MHz				
	Low Channel		High Channel		
	Frequency (MHz)	Frequency Error (ppm)	Frequency (MHz)	Frequency Error (ppm)	
-30	704.000003	0.005	711.000004	0.005	2.5
-20	704.000002	0.003	711.000004	0.006	2.5
-10	704.000003	0.004	711.000004	0.005	2.5
0	704.000002	0.003	711.000002	0.003	2.5
10	704.000003	0.004	711.000001	0.001	2.5
20	703.999999	-0.002	710.999998	-0.003	2.5
30	703.999996	-0.005	710.999998	-0.003	2.5
40	703.999998	-0.002	710.999999	-0.002	2.5
50	703.999998	-0.003	710.999998	-0.002	2.5
55	703.999997	-0.005	710.999998	-0.002	2.5

Frequency Error vs. Voltage

Voltage (Volts)	LTE Band 13				Limit (ppm)
	Channel Bandwidth: 5 MHz				
	Low Channel		High Channel		
	Frequency (MHz)	Frequency Error (ppm)	Frequency (MHz)	Frequency Error (ppm)	
3.3	779.500001	0.001	784.500002	0.002	2.5
3.135	779.500003	0.004	784.500004	0.005	2.5
4.4	779.500001	0.001	784.500004	0.004	2.5

Note: The applicant defined the normal working voltage of the battery is from 3.135 Vdc to 4.4 Vdc.

Frequency Error vs. Temperature

Temp. (°C)	LTE Band 13				Limit (ppm)
	Channel Bandwidth: 5 MHz				
	Low Channel		High Channel		
	Frequency (MHz)	Frequency Error (ppm)	Frequency (MHz)	Frequency Error (ppm)	
-30	779.500002	0.003	784.500003	0.004	2.5
-20	779.500003	0.003	784.500002	0.002	2.5
-10	779.500003	0.003	784.500003	0.004	2.5
0	779.500002	0.002	784.500004	0.005	2.5
10	779.500003	0.004	784.500003	0.004	2.5
20	779.499998	-0.003	784.499996	-0.005	2.5
30	779.499999	-0.002	784.499998	-0.002	2.5
40	779.499999	-0.002	784.499997	-0.003	2.5
50	779.499997	-0.004	784.499997	-0.004	2.5
55	779.499997	-0.003	784.499998	-0.002	2.5

Frequency Error vs. Voltage

Voltage (Volts)	LTE Band 13		Limit (ppm)
	Channel Bandwidth: 10 MHz		
	Frequency (MHz)	Frequency Error (ppm)	
3.3	782.000002	0.003	2.5
3.135	782.000001	0.001	2.5
4.4	782.000002	0.002	2.5

Note: The applicant defined the normal working voltage of the battery is from 3.135 Vdc to 4.4 Vdc.

Frequency Error vs. Temperature

Temp. (°C)	LTE Band 13		Limit (ppm)
	Channel Bandwidth: 10 MHz		
	Frequency (MHz)	Frequency Error (ppm)	
-30	782.000002	0.003	2.5
-20	782.000002	0.003	2.5
-10	782.000002	0.002	2.5
0	782.000002	0.002	2.5
10	782.000002	0.003	2.5
20	781.999998	-0.003	2.5
30	781.999999	-0.001	2.5
40	781.999997	-0.004	2.5
50	781.999999	-0.002	2.5
55	781.999997	-0.004	2.5

Frequency Error vs. Voltage

Voltage (Volts)	LTE Band 17				Limit (ppm)
	Channel Bandwidth: 5 MHz				
	Low Channel		High Channel		
	Frequency (MHz)	Frequency Error (ppm)	Frequency (MHz)	Frequency Error (ppm)	
3.3	706.500004	0.005	713.500003	0.004	2.5
3.135	706.500001	0.002	713.500001	0.001	2.5
4.4	706.500002	0.002	713.500004	0.006	2.5

Note: The applicant defined the normal working voltage of the battery is from 3.135 Vdc to 4.4 Vdc.

Frequency Error vs. Temperature

Temp. (°C)	LTE Band 17				Limit (ppm)
	Channel Bandwidth: 5 MHz				
	Low Channel		High Channel		
	Frequency (MHz)	Frequency Error (ppm)	Frequency (MHz)	Frequency Error (ppm)	
-30	706.500003	0.004	713.500004	0.005	2.5
-20	706.500002	0.002	713.500003	0.004	2.5
-10	706.500002	0.003	713.500002	0.003	2.5
0	706.500002	0.003	713.500004	0.005	2.5
10	706.500004	0.005	713.500003	0.004	2.5
20	706.499997	-0.005	713.499998	-0.003	2.5
30	706.499998	-0.003	713.499999	-0.002	2.5
40	706.499998	-0.003	713.499997	-0.004	2.5
50	706.499999	-0.002	713.499999	-0.002	2.5
55	706.499999	-0.002	713.499998	-0.003	2.5

Frequency Error vs. Voltage

Voltage (Volts)	LTE Band 17				Limit (ppm)
	Channel Bandwidth: 10 MHz				
	Low Channel		High Channel		
	Frequency (MHz)	Frequency Error (ppm)	Frequency (MHz)	Frequency Error (ppm)	
3.3	709.000001	0.002	711.000003	0.004	2.5
3.135	709.000002	0.003	711.000003	0.004	2.5
4.4	709.000001	0.001	711.000003	0.004	2.5

Note: The applicant defined the normal working voltage of the battery is from 3.135 Vdc to 4.4 Vdc.

Frequency Error vs. Temperature

Temp. (°C)	LTE Band 17				Limit (ppm)
	Channel Bandwidth: 10 MHz				
	Low Channel		High Channel		
	Frequency (MHz)	Frequency Error (ppm)	Frequency (MHz)	Frequency Error (ppm)	
-30	709.000002	0.002	711.000004	0.005	2.5
-20	709.000001	0.002	711.000003	0.005	2.5
-10	709.000003	0.005	711.000002	0.002	2.5
0	709.000002	0.003	711.000001	0.002	2.5
10	709.000004	0.005	711.000004	0.005	2.5
20	708.999998	-0.004	710.999997	-0.005	2.5
30	708.999997	-0.005	710.999999	-0.002	2.5
40	708.999998	-0.003	710.999996	-0.005	2.5
50	708.999999	-0.002	710.999998	-0.002	2.5
55	708.999998	-0.004	710.999999	-0.001	2.5

Frequency Error vs. Voltage

Voltage (Volts)	LTE Band 66				Limit (ppm)
	Channel Bandwidth: 1.4 MHz				
	Low Channel		High Channel		
	Frequency (MHz)	Frequency Error (ppm)	Frequency (MHz)	Frequency Error (ppm)	
3.3	1710.700003	0.002	1779.300003	0.002	2.5
3.135	1710.700003	0.002	1779.300004	0.002	2.5
4.4	1710.700002	0.001	1779.300003	0.001	2.5

Note: The applicant defined the normal working voltage of the battery is from 3.135 Vdc to 4.4 Vdc.

Frequency Error vs. Temperature

Temp. (°C)	LTE Band 66				Limit (ppm)
	Channel Bandwidth: 1.4 MHz				
	Low Channel		High Channel		
	Frequency (MHz)	Frequency Error (ppm)	Frequency (MHz)	Frequency Error (ppm)	
-30	1710.700001	0.001	1779.300001	0.001	2.5
-20	1710.700001	0.001	1779.300001	0.001	2.5
-10	1710.700002	0.001	1779.300003	0.002	2.5
0	1710.700001	0.001	1779.300002	0.001	2.5
10	1710.700003	0.002	1779.300004	0.002	2.5
20	1710.699997	-0.002	1779.299997	-0.002	2.5
30	1710.699999	-0.001	1779.299999	-0.001	2.5
40	1710.699997	-0.002	1779.299997	-0.002	2.5
50	1710.699997	-0.002	1779.299998	-0.001	2.5
55	1710.699997	-0.002	1779.299998	-0.001	2.5

Frequency Error vs. Voltage

Voltage (Volts)	LTE Band 66				Limit (ppm)
	Channel Bandwidth: 3 MHz				
	Low Channel		High Channel		
	Frequency (MHz)	Frequency Error (ppm)	Frequency (MHz)	Frequency Error (ppm)	
3.3	1711.500003	0.001	1778.500004	0.002	2.5
3.135	1711.500003	0.001	1778.500002	0.001	2.5
4.4	1711.500002	0.001	1778.500003	0.002	2.5

Note: The applicant defined the normal working voltage of the battery is from 3.135 Vdc to 4.4 Vdc.

Frequency Error vs. Temperature

Temp. (°C)	LTE Band 66				Limit (ppm)
	Channel Bandwidth: 3 MHz				
	Low Channel		High Channel		
	Frequency (MHz)	Frequency Error (ppm)	Frequency (MHz)	Frequency Error (ppm)	
-30	1711.500002	0.001	1778.500003	0.002	2.5
-20	1711.500003	0.002	1778.500001	0.001	2.5
-10	1711.500001	0.001	1778.500001	0.001	2.5
0	1711.500001	0.001	1778.500002	0.001	2.5
10	1711.500003	0.002	1778.500003	0.002	2.5
20	1711.499999	-0.001	1778.499997	-0.002	2.5
30	1711.499996	-0.002	1778.499997	-0.002	2.5
40	1711.499998	-0.001	1778.499997	-0.002	2.5
50	1711.499997	-0.002	1778.499998	-0.001	2.5
55	1711.499996	-0.002	1778.499997	-0.002	2.5

Frequency Error vs. Voltage

Voltage (Volts)	LTE Band 66				Limit (ppm)
	Channel Bandwidth: 5 MHz				
	Low Channel		High Channel		
	Frequency (MHz)	Frequency Error (ppm)	Frequency (MHz)	Frequency Error (ppm)	
3.3	1712.500001	0.001	1777.500004	0.002	2.5
3.135	1712.500003	0.002	1777.500004	0.002	2.5
4.4	1712.500004	0.002	1777.500004	0.002	2.5

Note: The applicant defined the normal working voltage of the battery is from 3.135 Vdc to 4.4 Vdc.

Frequency Error vs. Temperature

Temp. (°C)	LTE Band 66				Limit (ppm)
	Channel Bandwidth: 5 MHz				
	Low Channel		High Channel		
	Frequency (MHz)	Frequency Error (ppm)	Frequency (MHz)	Frequency Error (ppm)	
-30	1712.500004	0.002	1777.500002	0.001	2.5
-20	1712.500004	0.002	1777.500002	0.001	2.5
-10	1712.500001	0.001	1777.500003	0.002	2.5
0	1712.500004	0.002	1777.500002	0.001	2.5
10	1712.500001	0.001	1777.500001	0.001	2.5
20	1712.499998	-0.001	1777.499997	-0.002	2.5
30	1712.499996	-0.002	1777.499996	-0.002	2.5
40	1712.499999	-0.001	1777.499997	-0.002	2.5
50	1712.499999	-0.001	1777.499999	-0.001	2.5
55	1712.499999	-0.001	1777.499997	-0.002	2.5

Frequency Error vs. Voltage

Voltage (Volts)	LTE Band 66				Limit (ppm)
	Channel Bandwidth: 10 MHz				
	Low Channel		High Channel		
	Frequency (MHz)	Frequency Error (ppm)	Frequency (MHz)	Frequency Error (ppm)	
3.3	1715.000001	0.001	1775.000002	0.001	2.5
3.135	1715.000001	0.001	1775.000002	0.001	2.5
4.4	1715.000001	0.001	1775.000004	0.002	2.5

Note: The applicant defined the normal working voltage of the battery is from 3.135 Vdc to 4.4 Vdc.

Frequency Error vs. Temperature

Temp. (°C)	LTE Band 66				Limit (ppm)
	Channel Bandwidth: 10 MHz				
	Low Channel		High Channel		
	Frequency (MHz)	Frequency Error (ppm)	Frequency (MHz)	Frequency Error (ppm)	
-30	1715.000004	0.002	1775.000001	0.001	2.5
-20	1715.000004	0.002	1775.000002	0.001	2.5
-10	1715.000001	0.001	1775.000002	0.001	2.5
0	1715.000002	0.001	1775.000003	0.001	2.5
10	1715.000002	0.001	1775.000004	0.002	2.5
20	1714.999997	-0.002	1774.999998	-0.001	2.5
30	1714.999996	-0.002	1774.999998	-0.001	2.5
40	1714.999997	-0.002	1774.999997	-0.002	2.5
50	1714.999997	-0.002	1774.999997	-0.002	2.5
55	1714.999999	-0.001	1774.999997	-0.002	2.5

Frequency Error vs. Voltage

Voltage (Volts)	LTE Band 66				Limit (ppm)
	Channel Bandwidth: 15 MHz				
	Low Channel		High Channel		
	Frequency (MHz)	Frequency Error (ppm)	Frequency (MHz)	Frequency Error (ppm)	
3.3	1717.500003	0.002	1772.500002	0.001	2.5
3.135	1717.500002	0.001	1772.500002	0.001	2.5
4.4	1717.500003	0.002	1772.500003	0.002	2.5

Note: The applicant defined the normal working voltage of the battery is from 3.135 Vdc to 4.4 Vdc.

Frequency Error vs. Temperature

Temp. (°C)	LTE Band 66				Limit (ppm)
	Channel Bandwidth: 15 MHz				
	Low Channel		High Channel		
	Frequency (MHz)	Frequency Error (ppm)	Frequency (MHz)	Frequency Error (ppm)	
-30	1717.500002	0.001	1772.500003	0.001	2.5
-20	1717.500001	0.001	1772.500003	0.002	2.5
-10	1717.500001	0.001	1772.500003	0.002	2.5
0	1717.500003	0.001	1772.500002	0.001	2.5
10	1717.500004	0.002	1772.500003	0.002	2.5
20	1717.499998	-0.001	1772.499998	-0.001	2.5
30	1717.499997	-0.002	1772.499997	-0.002	2.5
40	1717.499998	-0.001	1772.499998	-0.001	2.5
50	1717.499998	-0.001	1772.499997	-0.002	2.5
55	1717.499997	-0.002	1772.499996	-0.002	2.5

Frequency Error vs. Voltage

Voltage (Volts)	LTE Band 66				Limit (ppm)
	Channel Bandwidth: 20 MHz				
	Low Channel		High Channel		
	Frequency (MHz)	Frequency Error (ppm)	Frequency (MHz)	Frequency Error (ppm)	
3.3	1720.000002	0.001	1770.000001	0.001	2.5
3.135	1720.000003	0.002	1770.000002	0.001	2.5
4.4	1720.000004	0.002	1770.000003	0.001	2.5

Note: The applicant defined the normal working voltage of the battery is from 3.135 Vdc to 4.4 Vdc.

Frequency Error vs. Temperature

Temp. (°C)	LTE Band 66				Limit (ppm)
	Channel Bandwidth: 20 MHz				
	Low Channel		High Channel		
	Frequency (MHz)	Frequency Error (ppm)	Frequency (MHz)	Frequency Error (ppm)	
-30	1720.000001	0.001	1770.000002	0.001	2.5
-20	1720.000002	0.001	1770.000003	0.002	2.5
-10	1720.000002	0.001	1770.000003	0.002	2.5
0	1720.000003	0.002	1770.000003	0.002	2.5
10	1720.000001	0.001	1770.000003	0.002	2.5
20	1719.999998	-0.001	1769.999998	-0.001	2.5
30	1719.999998	-0.001	1769.999998	-0.001	2.5
40	1719.999998	-0.001	1769.999998	-0.001	2.5
50	1719.999998	-0.001	1769.999996	-0.002	2.5
55	1719.999998	-0.001	1769.999997	-0.002	2.5

4.4 Occupied Bandwidth Measurement

4.4.1 Limits of Occupied Bandwidth Measurement

The width of a frequency band such that, below the lower and above the upper frequency limits, the mean powers emitted are each equal to a specified percentage 0.5 % of the total mean power of a given emission.

4.4.2 Test Procedure

- The conducted occupied bandwidth used the power splitter via EUT RF power connector between simulation base station and spectrum analyzer.
- Use OBW measurement function of Spectrum analyzer to measure 99 % occupied bandwidth.

4.4.3 Test Setup

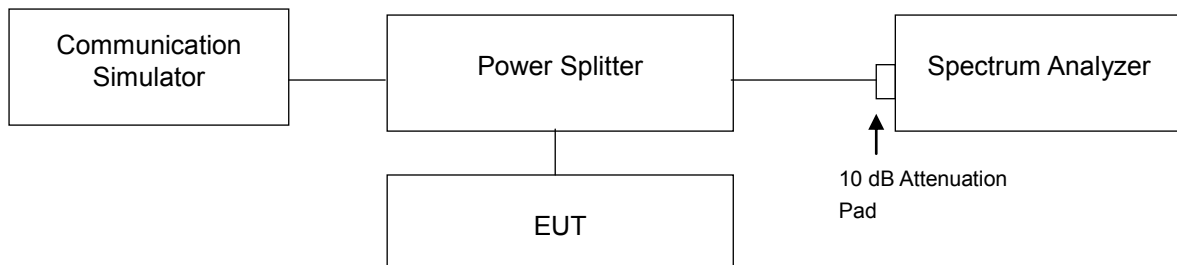

4.4.4 Test Result

WCDMA		
Channel	Frequency (MHz)	99 % Occupied Bandwidth (MHz)
1312	1712.4	4.0731
1413	1732.6	4.0779
1513	1752.6	4.0791

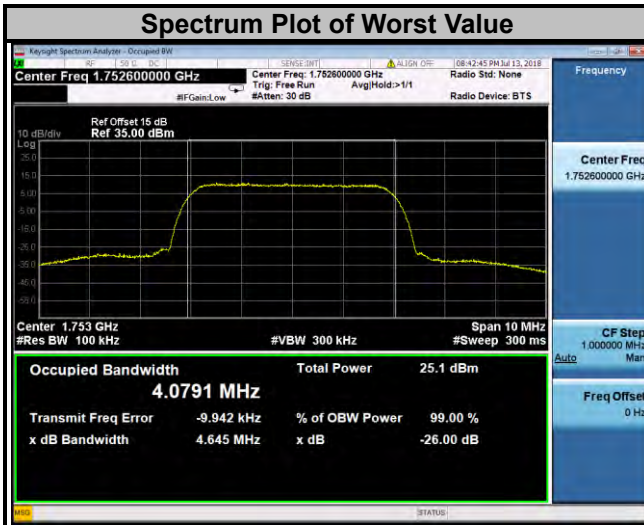

LTE Band 4							
Channel Bandwidth: 1.4 MHz				Channel Bandwidth: 3 MHz			
Channel	Frequency (MHz)	99 % Occupied Bandwidth (MHz)		Channel	Frequency (MHz)	99 % Occupied Bandwidth (MHz)	
		QPSK	16QAM			QPSK	16QAM
19957	1710.7	1.09	1.10	19965	1711.5	2.70	2.70
20175	1732.5	1.09	1.09	20175	1732.5	2.70	2.70
20393	1754.3	1.09	1.09	20385	1753.5	2.70	2.70

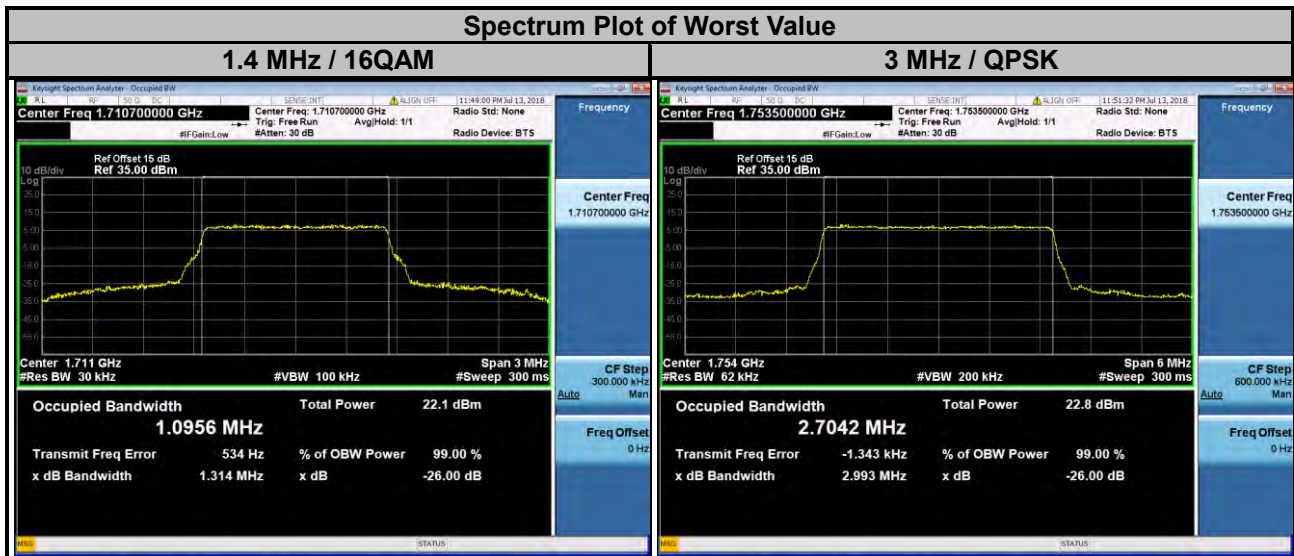

LTE Band 4							
Channel Bandwidth: 5 MHz				Channel Bandwidth: 10 MHz			
Channel	Frequency (MHz)	99 % Occupied Bandwidth (MHz)		Channel	Frequency (MHz)	99 % Occupied Bandwidth (MHz)	
		QPSK	16QAM			QPSK	16QAM
19975	1712.5	4.49	4.50	20000	1715.0	8.99	8.99
20175	1732.5	4.50	4.50	20175	1732.5	8.99	8.98
20375	1752.5	4.50	4.50	20350	1750.0	8.98	8.98

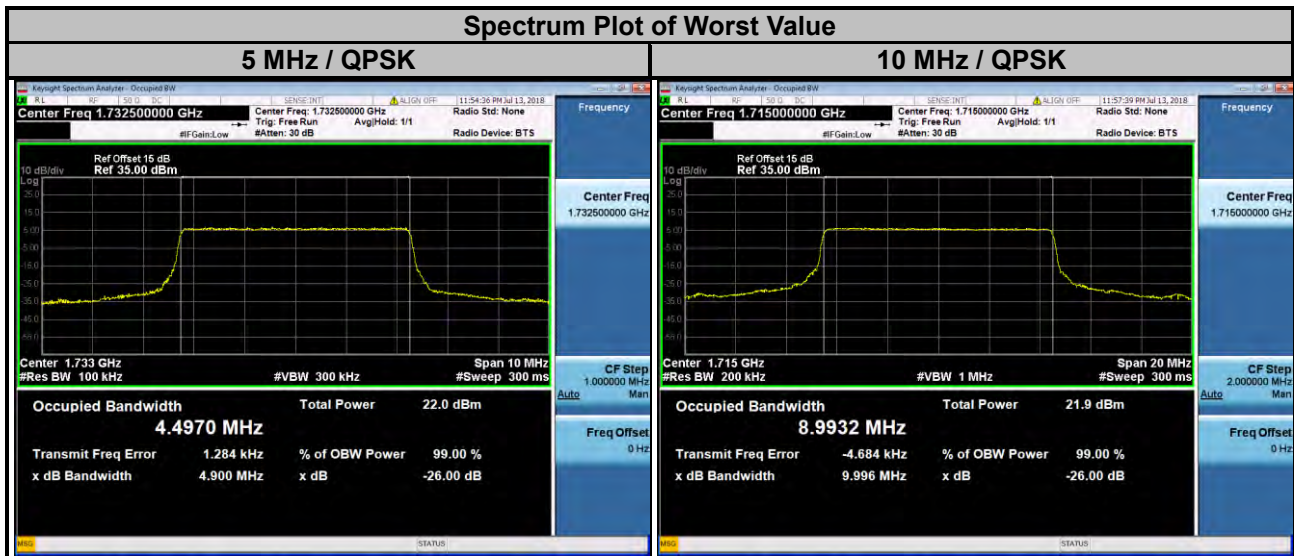

LTE Band 4

Channel Bandwidth: 15 MHz				Channel Bandwidth: 20 MHz			
Channel	Frequency (MHz)	99 % Occupied Bandwidth (MHz)		Channel	Frequency (MHz)	99 % Occupied Bandwidth (MHz)	
		QPSK	16QAM			QPSK	16QAM
20025	1717.5	13.48	13.48	20050	1720.0	17.98	17.99
20175	1732.5	13.47	13.48	20175	1732.5	17.98	17.98
20325	1747.5	13.47	13.48	20300	1745.0	17.97	17.98

Spectrum Plot of Worst Value

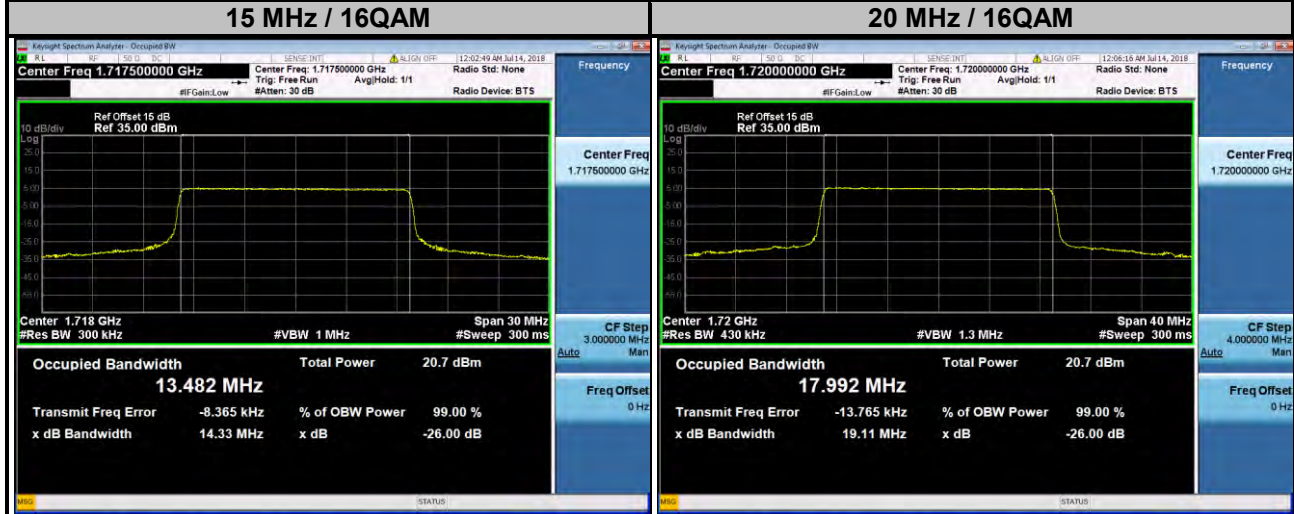

LTE Band 12							
Channel Bandwidth: 1.4 MHz				Channel Bandwidth: 3 MHz			
Channel	Frequency (MHz)	99 % Occupied Bandwidth (MHz)		Channel	Frequency (MHz)	99 % Occupied Bandwidth (MHz)	
		QPSK	16QAM			QPSK	16QAM
23017	699.7	1.10	1.09	23025	700.5	2.70	2.71
23095	707.5	1.09	1.09	23095	707.5	2.70	2.71
23173	715.3	1.10	1.10	23165	714.5	2.70	2.70

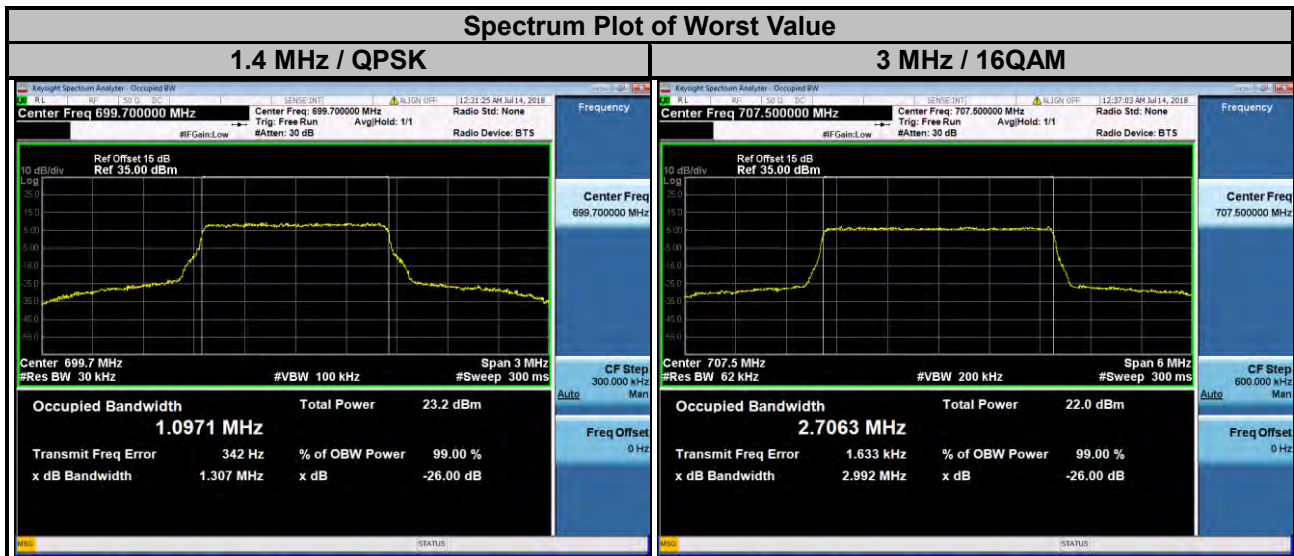

LTE Band 12

Channel Bandwidth: 5 MHz				Channel Bandwidth: 10 MHz			
Channel	Frequency (MHz)	99 % Occupied Bandwidth (MHz)		Channel	Frequency (MHz)	99 % Occupied Bandwidth (MHz)	
		QPSK	16QAM			QPSK	16QAM
23035	701.5	4.50	4.49	23060	704.0	8.99	8.99
23095	707.5	4.50	4.50	23095	707.5	9.00	9.00
23155	713.5	4.49	4.49	23130	711.0	8.98	8.97

Spectrum Plot of Worst Value

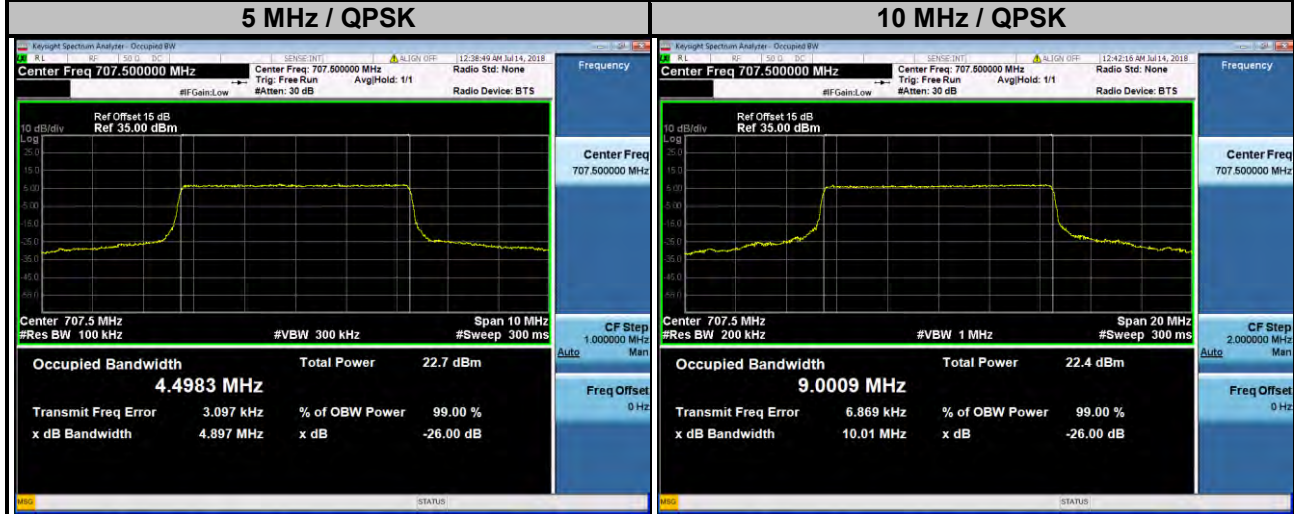

LTE Band 13							
Channel Bandwidth: 5 MHz				Channel Bandwidth: 10 MHz			
Channel	Frequency (MHz)	99 % Occupied Bandwidth (MHz)		Channel	Frequency (MHz)	99 % Occupied Bandwidth (MHz)	
		QPSK	16QAM			QPSK	16QAM
23205	779.5	4.50	4.50	23230	782.0	8.97	8.96
23230	782.0	4.49	4.49				
23255	784.5	4.49	4.49				

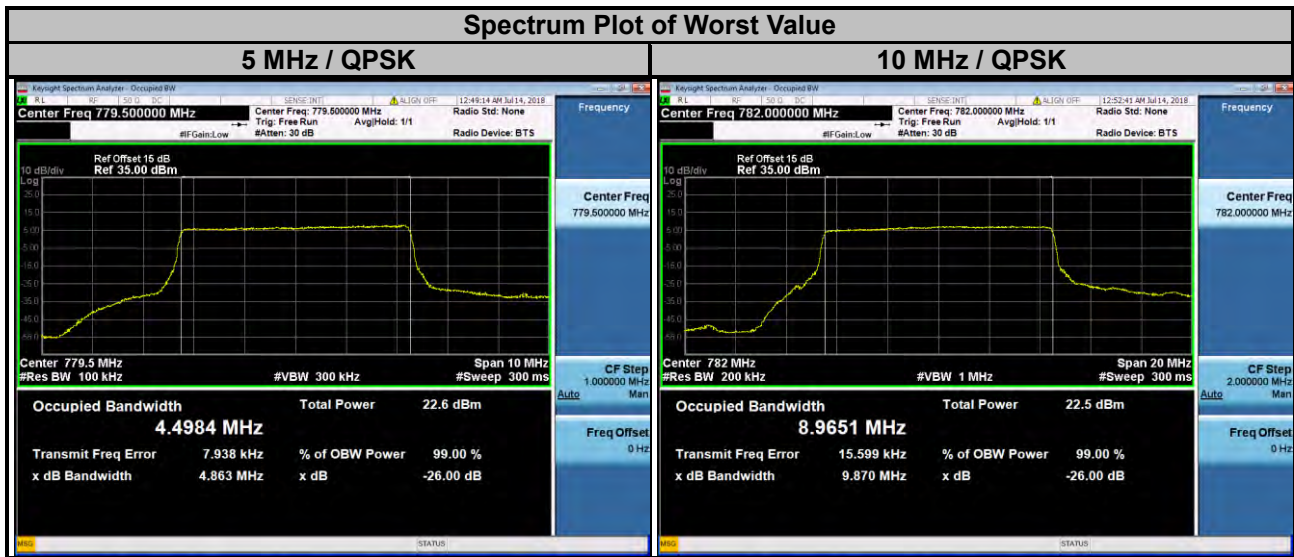

LTE Band 17

Channel Bandwidth: 5 MHz				Channel Bandwidth: 10 MHz			
Channel	Frequency (MHz)	99 % Occupied Bandwidth (MHz)		Channel	Frequency (MHz)	99 % Occupied Bandwidth (MHz)	
		QPSK	16QAM			QPSK	16QAM
23755	706.5	4.50	4.50	23780	709.0	8.98	8.99
23790	710.0	4.50	4.50	23790	710.0	8.99	8.98
23825	713.5	4.49	4.49	23800	711.0	8.99	8.97

Spectrum Plot of Worst Value



LTE Band 66

Channel Bandwidth: 1.4 MHz				Channel Bandwidth: 3 MHz			
Channel	Frequency (MHz)	99 % Occupied Bandwidth (MHz)		Channel	Frequency (MHz)	99 % Occupied Bandwidth (MHz)	
		QPSK	16QAM			QPSK	16QAM
131979	1710.7	1.09	1.10	131987	1711.5	2.70	2.70
132322	1745.0	1.09	1.09	132322	1745.0	2.70	2.70
132665	1779.3	1.09	1.09	132657	1778.5	2.70	2.71

Spectrum Plot of Worst Value

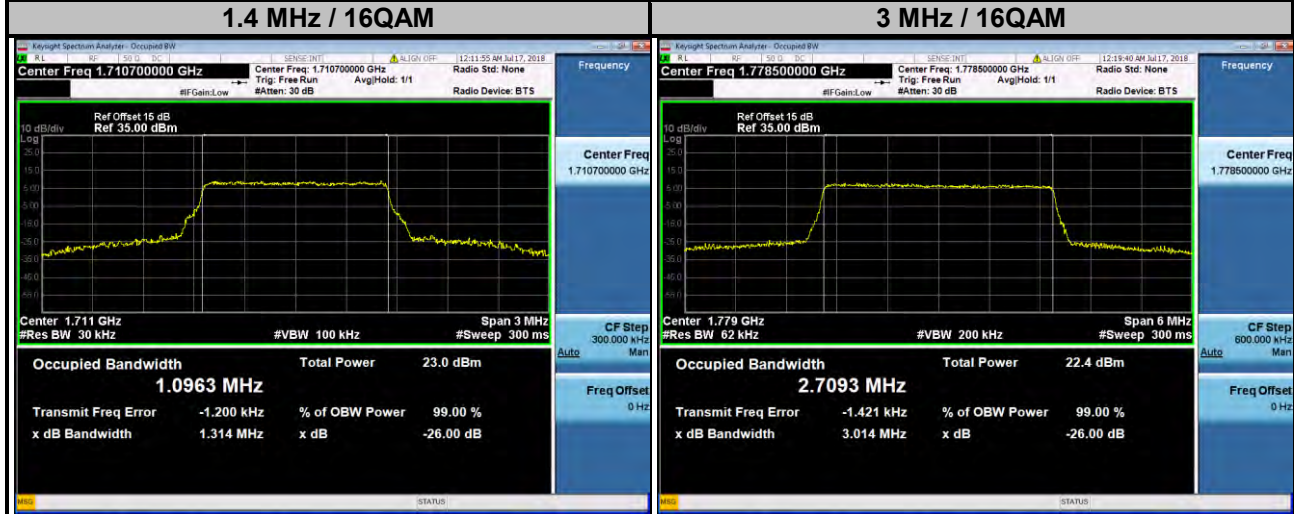

LTE Band 66

Channel Bandwidth: 5 MHz				Channel Bandwidth: 10 MHz			
Channel	Frequency (MHz)	99 % Occupied Bandwidth (MHz)		Channel	Frequency (MHz)	99 % Occupied Bandwidth (MHz)	
		QPSK	16QAM			QPSK	16QAM
131997	1712.5	4.50	4.49	132022	1715.0	8.99	9.00
132322	1745.0	4.50	4.51	132322	1745.0	9.00	9.00
132647	1777.5	4.50	4.50	132622	1775.0	8.97	8.98

Spectrum Plot of Worst Value

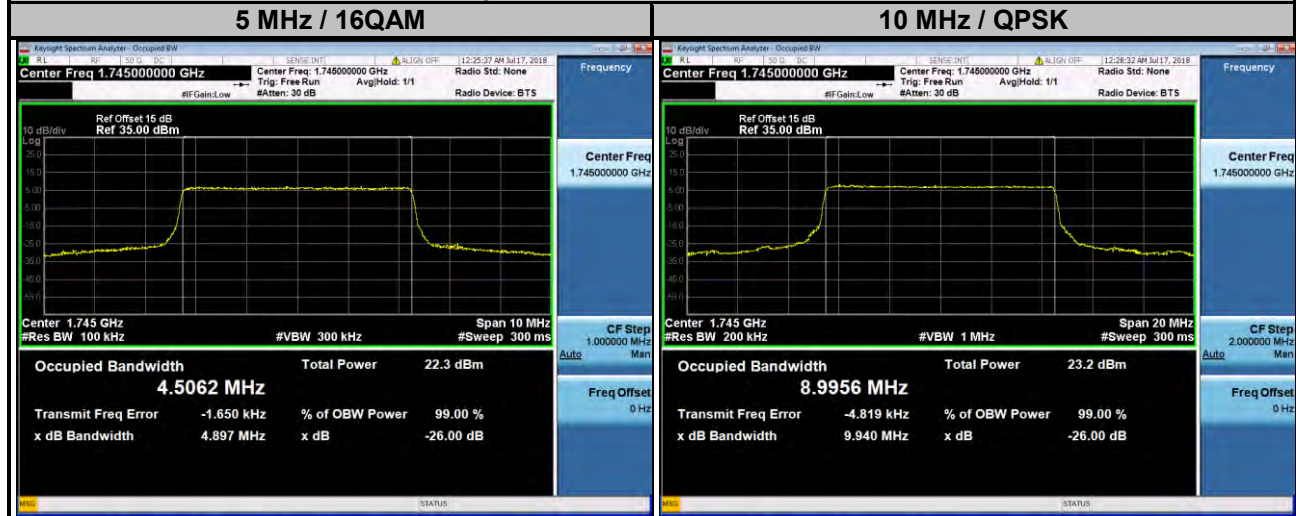

LTE Band 66

Channel Bandwidth: 15 MHz				Channel Bandwidth: 20 MHz			
Channel	Frequency (MHz)	99 % Occupied Bandwidth (MHz)		Channel	Frequency (MHz)	99 % Occupied Bandwidth (MHz)	
		QPSK	16QAM			QPSK	16QAM
132047	1717.5	13.47	13.47	132072	1720.0	17.98	17.98
132322	1745.0	13.47	13.48	132322	1745.0	17.96	17.96
132597	1772.5	13.45	13.44	132572	1770.0	17.94	17.94

Spectrum Plot of Worst Value

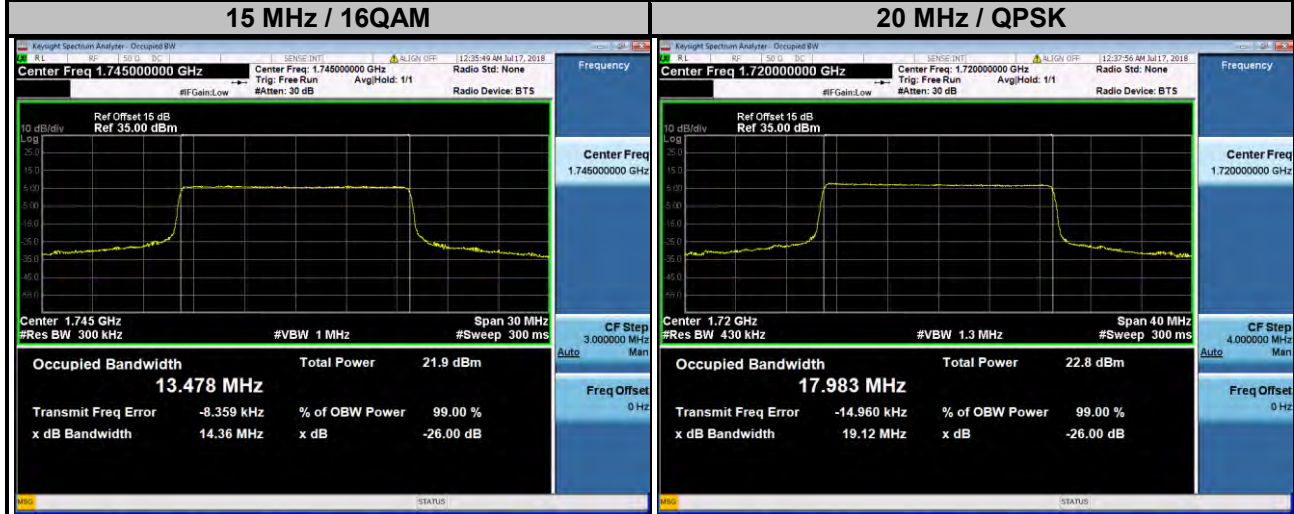

4.5 Band Edge Measurement

4.5.1 Limits of Band Edge Measurement

For operations in the 704-716 MHz band, the power of any emission outside a licensee's frequency band(s) of operation shall be attenuated below the transmitter power (P) within the licensed band(s) of operation, measured in watts, by at least $43 + 10 \log (P)$ dB. Compliance with this provision is based on the use of measurement instrumentation employing a resolution bandwidth of 100 kilohertz or greater.

However, in the 100 kilohertz bands immediately outside and adjacent to a licensee's frequency block, a resolution bandwidth of at least 30 kHz may be employed.

For operations in the 1710–1755 MHz bands, the power of any emission outside a licensee's frequency block shall be attenuated below the transmitter power (P) by at least $43 + 10 \log (P)$ dB.

4.5.2 Test Setup

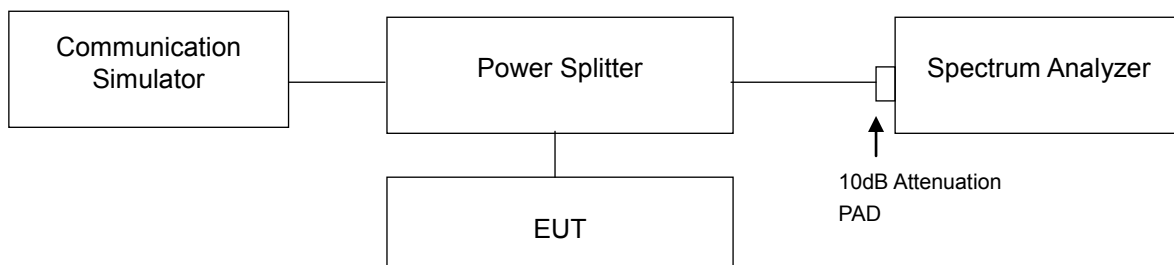

4.5.3 Test Procedures

- a. All measurements were done at low and high operational frequency range.
- b. The center frequency of spectrum is the band edge frequency and span is 5 MHz. RB of the spectrum is 100 kHz and VB of the spectrum is 300 kHz (WCDMA).
- c. The center frequency of spectrum is the band edge frequency and span is 1 MHz. RB of the spectrum is 30 kHz and VB of the spectrum is 100 kHz (LTE Bandwidth 1.4 MHz).
- d. The center frequency of spectrum is the band edge frequency and span is 1 MHz. RB of the spectrum is 62 kHz and VB of the spectrum is 200 kHz (LTE Bandwidth 3 MHz).
- e. The center frequency of spectrum is the band edge frequency and span is 1 MHz. RB of the spectrum is 100 kHz and VB of the spectrum is 300 kHz (LTE Bandwidth 5 MHz).
- f. The center frequency of spectrum is the band edge frequency and span is 1 MHz. RB of the spectrum is 200 kHz and VB of the spectrum is 1 MHz (LTE Bandwidth 10 MHz).
- g. The center frequency of spectrum is the band edge frequency and span is 1 MHz. RB of the spectrum is 300 kHz and VB of the spectrum is 1 MHz (LTE Bandwidth 15 MHz).
- h. The center frequency of spectrum is the band edge frequency and span is 1 MHz. RB of the spectrum is 300 kHz and VB of the spectrum is 1 MHz (LTE Bandwidth 20 MHz).
- i. Record the max. trace plot into the test report.

4.5.4 Test Results

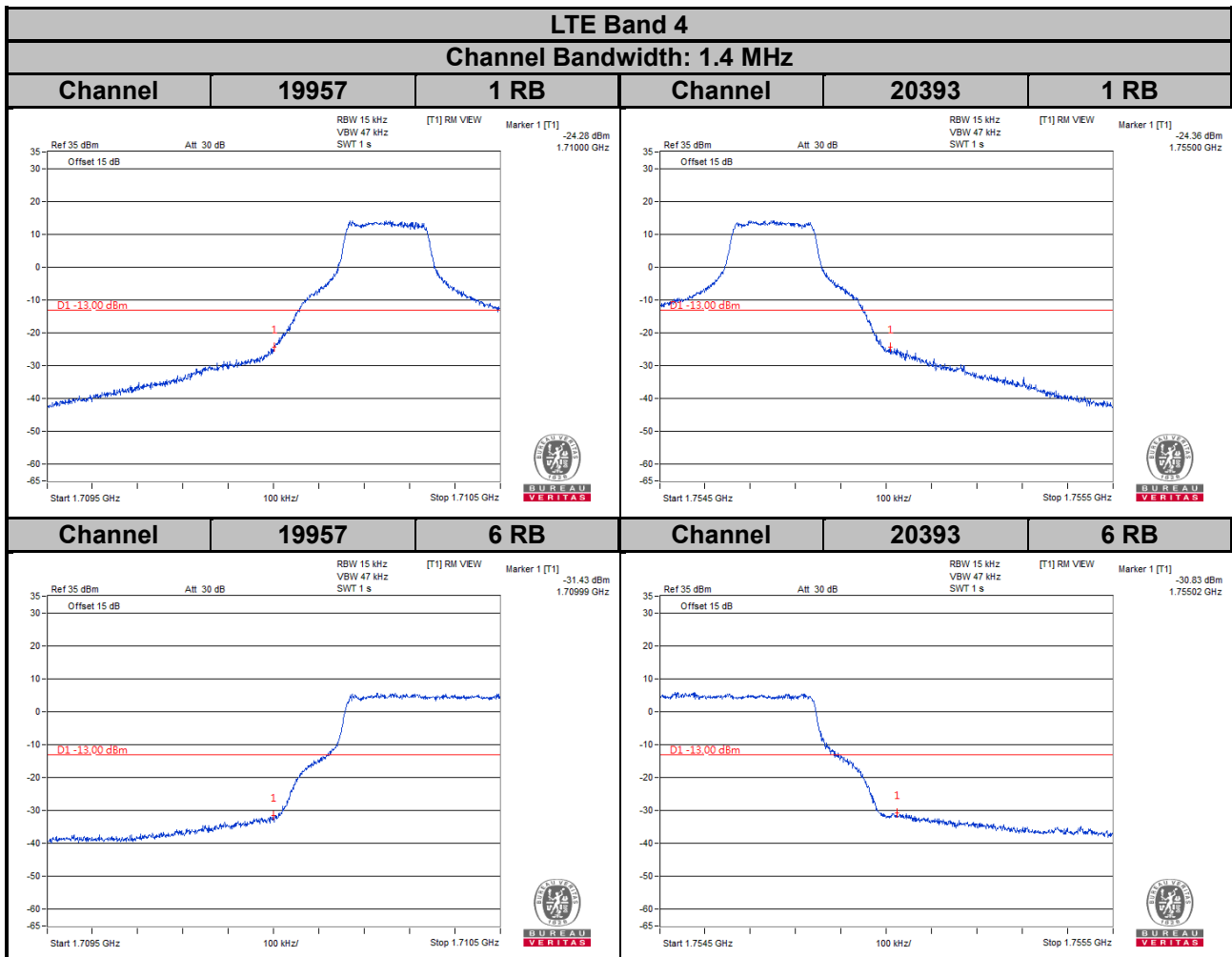
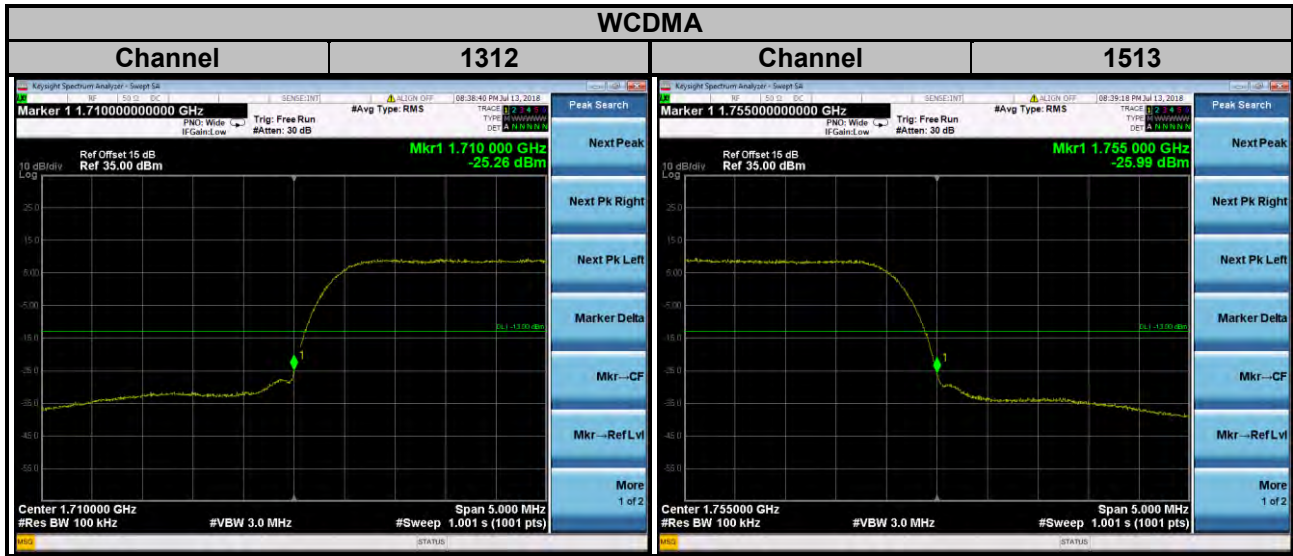

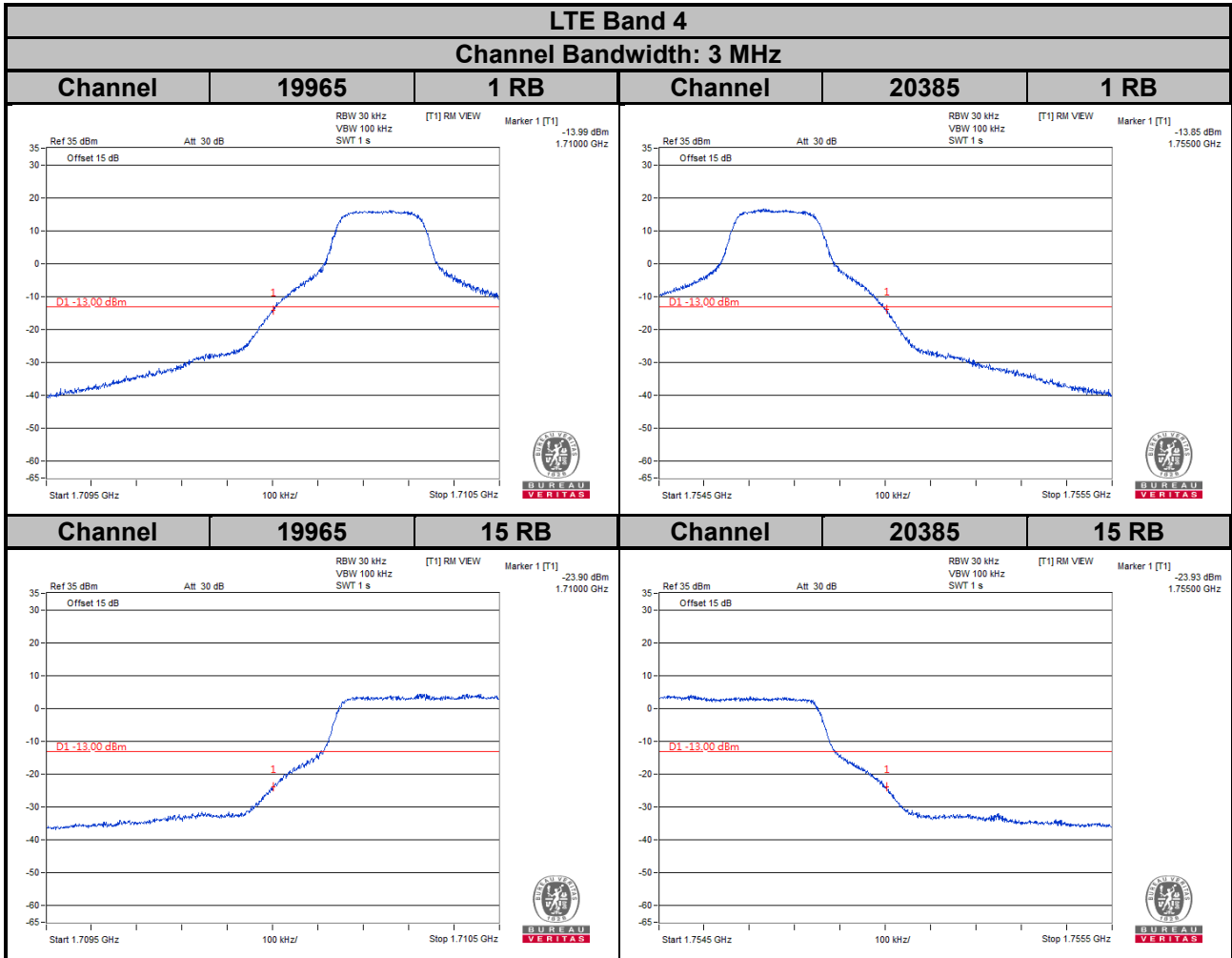

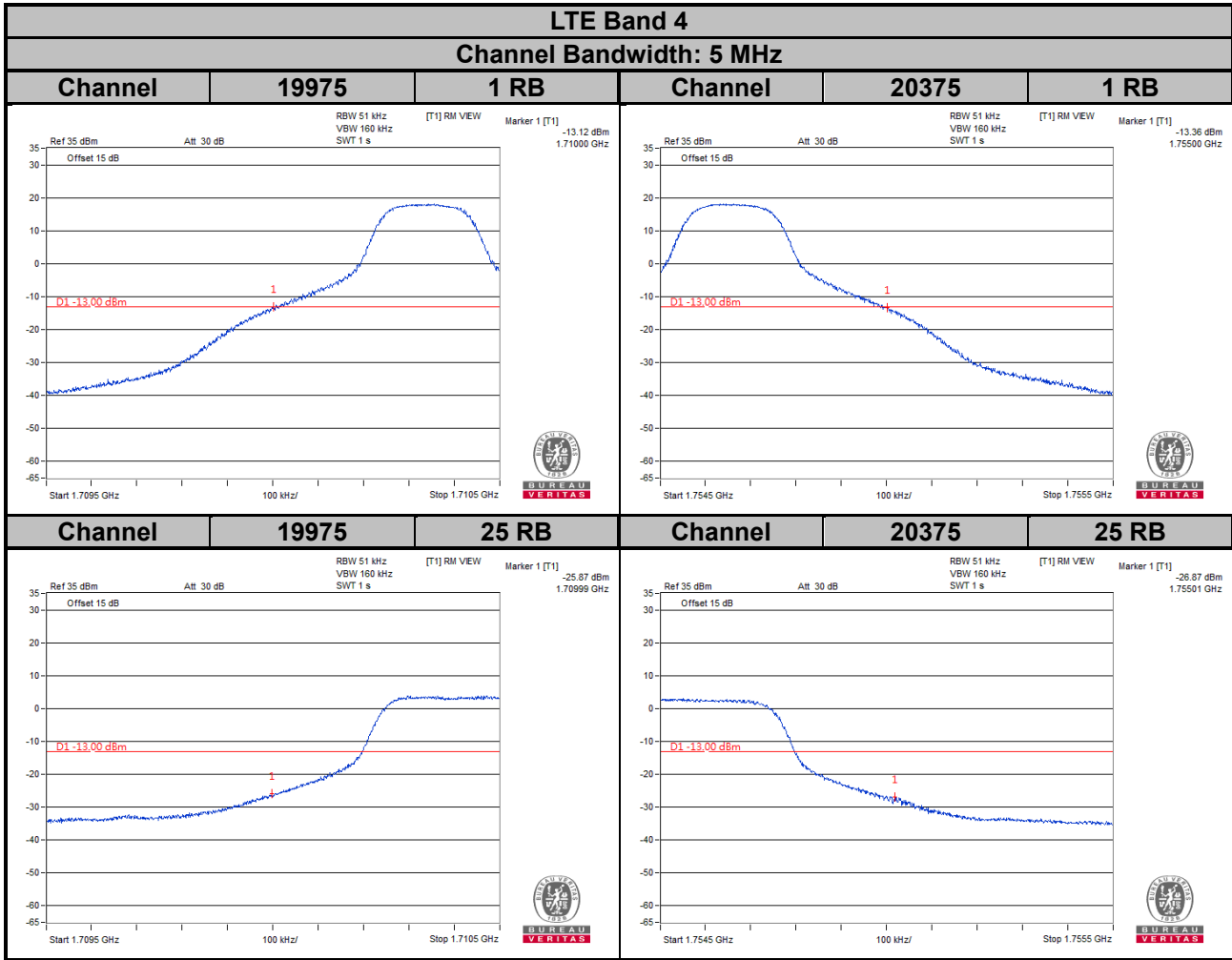

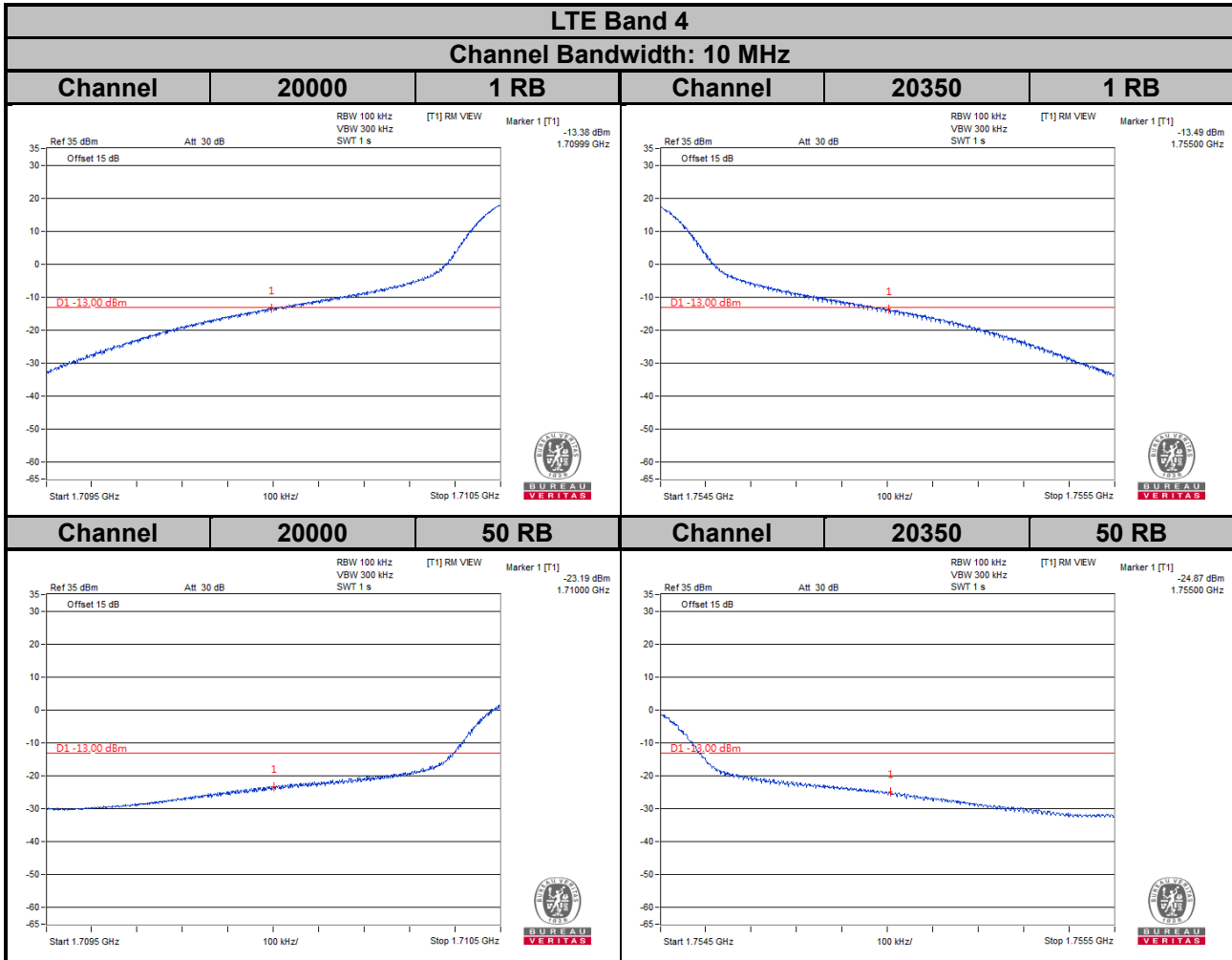

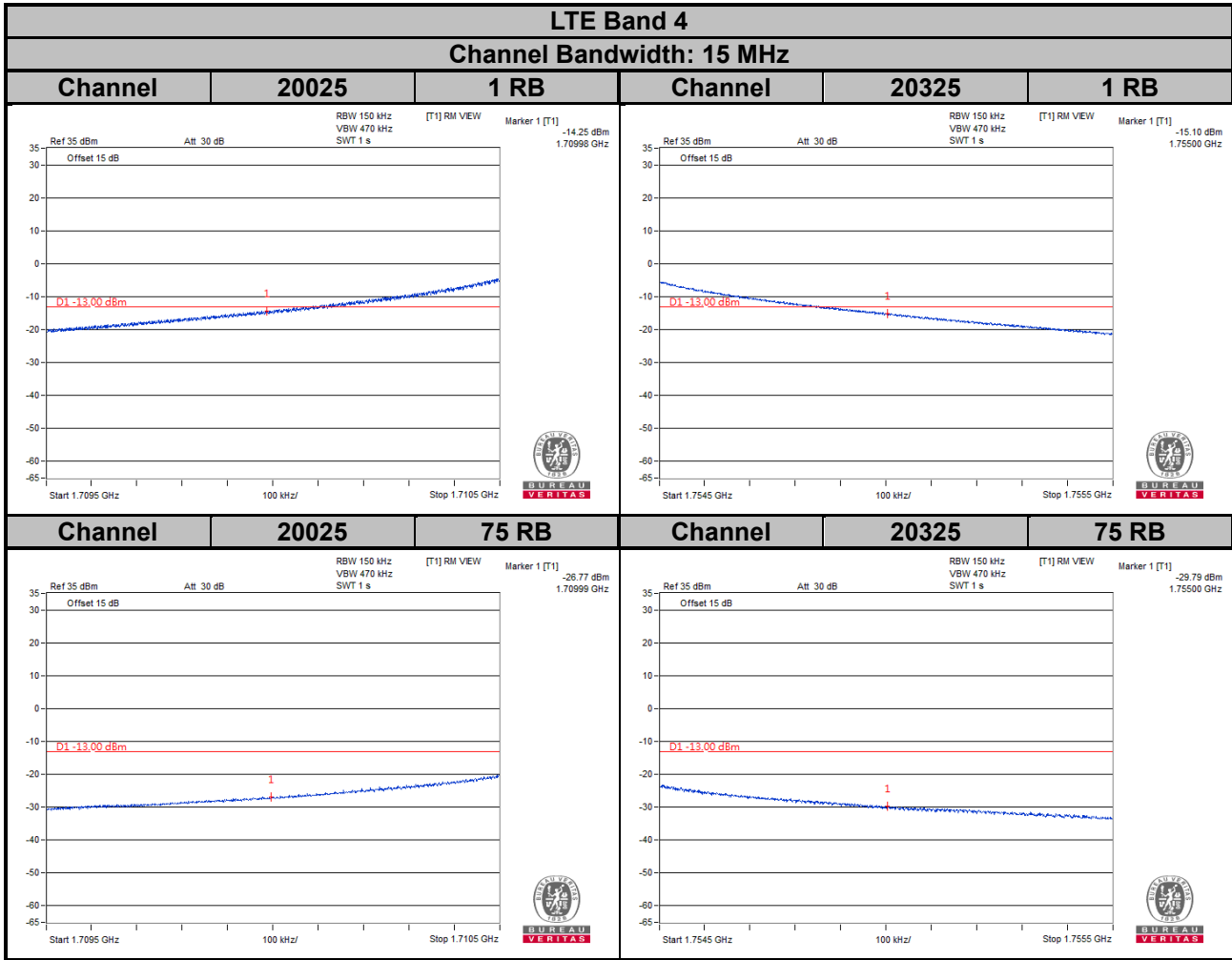

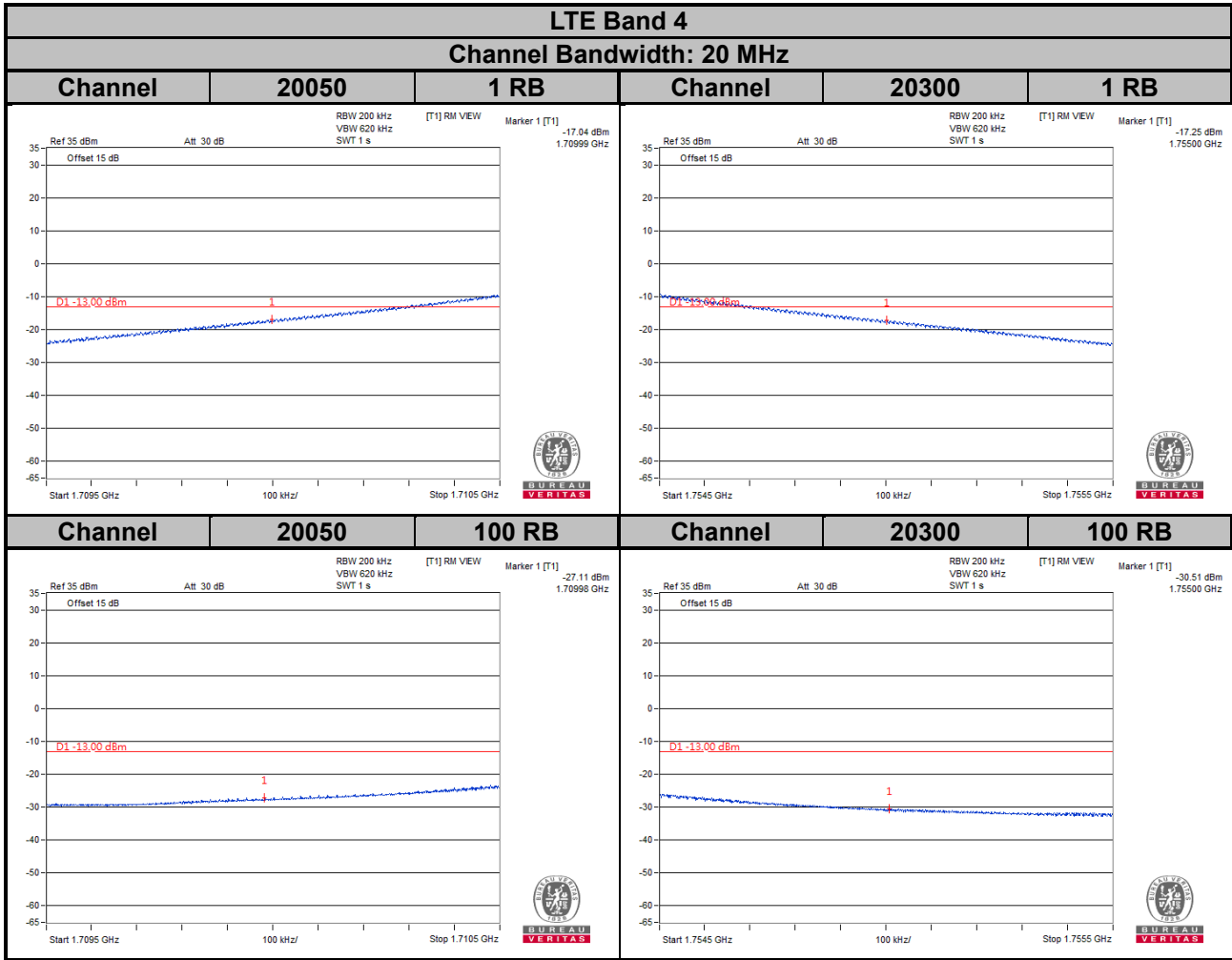

LTE Band 12
Channel Bandwidth: 1.4 MHz

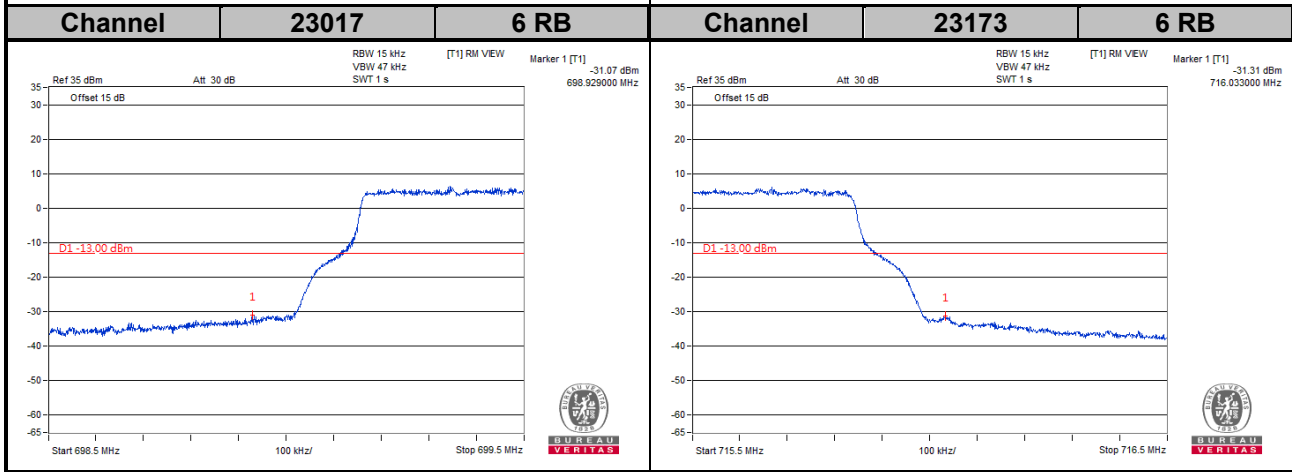
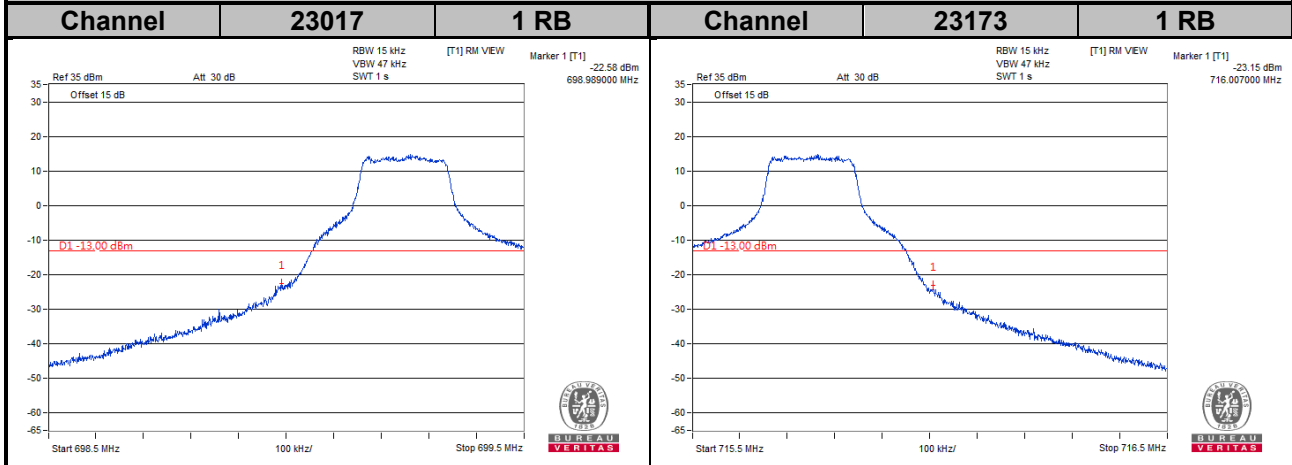

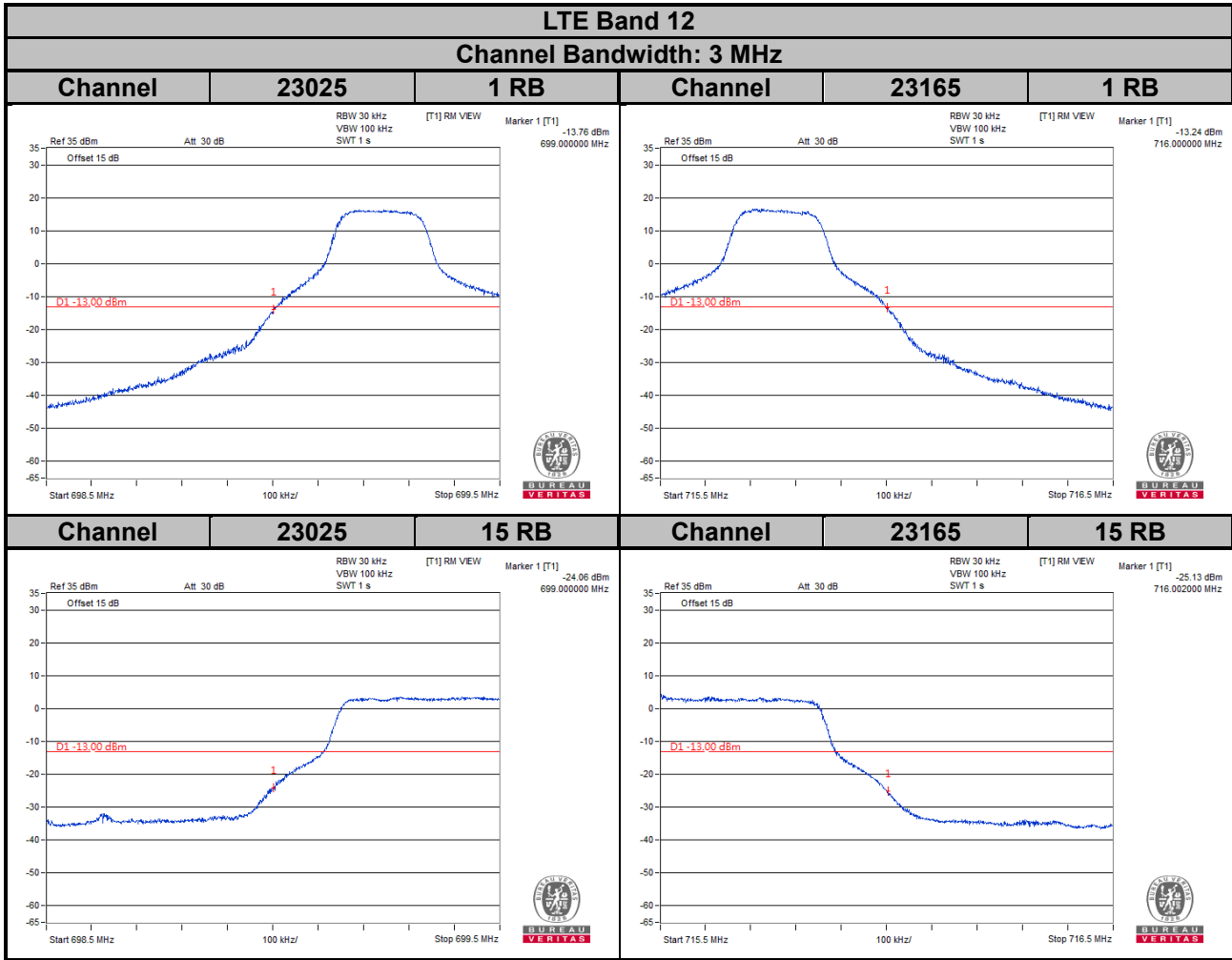

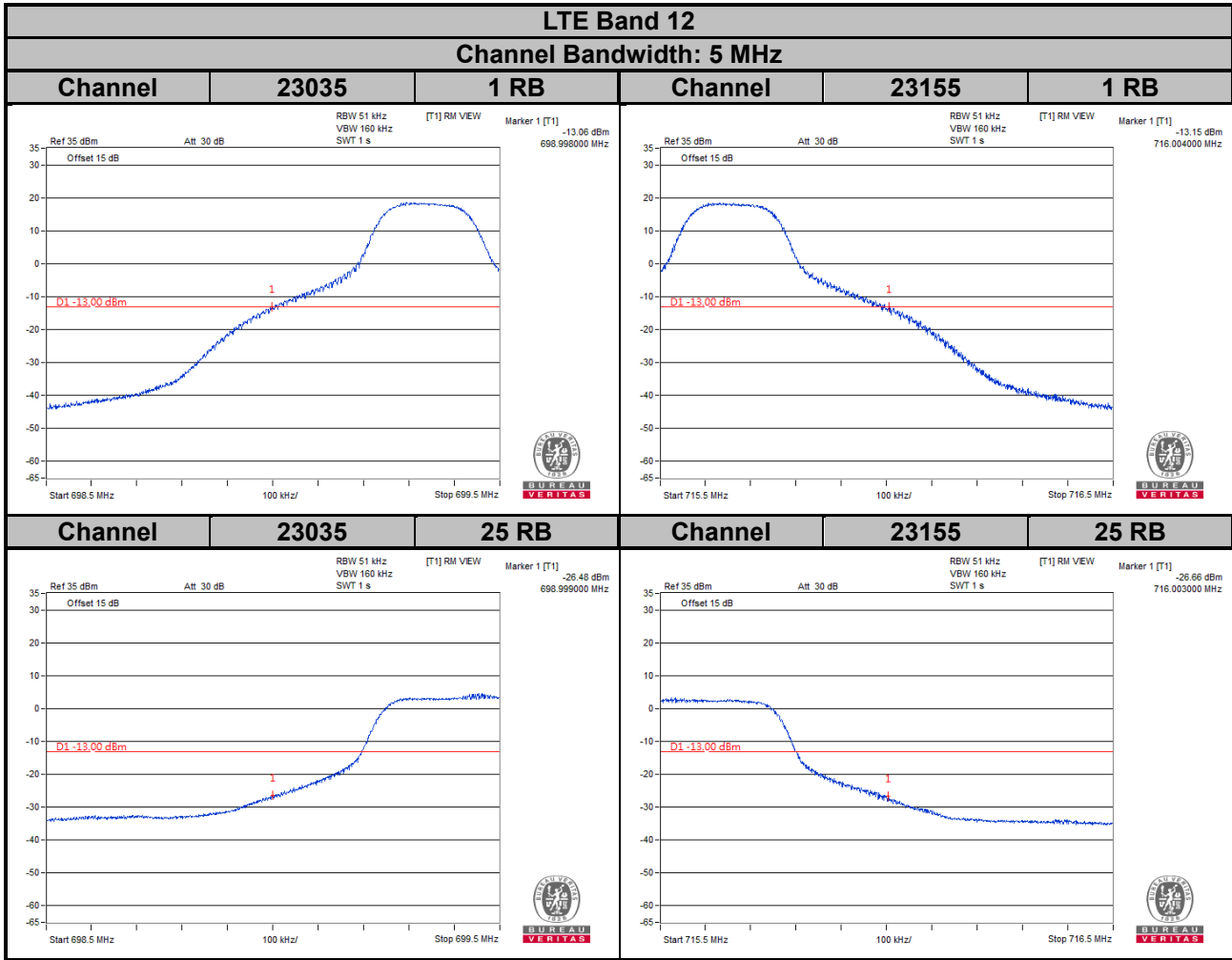

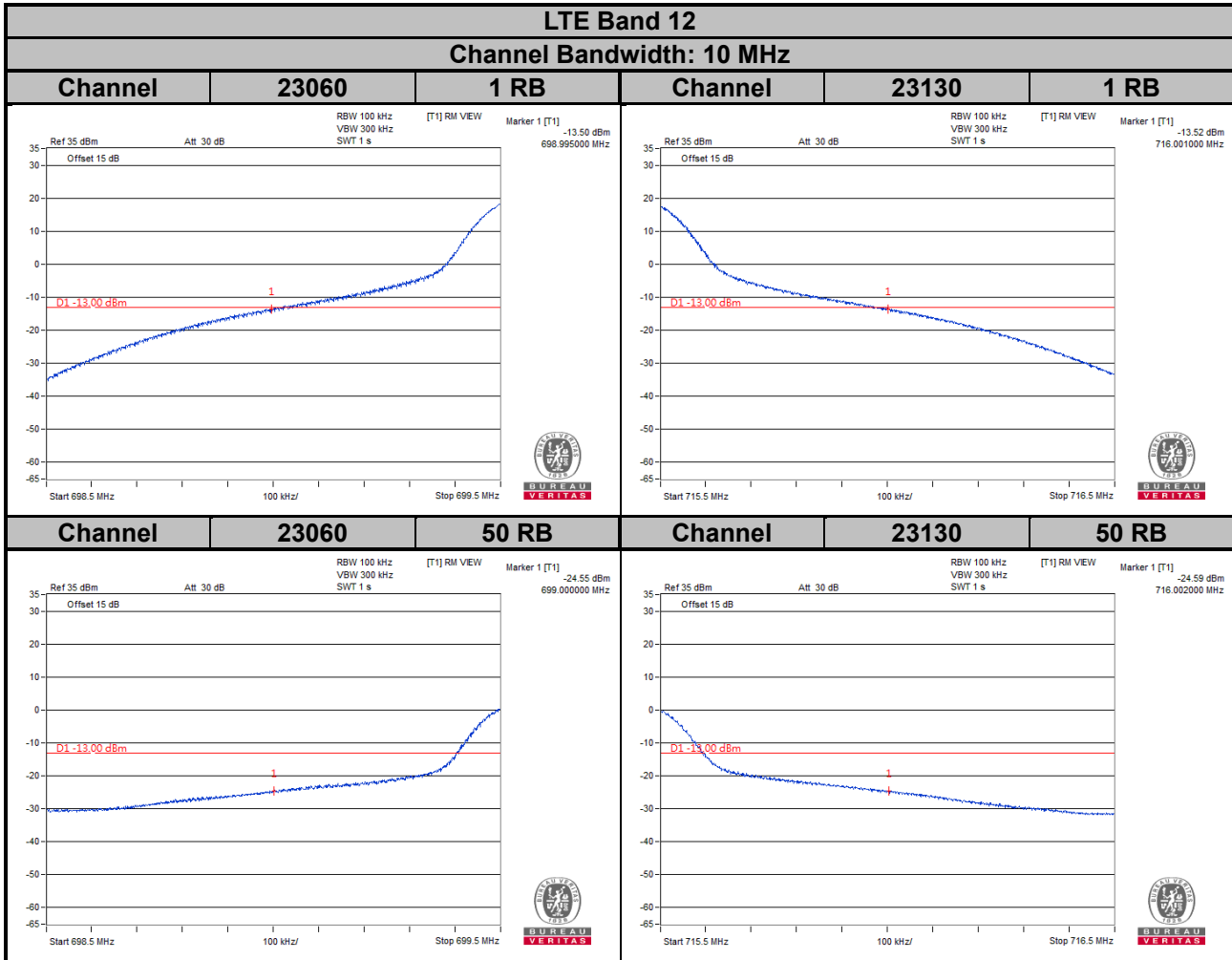

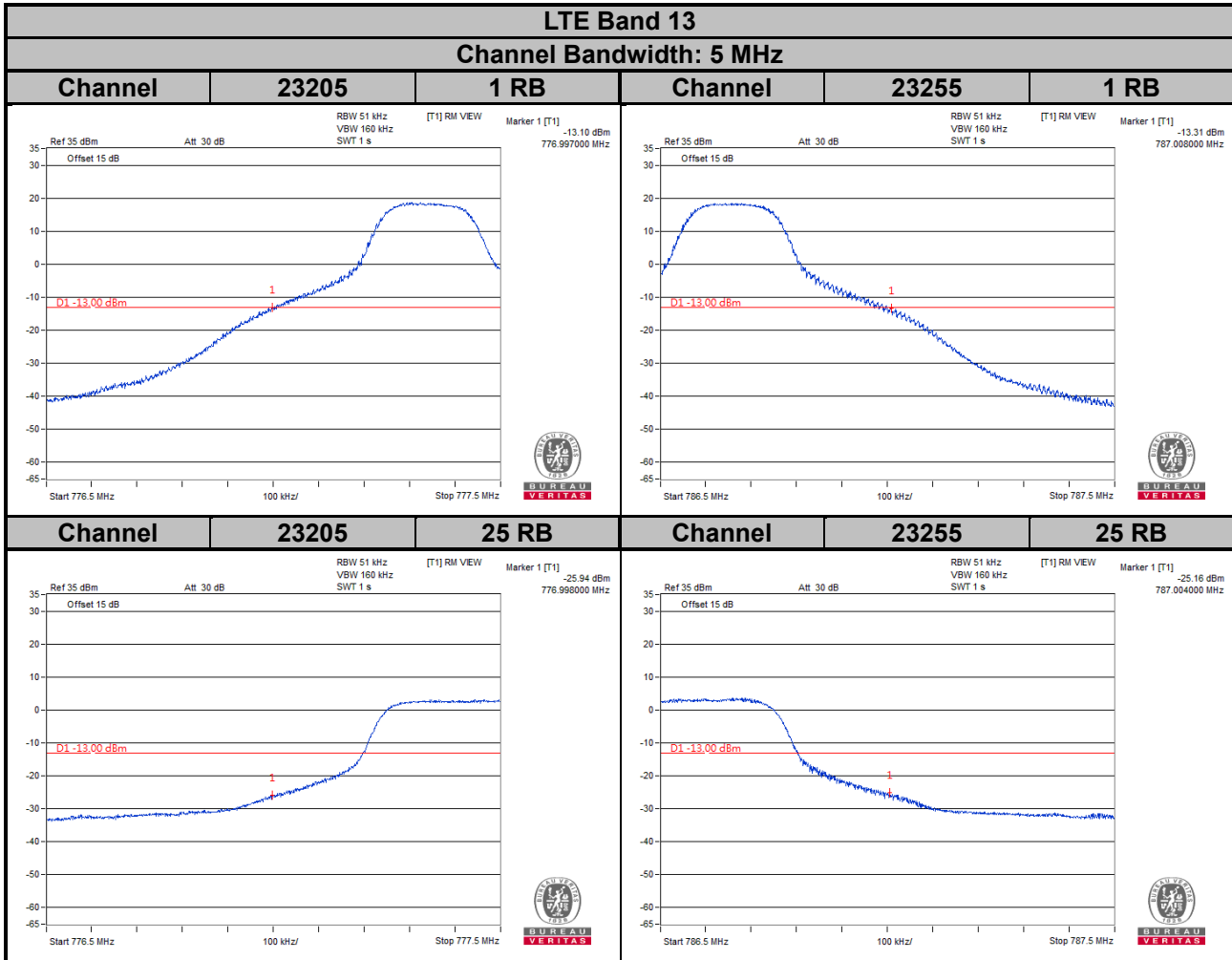

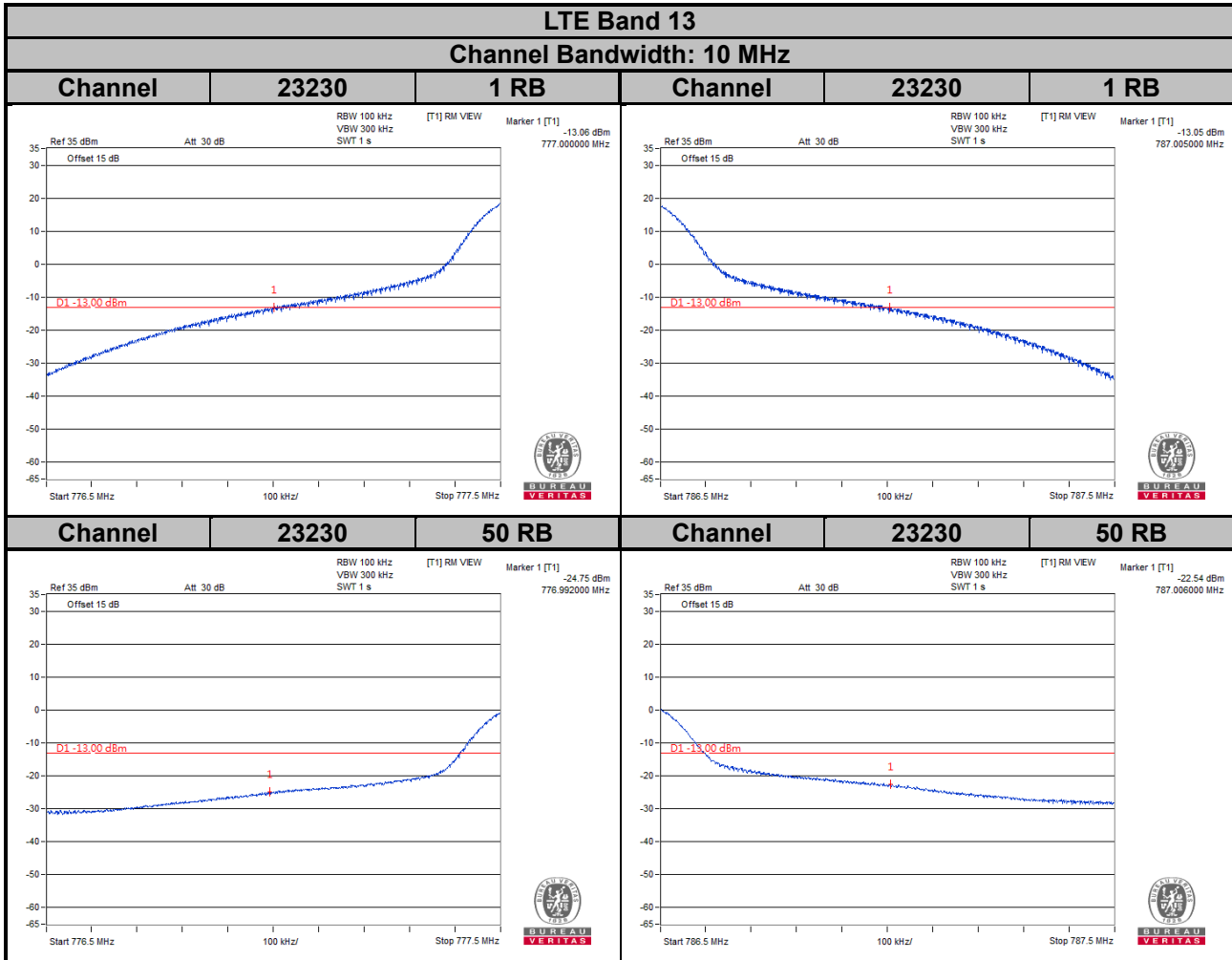

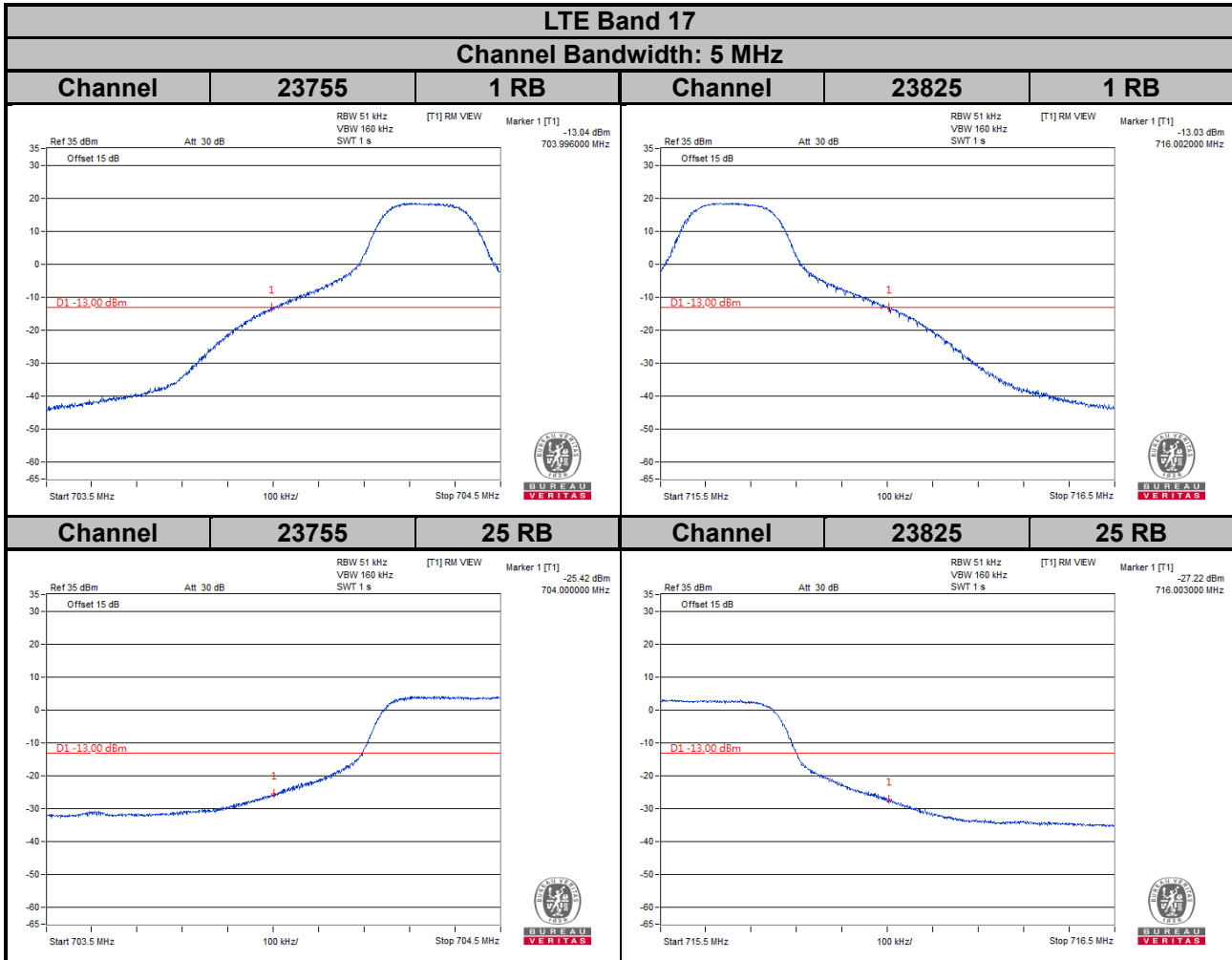

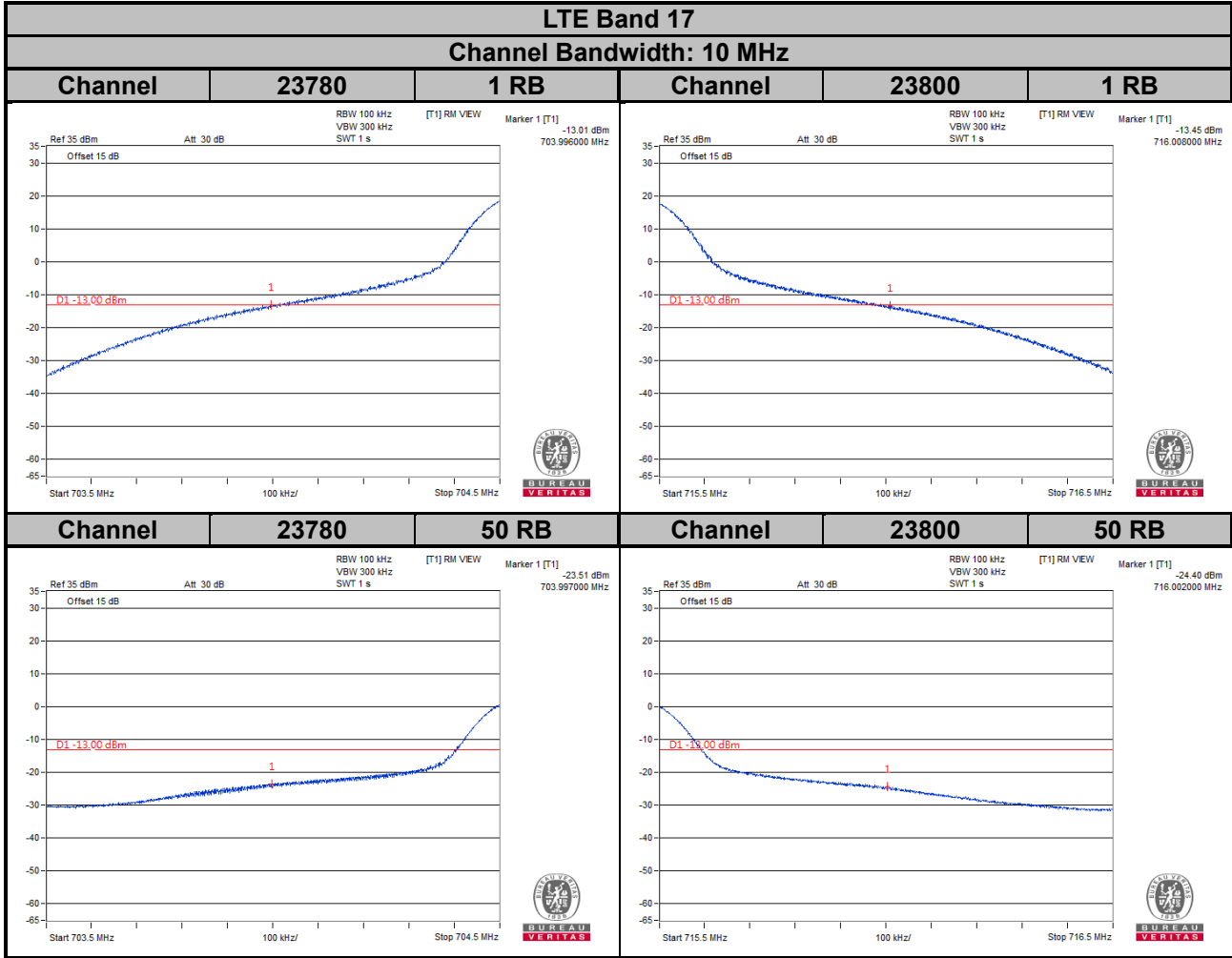

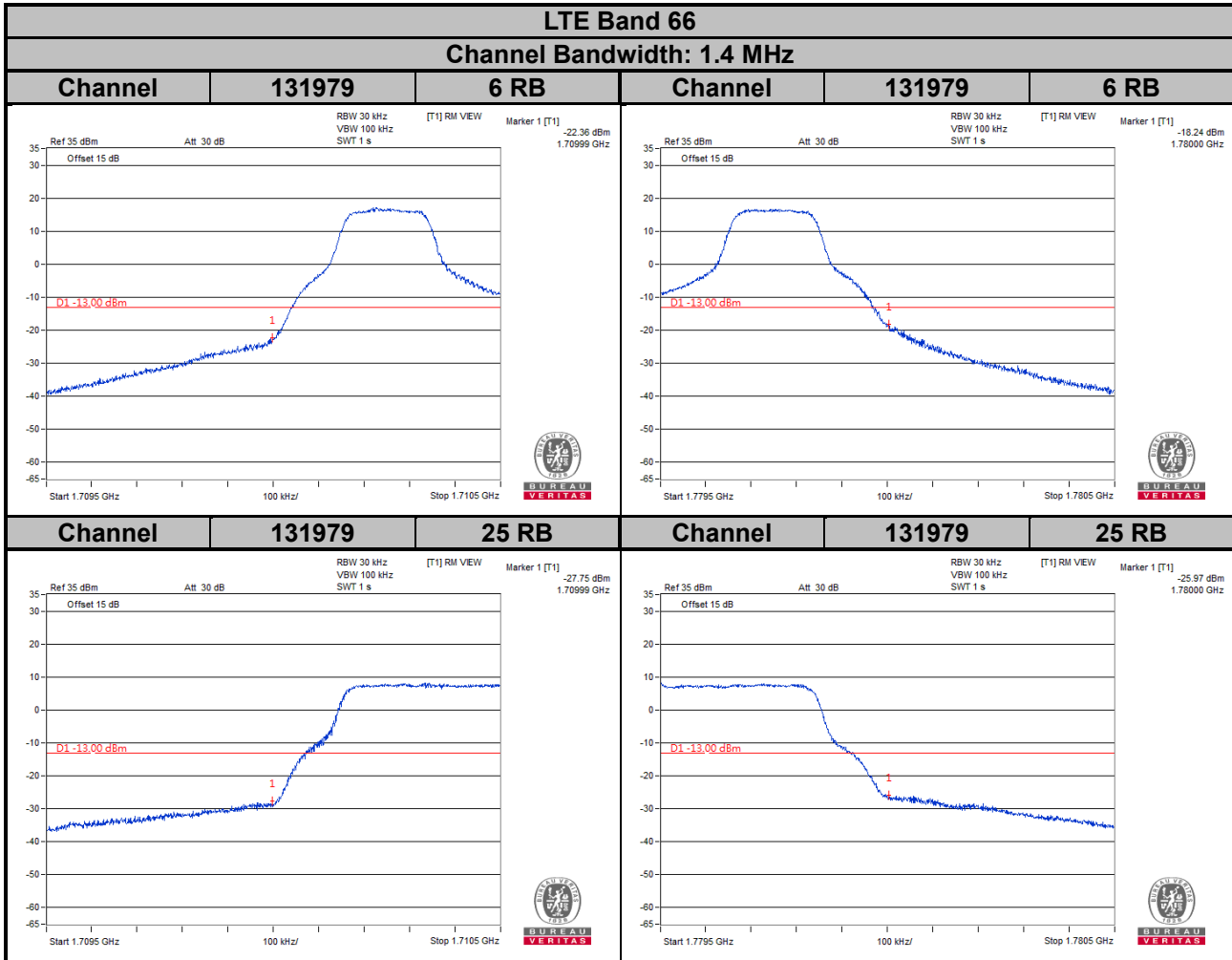

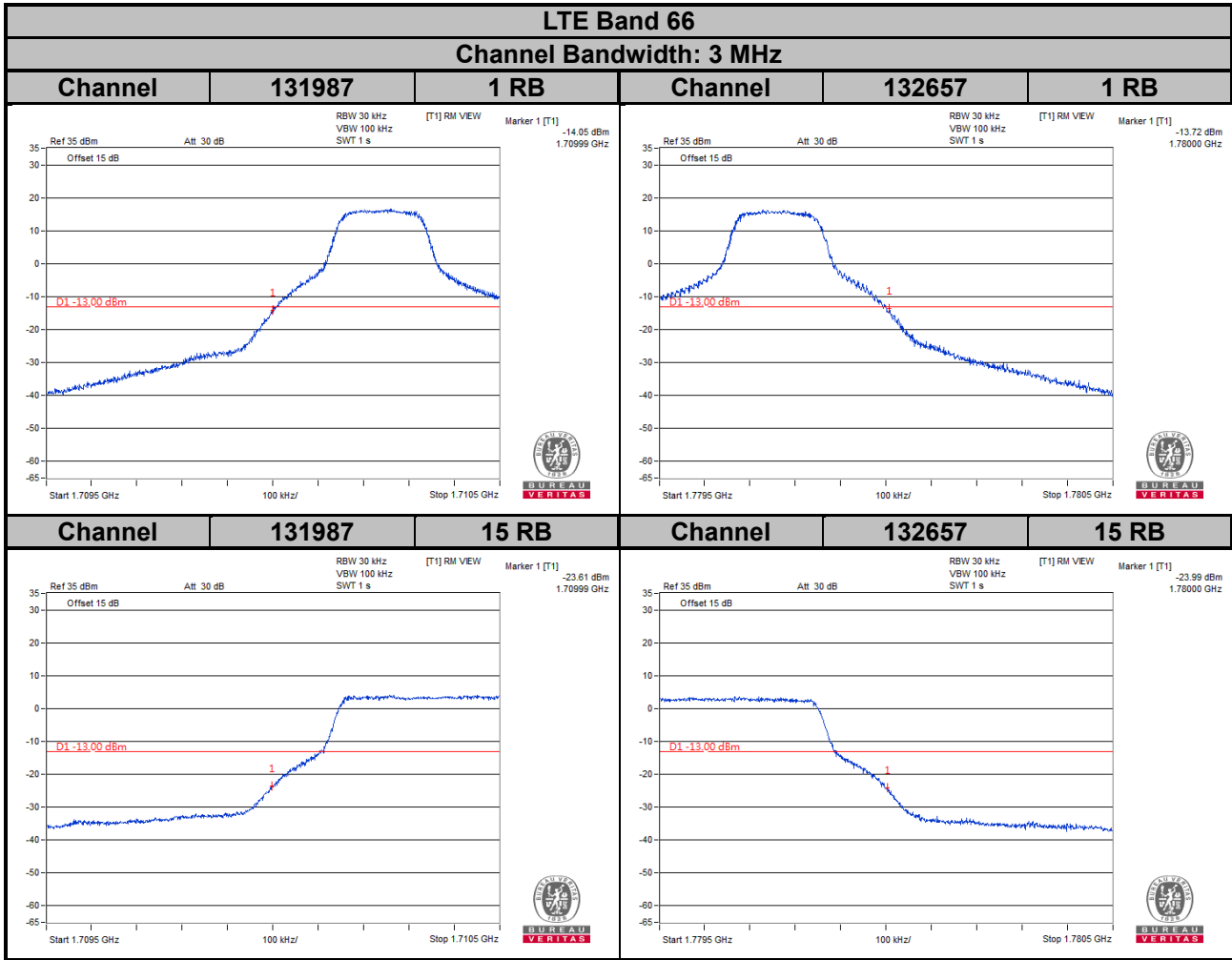

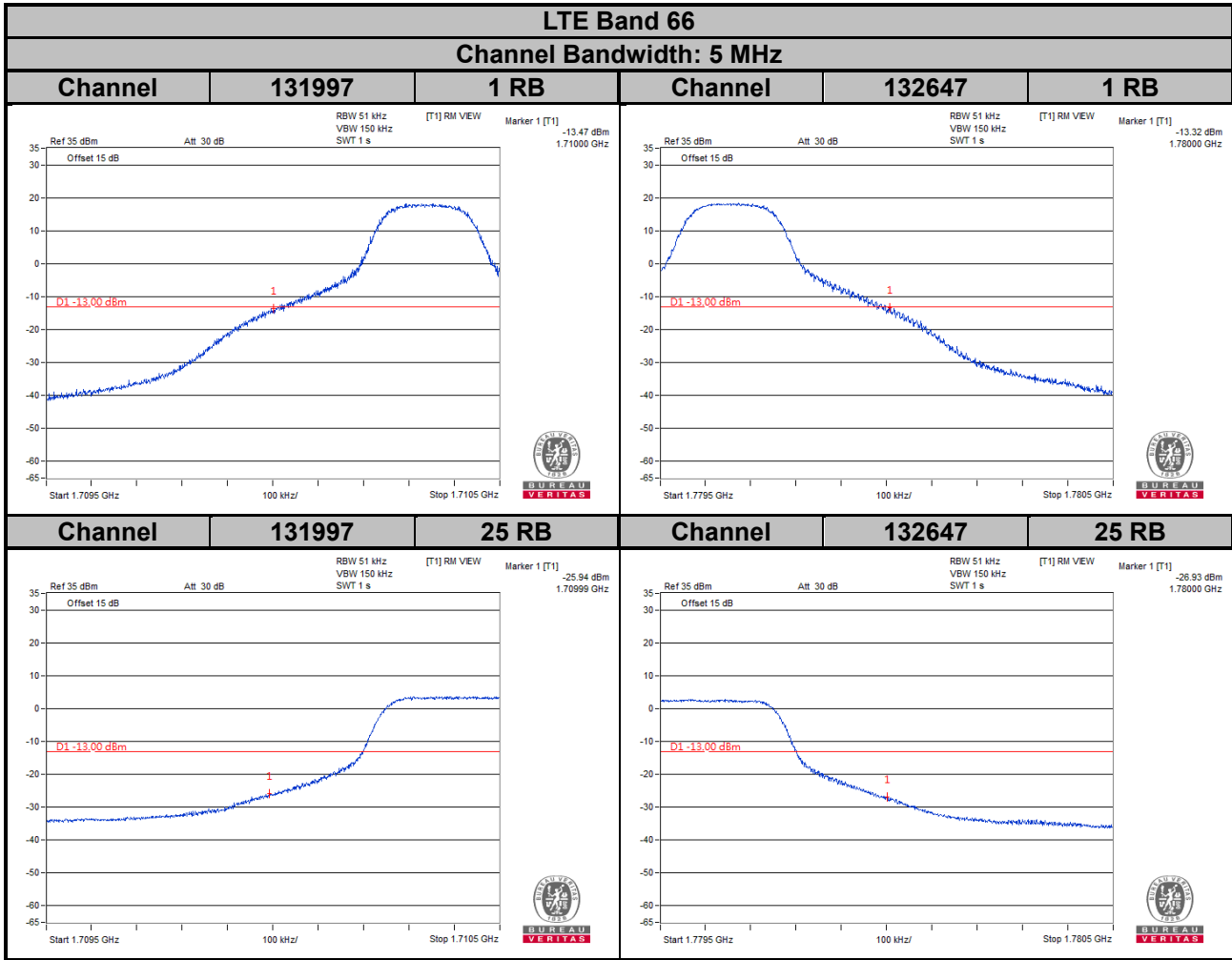

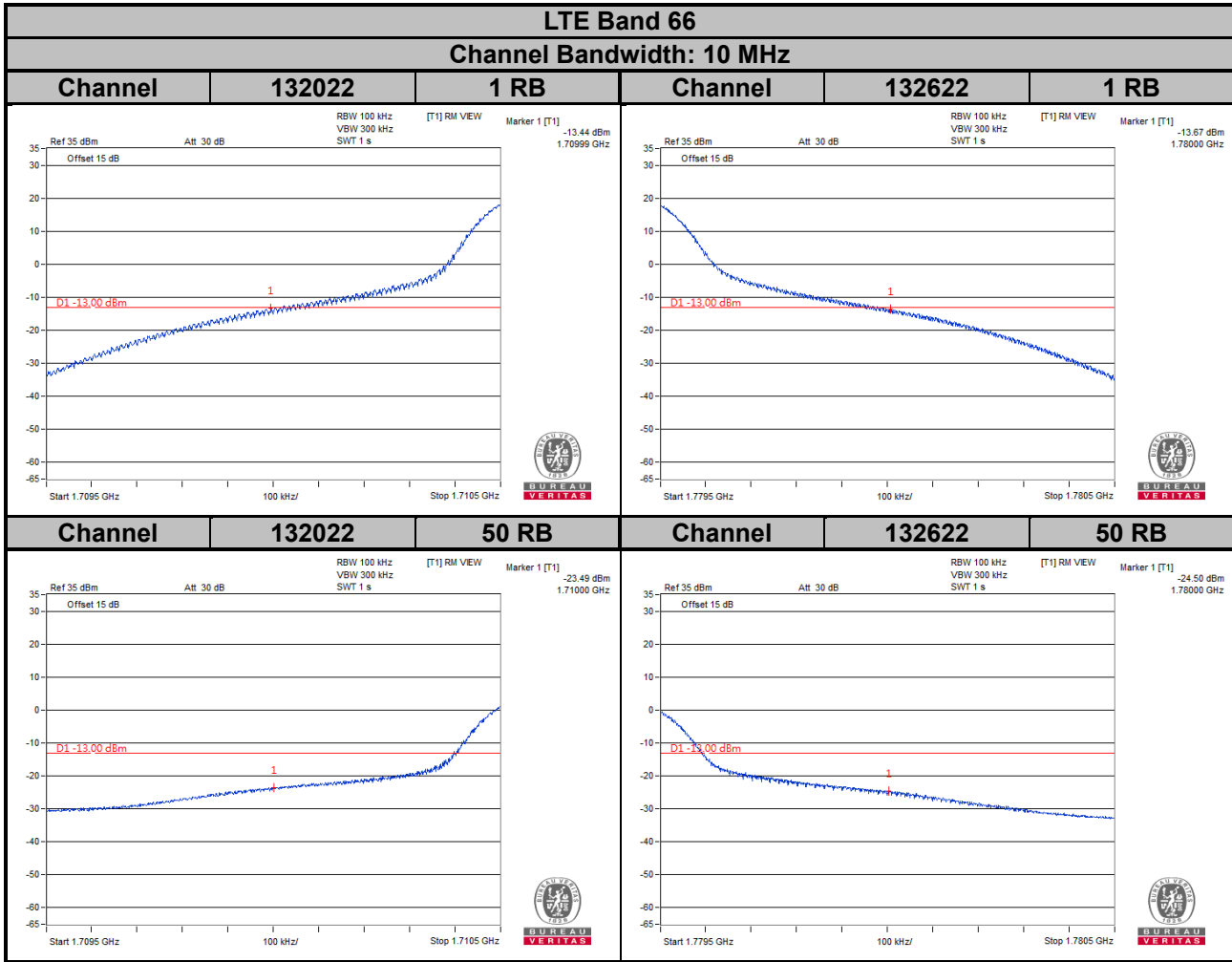

LTE Band 66
Channel Bandwidth: 15 MHz

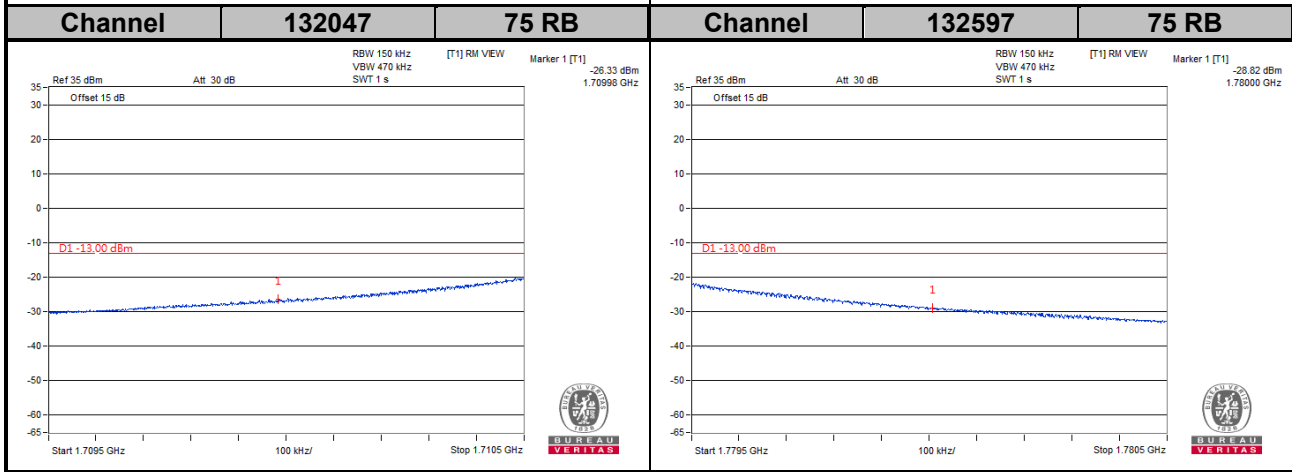
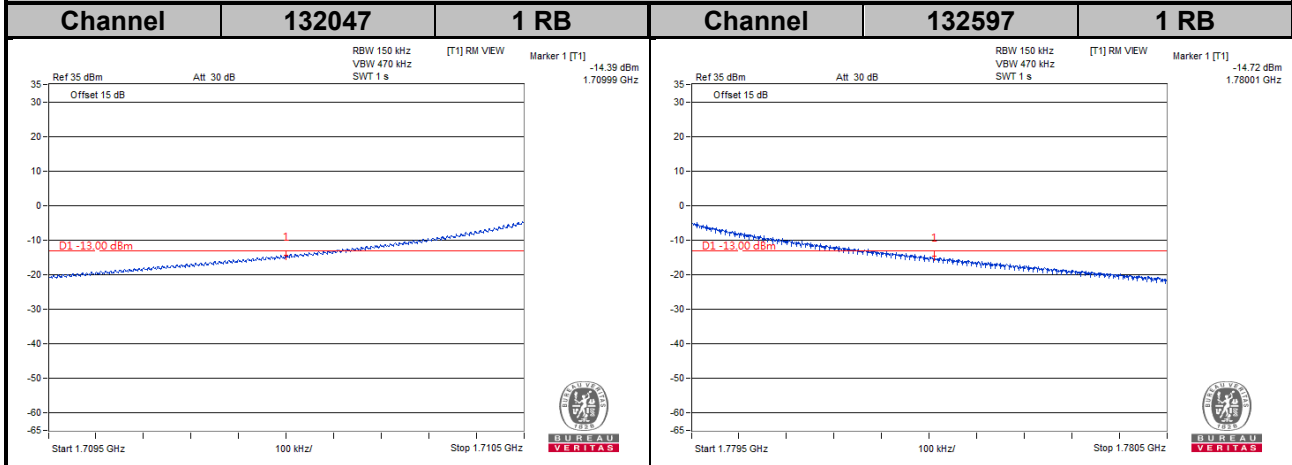

LTE Band 66
Channel Bandwidth: 20 MHz

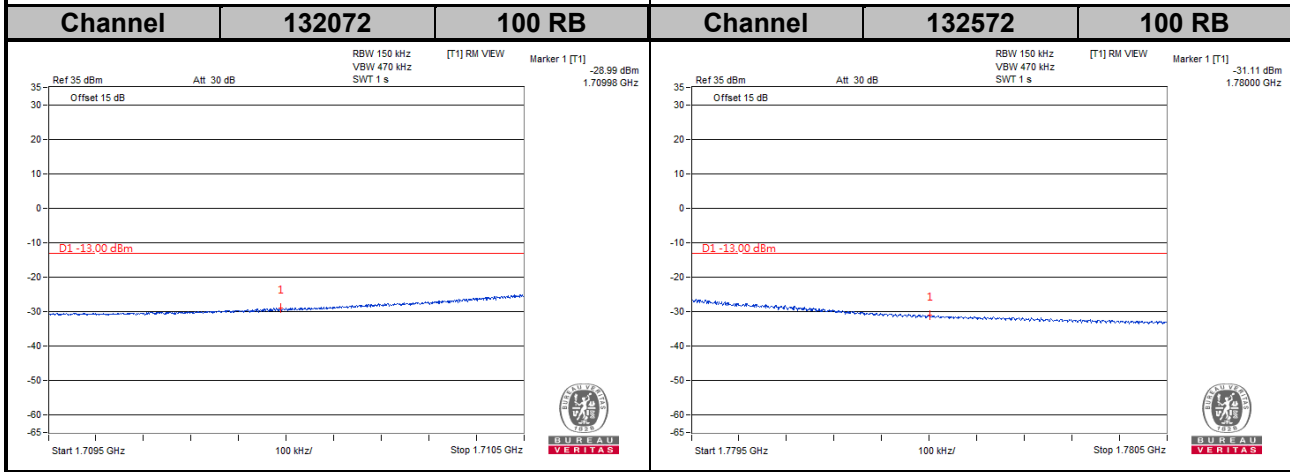
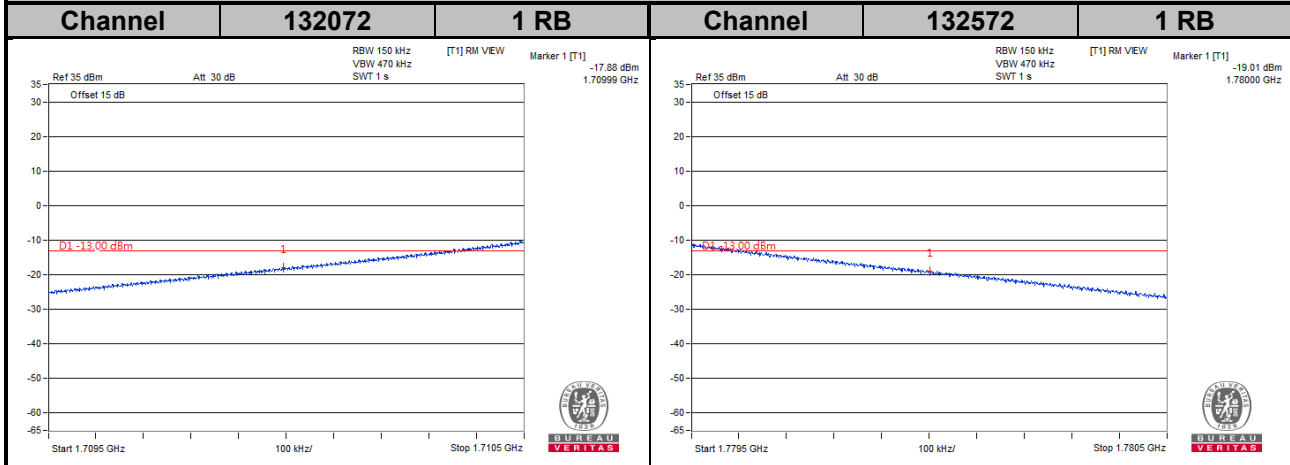

Emission Mask

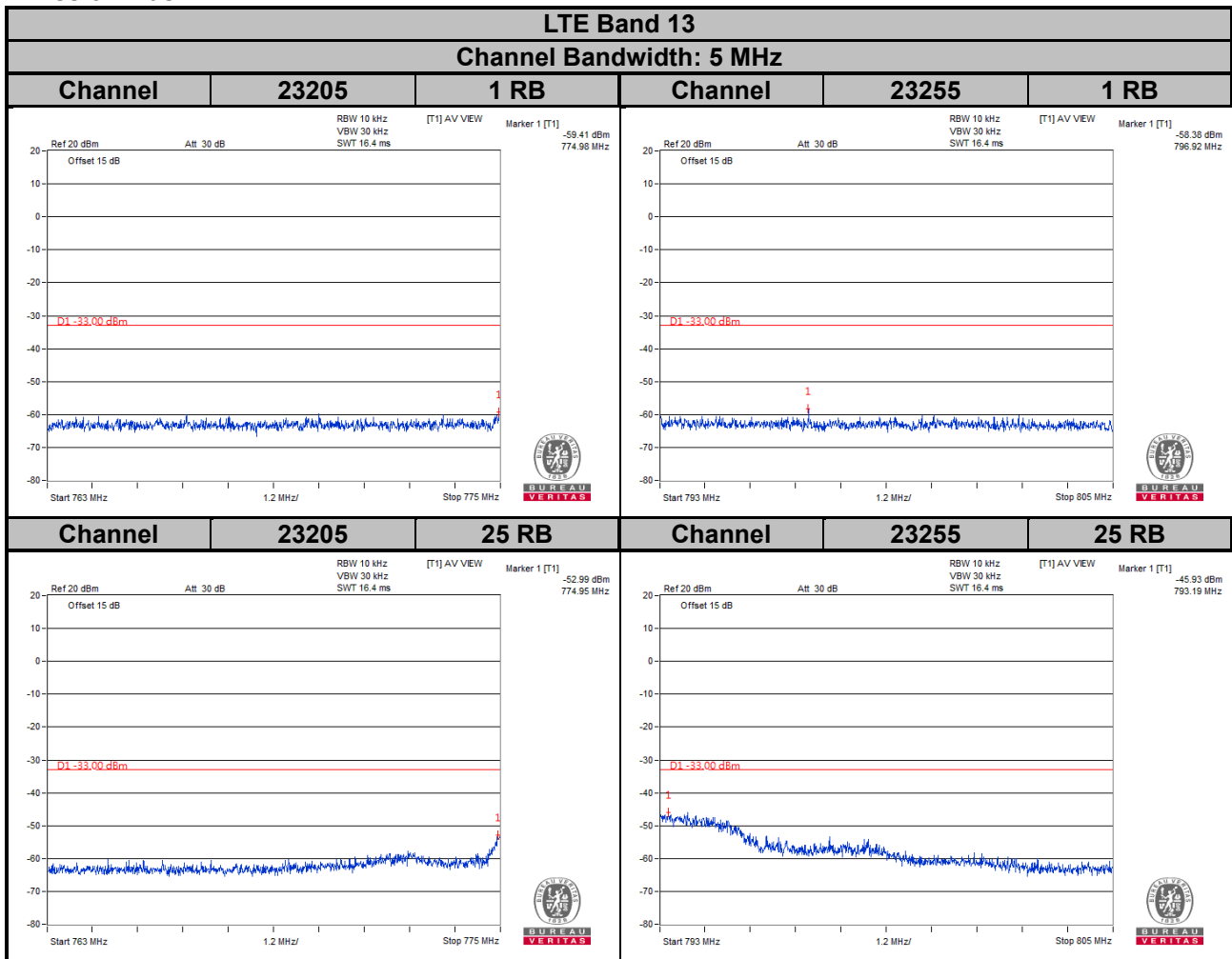

For the 763 - 775 MHz and 793 - 805 MHz band, the FCC limit is $65 + 10\log(P[\text{watt}])$ in a 6.25 kHz bandwidth. Since it was not possible to set the resolution bandwidth to 6.25 kHz with the available equipment, a bandwidth of 10 kHz was used instead to show compliance. By using a 10 kHz bandwidth on the spectrum analyzer.

$$10\log(10\text{kHz}/6.25\text{kHz}) = 2.04 \text{ dB}$$

$$\text{Limit line} = -35 \text{ dBm} + 2.04 \text{ dB} = -32.96 \text{ dBm}$$

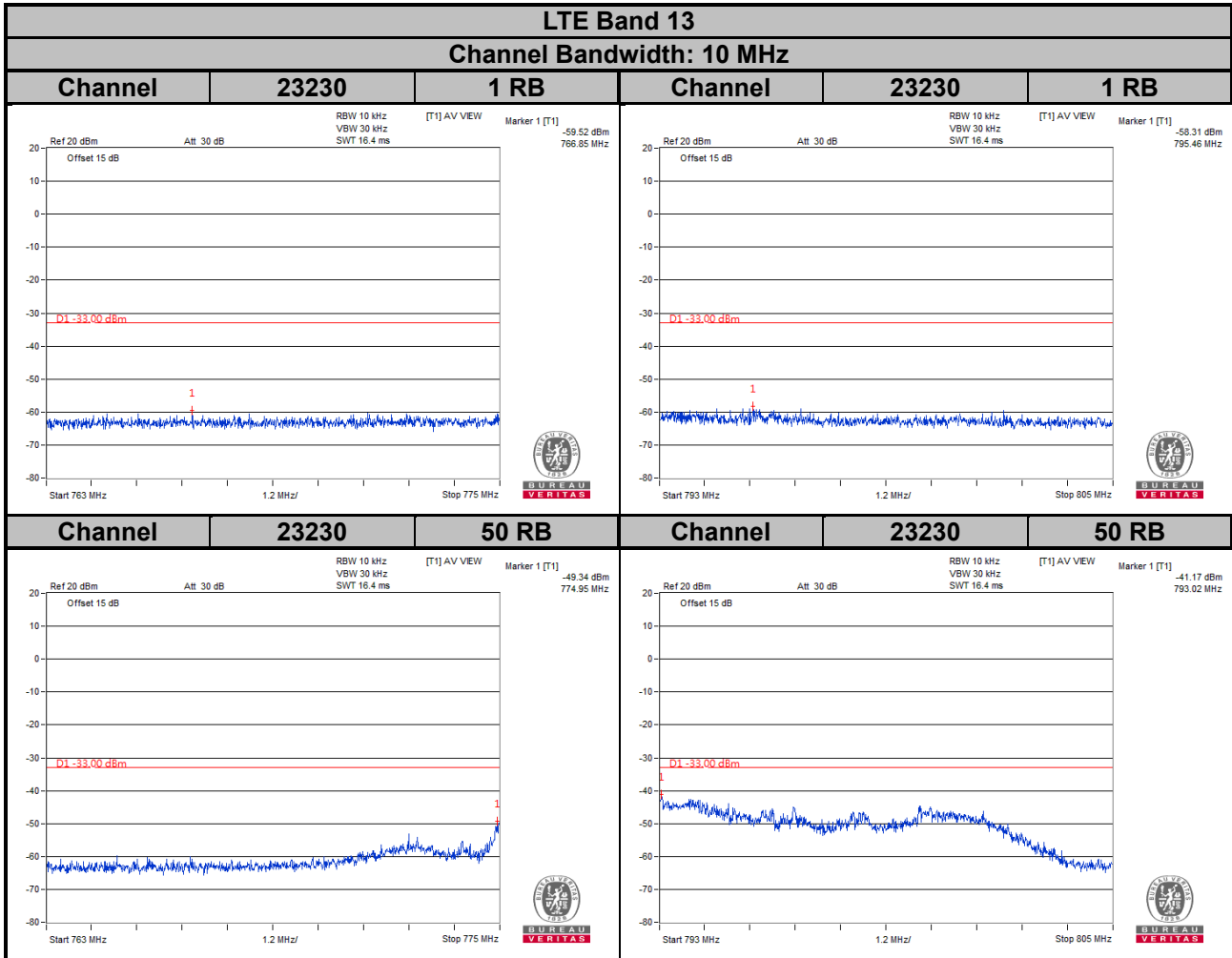

For the 763 - 775 MHz and 793 - 805 MHz band, the FCC limit is $65 + 10\log(P[\text{watt}])$ in a 6.25 kHz bandwidth. Since it was not possible to set the resolution bandwidth to 6.25 kHz with the available equipment, a bandwidth of 10 kHz was used instead to show compliance. By using a 10 kHz bandwidth on the spectrum analyzer.

$$10\log(10\text{kHz}/6.25\text{kHz}) = 2.04 \text{ dB}$$

$$\text{Limit line} = -35 \text{ dBm} + 2.04 \text{ dB} = -32.96 \text{ dBm}$$

4.6 Peak to Average Ratio

4.6.1 Limits of Peak to Average Ratio Measurement

In measuring transmissions in this band using an average power technique, the peak to-average ratio (PAR) of the transmission may not exceed 13 dB.

4.6.2 Test Setup

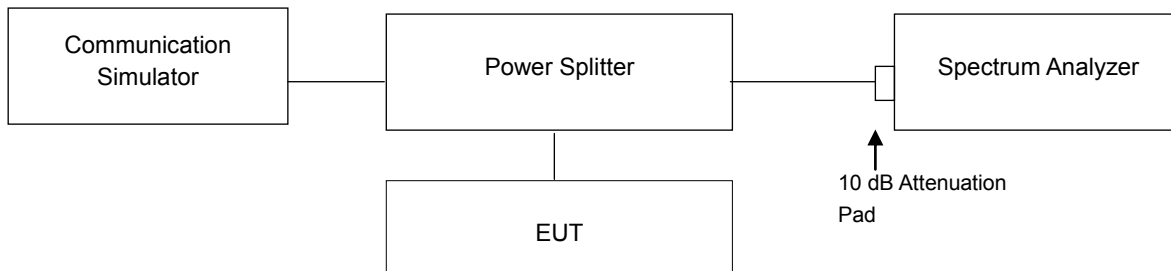

4.6.3 Test Procedures

1. Set resolution/measurement bandwidth \geq signal's occupied bandwidth;
2. Set the number of counts to a value that stabilizes the measured CCDF curve;
3. Record the maximum PAPR level associated with a probability of 0.1 %.

4.6.4 Test Results

WCDMA		
Channel	Frequency (MHz)	Peak to Average Ratio (dB)
1312	1712.4	3.39
1413	1732.6	3.42
1513	1752.6	3.38

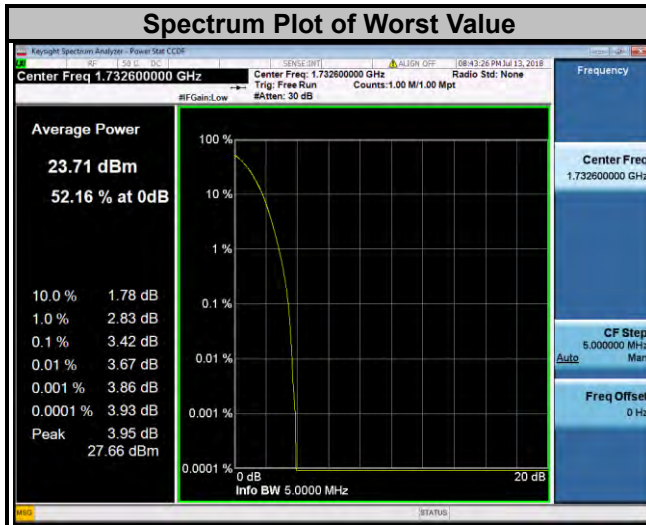

LTE Band 4							
Channel Bandwidth: 1.4 MHz				Channel Bandwidth: 3 MHz			
Channel	Frequency (MHz)	Peak to Average Ratio (dB)		Channel	Frequency (MHz)	Peak to Average Ratio (dB)	
		QPSK	16QAM			QPSK	16QAM
19957	1710.7	5.13	5.24	19965	1711.5	5.21	5.32
20175	1732.5	5.72	6.08	20175	1732.5	5.84	6.14
20393	1754.3	5.52	5.66	20385	1753.5	5.60	5.70

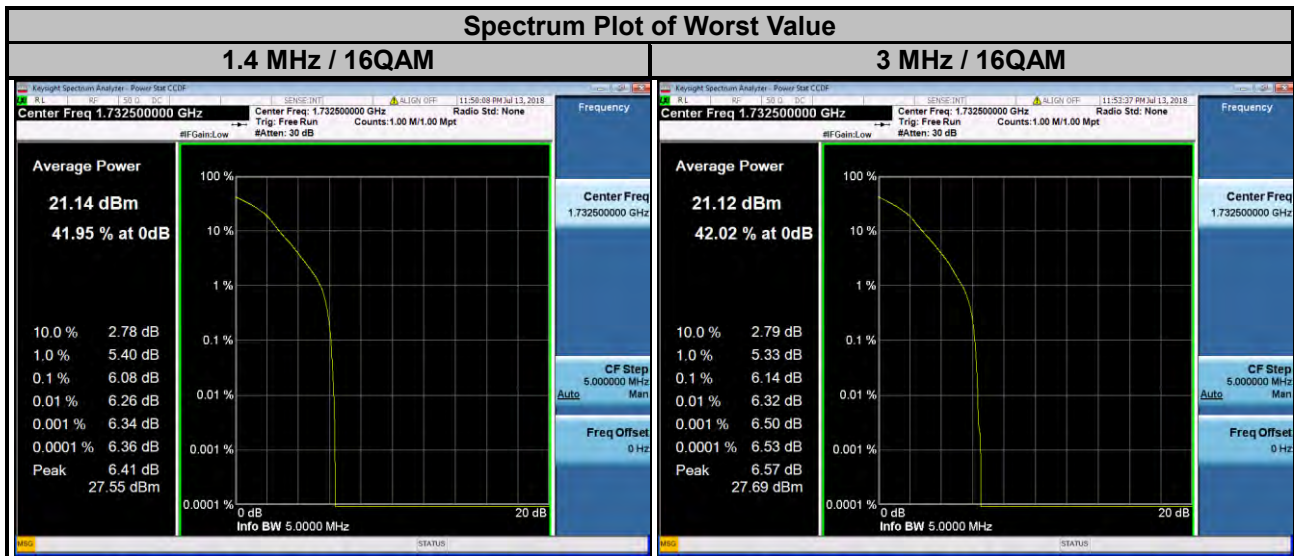

LTE Band 4

Channel Bandwidth: 5 MHz				Channel Bandwidth: 10 MHz			
Channel	Frequency (MHz)	Peak to Average Ratio (dB)		Channel	Frequency (MHz)	Peak to Average Ratio (dB)	
		QPSK	16QAM			QPSK	16QAM
19975	1712.5	5.17	5.26	20000	1715.0	5.14	5.33
20175	1732.5	5.74	6.04	20175	1732.5	5.75	6.01
20375	1752.5	5.53	5.61	20350	1750.0	5.45	5.55

Spectrum Plot of Worst Value

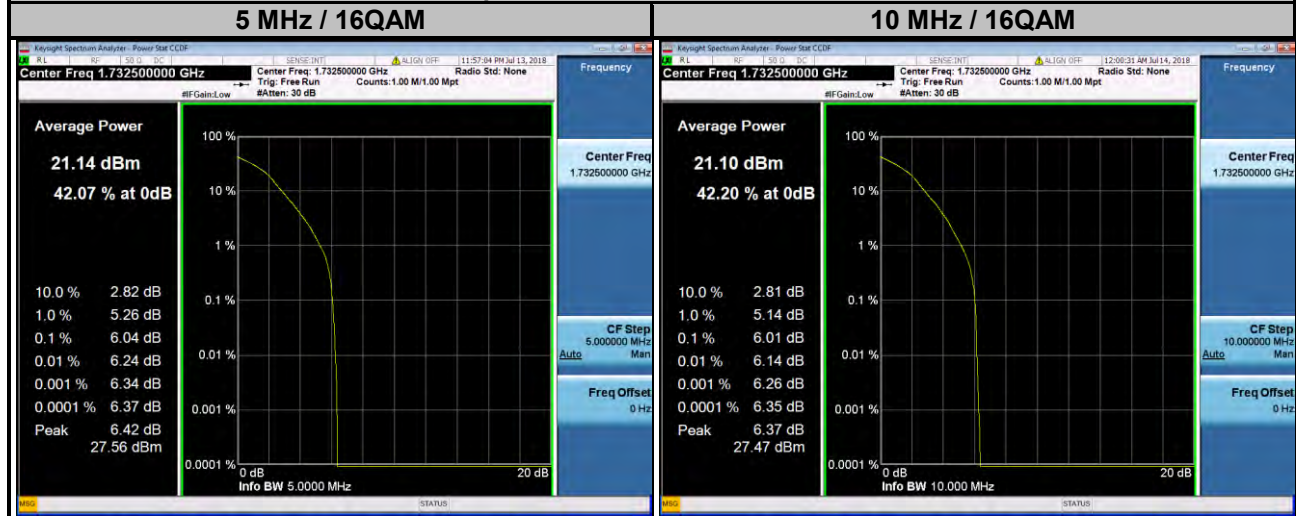

LTE Band 4							
Channel Bandwidth: 15 MHz				Channel Bandwidth: 20 MHz			
Channel	Frequency (MHz)	Peak to Average Ratio (dB)		Channel	Frequency (MHz)	Peak to Average Ratio (dB)	
		QPSK	16QAM			QPSK	16QAM
20025	1717.5	5.20	5.30	20050	1720.0	5.18	5.26
20175	1732.5	5.66	6.17	20175	1732.5	5.80	6.02
20325	1747.5	5.62	5.76	20300	1745.0	5.76	5.86

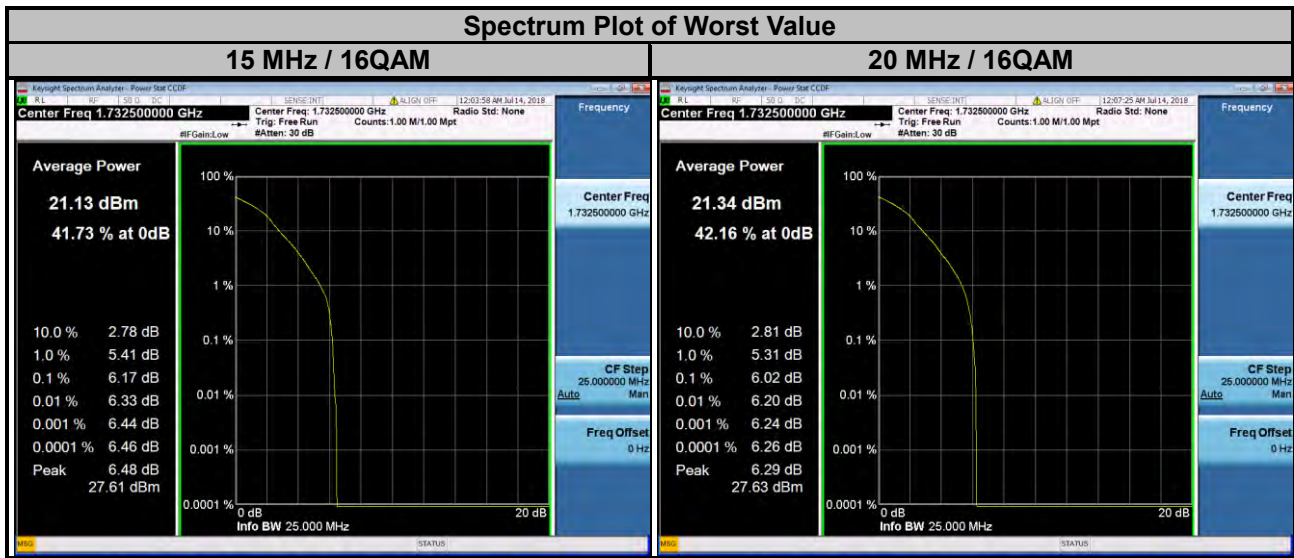

LTE Band 12

Channel Bandwidth: 1.4 MHz				Channel Bandwidth: 3 MHz			
Channel	Frequency (MHz)	Peak to Average Ratio (dB)		Channel	Frequency (MHz)	Peak to Average Ratio (dB)	
		QPSK	16QAM			QPSK	16QAM
23017	699.7	4.56	5.38	23025	700.5	4.60	5.57
23095	707.5	4.67	5.63	23095	707.5	4.81	5.64
23173	715.3	4.79	5.62	23165	714.5	4.82	5.66

Spectrum Plot of Worst Value

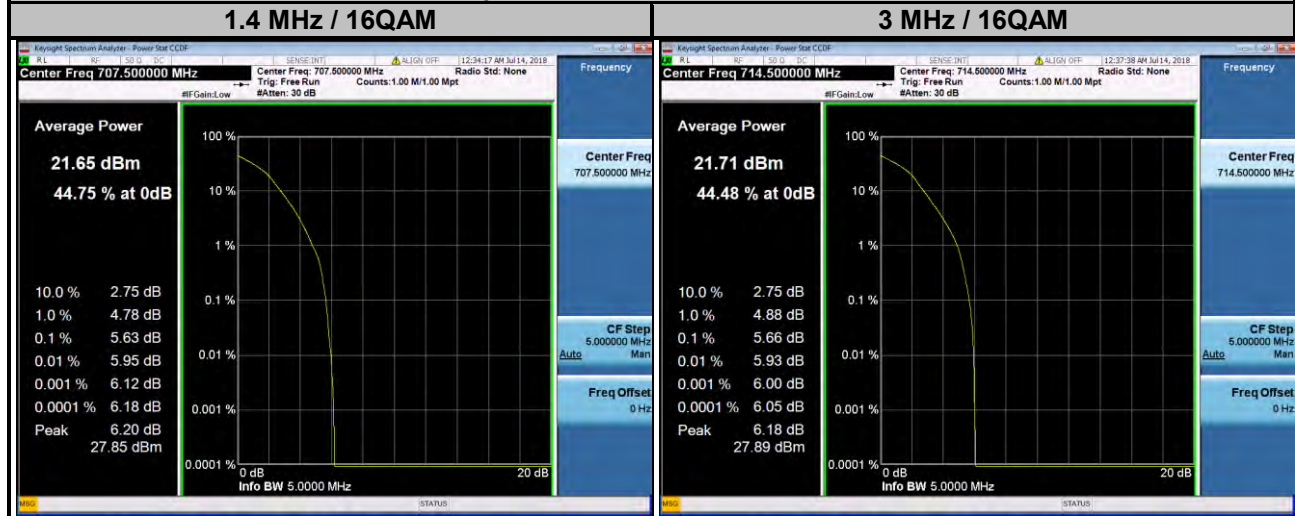

LTE Band 12

Channel Bandwidth: 5 MHz				Channel Bandwidth: 10 MHz			
Channel	Frequency (MHz)	Peak to Average Ratio (dB)		Channel	Frequency (MHz)	Peak to Average Ratio (dB)	
		QPSK	16QAM			QPSK	16QAM
23035	701.5	4.58	5.51	23060	704.0	4.55	5.50
23095	707.5	4.81	5.79	23095	707.5	4.65	5.62
23155	713.5	4.69	5.53	23130	711.0	4.65	5.58

Spectrum Plot of Worst Value

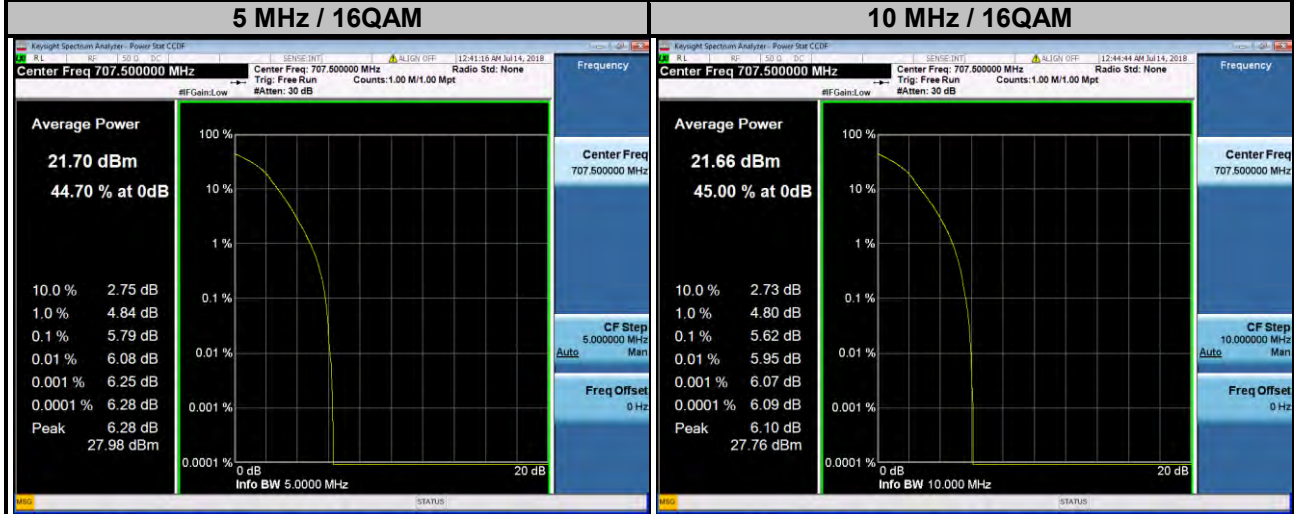

LTE Band 13							
Channel Bandwidth: 5 MHz				Channel Bandwidth: 10 MHz			
Channel	Frequency (MHz)	Peak to Average Ratio (dB)		Channel	Frequency (MHz)	Peak to Average Ratio (dB)	
		QPSK	16QAM			QPSK	16QAM
23205	779.5	3.83	4.87	23230	782.0	3.86	4.82
23230	782.0	5.11	5.99				
23255	784.5	5.75	6.58				

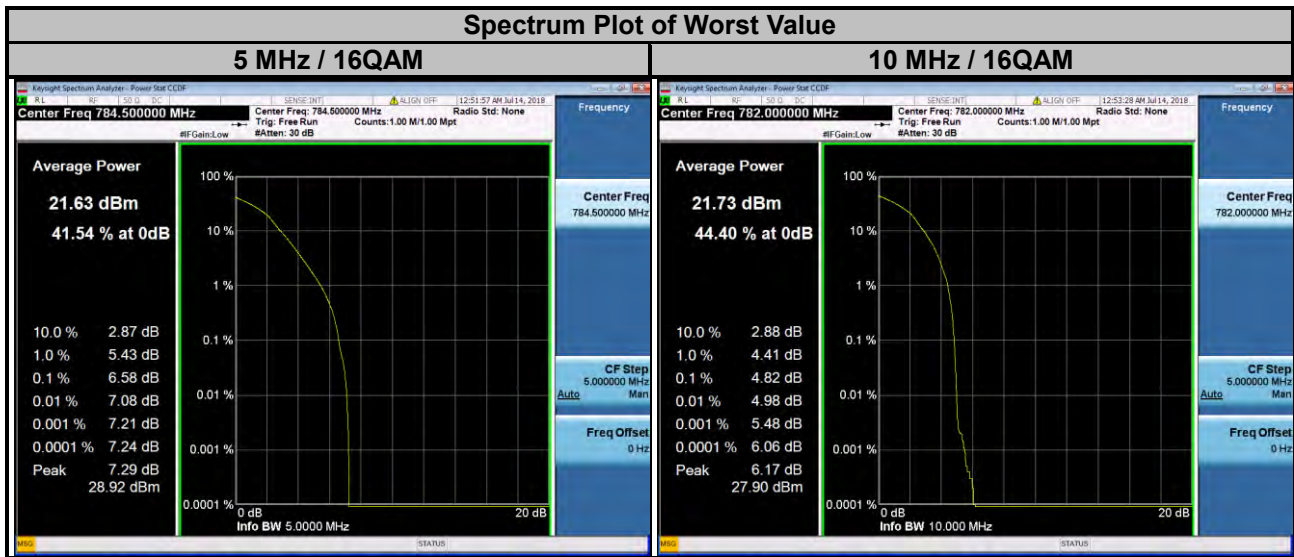

LTE Band 17

Channel Bandwidth: 5 MHz				Channel Bandwidth: 10 MHz			
Channel	Frequency (MHz)	Peak to Average Ratio (dB)		Channel	Frequency (MHz)	Peak to Average Ratio (dB)	
		QPSK	16QAM			QPSK	16QAM
23755	706.5	4.74	5.53	23780	709.0	4.75	5.47
23790	710.0	4.96	5.60	23790	710.0	4.77	5.65
23825	713.5	4.85	5.70	23800	711.0	4.80	5.61

Spectrum Plot of Worst Value

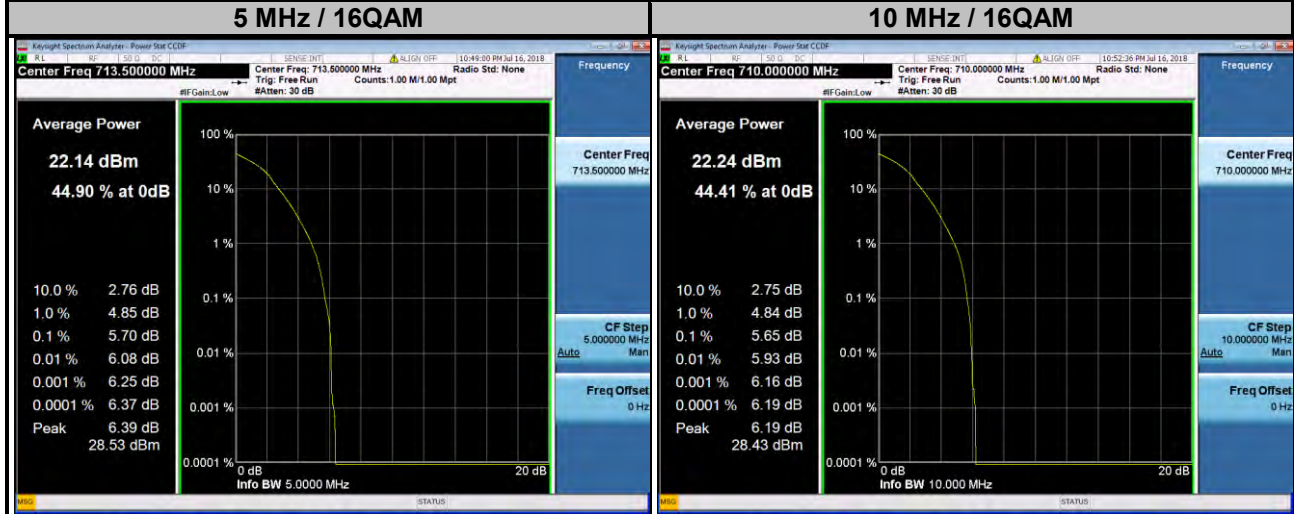

LTE Band 66

Channel Bandwidth: 1.4 MHz				Channel Bandwidth: 3 MHz			
Channel	Frequency (MHz)	Peak to Average Ratio (dB)		Channel	Frequency (MHz)	Peak to Average Ratio (dB)	
		QPSK	16QAM			QPSK	16QAM
131979	1710.7	4.95	4.79	131987	1711.5	5.29	4.82
132322	1745.0	4.91	4.87	132322	1745.0	4.98	4.98
132665	1779.3	4.26	4.41	132657	1778.5	4.46	4.49

Spectrum Plot of Worst Value

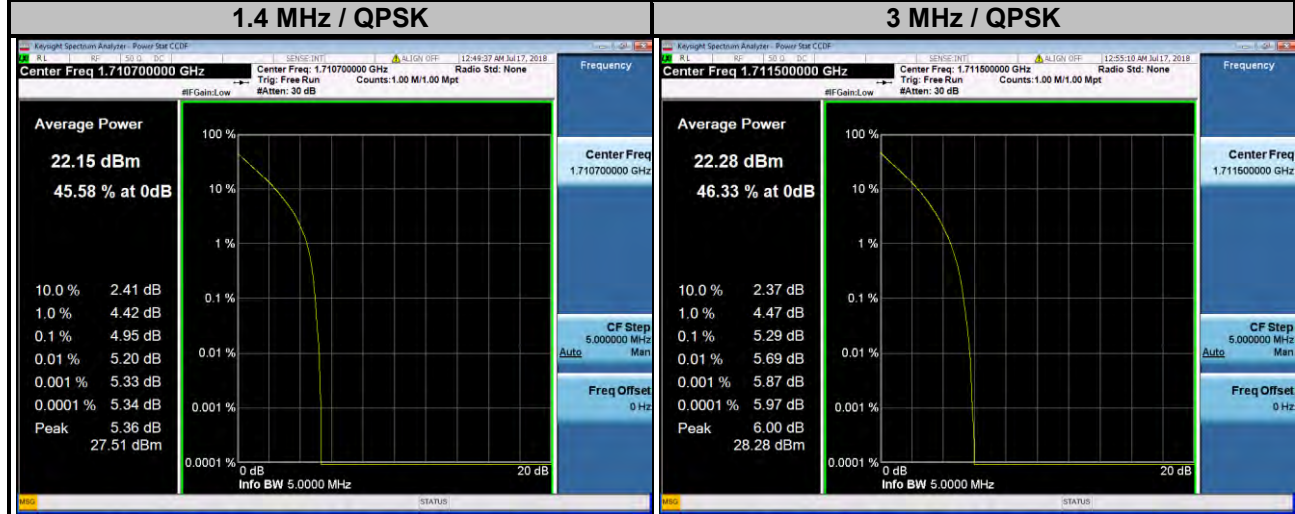

LTE Band 66

Channel Bandwidth: 5 MHz				Channel Bandwidth: 10 MHz			
Channel	Frequency (MHz)	Peak to Average Ratio (dB)		Channel	Frequency (MHz)	Peak to Average Ratio (dB)	
		QPSK	16QAM			QPSK	16QAM
131997	1712.5	4.78	4.90	132022	1715.0	4.73	4.75
132322	1745.0	4.91	5.09	132322	1745.0	5.10	5.18
132647	1777.5	4.75	4.78	132622	1775.0	5.35	5.45

Spectrum Plot of Worst Value

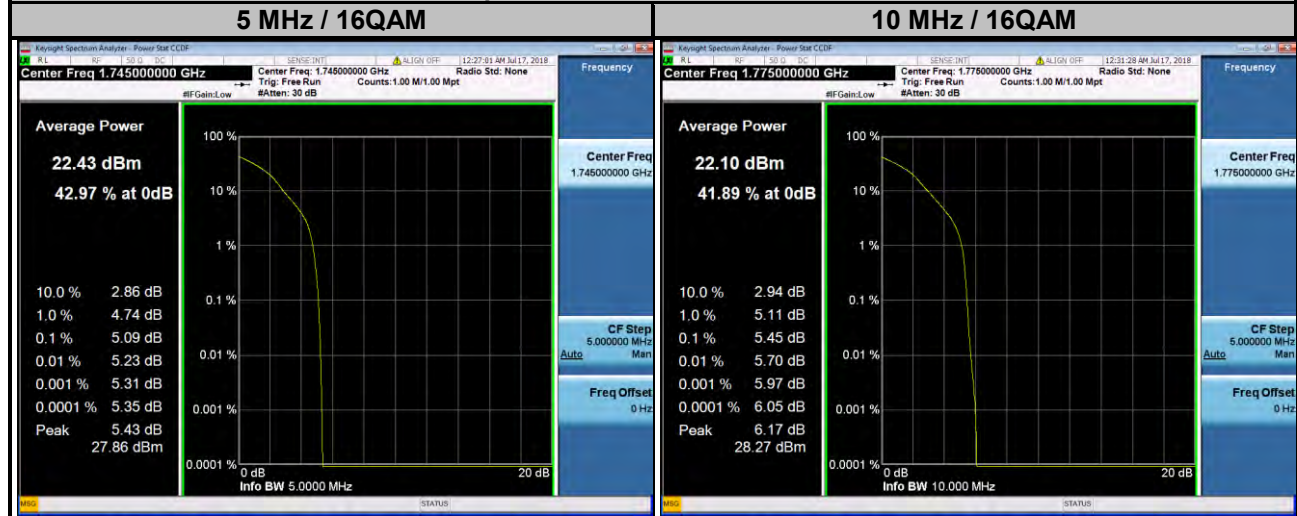

LTE Band 66

Channel Bandwidth: 15 MHz				Channel Bandwidth: 20 MHz			
Channel	Frequency (MHz)	Peak to Average Ratio (dB)		Channel	Frequency (MHz)	Peak to Average Ratio (dB)	
		QPSK	16QAM			QPSK	16QAM
132047	1717.5	5.58	4.97	132072	1720.0	4.76	4.85
132322	1745.0	5.26	5.24	132322	1745.0	5.27	5.41
132597	1772.5	5.48	5.77	132572	1770.0	5.47	5.51

Spectrum Plot of Worst Value

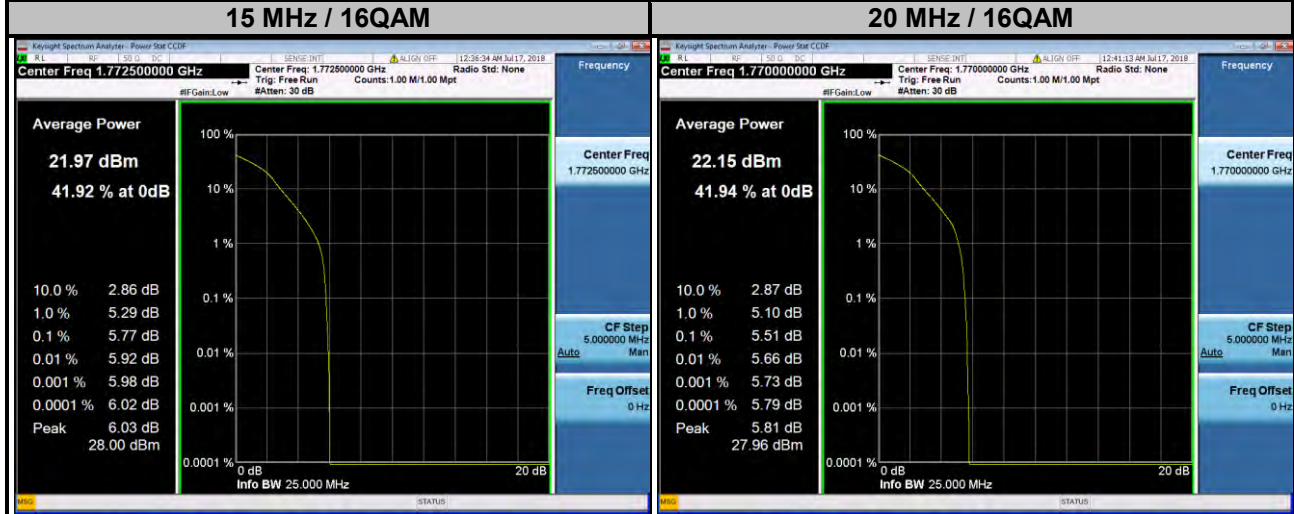

4.7 Conducted Spurious Emissions

4.7.1 Limits of Conducted Spurious Emissions Measurement

The power of any emission outside a licensee's frequency block shall be attenuated below the transmitter power (P) by at least $43 + 10 \log (P)$ dB. The limit of emission is equal to -13 dBm.

4.7.2 Test Setup

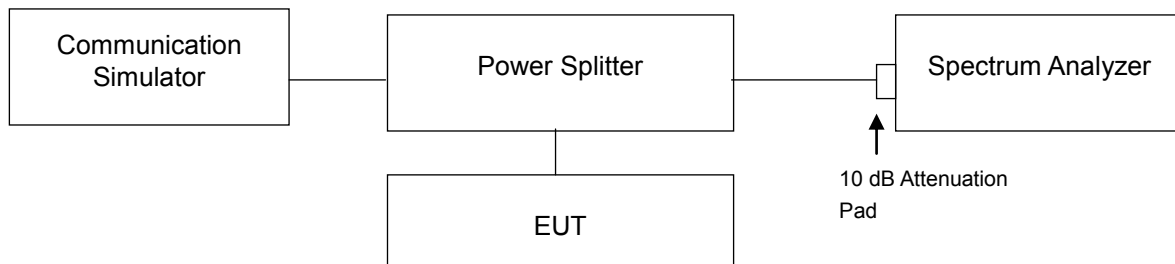

4.7.3 Test Procedure

- The EUT makes a phone call to the communication simulator. All measurements were done at low, middle and high operational frequency range.
- Measuring frequency range is from 9 kHz to 10 GHz for LTE Band 12, 13, 17 and from 9 kHz to 27 GHz for LTE Band 4, 66. 10 dB attenuation pad is connected with spectrum. RBW = 100 kHz and VBW = 300 kHz for 9 kHz to 1 GHz and RBW = 1 MHz and VBW = 3 MHz for 1 GHz to 27 GHz is used for conducted emission measurement.

4.7.4 Test Results

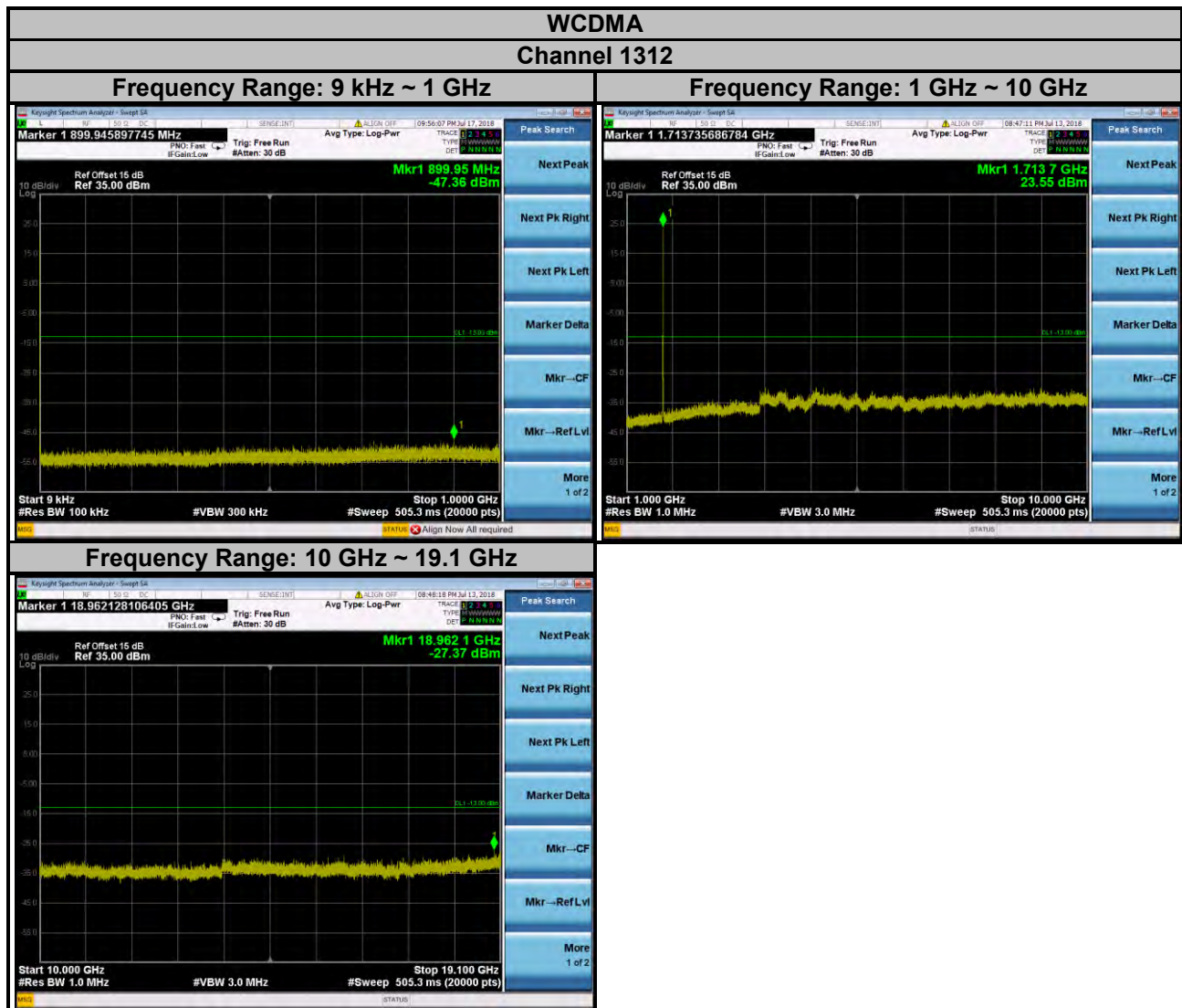

WCDMA Channel 1413

Frequency Range: 9 kHz ~ 1 GHz

Frequency Range: 1 GHz ~ 10 GHz

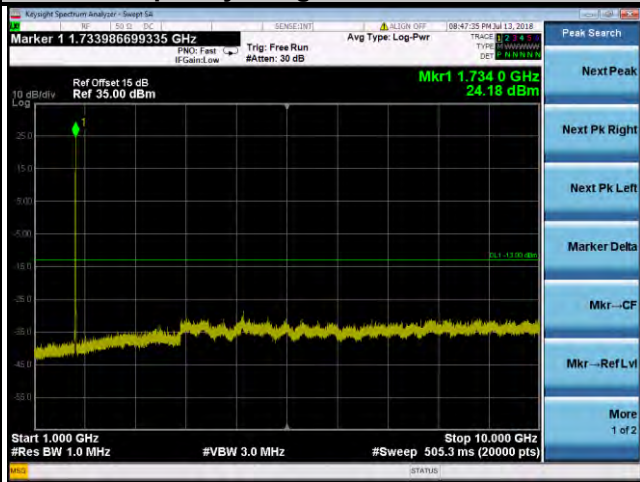
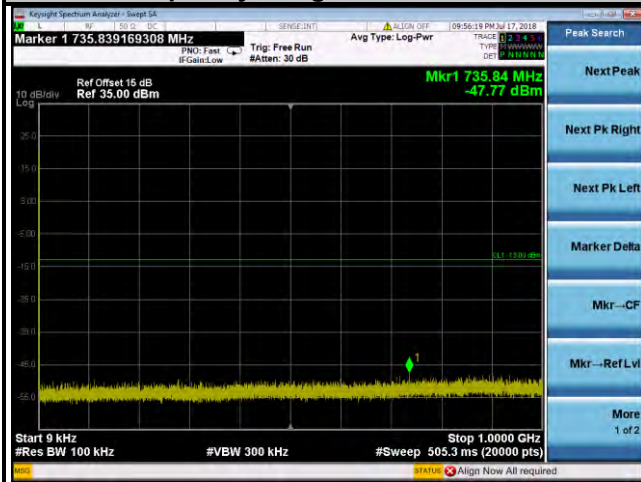

Frequency Range: 10 GHz ~ 19.1 GHz

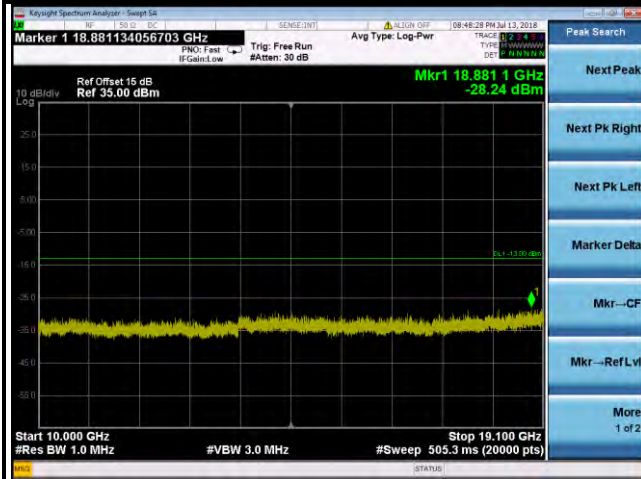

WCDMA
Channel 1513

Frequency Range: 9 kHz ~ 1 GHz

Frequency Range: 1 GHz ~ 10 GHz

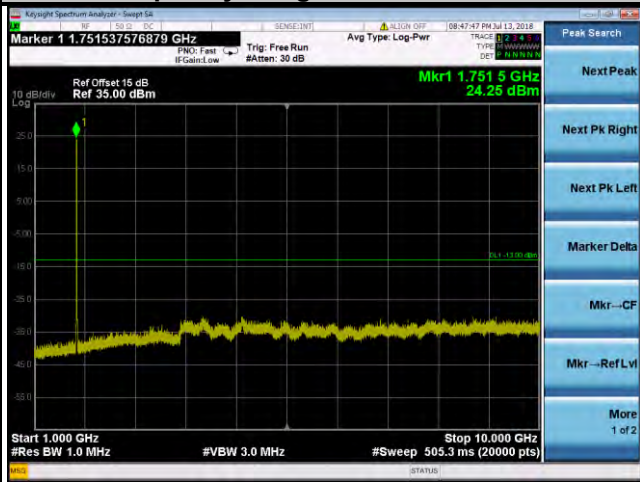
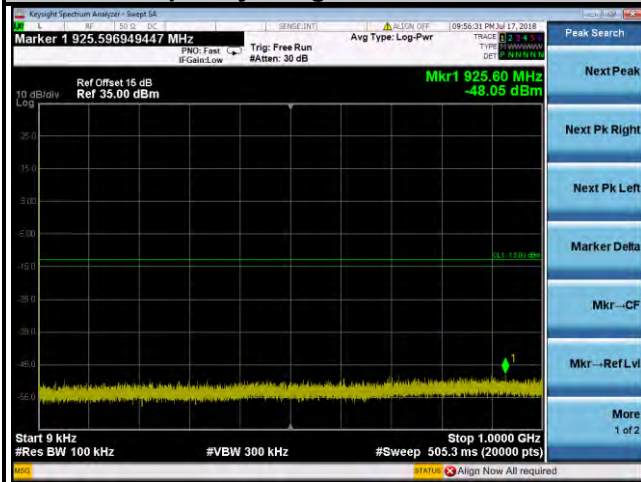

Frequency Range: 10 GHz ~ 19.1 GHz

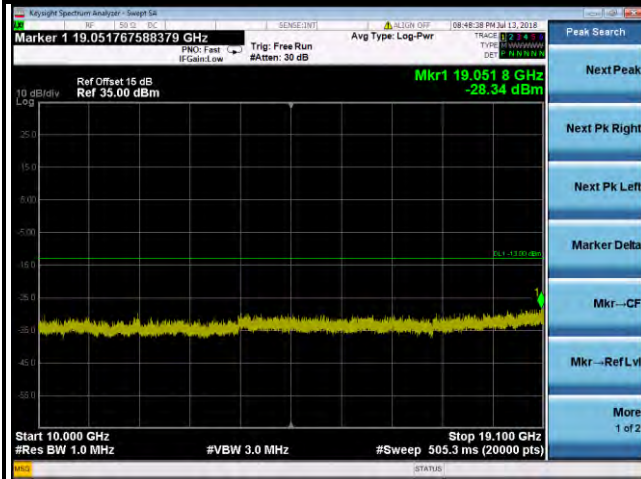

LTE Band 4
Channel Bandwidth: 1.4 MHz
Channel 19957

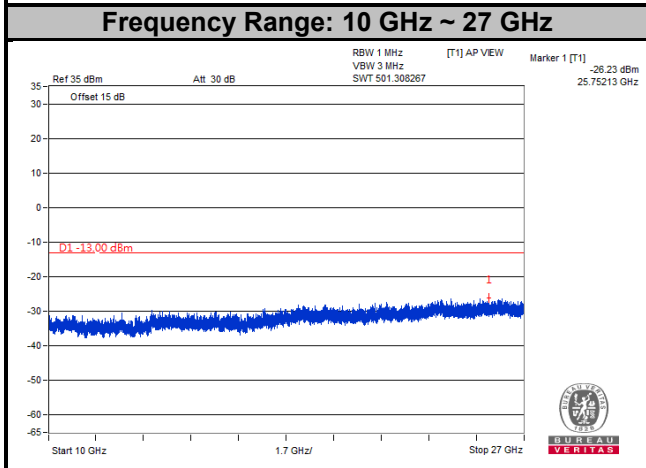
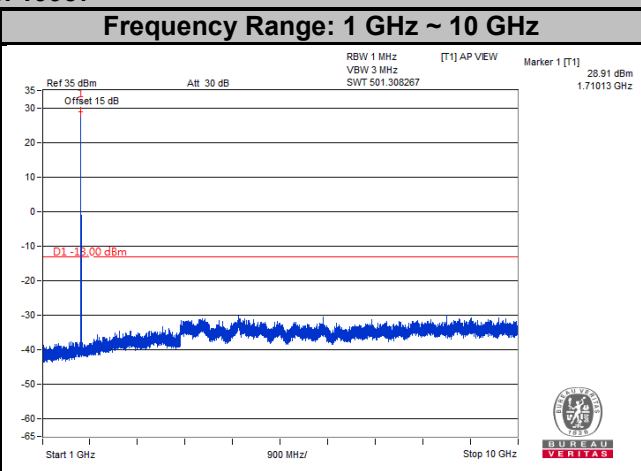
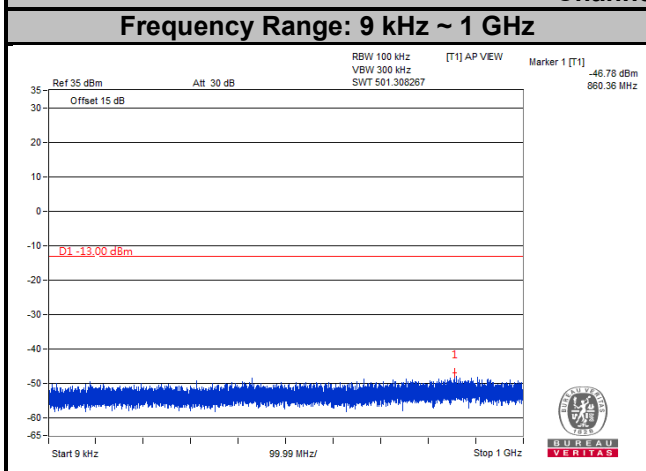

LTE Band 4
Channel Bandwidth: 1.4 MHz

Channel 20175

Frequency Range: 9 kHz ~ 1 GHz

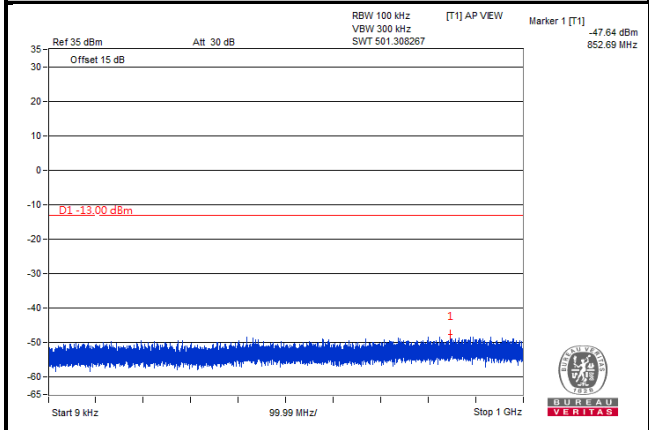

Frequency Range: 1 GHz ~ 10 GHz

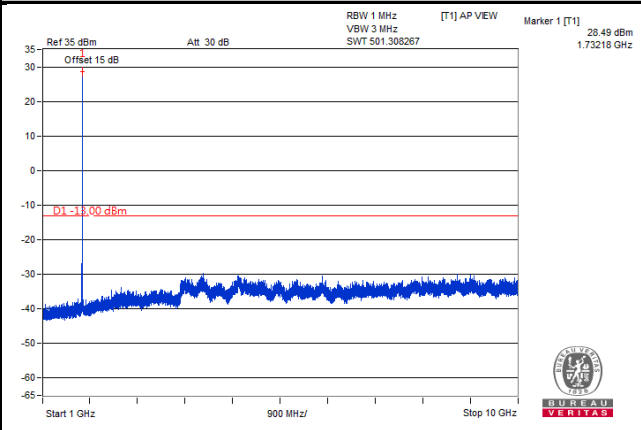

Frequency Range: 10 GHz ~ 27 GHz

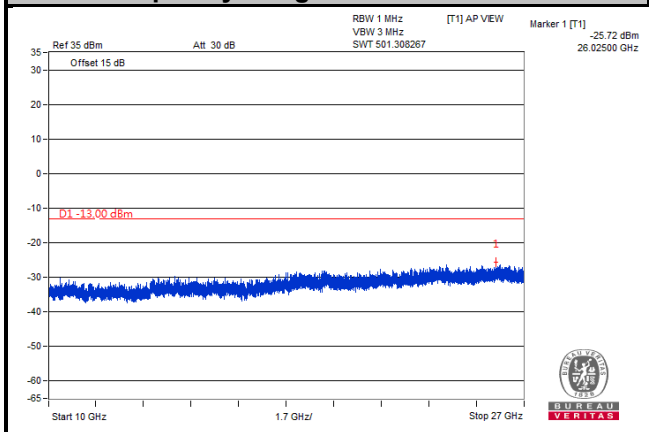

LTE Band 4
Channel Bandwidth: 1.4 MHz

Channel 20393

Frequency Range: 9 kHz ~ 1 GHz

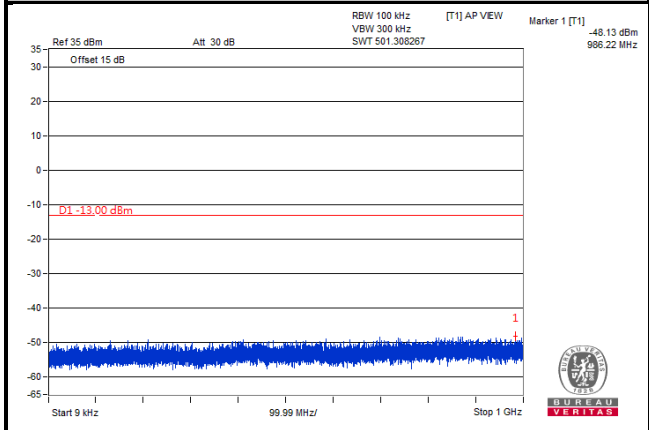

Frequency Range: 1 GHz ~ 10 GHz

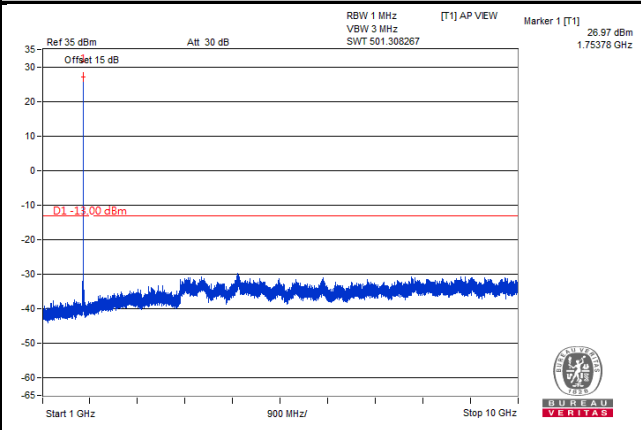

Frequency Range: 10 GHz ~ 27 GHz

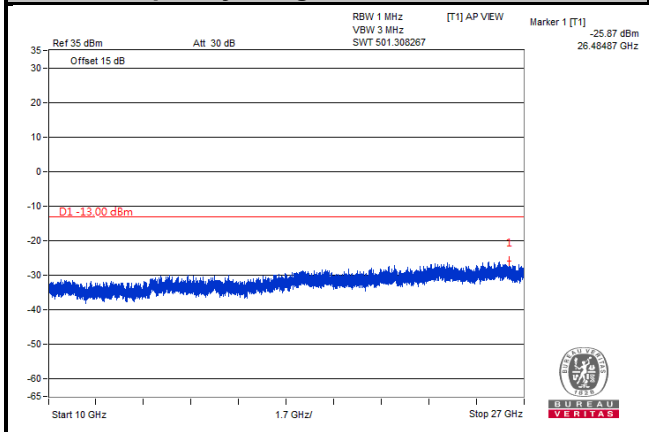

LTE Band 4
Channel Bandwidth: 3 MHz
Channel 19965

Frequency Range: 9 kHz ~ 1 GHz **Frequency Range: 1 GHz ~ 10 GHz**

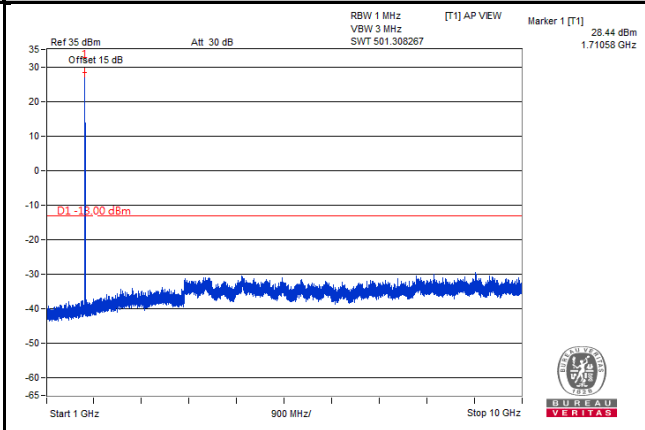
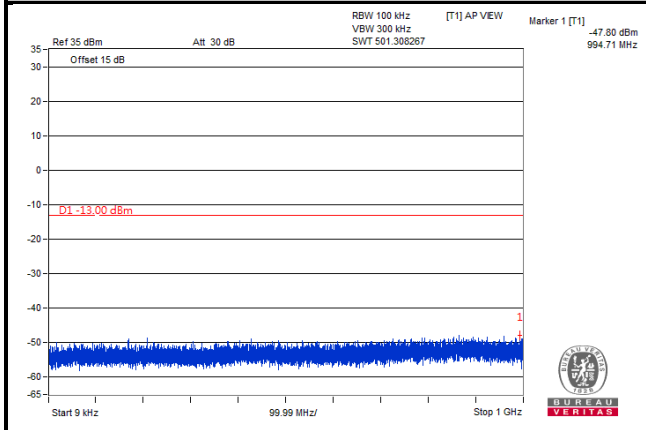

Frequency Range: 10 GHz ~ 27 GHz

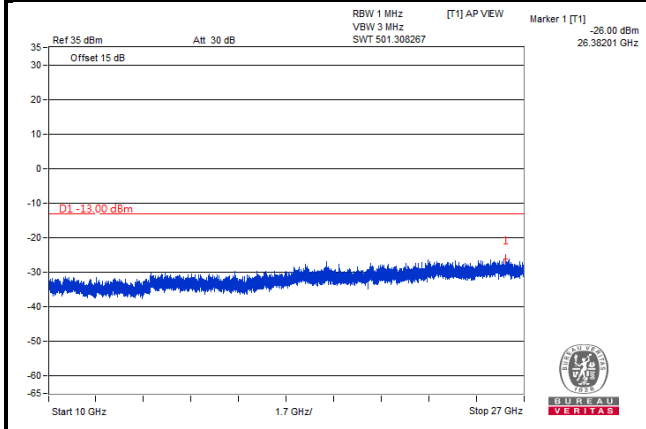

LTE Band 4
Channel Bandwidth: 3 MHz
Channel 20175

Frequency Range: 9 kHz ~ 1 GHz **Frequency Range: 1 GHz ~ 10 GHz**

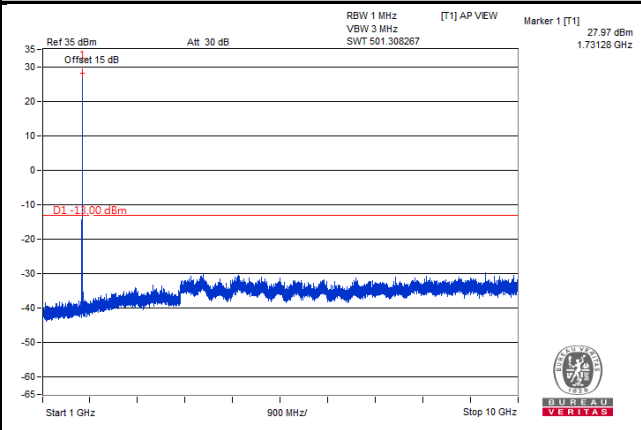
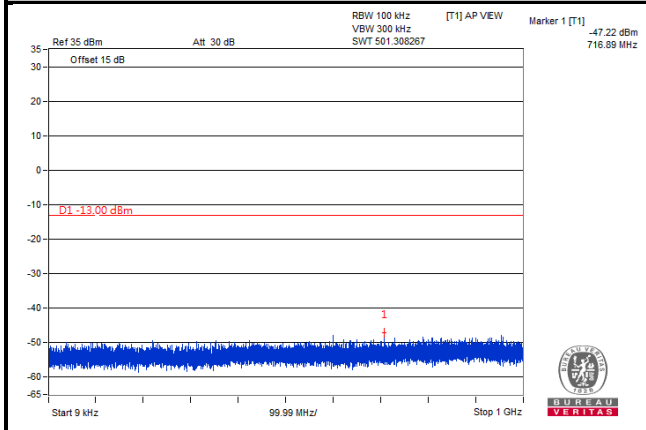

Frequency Range: 10 GHz ~ 27 GHz

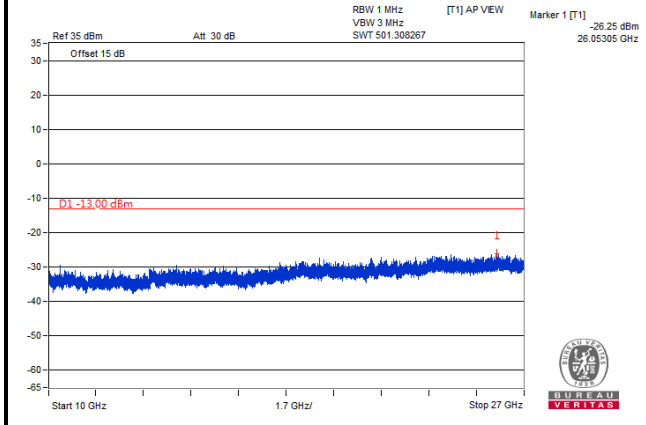

LTE Band 4
Channel Bandwidth: 3 MHz
Channel 20385

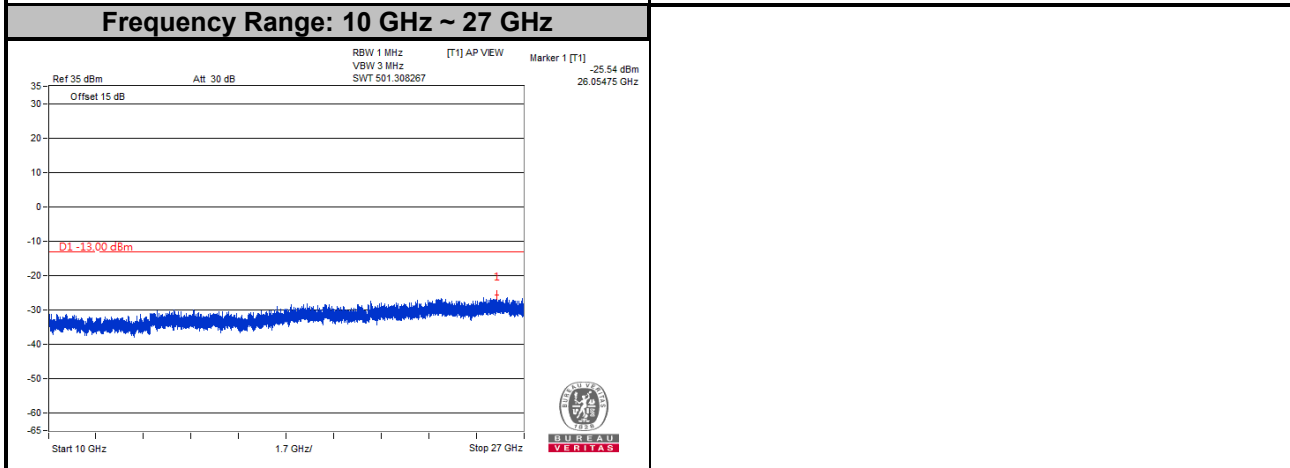
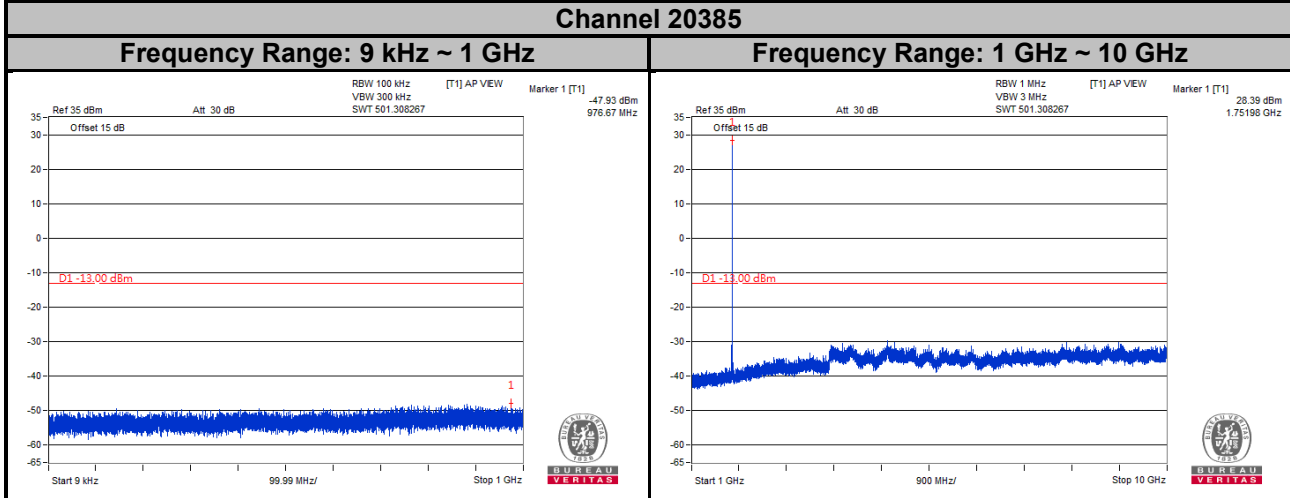

LTE Band 4
Channel Bandwidth: 5 MHz
Channel 19975

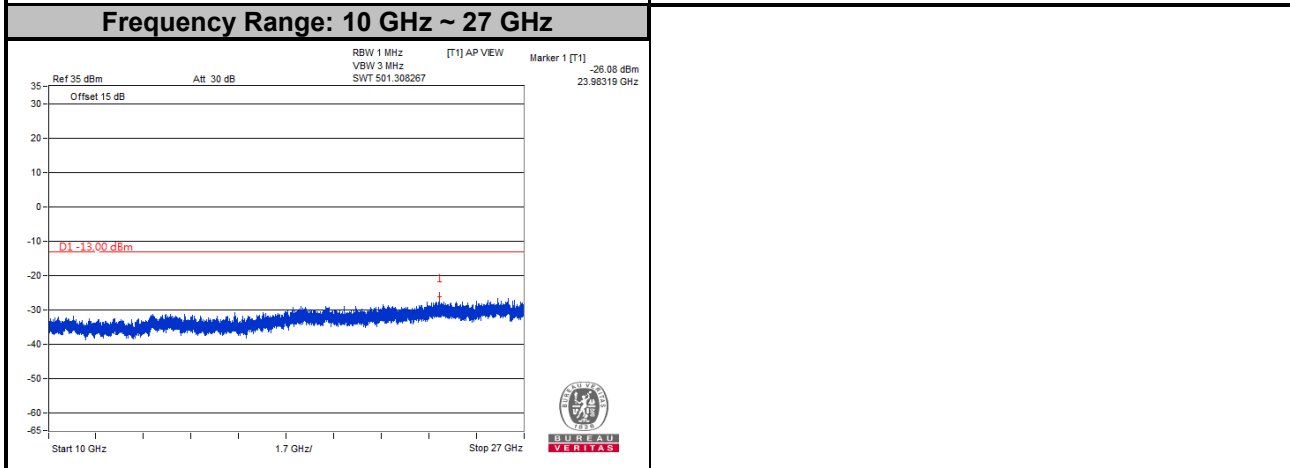
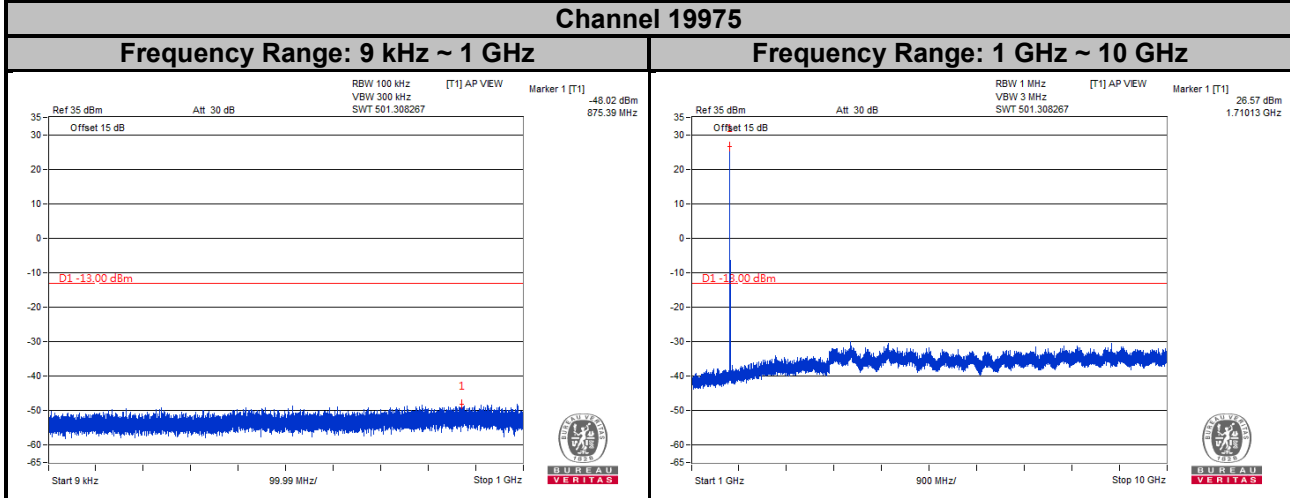

LTE Band 4
Channel Bandwidth: 5 MHz

Channel 20175

Frequency Range: 9 kHz ~ 1 GHz

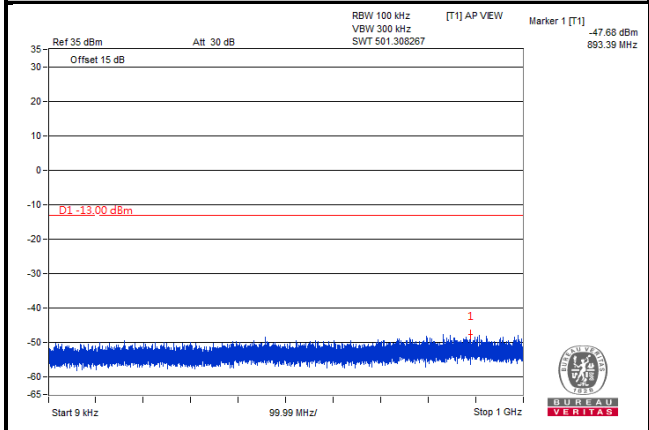

Frequency Range: 1 GHz ~ 10 GHz

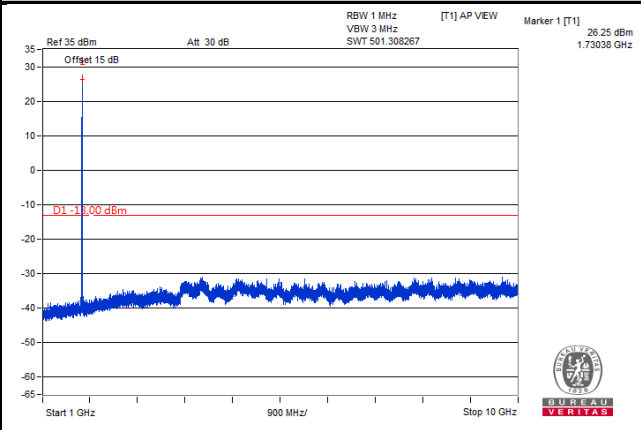

Frequency Range: 10 GHz ~ 27 GHz

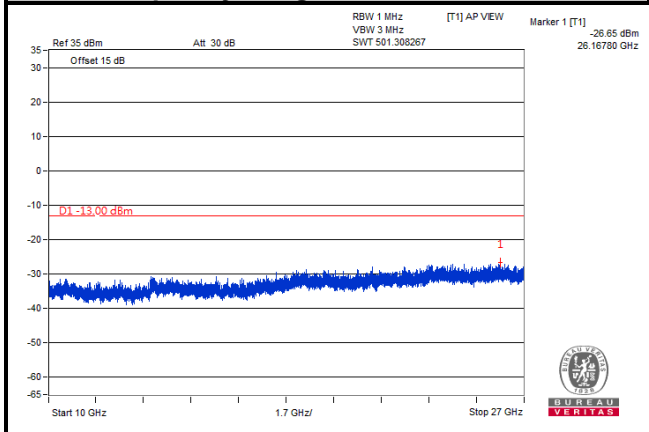

LTE Band 4
Channel Bandwidth: 5 MHz
Channel 20375

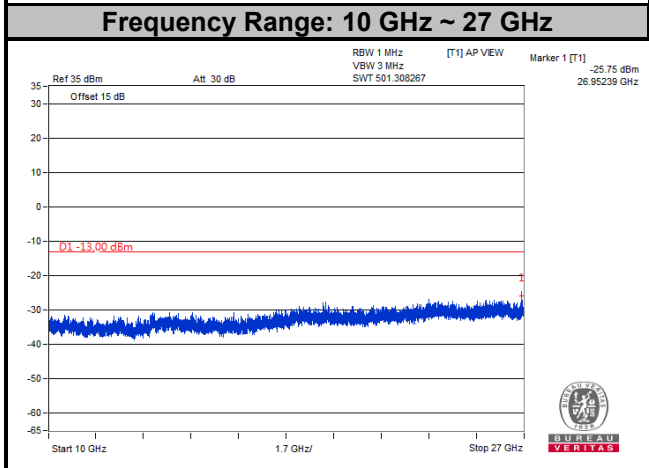
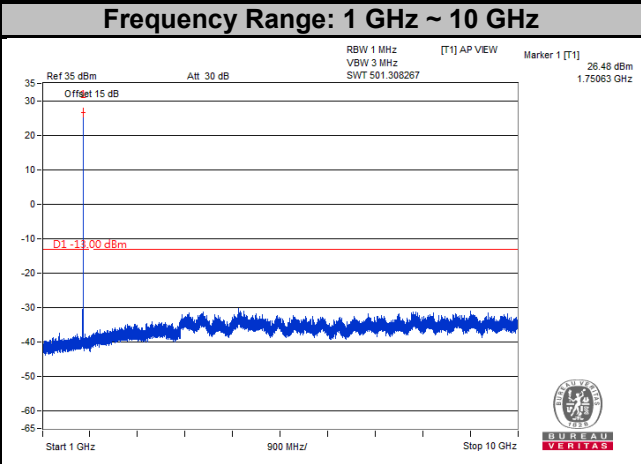
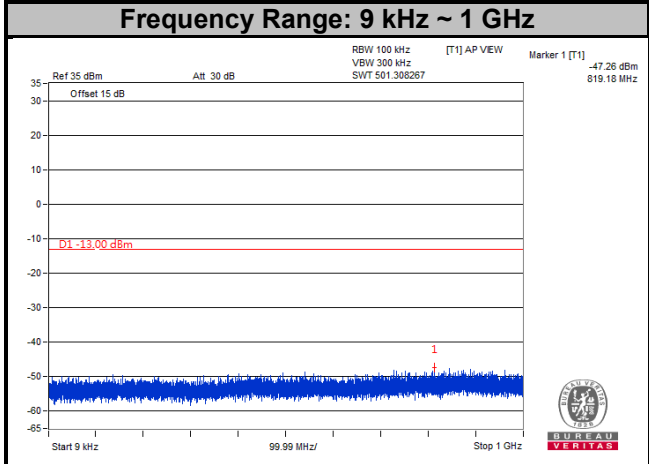

LTE Band 4
Channel Bandwidth: 10 MHz

Channel 20000

Frequency Range: 9 kHz ~ 1 GHz

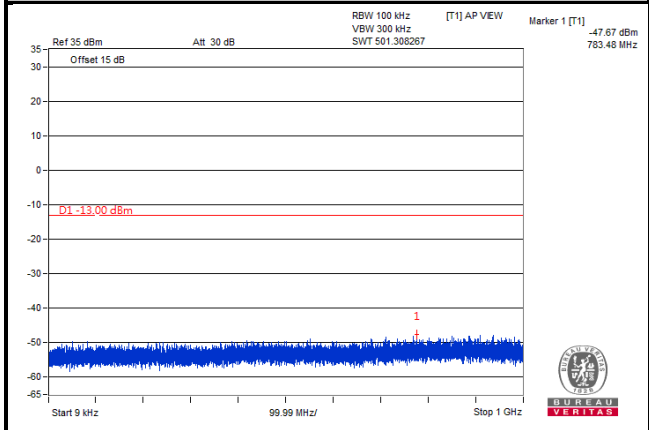

Frequency Range: 1 GHz ~ 10 GHz

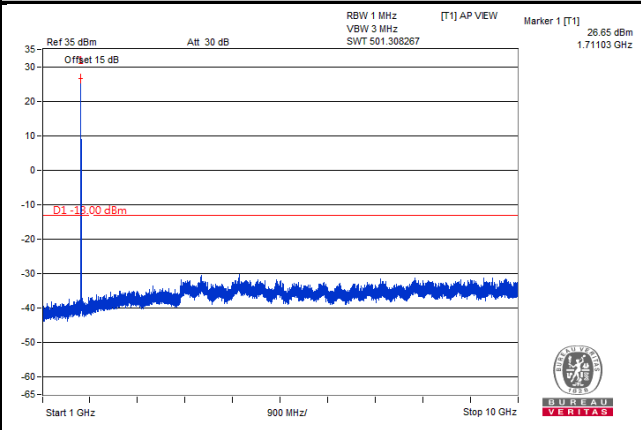

Frequency Range: 10 GHz ~ 27 GHz

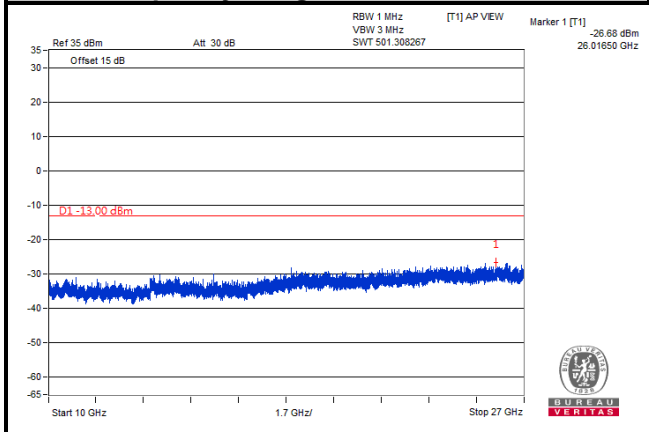

LTE Band 4

Channel Bandwidth: 10 MHz

Channel 20175

Frequency Range: 9 kHz ~ 1 GHz

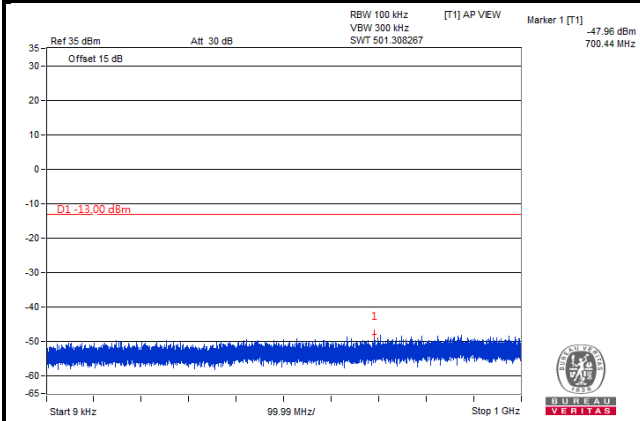

Frequency Range: 1 GHz ~ 10 GHz

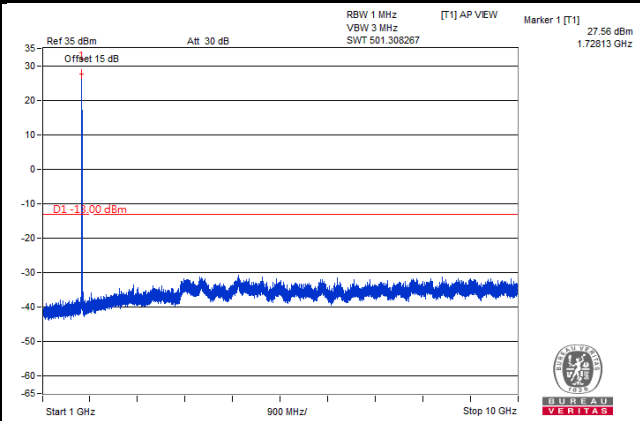

Frequency Range: 10 GHz ~ 27 GHz

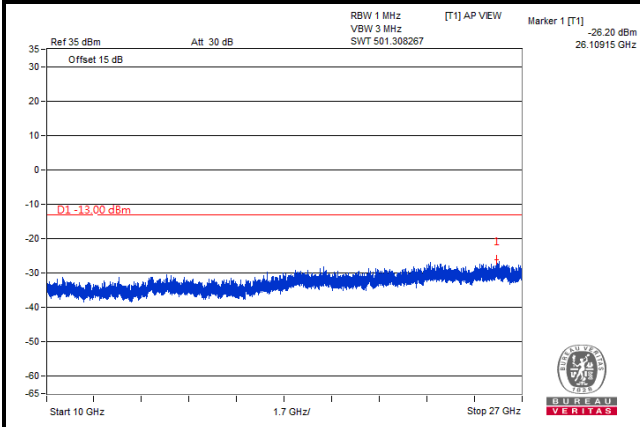

LTE Band 4
Channel Bandwidth: 10 MHz

Channel 20350

Frequency Range: 9 kHz ~ 1 GHz

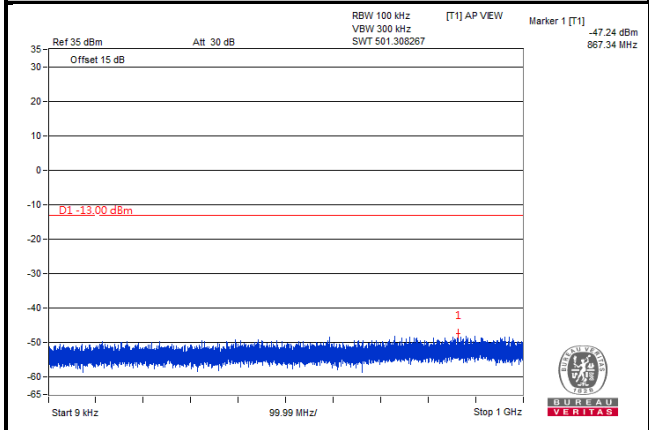

Frequency Range: 1 GHz ~ 10 GHz

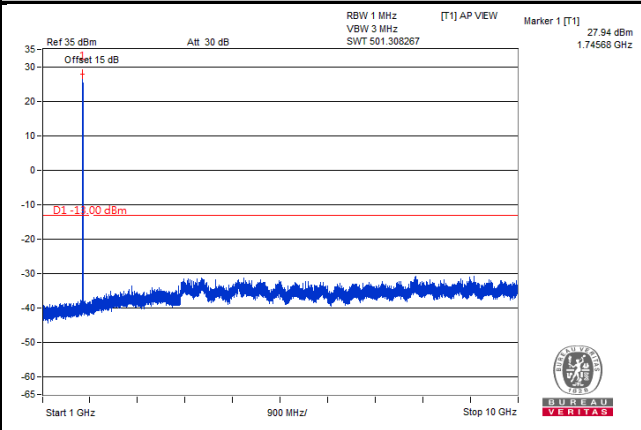

Frequency Range: 10 GHz ~ 27 GHz

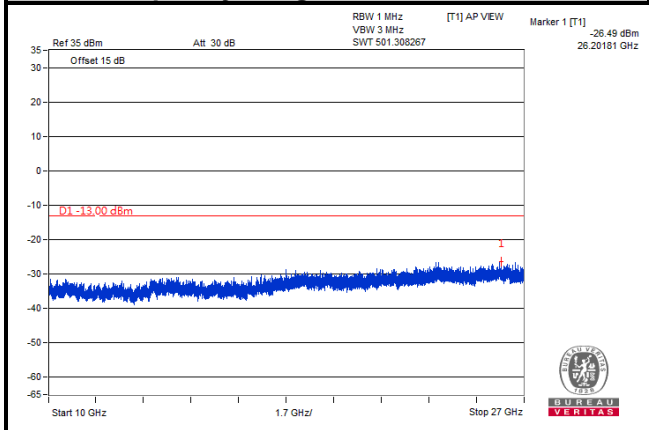

LTE Band 4
Channel Bandwidth: 15 MHz

Channel 20025

Frequency Range: 9 kHz ~ 1 GHz

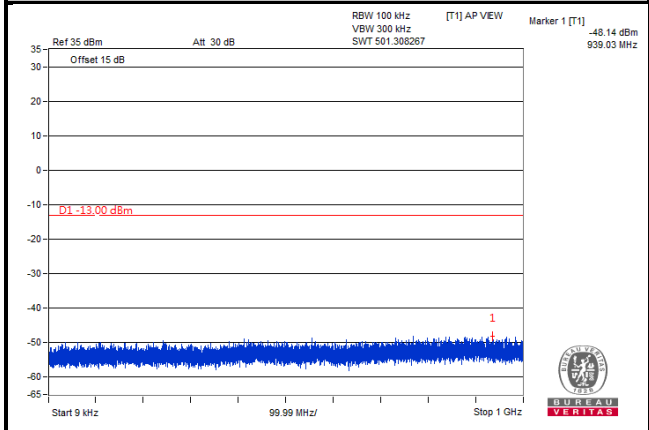

Frequency Range: 1 GHz ~ 10 GHz

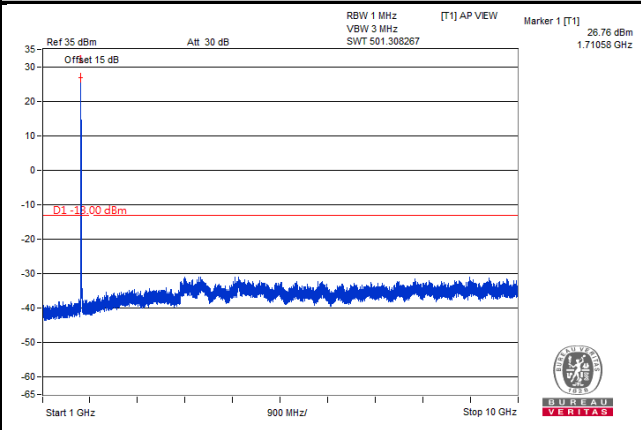

Frequency Range: 10 GHz ~ 27 GHz

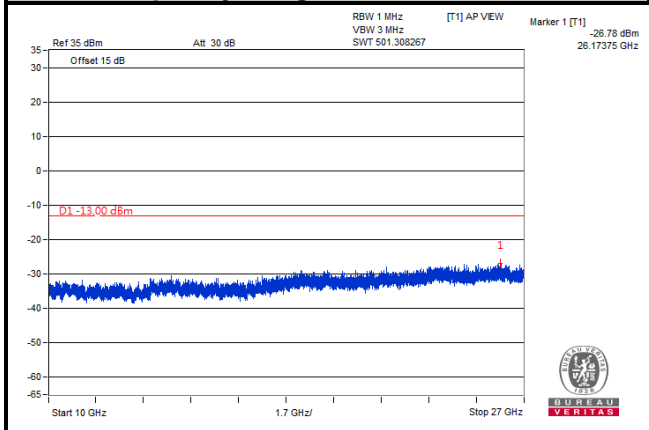

LTE Band 4
Channel Bandwidth: 15 MHz

Channel 20175

Frequency Range: 9 kHz ~ 1 GHz

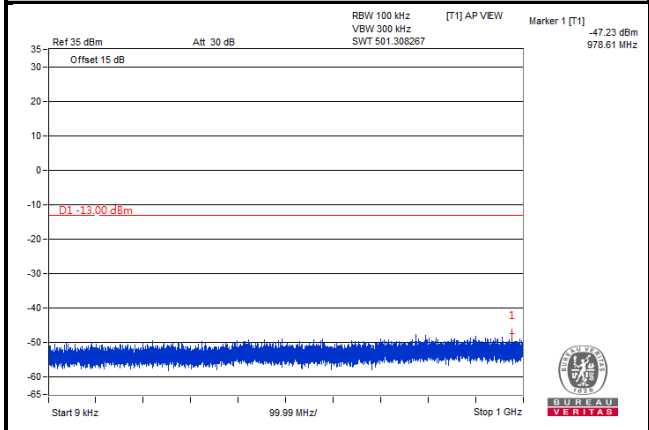

Frequency Range: 1 GHz ~ 10 GHz

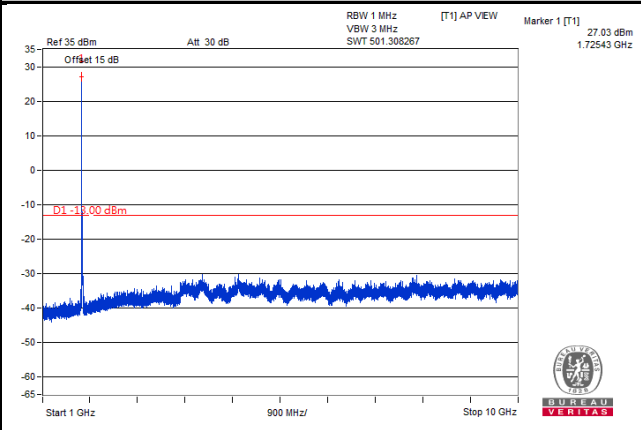

Frequency Range: 10 GHz ~ 27 GHz

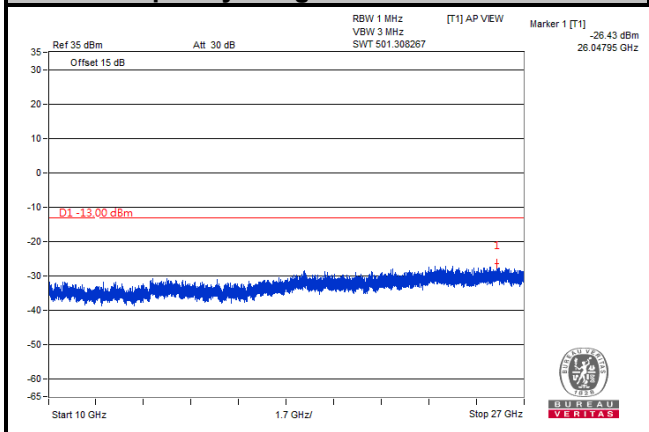

LTE Band 4
Channel Bandwidth: 15 MHz

Channel 20325

Frequency Range: 9 kHz ~ 1 GHz

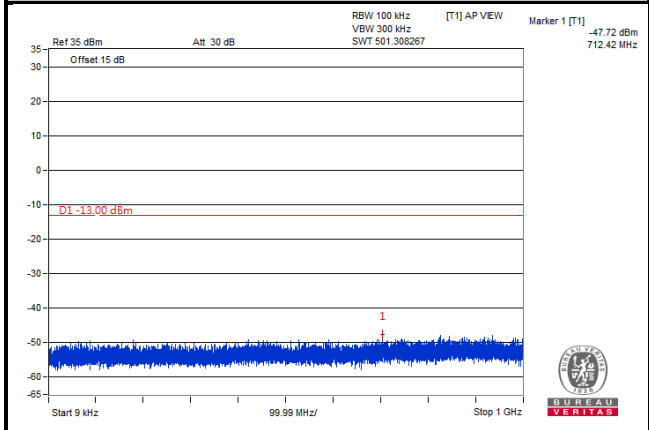

Frequency Range: 1 GHz ~ 10 GHz

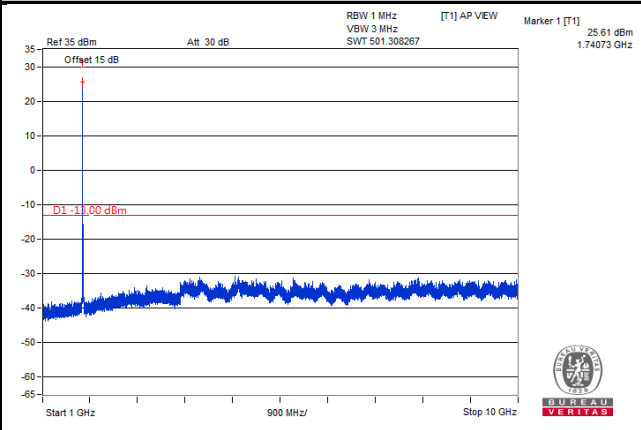

Frequency Range: 10 GHz ~ 27 GHz

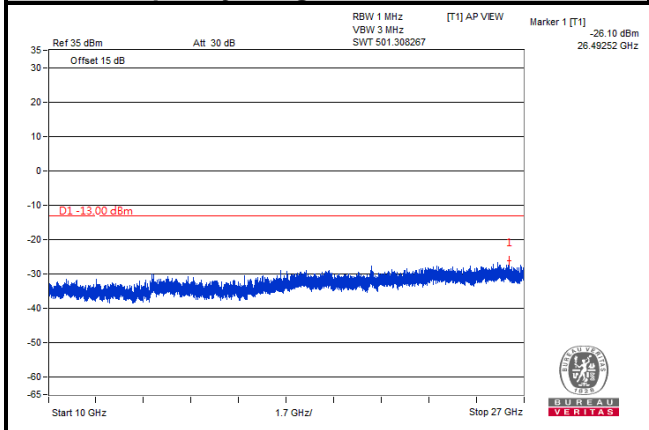

LTE Band 4
Channel Bandwidth: 20 MHz

Channel 20050

Frequency Range: 9 kHz ~ 1 GHz

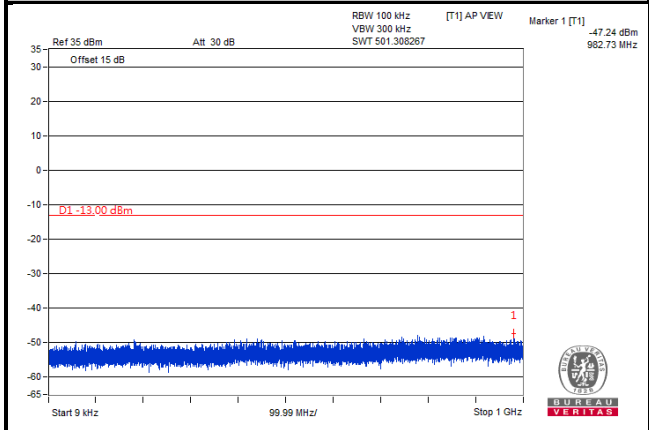

Frequency Range: 1 GHz ~ 10 GHz

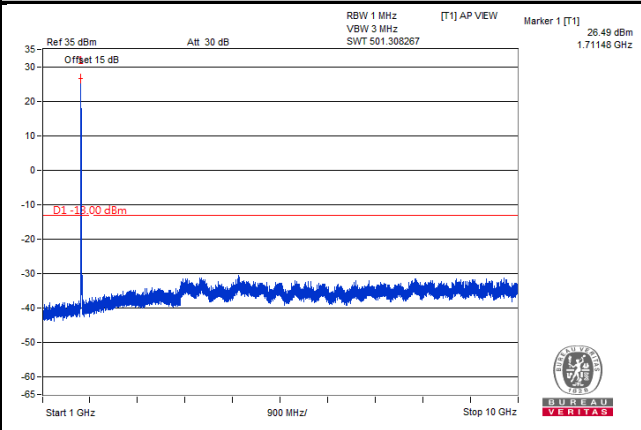

Frequency Range: 10 GHz ~ 27 GHz

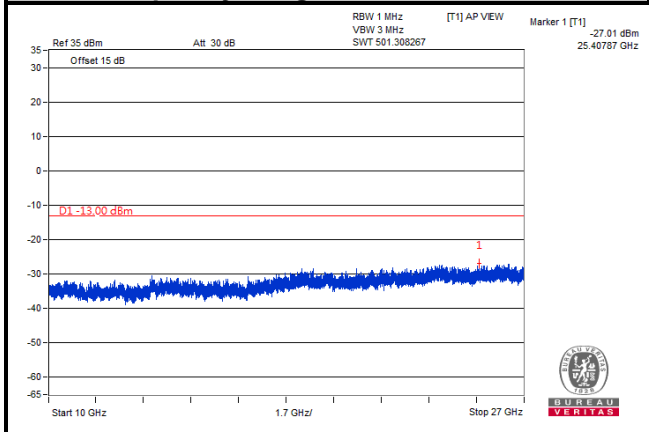

LTE Band 4
Channel Bandwidth: 20 MHz

Channel 20175

Frequency Range: 9 kHz ~ 1 GHz

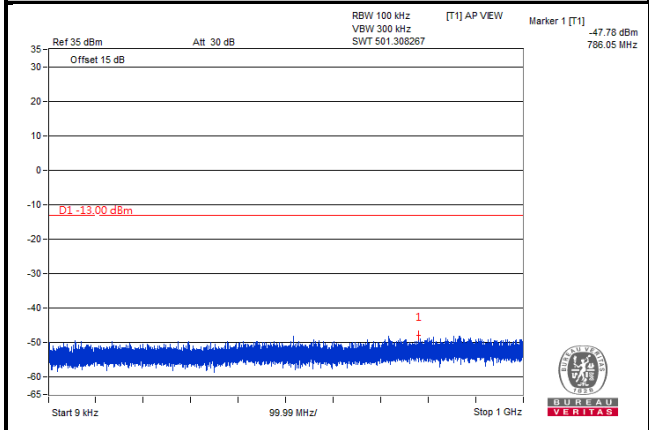

Frequency Range: 1 GHz ~ 10 GHz

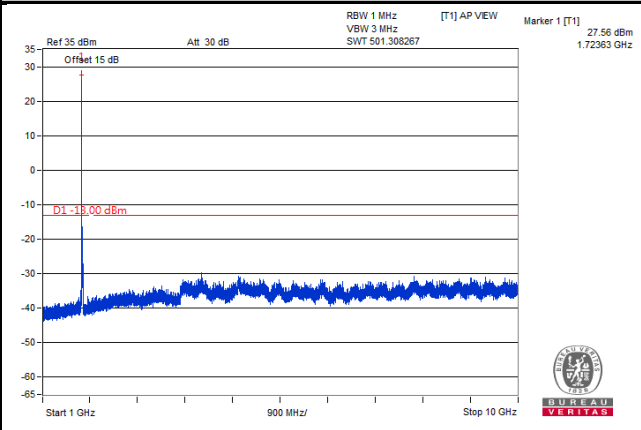

Frequency Range: 10 GHz ~ 27 GHz

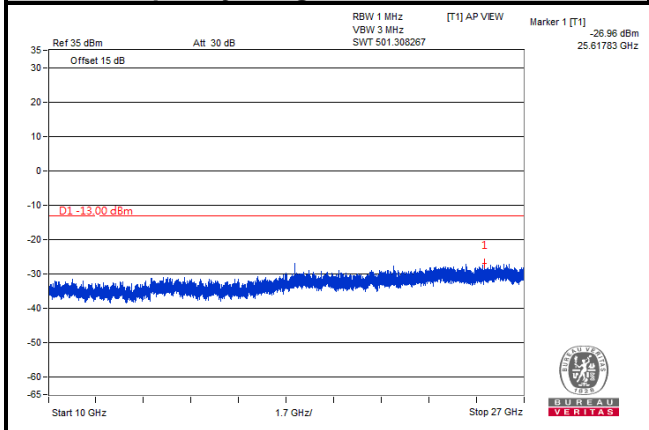

LTE Band 4
Channel Bandwidth: 20 MHz

Channel 20300

Frequency Range: 9 kHz ~ 1 GHz

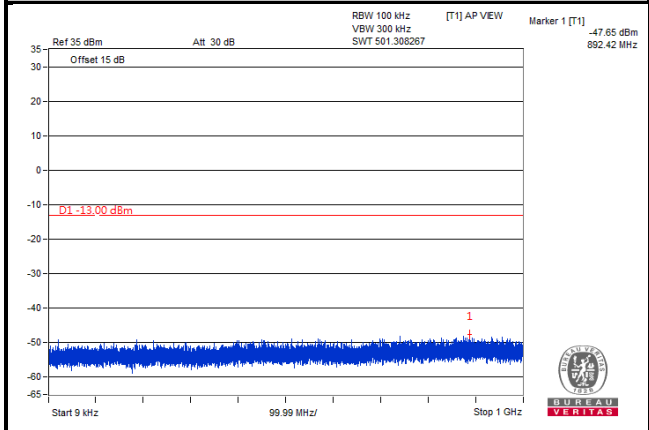

Frequency Range: 1 GHz ~ 10 GHz

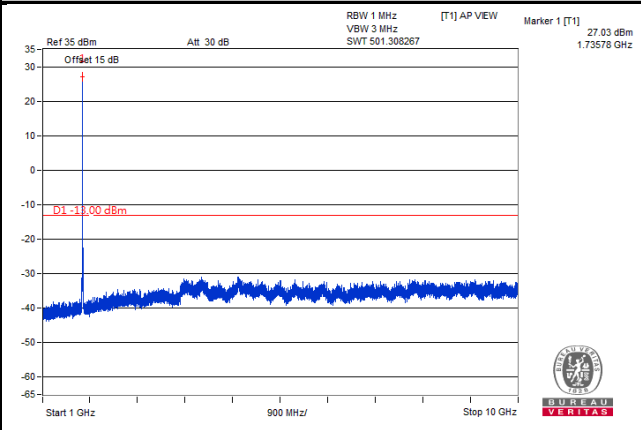

Frequency Range: 10 GHz ~ 27 GHz

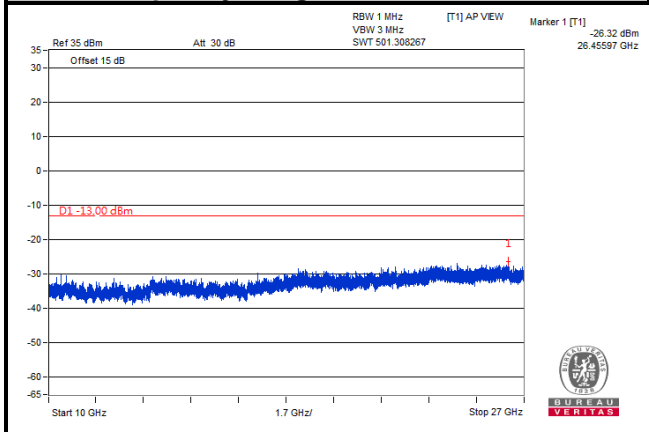

LTE Band 12
Channel Bandwidth: 1.4 MHz
Channel 23017

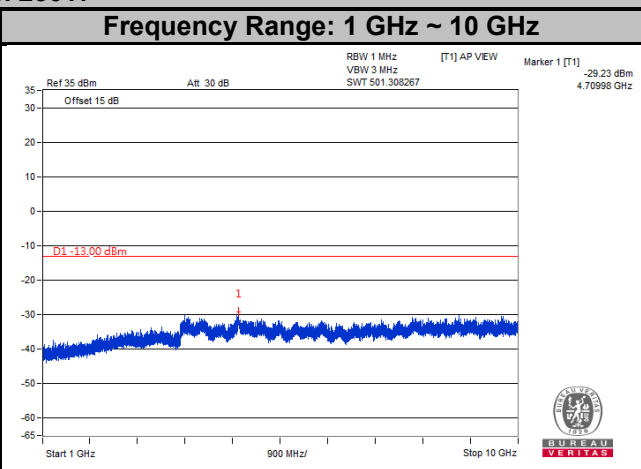
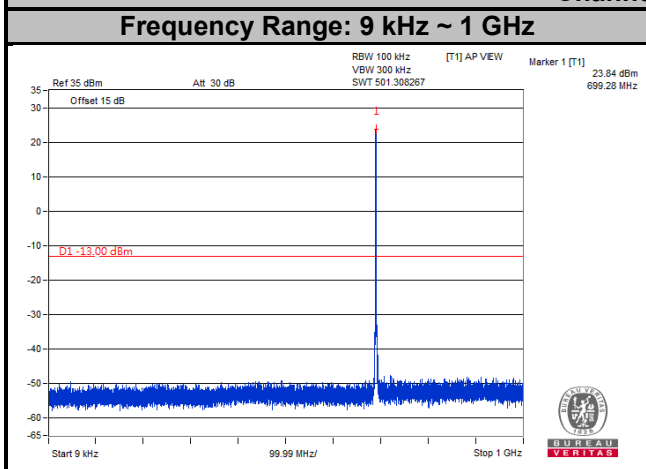

Channel 23095

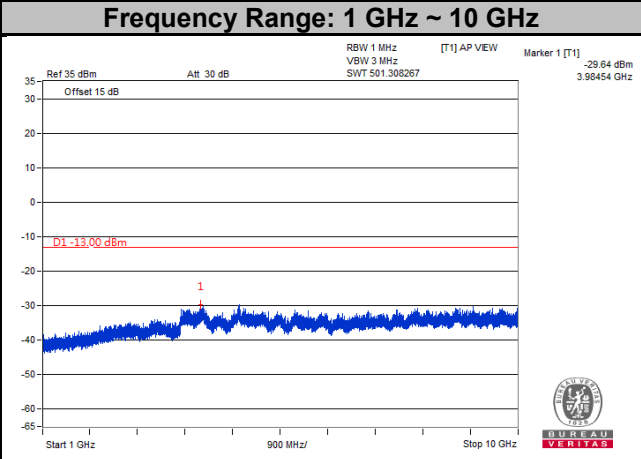
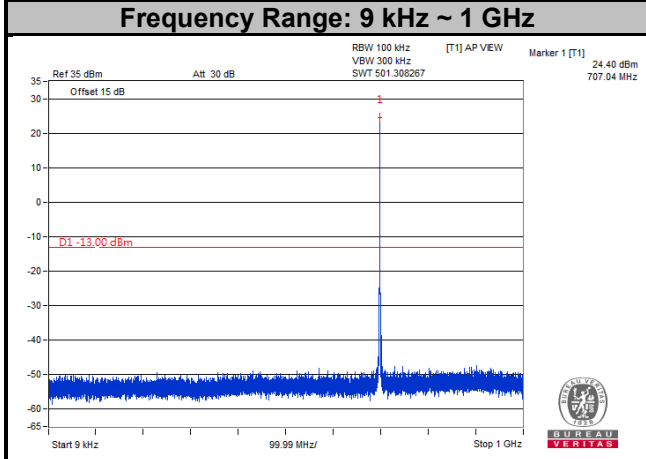

Channel 23173

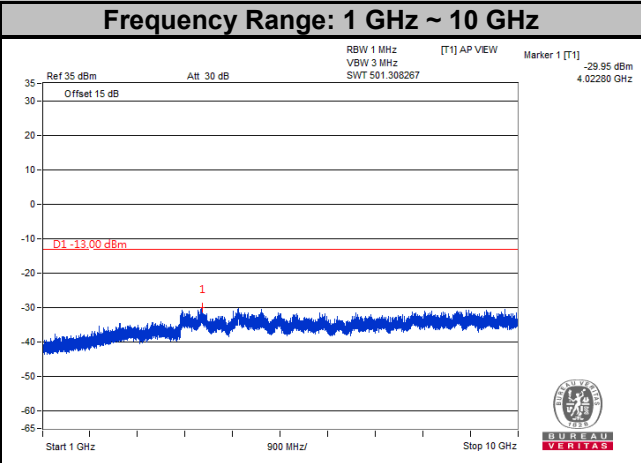
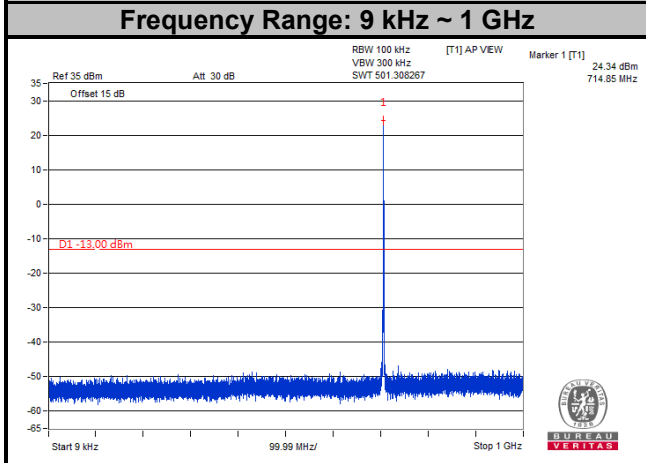

LTE Band 12
Channel Bandwidth: 3 MHz
Channel 23025

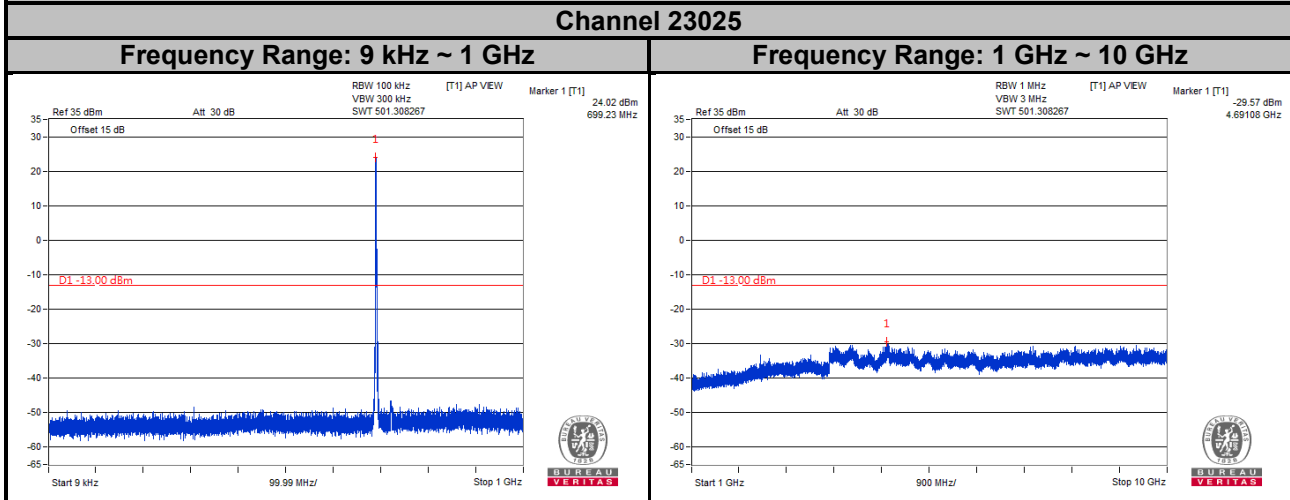

Channel 23095

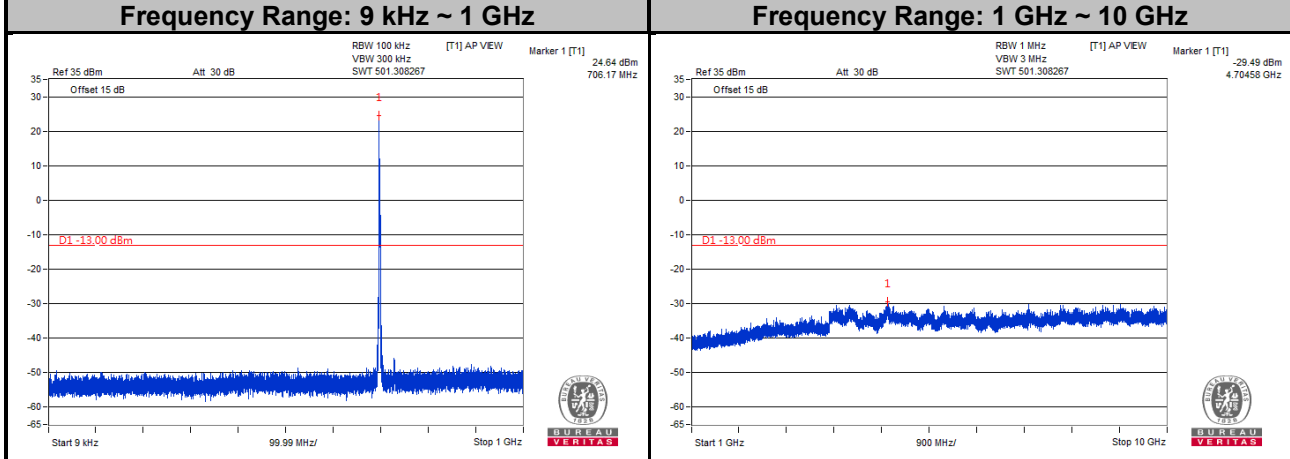

Channel 23165

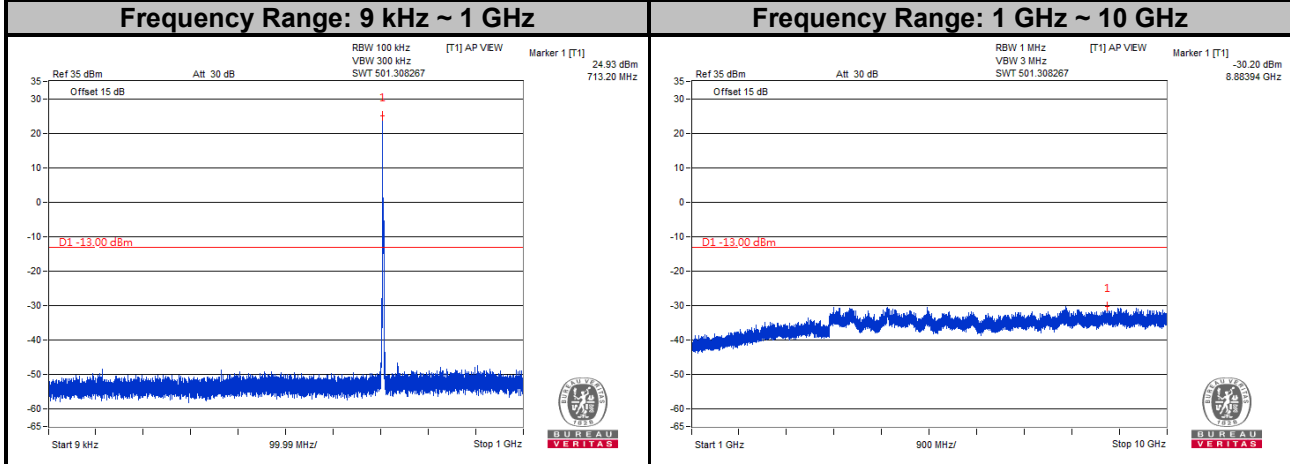

LTE Band 12
Channel Bandwidth: 5 MHz
Channel 23035

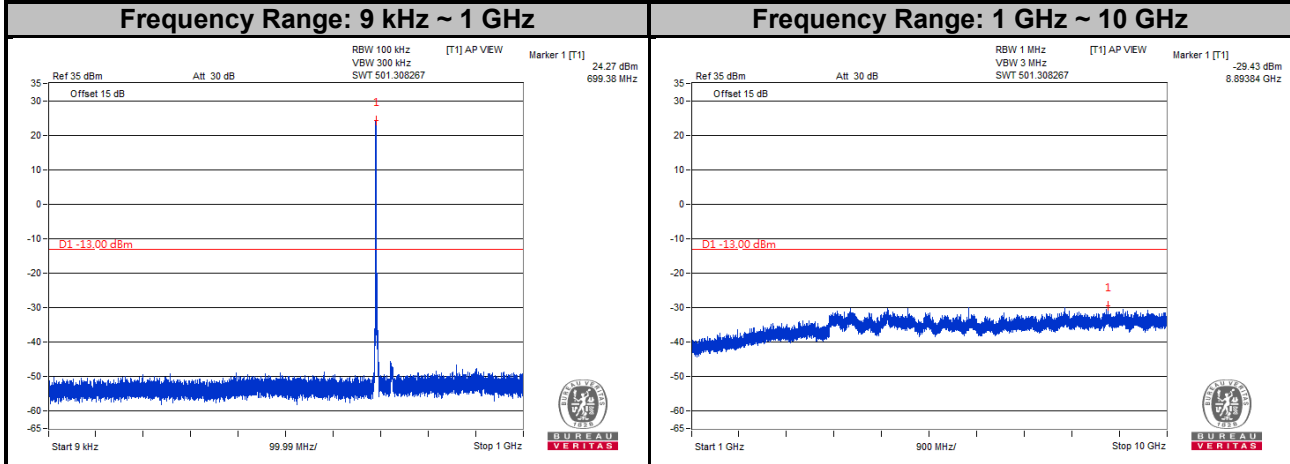

Channel 23095

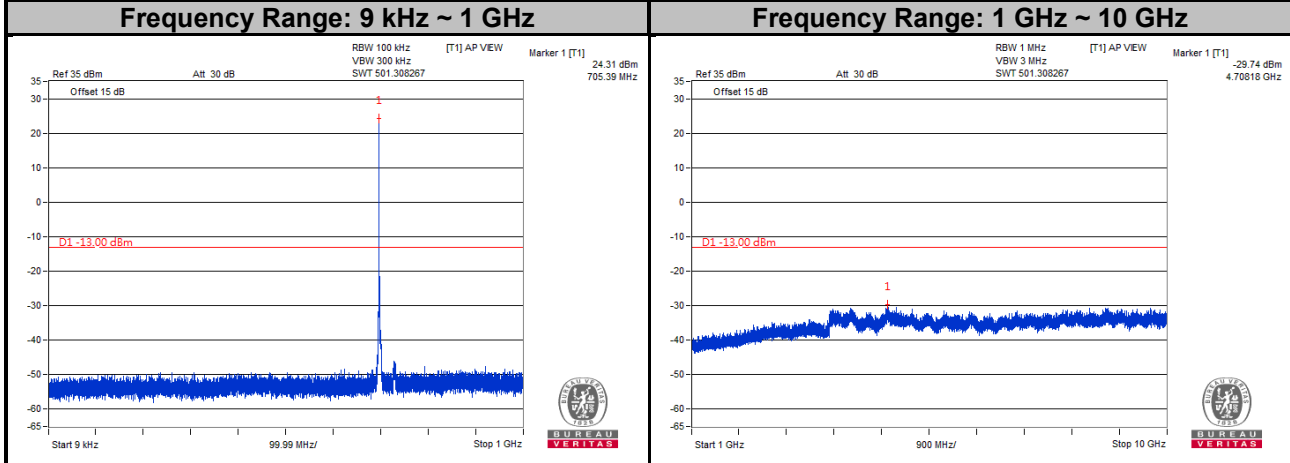

Channel 23155

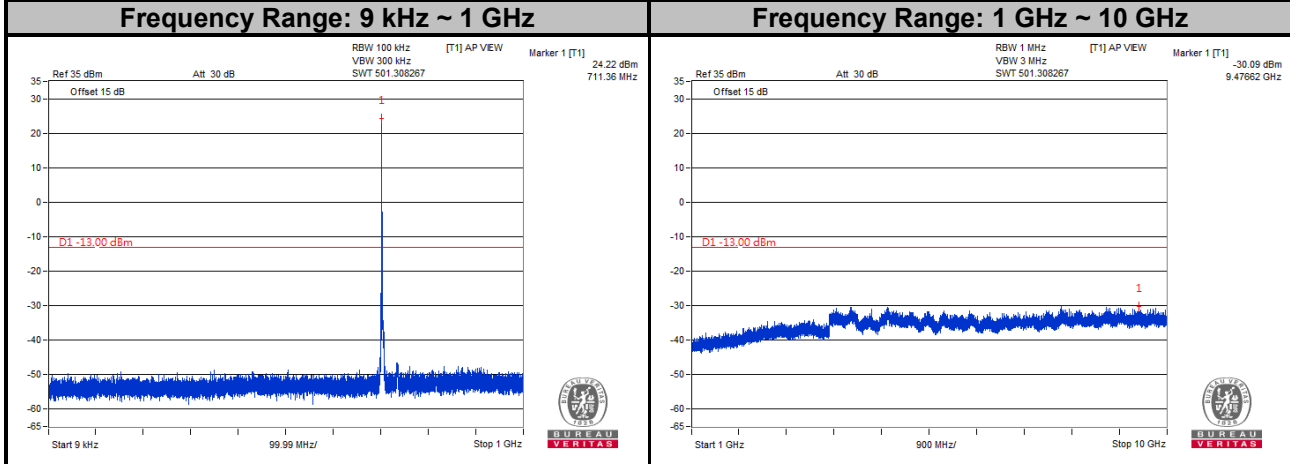

LTE Band 12
Channel Bandwidth: 10 MHz
Channel 23060

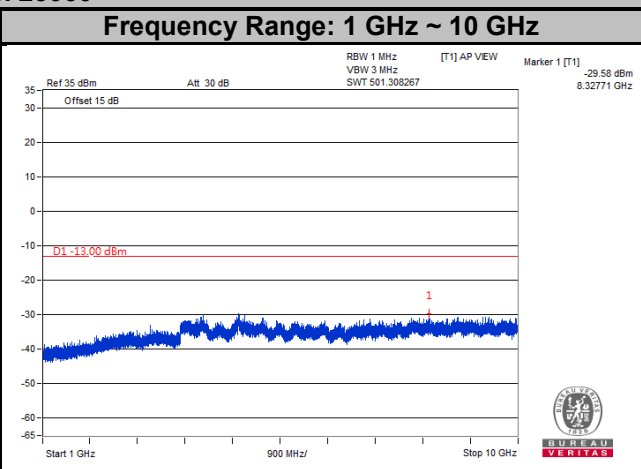
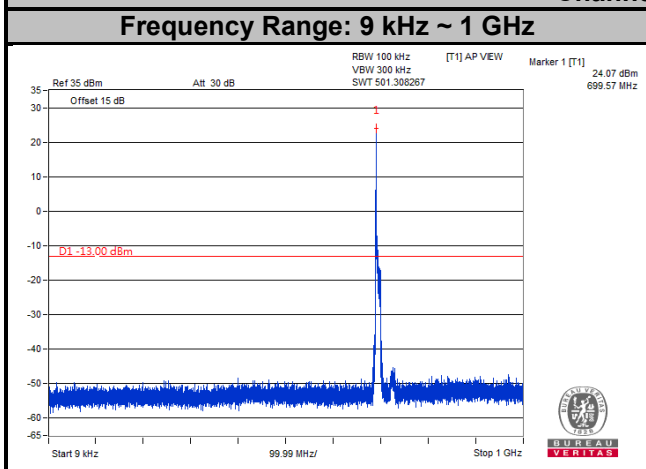

Channel 23095

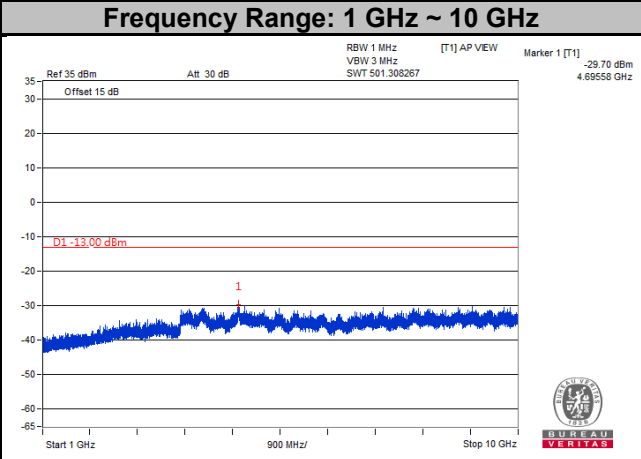
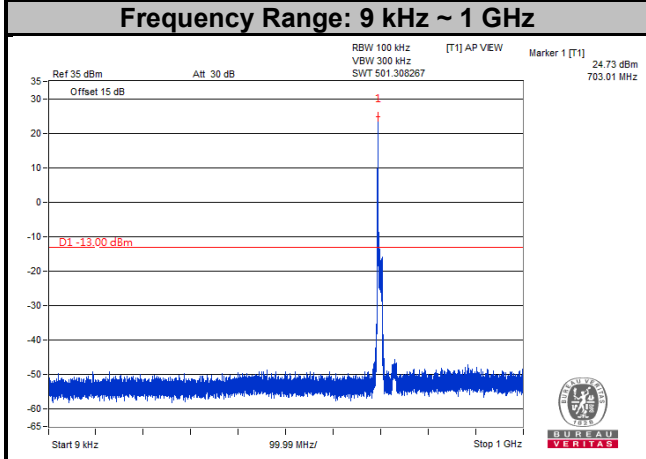

Channel 23130

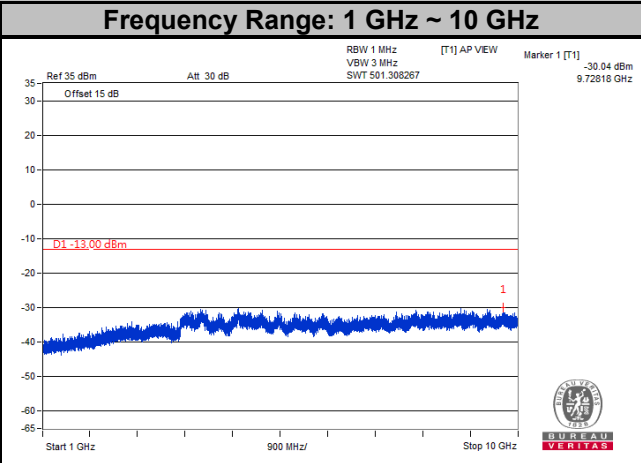
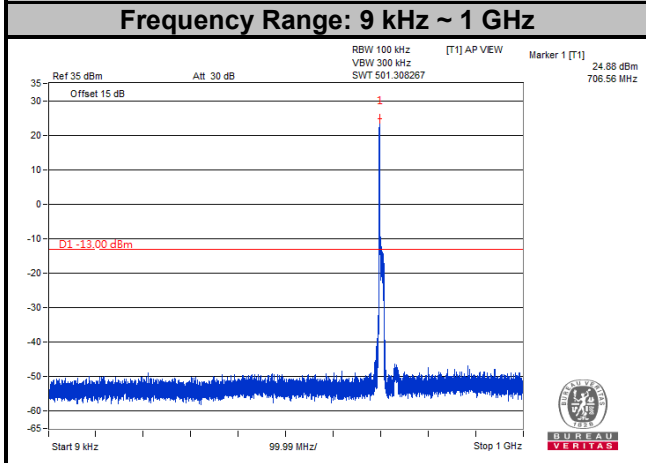

LTE Band 13
Channel Bandwidth: 5 MHz

Channel 23205

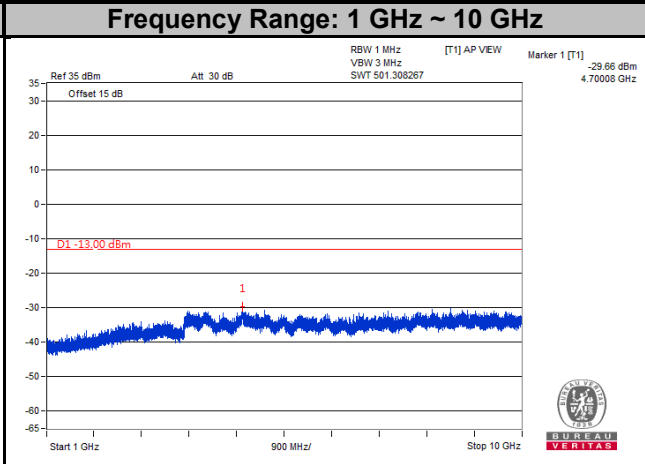
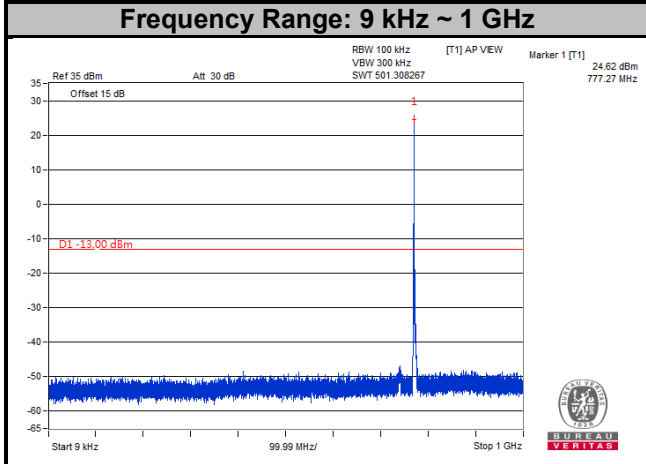

Channel 23230

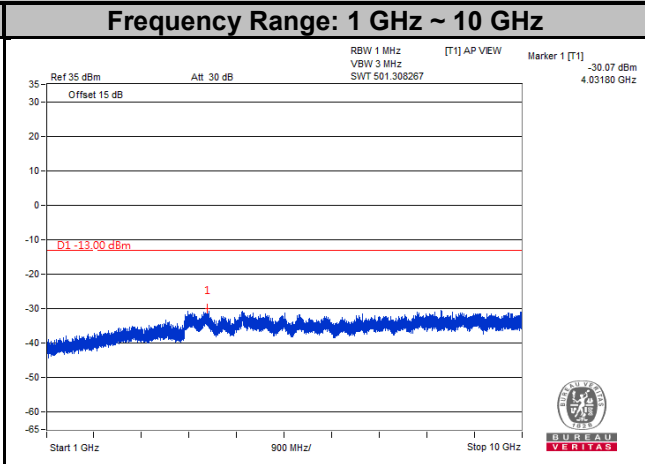
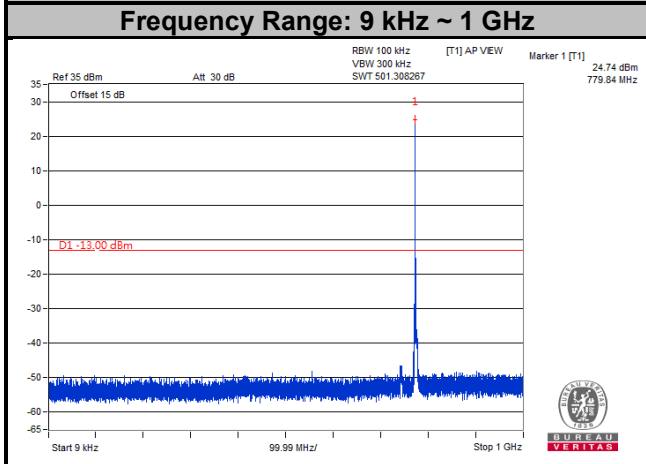

Channel 23255

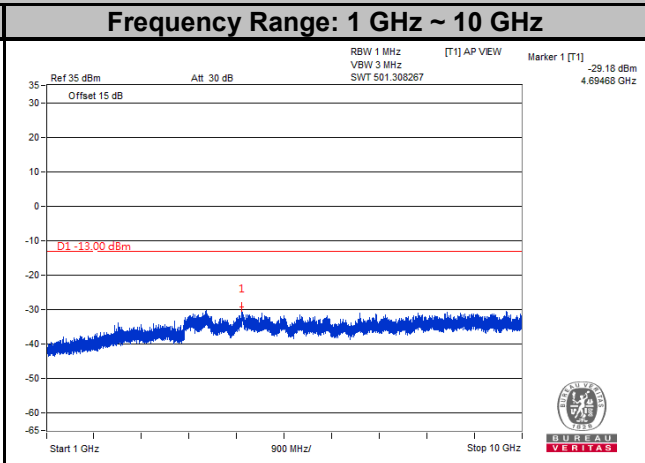
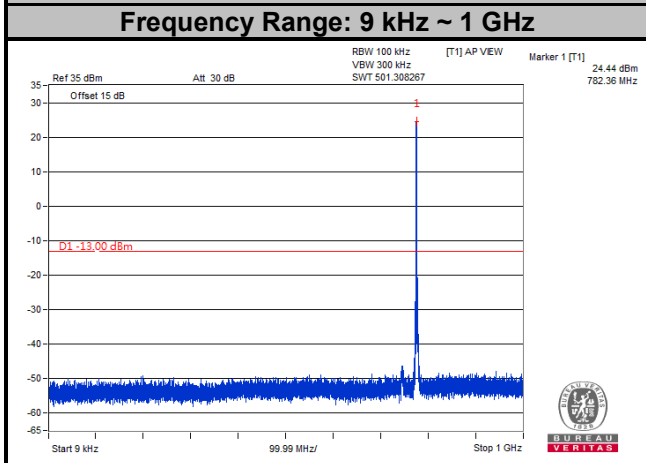

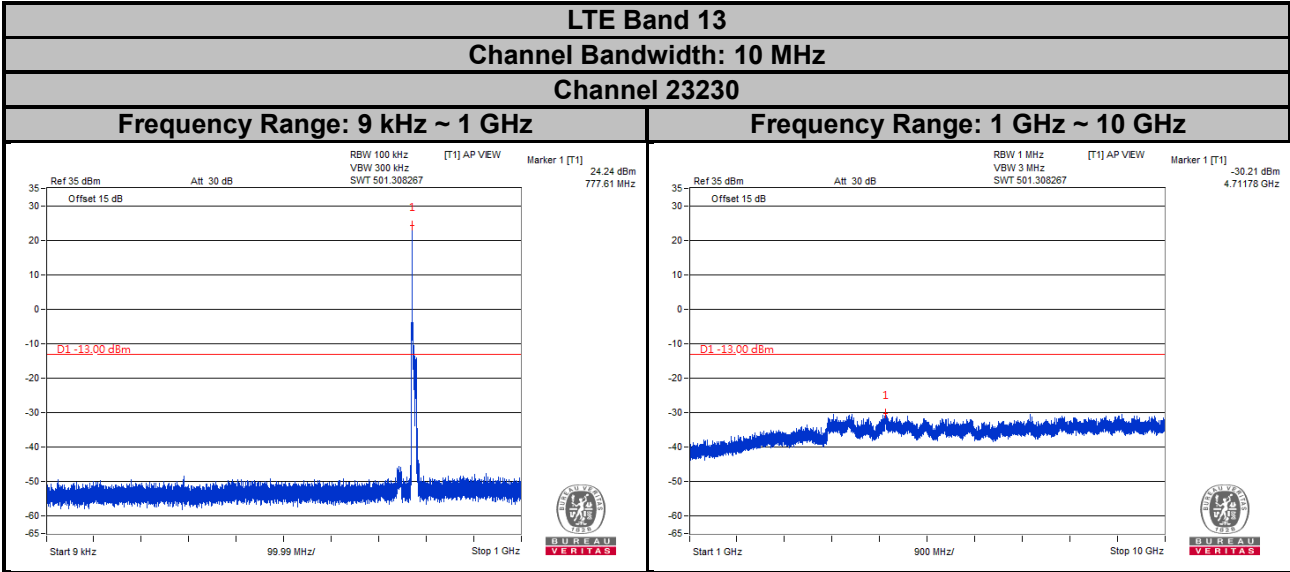

LTE Band 17
Channel Bandwidth: 5 MHz
Channel 23755

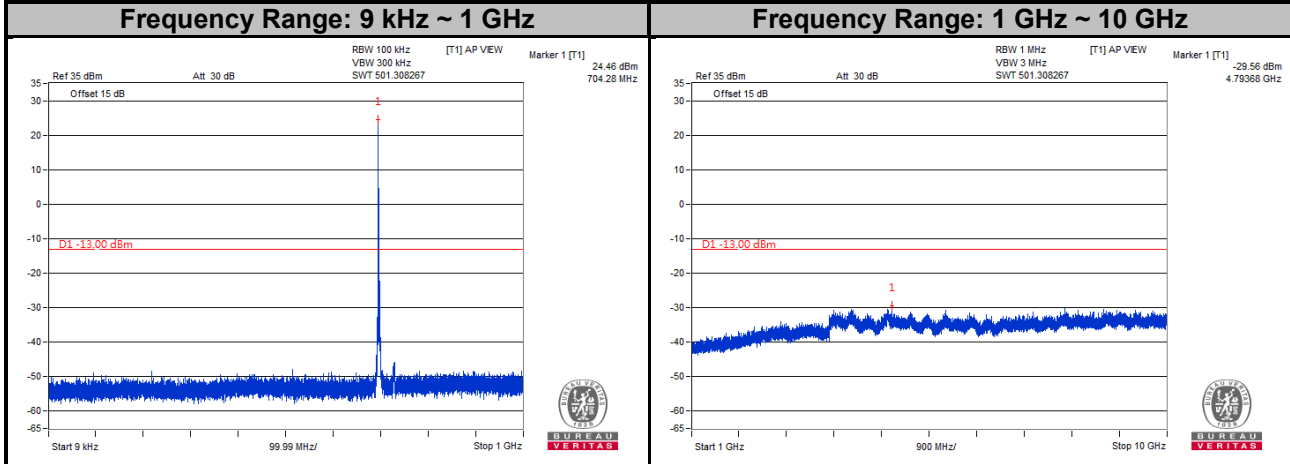

Channel 23790

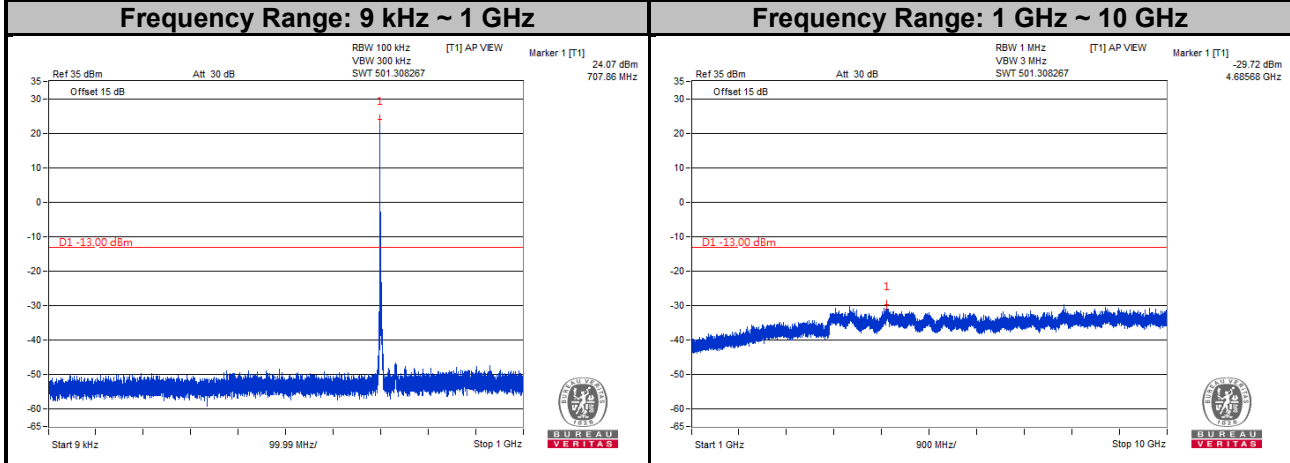

Channel 23825

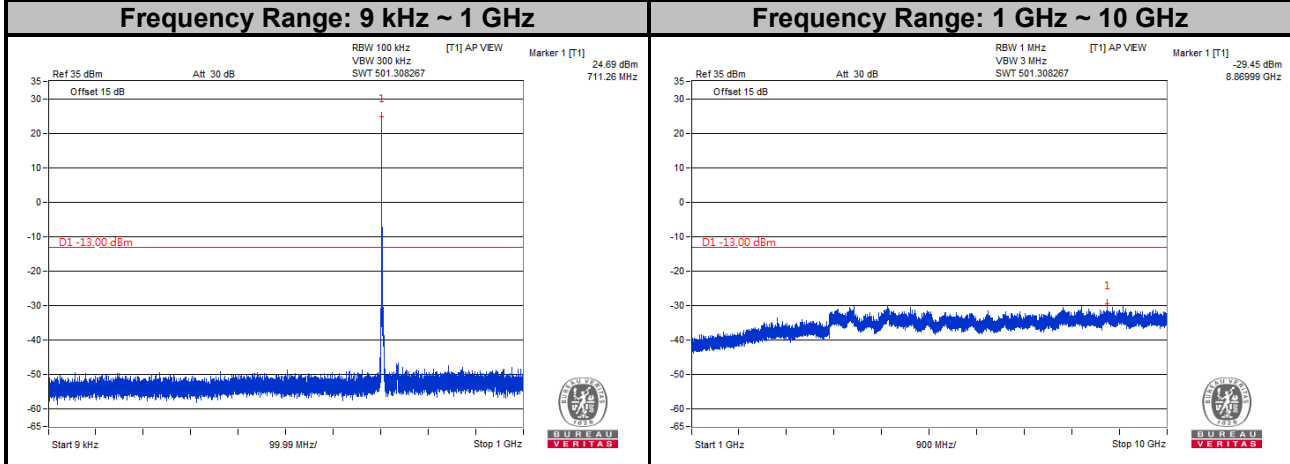

LTE Band 17
Channel Bandwidth: 10 MHz
Channel 23780

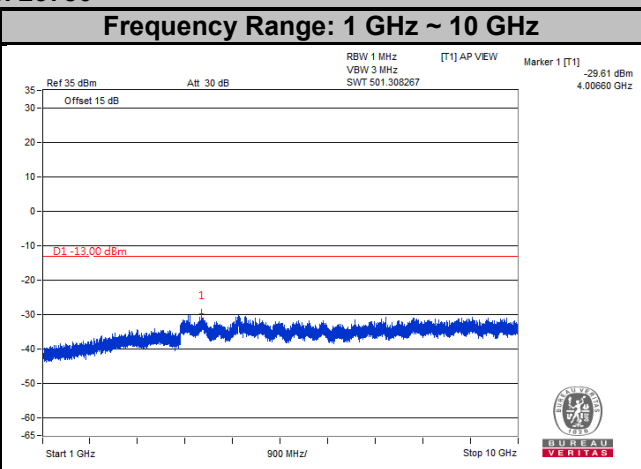
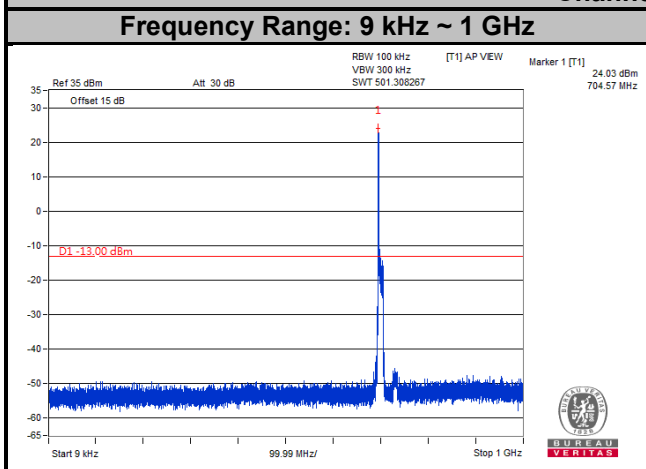

Channel 23790

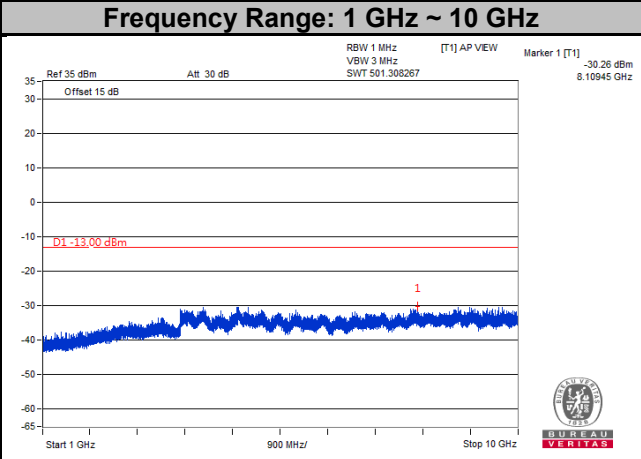
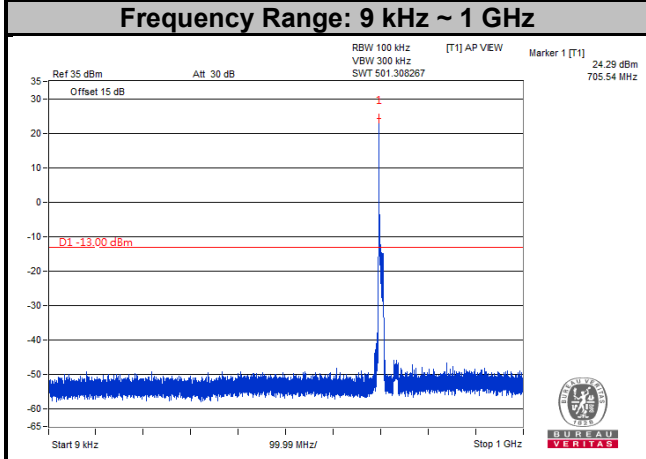

Channel 23800

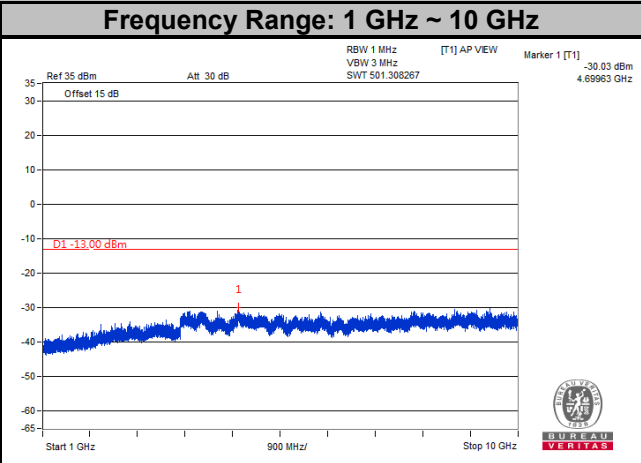
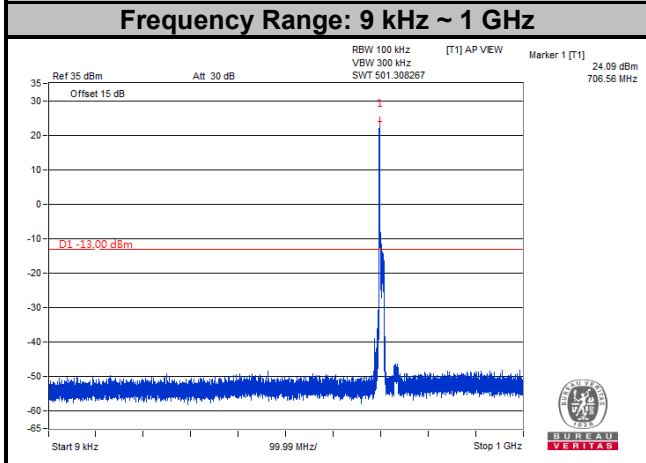

LTE Band 66
Channel Bandwidth: 1.4 MHz
Channel 131979

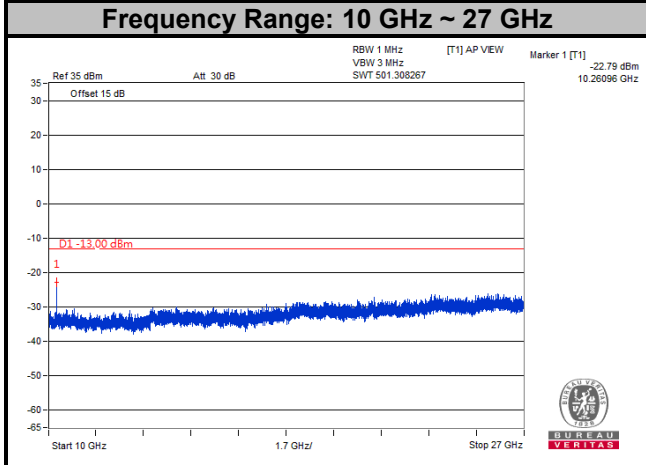
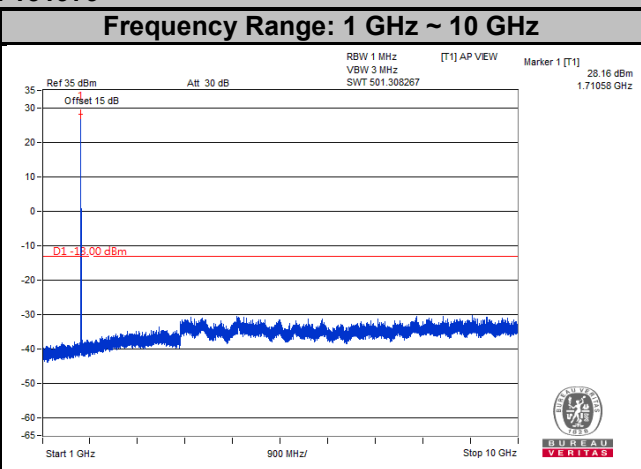
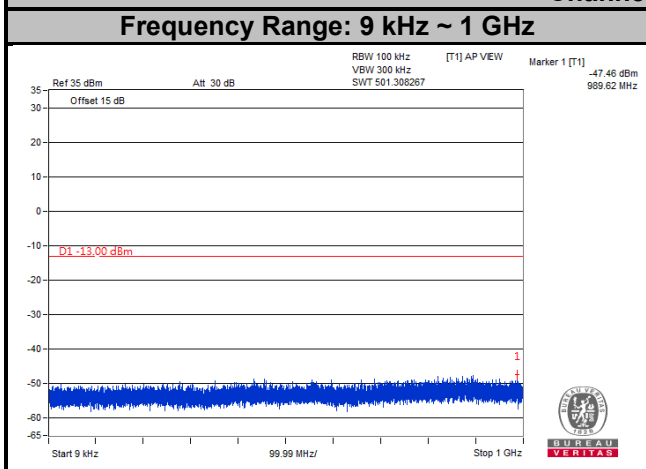

LTE Band 66

Channel Bandwidth: 1.4 MHz

Channel 132322

Frequency Range: 9 kHz ~ 1 GHz

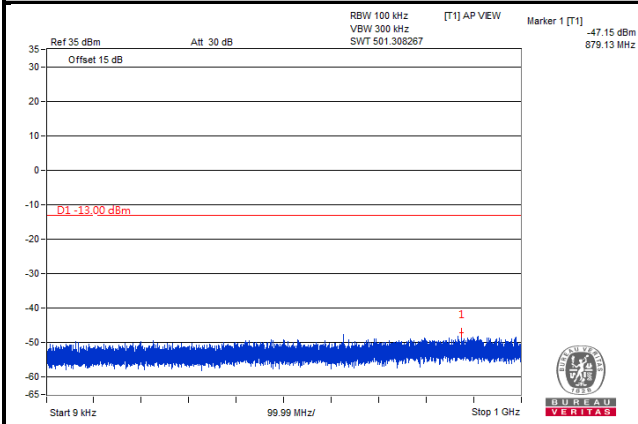

Frequency Range: 1 GHz ~ 10 GHz

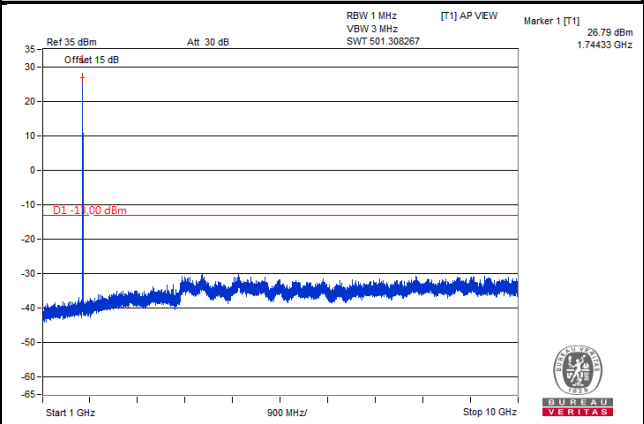

Frequency Range: 10 GHz ~ 27 GHz

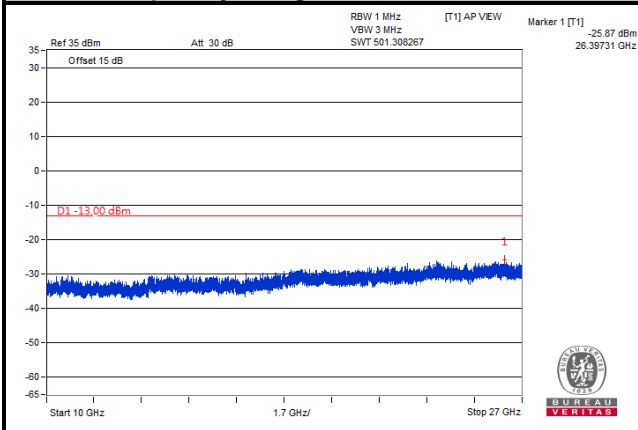

LTE Band 66
Channel Bandwidth: 1.4 MHz
Channel 132655

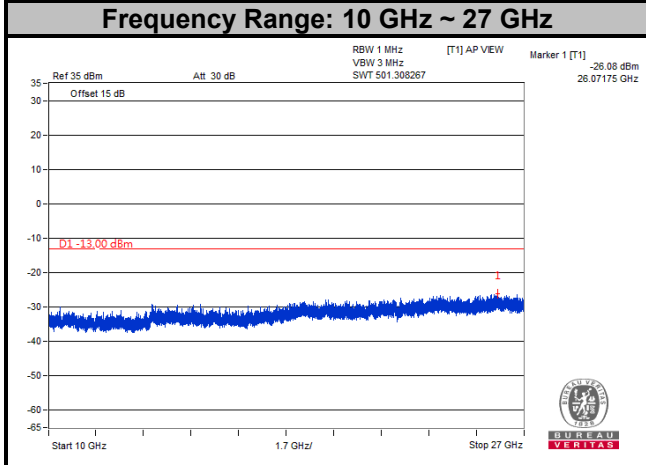
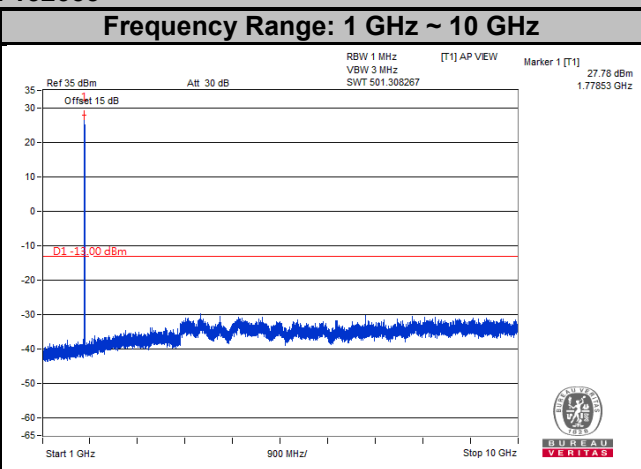
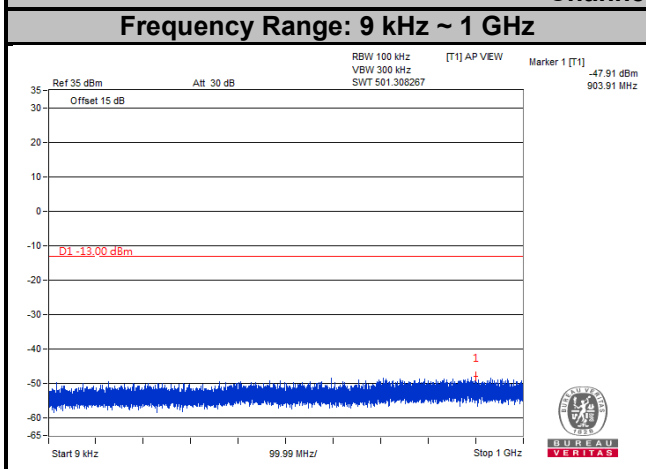

LTE Band 66
Channel Bandwidth: 3 MHz
Channel 131987

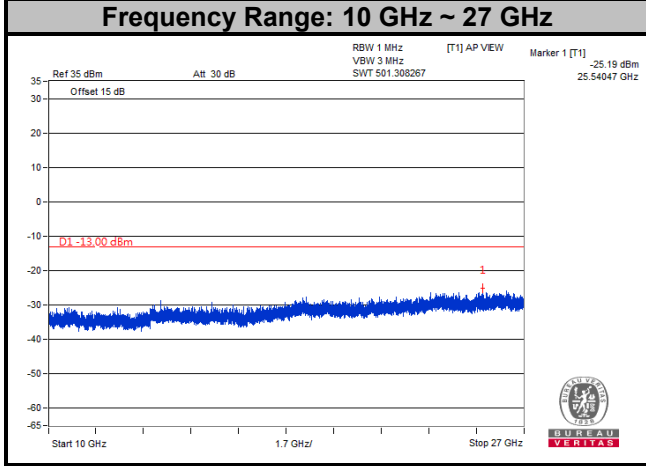
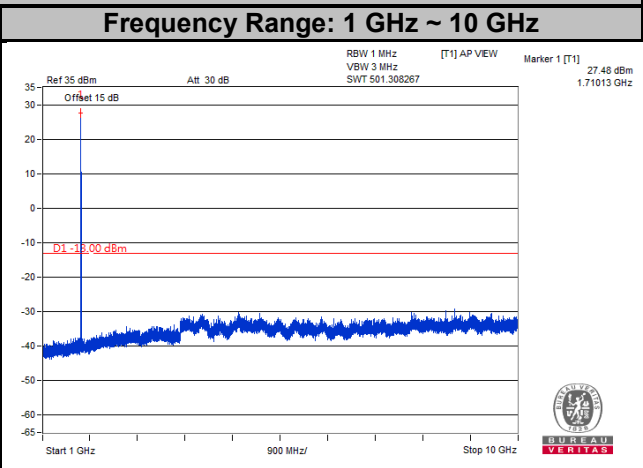
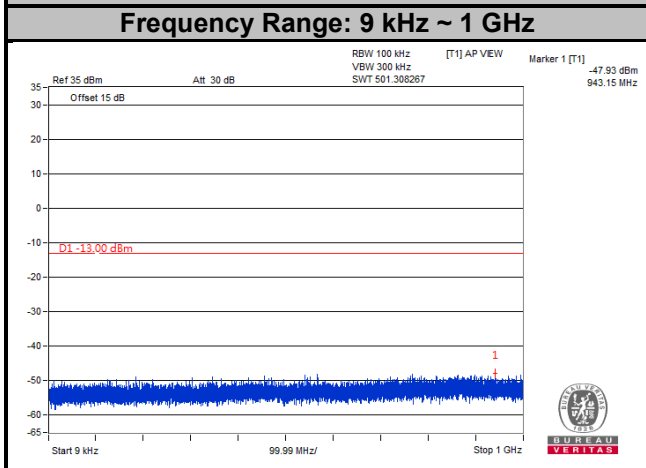

LTE Band 66
Channel Bandwidth: 3 MHz
Channel 132322

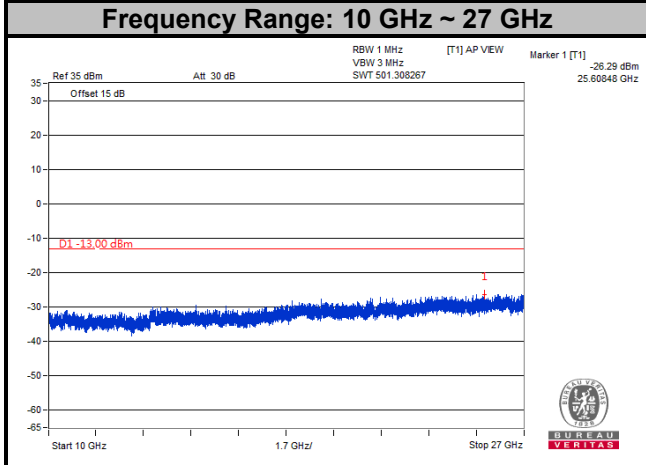
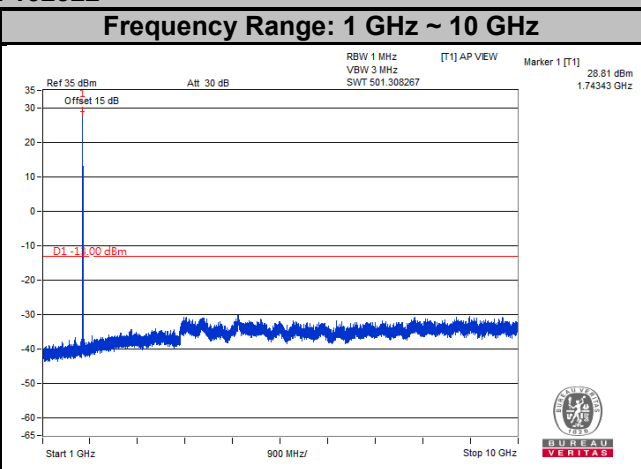
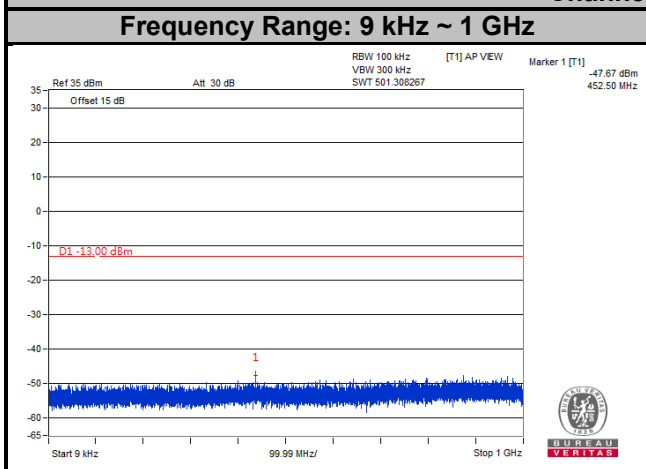

LTE Band 66

Channel Bandwidth: 3 MHz

Channel 132657

Frequency Range: 9 kHz ~ 1 GHz

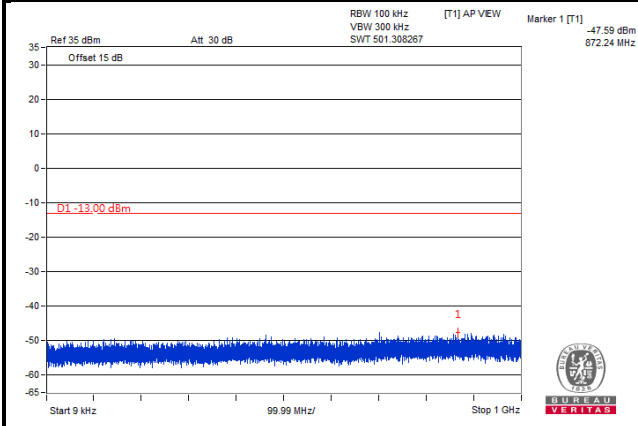

Frequency Range: 1 GHz ~ 10 GHz

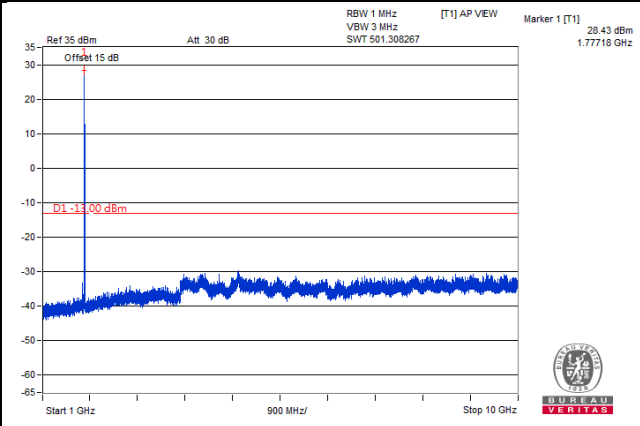

Frequency Range: 10 GHz ~ 27 GHz

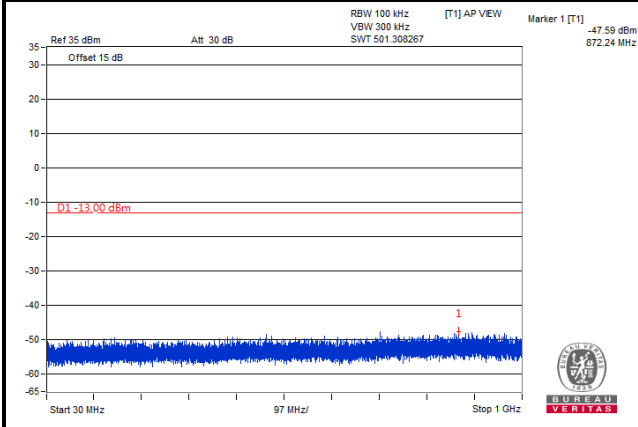

LTE Band 66

Channel Bandwidth: 5 MHz

Channel 131997

Frequency Range: 9 kHz ~ 1 GHz

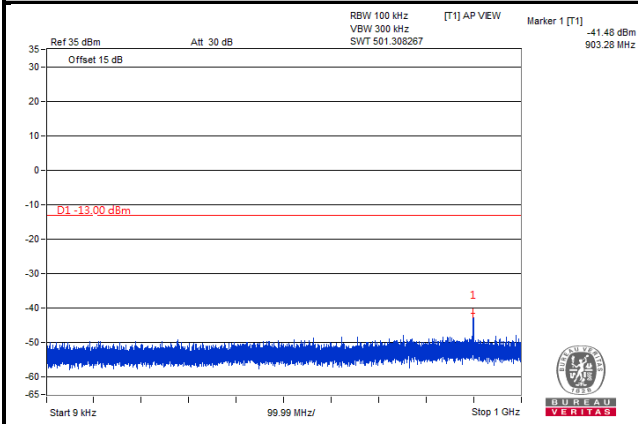

Frequency Range: 1 GHz ~ 10 GHz

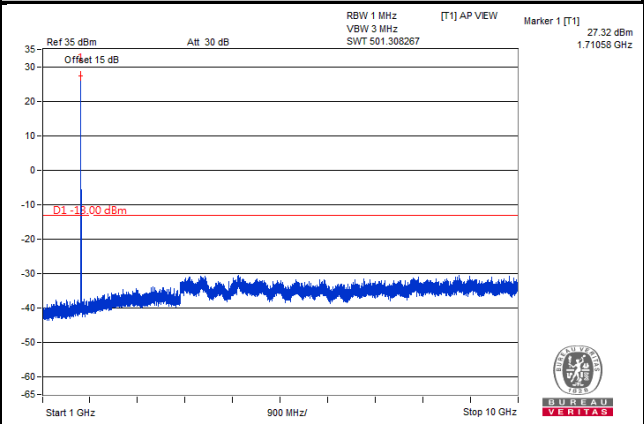

Frequency Range: 10 GHz ~ 27 GHz

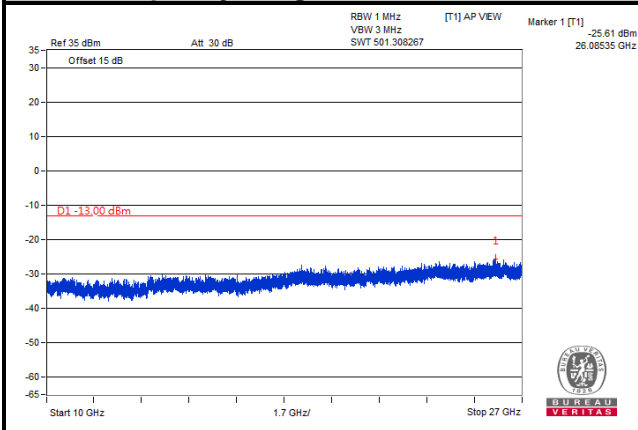

LTE Band 66
Channel Bandwidth: 5 MHz
Channel 132322

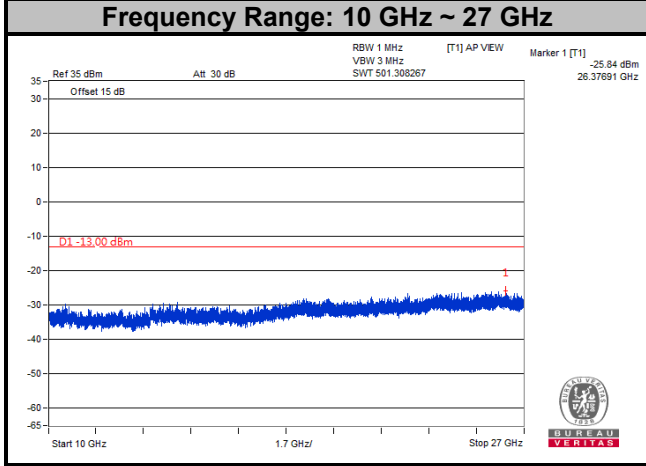
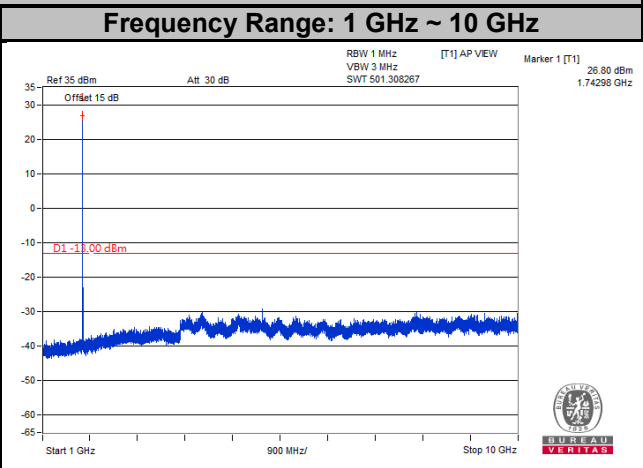
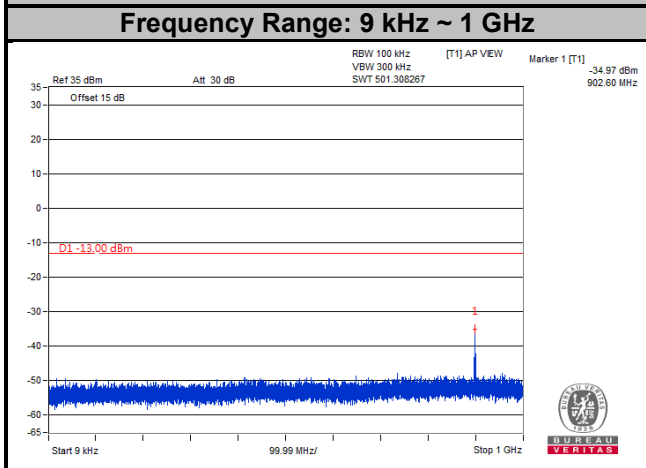

LTE Band 66
Channel Bandwidth: 5 MHz
Channel 132647

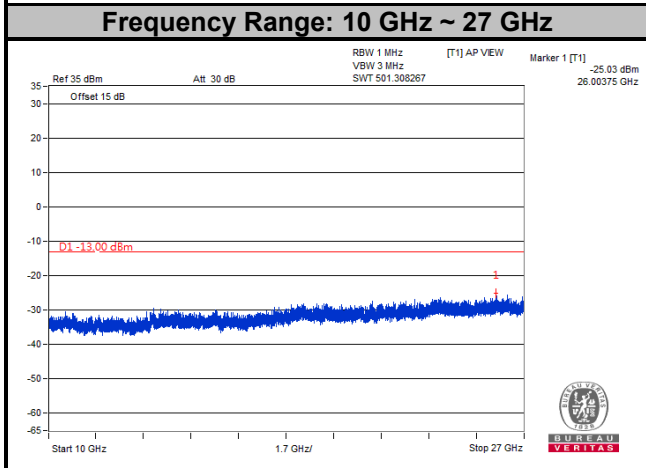
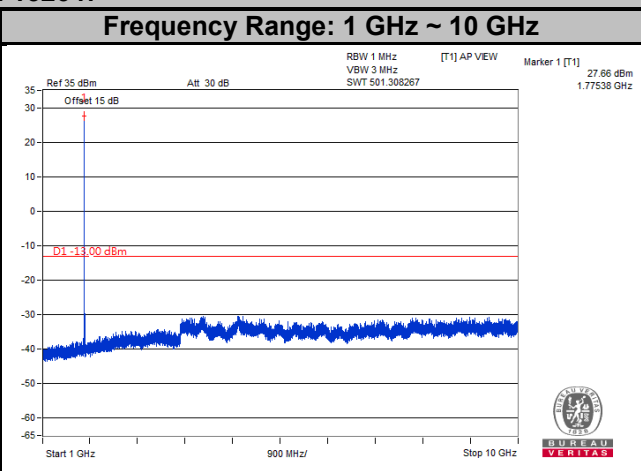
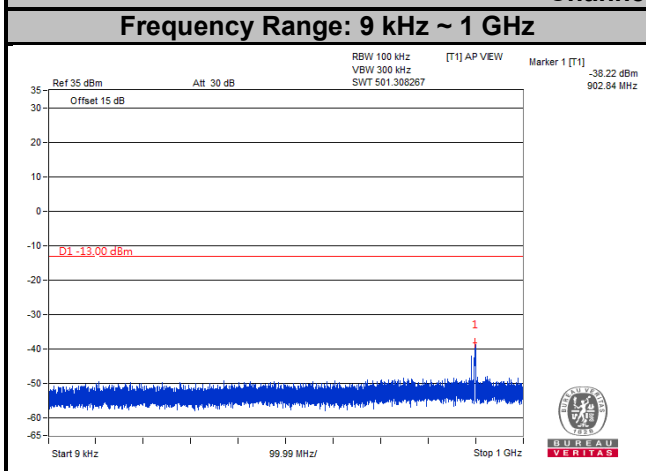

LTE Band 66
Channel Bandwidth: 10 MHz
Channel 132022

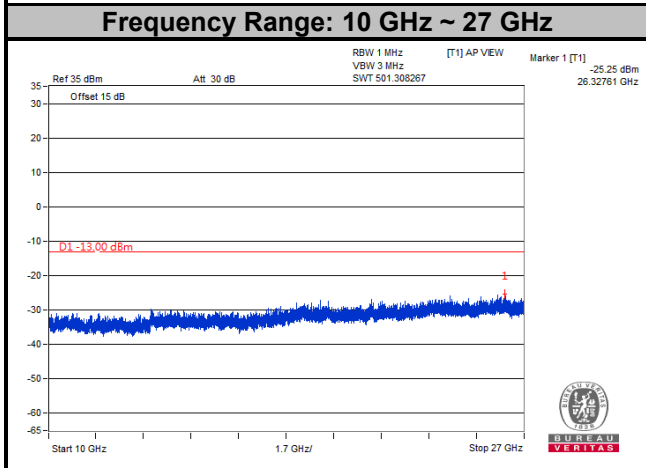
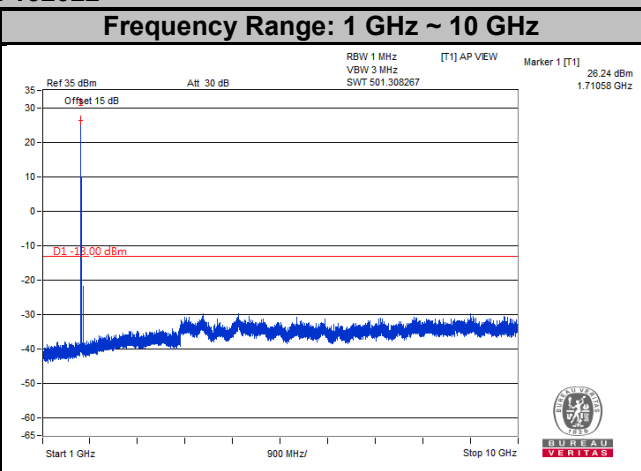
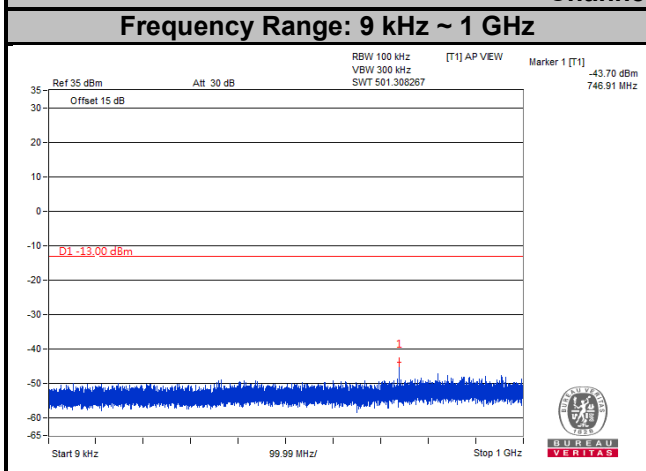

LTE Band 66
Channel Bandwidth: 10 MHz
Channel 132322

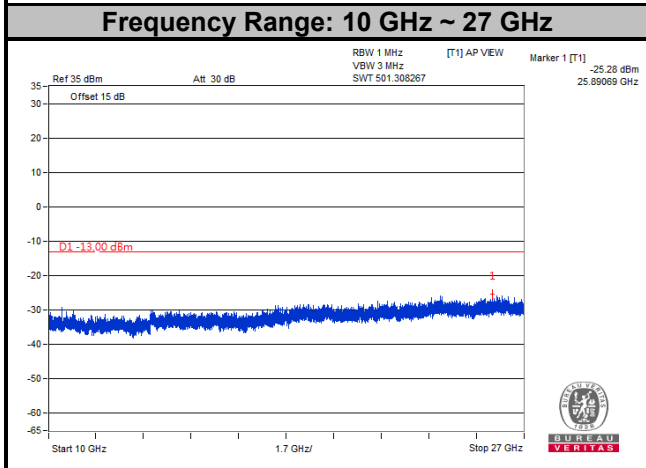
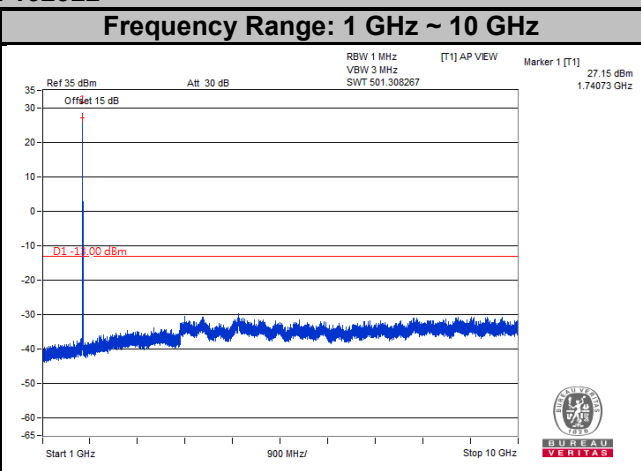
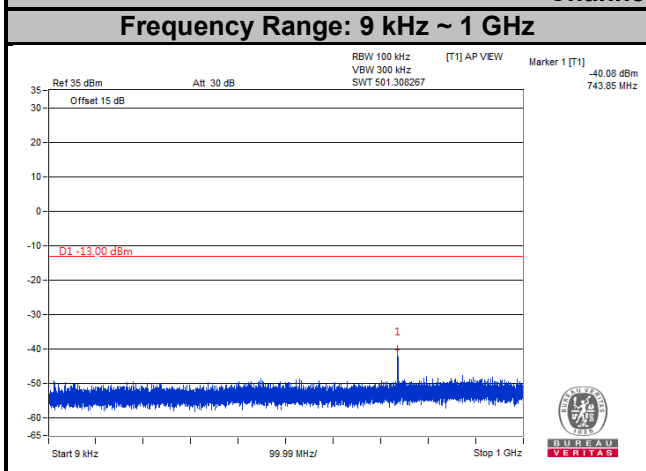

LTE Band 66
Channel Bandwidth: 10 MHz
Channel 132622

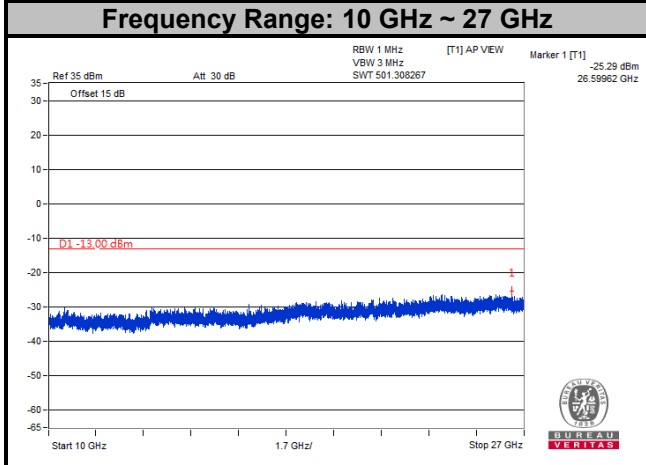
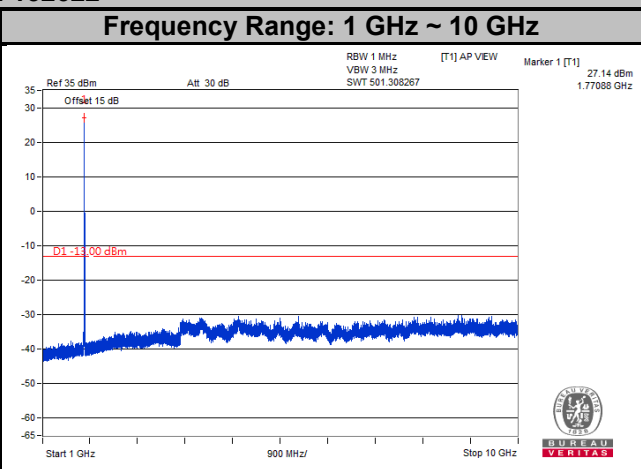
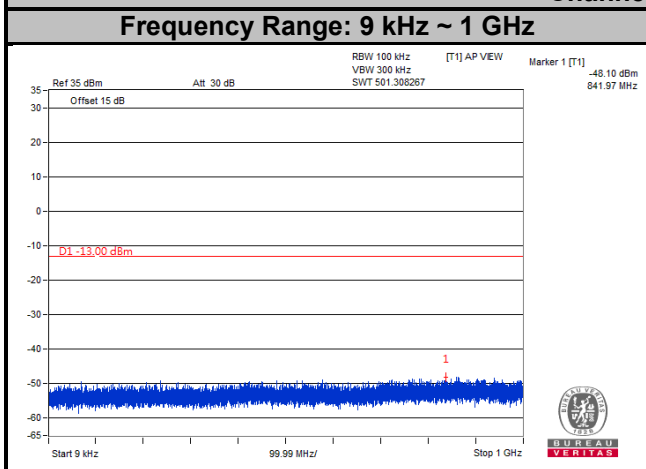

LTE Band 66
Channel Bandwidth: 15 MHz
Channel 132047

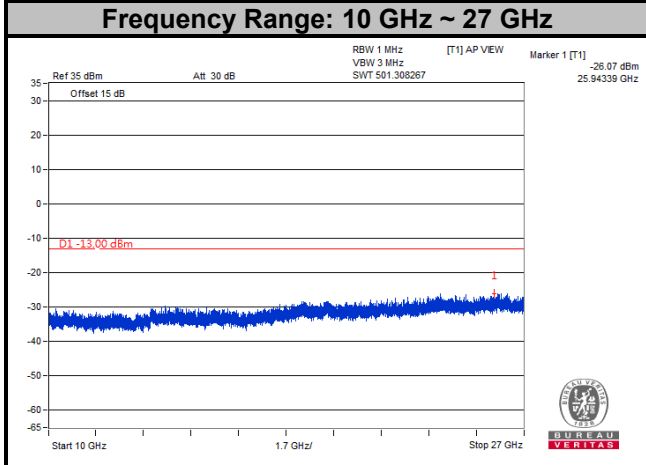
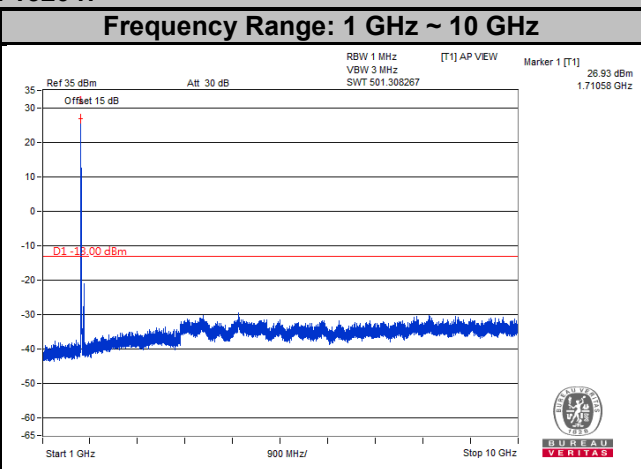
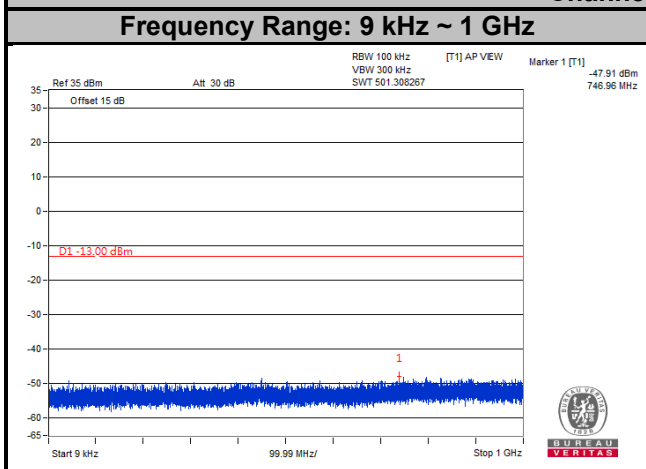

LTE Band 66
Channel Bandwidth: 15 MHz
Channel 132322

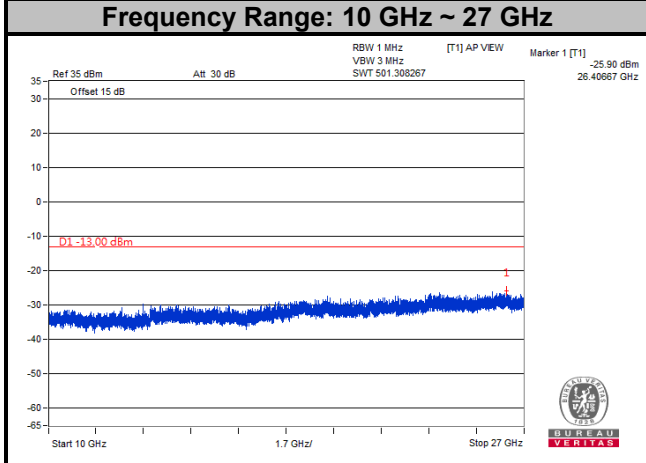
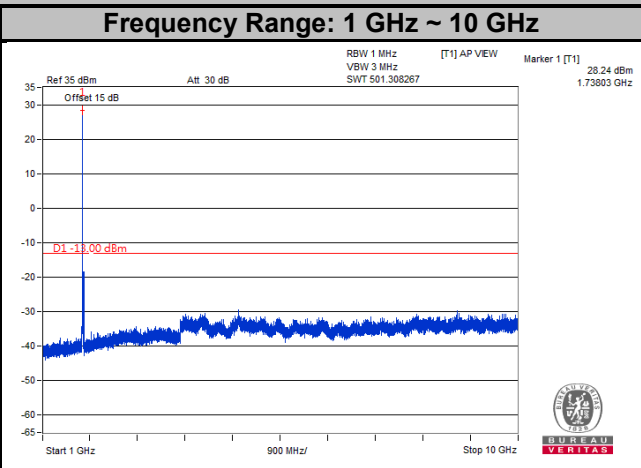
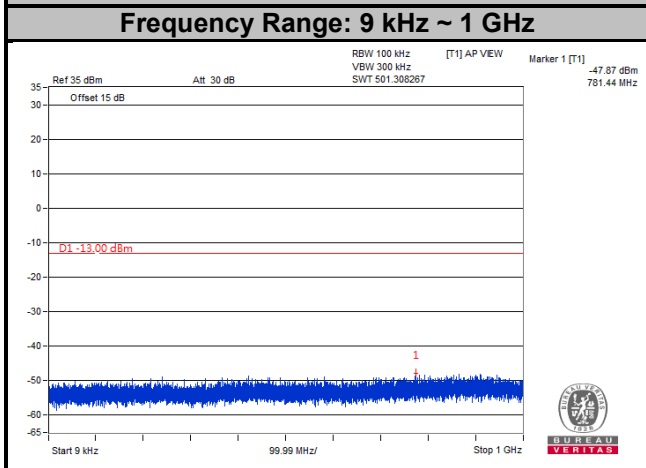

LTE Band 66
Channel Bandwidth: 15 MHz
Channel 132597

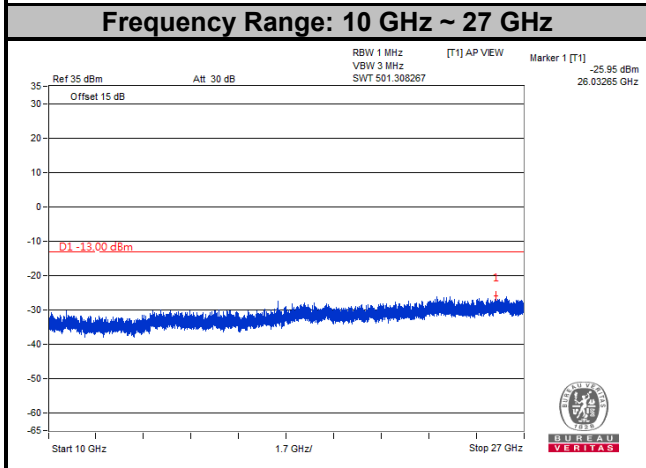
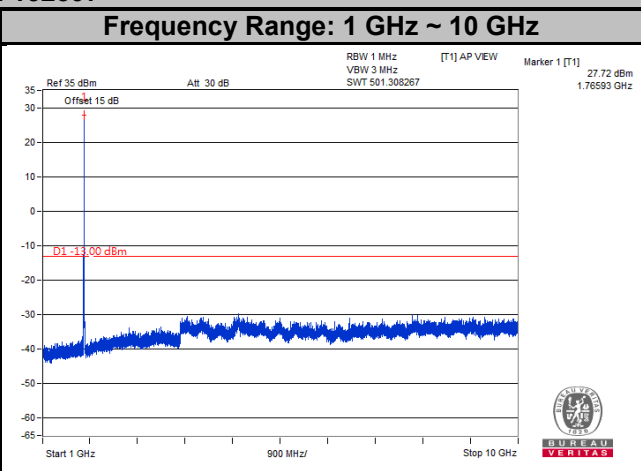
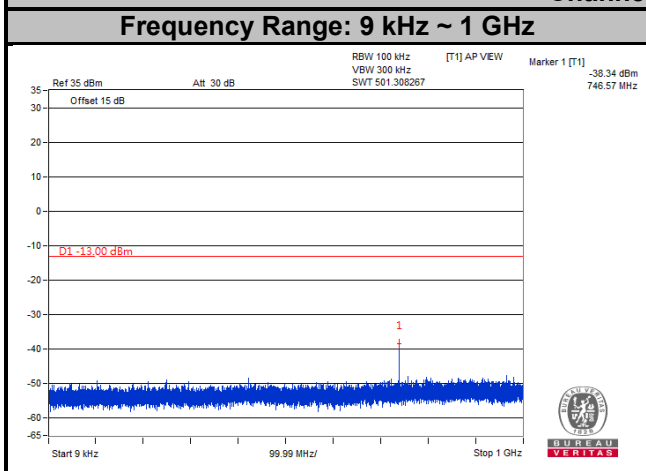

LTE Band 66
Channel Bandwidth: 20 MHz
Channel 132072

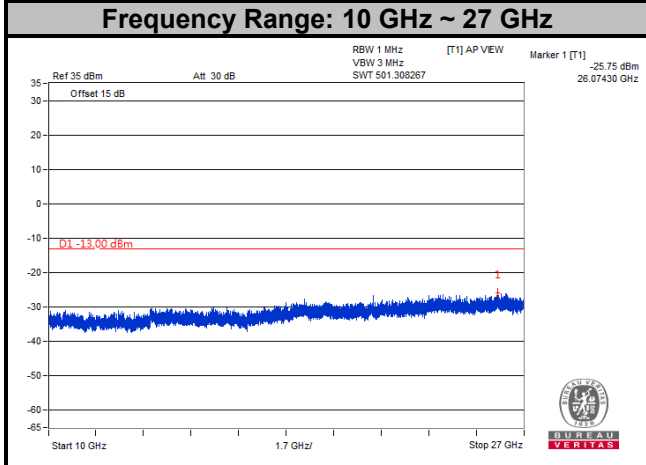
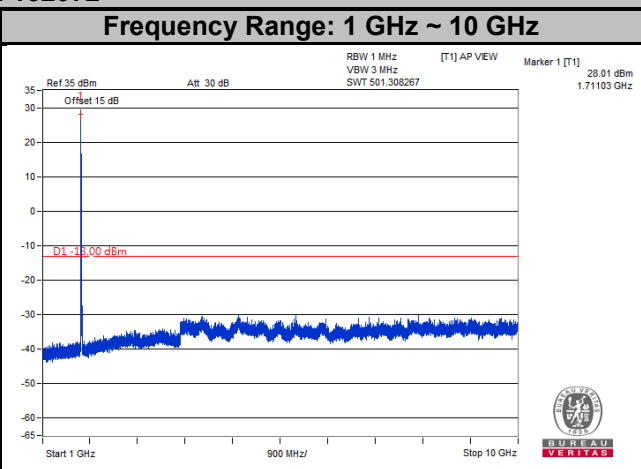
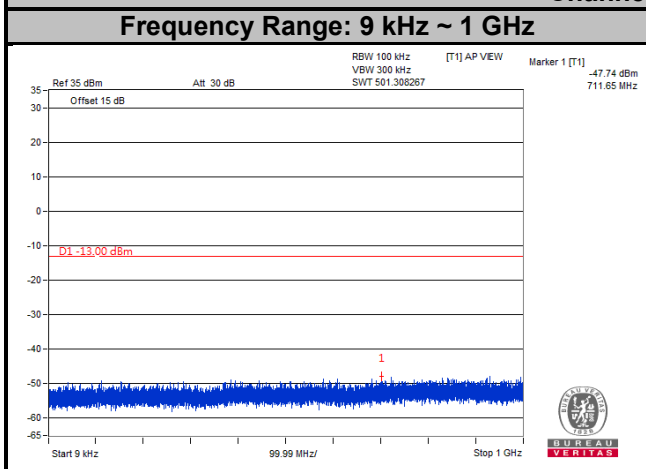

LTE Band 66
Channel Bandwidth: 20 MHz
Channel 132322

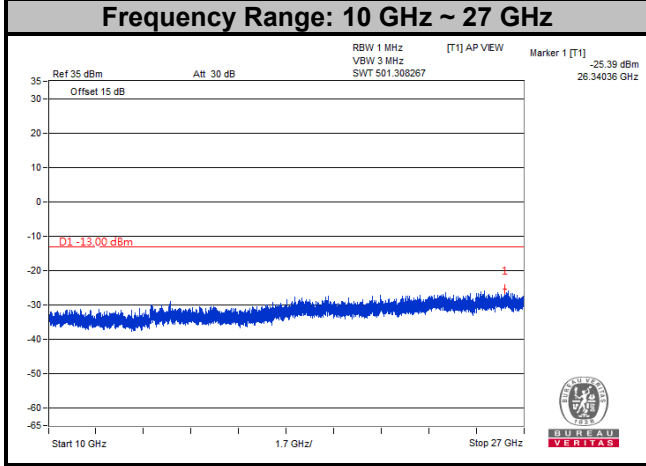
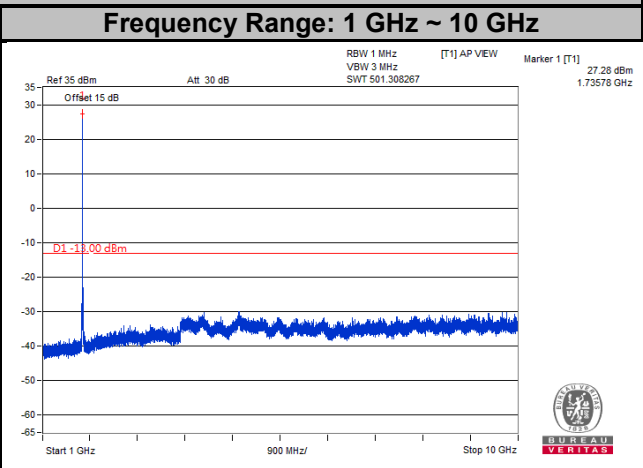
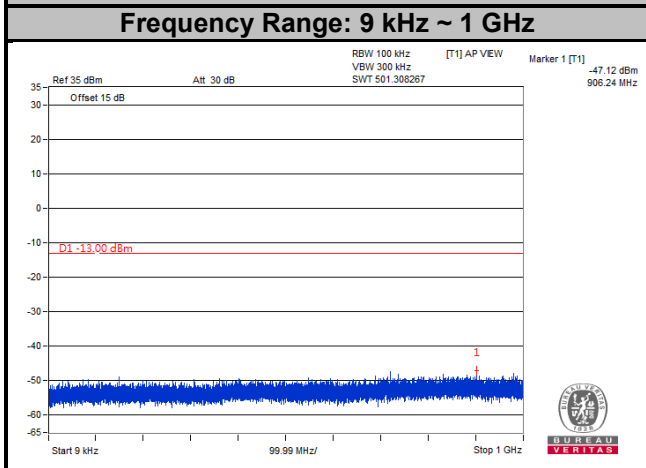

LTE Band 66
Channel Bandwidth: 20 MHz
Channel 132572

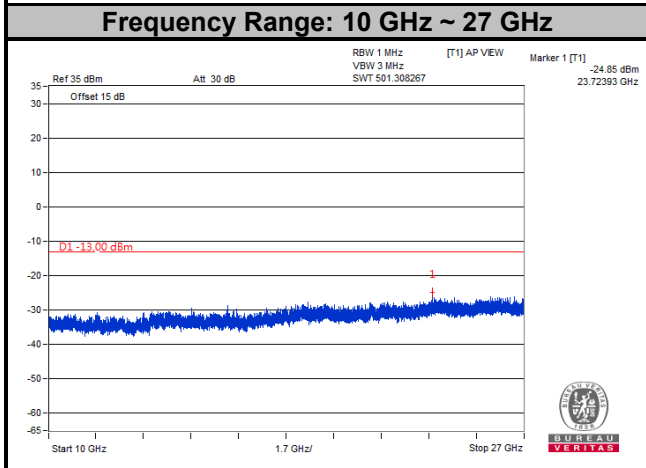
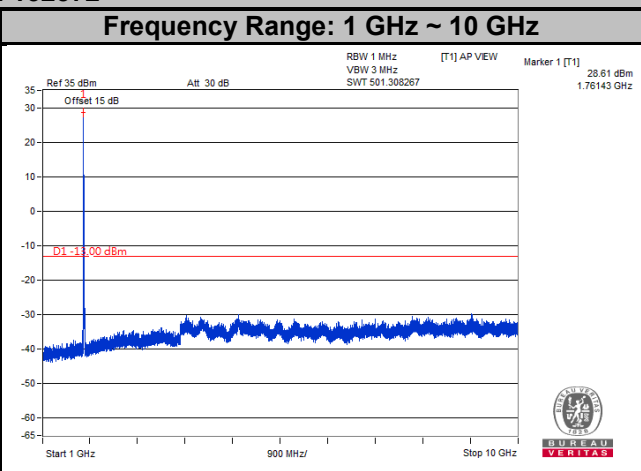
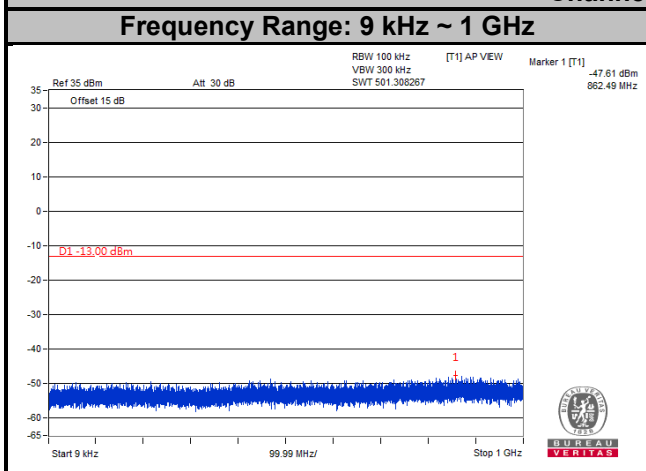

4.8 Radiated Emission Measurement

4.8.1 Limits of Radiated Emission Measurement

- a. The power of any emission outside a licensee's frequency block shall be attenuated below the transmitter power (P) by at least $43 + 10 \log (P)$ dB. The limit of emission is equal to -13 dBm.
- b. For operations in the 775-788 MHz, emissions in the band 1559-1610 MHz shall be limited to -70 dBW/MHz. The limit of emissions is equal to -40 dBm.

4.8.2 Test Procedure

- a. Substitution method is used for E.I.R.P measurement. In the semi-anechoic chamber, EUT placed on the 0.8 m (below or equal 1 GHz) and/or 1.5 m (above 1 GHz) height of Turn Table, rotated the table around 360 degrees to search the maximum radiation power and receiver antenna shall be rotated vertical and horizontal polarization and moved height from 1 m to 4 m to find the maximum polar radiated power. The "Read Value" is the spectrum reading the maximum power value.
- b. The substitution horn antenna is substituted for EUT at the same position and signals generator export the CW signal to the substitution antenna via a TX cable. Rotated the Turn Table and moved receiving antenna to find the maximum radiation power. Adjust output power level of S.G to get a Value of spectrum reading equal to "Read Value" of step a. Record the power level of S.G.
- c. $EIRP = \text{Output power level of S.G} - \text{TX cable loss} + \text{Antenna gain of substitution horn}$.
- d. E.R.P power can be calculated form E.I.R.P power by subtracting the gain of dipole, $E.R.P \text{ power} = E.I.R.P \text{ power} - 2.15 \text{ dB}$.

Note: The resolution bandwidth of spectrum analyzer is 1 MHz and the video bandwidth is 3 MHz.

4.8.3 Deviation from Test Standard

No deviation.

4.8.4 Test Setup

<Radiated Emission below or equal 1 GHz>

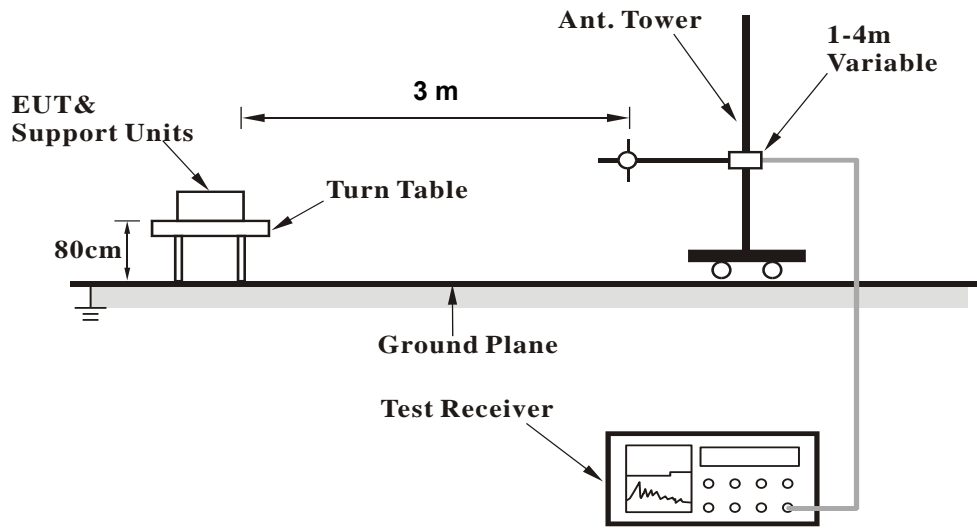

<Radiated Emission above 1 GHz>

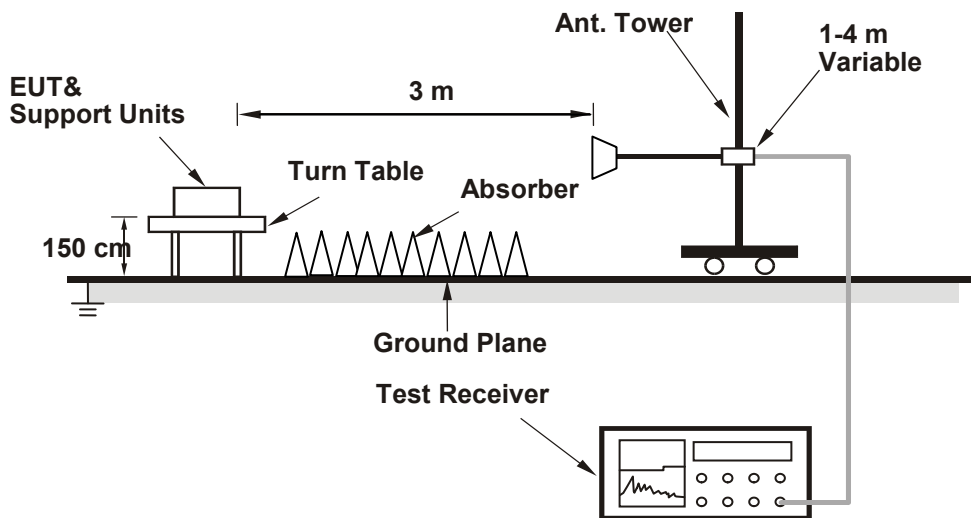

For the actual test configuration, please refer to the attached file (Test Setup Photo).

4.8.5 Test Results

WCDMA:
Low Channel



Bureau Veritas Consumer Products Services Ltd., Taoyuan Branch

A D T

Data: 3

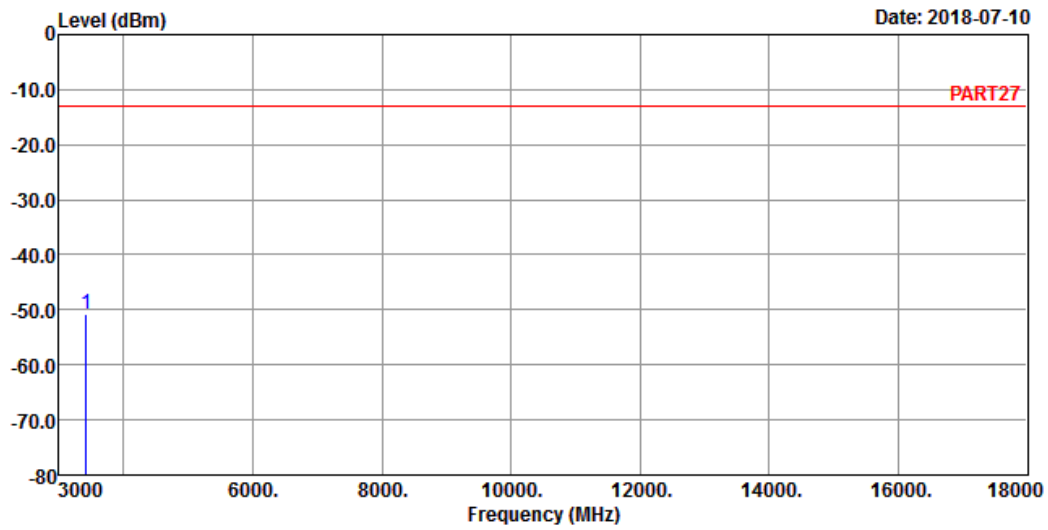

Site : 966 Chamber 5
Condition: PART27 HORIZONTAL
Remak : WCDMA Band 4 L-CH Link
Tested by: Jisyong Wang

Freq	Level	Read Level	Limit Line	Over Limit	Factor	Remark
MHz	dBm	dBm	dBm	dB	dB	
1 pp 3424.80	-50.84	-42.50	-13.00	-37.84	-8.34	Peak



Bureau Veritas Consumer Products Services Ltd., Taoyuan Branch

A D T

Data: 4

Date: 2018-07-10

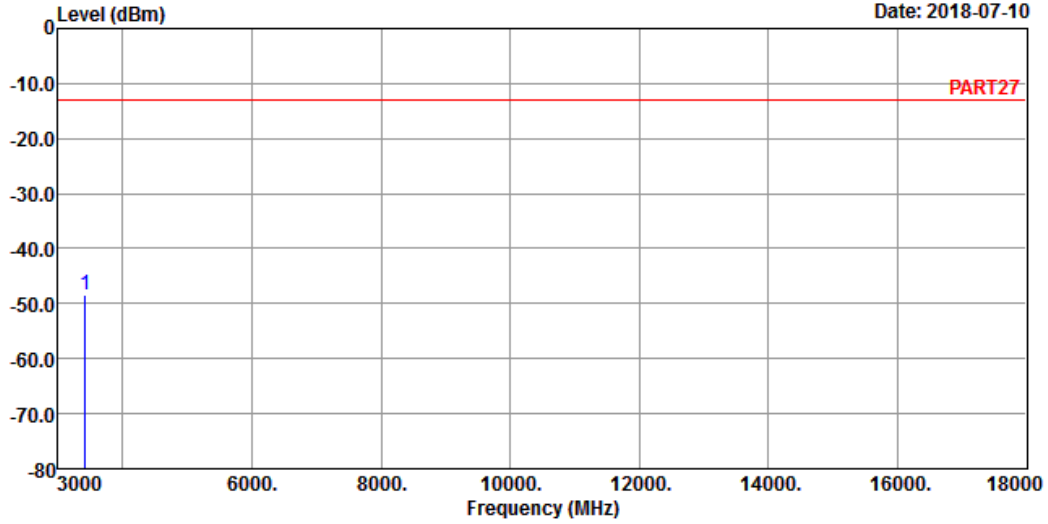

Site : 966 Chamber 5
 Condition: PART27 VERTICAL
 Remak : WCDMA Band 4 L-CH Link
 Tested by: Jisyong Wang

Freq	Level	Read Level	Limit Line	Over Limit	Factor	Remark
MHz	dBm	dBm	dBm	dB	dB	
1 pp 3424.80	-48.47	-40.13	-13.00	-35.47	-8.34	Peak

Middle Channel



Bureau Veritas Consumer Products Services Ltd., Taoyuan Branch

A D T

Data: 3

Date: 2018-07-10

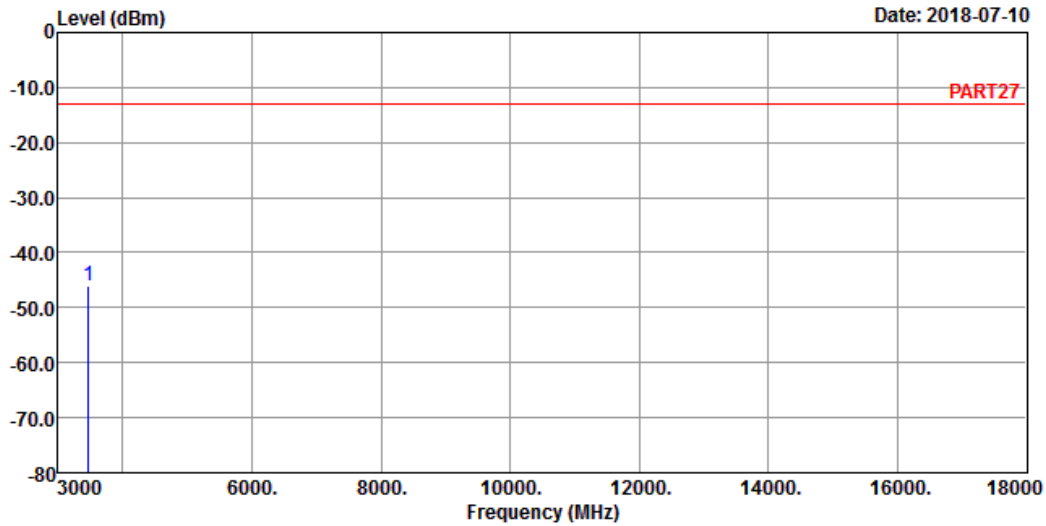

Site : 966 Chamber 5
 Condition: PART27 HORIZONTAL
 Remak : WCDMA Band 4 M-CH Link
 Tested by: Jisyong Wang

	Read	Limit	Over			
Freq	Level	Level	Line	Limit	Factor	Remark
MHz	dBm	dBm	dBm	dB	dB	
1 pp 3465.20	-46.18	-38.30	-13.00	-33.18	-7.88	Peak



Bureau Veritas Consumer Products Services Ltd., Taoyuan Branch

A D T

Data: 4

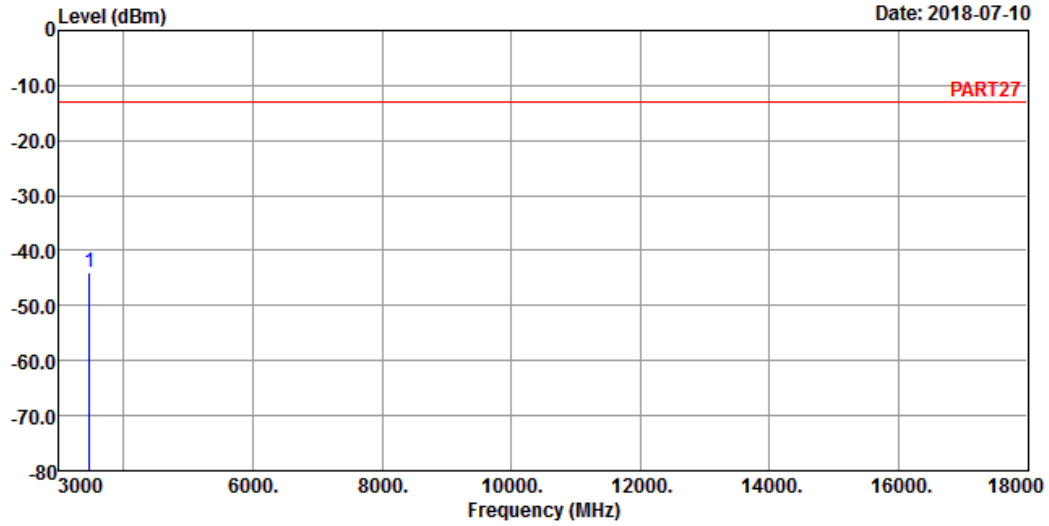

Site : 966 Chamber 5
 Condition: PART27 VERTICAL
 Remak : WCDMA Band 4 M-CH Link
 Tested by: Jisyong Wang

Freq	Level	Read Level	Limit Line	Over Limit	Factor	Remark
MHz	dBm	dBm	dBm	dB	dB	
1 pp 3465.20	-44.05	-36.17	-13.00	-31.05	-7.88	Peak

High Channel



Bureau Veritas Consumer Products Services Ltd., Taoyuan Branch

A D T

Data: 5

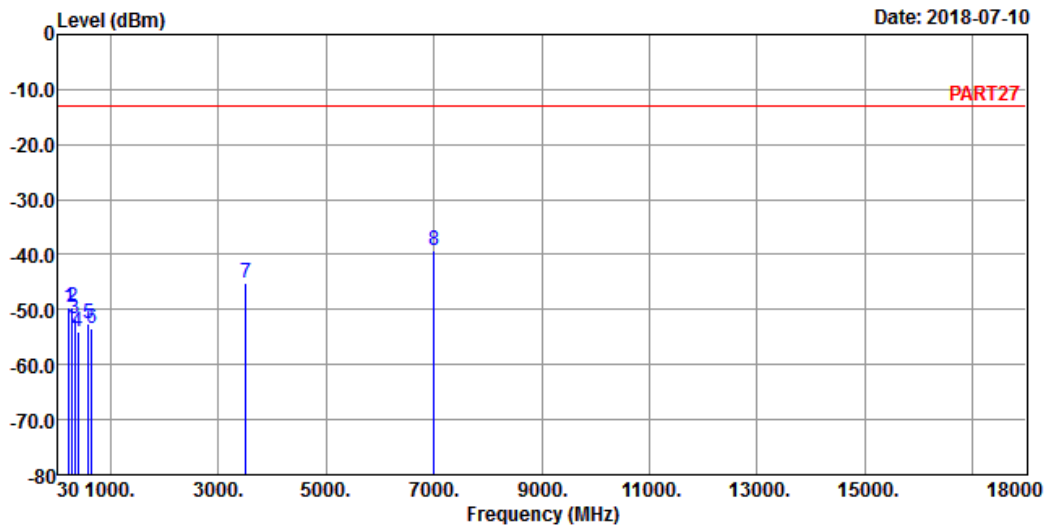

Site : 966 Chamber 5
 Condition: PART27 HORIZONTAL
 Remak : WCDMA Band 4 H-CH Link
 Tested by: Jisyong Wang

	Freq	Level	Read Level	Limit	Over	Factor	Remark
	MHz	dBm	dBm	dBm	dB	dB	
1	234.67	-49.62	-43.00	-13.00	-36.62	-6.62	Peak
2	286.08	-49.46	-42.73	-13.00	-36.46	-6.73	Peak
3	338.46	-51.78	-45.36	-13.00	-38.78	-6.42	Peak
4	390.84	-53.97	-47.97	-13.00	-40.97	-6.00	Peak
5	598.42	-52.47	-51.64	-13.00	-39.47	-0.83	Peak
6	650.80	-53.57	-52.70	-13.00	-40.57	-0.87	Peak
7	3505.20	-45.03	-37.58	-13.00	-32.03	-7.45	Peak
8 pp	7010.40	-39.19	-42.38	-13.00	-26.19	3.19	Peak



Bureau Veritas Consumer Products Services Ltd., Taoyuan Branch

A D T

Data: 6

Date: 2018-07-10

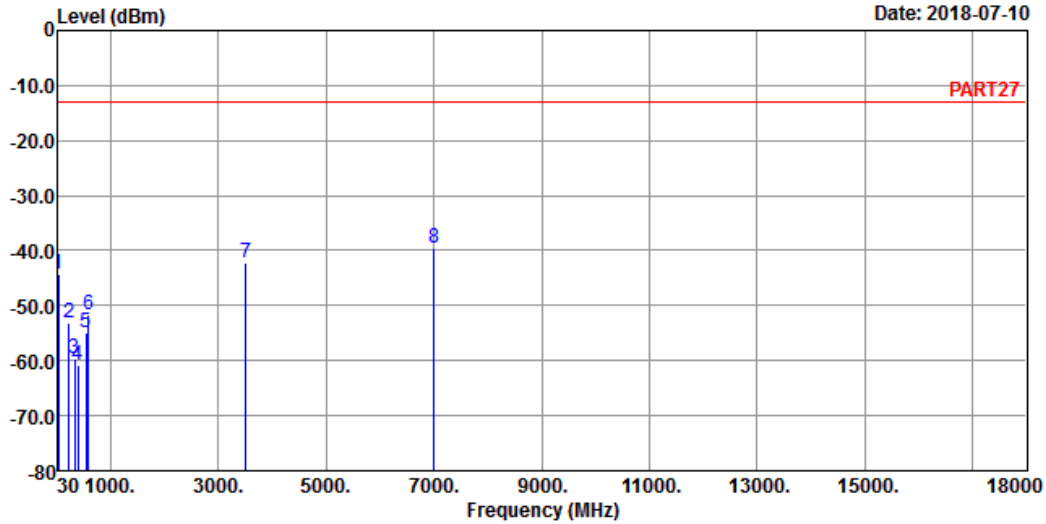

Site : 966 Chamber 5
 Condition: PART27 VERTICAL
 Remak : WCDMA Band 4 H-CH Link
 Tested by: Jisyong Wang

	Freq	Level	Read Level	Limit Line	Over Limit	Factor	Remark
	MHz	dBm	dBm	dBm	dB	dB	
1	40.67	-44.18	-44.30	-13.00	-31.18	0.12	Peak
2	234.67	-53.23	-46.61	-13.00	-40.23	-6.62	Peak
3	338.46	-59.76	-53.34	-13.00	-46.76	-6.42	Peak
4	390.84	-60.89	-54.89	-13.00	-47.89	-6.00	Peak
5	546.04	-54.80	-51.81	-13.00	-41.80	-2.99	Peak
6	598.42	-51.63	-50.80	-13.00	-38.63	-0.83	Peak
7	3505.20	-42.30	-34.85	-13.00	-29.30	-7.45	Peak
8 pp	7010.40	-39.46	-42.65	-13.00	-26.46	3.19	Peak

LTE Band 4
 Channel Bandwidth: 20 MHz / QPSK
 Low Channel



Bureau Veritas Consumer Products Services Ltd., Taoyuan Branch

A D T

Data: 1

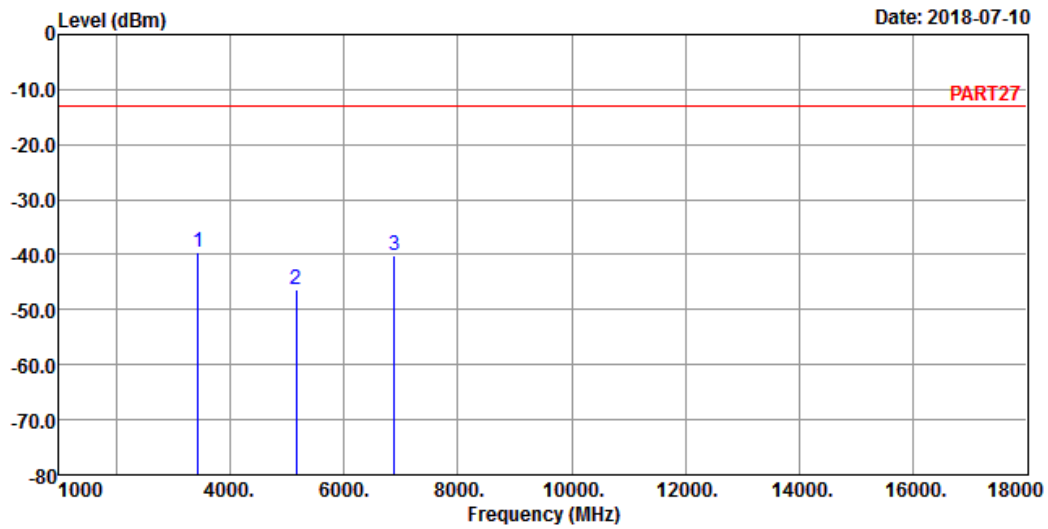

Site : 966 Chamber 5
 Condition: PART27 HORIZONTAL
 Remak : LTE Band 4 QPSK_20M Link_L-CH
 Tested by: Thomas Wei

	Freq	Level	Read Level	Limit Line	Over Limit	Factor	Remark
	MHz	dBm	dBm	dBm	dB	dB	
1	pp 3440.00	-39.63	-31.41	-13.00	-26.63	-8.22	Peak
2	5160.00	-46.37	-44.46	-13.00	-33.37	-1.91	Peak
3	6880.00	-40.12	-42.60	-13.00	-27.12	2.48	Peak



A D T

Data: 2

Date: 2018-07-10

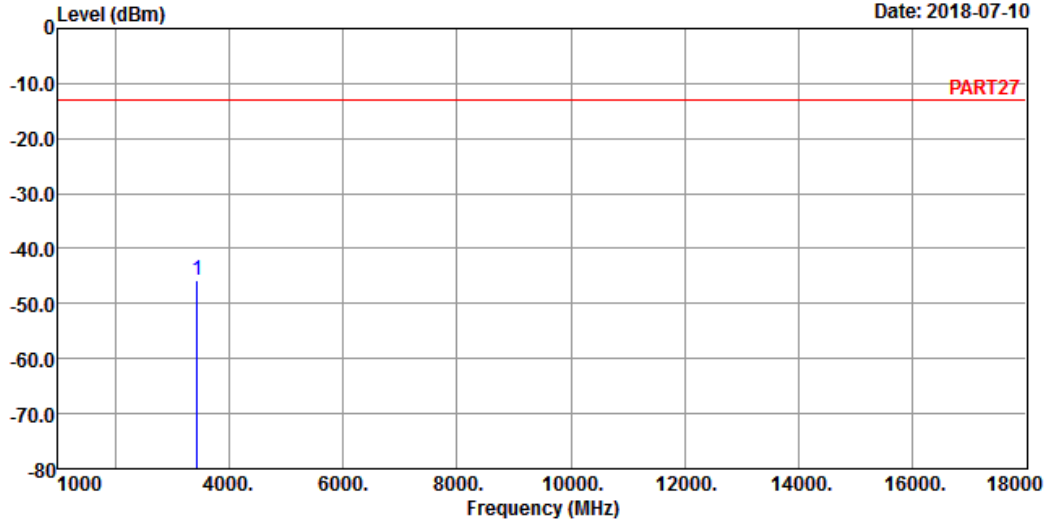

Site : 966 Chamber 5
 Condition: PART27 VERTICAL
 Remak : LTE Band 4 QPSK_20M Link_L-CH
 Tested by: Thomas Wei

Freq	Level	Read Level	Limit Line	Over Limit	Factor	Remark
MHz	dBm	dBm	dBm	dB	dB	
1 pp 3440.00	-45.71	-37.49	-13.00	-32.71	-8.22	Peak

Middle Channel



Bureau Veritas Consumer Products Services Ltd., Taoyuan Branch

A D T

Data: 1

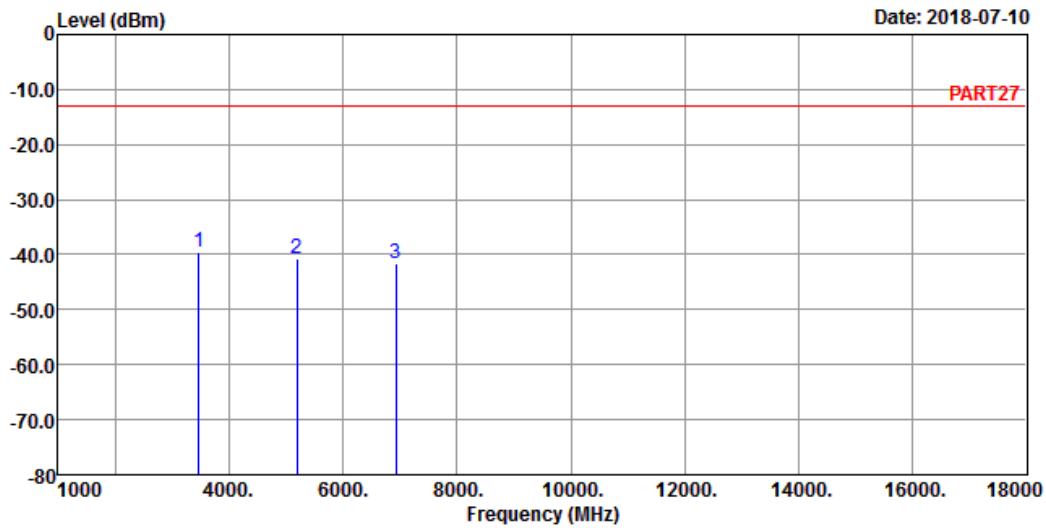

Site : 966 Chamber 5
 Condition: PART27 HORIZONTAL
 Remak : LTE Band 4 QPSK_20M Link_M-CH
 Tested by: Thomas Wei

	Freq	Level	Read Level	Limit Line	Over Limit	Factor	Remark
	MHz	dBm	dBm	dBm	dB	dB	
1 pp	3465.00	-39.52	-31.64	-13.00	-26.52	-7.88	Peak
2	5197.50	-40.63	-38.56	-13.00	-27.63	-2.07	Peak
3	6930.00	-41.66	-44.35	-13.00	-28.66	2.69	Peak



A D T

Data: 2

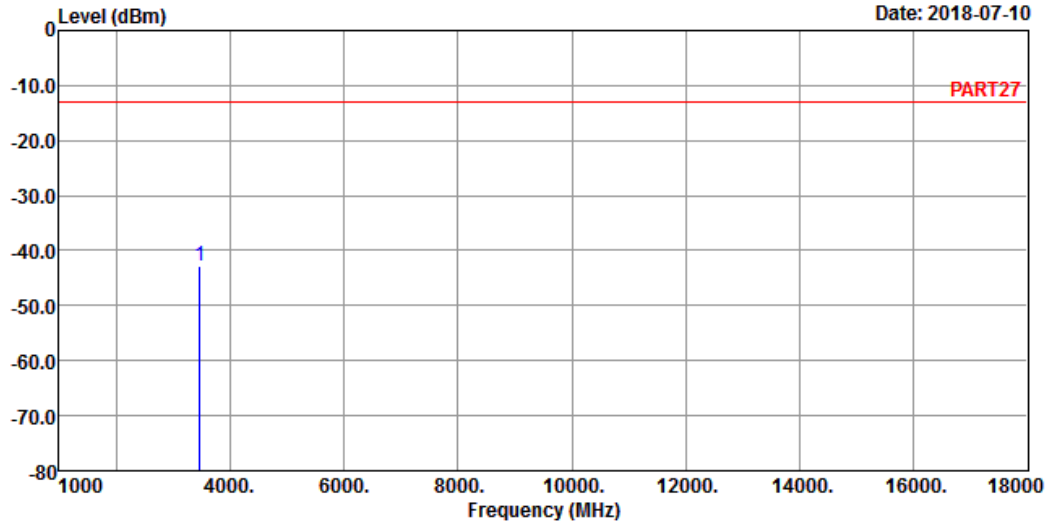

Site : 966 Chamber 5
 Condition: PART27 VERTICAL
 Remak : LTE Band 4 QPSK_20M Link_M-CH
 Tested by: Thomas Wei

Freq	Level	Read Level	Limit Line	Over Limit	Factor	Remark
MHz	dBm	dBm	dBm	dB	dB	
1 pp 3465.00	-42.81	-34.93	-13.00	-29.81	-7.88	Peak

High Channel



Bureau Veritas Consumer Products Services Ltd., Taoyuan Branch

A D T

Data: 5

Date: 2018-07-10

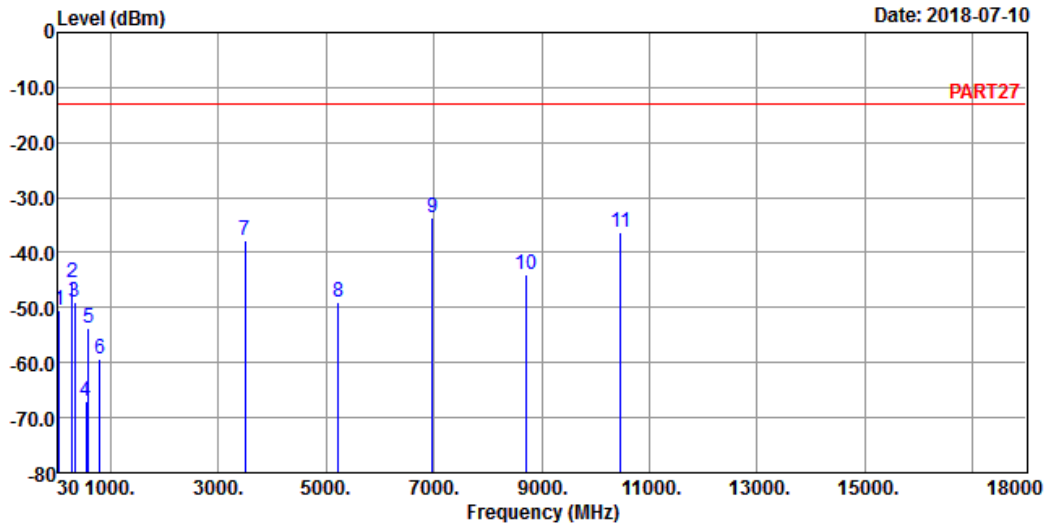

Site : 966 Chamber 5
 Condition: PART27 HORIZONTAL
 Remak : LTE Band 4 QPSK_20M Link_H-CH
 Tested by: Thomas Wei

	Freq	Level	Read Level	Limit	Over	Factor	Remark
	MHz	dBm	dBm	dBm	dB	dB	
1	44.55	-50.42	-48.43	-13.00	-37.42	-1.99	Peak
2	286.08	-45.52	-38.79	-13.00	-32.52	-6.73	Peak
3	338.46	-49.15	-42.73	-13.00	-36.15	-6.42	Peak
4	544.10	-67.05	-63.99	-13.00	-54.05	-3.06	Peak
5	598.42	-53.68	-52.85	-13.00	-40.68	-0.83	Peak
6	806.00	-59.44	-60.12	-13.00	-46.44	0.68	Peak
7	3495.00	-37.65	-30.12	-13.00	-24.65	-7.53	Peak
8	5235.00	-48.94	-46.53	-13.00	-35.94	-2.41	Peak
9 pp	6980.00	-33.59	-36.65	-13.00	-20.59	3.06	Peak
10	8725.00	-44.01	-48.77	-13.00	-31.01	4.76	Peak
11	10470.00	-36.19	-42.06	-13.00	-23.19	5.87	Peak



Bureau Veritas Consumer Products Services Ltd., Taoyuan Branch

A D T

Data: 6

Date: 2018-07-10

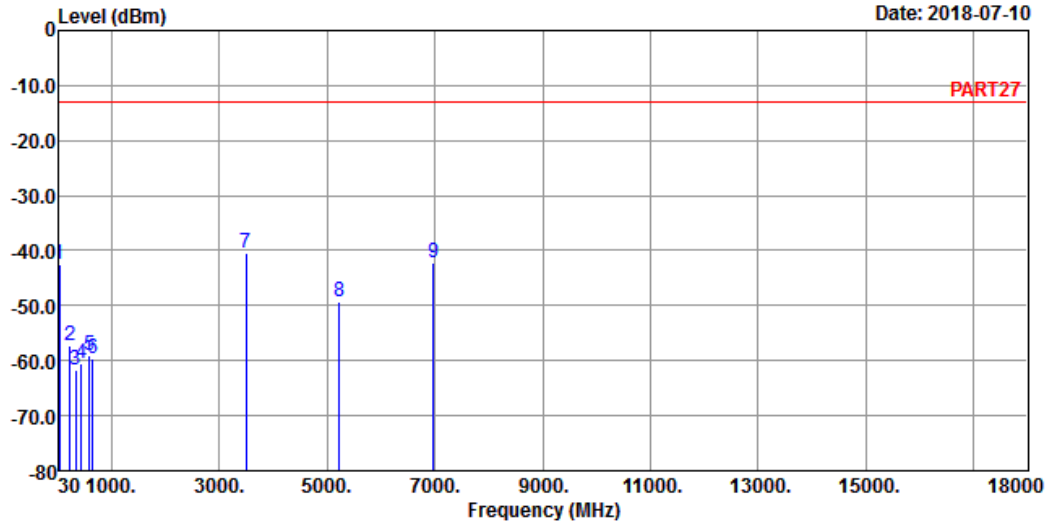

Site : 966 Chamber 5
 Condition: PART27 VERTICAL
 Remak : LTE Band 4 QPSK_20M Link_H-CH
 Tested by: Thomas Wei

	Freq	Level	Read Level	Limit Line	Over Limit	Factor	Remark
	MHz	dBm	dBm	dBm	dB	dB	
1	39.70	-42.47	-43.11	-13.00	-29.47	0.64	Peak
2	234.67	-57.31	-50.69	-13.00	-44.31	-6.62	Peak
3	338.46	-61.58	-55.16	-13.00	-48.58	-6.42	Peak
4	442.25	-60.39	-54.78	-13.00	-47.39	-5.61	Peak
5	598.42	-58.91	-58.08	-13.00	-45.91	-0.83	Peak
6	650.80	-59.70	-58.83	-13.00	-46.70	-0.87	Peak
7 pp	3490.00	-40.49	-32.84	-13.00	-27.49	-7.65	Peak
8	5235.00	-49.40	-46.99	-13.00	-36.40	-2.41	Peak
9	6980.00	-42.14	-45.20	-13.00	-29.14	3.06	Peak

LTE Band 12
 Channel Bandwidth: 10 MHz / QPSK
 Low Channel



Bureau Veritas Consumer Products Services Ltd., Taoyuan Branch

A D T

Data: 5

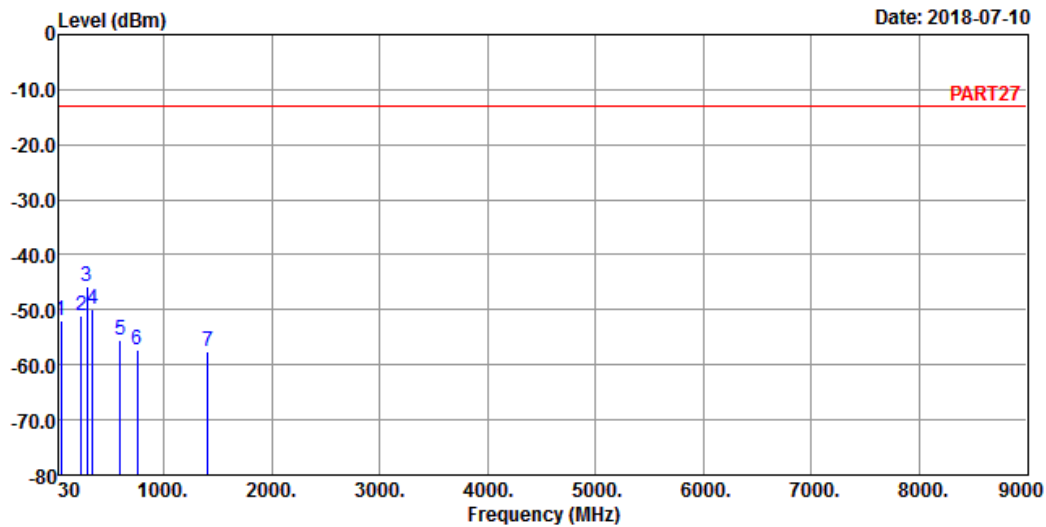

Site : 966 Chamber 5
 Condition: PART27 HORIZONTAL
 Remak : LTE Band 12 QPSK_10M Link_L-CH
 Tested by: Thomas Wei

	Freq	Level	Read Level	Limit Line	Over Limit	Factor	Remark
	MHz	dBm	dBm	dBm	dB	dB	
1	44.55	-51.88	-49.89	-13.00	-38.88	-1.99	Peak
2	234.67	-51.10	-44.48	-13.00	-38.10	-6.62	Peak
3 pp	286.08	-45.78	-39.05	-13.00	-32.78	-6.73	Peak
4	338.46	-49.76	-43.34	-13.00	-36.76	-6.42	Peak
5	598.42	-55.44	-54.61	-13.00	-42.44	-0.83	Peak
6	754.59	-57.28	-58.15	-13.00	-44.28	0.87	Peak
7	1408.00	-57.44	-45.48	-13.00	-44.44	-11.96	Peak



Bureau Veritas Consumer Products Services Ltd., Taoyuan Branch

A D T

Data: 6

Date: 2018-07-10

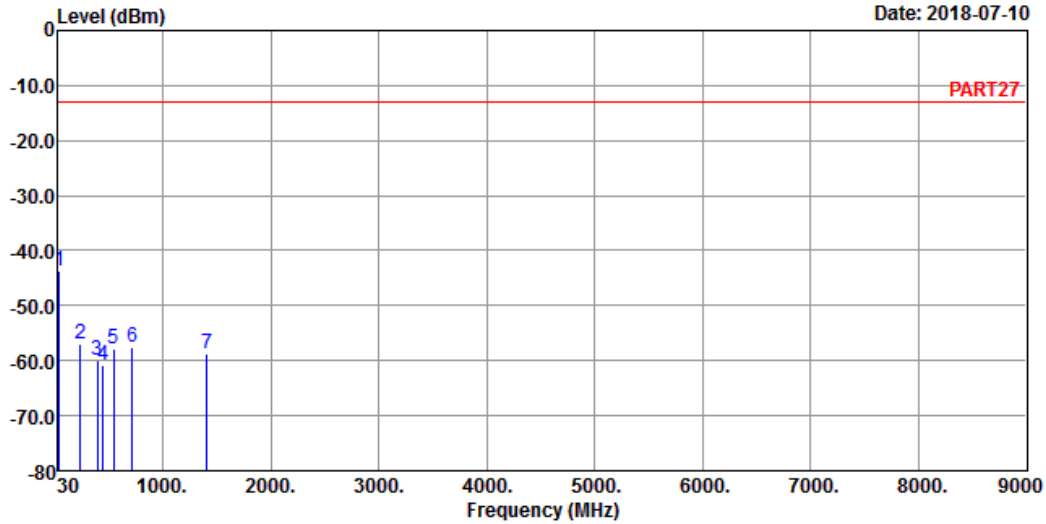

Site : 966 Chamber 5
 Condition: PART27 VERTICAL
 Remak : LTE Band 12 QPSK_10M Link_L-CH
 Tested by: Thomas Wei

	Freq	Level	Read Level	Limit Line	Over Limit	Factor	Remark
	MHz	dBm	dBm	dBm	dB	dB	
1 pp	39.70	-43.57	-44.21	-13.00	-30.57	0.64	Peak
2	234.67	-56.91	-50.29	-13.00	-43.91	-6.62	Peak
3	390.84	-59.94	-53.94	-13.00	-46.94	-6.00	Peak
4	442.25	-60.71	-55.10	-13.00	-47.71	-5.61	Peak
5	546.04	-57.91	-54.92	-13.00	-44.91	-2.99	Peak
6	717.73	-57.45	-57.70	-13.00	-44.45	0.25	Peak
7	1408.00	-58.72	-46.76	-13.00	-45.72	-11.96	Peak

Middle Channel



Bureau Veritas Consumer Products Services Ltd., Taoyuan Branch

A D T

Data: 1

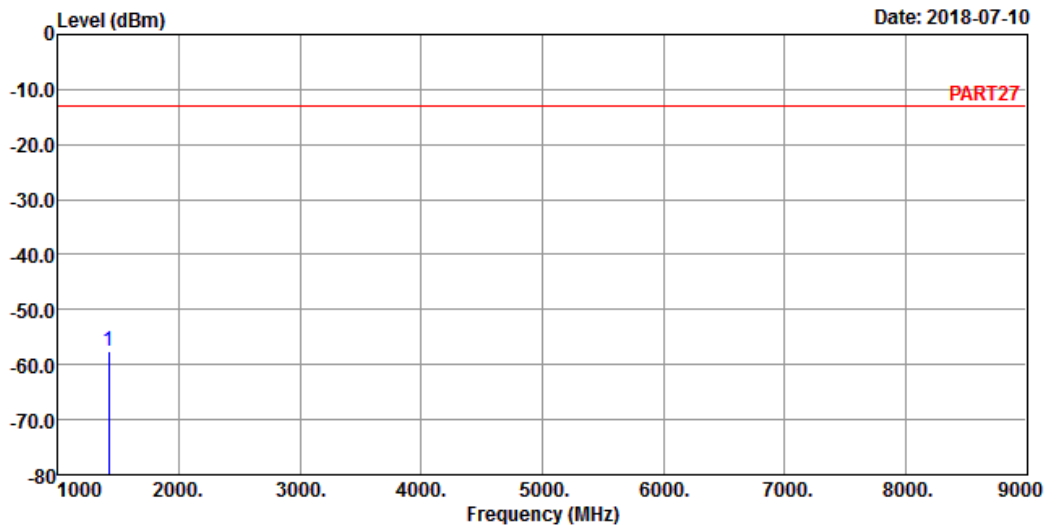

Site : 966 Chamber 5
 Condition: PART27 HORIZONTAL
 Remak : LTE Band 12 QPSK_10M Link_M-CH
 Tested by: Thomas Wei

	Read	Limit	Over			
Freq	Level	Level	Line	Limit	Factor	Remark
MHz	dBm	dBm	dBm	dB	dB	
1 pp 1415.00	-57.71	-45.63	-13.00	-44.71	-12.08	Peak



Bureau Veritas Consumer Products Services Ltd., Taoyuan Branch

A D T

Data: 2

Date: 2018-07-10

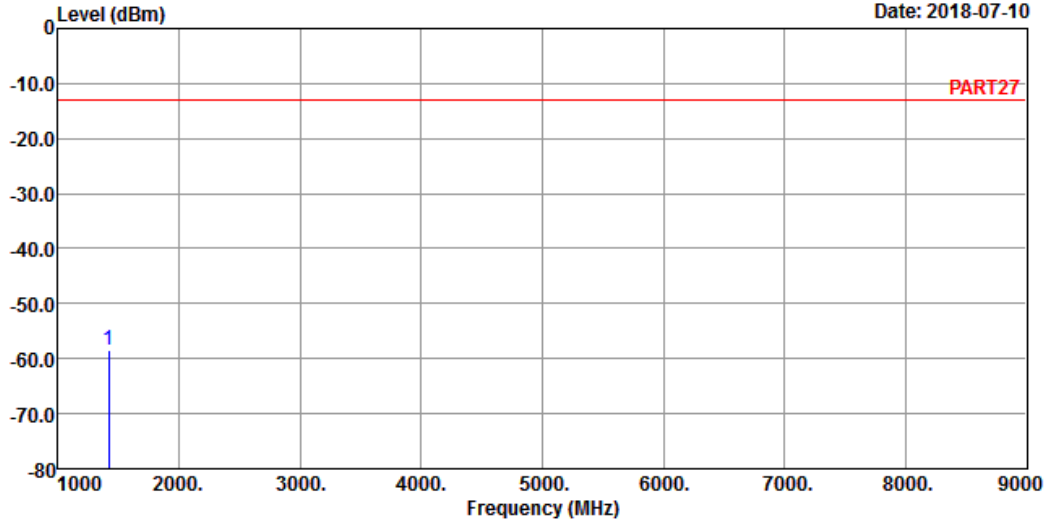

Site : 966 Chamber 5
 Condition: PART27 VERTICAL
 Remak : LTE Band 12 QPSK_10M Link_M-CH
 Tested by: Thomas Wei

Freq	Level	Read Level	Limit Line	Over Limit	Factor	Remark
MHz	dBm	dBm	dBm	dB	dB	
1 pp 1415.00	-58.40	-46.32	-13.00	-45.40	-12.08	Peak

High Channel



Bureau Veritas Consumer Products Services Ltd., Taoyuan Branch

A D T

Data: 1

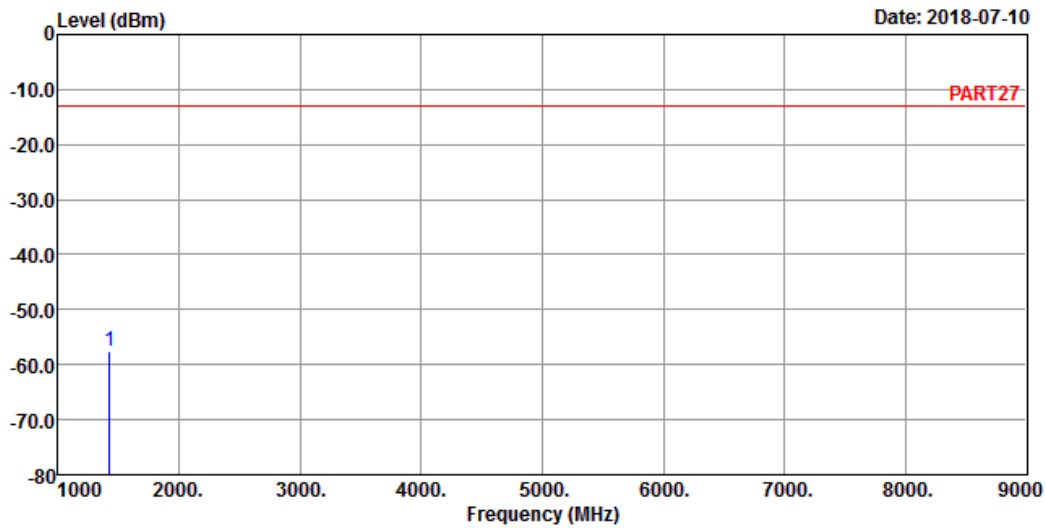

Site : 966 Chamber 5
 Condition: PART27 HORIZONTAL
 Remak : LTE Band 12 QPSK_10M Link_H-CH
 Tested by: Thomas Wei

	Read	Limit	Over			
Freq	Level	Level	Line	Limit	Factor	Remark
MHz	dBm	dBm	dBm	dB	dB	
1 pp 1422.00	-57.67	-45.48	-13.00	-44.67	-12.19	Peak



A D T

Data: 2

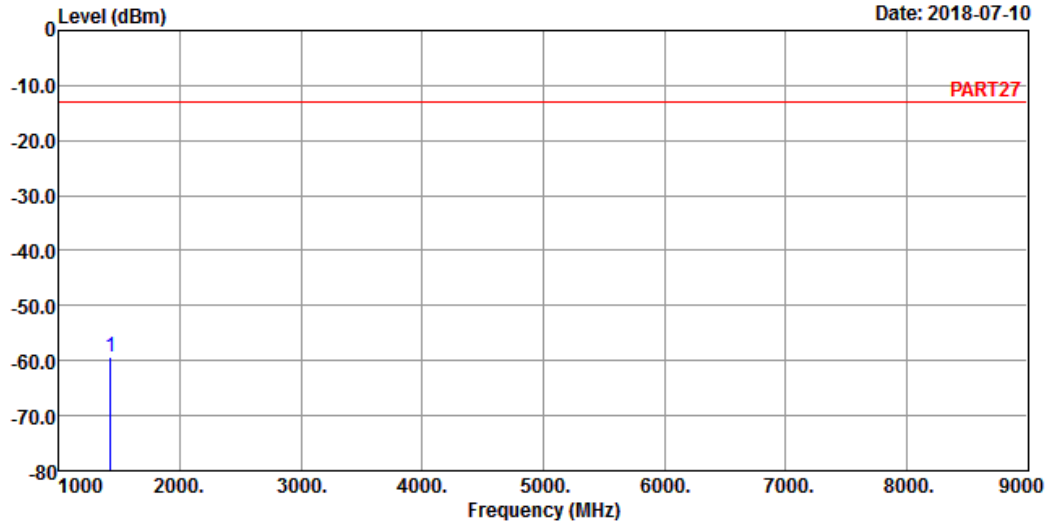

Site : 966 Chamber 5
 Condition: PART27 VERTICAL
 Remak : LTE Band 12 QPSK_10M Link_H-CH
 Tested by: Thomas Wei

Freq	Level	Read Level	Limit Line	Over Limit	Factor	Remark
MHz	dBm	dBm	dBm	dB	dB	
1 pp 1422.00	-59.33	-47.14	-13.00	-46.33	-12.19	Peak

LTE Band 13
 Channel Bandwidth: 10 MHz / QPSK
 Middle Channel_1RB



Bureau Veritas Consumer Products Services Ltd., Taoyuan Branch

A D T

Data: 5

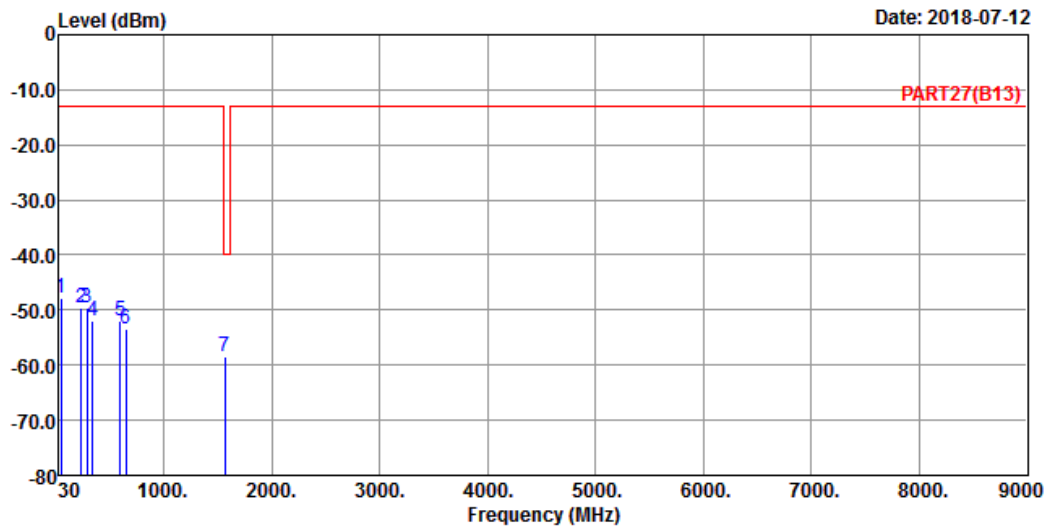

Site : 966 Chamber 5
 Condition: PART27(B13) HORIZONTAL
 Remak : LTE Band 13 QPSK_10M Link_M-CH
 Tested by: Jisyong Wang

	Freq	Level	Read Level	Limit Line	Over Limit	Factor	Remark
	MHz	dBm	dBm	dBm	dB	dB	
1	44.55	-47.84	-45.85	-13.00	-34.84	-1.99	Peak
2	234.67	-49.71	-43.09	-13.00	-36.71	-6.62	Peak
3	286.08	-49.63	-42.90	-13.00	-36.63	-6.73	Peak
4	338.46	-51.87	-45.45	-13.00	-38.87	-6.42	Peak
5	598.42	-52.06	-51.23	-13.00	-39.06	-0.83	Peak
6	649.83	-53.54	-52.66	-13.00	-40.54	-0.88	Peak
7 pp	1564.00	-58.52	-45.18	-40.00	-18.52	-13.34	Peak



Bureau Veritas Consumer Products Services Ltd., Taoyuan Branch

A D T

Data: 6

Date: 2018-07-12

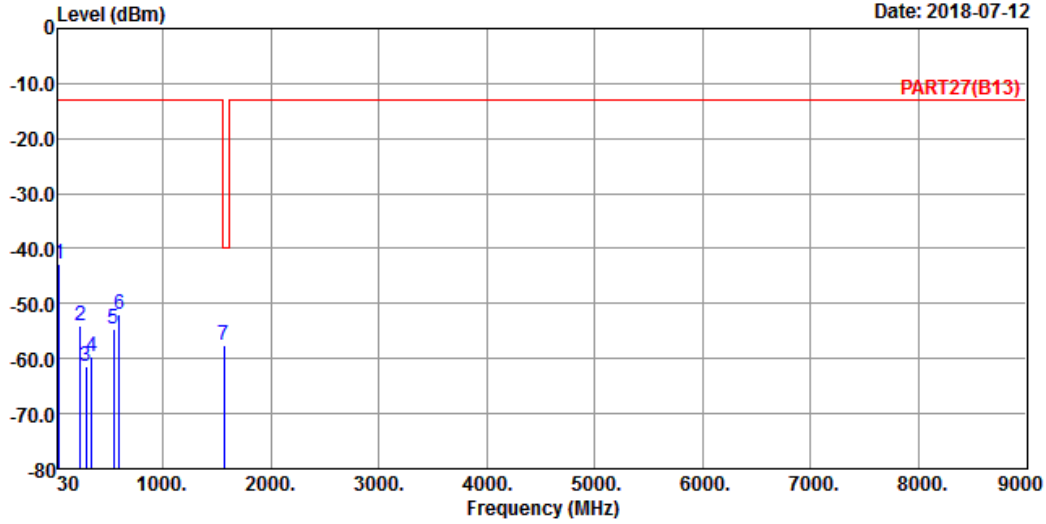

Site : 966 Chamber 5
 Condition: PART27(B13) VERTICAL
 Remak : LTE Band 13 QPSK_10M Link_M-CH
 Tested by: Jisyong Wang

	Freq	Level	Read Level	Limit Line	Over Limit	Factor	Remark
	MHz	dBm	dBm	dBm	dB	dB	
1	41.64	-42.90	-42.49	-13.00	-29.90	-0.41	Peak
2	234.67	-53.99	-47.37	-13.00	-40.99	-6.62	Peak
3	286.08	-61.29	-54.56	-13.00	-48.29	-6.73	Peak
4	338.46	-59.67	-53.25	-13.00	-46.67	-6.42	Peak
5	546.04	-54.55	-51.56	-13.00	-41.55	-2.99	Peak
6	598.42	-51.85	-51.02	-13.00	-38.85	-0.83	Peak
7 pp	1564.00	-57.63	-44.29	-40.00	-17.63	-13.34	Peak

Middle Channel_Full RB



Bureau Veritas Consumer Products Services Ltd., Taoyuan Branch

A D T

Data: 3

Date: 2018-07-12

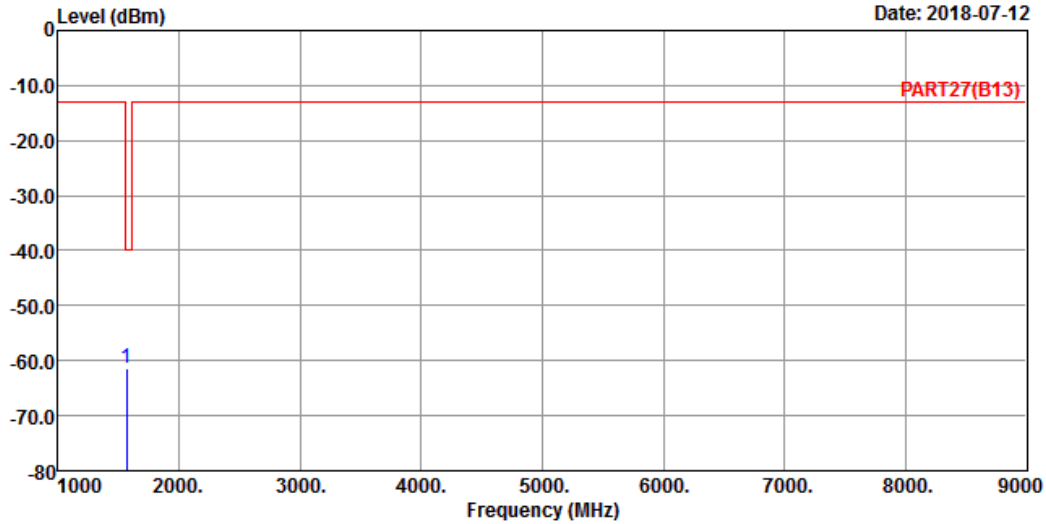

Site : 966 Chamber 5
 Condition: PART27(B13) HORIZONTAL
 Remak : LTE Band 13 QPSK_10M Link_M-CH
 Tested by: Jisyong Wang

Freq	Level	Read Level	Limit	Over	Factor	Remark
MHz	dBm	dBm	dBm	dB	dB	

1 pp 1564.00 -61.52 -48.18 -40.00 -21.52 -13.34 Peak



A D T

Data: 4

Date: 2018-07-12

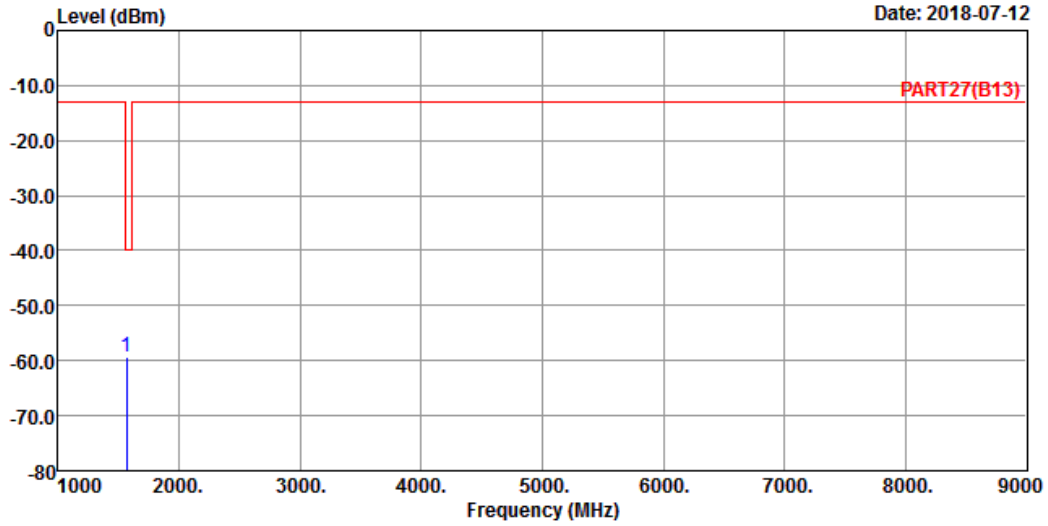

Site : 966 Chamber 5
 Condition: PART27(B13) VERTICAL
 Remak : LTE Band 13 QPSK_10M Link_M-CH
 Tested by: Jisyong Wang

Freq	Level	Read Level	Limit Line	Over Limit	Factor	Remark
MHz	dBm	dBm	dBm	dB	dB	

1 pp 1564.00 -59.25 -45.91 -40.00 -19.25 -13.34 Peak

LTE Band 17
Channel Bandwidth: 10 MHz / QPSK
Low Channel



Bureau Veritas Consumer Products Services Ltd., Taoyuan Branch

A D T

Data: 1

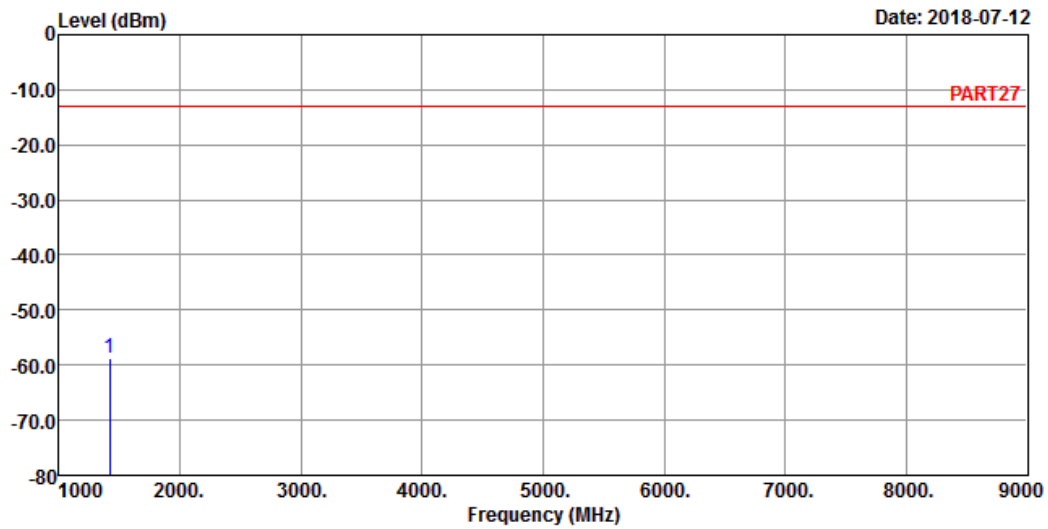

Site : 966 Chamber 5
Condition: PART27 HORIZONTAL
Remak : LTE Band 17 QPSK_10M Link_L-CH
Tested by: Thomas Wei

Freq	Level	Read Level	Limit Line	Over Limit	Factor	Remark
MHz	dBm	dBm	dBm	dB	dB	
1 pp 1418.00	-58.64	-46.50	-13.00	-45.64	-12.14	Peak



A D T

Data: 2

Date: 2018-07-12

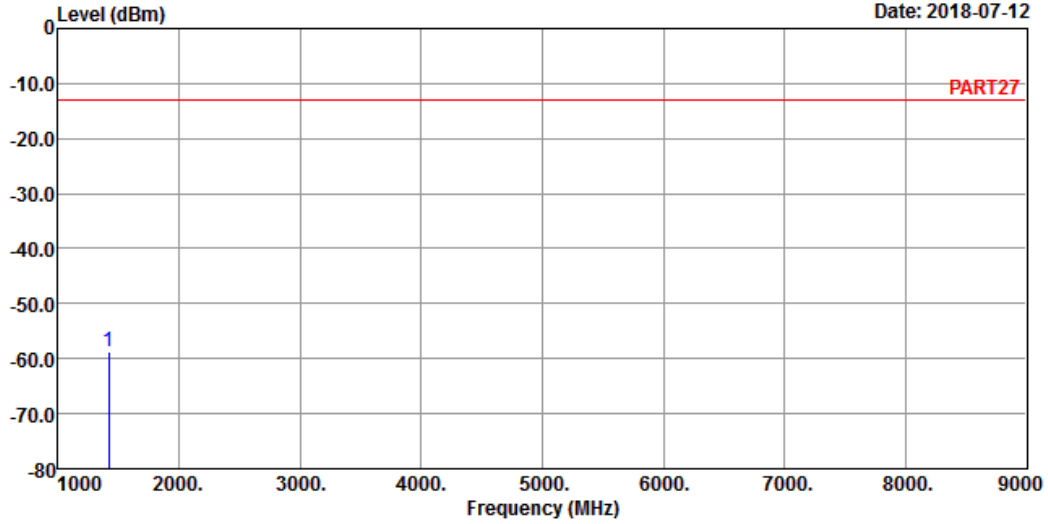

Site : 966 Chamber 5
 Condition: PART27 VERTICAL
 Remak : LTE Band 17 QPSK_10M Link_L-CH
 Tested by: Thomas Wei

Freq	Level	Read Level	Limit Line	Over Limit	Factor	Remark
MHz	dBm	dBm	dBm	dB	dB	
1 pp 1418.00	-58.69	-46.55	-13.00	-45.69	-12.14	Peak

Middle Channel



Bureau Veritas Consumer Products Services Ltd., Taoyuan Branch

A D T

Data: 5

Date: 2018-07-12

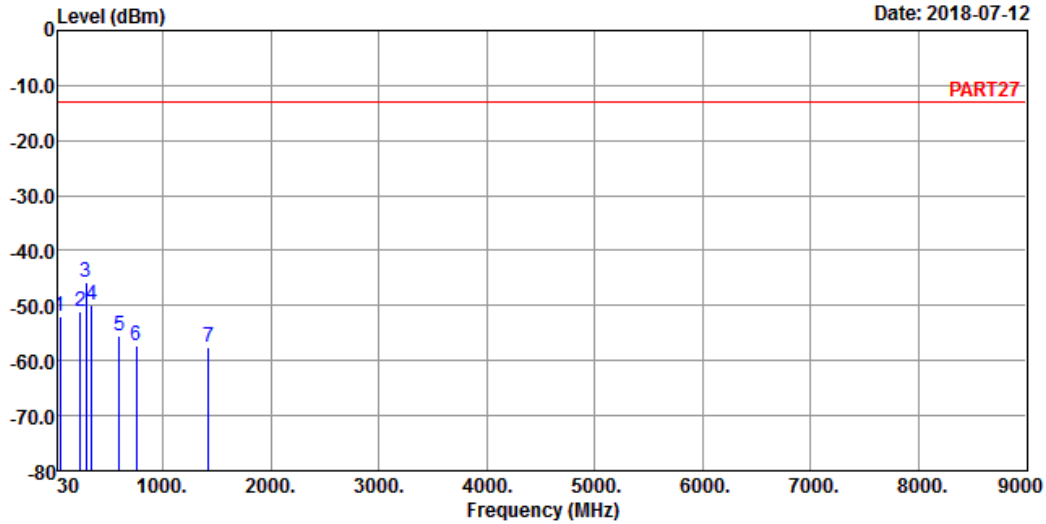

Site : 966 Chamber 5
 Condition: PART27 HORIZONTAL
 Remak : LTE Band 17 QPSK_10M Link_M-CH
 Tested by: Thomas Wei

	Freq	Level	Read Level	Limit Line	Over Limit	Factor	Remark
	MHz	dBm	dBm	dBm	dB	dB	
1	44.55	-51.88	-49.89	-13.00	-38.88	-1.99	Peak
2	234.67	-51.10	-44.48	-13.00	-38.10	-6.62	Peak
3 pp	286.08	-45.78	-39.05	-13.00	-32.78	-6.73	Peak
4	338.46	-49.76	-43.34	-13.00	-36.76	-6.42	Peak
5	598.42	-55.44	-54.61	-13.00	-42.44	-0.83	Peak
6	754.59	-57.28	-58.15	-13.00	-44.28	0.87	Peak
7	1420.00	-57.49	-45.35	-13.00	-44.49	-12.14	Peak



Bureau Veritas Consumer Products Services Ltd., Taoyuan Branch

A D T

Data: 6

Date: 2018-07-12

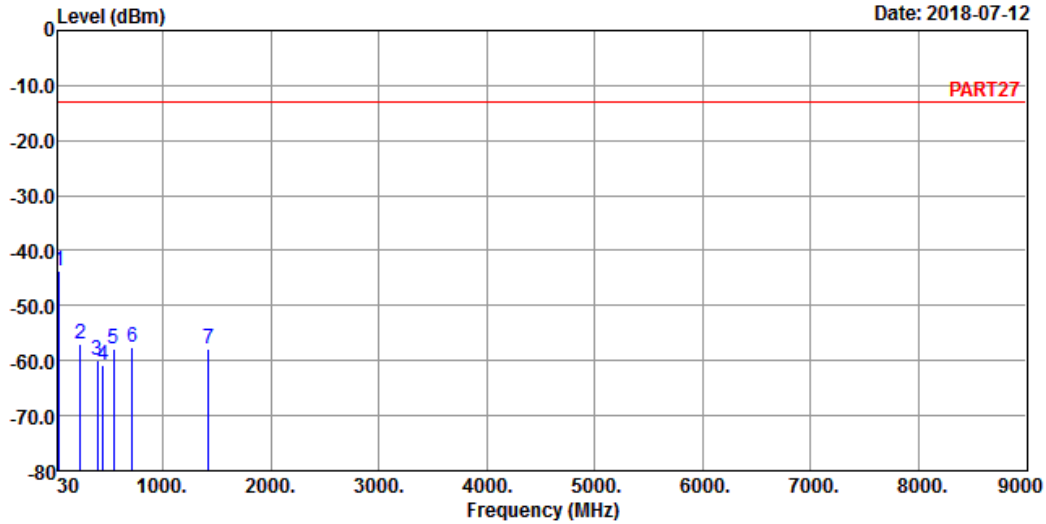

Site : 966 Chamber 5
 Condition: PART27 VERTICAL
 Remak : LTE Band 17 QPSK_10M Link_M-CH
 Tested by: Thomas Wei

	Freq	Level	Read Level	Limit Line	Over Limit	Factor	Remark
	MHz	dBm	dBm	dBm	dB	dB	
1 pp	39.70	-43.57	-44.21	-13.00	-30.57	0.64	Peak
2	234.67	-56.91	-50.29	-13.00	-43.91	-6.62	Peak
3	390.84	-59.94	-53.94	-13.00	-46.94	-6.00	Peak
4	442.25	-60.71	-55.10	-13.00	-47.71	-5.61	Peak
5	546.04	-57.91	-54.92	-13.00	-44.91	-2.99	Peak
6	717.73	-57.45	-57.70	-13.00	-44.45	0.25	Peak
7	1420.00	-57.84	-45.70	-13.00	-44.84	-12.14	Peak

High Channel



Bureau Veritas Consumer Products Services Ltd., Taoyuan Branch

A D T

Data: 1

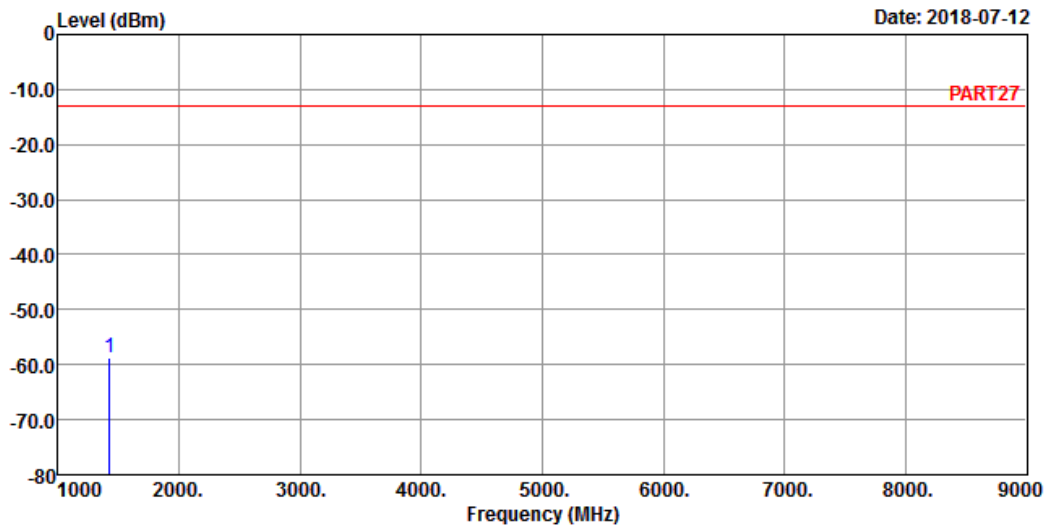

Site : 966 Chamber 5
 Condition: PART27 HORIZONTAL
 Remak : LTE Band 17 QPSK_10M Link_H-CH
 Tested by: Thomas Wei

	Read	Limit	Over			
Freq	Level	Level	Line	Limit	Factor	Remark
MHz	dBm	dBm	dBm	dB	dB	
1 pp 1422.00	-58.87	-46.68	-13.00	-45.87	-12.19	Peak



A D T

Data: 2

Date: 2018-07-12

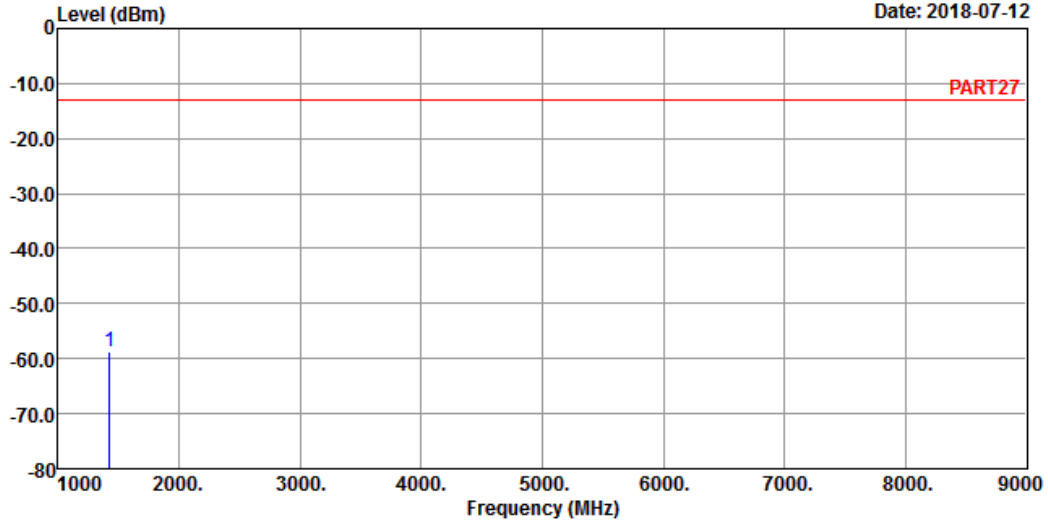

Site : 966 Chamber 5
 Condition: PART27 VERTICAL
 Remak : LTE Band 17 QPSK_10M Link_H-CH
 Tested by: Thomas Wei

Freq	Level	Read Level	Limit Line	Over Limit	Factor	Remark
MHz	dBm	dBm	dBm	dB	dB	
1 pp 1422.00	-58.82	-46.63	-13.00	-45.82	-12.19	Peak

LTE Band 66:
Channel Bandwidth: 20 MHz / QPSK
Low Channel



Bureau Veritas Consumer Products Services Ltd., Taoyuan Branch

A D T

Data: 3

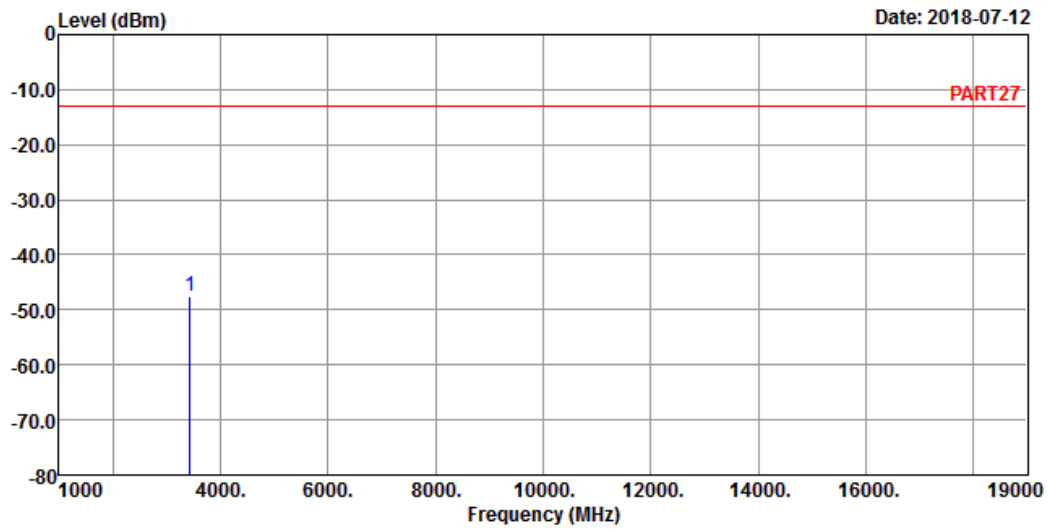

Site : 966 Chamber 5
Condition: PART27 HORIZONTAL
Remak : LTE Band 66 QPSK_20M Link_L-CH
Tested by: Jisyong Wang

Freq	Level	Read Level	Limit Line	Over Limit	Factor	Remark
MHz	dBm	dBm	dBm	dB	dB	
1 pp 3440.00	-47.52	-39.30	-13.00	-34.52	-8.22	Peak



Bureau Veritas Consumer Products Services Ltd., Taoyuan Branch

A D T

Data: 4

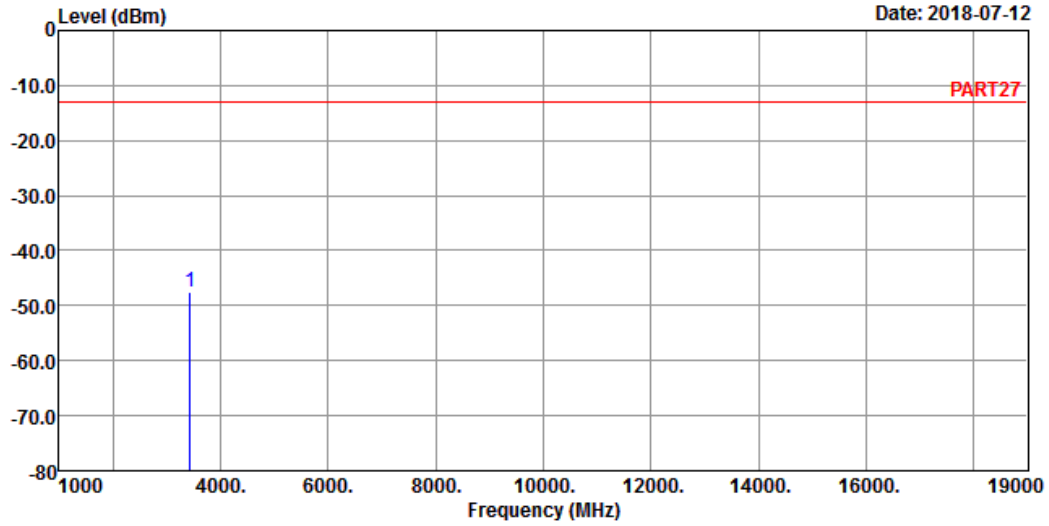

Site : 966 Chamber 5
 Condition: PART27 VERTICAL
 Remak : LTE Band 66 QPSK_20M Link_L-CH
 Tested by: Jisyong Wang

Freq	Level	Read Level	Limit Line	Over Limit	Factor	Remark
MHz	dBm	dBm	dBm	dB	dB	
1 pp 3440.00	-47.63	-39.41	-13.00	-34.63	-8.22	Peak

Middle Channel



Bureau Veritas Consumer Products Services Ltd., Taoyuan Branch

A D T

Data: 5

Date: 2018-07-12

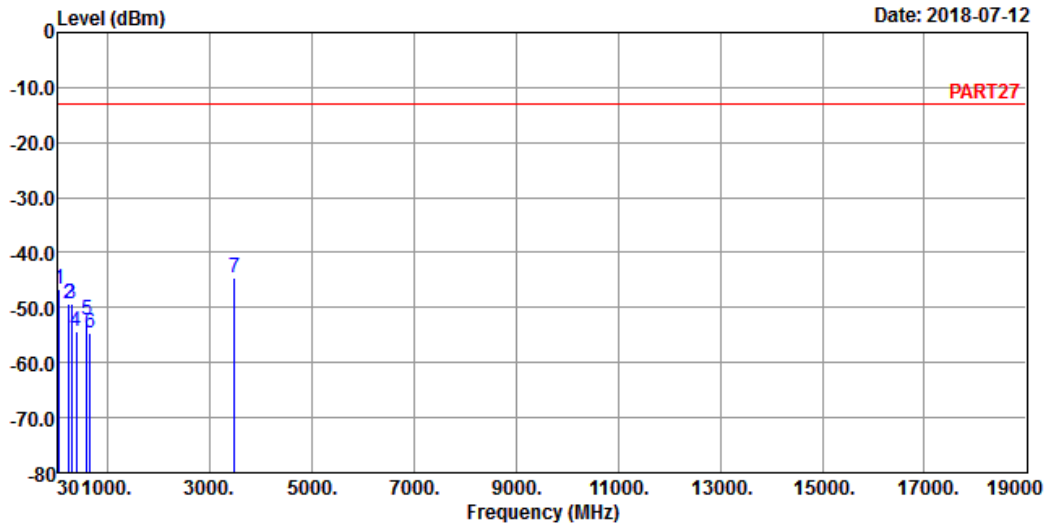

Site : 966 Chamber 5
 Condition: PART27 HORIZONTAL
 Remak : LTE Band 66 QPSK_20M Link_M-CH
 Tested by: Jisyoung Wang

	Read	Limit	Over				
Freq	Level	Level	Line	Limit	Factor	Remark	
MHz	dBm	dBm	dBm	dB	dB		
1	44.55	-46.68	-44.69	-13.00	-33.68	-1.99	Peak
2	234.67	-49.44	-42.82	-13.00	-36.44	-6.62	Peak
3	286.08	-49.34	-42.61	-13.00	-36.34	-6.73	Peak
4	389.87	-54.30	-48.30	-13.00	-41.30	-6.00	Peak
5	598.42	-52.18	-51.35	-13.00	-39.18	-0.83	Peak
6	650.80	-54.63	-53.76	-13.00	-41.63	-0.87	Peak
7 pp	3490.00	-44.52	-36.87	-13.00	-31.52	-7.65	Peak



Bureau Veritas Consumer Products Services Ltd., Taoyuan Branch

A D T

Data: 6

Date: 2018-07-12

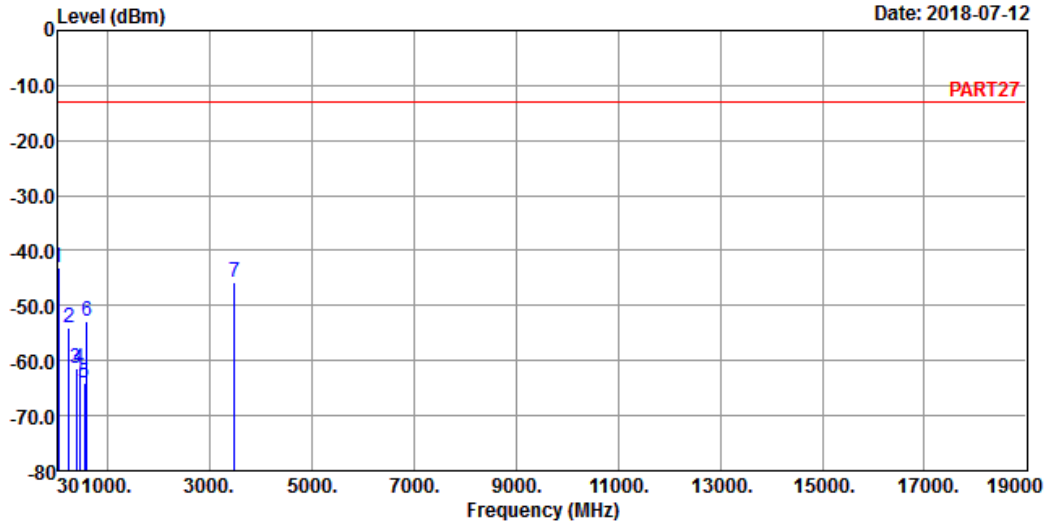

Site : 966 Chamber 5
 Condition: PART27 VERTICAL
 Remak : LTE Band 66 QPSK_20M Link_M-CH
 Tested by: Jisyong Wang

	Freq	Level	Read Level	Limit Line	Over Limit	Factor	Remark
	MHz	dBm	dBm	dBm	dB	dB	
1 pp	39.70	-43.01	-43.65	-13.00	-30.01	0.64	Peak
2	234.67	-53.92	-47.30	-13.00	-40.92	-6.62	Peak
3	390.84	-61.38	-55.38	-13.00	-48.38	-6.00	Peak
4	442.25	-61.40	-55.79	-13.00	-48.40	-5.61	Peak
5	547.98	-64.07	-61.15	-13.00	-51.07	-2.92	Peak
6	598.42	-52.93	-52.10	-13.00	-39.93	-0.83	Peak
7	3490.00	-45.85	-38.20	-13.00	-32.85	-7.65	Peak

High Channel



Bureau Veritas Consumer Products Services Ltd., Taoyuan Branch

A D T

Data: 3

Date: 2018-07-12

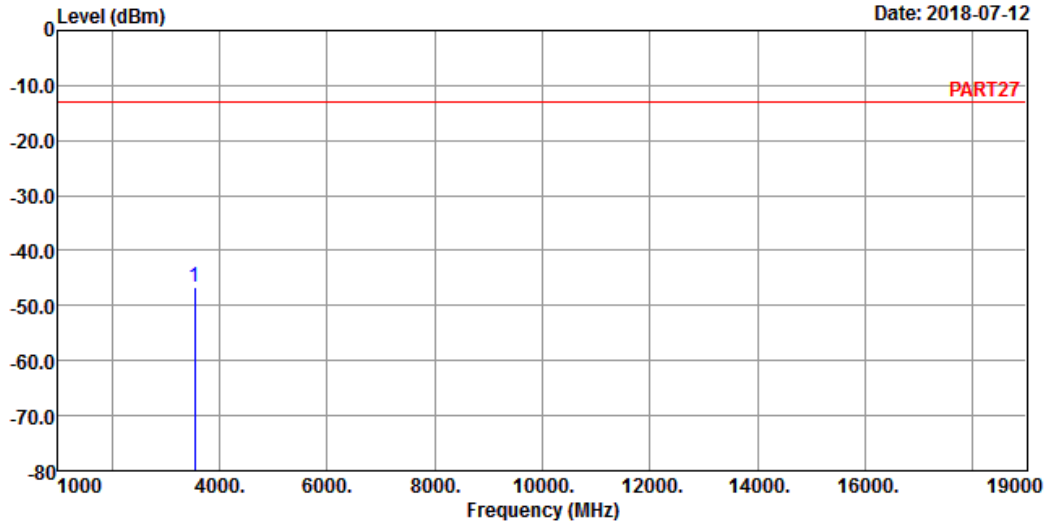

Site : 966 Chamber 5
 Condition: PART27 HORIZONTAL
 Remak : LTE Band 66 QPSK_20M Link_H-CH
 Tested by: Jisyong Wang

Freq	Level	Read Level	Limit	Over	Factor	Remark
MHz	dBm	dBm	dBm	dB	dB	

1 pp 3540.00 -46.52 -39.30 -13.00 -33.52 -7.22 Peak



A D T

Data: 4

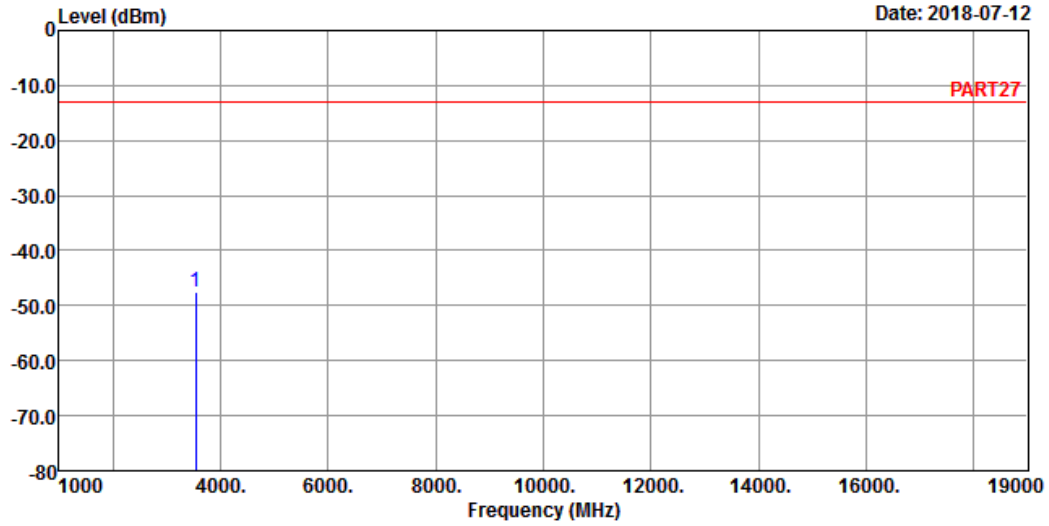

Site : 966 Chamber 5
 Condition: PART27 VERTICAL
 Remak : LTE Band 66 QPSK_20M Link_H-CH
 Tested by: Jisyong Wang

Freq	Level	Read Level	Limit Line	Over Limit	Factor	Remark
MHz	dBm	dBm	dBm	dB	dB	
1 pp 3540.00	-47.52	-40.30	-13.00	-34.52	-7.22	Peak

5 Pictures of Test Arrangements

Please refer to the attached file (Test Setup Photo).

Appendix – Information on the Testing Laboratories

We, Bureau Veritas Consumer Products Services (H.K.) Ltd., Taoyuan Branch, were founded in 1988 to provide our best service in EMC, Radio, Telecom and Safety consultation. Our laboratories are FCC recognized accredited test firms and accredited according to ISO/IEC 17025.

If you have any comments, please feel free to contact us at the following:

Linko EMC/RF Lab

Tel: 886-2-26052180

Fax: 886-2-26051924

Hsin Chu EMC/RF/Telecom Lab

Tel: 886-3-6668565

Fax: 886-3-6668323

Hwa Ya EMC/RF/Safety

Tel: 886-3-3183232

Fax: 886-3-3270892

Email: service.adt@tw.bureauveritas.com

Web Site: www.bureauveritas-adt.com

The address and road map of all our labs can be found in our web site also.

--- END ---