

## FCC Test Report

### (PART 27)

**Report No.:** RF180704C01-3

**FCC ID:** ZMOL850GLD

**Test Model:** L850-GL

**Received Date:** Jul. 04, 2018

**Test Date:** Jul. 10, 2018 ~ Jul. 19, 2018

**Issued Date:** Jul. 19, 2018

**Applicant:** Fibocom Wireless Inc.

**Address:** 5/F, Tower A, Technology Building II, 1057 Nanhai Blvd, Nanshan,  
Shenzhen, China

**Issued By:** Bureau Veritas Consumer Products Services (H.K.) Ltd., Taoyuan Branch

**Lab Address:** No. 47-2, 14th Ling, Chia Pau Vil., Lin Kou Dist., New Taipei City, Taiwan  
( R.O.C )

**Test Location:** No. 19, Hwa Ya 2nd Rd, Wen Hwa Vil, Kwei Shan Dist., Taoyuan City  
33383, Taiwan (R.O.C)

**FCC Registration /  
Designation Number:** 788550 / TW0003



This report is for your exclusive use. Any copying or replication of this report to or for any other person or entity, or use of our name or trademark, is permitted only with our prior written permission. This report sets forth our findings solely with respect to the test samples identified herein. The results set forth in this report are not indicative or representative of the quality or characteristics of the lot from which a test sample was taken or any similar or identical product unless specifically and expressly noted. Our report includes all of the tests requested by you and the results thereof based upon the information that you provided to us. You have 60 days from date of issuance of this report to notify us of any material error or omission caused by our negligence, provided, however, that such notice shall be in writing and shall specifically address the issue you wish to raise. A failure to raise such issue within the prescribed time shall constitute your unqualified acceptance of the completeness of this report, the tests conducted and the correctness of the report contents. Unless specific mention, the uncertainty of measurement has been explicitly taken into account to declare the compliance or non-compliance to the specification. The report must not be used by the client to claim product certification, approval, or endorsement by TAF or any government agencies

## Table of Contents

|   |           |
|---|-----------|
| <b>Release Control Record .....</b>                             | <b>3</b>  |
| <b>1 Certificate of Conformity .....</b>                        | <b>4</b>  |
| <b>2 Summary of Test Results.....</b>                           | <b>5</b>  |
| 2.1 Measurement Uncertainty.....                                | 5         |
| 2.2 Test Site And Instruments .....                             | 6         |
| <b>3 General Information .....</b>                              | <b>7</b>  |
| 3.1 General Description of EUT .....                            | 7         |
| 3.2 Configuration of System Under Test .....                    | 8         |
| 3.2.1 Description of Support Units .....                        | 8         |
| 3.3 Test Mode Applicability and Tested Channel Detail .....     | 8         |
| 3.4 EUT Operating Conditions .....                              | 10        |
| 3.5 General Description of Applied Standards.....               | 10        |
| <b>4 Test Types and Results .....</b>                           | <b>11</b> |
| 4.1 Output Power Measurement.....                               | 11        |
| 4.1.1 Limits of Output Power Measurement .....                  | 11        |
| 4.1.2 Test Procedures.....                                      | 11        |
| 4.1.3 Test Setup.....   | 12        |
| 4.1.4 Test Results .....  | 13        |
| 4.2 Modulation Characteristics Measurement .....                | 15        |
| 4.2.1 Limits of Modulation Characteristics .....                | 15        |
| 4.2.2 Test Setup.....   | 15        |
| 4.2.3 Test Procedure .....                                      | 15        |
| 4.2.4 Test Results .....  | 16        |
| 4.3 Frequency Stability Measurement .....                       | 17        |
| 4.3.1 Limits of Frequency Stability Measurement .....           | 17        |
| 4.3.2 Test Procedure .....                                      | 17        |
| 4.3.3 Test Setup.....   | 17        |
| 4.3.4 Test Results .....  | 18        |
| 4.4 Occupied Bandwidth Measurement.....                         | 20        |
| 4.4.1 Limits of Occupied Bandwidth Measurement .....            | 20        |
| 4.4.2 Test Procedure .....                                      | 20        |
| 4.4.3 Test Setup.....   | 20        |
| 4.4.4 Test Result.....  | 21        |
| 4.5 Band Edge Measurement .....                                 | 22        |
| 4.5.1 Limits of Band Edge Measurement .....                     | 22        |
| 4.5.2 Test Setup.....   | 22        |
| 4.5.3 Test Procedures.....                                      | 22        |
| 4.5.4 Test Results .....  | 23        |
| 4.6 Conducted Spurious Emissions.....                           | 27        |
| 4.6.1 Limits of Conducted Spurious Emissions Measurement .....  | 27        |
| 4.6.2 Test Setup.....   | 27        |
| 4.6.3 Test Procedure .....                                      | 27        |
| 4.6.4 Test Results .....  | 28        |
| 4.7 Radiated Emission Measurement.....                          | 32        |
| 4.7.1 Limits of Radiated Emission Measurement .....             | 32        |
| 4.7.2 Test Procedure .....                                      | 32        |
| 4.7.3 Deviation from Test Standard .....                        | 32        |
| 4.7.4 Test Setup.....   | 33        |
| 4.7.5 Test Results .....  | 34        |
| <b>5 Pictures of Test Arrangements.....</b>                     | <b>42</b> |
| <b>Appendix – Information on the Testing Laboratories .....</b> | <b>43</b> |

### Release Control Record

| Issue No.     | Description      | Date Issued   |
|---------------|------------------|---------------|
| RF180704C01-3 | Original Release | Jul. 19, 2018 |

## 1 Certificate of Conformity

**Product:** LTE module  
**Brand:** Fibocom  
**Test Model:** L850-GL  
**Sample Status:** Identical Prototype  
**Applicant:** Fibocom Wireless Inc.  
**Test Date:** Jul. 10, 2018 ~ Jul. 19, 2018  
**Standards:** FCC Part 27, Subpart C, D

The above equipment has been tested by **Bureau Veritas Consumer Products Services (H.K.) Ltd., Taoyuan Branch**, and found compliance with the requirement of the above standards. The test record, data evaluation & Equipment Under Test (EUT) configurations represented herein are true and accurate accounts of the measurements of the sample's RF characteristics under the conditions specified in this report.

**Prepared by :** , **Date:** Jul. 19, 2018  
Rona Chen / Specialist

**Approved by :** , **Date:** Jul. 19, 2018  
Dylan Chiou / Project Engineer

## 2 Summary of Test Results

| Applied Standard: FCC Part 27 & Part 2 |                                     |        |  |
|--|-------------------------------------|--------|--|
| FCC Clause                             | Test Item                           | Result | Remarks  |
| 2.1046<br>27.50(a)(3)                  | Equivalent Isotropic Radiated Power | Pass   | Meet the requirement of limit.   |
| 2.1047                                 | Modulation Characteristics          | Pass   | Meet the requirement.  |
| 2.1055<br>27.54                        | Frequency Stability                 | Pass   | Meet the requirement of limit.   |
| 2.1049                                 | Occupied Bandwidth                  | Pass   | Meet the requirement of limit.   |
| 2.1051<br>27.53(a)(4)                  | Band Edge Measurements              | Pass   | Meet the requirement of limit.   |
| 2.1051<br>27.53(a)(4)                  | Conducted Spurious Emissions        | Pass   | Meet the requirement of limit.   |
| 2.1053<br>27.53(a)(4)                  | Radiated Spurious Emissions         | Pass   | Meet the requirement of limit.<br>Minimum passing margin is -4.78 dB at 39.70 MHz. |

### 2.1 Measurement Uncertainty

Where relevant, the following measurement uncertainty levels have been estimated for tests performed on the EUT as specified in CISPR 16-4-2:

| Measurement                    | Frequency          | Expanded Uncertainty (k=2) ( $\pm$ ) |
|--------------------------------|--------------------|--------------------------------------|
| Radiated Emissions up to 1 GHz | 30 MHz ~ 200 MHz   | 2.93 dB                              |
|                                | 200 MHz ~ 1000 MHz | 2.95 dB                              |
| Radiated Emissions above 1 GHz | 1 GHz ~ 18 GHz     | 2.26 dB                              |
|                                | 18 GHz ~ 40 GHz    | 1.94 dB                              |

## 2.2 Test Site And Instruments

| Description & Manufacturer                     | Model No.                  | Serial No.                    | Date of Calibration | Due Date of Calibration |
|--|----------------------------|-------------------------------|---------------------|-------------------------|
| Test Receiver<br>Agilent                       | N9038A                     | MY51210203                    | Mar. 16, 2018       | Mar. 15, 2019           |
| Spectrum Analyzer<br>Agilent                   | N9010A                     | MY52220314                    | Nov. 24, 2017       | Nov. 23, 2018           |
| Spectrum Analyzer<br>ROHDE & SCHWARZ           | FSU43                      | 101261                        | Jan. 11, 2018       | Jan. 10, 2019           |
| Double Ridge Guide Horn<br>Antenna EMCO        | 3115                       | 5619                          | Nov. 30, 2017       | Nov. 29, 2018           |
| BILOG Antenna<br>SCHWARZBECK                   | VULB 9168                  | 9168-153                      | Dec. 06, 2017       | Dec. 05, 2018           |
| Fixed Attenuator<br>Mini-Circuits              | MDCS18N-10                 | MDCS18N-10-01                 | Apr. 16, 2018       | Apr. 15, 2019           |
| Preamplifier<br>EMCI                           | EMC 012645                 | 980115                        | Oct. 20, 2017       | Oct. 19, 2018           |
| Preamplifier<br>EMCI                           | EMC 184045                 | 980116                        | Oct. 20, 2017       | Oct. 19, 2018           |
| Preamplifier<br>EMCI                           | EMC 330H                   | 980112                        | Oct. 13, 2017       | Oct. 12, 2018           |
| Power Meter<br>Anritsu                         | ML2495A                    | 1012010                       | Aug. 15, 2017       | Aug. 14, 2018           |
| Power Sensor<br>Anritsu                        | MA2411B                    | 1315050                       | Aug. 15, 2017       | Aug. 14, 2018           |
| RF Coaxial Cable<br>HUBER+SUHNNER              | EMC104-SM-SM-800<br>0&3000 | 140811+170717                 | Oct. 20, 2017       | Oct. 19, 2018           |
| RF Coaxial Cable<br>HUBER+SUHNNER              | SUCOFLEX 104               | EMC104-SM-SM-<br>1000(140807) | Oct. 20, 2017       | Oct. 19, 2018           |
| RF Coaxial Cable<br>Worken                     | 8D-FB                      | Cable-Ch10-01                 | Oct. 20, 2017       | Oct. 19, 2018           |
| Software<br>BV ADT                             | E3<br>6.120103             | NA                            | NA                  | NA                      |
| Antenna Tower<br>MF                            | MFA-440H                   | NA                            | NA                  | NA                      |
| Turn Table<br>MF                               | MFT-201SS                  | NA                            | NA                  | NA                      |
| Antenna Tower & Turn<br>Table Controller<br>MF | MF-7802                    | NA                            | NA                  | NA                      |
| Radio Communication<br>Analyzer                | MT8820C                    | 6201300640                    | Aug. 16, 2017       | Aug. 15, 2019           |
| Temperature & Humidity<br>Chamber              | GTH-120-40-CP-AR           | MAA1306-019                   | Sep. 08, 2017       | Sep. 07, 2018           |
| DC Power Supply<br>Topward                     | 33010D                     | 807748                        | Oct. 25, 2016       | Oct. 24, 2018           |
| Digital Multimeter<br>Fluke                    | 87-III                     | 70360742                      | Jun. 29, 2018       | Jun. 28, 2019           |

- Note: 1. The calibration interval of the above test instruments is 12 / 24 months and the calibrations are traceable to NML/ROC and NIST/USA.
2. The test was performed in HwaYa Chamber 10.
3. The horn antenna and preamplifier (model: EMC 184045) are used only for the measurement of emission frequency above 1 GHz if tested.
4. The IC Site Registration No. is IC7450F-10.

### 3 General Information

#### 3.1 General Description of EUT

|                            |   |                     |
|----------------------------|---|---------------------|
| <b>Product</b>             | LTE module                              |                     |
| <b>Brand</b>               | Fibocom                                 |                     |
| <b>Test Model</b>          | L850-GL                                 |                     |
| <b>Status of EUT</b>       | Identical Prototype                     |                     |
| <b>Power Supply Rating</b> | 3.3 Vdc (Host equipment)                |                     |
| <b>Modulation Type</b>     | QPSK, 16QAM                             |                     |
| <b>Frequency Range</b>     | LTE Band 30 (Channel Bandwidth: 5 MHz)  | 2307.5 ~ 2312.5 MHz |
|                            | LTE Band 30 (Channel Bandwidth: 10 MHz) | 2310 MHz            |
| <b>Max. EIRP Power</b>     | LTE Band 30 (Channel Bandwidth: 5 MHz)  | 245.87 mW           |
|                            | LTE Band 30 (Channel Bandwidth: 10 MHz) | 249.46 mW           |
| <b>Emission Designator</b> | LTE Band 30 (Channel Bandwidth: 5 MHz)  | 4M50W7D             |
|                            | LTE Band 30 (Channel Bandwidth: 10 MHz) | 8M98W7D             |
| <b>Antenna Type</b>        | External Antenna with 3.0 dBi gain      |                     |
| <b>Accessory Device</b>    | N/A                                     |                     |
| <b>Data Cable Supplied</b> | N/A                                     |                     |

Note:

1. The above EUT information is declared by manufacturer and for more detailed features description, please refers to the manufacturer's specifications or user's manual.

### 3.2 Configuration of System Under Test

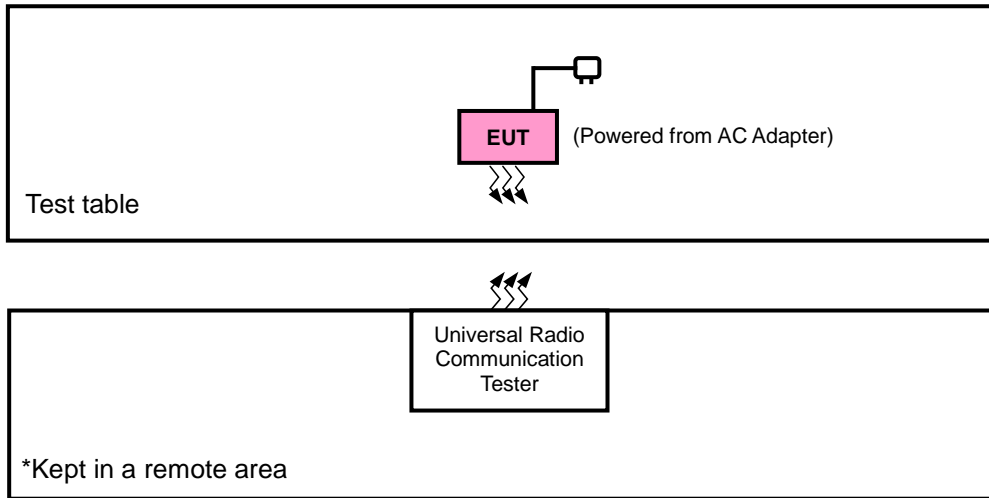

#### 3.2.1 Description of Support Units

The EUT has been tested as an independent unit together with other necessary accessories or support units.

### 3.3 Test Mode Applicability and Tested Channel Detail

Pre-Scan has been conducted to determine the worst-case mode from all possible combinations between available modulations, data rates, XYZ axis and antenna ports

The worst case was found when positioned on Z-plane for EIRP and Z-axis for radiated emission. Following channel(s) was (were) selected for the final test as listed below:

| EUT Configure Mode | Test Item                  | Available Channel | Tested Channel      | Channel Bandwidth | Modulation  | Mode                                       |
|--------------------|----------------------------|-------------------|---------------------|-------------------|-------------|--|
| -                  | EIRP                       | 27685 to 27735    | 27685, 27710, 27735 | 5 MHz             | QPSK, 16QAM | 1 RB / 24 RB Offset                        |
|                    |                            | 27710             | 27710               | 10 MHz            | QPSK, 16QAM | 1 RB / 49 RB Offset                        |
| -                  | Modulation Characteristics | 27710             | 27710               | 5 MHz             | QPSK, 16QAM | 25 RB / 0 RB Offset                        |
| -                  | Frequency Stability        | 27685 to 27735    | 27685, 27735        | 5 MHz             | QPSK        | 1 RB / 24 RB Offset                        |
|                    |                            | 27710             | 27710               | 10 MHz            | QPSK        | 1 RB / 49 RB Offset                        |
| -                  | Occupied Bandwidth         | 27685 to 27735    | 27685, 27710, 27735 | 5 MHz             | QPSK, 16QAM | 25 RB / 0 RB Offset                        |
|                    |                            | 27710             | 27710               | 10 MHz            | QPSK, 16QAM | 50 RB / 0 RB Offset                        |
| -                  | Band Edge                  | 27685 to 27735    | 27685               | 5 MHz             | QPSK, 16QAM | 1 RB / 0 RB Offset<br>25 RB / 0 RB Offset  |
|                    |                            |                   | 27735               | 5 MHz             | QPSK, 16QAM | 1 RB / 24 RB Offset<br>25 RB / 0 RB Offset |
|                    |                            | 27710             | 27710               | 10 MHz            | QPSK, 16QAM | 1 RB / 0 RB Offset                         |
|                    |                            |                   |                     |                   |             | 1 RB / 49 RB Offset<br>50 RB / 0 RB Offset |
| -                  | Conducted Emission         | 27685 to 27735    | 27685, 27710, 27735 | 5 MHz             | QPSK        | 1 RB / 24 RB Offset                        |
|                    |                            | 27710             | 27710               | 10 MHz            | QPSK        | 1 RB / 49 RB Offset                        |
| -                  | Radiated Emission          | 27685 to 27735    | 27685, 27710, 27735 | 5 MHz             | QPSK        | 1 RB / 24 RB Offset                        |
|                    |                            | 27710             | 27710               | 10 MHz            | QPSK        | 1 RB / 49 RB Offset                        |

**Note:** This device was tested under all bandwidths, RB configurations and modulations. The worst case was found in QPSK modulation.



**Test Condition:**

| Test Item                  | Environmental Conditions | Input Power    | Tested By  |
|----------------------------|--------------------------|----------------|------------|
| EIRP                       | 25 deg. C, 65 % RH       | 3.3 Vdc        | Thomas Wei |
| Modulation Characteristics | 25 deg. C, 65 % RH       | 3.3 Vdc        | Getaz Yang |
| Frequency Stability        | 25 deg. C, 65 % RH       | 3.3 Vdc        | Getaz Yang |
| Occupied Bandwidth         | 25 deg. C, 65 % RH       | 3.3 Vdc        | Getaz Yang |
| Band Edge                  | 25 deg. C, 65 % RH       | 3.3 Vdc        | Getaz Yang |
| Conducted Emission         | 25 deg. C, 65 % RH       | 3.3 Vdc        | Getaz Yang |
| Radiated Emission          | 25 deg. C, 65 % RH       | 120 Vac, 60 Hz | Thomas Wei |

### **3.4 EUT Operating Conditions**

The EUT makes a call to the communication simulator. The communication simulator station system controlled a EUT to export maximum output power under transmission mode and specific channel frequency

### **3.5 General Description of Applied Standards**

The EUT is a RF Product. According to the specifications of the manufacturer, it must comply with the requirements of the following standards:

**FCC 47 CFR Part 2**

**FCC 47 CFR Part 27**

**KDB 971168 D01 Power Meas License Digital Systems v03r01**

**ANSI/TIA/EIA-603-E 2016**

**ANSI 63.26-2015**

**NOTE:** All test items have been performed and recorded as per the above standards.

## 4 Test Types and Results

### 4.1 Output Power Measurement

#### 4.1.1 Limits of Output Power Measurement

Mobile and portable stations. (i) For mobile and portable stations transmitting in the 2305-2315 MHz band or the 2350-2360 MHz band, the average EIRP must not exceed 50 milliwatts within any 1 megahertz of authorized bandwidth, except that for mobile and portable stations compliant with 3GPP LTE standards or another advanced mobile broadband protocol that avoids concentrating energy at the edge of the operating band the average EIRP must not exceed 250 milliwatts within any 5 megahertz of authorized bandwidth but may exceed 50 milliwatts within any 1 megahertz of authorized bandwidth. For mobile and portable stations using time division duplexing (TDD) technology, the duty cycle must not exceed 38 percent in the 2305-2315 MHz and 2350-2360 MHz bands. Mobile and portable stations using FDD technology are restricted to transmitting in the 2305-2315 MHz band. Power averaging shall not include intervals in which the transmitter is off.

#### 4.1.2 Test Procedures

##### **EIRP Measurement:**

- a. All measurements were done at low, middle and high operational frequency range. RBW is 5 MHz and VBW is 15 MHz for LTE mode.
- b. Substitution method is used for E.I.R.P measurement. In the semi-anechoic chamber, EUT placed on the 0.8 m (below or equal 1 GHz) and/or 1.5 m (above 1 GHz) height of Turn Table, rotated the table around 360 degrees to search the maximum radiation power and receiver antenna shall be rotated vertical and horizontal polarization and moved height from 1 m to 4 m to find the maximum polar radiated power. The "Read Value" is the spectrum reading the maximum power value.
- c. The substitution horn antenna is substituted for EUT at the same position and signals generator export the CW signal to the substitution antenna via a tx cable. Rotated the Turn Table and moved receiving antenna to find the maximum radiation power. Adjust output power level of S.G to get a Value of spectrum reading equal to "Read Value" of step b. Record the power level of S.G.
- d.  $EIRP = \text{Output power level of S.G} - \text{TX cable loss} + \text{Antenna gain of substitution horn}.$

##### **Conducted Power Measurement:**

- a. The EUT was set up for the maximum power with LTE link data modulation and link up with simulator.
- b. Set the EUT to transmit under low, middle and high channel and record the power level shown on simulator.

4.1.3 Test Setup

**EIRP / ERP Measurement:**

**<Radiated Emission below or equal 1 GHz>**

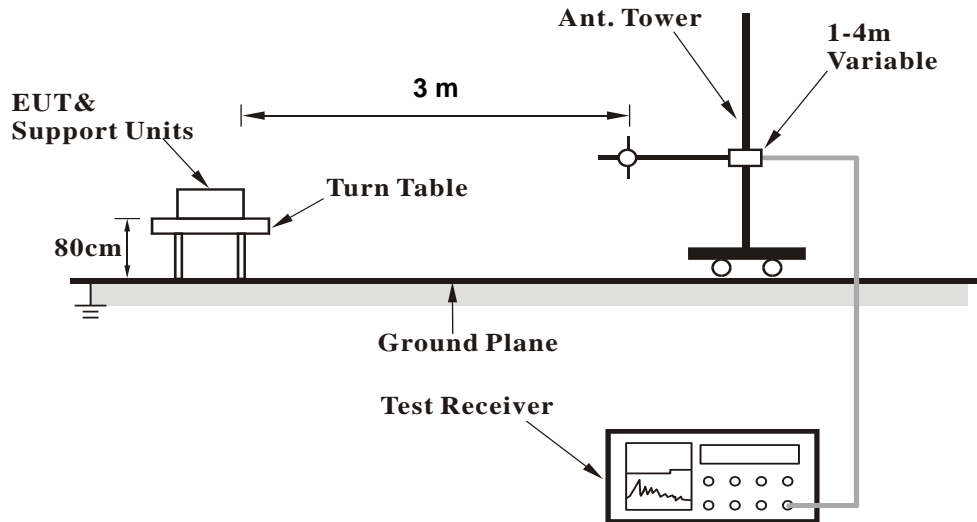

**<Radiated Emission above 1 GHz>**

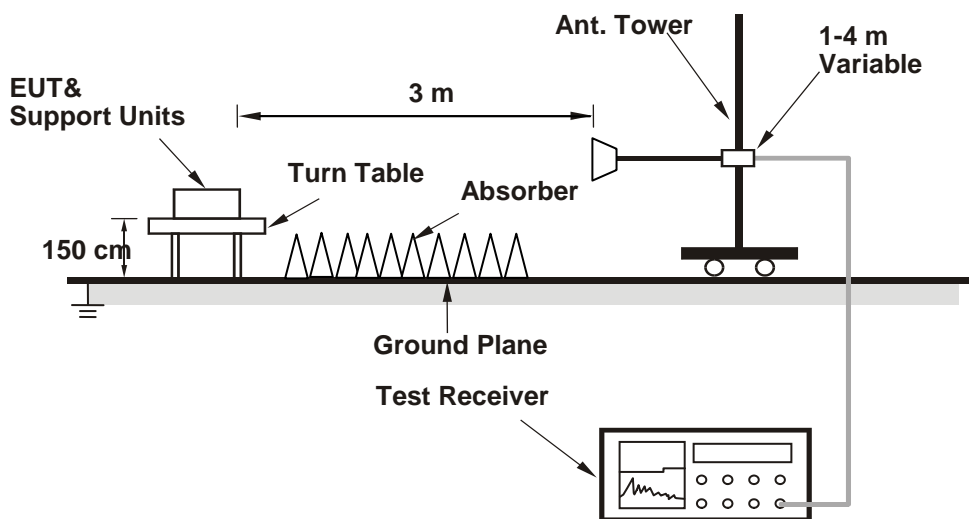

For the actual test configuration, please refer to the attached file (Test Setup Photo).

**Conducted Power Measurement:**

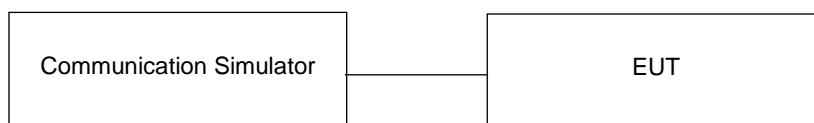

#### 4.1.4 Test Results

##### Conducted Output Power (dBm)

| LTE Band / BW | RB Size | RB Offset | QPSK         |              |               | 3GPP MPR (dB) | 16QAM        |              |               | 3GPP MPR (dB) |
|---------------|---------|-----------|--------------|--------------|---------------|---------------|--------------|--------------|---------------|---------------|
|               |         |           | Low Ch 27685 | Mid Ch 27710 | High Ch 27735 |               | Low Ch 27685 | Mid Ch 27710 | High Ch 27735 |               |
|               |         |           | 2307.5 MHz   | 2310.0 MHz   | 2312.5 MHz    |               | 2307.5 MHz   | 2310.0 MHz   | 2312.5 MHz    |               |
| 30 / 5M       | 1       | 0         | 22.39        | 22.45        | 22.64         | 0             | 21.32        | 21.37        | 21.57         | 1             |
|               | 1       | 12        | 22.24        | 22.29        | 22.55         | 0             | 21.25        | 21.26        | 21.47         | 1             |
|               | 1       | 24        | 22.06        | 22.21        | 22.30         | 0             | 20.98        | 21.10        | 21.26         | 1             |
|               | 12      | 0         | 21.27        | 21.30        | 21.51         | 1             | 20.09        | 20.14        | 20.47         | 2             |
|               | 12      | 6         | 21.06        | 21.08        | 21.32         | 1             | 20.02        | 20.12        | 20.20         | 2             |
|               | 12      | 13        | 21.04        | 20.98        | 21.25         | 1             | 19.96        | 20.05        | 20.20         | 2             |
|               | 25      | 0         | 21.30        | 21.34        | 21.53         | 1             | 20.20        | 20.18        | 20.33         | 2             |

| LTE Band / BW | RB Size | RB Offset | QPSK         | 3GPP MPR (dB) | 16QAM        | 3GPP MPR (dB) |
|---------------|---------|-----------|--------------|---------------|--------------|---------------|
|               |         |           | Mid Ch 27710 |               | Mid Ch 27710 |               |
|               |         |           | 2310.0 MHz   |               | 2310.0 MHz   |               |
| 30 / 10M      | 1       | 0         | 22.54        | 0             | 21.49        | 1             |
|               | 1       | 24        | 22.38        | 0             | 21.33        | 1             |
|               | 1       | 49        | 22.21        | 0             | 21.32        | 1             |
|               | 25      | 0         | 21.42        | 1             | 20.30        | 2             |
|               | 25      | 12        | 21.22        | 1             | 20.16        | 2             |
|               | 25      | 25        | 21.18        | 1             | 20.10        | 2             |
|               | 50      | 0         | 21.32        | 1             | 20.34        | 2             |

**EIRP Power (dBm)**

| LTE Band 30                      |         |                 |               |                        |            |           |                    |
|----------------------------------|---------|-----------------|---------------|------------------------|------------|-----------|--------------------|
| Channel Bandwidth: 5 MHz / QPSK  |         |                 |               |                        |            |           |                    |
| Plane                            | Channel | Frequency (MHz) | Reading (dBm) | Correction Factor (dB) | EIRP (dBm) | EIRP (mW) | Polarization (H/V) |
| Z                                | 27685   | 2307.5          | -26.63        | 44.66                  | 18.03      | 63.49     | H                  |
|                                  | 27710   | 2310.0          | -26.85        | 44.59                  | 17.74      | 59.43     |                    |
|                                  | 27735   | 2312.5          | -26.69        | 44.70                  | 18.01      | 63.24     |                    |
|                                  | 27685   | 2307.5          | -21.91        | 45.82                  | 23.91      | 245.87    | V                  |
|                                  | 27710   | 2310.0          | -21.66        | 45.02                  | 23.36      | 216.67    |                    |
|                                  | 27735   | 2312.5          | -21.81        | 45.64                  | 23.83      | 241.55    |                    |
| Channel Bandwidth: 5 MHz / 16QAM |         |                 |               |                        |            |           |                    |
| Z                                | 27685   | 2307.5          | -27.64        | 44.66                  | 17.02      | 50.32     | H                  |
|                                  | 27710   | 2310.0          | -27.86        | 44.59                  | 16.73      | 47.10     |                    |
|                                  | 27735   | 2312.5          | -27.69        | 44.70                  | 17.01      | 50.23     |                    |
|                                  | 27685   | 2307.5          | -22.99        | 45.82                  | 22.83      | 191.73    | V                  |
|                                  | 27710   | 2310.0          | -22.65        | 45.02                  | 22.37      | 172.50    |                    |
|                                  | 27735   | 2312.5          | -22.83        | 45.64                  | 22.81      | 190.99    |                    |

Note: EIRP (dBm) = Reading (dBm) + Correction Factor (dB)

| LTE Band 30                       |         |                 |               |                        |            |           |                    |
|-----------------------------------|---------|-----------------|---------------|------------------------|------------|-----------|--------------------|
| Channel Bandwidth: 10 MHz / QPSK  |         |                 |               |                        |            |           |                    |
| Plane                             | Channel | Frequency (MHz) | Reading (dBm) | Correction Factor (dB) | EIRP (dBm) | EIRP (mW) | Polarization (H/V) |
| Z                                 | 27710   | 2310.0          | -26.52        | 44.59                  | 18.07      | 64.12     | H                  |
|                                   | 27710   | 2310.0          | -21.05        | 45.02                  | 23.97      | 249.46    | V                  |
| Channel Bandwidth: 10 MHz / 16QAM |         |                 |               |                        |            |           |                    |
| Z                                 | 27710   | 2310.0          | -27.53        | 44.59                  | 17.06      | 50.82     | H                  |
|                                   | 27710   | 2310.0          | -22.09        | 45.02                  | 22.93      | 196.34    | V                  |

Note: EIRP (dBm) = Reading (dBm) + Correction Factor (dB)

## 4.2 Modulation Characteristics Measurement

### 4.2.1 Limits of Modulation Characteristics

N/A

### 4.2.2 Test Setup



### 4.2.3 Test Procedure

Connect the EUT to Communication Simulator via the antenna connector. The frequency band is set as EUT supported Modulation and Channels, the EUT output is matched with 50 ohm load, the waveform quality and constellation of the EUT was tested.

### 4.2.4 Test Results

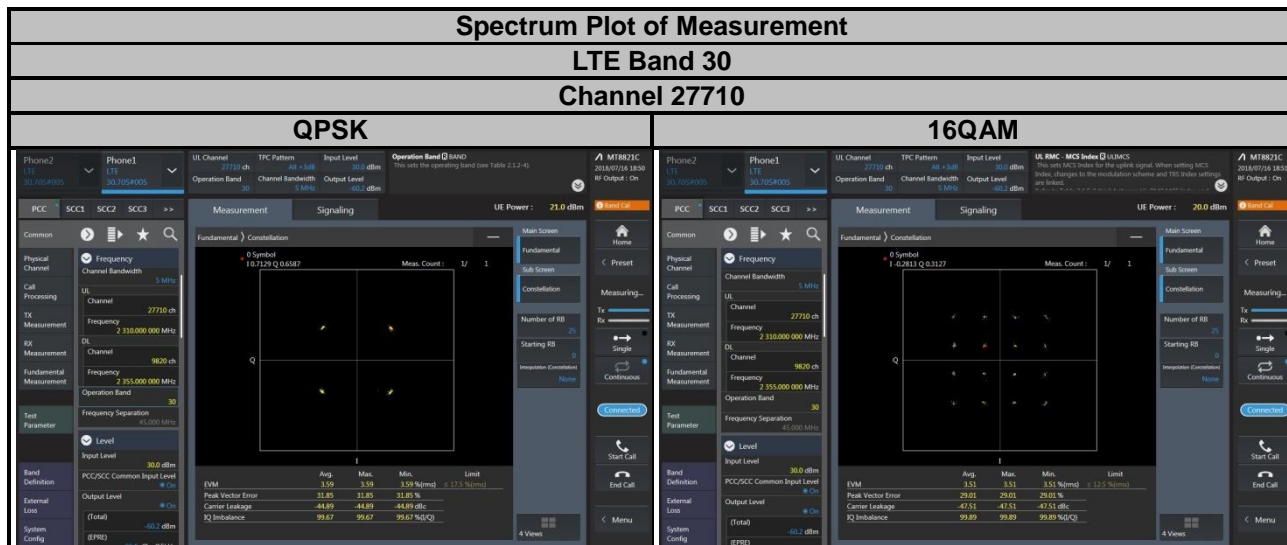



### 4.3 Frequency Stability Measurement

#### 4.3.1 Limits of Frequency Stability Measurement

The frequency stability shall be sufficient to ensure that the fundamental emissions stay within the authorized bands of operation.

#### 4.3.2 Test Procedure

- Device is placed at the oven room. The oven room could control the temperatures and humidity. Power warm up is at least 15 min and power applied should perform before recording frequency error.
- EUT is connected the external power supply to control the DC input power. The test voltage range is from minimum to maximum working voltage. Each step shall be record the frequency error rate.
- The temperature range step is 10 degrees in this test items. All temperature levels shall be hold the  $\pm 0.5$  °C during the measurement testing. The each temperature step shall be at least 0.5 hours, consider the EUT could be test under the stability condition.

**Note:** The frequency error was recorded frequency error from the communication simulator.

#### 4.3.3 Test Setup

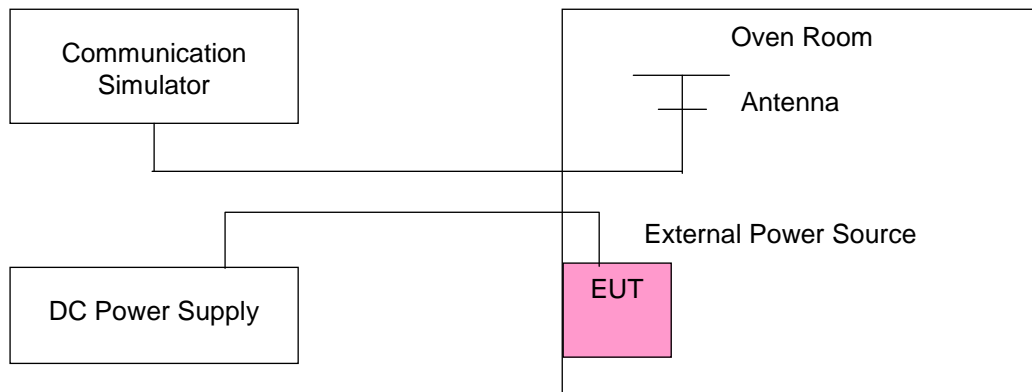

#### 4.3.4 Test Results

##### Frequency Error vs. Voltage

| Voltage<br>(Volts) | LTE Band 30              |                       |                 |                       | Limit (ppm) |
|--------------------|--------------------------|-----------------------|-----------------|-----------------------|-------------|
|                    | Channel Bandwidth: 5 MHz |                       |                 |                       |             |
|                    | Low Channel              |                       | High Channel    |                       |             |
|                    | Frequency (MHz)          | Frequency Error (ppm) | Frequency (MHz) | Frequency Error (ppm) |             |
| 3.3                | 2307.500003              | 0.001                 | 2312.500002     | 0.001                 | 2.5         |
| 3.135              | 2307.500004              | 0.002                 | 2312.500003     | 0.001                 | 2.5         |
| 4.4                | 2307.500003              | 0.001                 | 2312.500003     | 0.001                 | 2.5         |

**Note:** The applicant defined the normal working voltage of the battery is from 3.135 Vdc to 4.4 Vdc.

##### Frequency Error vs. Temperature

| Temp. (°C) | LTE Band 30              |                       |                 |                       | Limit (ppm) |
|------------|--------------------------|-----------------------|-----------------|-----------------------|-------------|
|            | Channel Bandwidth: 5 MHz |                       |                 |                       |             |
|            | Low Channel              |                       | High Channel    |                       |             |
|            | Frequency (MHz)          | Frequency Error (ppm) | Frequency (MHz) | Frequency Error (ppm) |             |
| -30        | 2307.500002              | 0.001                 | 2312.500001     | 0.000                 | 2.5         |
| -20        | 2307.500003              | 0.001                 | 2312.500003     | 0.001                 | 2.5         |
| -10        | 2307.500002              | 0.001                 | 2312.500002     | 0.001                 | 2.5         |
| 0          | 2307.500003              | 0.001                 | 2312.500002     | 0.001                 | 2.5         |
| 10         | 2307.500002              | 0.001                 | 2312.500002     | 0.001                 | 2.5         |
| 20         | 2307.499999              | -0.001                | 2312.499998     | -0.001                | 2.5         |
| 30         | 2307.499996              | -0.002                | 2312.499997     | -0.001                | 2.5         |
| 40         | 2307.499999              | -0.001                | 2312.499998     | -0.001                | 2.5         |
| 50         | 2307.499997              | -0.001                | 2312.499996     | -0.002                | 2.5         |
| 55         | 2307.499998              | -0.001                | 2312.499997     | -0.001                | 2.5         |

## Frequency Error vs. Voltage

| Voltage<br>(Volts) | LTE Band 30               |                       | Limit (ppm) |
|--------------------|---------------------------|-----------------------|-------------|
|                    | Channel Bandwidth: 10 MHz |                       |             |
|                    | Frequency (MHz)           | Frequency Error (ppm) |             |
| 3.3                | 2310.000002               | 0.001                 | 2.5         |
| 3.135              | 2310.000002               | 0.001                 | 2.5         |
| 4.4                | 2310.000003               | 0.001                 | 2.5         |

**Note:** The applicant defined the normal working voltage of the battery is from 3.135 Vdc to 4.4 Vdc.

## Frequency Error vs. Temperature

| Temp. (°C) | LTE Band 30               |                       | Limit (ppm) |
|------------|---------------------------|-----------------------|-------------|
|            | Channel Bandwidth: 10 MHz |                       |             |
|            | Frequency (MHz)           | Frequency Error (ppm) |             |
| -30        | 2310.000002               | 0.001                 | 2.5         |
| -20        | 2310.000003               | 0.001                 | 2.5         |
| -10        | 2310.000002               | 0.001                 | 2.5         |
| 0          | 2310.000004               | 0.002                 | 2.5         |
| 10         | 2310.000004               | 0.002                 | 2.5         |
| 20         | 2309.999998               | -0.001                | 2.5         |
| 30         | 2309.999999               | 0.000                 | 2.5         |
| 40         | 2309.999997               | -0.001                | 2.5         |
| 50         | 2309.999998               | -0.001                | 2.5         |
| 55         | 2309.999997               | -0.001                | 2.5         |

#### 4.4 Occupied Bandwidth Measurement

##### 4.4.1 Limits of Occupied Bandwidth Measurement

The width of a frequency band such that, below the lower and above the upper frequency limits, the mean powers emitted are each equal to a specified percentage 0.5 % of the total mean power of a given emission.

##### 4.4.2 Test Procedure

- The conducted occupied bandwidth used the power splitter via EUT RF power connector between simulation base station and spectrum analyzer.
- Use OBW measurement function of Spectrum analyzer to measure 99 % occupied bandwidth.

##### 4.4.3 Test Setup

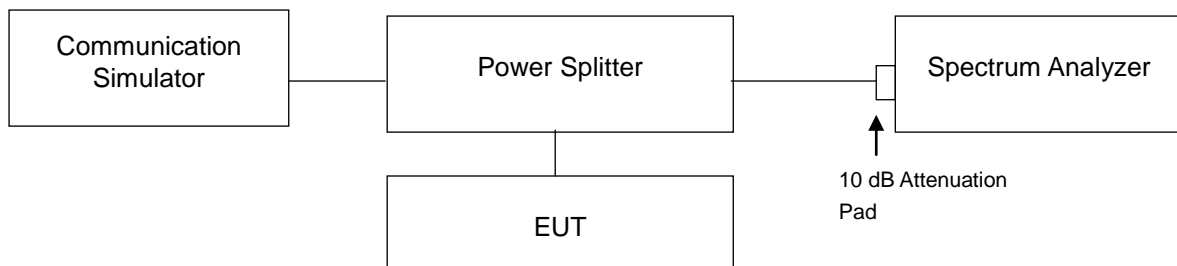

#### 4.4.4 Test Result

| LTE Band 30              |                 |                               |       |                           |                 |                               |       |
|--------------------------|-----------------|-------------------------------|-------|---------------------------|-----------------|-------------------------------|-------|
| Channel Bandwidth: 5 MHz |                 |                               |       | Channel Bandwidth: 10 MHz |                 |                               |       |
| Channel                  | Frequency (MHz) | 99 % Occupied Bandwidth (MHz) |       | Channel                   | Frequency (MHz) | 99 % Occupied Bandwidth (MHz) |       |
|                          |                 | QPSK                          | 16QAM |                           |                 | QPSK                          | 16QAM |
| 27685                    | 2307.5          | 4.50                          | 4.50  | 27710                     | 2310.0          | 8.97                          | 8.98  |
| 27710                    | 2310.0          | 4.50                          | 4.50  |                           |                 |                               |       |
| 27735                    | 2312.5          | 4.50                          | 4.49  |                           |                 |                               |       |

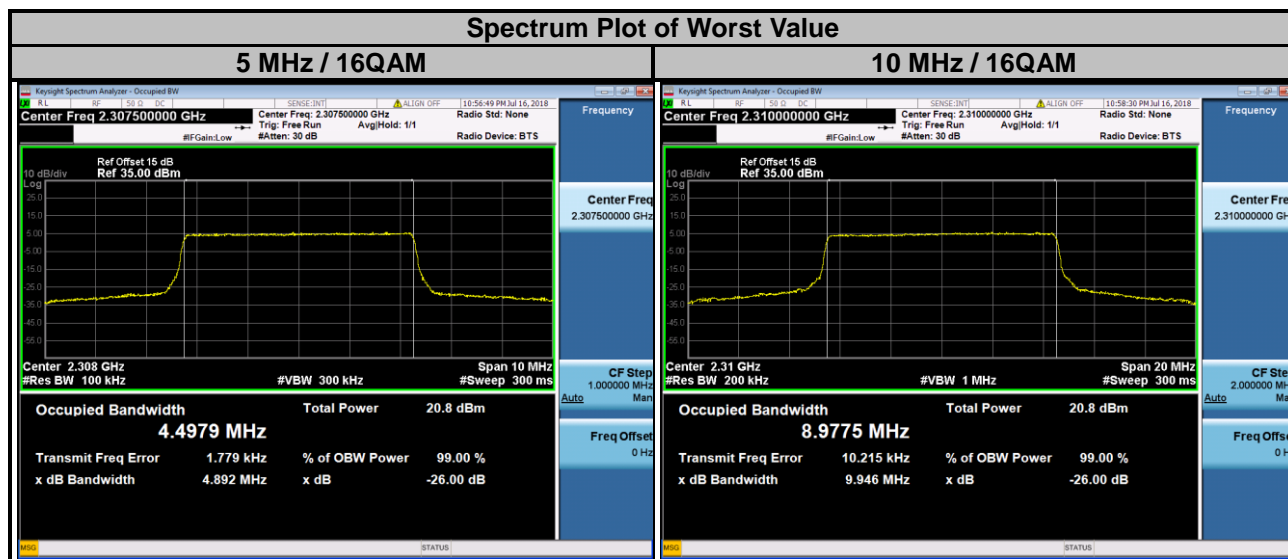

## 4.5 Band Edge Measurement

### 4.5.1 Limits of Band Edge Measurement

According to FCC 27.53(a) (4) For mobile and portable stations operating in the 2305-2315 MHz and 2350-2360 MHz bands:

- (i) By a factor of not less than:  $43 + 10 \log (P)$  dB on all frequencies between 2305 and 2320 MHz and on all frequencies between 2345 and 2360 MHz that are outside the licensed band(s) of operation, not less than  $55 + 10 \log (P)$  dB on all frequencies between 2320 and 2324 MHz and on all frequencies between 2341 and 2345 MHz, not less than  $61 + 10 \log (P)$  dB on all frequencies between 2324 and 2328 MHz and on all frequencies between 2337 and 2341 MHz, and not less than  $67 + 10 \log (P)$  dB on all frequencies between 2328 and 2337 MHz;
- (ii) By a factor of not less than  $43 + 10 \log (P)$  dB on all frequencies between 2300 and 2305 MHz,  $55 + 10 \log (P)$  dB on all frequencies between 2296 and 2300 MHz,  $61 + 10 \log (P)$  dB on all frequencies between 2292 and 2296 MHz,  $67 + 10 \log (P)$  dB on all frequencies between 2288 and 2292 MHz, and  $70 + 10 \log (P)$  dB below 2288 MHz;
- (iii) By a factor of not less than  $43 + 10 \log (P)$  dB on all frequencies between 2360 and 2365 MHz, and not less than  $70 + 10 \log (P)$  dB above 2365 MHz.

### 4.5.2 Test Setup

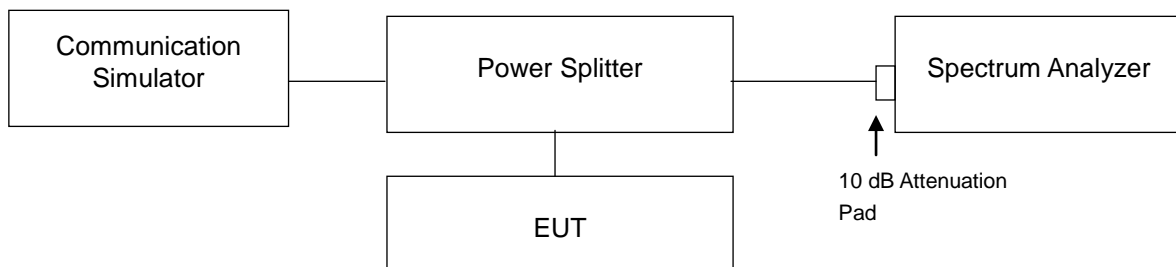

### 4.5.3 Test Procedures

- a. The EUT was set up for the maximum peak power with LTE link data modulation. The power was measured with R&S Spectrum Analyzer. All measurements were done at 2 channels (low and high operational frequency range).
- b. The band edge measurement used the power splitter via EUT RF power connector between simulation base station and spectrum analyzer.
- c. Measuring frequency range is from 2200 MHz to 2395 MHz for LTE Band 30. 10 dB attenuation pad is connected with spectrum. RBW = 1 MHz and VBW = 3 MHz are used for conducted emission measurement.
- d. Record the max trace plot into the test report.

### 4.5.4 Test Results

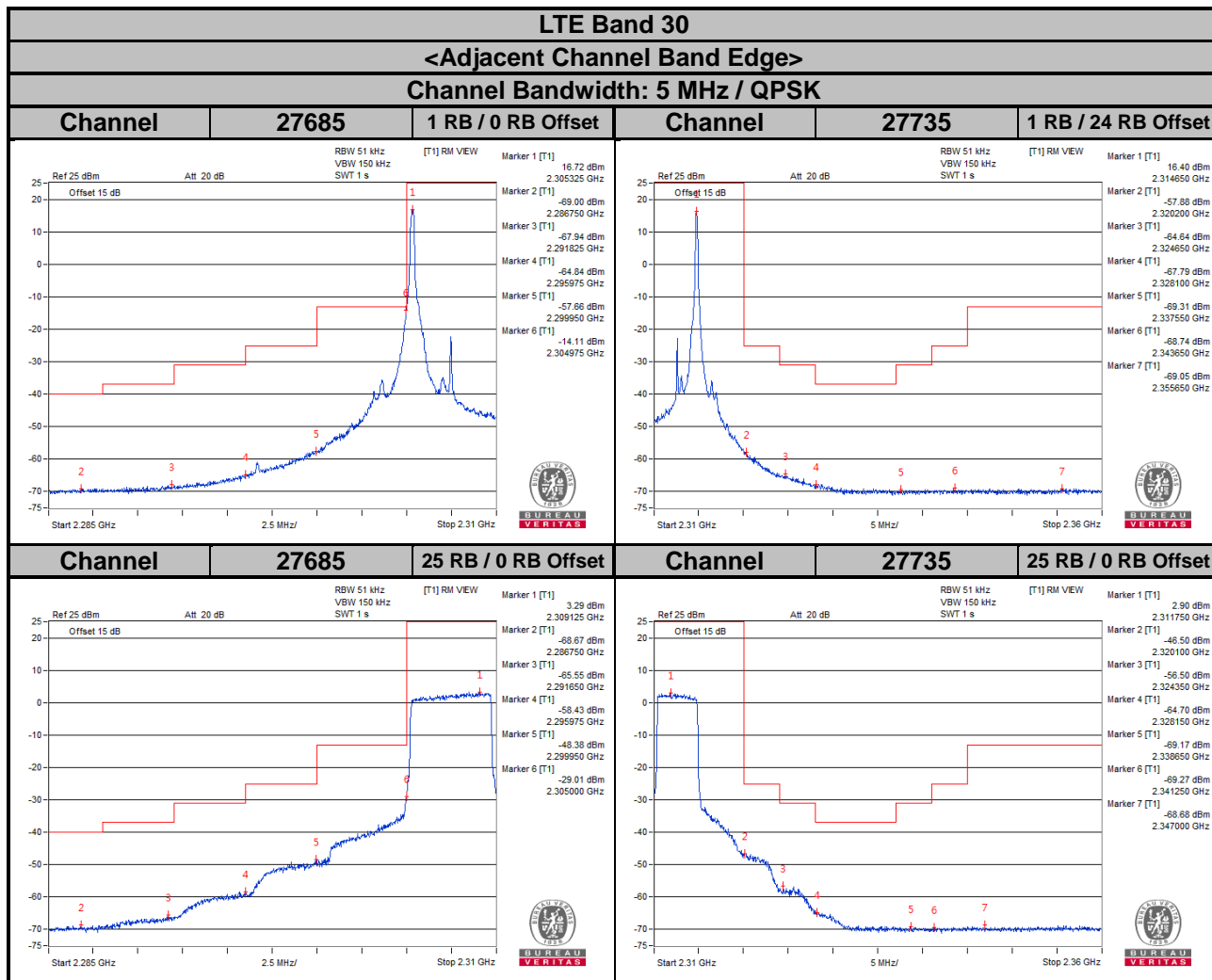

**LTE Band 30**  
**<Adjacent Channel Band Edge>**  
**Channel Bandwidth: 10 MHz / QPSK**

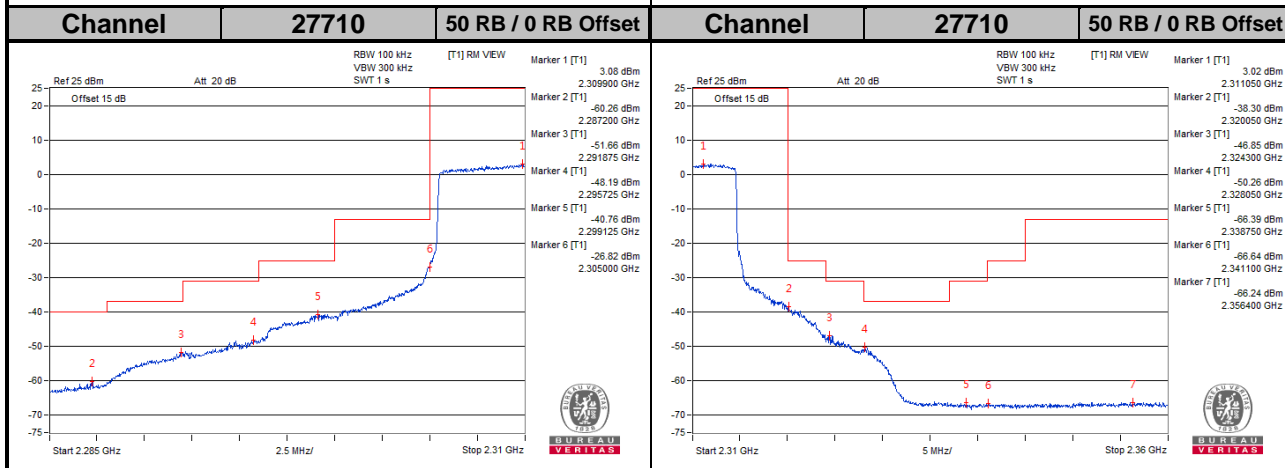
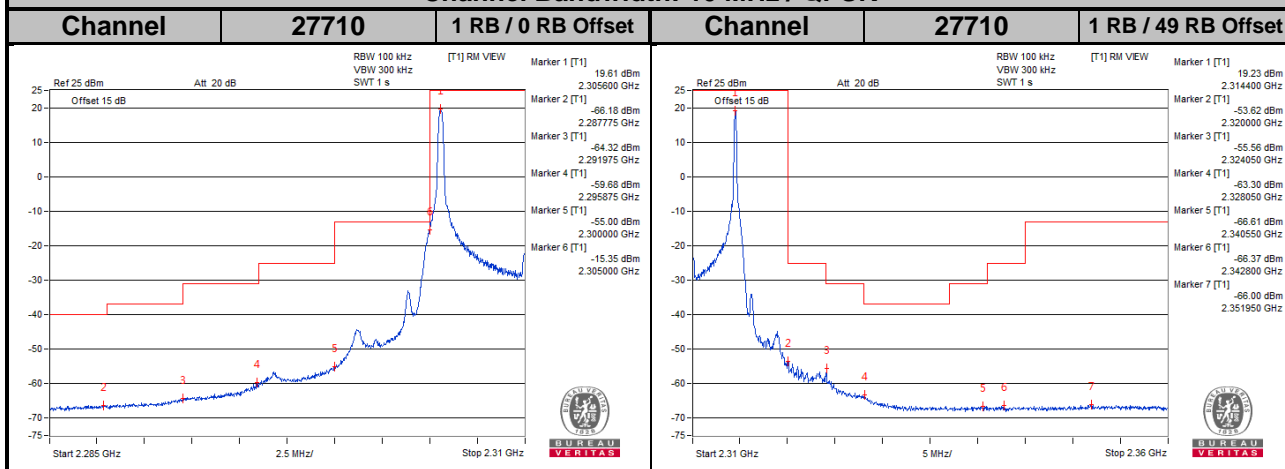



**LTE Band 30**  
**<Adjacent Channel Band Edge>**  
**Channel Bandwidth: 5 MHz / 16QAM**

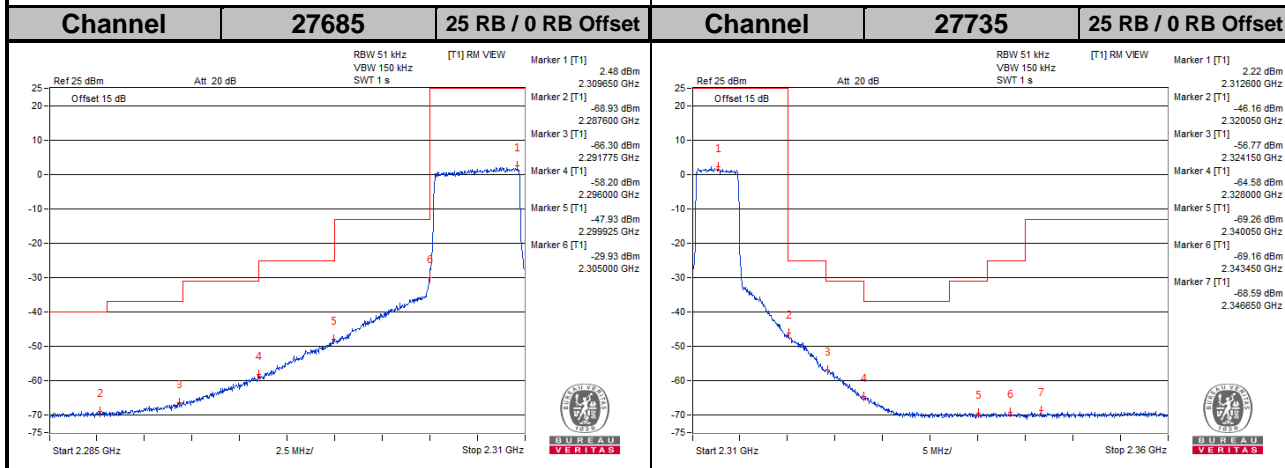
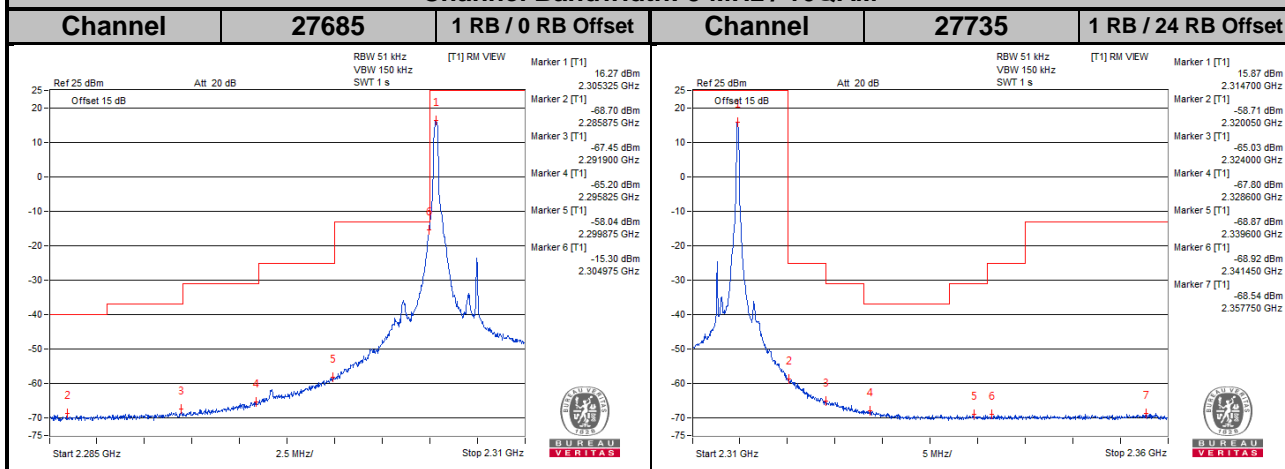

**LTE Band 30**  
**<Adjacent Channel Band Edge>**

**Channel Bandwidth: 10 MHz / 16QAM**

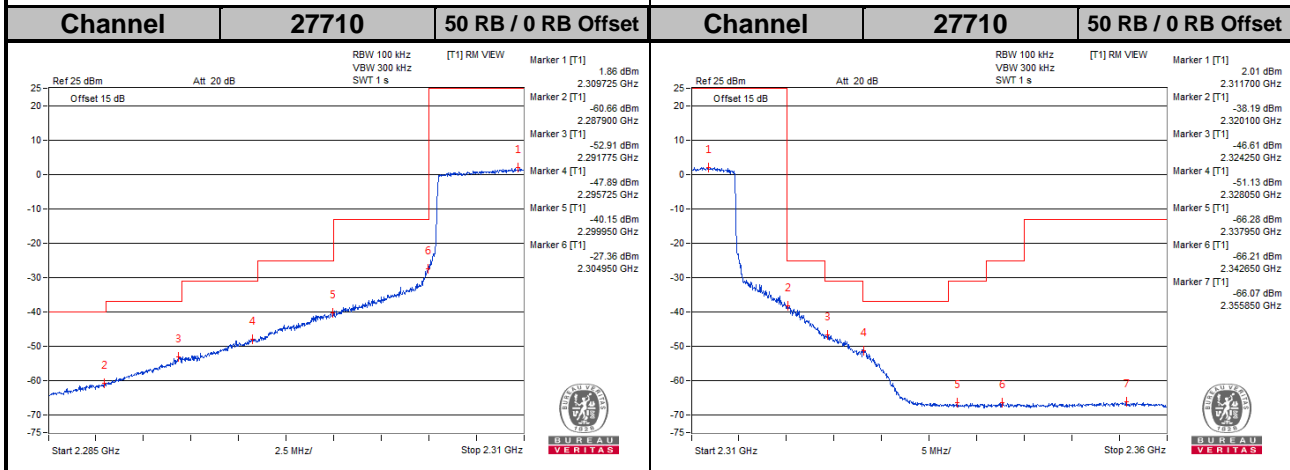
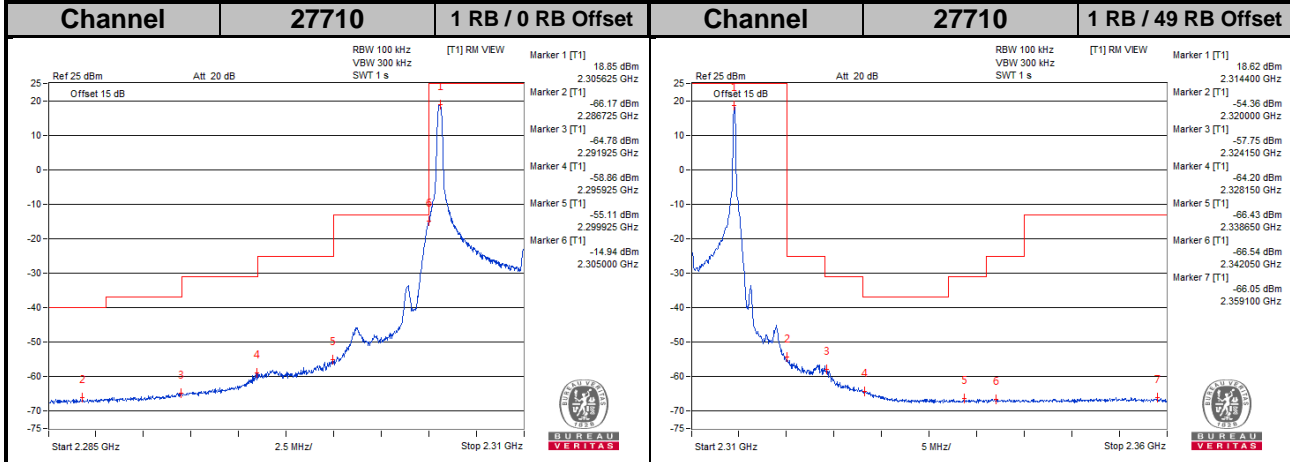

## 4.6 Conducted Spurious Emissions

### 4.6.1 Limits of Conducted Spurious Emissions Measurement

The power of any emission outside a licensee's frequency block shall be attenuated below the transmitter power (P) by at least  $70 + 10 \log_{10}(P)$  dB. The limit of emission is equal to -40 dBm.

### 4.6.2 Test Setup

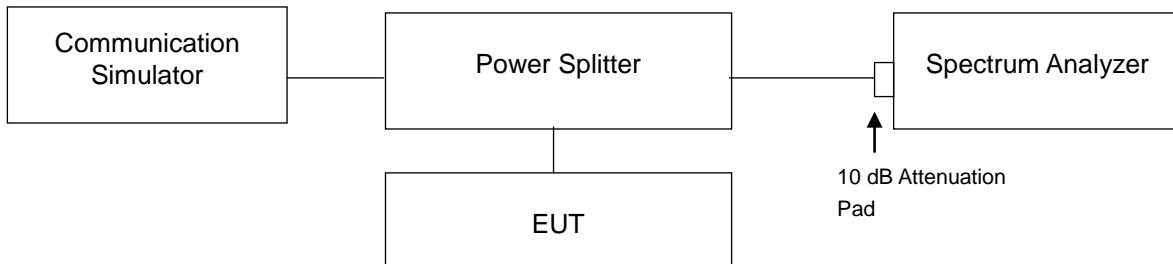

### 4.6.3 Test Procedure

- a. The EUT makes a phone call to the communication simulator. All measurements were done at low, middle and high operational frequency range.
- a. Measuring frequency range is from 9 kHz to 23.5 GHz for LTE Band 30. 10 dB attenuation pad is connected with spectrum. RBW = 100 kHz and VBW = 300 kHz for 9 kHz to 1 GHz and RBW = 1 MHz and VBW = 3 MHz for 1 GHz to 23.5 GHz is used for conducted emission measurement.

### 4.6.4 Test Results

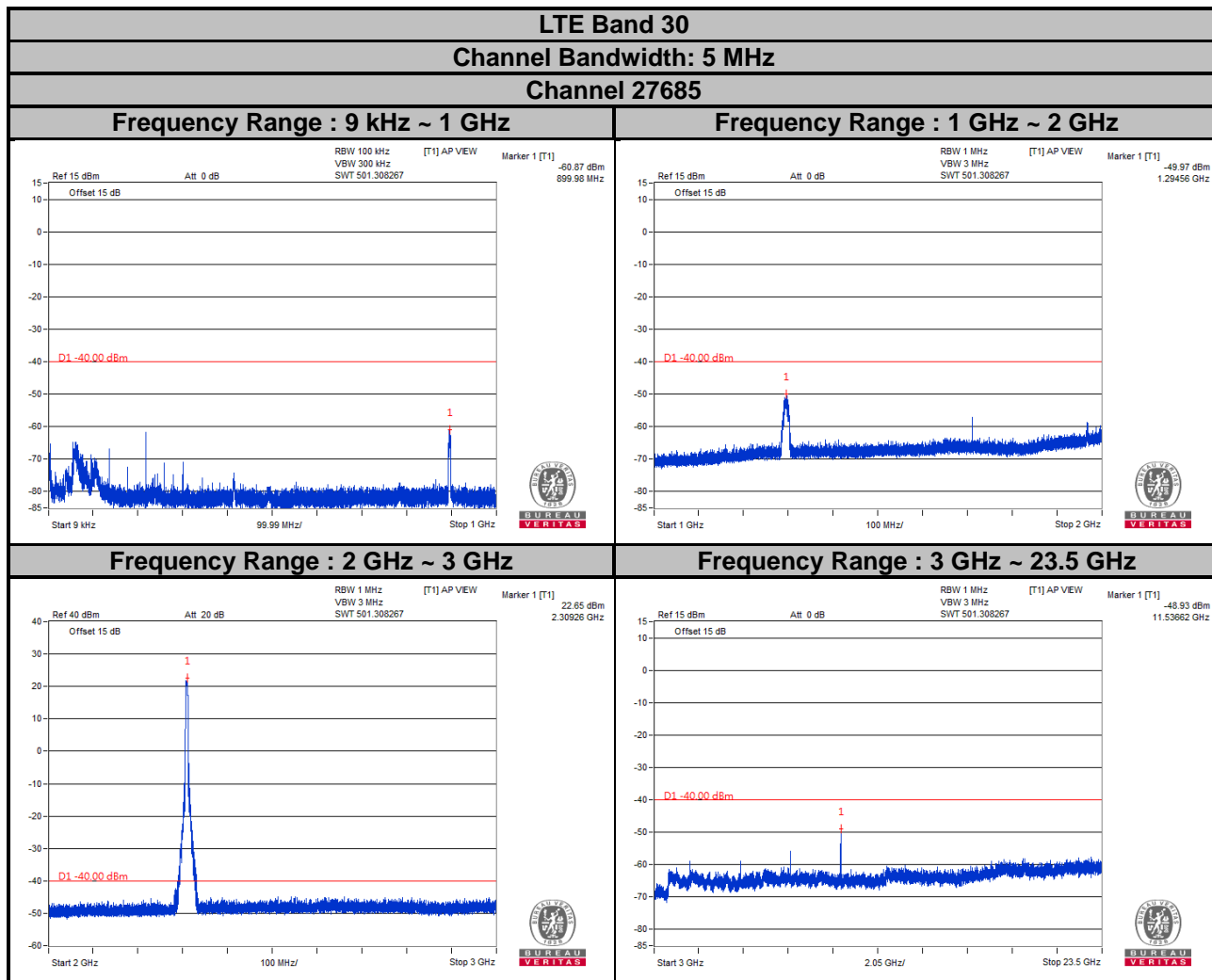

**LTE Band 30**

**Channel Bandwidth: 5 MHz**

**Channel 27710**

**Frequency Range : 9 kHz ~ 1 GHz**

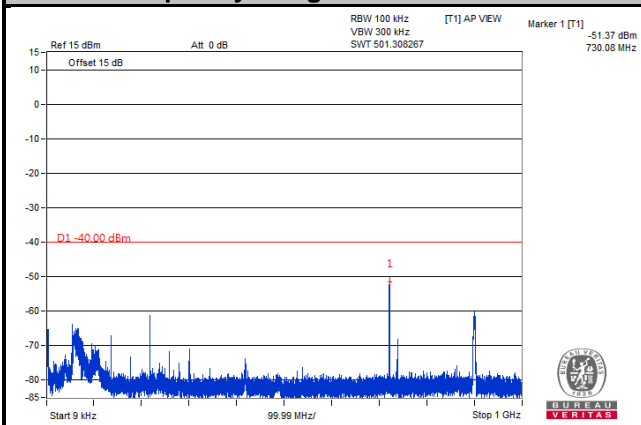

**Frequency Range : 1 GHz ~ 2 GHz**

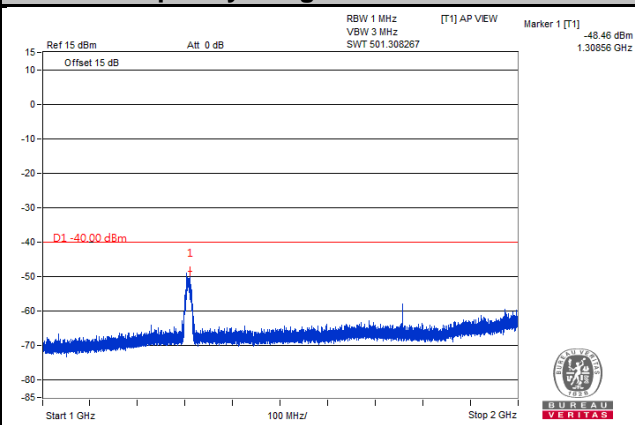

**Frequency Range : 2 GHz ~ 3 GHz**

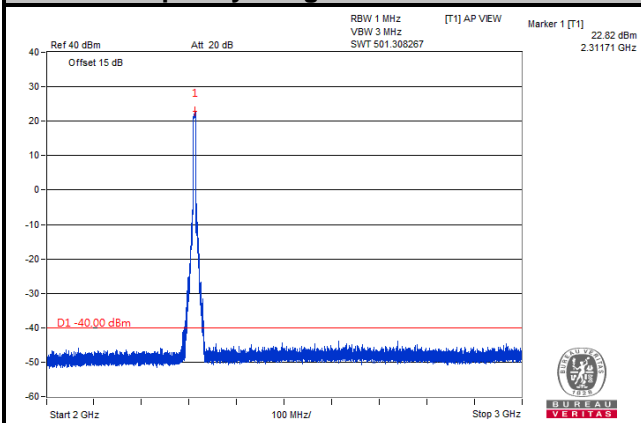

**Frequency Range : 3 GHz ~ 23.5 GHz**

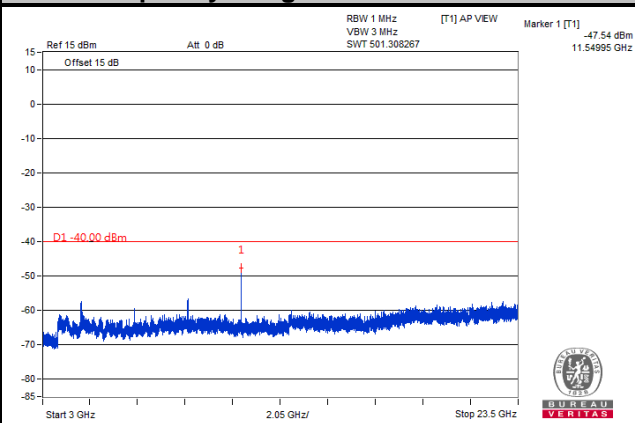

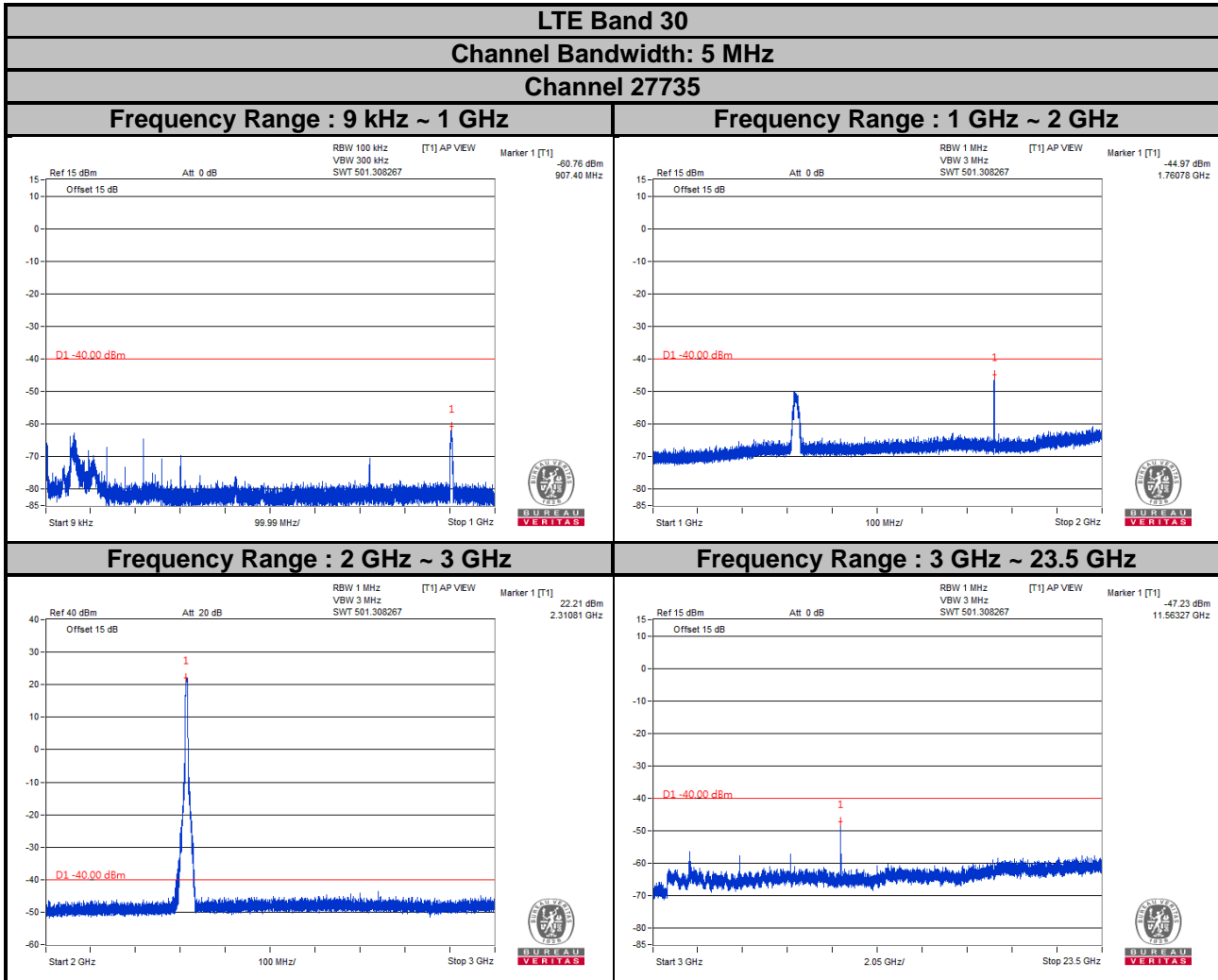

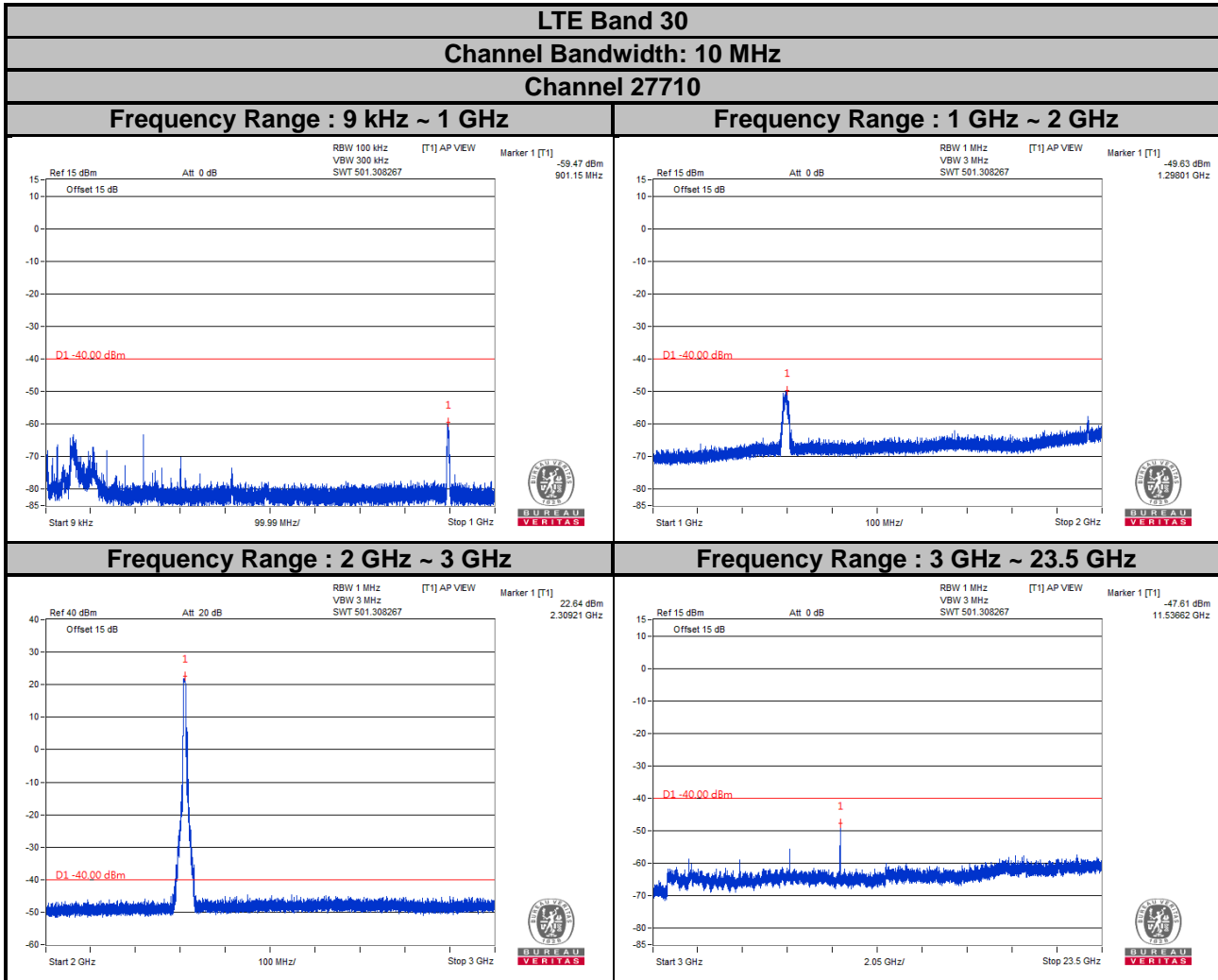

## 4.7 Radiated Emission Measurement

### 4.7.1 Limits of Radiated Emission Measurement

The power of any emission outside a licensee's frequency block shall be attenuated below the transmitter power (P) by at least  $70 + 10 \log_{10}(P)$  dB. The limit of emission is equal to -40 dBm.

### 4.7.2 Test Procedure

- a. Substitution method is used for E.I.R.P measurement. In the semi-anechoic chamber, EUT placed on the 0.8 m (below or equal 1 GHz) and/or 1.5 m (above 1 GHz) height of Turn Table, rotated the table around 360 degrees to search the maximum radiation power and receiver antenna shall be rotated vertical and horizontal polarization and moved height from 1 m to 4 m to find the maximum polar radiated power. The "Read Value" is the spectrum reading the maximum power value.
- b. The substitution horn antenna is substituted for EUT at the same position and signals generator export the CW signal to the substitution antenna via a TX cable. Rotated the Turn Table and moved receiving antenna to find the maximum radiation power. Adjust output power level of S.G to get a Value of spectrum reading equal to "Read Value " of step a. Record the power level of S.G
- c. EIRP = Output power level of S.G – TX cable loss + Antenna gain of substitution horn.
- d. E.R.P power can be calculated form E.I.R.P power by subtracting the gain of dipole, E.R.P power = E.I.R.P power - 2.15 dB.

**Note:** The resolution bandwidth of spectrum analyzer is 1 MHz and the video bandwidth is 3 MHz.

### 4.7.3 Deviation from Test Standard

No deviation.



4.7.4 Test Setup

<Radiated Emission below or equal 1 GHz>

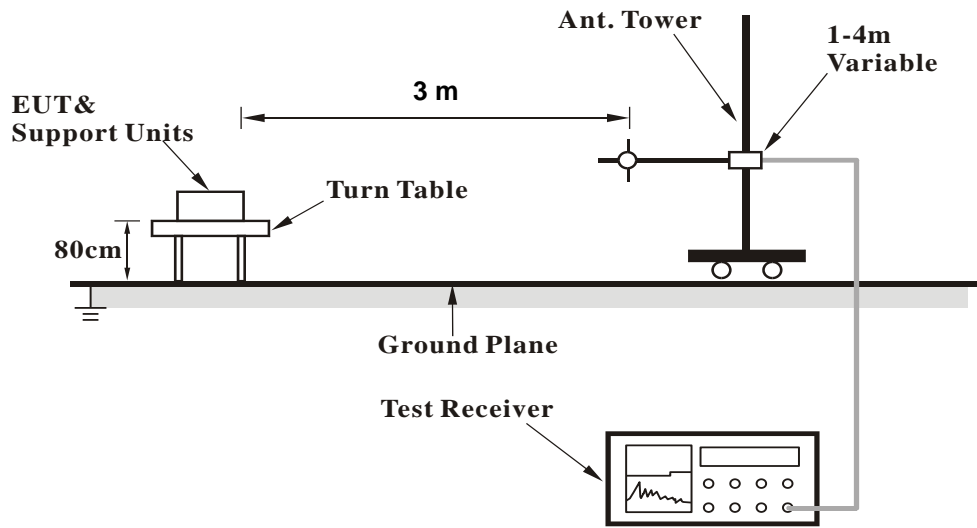

<Radiated Emission above 1 GHz>

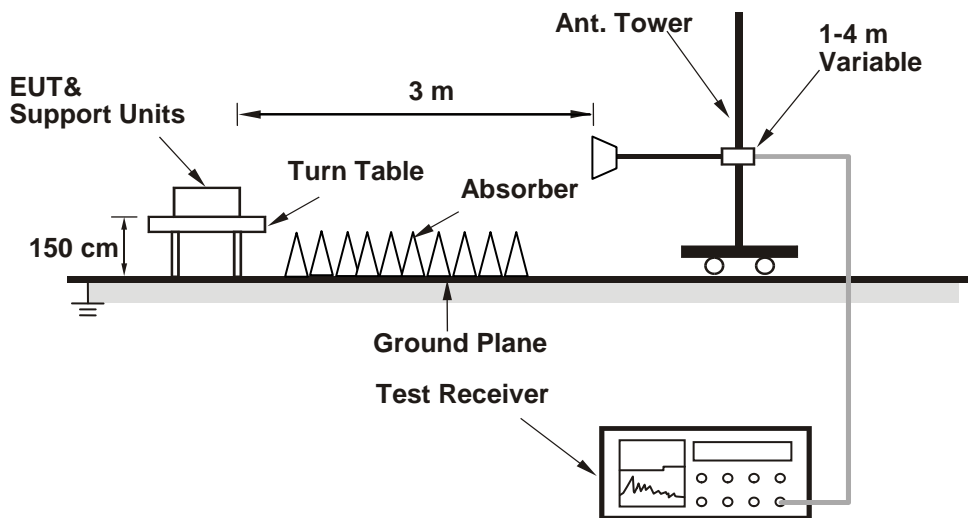

For the actual test configuration, please refer to the attached file (Test Setup Photo).

4.7.5 Test Results

LTE Band 30  
Channel Bandwidth: 5 MHz / QPSK  
Low Channel



Bureau Veritas Consumer Products Services Ltd., Taoyuan Branch

A D T

Data: 3

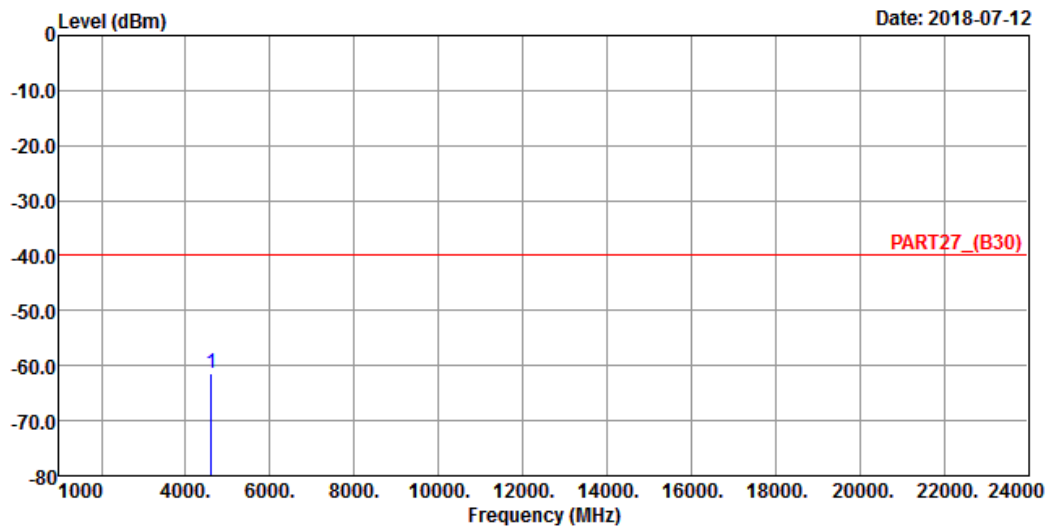

Site : 966 Chamber 5  
Condition: PART27\_(B30) HORIZONTAL  
Remak : LTE Band 30 QPSK\_5M\_L-CH Link  
Tested by: Jisyong Wang

| Freq | Level | Read Level | Limit Line | Over Limit | Factor | Remark |
|------|-------|------------|------------|------------|--------|--------|
| MHz  | dBm   | dBm        | dBm        | dB         | dB     |        |

1 pp 4615.00 -61.47 -57.82 -40.00 -21.47 -3.65 Peak



A D T

Data: 4

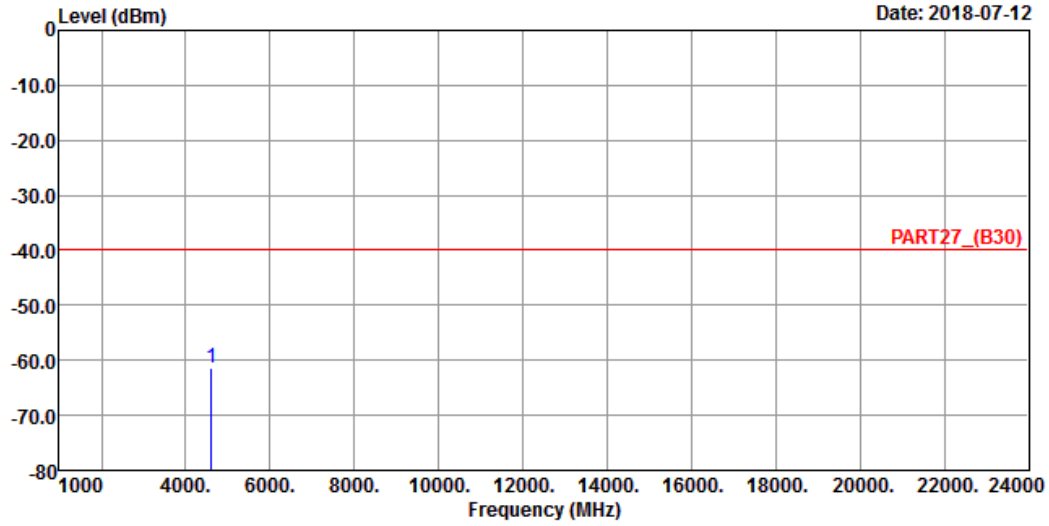

Site : 966 Chamber 5  
 Condition: PART27\_(B30) VERTICAL  
 Remak : LTE Band 30 QPSK\_5M\_L-CH Link  
 Tested by: Jisyong Wang

| Freq         | Level  | Read Level | Limit Line | Over Limit | Factor | Remark |
|--------------|--------|------------|------------|------------|--------|--------|
| MHz          | dBm    | dBm        | dBm        | dB         | dB     |        |
| 1 pp 4615.00 | -61.36 | -57.71     | -40.00     | -21.36     | -3.65  | Peak   |

Middle Channel



Bureau Veritas Consumer Products Services Ltd., Taoyuan Branch

A D T

Data: 3

Date: 2018-07-12

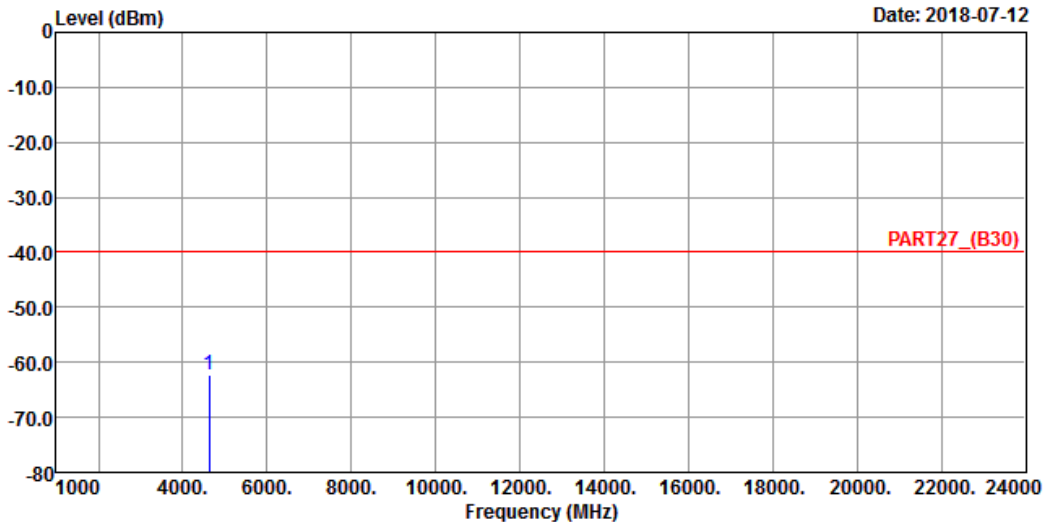

Site : 966 Chamber 5  
 Condition: PART27\_(B30) HORIZONTAL  
 Remak : LTE Band 30 QPSK\_5M\_M-CH Link  
 Tested by: Jisyong Wang

| Freq | Level | Read Level | Limit | Over | Factor | Remark |
|------|-------|------------|-------|------|--------|--------|
| MHz  | dBm   | dBm        | dBm   | dB   | dB     |        |

1 pp 4620.00 -62.21 -58.53 -40.00 -22.21 -3.68 Peak



A D T

Data: 4

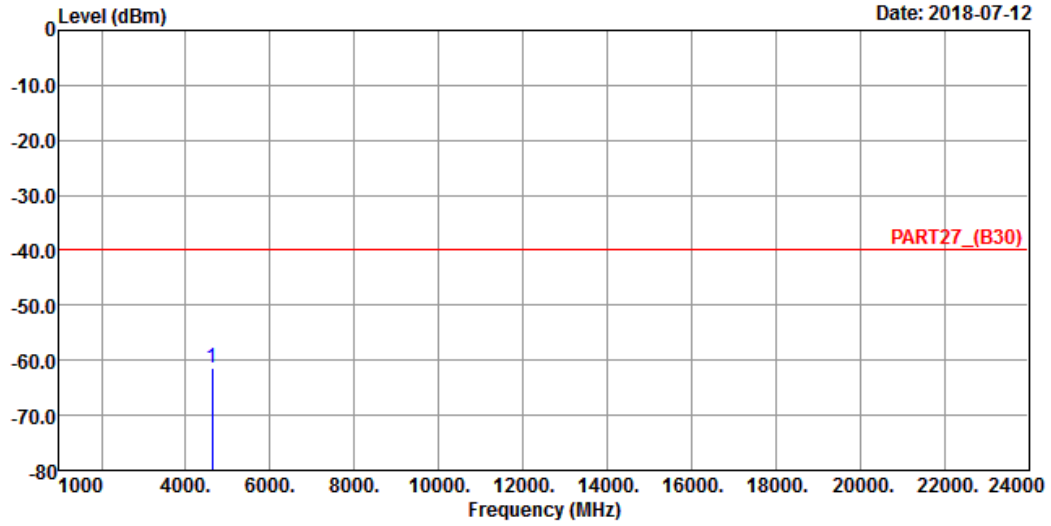

Site : 966 Chamber 5  
 Condition: PART27\_(B30) VERTICAL  
 Remak : LTE Band 30 QPSK\_5M\_M-CH Link  
 Tested by: Jisyong Wang

| Freq         | Level  | Read Level | Limit Line | Over Limit | Factor | Remark |
|--------------|--------|------------|------------|------------|--------|--------|
| MHz          | dBm    | dBm        | dBm        | dB         | dB     |        |
| 1 pp 4620.00 | -61.36 | -57.68     | -40.00     | -21.36     | -3.68  | Peak   |

# High Channel



Bureau Veritas Consumer Products Services Ltd., Taoyuan Branch

A D T

Data: 3

Date: 2018-07-12

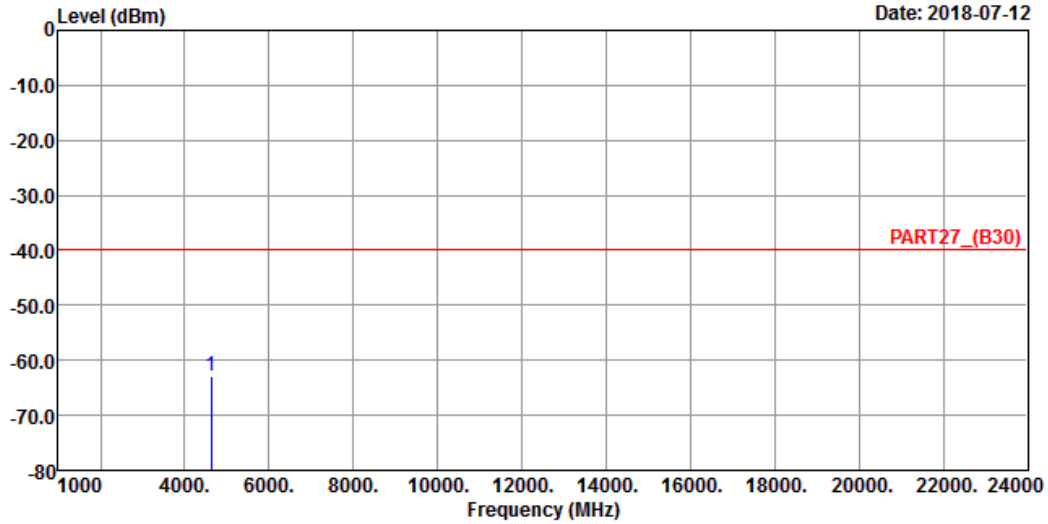

Site : 966 Chamber 5  
 Condition: PART27\_(B30) HORIZONTAL  
 Remak : LTE Band 30 QPSK\_5M\_H-CH Link  
 Tested by: Jisyong Wang

| Freq | Level | Read Level | Limit | Over | Factor | Remark |
|------|-------|------------|-------|------|--------|--------|
| MHz  | dBm   | dBm        | dBm   | dB   | dB     |        |

1 pp 4625.00 -62.85 -59.17 -40.00 -22.85 -3.68 Peak



A D T

Data: 4

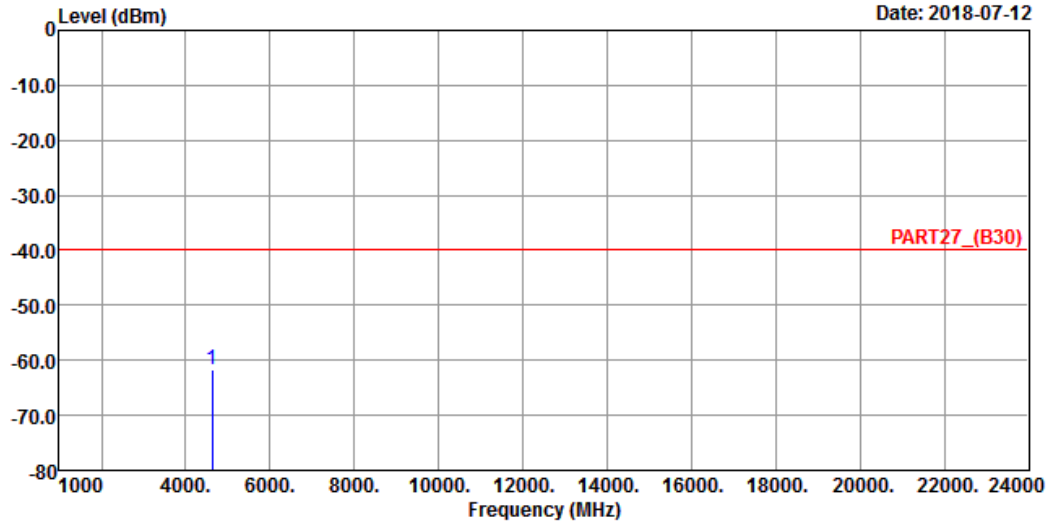

Site : 966 Chamber 5  
 Condition: PART27\_(B30) VERTICAL  
 Remak : LTE Band 30 QPSK\_5M\_H-CH Link  
 Tested by: Jisyong Wang

| Freq         | Level  | Read Level | Limit Line | Over Limit | Factor | Remark |
|--------------|--------|------------|------------|------------|--------|--------|
| MHz          | dBm    | dBm        | dBm        | dB         | dB     |        |
| 1 pp 4625.00 | -61.63 | -57.95     | -40.00     | -21.63     | -3.68  | Peak   |

Channel Bandwidth: 10 MHz / QPSK  
Middle Channel



Bureau Veritas Consumer Products Services Ltd., Taoyuan Branch

A D T

Data: 5

Date: 2018-07-12

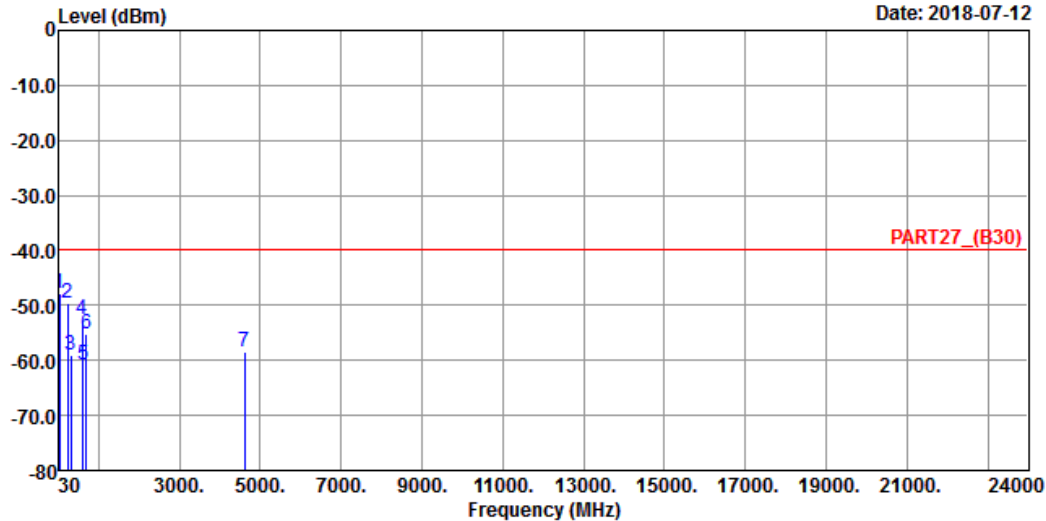

Site : 966 Chamber 5  
Condition: PART27\_(B30) HORIZONTAL  
Remak : LTE Band 30 QPSK\_10M\_M-CH Link  
Tested by: Jisyong Wang

|      | Freq    | Level  | Read Level | Limit Line | Over Limit | Factor | Remark |
|------|---------|--------|------------|------------|------------|--------|--------|
|      | MHz     | dBm    | dBm        | dBm        | dB         | dB     |        |
| 1 pp | 44.55   | -47.71 | -45.72     | -40.00     | -7.71      | -1.99  | Peak   |
| 2    | 234.67  | -49.64 | -43.02     | -40.00     | -9.64      | -6.62  | Peak   |
| 3    | 312.27  | -59.06 | -52.24     | -40.00     | -19.06     | -6.82  | Peak   |
| 4    | 598.42  | -52.44 | -51.61     | -40.00     | -12.44     | -0.83  | Peak   |
| 5    | 624.61  | -60.78 | -59.96     | -40.00     | -20.78     | -0.82  | Peak   |
| 6    | 702.21  | -55.16 | -55.10     | -40.00     | -15.16     | -0.06  | Peak   |
| 7    | 4620.00 | -58.52 | -54.84     | -40.00     | -18.52     | -3.68  | Peak   |





Bureau Veritas Consumer Products Services Ltd., Taoyuan Branch

A D T

Data: 6

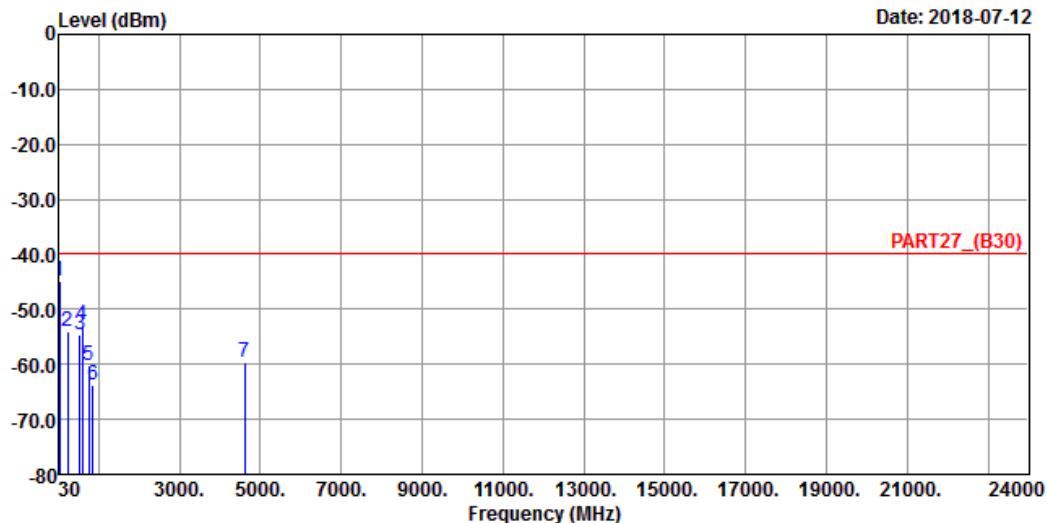

Site : 966 Chamber 5  
 Condition: PART27\_(B30) VERTICAL  
 Remak : LTE Band 30 QPSK\_10M\_M-CH Link  
 Tested by: Jisyong Wang

|      | Read    | Limit  | Over   |        |        |        |      |
|------|---------|--------|--------|--------|--------|--------|------|
| Freq | Level   | Level  | Line   | Limit  | Factor | Remark |      |
| MHz  | dBm     | dBm    | dBm    | dB     | dB     |        |      |
| 1 pp | 39.70   | -44.78 | -45.42 | -40.00 | -4.78  | 0.64   | Peak |
| 2    | 234.67  | -53.97 | -47.35 | -40.00 | -13.97 | -6.62  | Peak |
| 3    | 546.04  | -54.64 | -51.65 | -40.00 | -14.64 | -2.99  | Peak |
| 4    | 598.42  | -52.91 | -52.08 | -40.00 | -12.91 | -0.83  | Peak |
| 5    | 754.59  | -60.18 | -61.05 | -40.00 | -20.18 | 0.87   | Peak |
| 6    | 858.38  | -63.77 | -64.11 | -40.00 | -23.77 | 0.34   | Peak |
| 7    | 4620.00 | -59.52 | -55.84 | -40.00 | -19.52 | -3.68  | Peak |

## 5 Pictures of Test Arrangements

Please refer to the attached file (Test Setup Photo).

## Appendix – Information on the Testing Laboratories

We, Bureau Veritas Consumer Products Services (H.K.) Ltd., Taoyuan Branch, were founded in 1988 to provide our best service in EMC, Radio, Telecom and Safety consultation. Our laboratories are FCC recognized accredited test firms and accredited according to ISO/IEC 17025.

If you have any comments, please feel free to contact us at the following:

**Linko EMC/RF Lab**

Tel: 886-2-26052180

Fax: 886-2-26051924

**Hsin Chu EMC/RF/Telecom Lab**

Tel: 886-3-6668565

Fax: 886-3-6668323

**Hwa Ya EMC/RF/Safety**

Tel: 886-3-3183232

Fax: 886-3-3270892

**Email:** [service.adt@tw.bureauveritas.com](mailto:service.adt@tw.bureauveritas.com)

**Web Site:** [www.bureauveritas-adt.com](http://www.bureauveritas-adt.com)

The address and road map of all our labs can be found in our web site also.

--- END ---