



FCC SAR TEST REPORT

FCC ID : B94-AX200D2LP
Equipment : Notebook Computer
Brand Name : HP
Model Name : HSN-I29C
Applicant : HP Inc.
3390 East Harmony Road, Fort Collins, Colorado 80528,
United States
Standard : FCC 47 CFR Part 2 (2.1093)
ANSI/IEEE C95.1-1992
IEEE 1528-2013

The product was installed into Notebook Computer (Brand Name HP, Model Name: HSN-I29C) during test.

The product was received on Mar. 22, 2019 and testing was started from Apr. 16, 2019 and completed on Apr. 19, 2015. We, SPORTON INTERNATIONAL INC., would like to declare that the tested sample has been evaluated in accordance with the test procedures and has been in compliance with the applicable technical standards.

The report must not be used by the client to claim product certification, approval, or endorsement by TAF or any agency of government.

The test results in this variant report apply exclusively to the tested model / sample. Without written approval of SPORTON INTERNATIONAL INC. EMC & Wireless Communications Laboratory, the test report shall not be reproduced except in full.



Approved by: Cona Huang / Deputy Manager

SPORTON INTERNATIONAL INC. EMC & Wireless Communications Laboratory
No. 52, Huaya 1st Rd., Guishan Dist., Taoyuan City, Taiwan (R.O.C.)



Table of Contents

1. Statement of Compliance 4

2. Guidance Applied..... 4

3. Equipment Under Test (EUT) Information 5

 3.1 General Information 5

 3.2 Sensor Triggering angle and power verification 6

4. RF Exposure Limits.....10

 4.1 Uncontrolled Environment.....10

 4.2 Controlled Environment.....10

5. Specific Absorption Rate (SAR).....11

 5.1 Introduction11

 5.2 SAR Definition.....11

6. System Description and Setup12

 6.1 E-Field Probe13

 6.2 Data Acquisition Electronics (DAE)13

 6.3 Phantom.....14

 6.4 Device Holder.....15

7. Measurement Procedures16

 7.1 Spatial Peak SAR Evaluation16

 7.2 Power Reference Measurement.....17

 7.3 Area Scan17

 7.4 Zoom Scan.....18

 7.5 Volume Scan Procedures.....18

 7.6 Power Drift Monitoring.....18

8. Test Equipment List19

9. System Verification20

 9.1 Tissue Simulating Liquids.....20

 9.2 Tissue Verification21

 9.3 System Performance Check Results.....22

10. RF Exposure Positions22

 10.1 SAR Testing for Tablet.....22

11. Conducted RF Output Power (Unit: dBm).....23

12. Antenna Location55

13. SAR Test Results58

 13.1 Body SAR59

 13.2 Repeated SAR Measurement60

14. Simultaneous Transmission Analysis61

 14.1 Body Exposure Conditions61

 14.2 SPLSR Evaluation and Analysis.....62

15. Uncertainty Assessment63

16. References63

Appendix A. Plots of System Performance Check

Appendix B. Plots of High SAR Measurement

Appendix C. DASYS Calibration Certificate

Appendix D. Test Setup Photos



1. Statement of Compliance

The maximum results of Specific Absorption Rate (SAR) found during testing for HP Inc., Notebook Computer, HSN-I29C, are as follows.

Equipment Class	Frequency Band	Highest SAR Summary	
		Body	Highest Simultaneous Transmission 1g SAR (W/kg)
		1g SAR (W/kg)	
DTS	2.4GHz WLAN	0.75	1.44
NII	5GHz WLAN	1.16	1.16
DSS	Bluetooth	0.08	1.01
Date of Testing:		2019/4/16 ~ 2019/4/19	

Sporton Lab is accredited to ISO 17025 by Taiwan Accreditation Foundation (TAF code: 1190) and the FCC designation No. TW1190 under the FCC 2.948(e) by Mutual Recognition Agreement (MRA) in FCC test. This device is in compliance with Specific Absorption Rate (SAR) for general population/uncontrolled exposure limits (1.6 W/kg) specified in FCC 47 CFR part 2 (2.1093) and ANSI/IEEE C95.1-1992, and had been tested in accordance with the measurement methods and procedures specified in IEEE 1528-2013 and FCC KDB publications.

Reviewed by: Jason Wang
Report Producer: Daisy Peng

2. Guidance Applied

The Specific Absorption Rate (SAR) testing specification, method, and procedure for this device is in accordance with the following standards:

- FCC 47 CFR Part 2 (2.1093)
- ANSI/IEEE C95.1-1992
- IEEE 1528-2013
- FCC KDB 865664 D01 SAR Measurement 100 MHz to 6 GHz v01r04
- FCC KDB 865664 D02 SAR Reporting v01r02
- FCC KDB 447498 D01 General RF Exposure Guidance v06
- FCC KDB 248227 D01 802.11 Wi-Fi SAR v02r02
- FCC KDB 616217 D04 SAR for laptop and tablets v01r02



3. Equipment Under Test (EUT) Information

3.1 General Information

Product Feature & Specification	
Equipment Name	Notebook Computer
Brand Name	HP
Model Name	HSN-I29C
FCC ID	B94-AX200D2LP
Wireless Technology and Frequency Range	WLAN 2.4GHz Band: 2412 MHz ~ 2472 MHz WLAN 5.2GHz Band: 5180 MHz ~ 5240 MHz WLAN 5.3GHz Band: 5260 MHz ~ 5320 MHz WLAN 5.5GHz Band: 5500 MHz ~ 5720 MHz WLAN 5.8GHz Band: 5745 MHz ~ 5825 MHz Bluetooth: 2402 MHz ~ 2480 MHz NFC: 13.56 MHz
Mode	WLAN 2.4GHz : 802.11b/g/n/ax HT20/HT40/HE20/HE40 WLAN 5GHz : 802.11a/n/ac/ax HT20/HT40/VHT20/VHT40/VHT80/VHT160/HE20/HE40/HE80/HE160 Bluetooth BR/EDR/LE NFC: ASK
Remark:	
1. This device is convertible type notebook PC, and there have Laptop and Tablet two usage way, when end user is used different mode which the device will according current mode to limit different maximum power. 2. Refer to tune-up procedure the channel 12 and 13 powers are low than others channel, measure power and SAR consideration is not necessary.	

Host Information	
Equipment Name	Notebook Computer
Brand Name	HP
Model Name	HSN-I29C
Integrated NFC Module	Brand Name: WNC Model Name: XRAV-1
EUT Stage	Production Unit

Antenna Information(TB Mode)										
WLAN_Pocket Slot										
1 INPAQ ant 1 6036B0240701 (WA-P-LB-02-625)	Ant. Type	PIFA				2 INPAQ ant 2 6036B0240801 (WA-P-LB-02-624)	Ant. Type	PIFA		
	Peak Gain (dBi)									
	2400~2483.5MHz	-1.22	5470~5725MHz	1.01	2400~2483.5MHz		-2.07	5470~5725MHz	2.73	
	5150~5350MHz	0.52	5725~5850MHz	0.67		5150~5350MHz	0.59	5725~5850MHz	2.73	
Antenna Information(NB Mode)										
WLAN_Pocket Slot										
1 INPAQ ant 1 6036B0240701 (WA-P-LB-02-625)	Ant. Type	PIFA				2 INPAQ ant 2 6036B0240801 (WA-P-LB-02-624)	Ant. Type	PIFA		
	Peak Gain (dBi)									
	2400~2483.5MHz	1.49	5470~5725MHz	-0.96	2400~2483.5MHz		-0.34	5470~5725MHz	2.64	
	5150~5350MHz	0.37	5725~5850MHz	-0.77		5150~5350MHz	0.2	5725~5850MHz	0.07	



3.2 Sensor Triggering angle and power verification

General Note:

1. This device is convertible type notebook PC, and there have Laptop and Tablet two usage way, when end user is used different mode which the device will according current mode to limit different maximum power and the power verification in different usage mode was following below step:

For Lid close mode change to Tablet mode

Step 1: The device is in lid close mode, and then opens the screen rotate in 3 degree step until change to Laptop mode

Step 2: then the screen rotate back by at least 5 until the power is returned to lid close power table

Step 3: Again rotate the screen to laptop mode, but in 1 degree steps rotate the screen to the laptop mode until it is at least 5 mm past the triggering point.

Step 3: then move in 3 degree step until change to tablet power level (Reduce Power mode)

Step 4: the same procedure step 1 to Step 3 is used for Laptop mode until change to Tablet mode

Step 5: When Lid angle converting different configure there has +/- 5 degree tolerance.

The procedures will accord step1 to step4 to verify the operation of the triggering mechanism whether it is within this tolerance range.

For Tablet mode until change to Lid close mode

The process is then reversed by rotate the screen from tablet mode change to lid close mode according to steps 1) to 4), to check triggering release

when the screen angle is from 0 degree to 360 degree										
Screen angle (degree)	Wireless		WLAN							
	Band		2.4GHz WLAN		5.3GHz WLAN		5.5GHz WLAN		5.8GHz WLAN	
	Ant		Ant 2	Ant 1	Ant 2	Ant 1	Ant 2	Ant 1	Ant 2	Ant 1
	Mode		11b_1Mbps	11b_1Mbps	11ac-VHT80	11ac-VHT80	11ac-VHT80	11ac-VHT80	11ac-VHT80	11ac-VHT80
Non-Notebook	360		17.7	17.9	15.7	16.2	15.8	16.3	15.6	16.2
	350		17.7	17.9	15.7	16.2	15.8	16.3	15.6	16.2
	340		17.7	17.9	15.7	16.2	15.8	16.3	15.6	16.2
	330		17.7	17.9	15.7	16.2	15.8	16.3	15.6	16.2
	320		17.7	17.9	15.7	16.2	15.8	16.3	15.6	16.2
	310		17.7	17.9	15.7	16.2	15.8	16.3	15.6	16.2
	300		17.7	17.9	15.7	16.2	15.8	16.3	15.6	16.2
	290		17.7	17.9	15.7	16.2	15.8	16.3	15.6	16.2
	280		17.7	17.9	15.7	16.2	15.8	16.3	15.6	16.2
	270		17.7	17.9	15.7	16.2	15.8	16.3	15.6	16.2
	260		17.7	17.9	15.7	16.2	15.8	16.3	15.6	16.2
	250		17.7	17.9	15.7	16.2	15.8	16.3	15.6	16.2
	240		17.7	17.9	15.7	16.2	15.8	16.3	15.6	16.2
	230		17.7	17.9	15.7	16.2	15.8	16.3	15.6	16.2
	220		17.7	17.9	15.7	16.2	15.8	16.3	15.6	16.2
	210		17.7	17.9	15.7	16.2	15.8	16.3	15.6	16.2
	200		17.7	17.9	15.7	16.2	15.8	16.3	15.6	16.2
	190		17.7	17.9	15.7	16.2	15.8	16.3	15.6	16.2
	180		17.7	17.9	15.7	16.2	15.8	16.3	15.6	16.2
	170		17.7	17.9	15.7	16.2	15.8	16.3	15.6	16.2
	160		17.7	17.9	15.7	16.2	15.8	16.3	15.6	16.2
	150		17.7	17.9	15.7	16.2	15.8	16.3	15.6	16.2
	140		17.7	17.9	15.7	16.2	15.8	16.3	15.6	16.2
	135		17.7	17.9	15.7	16.2	15.8	16.3	15.6	16.2
	134		17.7	17.9	15.7	16.2	15.8	16.3	15.6	16.2
	133		17.7	17.9	15.7	16.2	15.8	16.3	15.6	16.2
	132		17.7	17.9	15.7	16.2	15.8	16.3	15.6	16.2
	131		17.7	17.9	15.7	16.2	15.8	16.3	15.6	16.2
130		17.7	17.9	15.7	16.2	15.8	16.3	15.6	16.2	
Notebook	129		20.3	20.2	17.2	17.3	20.2	20.2	19.2	18.7
	128		20.3	20.2	17.2	17.3	20.2	20.2	19.2	18.7
	127		20.3	20.2	17.2	17.3	20.2	20.2	19.2	18.7
	126		20.3	20.2	17.2	17.3	20.2	20.2	19.2	18.7
	125		20.3	20.2	17.2	17.3	20.2	20.2	19.2	18.7
	120		20.3	20.2	17.2	17.3	20.2	20.2	19.2	18.7
110		20.3	20.2	17.2	17.3	20.2	20.2	19.2	18.7	



FCC SAR TEST REPORT

Report No. : FA912412-07

	Lid Close	100	20.3	20.2	17.2	17.3	20.2	20.2	19.2	18.7
		90	20.3	20.2	17.2	17.3	20.2	20.2	19.2	18.7
		80	20.3	20.2	17.2	17.3	20.2	20.2	19.2	18.7
		70	20.3	20.2	17.2	17.3	20.2	20.2	19.2	18.7
		60	20.3	20.2	17.2	17.3	20.2	20.2	19.2	18.7
		50	20.3	20.2	17.2	17.3	20.2	20.2	19.2	18.7
		40	20.3	20.2	17.2	17.3	20.2	20.2	19.2	18.7
		39	20.3	20.2	17.2	17.3	20.2	20.2	19.2	18.7
		38	20.3	20.2	17.2	17.3	20.2	20.2	19.2	18.7
		37	20.3	20.2	17.2	17.3	20.2	20.2	19.2	18.7
		36	20.3	20.2	17.2	17.3	20.2	20.2	19.2	18.7
		35	20.3	20.2	17.2	17.3	20.2	20.2	19.2	18.7
		34	NA	NA	NA	NA	NA	NA	NA	NA
		33	NA	NA	NA	NA	NA	NA	NA	NA
		32	NA	NA	NA	NA	NA	NA	NA	NA
	31	NA	NA	NA	NA	NA	NA	NA	NA	
	30	NA	NA	NA	NA	NA	NA	NA	NA	
	20	NA	NA	NA	NA	NA	NA	NA	NA	
	10	NA	NA	NA	NA	NA	NA	NA	NA	
	0	NA	NA	NA	NA	NA	NA	NA	NA	
	Stand (Screen orientation =0)	349	17.7	17.9	15.7	16.2	15.8	16.3	15.6	16.2
		348	17.7	17.9	15.7	16.2	15.8	16.3	15.6	16.2
		347	17.7	17.9	15.7	16.2	15.8	16.3	15.6	16.2
		346	17.7	17.9	15.7	16.2	15.8	16.3	15.6	16.2
		345	17.7	17.9	15.7	16.2	15.8	16.3	15.6	16.2
		344	20.3	20.2	17.2	17.3	20.2	20.2	19.2	18.7
		343	20.3	20.2	17.2	17.3	20.2	20.2	19.2	18.7
		342	20.3	20.2	17.2	17.3	20.2	20.2	19.2	18.7
		341	20.3	20.2	17.2	17.3	20.2	20.2	19.2	18.7
		340	20.3	20.2	17.2	17.3	20.2	20.2	19.2	18.7
		330	20.3	20.2	17.2	17.3	20.2	20.2	19.2	18.7
		320	20.3	20.2	17.2	17.3	20.2	20.2	19.2	18.7
		310	20.3	20.2	17.2	17.3	20.2	20.2	19.2	18.7
		300	20.3	20.2	17.2	17.3	20.2	20.2	19.2	18.7
		290	20.3	20.2	17.2	17.3	20.2	20.2	19.2	18.7
		280	20.3	20.2	17.2	17.3	20.2	20.2	19.2	18.7
		270	20.3	20.2	17.2	17.3	20.2	20.2	19.2	18.7
		260	20.3	20.2	17.2	17.3	20.2	20.2	19.2	18.7
		250	20.3	20.2	17.2	17.3	20.2	20.2	19.2	18.7
		240	20.3	20.2	17.2	17.3	20.2	20.2	19.2	18.7
		230	20.3	20.2	17.2	17.3	20.2	20.2	19.2	18.7
		220	20.3	20.2	17.2	17.3	20.2	20.2	19.2	18.7
		210	20.3	20.2	17.2	17.3	20.2	20.2	19.2	18.7
		204	20.3	20.2	17.2	17.3	20.2	20.2	19.2	18.7
		203	20.3	20.2	17.2	17.3	20.2	20.2	19.2	18.7
202		20.3	20.2	17.2	17.3	20.2	20.2	19.2	18.7	
201		20.3	20.2	17.2	17.3	20.2	20.2	19.2	18.7	
200		20.3	20.2	17.2	17.3	20.2	20.2	19.2	18.7	
199	17.7	17.9	15.7	16.2	15.8	16.3	15.6	16.2		
198	17.7	17.9	15.7	16.2	15.8	16.3	15.6	16.2		
197	17.7	17.9	15.7	16.2	15.8	16.3	15.6	16.2		
196	17.7	17.9	15.7	16.2	15.8	16.3	15.6	16.2		
195	17.7	17.9	15.7	16.2	15.8	16.3	15.6	16.2		



when the screen angle is from 0 degree to 360 degree										
Screen angle (degree)	Wireless		WLAN							
	Band		2.4GHz WLAN		5.3GHz WLAN		5.5GHz WLAN		5.8GHz WLAN	
	Ant		Ant 2	Ant 1	Ant 2	Ant 1	Ant 2	Ant 1	Ant 2	Ant 1
	Mode		11b_1Mbps	11b_1Mbps	11ac-VHT80	11ac-VHT80	11ac-VHT80	11ac-VHT80	11ac-VHT80	11ac-VHT80
Lid Close	0		NA	NA	NA	NA	NA	NA	NA	NA
	10		NA	NA	NA	NA	NA	NA	NA	NA
	20		NA	NA	NA	NA	NA	NA	NA	NA
	30		NA	NA	NA	NA	NA	NA	NA	NA
	31		NA	NA	NA	NA	NA	NA	NA	NA
	32		NA	NA	NA	NA	NA	NA	NA	NA
	33		NA	NA	NA	NA	NA	NA	NA	NA
Notebook	34		NA	NA	NA	NA	NA	NA	NA	NA
	35		20.3	20.2	17.2	17.3	20.2	20.2	19.2	18.7
	36		20.3	20.2	17.2	17.3	20.2	20.2	19.2	18.7
	37		20.3	20.2	17.2	17.3	20.2	20.2	19.2	18.7
	38		20.3	20.2	17.2	17.3	20.2	20.2	19.2	18.7
	39		20.3	20.2	17.2	17.3	20.2	20.2	19.2	18.7
	40		20.3	20.2	17.2	17.3	20.2	20.2	19.2	18.7
	50		20.3	20.2	17.2	17.3	20.2	20.2	19.2	18.7
	60		20.3	20.2	17.2	17.3	20.2	20.2	19.2	18.7
	70		20.3	20.2	17.2	17.3	20.2	20.2	19.2	18.7
	80		20.3	20.2	17.2	17.3	20.2	20.2	19.2	18.7
	90		20.3	20.2	17.2	17.3	20.2	20.2	19.2	18.7
	100		20.3	20.2	17.2	17.3	20.2	20.2	19.2	18.7
	110		20.3	20.2	17.2	17.3	20.2	20.2	19.2	18.7
	120		20.3	20.2	17.2	17.3	20.2	20.2	19.2	18.7
	125		20.3	20.2	17.2	17.3	20.2	20.2	19.2	18.7
	Non-notebook	126		20.3	20.2	17.2	17.3	20.2	20.2	19.2
127			20.3	20.2	17.2	17.3	20.2	20.2	19.2	18.7
128			20.3	20.2	17.2	17.3	20.2	20.2	19.2	18.7
129			20.3	20.2	17.2	17.3	20.2	20.2	19.2	18.7
130			17.7	17.9	15.7	16.2	15.8	16.3	15.6	16.2
131			17.7	17.9	15.7	16.2	15.8	16.3	15.6	16.2
132			17.7	17.9	15.7	16.2	15.8	16.3	15.6	16.2
133			17.7	17.9	15.7	16.2	15.8	16.3	15.6	16.2
134			17.7	17.9	15.7	16.2	15.8	16.3	15.6	16.2
135			17.7	17.9	15.7	16.2	15.8	16.3	15.6	16.2
140			17.7	17.9	15.7	16.2	15.8	16.3	15.6	16.2
150			17.7	17.9	15.7	16.2	15.8	16.3	15.6	16.2
160			17.7	17.9	15.7	16.2	15.8	16.3	15.6	16.2
170			17.7	17.9	15.7	16.2	15.8	16.3	15.6	16.2
180			17.7	17.9	15.7	16.2	15.8	16.3	15.6	16.2
190			17.7	17.9	15.7	16.2	15.8	16.3	15.6	16.2
200			17.7	17.9	15.7	16.2	15.8	16.3	15.6	16.2
210			17.7	17.9	15.7	16.2	15.8	16.3	15.6	16.2
220			17.7	17.9	15.7	16.2	15.8	16.3	15.6	16.2
230			17.7	17.9	15.7	16.2	15.8	16.3	15.6	16.2
240		17.7	17.9	15.7	16.2	15.8	16.3	15.6	16.2	
250		17.7	17.9	15.7	16.2	15.8	16.3	15.6	16.2	
260		17.7	17.9	15.7	16.2	15.8	16.3	15.6	16.2	
270		17.7	17.9	15.7	16.2	15.8	16.3	15.6	16.2	
280		17.7	17.9	15.7	16.2	15.8	16.3	15.6	16.2	
290		17.7	17.9	15.7	16.2	15.8	16.3	15.6	16.2	
300		17.7	17.9	15.7	16.2	15.8	16.3	15.6	16.2	
310		17.7	17.9	15.7	16.2	15.8	16.3	15.6	16.2	
320		17.7	17.9	15.7	16.2	15.8	16.3	15.6	16.2	
330		17.7	17.9	15.7	16.2	15.8	16.3	15.6	16.2	
340		17.7	17.9	15.7	16.2	15.8	16.3	15.6	16.2	
350		17.7	17.9	15.7	16.2	15.8	16.3	15.6	16.2	
360		17.7	17.9	15.7	16.2	15.8	16.3	15.6	16.2	
Stand (Screen)	195		17.7	17.9	15.7	16.2	15.8	16.3	15.6	16.2
	196		17.7	17.9	15.7	16.2	15.8	16.3	15.6	16.2



FCC SAR TEST REPORT

Report No. : FA912412-07

orientation =0)	197	17.7	17.9	15.7	16.2	15.8	16.3	15.6	16.2
	198	17.7	17.9	15.7	16.2	15.8	16.3	15.6	16.2
	199	17.7	17.9	15.7	16.2	15.8	16.3	15.6	16.2
	200	20.3	20.2	17.2	17.3	20.2	20.2	19.2	18.7
	201	20.3	20.2	17.2	17.3	20.2	20.2	19.2	18.7
	202	20.3	20.2	17.2	17.3	20.2	20.2	19.2	18.7
	203	20.3	20.2	17.2	17.3	20.2	20.2	19.2	18.7
	204	20.3	20.2	17.2	17.3	20.2	20.2	19.2	18.7
	210	20.3	20.2	17.2	17.3	20.2	20.2	19.2	18.7
	220	20.3	20.2	17.2	17.3	20.2	20.2	19.2	18.7
	230	20.3	20.2	17.2	17.3	20.2	20.2	19.2	18.7
	240	20.3	20.2	17.2	17.3	20.2	20.2	19.2	18.7
	250	20.3	20.2	17.2	17.3	20.2	20.2	19.2	18.7
	260	20.3	20.2	17.2	17.3	20.2	20.2	19.2	18.7
	270	20.3	20.2	17.2	17.3	20.2	20.2	19.2	18.7
	280	20.3	20.2	17.2	17.3	20.2	20.2	19.2	18.7
	290	20.3	20.2	17.2	17.3	20.2	20.2	19.2	18.7
	300	20.3	20.2	17.2	17.3	20.2	20.2	19.2	18.7
	310	20.3	20.2	17.2	17.3	20.2	20.2	19.2	18.7
	320	20.3	20.2	17.2	17.3	20.2	20.2	19.2	18.7
	330	20.3	20.2	17.2	17.3	20.2	20.2	19.2	18.7
	340	20.3	20.2	17.2	17.3	20.2	20.2	19.2	18.7
	341	20.3	20.2	17.2	17.3	20.2	20.2	19.2	18.7
	342	20.3	20.2	17.2	17.3	20.2	20.2	19.2	18.7
	343	20.3	20.2	17.2	17.3	20.2	20.2	19.2	18.7
	344	20.3	20.2	17.2	17.3	20.2	20.2	19.2	18.7
	345	17.7	17.9	15.7	16.2	15.8	16.3	15.6	16.2
	346	17.7	17.9	15.7	16.2	15.8	16.3	15.6	16.2
	347	17.7	17.9	15.7	16.2	15.8	16.3	15.6	16.2
	348	17.7	17.9	15.7	16.2	15.8	16.3	15.6	16.2
	349	17.7	17.9	15.7	16.2	15.8	16.3	15.6	16.2



4. RF Exposure Limits

4.1 Uncontrolled Environment

Uncontrolled Environments are defined as locations where there is the exposure of individuals who have no knowledge or control of their exposure. The general population/uncontrolled exposure limits are applicable to situations in which the general public may be exposed or in which persons who are exposed as a consequence of their employment may not be made fully aware of the potential for exposure or cannot exercise control over their exposure. Members of the general public would come under this category when exposure is not employment-related; for example, in the case of a wireless transmitter that exposes persons in its vicinity.

4.2 Controlled Environment

Controlled Environments are defined as locations where there is exposure that may be incurred by persons who are aware of the potential for exposure, (i.e. as a result of employment or occupation). In general, occupational/controlled exposure limits are applicable to situations in which persons are exposed as a consequence of their employment, who have been made fully aware of the potential for exposure and can exercise control over their exposure. The exposure category is also applicable when the exposure is of a transient nature due to incidental passage through a location where the exposure levels may be higher than the general population/uncontrolled limits, but the exposed person is fully aware of the potential for exposure and can exercise control over his or her exposure by leaving the area or by some other appropriate means.

Limits for Occupational/Controlled Exposure (W/kg)

Whole-Body	Partial-Body	Hands, Wrists, Feet and Ankles
0.4	8.0	20.0

Limits for General Population/Uncontrolled Exposure (W/kg)

Whole-Body	Partial-Body	Hands, Wrists, Feet and Ankles
0.08	1.6	4.0

1. Whole-Body SAR is averaged over the entire body, partial-body SAR is averaged over any 1gram of tissue defined as a tissue volume in the shape of a cube. SAR for hands, wrists, feet and ankles is averaged over any 10 grams of tissue defined as a tissue volume in the shape of a cube.



5. Specific Absorption Rate (SAR)

5.1 Introduction

SAR is related to the rate at which energy is absorbed per unit mass in an object exposed to a radio field. The SAR distribution in a biological body is complicated and is usually carried out by experimental techniques or numerical modeling. The standard recommends limits for two tiers of groups, occupational/controlled and general population/uncontrolled, based on a person's awareness and ability to exercise control over his or her exposure. In general, occupational/controlled exposure limits are higher than the limits for general population/uncontrolled.

5.2 SAR Definition

The SAR definition is the time derivative (rate) of the incremental energy (dW) absorbed by (dissipated in) an incremental mass (dm) contained in a volume element (dv) of a given density (ρ). The equation description is as below:

$$SAR = \frac{d}{dt} \left(\frac{dW}{dm} \right) = \frac{d}{dt} \left(\frac{dW}{\rho dv} \right)$$

SAR is expressed in units of Watts per kilogram (W/kg)

$$SAR = \frac{\sigma |E|^2}{\rho}$$

Where: σ is the conductivity of the tissue, ρ is the mass density of the tissue and E is the RMS electrical field strength.

6. System Description and Setup

The DASY system used for performing compliance tests consists of the following items:

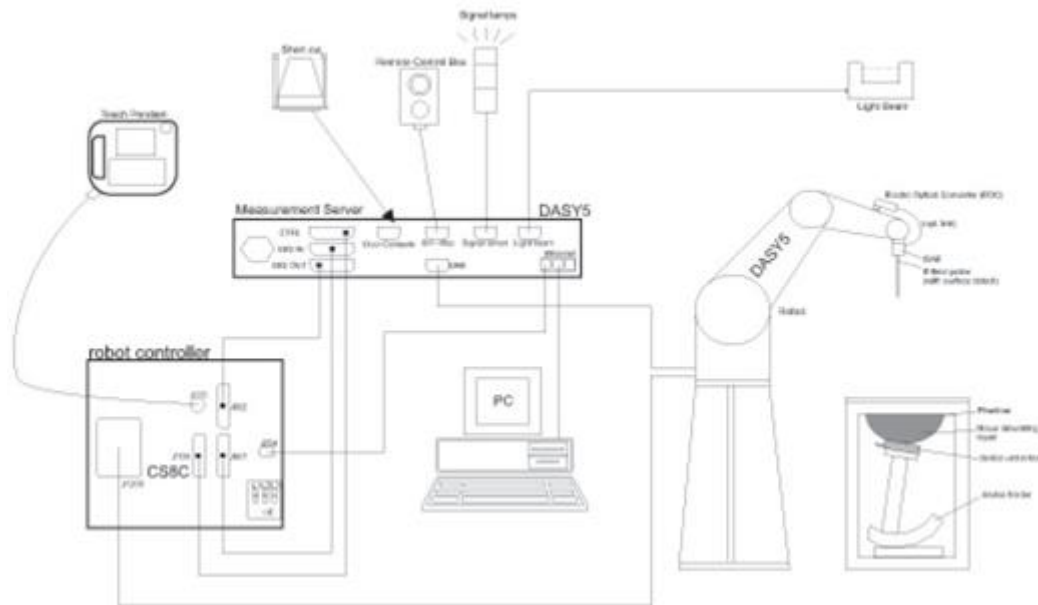

- A standard high precision 6-axis robot with controller, teach pendant and software. An arm extension for accommodating the data acquisition electronics (DAE).
- An isotropic Field probe optimized and calibrated for the targeted measurement.
- A data acquisition electronics (DAE) which performs the signal amplification, signal multiplexing, AD-conversion, offset measurements, mechanical surface detection, collision detection, etc. The unit is battery powered with standard or rechargeable batteries. The signal is optically transmitted to the EOC.
- The Electro-optical converter (EOC) performs the conversion from optical to electrical signals for the digital communication to the DAE. To use optical surface detection, a special version of the EOC is required. The EOC signal is transmitted to the measurement server.
- The function of the measurement server is to perform the time critical tasks such as signal filtering, control of the robot operation and fast movement interrupts.
- The Light Beam used is for probe alignment. This improves the (absolute) accuracy of the probe positioning.
- A computer running WinXP or Win7 and the DASY5 software.
- Remote control and teach pendant as well as additional circuitry for robot safety such as warning lamps, etc.
- The phantom, the device holder and other accessories according to the targeted measurement.

6.1 E-Field Probe

The SAR measurement is conducted with the dosimetric probe (manufactured by SPEAG). The probe is specially designed and calibrated for use in liquid with high permittivity. The dosimetric probe has special calibration in liquid at different frequency. This probe has a built in optical surface detection system to prevent from collision with phantom.

<ES3DV3 Probe>

Construction	Symmetric design with triangular core Interleaved sensors Built-in shielding against static charges PEEK enclosure material (resistant to organic solvents, e.g., DGBE)	
Frequency	10 MHz – 4 GHz; Linearity: ± 0.2 dB (30 MHz – 4 GHz)	
Directivity	± 0.2 dB in TSL (rotation around probe axis) ± 0.3 dB in TSL (rotation normal to probe axis)	
Dynamic Range	5 μ W/g – >100 mW/g; Linearity: ± 0.2 dB	
Dimensions	Overall length: 337 mm (tip: 20 mm) Tip diameter: 3.9 mm (body: 12 mm) Distance from probe tip to dipole centers: 3.0 mm	

<EX3DV4 Probe>

Construction	Symmetric design with triangular core Built-in shielding against static charges PEEK enclosure material (resistant to organic solvents, e.g., DGBE)	
Frequency	10 MHz – >6 GHz Linearity: ± 0.2 dB (30 MHz – 6 GHz)	
Directivity	± 0.3 dB in TSL (rotation around probe axis) ± 0.5 dB in TSL (rotation normal to probe axis)	
Dynamic Range	10 μ W/g – >100 mW/g Linearity: ± 0.2 dB (noise: typically <1 μ W/g)	
Dimensions	Overall length: 337 mm (tip: 20 mm) Tip diameter: 2.5 mm (body: 12 mm) Typical distance from probe tip to dipole centers: 1 mm	

6.2 Data Acquisition Electronics (DAE)

The data acquisition electronics (DAE) consists of a highly sensitive electrometer-grade preamplifier with auto-zeroing, a channel and gain-switching multiplexer, a fast 16 bit AD-converter and a command decoder and control logic unit. Transmission to the measurement server is accomplished through an optical downlink for data and status information as well as an optical uplink for commands and the clock.

The input impedance of the DAE is 200 MOhm; the inputs are symmetrical and floating. Common mode rejection is above 80 dB.



Fig 5.1 Photo of DAE

6.3 Phantom

<SAM Twin Phantom>

Shell Thickness	2 ± 0.2 mm; Center ear point: 6 ± 0.2 mm	
Filling Volume	Approx. 25 liters	
Dimensions	Length: 1000 mm; Width: 500 mm; Height: adjustable feet	
Measurement Areas	Left Hand, Right Hand, Flat Phantom	

The bottom plate contains three pair of bolts for locking the device holder. The device holder positions are adjusted to the standard measurement positions in the three sections. A white cover is provided to tap the phantom during off-periods to prevent water evaporation and changes in the liquid parameters. On the phantom top, three reference markers are provided to identify the phantom position with respect to the robot.

<ELI Phantom>

Shell Thickness	2 ± 0.2 mm (sagging: <1%)	
Filling Volume	Approx. 30 liters	
Dimensions	Major ellipse axis: 600 mm Minor axis: 400 mm	

The ELI phantom is intended for compliance testing of handheld and body-mounted wireless devices in the frequency range of 30 MHz to 6 GHz. ELI4 is fully compatible with standard and all known tissue simulating liquids.

6.4 Device Holder

<Mounting Device for Hand-Held Transmitter>

In combination with the Twin SAM V5.0/V5.0c or ELI phantoms, the Mounting Device for Hand-Held Transmitters enables rotation of the mounted transmitter device to specified spherical coordinates. At the heads, the rotation axis is at the ear opening. Transmitter devices can be easily and accurately positioned according to IEC 62209-1, IEEE 1528, FCC, or other specifications. The device holder can be locked for positioning at different phantom sections (left head, right head, flat). And upgrade kit to Mounting Device to enable easy mounting of wider devices like big smart-phones, e-books, small tablets, etc. It holds devices with width up to 140 mm.



Mounting Device for Hand-Held Transmitters



Mounting Device Adaptor for Wide-Phones

<Mounting Device for Laptops and other Body-Worn Transmitters>

The extension is lightweight and made of POM, acrylic glass and foam. It fits easily on the upper part of the mounting device in place of the phone positioned. The extension is fully compatible with the SAM Twin and ELI phantoms.



Mounting Device for Laptops

7. Measurement Procedures

The measurement procedures are as follows:

<Conducted power measurement>

- (a) For WWAN power measurement, use base station simulator to configure EUT WWAN transmission in conducted connection with RF cable, at maximum power in each supported wireless interface and frequency band.
- (b) Read the WWAN RF power level from the base station simulator.
- (c) For WLAN/BT power measurement, use engineering software to configure EUT WLAN/BT continuously transmission, at maximum RF power in each supported wireless interface and frequency band
- (d) Connect EUT RF port through RF cable to the power meter, and measure WLAN/BT output power

<SAR measurement>

- (a) Use base station simulator to configure EUT WWAN transmission in radiated connection, and engineering software to configure EUT WLAN/BT continuously transmission, at maximum RF power, in the highest power channel.
- (b) Place the EUT in the positions as Appendix D demonstrates.
- (c) Set scan area, grid size and other setting on the DASY software.
- (d) Measure SAR results for the highest power channel on each testing position.
- (e) Find out the largest SAR result on these testing positions of each band
- (f) Measure SAR results for other channels in worst SAR testing position if the reported SAR of highest power channel is larger than 0.8 W/kg

According to the test standard, the recommended procedure for assessing the peak spatial-average SAR value consists of the following steps:

- (a) Power reference measurement
- (b) Area scan
- (c) Zoom scan
- (d) Power drift measurement

7.1 Spatial Peak SAR Evaluation

The procedure for spatial peak SAR evaluation has been implemented according to the test standard. It can be conducted for 1g and 10g, as well as for user-specific masses. The DASY software includes all numerical procedures necessary to evaluate the spatial peak SAR value.

The base for the evaluation is a "cube" measurement. The measured volume must include the 1g and 10g cubes with the highest averaged SAR values. For that purpose, the center of the measured volume is aligned to the interpolated peak SAR value of a previously performed area scan.

The entire evaluation of the spatial peak values is performed within the post-processing engine (SEMCAD). The system always gives the maximum values for the 1g and 10g cubes. The algorithm to find the cube with highest averaged SAR is divided into the following stages:

- (a) Extraction of the measured data (grid and values) from the Zoom Scan
- (b) Calculation of the SAR value at every measurement point based on all stored data (A/D values and measurement parameters)
- (c) Generation of a high-resolution mesh within the measured volume
- (d) Interpolation of all measured values from the measurement grid to the high-resolution grid
- (e) Extrapolation of the entire 3-D field distribution to the phantom surface over the distance from sensor to surface
- (f) Calculation of the averaged SAR within masses of 1g and 10g



7.2 Power Reference Measurement

The Power Reference Measurement and Power Drift Measurements are for monitoring the power drift of the device under test in the batch process. The minimum distance of probe sensors to surface determines the closest measurement point to phantom surface. This distance cannot be smaller than the distance of sensor calibration points to probe tip as defined in the probe properties.

7.3 Area Scan

The area scan is used as a fast scan in two dimensions to find the area of high field values, before doing a fine measurement around the hot spot. The sophisticated interpolation routines implemented in DASY software can find the maximum found in the scanned area, within a range of the global maximum. The range (in dB) is specified in the standards for compliance testing. For example, a 2 dB range is required in IEEE standard 1528 and IEC 62209 standards, whereby 3 dB is a requirement when compliance is assessed in accordance with the ARIB standard (Japan), if only one zoom scan follows the area scan, then only the absolute maximum will be taken as reference. For cases where multiple maximums are detected, the number of zoom scans has to be increased accordingly.

Area scan parameters extracted from FCC KDB 865664 D01v01r04 SAR measurement 100 MHz to 6 GHz.

	≤ 3 GHz	> 3 GHz
Maximum distance from closest measurement point (geometric center of probe sensors) to phantom surface	5 ± 1 mm	$\frac{1}{2} \cdot \delta \cdot \ln(2) \pm 0.5$ mm
Maximum probe angle from probe axis to phantom surface normal at the measurement location	30° ± 1°	20° ± 1°
Maximum area scan spatial resolution: $\Delta x_{Area}, \Delta y_{Area}$	≤ 2 GHz: ≤ 15 mm 2 – 3 GHz: ≤ 12 mm	3 – 4 GHz: ≤ 12 mm 4 – 6 GHz: ≤ 10 mm
	When the x or y dimension of the test device, in the measurement plane orientation, is smaller than the above, the measurement resolution must be ≤ the corresponding x or y dimension of the test device with at least one measurement point on the test device.	

7.4 Zoom Scan

Zoom scans are used assess the peak spatial SAR values within a cubic averaging volume containing 1 gram and 10 gram of simulated tissue. The zoom scan measures points (refer to table below) within a cube shoes base faces are centered on the maxima found in a preceding area scan job within the same procedure. When the measurement is done, the zoom scan evaluates the averaged SAR for 1 gram and 10 gram and displays these values next to the job's label.

Zoom scan parameters extracted from FCC KDB 865664 D01v01r04 SAR measurement 100 MHz to 6 GHz.

		≤ 3 GHz	> 3 GHz	
Maximum zoom scan spatial resolution: $\Delta x_{Zoom}, \Delta y_{Zoom}$		≤ 2 GHz: ≤ 8 mm 2 – 3 GHz: ≤ 5 mm*	3 – 4 GHz: ≤ 5 mm* 4 – 6 GHz: ≤ 4 mm*	
Maximum zoom scan spatial resolution, normal to phantom surface	uniform grid: $\Delta z_{Zoom}(n)$	≤ 5 mm	3 – 4 GHz: ≤ 4 mm 4 – 5 GHz: ≤ 3 mm 5 – 6 GHz: ≤ 2 mm	
	graded grid	$\Delta z_{Zoom}(1)$: between 1 st two points closest to phantom surface	≤ 4 mm	3 – 4 GHz: ≤ 3 mm 4 – 5 GHz: ≤ 2.5 mm 5 – 6 GHz: ≤ 2 mm
		$\Delta z_{Zoom}(n>1)$: between subsequent points	$\leq 1.5 \cdot \Delta z_{Zoom}(n-1)$	
Minimum zoom scan volume	x, y, z	≥ 30 mm	3 – 4 GHz: ≥ 28 mm 4 – 5 GHz: ≥ 25 mm 5 – 6 GHz: ≥ 22 mm	
Note: δ is the penetration depth of a plane-wave at normal incidence to the tissue medium; see draft standard IEEE P1528-2011 for details. * When zoom scan is required and the <i>reported</i> SAR from the <i>area scan based 1-g SAR estimation</i> procedures of KDB 447498 is ≤ 1.4 W/kg, ≤ 8 mm, ≤ 7 mm and ≤ 5 mm zoom scan resolution may be applied, respectively, for 2 GHz to 3 GHz, 3 GHz to 4 GHz and 4 GHz to 6 GHz.				

7.5 Volume Scan Procedures

The volume scan is used for assess overlapping SAR distributions for antennas transmitting in different frequency bands. It is equivalent to an oversized zoom scan used in standalone measurements. The measurement volume will be used to enclose all the simultaneous transmitting antennas. For antennas transmitting simultaneously in different frequency bands, the volume scan is measured separately in each frequency band. In order to sum correctly to compute the 1g aggregate SAR, the EUT remain in the same test position for all measurements and all volume scan use the same spatial resolution and grid spacing. When all volume scan were completed, the software, SEMCAD postprocessor can combine and subsequently superpose these measurement data to calculating the multiband SAR.

7.6 Power Drift Monitoring

All SAR testing is under the EUT install full charged battery and transmit maximum output power. In DASYS measurement software, the power reference measurement and power drift measurement procedures are used for monitoring the power drift of EUT during SAR test. Both these procedures measure the field at a specified reference position before and after the SAR testing. The software will calculate the field difference in dB. If the power drifts more than 5%, the SAR will be retested.



8. Test Equipment List

Manufacturer	Name of Equipment	Type/Model	Serial Number	Calibration	
				Last Cal.	Due Date
SPEAG	2450MHz System Validation Kit	D2450V2	736	Aug. 31, 2018	Aug. 30, 2019
SPEAG	2450MHz System Validation Kit	D2450V2	806	Mar. 14, 2019	Mar. 13, 2020
SPEAG	5GHz System Validation Kit	D5GHzV2	1171	Jul. 19, 2018	Jul. 18, 2019
SPEAG	Data Acquisition Electronics	DAE4	853	Jul. 24, 2018	Jul. 23, 2019
SPEAG	Data Acquisition Electronics	DAE4	1326	Sep. 18, 2018	Sep. 17, 2019
SPEAG	Dosimetric E-Field Probe	ES3DV3	3169	May. 28, 2018	May. 27, 2019
SPEAG	Dosimetric E-Field Probe	EX3DV4	3925	May. 31, 2018	May. 30, 2019
RCPTWN	Thermometer	HTC-1	TM685-1	Nov. 12, 2018	Nov. 11, 2019
RCPTWN	Thermometer	HTC-1	TM560-2	Nov. 12, 2018	Nov. 11, 2019
R&S	BT Base Station	CBT32	100519	May. 30, 2018	May. 29, 2019
SPEAG	Device Holder	N/A	N/A	N/A	N/A
Anritsu	Signal Generator	MG3710A	6201502524	Dec. 11, 2018	Dec. 10, 2019
Agilent	ENA Network Analyzer	E5071C	MY46104758	Sep. 19, 2018	Sep. 18, 2019
SPEAG	Dielectric Probe Kit	DAK-3.5	1126	Sep. 19, 2018	Sep. 18, 2019
LINE SEIKI	Digital Thermometer	DTM3000-spezial	3169	Sep. 11, 2018	Sep. 10, 2019
Anritsu	Power Meter	ML2495A	1419002	May. 18, 2018	May. 17, 2019
Anritsu	Power Sensor	MA2411B	1339124	May. 18, 2018	May. 17, 2019
Anritsu	Power Meter	ML2495A	1240001	Sep. 13, 2018	Sep. 12, 2019
Anritsu	Power Sensor	MA2411B	1207349	Sep. 13, 2018	Sep. 12, 2019
Agilent	Spectrum Analyzer	E4408B	MY44211028	Aug. 28, 2018	Aug. 27, 2019
Anritsu	Spectrum Analyzer	MS2830A	6201396378	Jun. 23, 2018	Jun. 22, 2019
Mini-Circuits	Power Amplifier	ZVE-8G+	070501814	Oct. 08, 2018	Oct. 07, 2019
Mini-Circuits	Power Amplifier	ZVE-8G+	6382	Aug. 09, 2018	Aug. 08, 2019
ATM	Dual Directional Coupler	C122H-10	P610410z-02	Note 1	
Woken	Attenuator 1	WK0602-XX	N/A	Note 1	
PE	Attenuator 2	PE7005-10	N/A	Note 1	
PE	Attenuator 3	PE7005-3	N/A	Note 1	

General Note:

1. Prior to system verification and validation, the path loss from the signal generator to the system check source and the power meter, which includes the amplifier, cable, attenuator and directional coupler, was measured by the network analyzer. The reading of the power meter was offset by the path loss difference between the path to the power meter and the path to the system check source to monitor the actual power level fed to the system check source.

9. System Verification

9.1 Tissue Simulating Liquids

For the measurement of the field distribution inside the SAM phantom with DASY, the phantom must be filled with around 25 liters of homogeneous body tissue simulating liquid. For head SAR testing, the liquid height from the ear reference point (ERP) of the phantom to the liquid top surface is larger than 15 cm, which is shown in Fig. 10.1. For body SAR testing, the liquid height from the center of the flat phantom to the liquid top surface is larger than 15 cm, which is shown in Fig. 10.2.

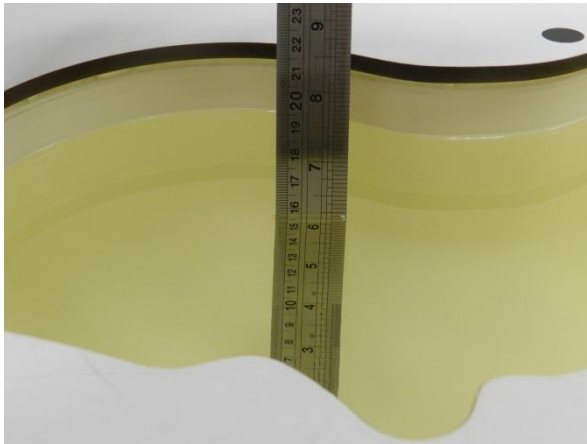

Fig 10.1 Photo of Liquid Height for Head SAR

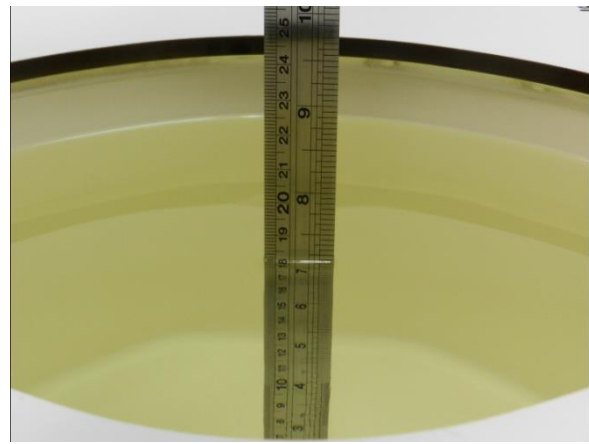

Fig 10.2 Photo of Liquid Height for Body SAR

9.2 Tissue Verification

The following tissue formulations are provided for reference only as some of the parameters have not been thoroughly verified. The composition of ingredients may be modified accordingly to achieve the desired target tissue parameters required for routine SAR evaluation.

Frequency (MHz)	Water (%)	Sugar (%)	Cellulose (%)	Salt (%)	Preventol (%)	DGBE (%)	Conductivity (σ)	Permittivity (ϵ_r)
For Head								
750	41.1	57.0	0.2	1.4	0.2	0	0.89	41.9
835	40.3	57.9	0.2	1.4	0.2	0	0.90	41.5
900	40.3	57.9	0.2	1.4	0.2	0	0.97	41.5
1800, 1900, 2000	55.2	0	0	0.3	0	44.5	1.40	40.0
2450	55.0	0	0	0	0	45.0	1.80	39.2
2600	54.8	0	0	0.1	0	45.1	1.96	39.0
For Body								
750	51.7	47.2	0	0.9	0.1	0	0.96	55.5
835	50.8	48.2	0	0.9	0.1	0	0.97	55.2
900	50.8	48.2	0	0.9	0.1	0	1.05	55.0
1800, 1900, 2000	70.2	0	0	0.4	0	29.4	1.52	53.3
2450	68.6	0	0	0	0	31.4	1.95	52.7
2600	68.1	0	0	0.1	0	31.8	2.16	52.5

Simulating Liquid for 5GHz, Manufactured by SPEAG

Ingredients	(% by weight)
Water	64~78%
Mineral oil	11~18%
Emulsifiers	9~15%
Additives and Salt	2~3%

<Tissue Dielectric Parameter Check Results>

Frequency (MHz)	Tissue Type	Liquid Temp. (°C)	Conductivity (σ)	Permittivity (ϵ_r)	Conductivity Target (σ)	Permittivity Target (ϵ_r)	Delta (σ) (%)	Delta (ϵ_r) (%)	Limit (%)	Date
2450	MSL	22.3	1.993	51.934	1.95	52.70	2.21	-1.45	±5	2019/4/18
2450	MSL	22.5	1.970	52.856	1.95	52.70	1.03	0.30	±5	2019/4/19
5250	MSL	22.3	5.124	49.473	5.36	48.95	-4.40	1.07	±5	2019/4/16
5600	MSL	22.3	5.587	48.934	5.77	48.50	-3.17	0.89	±5	2019/4/16
5750	MSL	22.3	5.793	48.703	5.94	48.28	-2.47	0.88	±5	2019/4/16

9.3 System Performance Check Results

Comparing to the original SAR value provided by SPEAG, the verification data should be within its specification of 10 %. Below table shows the target SAR and measured SAR after normalized to 1W input power. The table below indicates the system performance check can meet the variation criterion and the plots can be referred to Appendix A of this report.

Date	Frequency (MHz)	Tissue Type	Input Power (mW)	Dipole S/N	Probe S/N	DAE S/N	Measured 1g SAR (W/kg)	Targeted 1g SAR (W/kg)	Normalized 1g SAR (W/kg)	Deviation (%)
2019/4/18	2450	MSL	250	D2450V2_806	EX3DV4 - SN3925	DAE4 Sn853	12.70	50.40	50.8	0.79
2019/4/19	2450	MSL	250	D2450V2-736	ES3DV3 - SN3169	DAE4 Sn1326	12.80	51.50	51.2	-0.58
2019/4/16	5250	MSL	100	D5GHzV2-1171-5250	EX3DV4 - SN3925	DAE4 Sn853	7.61	75.10	76.1	1.33
2019/4/16	5600	MSL	100	D5GHzV2-1171-5600	EX3DV4 - SN3925	DAE4 Sn853	7.70	78.50	77	-1.91
2019/4/16	5750	MSL	100	D5GHzV2-1171-5750	EX3DV4 - SN3925	DAE4 Sn853	7.62	74.40	76.2	2.42

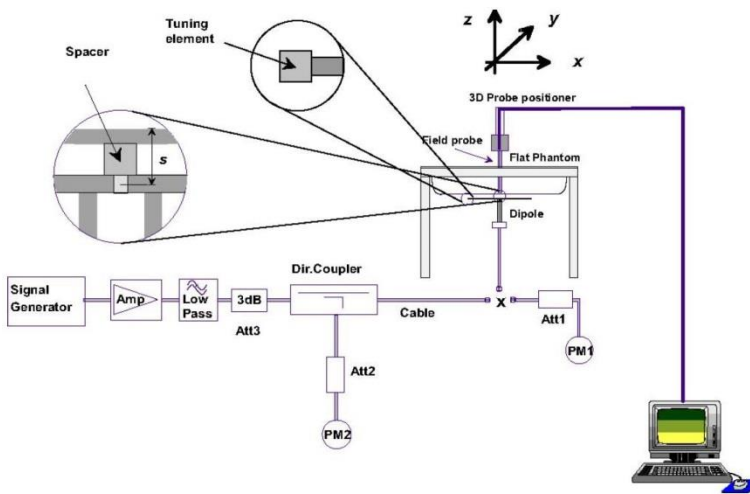

Fig 8.3.1 System Performance Check Setup



Fig 8.3.2 Setup Photo

10. RF Exposure Positions

10.1 SAR Testing for Tablet

This device can be used also in full sized tablet exposure conditions, due to its size. Per FCC KDB 616217, the back surface and edges of the tablet should be tested for SAR compliance with the tablet touching the phantom. The SAR exclusion threshold in KDB 447498 D01v06 can be applied to determine SAR test exclusion for adjacent edge configurations. The closest distance from the antenna to an adjacent tablet edge is used to determine if SAR testing is required for the adjacent edges, with the adjacent edge positioned against the phantom and the edge containing the antenna positioned perpendicular to the phantom.



11. Conducted RF Output Power (Unit: dBm)

<WLAN Conducted Power>

General Note:

1. For each antenna, transmit power in SISO operation is larger than (or equal to) the power in MIMO operation, RF exposure compliance of MIMO mode can be deduced from the compliance simultaneous transmission of antennas operating in SISO mode.
2. Per KDB 248227 D01v02r02, the simultaneous SAR provisions in KDB publication 447498 should be applied to determine simultaneous transmission SAR test exclusion for WiFi MIMO. If the sum of 1g single transmission chain SAR measurements is $< 1.6\text{W/kg}$ and SAR peak to location ratio ≤ 0.04 , no additional SAR measurements for MIMO.
3. Per KDB 248227 D01v02r02, SAR test reduction is determined according to 802.11 transmission mode configurations and certain exposure conditions with multiple test positions. In the 2.4 GHz band, separate SAR procedures are applied to DSSS and OFDM configurations to simplify DSSS test requirements. For OFDM, in both 2.4 and 5 GHz bands, an initial test configuration must be determined for each standalone and aggregated frequency band, according to the transmission mode configuration with the highest maximum output power specified for production units to perform SAR measurements. If the same highest maximum output power applies to different combinations of channel bandwidths, modulations and data rates, additional procedures are applied to determine which test configurations require SAR measurement. When applicable, an initial test position may be applied to reduce the number of SAR measurements required for next to the ear, UMPC mini-tablet or hotspot mode configurations with multiple test positions.
4. For 2.4 GHz 802.11b DSSS, either the initial test position procedure for multiple exposure test positions or the DSSS procedure for fixed exposure position is applied; these are mutually exclusive. For 2.4 GHz and 5 GHz OFDM configurations, the initial test configuration is applied to measure SAR using either the initial test position procedure for multiple exposure test position configurations or the initial test configuration procedures for fixed exposure test conditions. Based on the reported SAR of the measured configurations and maximum output power of the transmission mode configurations that are not included in the initial test configuration, the subsequent test configuration and initial test position procedures are applied to determine if SAR measurements are required for the remaining OFDM transmission configurations. In general, the number of test channels that require SAR measurement is minimized based on maximum output power measured for the test sample(s).
5. For OFDM transmission configurations in the 2.4 GHz and 5 GHz bands, When the same maximum power is specified for multiple transmission modes in a frequency band, the largest channel bandwidth, lowest order modulation, lowest data rate and lowest order 802.11a/g/n/ac mode is used for SAR measurement, on the highest measured output power channel for each frequency band.
6. DSSS and OFDM configurations are considered separately according to the required SAR procedures. SAR is measured in the initial test position using the 802.11 transmission mode configuration required by the DSSS procedure or initial test configuration and subsequent test configuration(s) according to the OFDM procedures. 18 The initial test position procedure is described in the following:
 - a. When the reported SAR of the initial test position is $\leq 0.4\text{ W/kg}$, further SAR measurement is not required for the other test positions in that exposure configuration and 802.11 transmission mode combinations within the frequency band or aggregated band.
 - b. When the reported SAR of the test position is $> 0.4\text{ W/kg}$, SAR is repeated for the 802.11 transmission mode configuration tested in the initial test position to measure the subsequent next closet/smallest test separation distance and maximum coupling test position on the highest maximum output power channel, until the report SAR is $\leq 0.8\text{ W/kg}$ or all required test position are tested.
 - c. For all positions/configurations, when the reported SAR is $> 0.8\text{ W/kg}$, SAR is measured for these test positions/configurations on the subsequent next highest measured output power channel(s) until the reported SAR is $\leq 1.2\text{ W/kg}$ or all required channels are tested.
7. Per 201904 TCBC workshops, General principles of FCC KDB Publication 248227 D01 can be applied to determine the SAR Initial Test Configurations and test reduction for 802.11ax SAR testing. For the table below the 802.11ax maximum power is SU (non-OFDMA), and the SU maximum power also higher than RU (OFDMA)
8. In applying the test guidance, the IEEE 802.11 mode with the maximum output power (out of all modes) should be considered for testing
9. For modes with the same maximum output power, the guidance from section 5.3.2 a) of FCC KDB Publication 248227 D01 should be applied, with 802.11ax being considered as the highest 802.11 mode for the appropriate frequency bands
10. When SAR testing for 802.11ax is required
 - a. If the maximum output power is highest for OFDMA scenarios, choose the tone size with the maximum number of tones and the highest maximum output power
 - b. Otherwise, consider the fully allocated channel for SAR testing
 - c. When SAR testing is required on RU sizes less than the fully allocated channel, use the RU number closest to the middle of the channel, choosing the higher RU number when two RUs are equidistant to the middle of the channel



<For Tablet Mode>

<2.4GHz WLAN ANT 2>

	Mode	Channel	Frequency (MHz)	Average power (dBm)	Tune-Up Limit	Duty Cycle %
2.4GHz WLAN	802.11b 1Mbps	1	2412	17.70	18.00	99.11
		6	2437	17.70	18.00	
		11	2462	17.70	18.00	
		12	2467	16.20	16.50	
		13	2472	15.20	15.25	
	802.11g 6Mbps	1	2412	16.90	17.00	97.44
		6	2437	17.70	18.00	
		11	2462	15.30	15.50	
		12	2467	13.30	13.50	
		13	2472	10.60	10.75	
	802.11n-HT20 MCS0	1	2412	16.80	17.00	98.76
		6	2437	17.70	18.00	
		11	2462	15.20	15.50	
		12	2467	13.20	13.50	
		13	2472	10.60	10.75	
	802.11n-HT40 MCS0	3	2422	16.90	17.00	99.01
		6	2437	17.30	17.50	
		9	2452	13.50	13.75	
		10	2457	11.40	11.50	
		11	2462	11.20	11.50	
802.11ax-HE20 MCS0	1	2412	16.80	17.00	97.23	
	6	2437	17.60	18.00		
	11	2462	15.20	15.50		
	12	2467	13.30	13.50		
	13	2472	10.70	10.75		
802.11ax-HE40 MCS0	3	2422	16.70	17.00	96.88	
	6	2437	17.20	17.50		
	9	2452	13.40	13.75		
	10	2457	11.40	11.50		
	11	2462	11.40	11.50		



<2.4GHz WLAN ANT 1>

	Mode	Channel	Frequency (MHz)	Average power (dBm)	Tune-Up Limit	Duty Cycle %
2.4GHz WLAN	802.11b 1Mbps	1	2412	17.70	18.00	98.99
		6	2437	17.90	18.00	
		11	2462	17.90	18.00	
		12	2467	17.10	17.50	
		13	2472	15.20	15.25	
	802.11g 6Mbps	1	2412	17.70	18.00	97.67
		6	2437	17.80	18.00	
		11	2462	15.40	15.50	
		12	2467	13.10	13.50	
		13	2472	10.60	10.75	
	802.11n-HT20 MCS0	1	2412	17.80	18.00	98.76
		6	2437	17.70	18.00	
		11	2462	15.30	15.50	
		12	2467	13.20	13.50	
		13	2472	10.70	10.75	
	802.11n-HT40 MCS0	3	2422	16.80	17.00	98.76
		6	2437	17.10	17.50	
		9	2452	13.70	14.00	
		10	2457	11.30	11.50	
		11	2462	11.30	11.50	
802.11ax-HE20 MCS0	1	2412	17.80	18.00	97.48	
	6	2437	17.70	18.00		
	11	2462	15.20	15.50		
	12	2467	13.30	13.50		
	13	2472	10.60	10.75		
802.11ax-HE40 MCS0	3	2422	16.70	17.00	97.01	
	6	2437	17.10	17.50		
	9	2452	13.60	14.00		
	10	2457	11.30	11.50		
	11	2462	11.40	11.50		

<2.4GHz WLAN ANT 1+2>

	Mode	Channel	Frequency (MHz)	Average power (dBm)	Tune-Up Limit	Duty Cycle %
2.4GHz WLAN	802.11n-HT20 MCS0	1	2412	16.01	16.25	98.94
		6	2437	17.31	17.50	
		11	2462	14.36	14.50	
		12	2467	12.76	13.00	
		13	2472	7.71	7.75	
	802.11n-HT40 MCS0	3	2422	16.21	16.25	99.00
		6	2437	16.36	16.50	
		9	2452	13.21	13.25	
		10	2457	9.96	10.50	
		11	2462	8.16	8.50	
	802.11ax-HE20 MCS0	1	2412	16.06	16.25	97.55
		6	2437	17.26	17.50	
		11	2462	14.36	14.50	
		12	2467	12.82	13.00	
		13	2472	7.51	7.75	
	802.11ax-HE40 MCS0	3	2422	16.16	16.25	97.04
		6	2437	16.26	16.50	
		9	2452	13.16	13.25	
		10	2457	10.46	10.50	
		11	2462	8.31	8.50	



<5GHz WLAN ANT2>

	Mode	Channel	Frequency (MHz)	Average power (dBm)	Tune-Up Limit	Duty Cycle %
5.2GHz WLAN	802.11a 6Mbps	36	5180	15.80	16.00	97.35
		40	5200	15.70	16.00	
		44	5220	15.70	16.00	
		48	5240	15.80	16.00	
	802.11n-HT20 MCS0	36	5180	15.80	16.00	98.51
		40	5200	15.70	16.00	
		44	5220	15.80	16.00	
		48	5240	15.80	16.00	
	802.11n-HT40 MCS0	38	5190	15.80	16.00	97.77
		46	5230	15.70	16.00	
	802.11ac-VHT20 MCS0	36	5180	15.70	16.00	98.75
		40	5200	15.60	16.00	
		44	5220	15.70	16.00	
		48	5240	15.70	16.00	
	802.11ac-VHT40 MCS0	38	5190	15.80	16.00	98.13
		46	5230	15.80	16.00	
	802.11ac-VHT80 MCS0	42	5210	15.70	16.00	97.76
	802.11ax-HE20 MCS0	36	5180	15.80	16.00	97.81
		40	5200	15.70	16.00	
		44	5220	15.70	16.00	
48		5240	15.80	16.00		
802.11ax-HE40 MCS0	38	5190	15.70	16.00	96.35	
	46	5230	15.70	16.00		
802.11ax-HE80 MCS0	42	5210	15.90	16.00	96.22	



	Mode	Channel	Frequency (MHz)	Average power (dBm)	Tune-Up Limit	Duty Cycle %
5.3GHz WLAN	802.11a 6Mbps	52	5260	15.90	16.00	97.35
		56	5280	15.80	16.00	
		60	5300	15.80	16.00	
		64	5320	15.90	16.00	
	802.11n-HT20 MCS0	52	5260	15.80	16.00	98.51
		56	5280	15.70	16.00	
		60	5300	15.70	16.00	
		64	5320	15.70	16.00	
	802.11n-HT40 MCS0	54	5270	15.70	16.00	97.77
		62	5310	15.80	16.00	
	802.11ac-VHT20 MCS0	52	5260	15.70	16.00	98.75
		56	5280	15.60	16.00	
		60	5300	15.60	16.00	
		64	5320	15.70	16.00	
	802.11ac-VHT40 MCS0	54	5270	15.60	16.00	98.13
		62	5310	15.70	16.00	
802.11ac-VHT80 MCS0	58	5290	15.70	16.00	97.76	
802.11ac-VHT160 MCS0	50	5250	14.50	14.75	97.27	
802.11ax-HE20 MCS0	52	5260	15.80	16.00	97.81	
	56	5280	15.70	16.00		
	60	5300	15.70	16.00		
	64	5320	15.70	16.00		
802.11ax-HE40 MCS0	54	5270	15.80	16.00	96.35	
	62	5310	15.70	16.00		
802.11ax-HE80 MCS0	58	5290	15.90	16.00	96.22	
802.11ax-HE160 MCS0	50	5250	14.60	14.75	96.05	



	Mode	Channel	Frequency (MHz)	Average power (dBm)	Tune-Up Limit	Duty Cycle %
5.5GHz WLAN	802.11a 6Mbps	100	5500	15.90	16.00	97.35
		116	5580	15.90	16.00	
		124	5620	15.80	16.00	
		132	5660	15.80	16.00	
		144	5720	15.90	16.00	
	802.11n-HT20 MCS0	100	5500	15.80	16.00	98.51
		116	5580	15.90	16.00	
		124	5620	15.80	16.00	
		132	5660	15.70	16.00	
		144	5720	15.80	16.00	
	802.11n-HT40 MCS0	102	5510	15.80	16.00	97.77
		110	5550	15.90	16.00	
		126	5630	15.80	16.00	
		134	5670	15.90	16.00	
		142	5710	15.80	16.00	
	802.11ac-VHT20 MCS0	100	5500	15.80	16.00	98.75
		116	5580	15.80	16.00	
		124	5620	15.70	16.00	
		132	5660	15.70	16.00	
		144	5720	15.80	16.00	
	802.11ac-VHT40 MCS0	102	5510	15.70	16.00	98.13
		110	5550	15.70	16.00	
		126	5630	15.70	16.00	
		134	5670	15.70	16.00	
		142	5710	15.80	16.00	
	802.11ac-VHT80 MCS0	106	5530	15.70	16.00	97.76
		122	5610	15.70	16.00	
		138	5690	15.80	16.00	
802.11ac-VHT160 MCS0	114	5570	15.40	15.50	97.27	
802.11ax-HE20 MCS0	100	5500	15.90	16.00	97.81	
	116	5580	15.80	16.00		
	124	5620	15.80	16.00		
	132	5660	15.80	16.00		
	144	5720	15.90	16.00		
802.11ax-HE40 MCS0	102	5510	15.90	16.00	96.35	
	110	5550	15.80	16.00		
	126	5630	15.70	16.00		
	134	5670	15.60	16.00		
	142	5710	15.80	16.00		
802.11ax-HE80 MCS0	106	5530	15.80	16.00	96.22	
	122	5610	15.70	16.00		
	138	5690	15.70	16.00		
802.11ax-HE160 MCS0	114	5570	15.30	15.50	96.05	



	Mode	Channel	Frequency (MHz)	Average power (dBm)	Tune-Up Limit	Duty Cycle %
5.8GHz WLAN	802.11a MCS0	149	5745	15.70	16.00	97.35
		157	5785	15.70	16.00	
		165	5825	15.60	16.00	
	802.11n-HT20 MCS0	149	5745	15.90	16.00	98.51
		157	5785	15.90	16.00	
		165	5825	15.90	16.00	
	802.11n-HT40 MCS0	151	5755	15.80	16.00	97.77
		159	5795	15.80	16.00	
	802.11ac-VHT20 MCS0	149	5745	15.80	16.00	98.75
		157	5785	15.80	16.00	
		165	5825	15.70	16.00	
	802.11ac-VHT40 MCS0	151	5755	15.70	16.00	98.13
		159	5795	15.70	16.00	
	802.11ac-VHT80 MCS0	155	5775	15.60	16.00	97.76
	802.11ax-HE20 MCS0	149	5745	15.90	16.00	97.81
157		5785	15.90	16.00		
165		5825	15.80	16.00		
802.11ax-HE40 MCS0	151	5755	15.80	16.00	96.35	
	159	5795	15.70	16.00		
802.11ax-HE80 MCS0	155	5775	15.60	16.00	96.22	



<5GHz WLAN ANT1>

	Mode	Channel	Frequency (MHz)	Average power (dBm)	Tune-Up Limit	Duty Cycle %
5.2GHz WLAN	802.11a 6Mbps	36	5180	16.30	16.50	97.85
		40	5200	16.30	16.50	
		44	5220	16.40	16.50	
		48	5240	16.40	16.50	
	802.11n-HT20 MCS0	36	5180	16.30	16.50	98.76
		40	5200	16.30	16.50	
		44	5220	16.30	16.50	
		48	5240	16.40	16.50	
	802.11n-HT40 MCS0	38	5190	16.40	16.50	97.52
		46	5230	16.40	16.50	
	802.11ac-VHT20 MCS0	36	5180	16.30	16.50	98.25
		40	5200	16.20	16.50	
		44	5220	16.20	16.50	
		48	5240	16.30	16.50	
	802.11ac-VHT40 MCS0	38	5190	16.30	16.50	97.87
		46	5230	16.40	16.50	
	802.11ac-VHT80 MCS0	42	5210	16.30	16.50	97.65
	802.11ax-HE20 MCS0	36	5180	16.30	16.50	97.45
40		5200	16.10	16.50		
44		5220	16.10	16.50		
48		5240	16.20	16.50		
802.11ax-HE40 MCS0	38	5190	16.30	16.50	96.55	
	46	5230	16.30	16.50		
802.11ax-HE80 MCS0	42	5210	16.20	16.50	96.34	



	Mode	Channel	Frequency (MHz)	Average power (dBm)	Tune-Up Limit	Duty Cycle %
5.3GHz WLAN	802.11a 6Mbps	52	5260	16.40	16.50	97.85
		56	5280	16.20	16.50	
		60	5300	16.20	16.50	
		64	5320	16.30	16.50	
	802.11n-HT20 MCS0	52	5260	16.30	16.50	98.76
		56	5280	16.30	16.50	
		60	5300	16.40	16.50	
		64	5320	16.40	16.50	
	802.11n-HT40 MCS0	54	5270	16.40	16.50	97.52
		62	5310	16.30	16.50	
	802.11ac-VHT20 MCS0	52	5260	16.30	16.50	98.25
		56	5280	16.20	16.50	
		60	5300	16.30	16.50	
		64	5320	16.30	16.50	
	802.11ac-VHT40 MCS0	54	5270	16.30	16.50	97.87
		62	5310	16.20	16.50	
802.11ac-VHT80 MCS0	58	5290	16.20	16.50	97.65	
802.11ac-VHT160 MCS0	50	5250	14.40	14.50	98.27	
802.11ax-HE20 MCS0	52	5260	16.20	16.50	97.45	
	56	5280	16.10	16.50		
	60	5300	16.20	16.50		
	64	5320	16.40	16.50		
802.11ax-HE40 MCS0	54	5270	16.40	16.50	96.55	
	62	5310	16.30	16.50		
802.11ax-HE80 MCS0	58	5290	16.40	16.50	96.34	
802.11ax-HE160 MCS0	50	5250	14.40	14.50	96.27	



	Mode	Channel	Frequency (MHz)	Average power (dBm)	Tune-Up Limit	Duty Cycle %
5.5GHz WLAN	802.11a 6Mbps	100	5500	16.30	16.50	97.85
		116	5580	16.30	16.50	
		124	5620	16.20	16.50	
		132	5660	16.30	16.50	
		144	5720	16.20	16.50	
	802.11n-HT20 MCS0	100	5500	16.40	16.50	98.76
		116	5580	16.30	16.50	
		124	5620	16.30	16.50	
		132	5660	16.40	16.50	
		144	5720	16.40	16.50	
	802.11n-HT40 MCS0	102	5510	16.40	16.50	97.52
		110	5550	16.40	16.50	
		126	5630	16.30	16.50	
		134	5670	16.40	16.50	
		142	5710	16.40	16.50	
	802.11ac-VHT20 MCS0	100	5500	16.40	16.50	98.25
		116	5580	16.30	16.50	
		124	5620	16.30	16.50	
		132	5660	16.40	16.50	
		144	5720	16.30	16.50	
	802.11ac-VHT40 MCS0	102	5510	16.30	16.50	97.87
		110	5550	16.20	16.50	
		126	5630	16.20	16.50	
		134	5670	16.20	16.50	
		142	5710	16.30	16.50	
	802.11ac-VHT80 MCS0	106	5530	16.30	16.50	97.65
		122	5610	16.30	16.50	
		138	5690	16.30	16.50	
802.11ac-VHT160 MCS0	114	5570	14.40	14.50	98.27	
802.11ax-HE20 MCS0	100	5500	16.30	16.50	97.45	
	116	5580	16.30	16.50		
	124	5620	16.30	16.50		
	132	5660	16.20	16.50		
	144	5720	16.20	16.50		
802.11ax-HE40 MCS0	102	5510	16.30	16.50	96.55	
	110	5550	16.30	16.50		
	126	5630	16.40	16.50		
	134	5670	16.10	16.50		
	142	5710	16.20	16.50		
802.11ax-HE80 MCS0	106	5530	16.30	16.50	96.34	
	122	5610	16.40	16.50		
	138	5690	16.20	16.50		
802.11ax-HE160 MCS0	114	5570	14.40	14.50	96.27	



	Mode	Channel	Frequency (MHz)	Average power (dBm)	Tune-Up Limit	Duty Cycle %
5.8GHz WLAN	802.11a MCS0	149	5745	16.20	16.50	97.85
		157	5785	16.10	16.50	
		165	5825	16.20	16.50	
	802.11n-HT20 MCS0	149	5745	16.40	16.50	98.76
		157	5785	16.30	16.50	
		165	5825	16.40	16.50	
	802.11n-HT40 MCS0	151	5755	16.40	16.50	97.52
		159	5795	16.30	16.50	
	802.11ac-VHT20 MCS0	149	5745	16.30	16.50	98.25
		157	5785	16.20	16.50	
		165	5825	16.30	16.50	
	802.11ac-VHT40 MCS0	151	5755	16.30	16.50	97.87
		159	5795	16.20	16.50	
	802.11ac-VHT80 MCS0	155	5775	16.20	16.50	97.65
	802.11ax-HE20 MCS0	149	5745	16.40	16.50	97.45
157		5785	16.30	16.50		
165		5825	16.20	16.50		
802.11ax-HE40 MCS0	151	5755	16.30	16.50	96.55	
	159	5795	16.30	16.50		
802.11ax-HE80 MCS0	155	5775	16.40	16.50	96.34	

<5GHz WLAN ANT1+2>

	Mode	Channel	Frequency (MHz)	Average power (dBm)	Tune-Up Limit	Duty Cycle %
5.2GHz WLAN	802.11n-HT20 MCS0	36	5180	15.86	16.00	98.69
		40	5200	15.81	16.00	
		44	5220	15.91	16.00	
		48	5240	15.76	16.00	
	802.11n-HT40 MCS0	38	5190	15.91	16.00	98.50
		46	5230	15.76	16.00	
	802.11ac-VHT20 MCS0	36	5180	15.81	16.00	98.49
		40	5200	15.86	16.00	
		44	5220	15.91	16.00	
	802.11ac-VHT40 MCS0	38	5190	15.86	16.00	97.86
		46	5230	15.71	16.00	
	802.11ac-VHT80 MCS0	42	5210	15.61	16.00	97.25
	802.11ax-HE20 MCS0	36	5180	15.81	16.00	97.69
		40	5200	15.76	16.00	
		44	5220	15.78	16.00	
		48	5240	15.86	16.00	
802.11ax-HE40 MCS0	38	5190	15.87	16.00	97.51	
	46	5230	15.86	16.00		
802.11ax-HE80 MCS0	42	5210	15.81	16.00	97.36	



	Mode	Channel	Frequency (MHz)	Average power (dBm)	Tune-Up Limit	Duty Cycle %
5.3GHz WLAN	802.11n-HT20 MCS0	52	5260	15.91	16.00	98.69
		56	5280	15.81	16.00	
		60	5300	15.86	16.00	
		64	5320	15.96	16.00	
	802.11n-HT40 MCS0	54	5270	15.96	16.00	98.50
		62	5310	15.81	16.00	
	802.11ac-VHT20 MCS0	52	5260	15.91	16.00	98.49
		56	5280	15.81	16.00	
		60	5300	15.81	16.00	
		64	5320	15.91	16.00	
	802.11ac-VHT40 MCS0	54	5270	15.91	16.00	97.86
		62	5310	15.71	16.00	
	802.11ac-VHT80 MCS0	58	5290	15.46	15.75	97.25
	802.11ac-VHT160 MCS0	50	5250	14.21	14.50	97.12
	802.11ax-HE20 MCS0	52	5260	15.81	16.00	97.69
		56	5280	15.76	16.00	
60		5300	15.73	16.00		
64		5320	15.76	16.00		
802.11ax-HE40 MCS0	54	5270	15.81	16.00	97.51	
	62	5310	15.76	16.00		
802.11ax-HE80 MCS0	58	5290	15.41	15.75	97.36	
802.11ax-HE160 MCS0	50	5250	14.41	14.50	97.02	



	Mode	Channel	Frequency (MHz)	Average power (dBm)	Tune-Up Limit	Duty Cycle %
5.5GHz WLAN	802.11n-HT20 MCS0	100	5500	15.81	16.00	98.69
		116	5580	15.86	16.00	
		124	5620	15.71	16.00	
		132	5660	15.76	16.00	
		144	5720	15.81	16.00	
	802.11n-HT40 MCS0	102	5510	15.86	16.00	98.50
		110	5550	15.76	16.00	
		126	5630	15.71	16.00	
		134	5670	15.76	16.00	
		142	5710	15.96	16.00	
	802.11ac-VHT20 MCS0	100	5500	15.76	16.00	98.49
		116	5580	15.71	16.00	
		124	5620	15.71	16.00	
		132	5660	15.66	16.00	
		144	5720	15.71	16.00	
	802.11ac-VHT40 MCS0	102	5510	15.76	16.00	97.86
		110	5550	15.76	16.00	
		126	5630	15.71	16.00	
		134	5670	15.76	16.00	
		142	5710	15.91	16.00	
	802.11ac-VHT80 MCS0	106	5530	15.86	16.00	97.25
		122	5610	15.81	16.00	
		138	5690	15.76	16.00	
	802.11ac-VHT160 MCS0	114	5570	14.26	14.50	97.12
	802.11ax-HE20 MCS0	100	5500	15.81	16.00	97.69
		116	5580	15.77	16.00	
		124	5620	15.67	16.00	
		132	5660	15.68	16.00	
144		5720	15.71	16.00		
802.11ax-HE40 MCS0	102	5510	15.91	16.00	97.51	
	110	5550	15.83	16.00		
	126	5630	15.81	16.00		
	134	5670	15.66	16.00		
	142	5710	15.56	16.00		
802.11ax-HE80 MCS0	106	5530	15.87	16.00	97.36	
	122	5610	15.86	16.00		
	138	5690	15.76	16.00		
802.11ax-HE160 MCS0	114	5570	14.31	14.50	97.02	



	Mode	Channel	Frequency (MHz)	Average power (dBm)	Tune-Up Limit	Duty Cycle %
5.8GHz WLAN	802.11n-HT20 MCS0	149	5745	15.87	16.00	98.69
		157	5785	15.72	16.00	
		165	5825	15.76	16.00	
	802.11n-HT40 MCS0	151	5755	15.92	16.00	98.50
		159	5795	15.91	16.00	
	802.11ac-VHT20 MCS0	149	5745	15.77	16.00	98.49
		157	5785	15.72	16.00	
		165	5825	15.71	16.00	
	802.11ac-VHT40 MCS0	151	5755	15.72	16.00	97.86
		159	5795	15.72	16.00	
	802.11ac-VHT80 MCS0	155	5775	15.82	16.00	97.25
	802.11ax-HE20 MCS0	149	5745	15.72	16.00	97.69
		157	5785	15.72	16.00	
		165	5825	15.71	16.00	
	802.11ax-HE40 MCS0	151	5755	15.67	16.00	97.51
		159	5795	15.67	16.00	
	802.11ax-HE80 MCS0	155	5775	15.87	16.00	97.36



<For Laptop Mode>

<2.4GHz WLAN ANT 2>

	Mode	Channel	Frequency (MHz)	Average power (dBm)	Tune-Up Limit	Duty Cycle %
2.4GHz WLAN	802.11b 1Mbps	1	2412	19.30	19.50	99.11
		6	2437	20.30	20.50	
		11	2462	18.00	18.25	
		12	2467	16.20	16.50	
		13	2472	15.20	15.25	
	802.11g 6Mbps	1	2412	16.90	17.00	97.44
		6	2437	19.70	20.00	
		11	2462	15.30	15.50	
		12	2467	13.30	13.50	
		13	2472	10.60	10.75	
	802.11n-HT20 MCS0	1	2412	16.90	17.00	98.76
		6	2437	19.60	20.00	
		11	2462	15.20	15.50	
		12	2467	13.20	13.50	
		13	2472	10.60	10.75	
	802.11n-HT40 MCS0	3	2422	16.90	17.00	99.01
		6	2437	17.30	17.50	
		9	2452	13.50	13.75	
		10	2457	11.40	11.50	
		11	2462	11.20	11.50	
802.11ax-HE20 MCS0	1	2412	16.80	17.00	97.23	
	6	2437	19.70	20.00		
	11	2462	15.20	15.50		
	12	2467	13.30	13.50		
	13	2472	10.70	10.75		
802.11ax-HE40 MCS0	3	2422	16.70	17.00	96.88	
	6	2437	17.20	17.50		
	9	2452	13.40	13.75		
	10	2457	11.40	11.50		
	11	2462	11.40	11.50		



<2.4GHz WLAN ANT 1>

	Mode	Channel	Frequency (MHz)	Average power (dBm)	Tune-Up Limit	Duty Cycle %
2.4GHz WLAN	802.11b 1Mbps	1	2412	19.30	19.50	98.99
		6	2437	20.20	20.50	
		11	2462	18.00	18.25	
		12	2467	17.10	17.50	
		13	2472	15.20	15.25	
	802.11g 6Mbps	1	2412	17.70	18.00	97.67
		6	2437	19.80	20.00	
		11	2462	15.40	15.50	
		12	2467	13.10	13.50	
		13	2472	10.60	10.75	
	802.11n-HT20 MCS0	1	2412	17.80	18.00	98.76
		6	2437	19.70	20.00	
		11	2462	15.30	15.50	
		12	2467	13.20	13.50	
		13	2472	10.70	10.75	
	802.11n-HT40 MCS0	3	2422	16.80	17.00	98.76
		6	2437	17.10	17.50	
		9	2452	13.70	14.00	
		10	2457	11.30	11.50	
		11	2462	11.30	11.50	
802.11ax-HE20 MCS0	1	2412	17.80	18.00	97.48	
	6	2437	19.80	20.00		
	11	2462	15.20	15.50		
	12	2467	13.30	13.50		
	13	2472	10.60	10.75		
802.11ax-HE40 MCS0	3	2422	16.70	17.00	97.01	
	6	2437	17.10	17.50		
	9	2452	13.60	14.00		
	10	2457	11.30	11.50		
	11	2462	11.40	11.50		



<2.4GHz WLAN ANT 1+2>

	Mode	Channel	Frequency (MHz)	Average power (dBm)	Tune-Up Limit	Duty Cycle %
2.4GHz WLAN	802.11n-HT20 MCS0	1	2412	16.21	16.25	98.94
		6	2437	17.31	17.50	
		11	2462	14.36	14.50	
		12	2467	12.76	13.00	
		13	2472	7.71	7.75	
	802.11n-HT40 MCS0	3	2422	16.21	16.25	99.00
		6	2437	16.36	16.50	
		9	2452	13.21	13.25	
		10	2457	9.96	10.50	
		11	2462	8.16	8.50	
	802.11ax-HE20 MCS0	1	2412	16.06	16.25	97.55
		6	2437	17.36	17.50	
		11	2462	14.36	14.50	
		12	2467	12.82	13.00	
		13	2472	7.51	7.75	
	802.11ax-HE40 MCS0	3	2422	16.16	16.25	97.04
		6	2437	16.26	16.50	
		9	2452	13.16	13.25	
		10	2457	10.46	10.50	
		11	2462	8.31	8.50	



<5GHz WLAN ANT2>

	Mode	Channel	Frequency (MHz)	Average power (dBm)	Tune-Up Limit	Duty Cycle %
5.2GHz WLAN	802.11a 6Mbps	36	5180	18.90	19.00	97.35
		40	5200	20.40	20.50	
		44	5220	20.40	20.50	
		48	5240	20.30	20.50	
	802.11n-HT20 MCS0	36	5180	18.90	19.00	98.51
		40	5200	20.20	20.50	
		44	5220	20.40	20.50	
		48	5240	20.30	20.50	
	802.11n-HT40 MCS0	38	5190	18.40	18.50	97.77
		46	5230	20.30	20.50	
	802.11ac-VHT20 MCS0	36	5180	18.80	19.00	98.75
		40	5200	20.20	20.50	
		44	5220	20.30	20.50	
		48	5240	20.20	20.50	
	802.11ac-VHT40 MCS0	38	5190	18.30	18.50	98.13
		46	5230	20.20	20.50	
802.11ac-VHT80 MCS0	42	5210	18.40	18.50	97.76	
802.11ax-HE20 MCS0	36	5180	18.80	19.00	97.81	
	40	5200	20.30	20.50		
	44	5220	20.30	20.50		
	48	5240	20.40	20.50		
802.11ax-HE40 MCS0	38	5190	18.30	18.50	96.35	
	46	5230	20.20	20.50		
802.11ax-HE80 MCS0	42	5210	18.30	18.50	96.22	



	Mode	Channel	Frequency (MHz)	Average power (dBm)	Tune-Up Limit	Duty Cycle %
5.3GHz WLAN	802.11a 6Mbps	52	5260	20.30	20.50	97.35
		56	5280	20.30	20.50	
		60	5300	20.20	20.50	
		64	5320	18.60	18.75	
	802.11n-HT20 MCS0	52	5260	20.30	20.50	98.51
		56	5280	20.20	20.50	
		60	5300	20.40	20.50	
		64	5320	18.70	18.75	
	802.11n-HT40 MCS0	54	5270	20.40	20.50	97.77
		62	5310	17.40	17.50	
	802.11ac-VHT20 MCS0	52	5260	20.20	20.50	98.75
		56	5280	20.10	20.50	
		60	5300	20.30	20.50	
		64	5320	18.60	18.75	
	802.11ac-VHT40 MCS0	54	5270	20.30	20.50	98.13
		62	5310	17.30	17.50	
802.11ac-VHT80 MCS0	58	5290	17.20	17.50	97.76	
802.11ac-VHT160 MCS0	50	5250	14.60	14.75	97.27	
802.11ax-HE20 MCS0	52	5260	20.40	20.50	97.81	
	56	5280	20.30	20.50		
	60	5300	20.30	20.50		
	64	5320	18.60	18.75		
802.11ax-HE40 MCS0	54	5270	20.40	20.50	96.35	
	62	5310	17.30	17.50		
802.11ax-HE80 MCS0	58	5290	17.40	17.50	96.22	
802.11ax-HE160 MCS0	50	5250	14.40	14.75	96.05	



	Mode	Channel	Frequency (MHz)	Average power (dBm)	Tune-Up Limit	Duty Cycle %
5.5GHz WLAN	802.11a 6Mbps	100	5500	19.40	19.50	97.35
		116	5580	20.30	20.50	
		124	5620	20.10	20.50	
		132	5660	20.30	20.50	
		144	5720	20.40	20.50	
	802.11n-HT20 MCS0	100	5500	19.40	19.50	98.51
		116	5580	20.40	20.50	
		124	5620	20.40	20.50	
		132	5660	20.20	20.50	
		144	5720	20.10	20.50	
	802.11n-HT40 MCS0	102	5510	18.70	19.00	97.77
		110	5550	20.40	20.50	
		126	5630	20.20	20.50	
		134	5670	19.40	19.50	
		142	5710	20.10	20.50	
	802.11ac-VHT20 MCS0	100	5500	19.30	19.50	98.75
		116	5580	20.30	20.50	
		124	5620	20.30	20.50	
		132	5660	20.40	20.50	
		144	5720	20.00	20.50	
	802.11ac-VHT40 MCS0	102	5510	18.60	19.00	98.13
		110	5550	20.30	20.50	
		126	5630	20.10	20.50	
		134	5670	19.30	19.50	
		142	5710	20.00	20.50	
	802.11ac-VHT80 MCS0	106	5530	18.40	18.50	97.76
		122	5610	19.40	19.50	
		138	5690	20.20	20.50	
802.11ac-VHT160 MCS0	114	5570	15.30	15.50	97.27	
802.11ax-HE20 MCS0	100	5500	19.30	19.50	97.81	
	116	5580	20.30	20.50		
	124	5620	20.40	20.50		
	132	5660	20.40	20.50		
	144	5720	20.40	20.50		
802.11ax-HE40 MCS0	102	5510	18.80	19.00	96.35	
	110	5550	20.10	20.50		
	126	5630	20.20	20.50		
	134	5670	19.40	19.50		
	142	5710	20.40	20.50		
802.11ax-HE80 MCS0	106	5530	18.30	18.50	96.22	
	122	5610	19.20	19.50		
	138	5690	20.30	20.50		
802.11ax-HE160 MCS0	114	5570	15.40	15.50	96.05	



	Mode	Channel	Frequency (MHz)	Average power (dBm)	Tune-Up Limit	Duty Cycle %
5.8GHz WLAN	802.11a MCS0	149	5745	20.20	20.50	97.35
		157	5785	20.10	20.50	
		165	5825	20.20	20.50	
	802.11n-HT20 MCS0	149	5745	20.30	20.50	98.51
		157	5785	20.30	20.50	
		165	5825	20.20	20.50	
	802.11n-HT40 MCS0	151	5755	20.30	20.50	97.77
		159	5795	20.20	20.50	
	802.11ac-VHT20 MCS0	149	5745	20.20	20.50	98.75
		157	5785	20.20	20.50	
		165	5825	20.10	20.50	
	802.11ac-VHT40 MCS0	151	5755	20.20	20.50	98.13
		159	5795	20.20	20.50	
	802.11ac-VHT80 MCS0	155	5775	19.20	19.25	97.76
	802.11ax-HE20 MCS0	149	5745	20.30	20.50	97.81
157		5785	20.30	20.50		
165		5825	20.40	20.50		
802.11ax-HE40 MCS0	151	5755	20.30	20.50	96.35	
	159	5795	20.10	20.50		
802.11ax-HE80 MCS0	155	5775	19.10	19.25	96.22	



<5GHz WLAN ANT1>

	Mode	Channel	Frequency (MHz)	Average power (dBm)	Tune-Up Limit	Duty Cycle %
5.2GHz WLAN	802.11a 6Mbps	36	5180	18.80	19.00	97.85
		40	5200	20.20	20.50	
		44	5220	20.30	20.50	
		48	5240	20.40	20.50	
	802.11n-HT20 MCS0	36	5180	18.70	19.00	98.76
		40	5200	20.20	20.50	
		44	5220	20.40	20.50	
		48	5240	20.30	20.50	
	802.11n-HT40 MCS0	38	5190	18.30	18.50	97.52
		46	5230	20.40	20.50	
	802.11ac-VHT20 MCS0	36	5180	18.60	19.00	98.25
		40	5200	20.30	20.50	
		44	5220	20.30	20.50	
		48	5240	20.20	20.50	
	802.11ac-VHT40 MCS0	38	5190	18.20	18.50	97.87
		46	5230	20.30	20.50	
802.11ac-VHT80 MCS0	42	5210	18.40	18.50	97.65	
802.11ax-HE20 MCS0	36	5180	18.70	19.00	97.45	
	40	5200	20.30	20.50		
	44	5220	20.30	20.50		
	48	5240	20.40	20.50		
802.11ax-HE40 MCS0	38	5190	18.40	18.50	96.55	
	46	5230	20.40	20.50		
802.11ax-HE80 MCS0	42	5210	18.40	18.50	96.34	



	Mode	Channel	Frequency (MHz)	Average power (dBm)	Tune-Up Limit	Duty Cycle %
5.3GHz WLAN	802.11a 6Mbps	52	5260	20.30	20.50	97.85
		56	5280	20.40	20.50	
		60	5300	20.30	20.50	
		64	5320	18.70	18.75	
	802.11n-HT20 MCS0	52	5260	20.30	20.50	98.76
		56	5280	20.20	20.50	
		60	5300	20.30	20.50	
		64	5320	18.60	18.75	
	802.11n-HT40 MCS0	54	5270	20.30	20.50	97.52
		62	5310	17.30	17.50	
	802.11ac-VHT20 MCS0	52	5260	20.20	20.50	98.25
		56	5280	20.30	20.50	
		60	5300	20.20	20.50	
		64	5320	18.50	18.75	
	802.11ac-VHT40 MCS0	54	5270	20.20	20.50	97.87
		62	5310	17.20	17.50	
802.11ac-VHT80 MCS0	58	5290	17.30	17.50	97.65	
802.11ac-VHT160 MCS0	50	5250	14.30	14.50	98.27	
802.11ax-HE20 MCS0	52	5260	20.30	20.50	97.45	
	56	5280	20.20	20.50		
	60	5300	20.20	20.50		
	64	5320	18.50	18.75		
802.11ax-HE40 MCS0	54	5270	20.30	20.50	96.55	
	62	5310	17.40	17.50		
802.11ax-HE80 MCS0	58	5290	17.30	17.50	96.34	
802.11ax-HE160 MCS0	50	5250	14.40	14.50	96.27	



	Mode	Channel	Frequency (MHz)	Average power (dBm)	Tune-Up Limit	Duty Cycle %
5.5GHz WLAN	802.11a 6Mbps	100	5500	19.40	19.50	97.85
		116	5580	20.20	20.50	
		124	5620	20.10	20.50	
		132	5660	20.40	20.50	
		144	5720	20.20	20.50	
	802.11n-HT20 MCS0	100	5500	19.40	19.50	98.76
		116	5580	20.40	20.50	
		124	5620	20.40	20.50	
		132	5660	20.30	20.50	
		144	5720	20.20	20.50	
	802.11n-HT40 MCS0	102	5510	18.80	19.00	97.52
		110	5550	20.20	20.50	
		126	5630	20.30	20.50	
		134	5670	18.30	18.50	
		142	5710	20.00	20.50	
	802.11ac-VHT20 MCS0	100	5500	19.30	19.50	98.25
		116	5580	20.30	20.50	
		124	5620	20.20	20.50	
		132	5660	20.30	20.50	
		144	5720	20.10	20.50	
	802.11ac-VHT40 MCS0	102	5510	18.70	19.00	97.87
		110	5550	20.10	20.50	
		126	5630	20.10	20.50	
		134	5670	18.20	18.50	
		142	5710	19.90	20.50	
	802.11ac-VHT80 MCS0	106	5530	18.30	18.50	97.65
		122	5610	19.30	19.50	
		138	5690	20.20	20.50	
802.11ac-VHT160 MCS0	114	5570	14.10	14.50	98.27	
802.11ax-HE20 MCS0	100	5500	19.30	19.50	97.45	
	116	5580	20.20	20.50		
	124	5620	20.30	20.50		
	132	5660	20.20	20.50		
	144	5720	20.20	20.50		
802.11ax-HE40 MCS0	102	5510	18.70	19.00	96.55	
	110	5550	20.20	20.50		
	126	5630	20.30	20.50		
	134	5670	18.40	18.50		
	142	5710	20.20	20.50		
802.11ax-HE80 MCS0	106	5530	18.30	18.50	96.34	
	122	5610	19.10	19.50		
	138	5690	20.10	20.50		
802.11ax-HE160 MCS0	114	5570	14.40	14.50	96.27	



	Mode	Channel	Frequency (MHz)	Average power (dBm)	Tune-Up Limit	Duty Cycle %
5.8GHz WLAN	802.11a MCS0	149	5745	20.20	20.50	97.85
		157	5785	20.30	20.50	
		165	5825	20.10	20.50	
	802.11n-HT20 MCS0	149	5745	20.40	20.50	98.76
		157	5785	20.30	20.50	
		165	5825	20.20	20.50	
	802.11n-HT40 MCS0	151	5755	20.20	20.50	97.52
		159	5795	20.40	20.50	
	802.11ac-VHT20 MCS0	149	5745	20.40	20.50	98.25
		157	5785	20.20	20.50	
		165	5825	20.10	20.50	
	802.11ac-VHT40 MCS0	151	5755	20.10	20.50	97.87
		159	5795	20.30	20.50	
	802.11ac-VHT80 MCS0	155	5775	18.70	19.00	97.65
	802.11ax-HE20 MCS0	149	5745	20.30	20.50	97.45
157		5785	20.20	20.50		
165		5825	20.30	20.50		
802.11ax-HE40 MCS0	151	5755	20.40	20.50	96.55	
	159	5795	20.40	20.50		
802.11ax-HE80 MCS0	155	5775	18.90	19.00	96.34	



<5GHz WLAN ANT1+2>

	Mode	Channel	Frequency (MHz)	Average power (dBm)	Tune-Up Limit	Duty Cycle %
5.2GHz WLAN	802.11n-HT20 MCS0	36	5180	17.81	18.00	98.69
		40	5200	19.31	19.50	
		44	5220	19.26	19.50	
		48	5240	19.36	19.50	
	802.11n-HT40 MCS0	38	5190	16.27	16.50	98.50
		46	5230	19.16	19.25	
	802.11ac-VHT20 MCS0	36	5180	17.71	18.00	98.49
		40	5200	19.21	19.50	
		44	5220	19.16	19.50	
	802.11ac-VHT40 MCS0	38	5190	16.17	16.50	97.86
		46	5230	19.06	19.25	
	802.11ac-VHT80 MCS0	42	5210	16.46	16.50	97.25
	802.11ax-HE20 MCS0	36	5180	17.71	18.00	97.69
		40	5200	19.31	19.50	
		44	5220	19.32	19.50	
		48	5240	19.41	19.50	
802.11ax-HE40 MCS0	38	5190	16.36	16.50	97.51	
	46	5230	19.01	19.25		
802.11ax-HE80 MCS0	42	5210	16.36	16.50	97.36	



	Mode	Channel	Frequency (MHz)	Average power (dBm)	Tune-Up Limit	Duty Cycle %
5.3GHz WLAN	802.11n-HT20 MCS0	52	5260	19.41	19.50	98.69
		56	5280	19.36	19.50	
		60	5300	19.36	19.50	
		64	5320	17.26	17.50	
	802.11n-HT40 MCS0	54	5270	19.06	19.25	98.50
		62	5310	15.76	16.00	
	802.11ac-VHT20 MCS0	52	5260	19.31	19.50	98.49
		56	5280	19.26	19.50	
		60	5300	19.26	19.50	
		64	5320	17.16	17.50	
	802.11ac-VHT40 MCS0	54	5270	18.96	19.25	97.86
		62	5310	15.66	16.00	
	802.11ac-VHT80 MCS0	58	5290	15.71	15.75	97.25
	802.11ac-VHT160 MCS0	50	5250	17.27	17.50	97.12
	802.11ax-HE20 MCS0	52	5260	19.31	19.50	97.69
		56	5280	19.21	19.50	
60		5300	19.19	19.50		
64		5320	17.41	17.50		
802.11ax-HE40 MCS0	54	5270	19.11	19.25	97.51	
	62	5310	15.91	16.00		
802.11ax-HE80 MCS0	58	5290	15.51	15.75	97.36	
802.11ax-HE160 MCS0	50	5250	17.31	17.50	97.02	



	Mode	Channel	Frequency (MHz)	Average power (dBm)	Tune-Up Limit	Duty Cycle %
5.5GHz WLAN	802.11n-HT20 MCS0	100	5500	18.32	18.50	98.69
		116	5580	19.37	19.50	
		124	5620	19.17	19.50	
		132	5660	19.12	19.50	
		144	5720	19.11	19.50	
	802.11n-HT40 MCS0	102	5510	17.87	18.00	98.50
		110	5550	19.41	19.50	
		126	5630	19.16	19.50	
		134	5670	18.31	18.50	
		142	5710	19.11	19.50	
	802.11ac-VHT20 MCS0	100	5500	18.21	18.50	98.49
		116	5580	19.32	19.50	
		124	5620	19.12	19.50	
		132	5660	19.07	19.50	
		144	5720	19.01	19.50	
	802.11ac-VHT40 MCS0	102	5510	17.77	18.00	97.86
		110	5550	19.31	19.50	
		126	5630	19.06	19.50	
		134	5670	18.21	18.50	
		142	5710	19.01	19.50	
	802.11ac-VHT80 MCS0	106	5530	17.21	17.50	97.25
		122	5610	18.36	18.50	
		138	5690	19.21	19.50	
	802.11ac-VHT160 MCS0	114	5570	17.27	17.50	97.12
	802.11ax-HE20 MCS0	100	5500	18.25	18.50	97.69
		116	5580	19.31	19.50	
		124	5620	19.36	19.50	
		132	5660	29.33	19.50	
144		5720	19.21	19.50		
802.11ax-HE40 MCS0	102	5510	17.66	18.00	97.51	
	110	5550	19.29	19.50		
	126	5630	19.36	19.50		
	134	5670	18.31	18.50		
	142	5710	19.26	19.50		
802.11ax-HE80 MCS0	106	5530	17.46	17.50	97.36	
	122	5610	18.26	18.50		
	138	5690	19.31	19.50		
802.11ax-HE160 MCS0	114	5570	17.46	17.50	97.02	



	Mode	Channel	Frequency (MHz)	Average power (dBm)	Tune-Up Limit	Duty Cycle %
5.8GHz WLAN	802.11n-HT20 MCS0	149	5745	19.27	19.50	98.69
		157	5785	19.47	19.50	
		165	5825	19.46	19.50	
	802.11n-HT40 MCS0	151	5755	19.41	19.50	98.50
		159	5795	19.47	19.50	
	802.11ac-VHT20 MCS0	149	5745	19.12	19.50	98.49
		157	5785	19.37	19.50	
		165	5825	19.41	19.50	
	802.11ac-VHT40 MCS0	151	5755	19.36	19.50	97.86
		159	5795	19.37	19.50	
	802.11ac-VHT80 MCS0	155	5775	17.92	18.25	97.25
	802.11ax-HE20 MCS0	149	5745	19.37	19.50	97.69
		157	5785	19.31	19.50	
		165	5825	19.31	19.50	
	802.11ax-HE40 MCS0	151	5755	19.27	19.50	97.51
159		5795	19.21	19.50		
802.11ax-HE80 MCS0	155	5775	17.97	18.25	97.36	



<2.4GHz Bluetooth>

General Note:

- For 2.4GHz Bluetooth SAR testing was selected 1Mbps due to its highest average power and duty cycle is 77.13% considered in SAR testing, and the duty cycle would be scaled to theoretical 83.3% in reported SAR calculation.

Mode	Channel	Frequency (MHz)	Average power (dBm)		
			1Mbps	2Mbps	3Mbps
BR / EDR	CH 00	2402	9.47	6.00	6.17
	CH 39	2441	9.19	6.12	6.06
	CH 78	2480	9.10	6.13	6.05
Tune-up Limit			9.50	6.20	6.20

Mode	Channel	Frequency (MHz)	Average power (dBm)	
			1Mbps	2Mbps
LE	CH 00	2402	5.20	5.20
	CH 19	2440	5.20	5.20
	CH 39	2480	5.10	5.20
Tune-up Limit			6.00	6.00

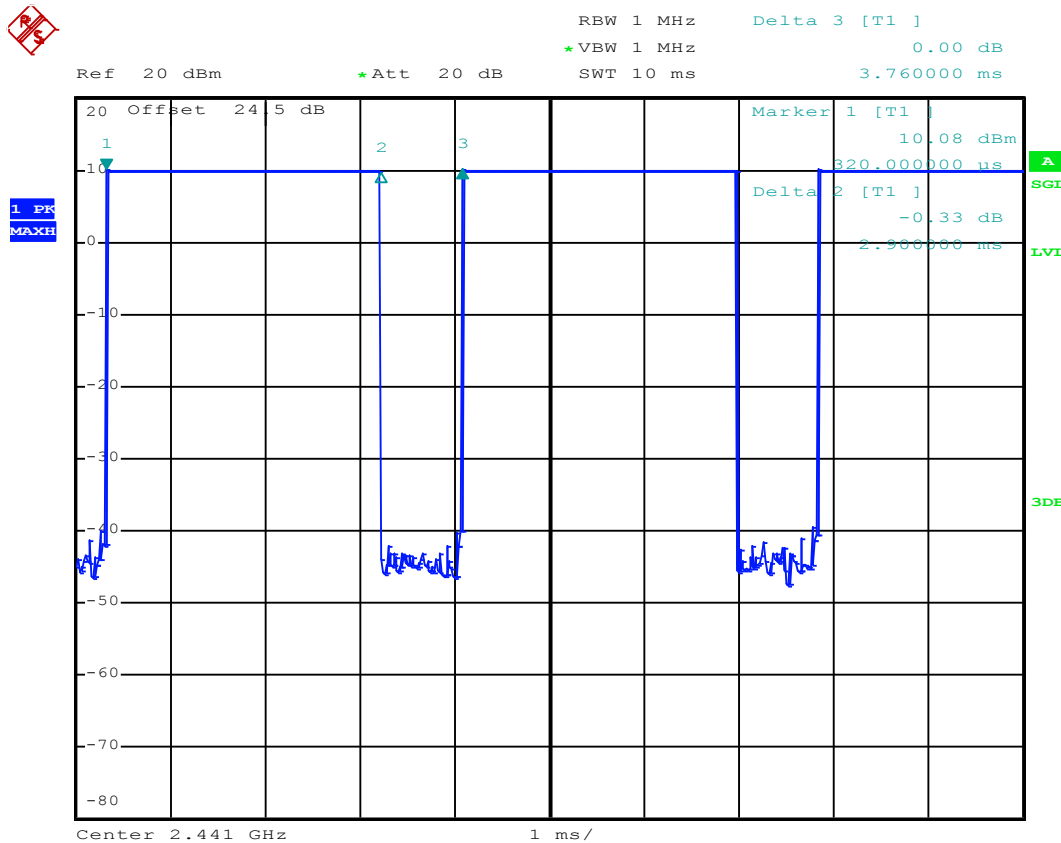

Date: 19.APR.2019 18:26:23

12. Antenna Location

<For Tablet Mode>

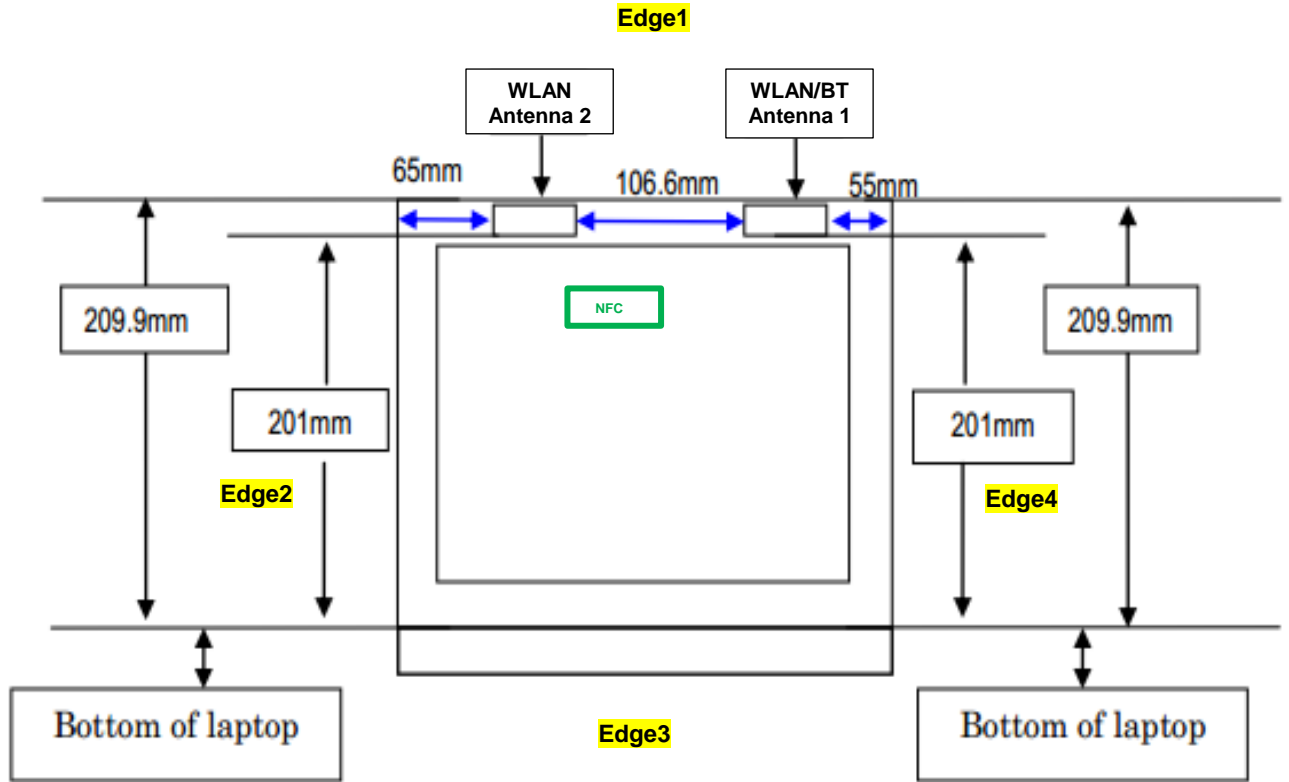

Front View

The separation distance for antenna to edge :

Antenna	To Edge1 (mm)	To Edge2 (mm)	To Edge3 (mm)	To Edge4 (mm)
WLAN Antenna 2	<5	203.6	204.5	65
WLAN/BT Antenna 1	<5	55	204.5	217.6

<For Laptop Mode>

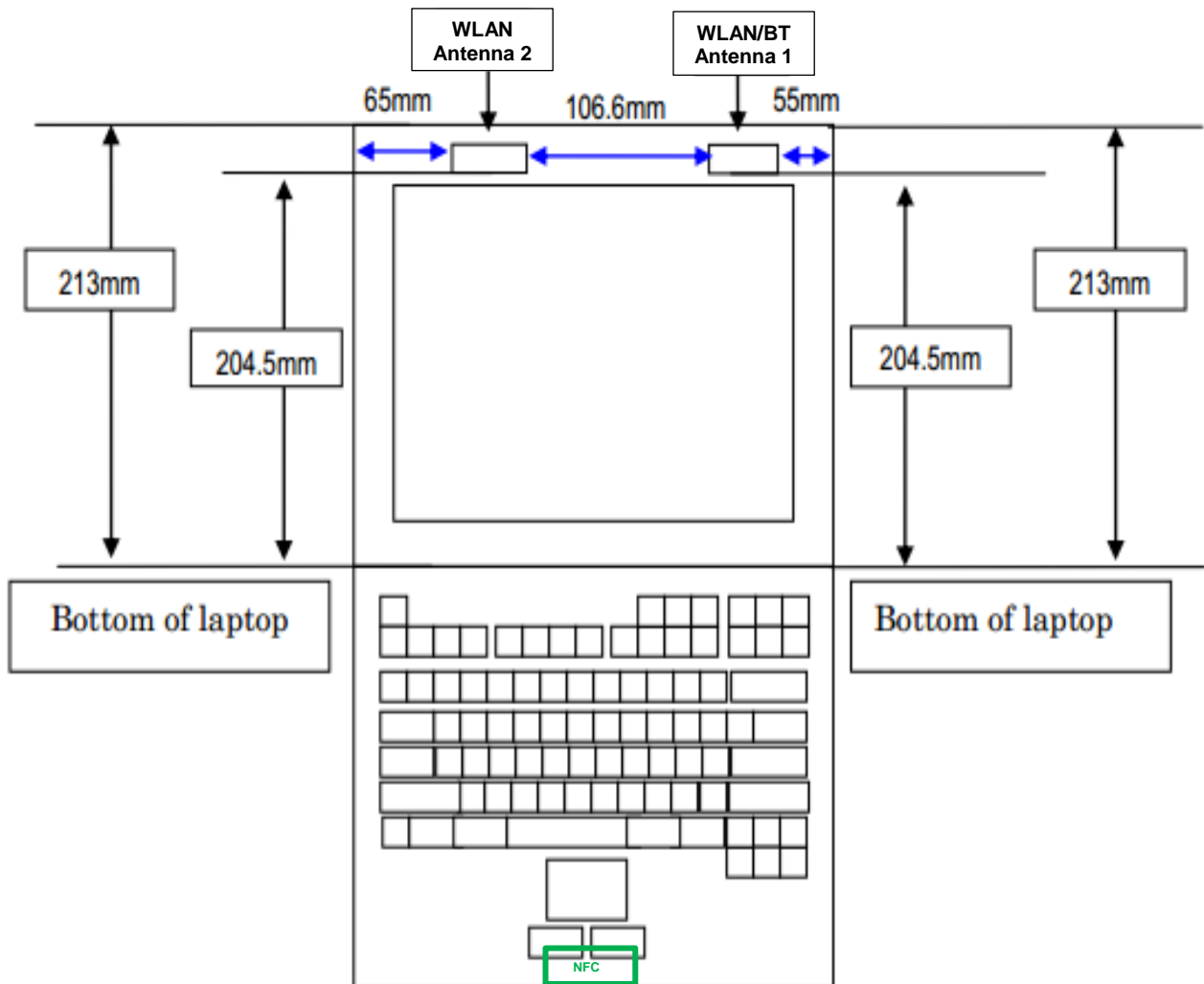



<SAR test exclusion table>

General Note:

1. The below table, when the distance is < 50 mm exclusion threshold is "Ratio", when the distance is > 50 mm exclusion threshold is "mW"
2. Maximum power is the source-based time-average power and represents the maximum RF output power among production units
3. Per KDB 447498 D01v06, for larger devices, the test separation distance of adjacent edge configuration is determined by the closest separation between the antenna and the user.
4. Per KDB 447498 D01v06, standalone SAR test exclusion threshold is applied; If the test separation distance is < 5mm, 5mm is used to determine SAR exclusion threshold.
5. Per KDB 447498 D01v06, the 1-g and 10-g SAR test exclusion thresholds for 100 MHz to 6 GHz at *test separation distances* ≤ 50 mm are determined by:
 - $[(\text{max. power of channel, including tune-up tolerance, mW}) / (\text{min. test separation distance, mm})] \cdot [\sqrt{f(\text{GHz})}] \leq 3.0$ for 1-g SAR and ≤ 7.5 for 10-g extremity SAR
 - f(GHz) is the RF channel transmit frequency in GHz
 - Power and distance are rounded to the nearest mW and mm before calculation
 - The result is rounded to one decimal place for comparison
6. Per KDB 447498 D01v06, at 100 MHz to 6 GHz and for *test separation distances* > 50 mm, the SAR test exclusion threshold is determined according to the following
 - a) [Threshold at 50 mm in step 1) + (test separation distance - 50 mm) · (f(MHz)/150)] mW, at 100 MHz to 1500 MHz
 - b) [Threshold at 50 mm in step 1) + (test separation distance - 50 mm) · 10] mW at > 1500 MHz and ≤ 6 GHz

<For Tablet Mode>

Exposure Position	Wireless Interface	2.4GHz WLAN ANT 2	2.4GHz WLAN ANT 1	5GHz WLAN ANT 2	5GHz WLAN ANT 1
	Calculated Frequency	2472MHz	2472MHz	5825MHz	5825MHz
	Maximum power (dBm)	18	18	16	16.5
	Maximum rated power(mW)	63.0	63.0	40.0	45.0
Bottom Face	Separation distance(mm)	5.0	5.0	5.0	5.0
	exclusion threshold	19.8	19.8	19.3	21.7
	Testing required?	Yes	Yes	Yes	Yes
Edge 1	Separation distance(mm)	5.0	5.0	5.0	5.0
	exclusion threshold	19.8	19.8	19.3	21.7
	Testing required?	Yes	Yes	Yes	Yes
Edge 2	Separation distance(mm)	203.6	55.0	203.6	55.0
	exclusion threshold	1631.0	145.0	1598.0	112.0
	Testing required?	No	No	No	No
Edge 3	Separation distance(mm)	204.5	204.5	204.5	204.5
	exclusion threshold	1640.0	1640.0	1607.0	1607.0
	Testing required?	No	No	No	No
Edge 4	Separation distance(mm)	65.0	217.6	65.0	217.6
	exclusion threshold	245.0	1771.0	212.0	1738.0
	Testing required?	No	No	No	No

<For Laptop Mode>

Exposure Position	Wireless Interface	2.4GHz WLAN ANT 2	2.4GHz WLAN ANT 1	5GHz WLAN ANT 2	5GHz WLAN ANT 1
	Calculated Frequency	2472MHz	2472MHz	5825MHz	5825MHz
	Maximum power (dBm)	20.5	20.5	20.5	20.5
	Maximum rated power(mW)	112.0	112.0	112.0	112.0
Bottom of Laptop	Separation distance(mm)	204.5	204.5	204.5	204.5
	exclusion threshold	1640.0	1640.0	1607.0	1607.0
	Testing required?	No	No	No	No



13. SAR Test Results

General Note:

1. Per KDB 447498 D01v06, the reported SAR is the measured SAR value adjusted for maximum tune-up tolerance.
 - a. Tune-up scaling Factor = tune-up limit power (mW) / EUT RF power (mW), where tune-up limit is the maximum rated power among all production units.
 - b. For SAR testing of WLAN signal with non-100% duty cycle, the measured SAR is scaled-up by the duty cycle scaling factor which is equal to "1/(duty cycle)"
 - c. For WLAN/Bluetooth: Reported SAR(W/kg)= Measured SAR(W/kg)* Duty Cycle scaling factor * Tune-up scaling factor
2. Per KDB 447498 D01v06, for each exposure position, testing of other required channels within the operating mode of a frequency band is not required when the *reported* 1-g or 10-g SAR for the mid-band or highest output power channel is:
 - ≤ 0.8 W/kg or 2.0 W/kg, for 1-g or 10-g respectively, when the transmission band is ≤ 100 MHz
 - ≤ 0.6 W/kg or 1.5 W/kg, for 1-g or 10-g respectively, when the transmission band is between 100 MHz and 200 MHz
 - ≤ 0.4 W/kg or 1.0 W/kg, for 1-g or 10-g respectively, when the transmission band is ≥ 200 MHz
3. Per KDB 865664 D01v01r04, for each frequency band, repeated SAR measurement is required only when the measured SAR is ≥ 0.8 W/kg.

WLAN Note:

1. Per KDB 248227 D01v02r02, for 2.4GHz 802.11g/n SAR testing is not required when the highest reported SAR for DSSS is adjusted by the ratio of OFDM to DSSS specified maximum output power and the adjusted SAR is ≤ 1.2 W/kg.
2. Per KDB 248227 D01v02r02, U-NII-1 SAR testing is not required when the U-NII-2A band highest reported SAR for a test configuration is ≤ 1.2 W/kg, SAR is not required for U-NII-1 band.
3. When the reported SAR of the test position is > 0.4 W/kg, SAR is repeated for the 802.11 transmission mode configuration tested in the initial test position to measure the subsequent next closet/smallest test separation distance and maximum coupling test position on the highest maximum output power channel, until the report SAR is ≤ 0.8 W/kg or all required test position are tested.
4. For all positions / configurations, when the reported SAR is > 0.8 W/kg, SAR is measured for these test positions / configurations on the subsequent next highest measured output power channel(s) until the reported SAR is ≤ 1.2 W/kg or all required channels are tested.
5. For WLAN SAR testing was performed on single antenna RF power in SISO mode is larger or equal to the single antenna RF power in MIMO mode, and for RF exposure assessment of MIMO mode simultaneous transmission exclusion analysis was performed with SAR test results of each antenna in SISO mode.
6. Per KDB 248227 D01v02r02, the simultaneous SAR provisions in KDB publication 447498 should be applied to determine simultaneous transmission SAR test exclusion for WiFi MIMO. If the sum of 1g single transmission chain SAR measurements is < 1.6 W/kg and SAR peak to location ratio ≤ 0.04 , no additional SAR measurements for MIMO.
7. During SAR testing the WLAN transmission was verified using a spectrum analyzer.
8. Since the same RF amplifier and antenna is used for WiFi / Bluetooth transmitter and the Bluetooth output power is least 2 dB below the output power of WiFi, therefore, for Bluetooth SAR testing is selected the same positions of WiFi perform



13.1 Body SAR

<WLAN SAR>

Plot No.	Band	Mode	Test Position	Gap (mm)	Antenna	Configure Tablet / NB	Ch.	Freq. (MHz)	Average Power (dBm)	Tune-Up Limit (dBm)	Tune-up Scaling Factor	Duty Cycle %	Duty Cycle Scaling Factor	Power Drift (dB)	Measured 1g SAR (W/kg)	Reported 1g SAR (W/kg)
	WLAN2.4GHz	802.11b 1Mbps	Bottom Face	0mm	Ant 2	Tablet	6	2437	17.70	18.00	1.072	99.11	1.009	0.08	0.235	0.254
	WLAN2.4GHz	802.11b 1Mbps	Edge 1	0mm	Ant 2	Tablet	6	2437	17.70	18.00	1.072	99.11	1.009	-0.07	0.270	0.292
01	WLAN2.4GHz	802.11b 1Mbps	Edge 1	0mm	Ant 2	Tablet	1	2412	17.70	18.00	1.072	99.11	1.009	-0.06	0.697	0.754
	WLAN2.4GHz	802.11b 1Mbps	Edge 1	0mm	Ant 2	Tablet	11	2462	17.70	18.00	1.072	99.11	1.009	-0.03	0.673	0.728
	WLAN2.4GHz	802.11b 1Mbps	Bottom Face	0mm	Ant 1	Tablet	6	2437	17.90	18.00	1.023	98.99	1.010	0.01	0.308	0.318
	WLAN2.4GHz	802.11b 1Mbps	Edge 1	0mm	Ant 1	Tablet	6	2437	17.90	18.00	1.023	98.99	1.010	-0.03	0.666	0.688
	WLAN5GHz	802.11ac-VHT80 MCS0	Bottom Face	0mm	Ant 2	Tablet	58	5290	15.70	16.00	1.072	97.76	1.023	0	0.204	0.224
	WLAN5GHz	802.11ac-VHT80 MCS0	Edge 1	0mm	Ant 2	Tablet	58	5290	15.70	16.00	1.072	97.76	1.023	0.02	0.847	0.928
	WLAN5GHz	802.11n-HT40 MCS0	Edge 1	0mm	Ant 2	Tablet	62	5310	15.80	16.00	1.047	97.77	1.023	0.05	0.673	0.721
	WLAN5GHz	802.11ac-VHT80 MCS0	Bottom Face	0mm	Ant 1	Tablet	58	5290	16.20	16.50	1.072	97.65	1.024	0	0.195	0.214
02	WLAN5GHz	802.11ac-VHT80 MCS0	Edge 1	0mm	Ant 1	Tablet	58	5290	16.20	16.50	1.072	97.65	1.024	0.02	1.060	1.163
	WLAN5GHz	802.11n-HT40 MCS0	Edge 1	0mm	Ant 1	Tablet	54	5270	16.40	16.50	1.023	97.52	1.025	0.04	1.020	1.070
	WLAN5GHz	802.11ac-VHT80 MCS0	Bottom Face	0mm	Ant 2	Tablet	138	5690	15.80	16.00	1.047	97.76	1.023	0	0.159	0.170
	WLAN5GHz	802.11ac-VHT80 MCS0	Edge 1	0mm	Ant 2	Tablet	138	5690	15.80	16.00	1.047	97.76	1.023	0.03	0.665	0.712
	WLAN5GHz	802.11ac-VHT80 MCS0	Bottom Face	0mm	Ant 1	Tablet	138	5690	16.30	16.50	1.047	97.65	1.024	0	0.169	0.181
	WLAN5GHz	802.11ac-VHT80 MCS0	Edge 1	0mm	Ant 1	Tablet	138	5690	16.30	16.50	1.047	97.65	1.024	0.04	0.857	0.919
03	WLAN5GHz	802.11ac-VHT80 MCS0	Edge 1	0mm	Ant 1	Tablet	122	5610	16.30	16.50	1.047	97.65	1.024	0.03	0.907	0.973
	WLAN5GHz	802.11ac-VHT80 MCS0	Edge 1	0mm	Ant 1	Tablet	106	5530	16.30	16.50	1.047	97.65	1.024	0.02	0.866	0.929
	WLAN5GHz	802.11ac-VHT80 MCS0	Bottom Face	0mm	Ant 2	Tablet	155	5775	15.60	16.00	1.096	97.76	1.023	0	0.156	0.175
	WLAN5GHz	802.11ac-VHT80 MCS0	Edge 1	0mm	Ant 2	Tablet	155	5775	15.60	16.00	1.096	97.76	1.023	-0.05	0.731	0.820
	WLAN5GHz	802.11ac-HT40 MCS0	Edge 1	0mm	Ant 2	Tablet	151	5755	15.80	16.00	1.047	97.77	1.023	0.06	0.558	0.598
	WLAN5GHz	802.11ac-VHT80 MCS0	Bottom Face	0mm	Ant 1	Tablet	155	5775	16.20	16.50	1.072	97.65	1.024	0	0.208	0.228
04	WLAN5GHz	802.11ac-VHT80 MCS0	Edge 1	0mm	Ant 1	Tablet	155	5775	16.20	16.50	1.072	97.65	1.024	0.15	0.942	1.034
	WLAN5GHz	802.11ac-HT40 MCS0	Edge 1	0mm	Ant 1	Tablet	151	5755	16.40	16.50	1.023	97.52	1.025	0.04	0.889	0.932

<Bluetooth SAR>

Plot No.	Band	Mode	Test Position	Gap (mm)	Antenna	Configure Tablet / NB	Ch.	Freq. (MHz)	Average Power (dBm)	Tune-Up Limit (dBm)	Tune-up Scaling Factor	Duty Cycle %	Duty Cycle Scaling Factor	Power Drift (dB)	Measured 1g SAR (W/kg)	Reported 1g SAR (W/kg)
	Bluetooth	1Mbps	Bottom Face	0mm	Ant 1	Tablet	0	2402	9.47	9.50	1.007	77.13	1.080	0.01	0.021	0.023
	Bluetooth	1Mbps	Edge 1	0mm	Ant 1	Tablet	0	2402	9.47	9.50	1.007	77.13	1.080	-0.05	0.071	0.077
05	Bluetooth	1Mbps	Edge 1	0mm	Ant 1	Tablet	39	2441	9.19	9.50	1.074	77.13	1.080	0.08	0.067	0.078
	Bluetooth	1Mbps	Edge 1	0mm	Ant 1	Tablet	78	2480	9.10	9.50	1.096	77.13	1.080	-0.03	0.050	0.059

13.2 Repeated SAR Measurement

No.	Band	Mode	Test Position	Gap (mm)	Antenna	Configure Tablet / NB	Ch.	Freq. (MHz)	Average Power (dBm)	Tune-Up Limit (dBm)	Tune-up Scaling Factor	Duty Cycle %	Duty Cycle Scaling Factor	Power Drift (dB)	Measured 1g SAR (W/kg)	Ratio	Reported 1g SAR (W/kg)
1st	WLAN5GHz	802.11ac-VHT80 MCS0	Edge 1	0mm	Ant 1	Tablet	58	5290	16.20	16.50	1.072	97.65	1.024	0.02	1.060		1.163
2nd	WLAN5GHz	802.11ac-VHT80 MCS0	Edge 1	0mm	Ant 1	Tablet	58	5290	16.20	16.50	1.072	97.65	1.024	0.04	1.020	1.04	1.119
1st	WLAN5GHz	802.11ac-VHT80 MCS0	Edge 1	0mm	Ant 1	Tablet	122	5610	16.30	16.50	1.047	97.65	1.024	0.03	0.907		0.973
2nd	WLAN5GHz	802.11ac-VHT80 MCS0	Edge 1	0mm	Ant 1	Tablet	122	5610	16.30	16.50	1.047	97.65	1.024	0.03	0.867	1.05	0.930
1st	WLAN5GHz	802.11ac-VHT80 MCS0	Edge 1	0mm	Ant 1	Tablet	155	5775	16.20	16.50	1.072	97.65	1.024	0.15	0.942		1.034
2nd	WLAN5GHz	802.11ac-VHT80 MCS0	Edge 1	0mm	Ant 1	Tablet	155	5775	16.20	16.50	1.072	97.65	1.024	0.07	0.891	1.06	0.978

General Note:

1. Per KDB 865664 D01v01r04, for each frequency band, repeated SAR measurement is required only when the measured SAR is $\geq 0.8W/kg$.
2. Per KDB 865664 D01v01r04, if the ratio among the repeated measurement is ≤ 1.2 and the measured SAR $< 1.45W/kg$, only one repeated measurement is required.
3. The ratio is the difference in percentage between original and repeated *measured SAR*.
4. All measurement SAR result is scaled-up to account for tune-up tolerance and is compliant.

14. Simultaneous Transmission Analysis

NO.	Simultaneous Transmission Configurations	Body
1.	2.4GHz WLAN ANT 1 + 2.4GHz WLAN ANT 2	Yes
2.	5GHz WLAN ANT 1 + 5GHz WLAN ANT 2	Yes
3.	2.4GHz WLAN ANT 2 + Bluetooth ANT 1	Yes
4.	5GHz WLAN ANT 2 + Bluetooth ANT 1	Yes
5.	5GHz WLAN ANT 1 + 5GHz WLAN ANT 2 + Bluetooth ANT 1	Yes

General Note:

1. For SAR testing was performed on single antenna RF power in SISO mode is larger or equal to the single antenna RF power in MIMO mode, and for RF exposure assessment of MIMO mode simultaneous transmission exclusion analysis was performed with SAR test results of each antenna in SISO mode.
2. WLAN and Bluetooth share the same antenna 1, and cannot transmit simultaneously.
3. EUT will choose either WLAN 2.4GHz or WLAN 5GHz according to the network signal condition; therefore, 2.4GHz WLAN and 5GHz WLAN will not operate simultaneously at any moment.
4. The Scaled SAR summation is calculated based on the same configuration and test position.
5. Per KDB 447498 D01v06, simultaneous transmission SAR is compliant if,
 - i) Scalar SAR summation < 1.6W/kg.
 - ii) $SPLSR = (SAR1 + SAR2)^{1.5} / (\text{min. separation distance, mm})$, and the peak separation distance is determined from the square root of $[(x1-x2)^2 + (y1-y2)^2 + (z1-z2)^2]$, where (x1, y1, z1) and (x2, y2, z2) are the coordinates of the extrapolated peak SAR locations in the zoom scan.
 - iii) If $SPLSR \leq 0.04$, simultaneously transmission SAR measurement is not necessary.
 - iv) Simultaneously transmission SAR measurement, and the reported multi-band SAR < 1.6W/kg.

14.1 Body Exposure Conditions

Exposure Position	1	2	3	4	5	1+2 Summed 1g SAR (W/kg)	3+4 Summed 1g SAR (W/kg)	1+5 Summed 1g SAR (W/kg)	3+5 Summed 1g SAR (W/kg)	3+4+5 Summed 1g SAR (W/kg)	SPLSR	Case No
	2.4GHz WLAN Ant 2	2.4GHz WLAN Ant 1	5GHz WLAN Ant 2	5GHz WLAN Ant 1	Bluetooth Ant 1							
	1g SAR (W/kg)	1g SAR (W/kg)	1g SAR (W/kg)	1g SAR (W/kg)	1g SAR (W/kg)							
Bottom Face at 0mm	0.254	0.318	0.224	0.228	0.023	0.572	0.452	0.277	0.247	0.475		
Edge 1 at 0mm	0.754	0.688	0.928	1.163	0.078	1.442	2.091	0.832	1.006	2.169	0.02	Case 1

14.2 SPLSR Evaluation and Analysis

General Note:

- SPLSR = $(SAR_1 + SAR_2)^{1.5} / (\text{min. separation distance, mm})$. If $SPLSR \leq 0.04$, simultaneously transmission SAR measurement is not necessary

Case 1	Band	Position	SAR (W/kg)	Gap (mm)	SAR peak location (mm)			3D distance (mm)	Summed SAR (W/kg)	SPLSR Results	Simultaneous SAR
					X	Y	Z				
	WLAN5GHz_Ant 2	Edge 1	0.928	0	2.4	-61.8	3.97	152.6	2.17	0.02	Not required
	WLAN5GHz_Ant 1 + BT_Ant 1		1.241	0	2.6	90.8	4.16				

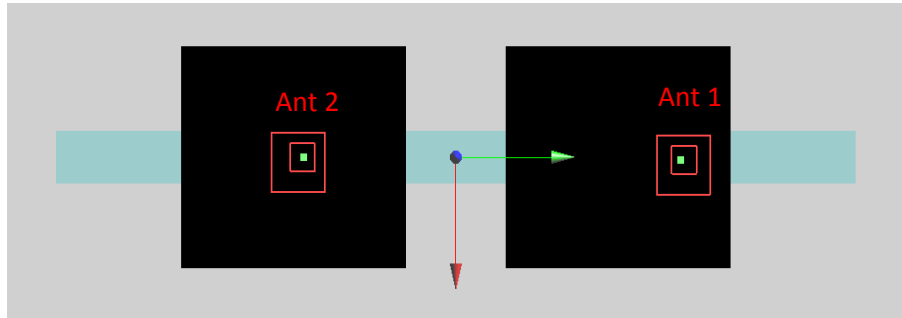

Test Engineer : Steven Chang and Ted Hsieh



15. Uncertainty Assessment

Per KDB 865664 D01 SAR measurement 100MHz to 6GHz, when the highest measured 1-g SAR within a frequency band is < 1.5 W/kg and the measured 10-g SAR within a frequency band is < 3.75 W/kg. The expanded SAR measurement uncertainty must be $\leq 30\%$, for a confidence interval of $k = 2$. If these conditions are met, extensive SAR measurement uncertainty analysis described in IEEE Std 1528-2013 is not required in SAR reports submitted for equipment approval. For this device, the highest measured 1-g SAR is less 1.5W/kg. Therefore, the measurement uncertainty table is not required in this report.

16. References

- [1] FCC 47 CFR Part 2 "Frequency Allocations and Radio Treaty Matters; General Rules and Regulations"
- [2] ANSI/IEEE Std. C95.1-1992, "IEEE Standard for Safety Levels with Respect to Human Exposure to Radio Frequency Electromagnetic Fields, 3 kHz to 300 GHz", September 1992
- [3] IEEE Std. 1528-2013, "IEEE Recommended Practice for Determining the Peak Spatial-Average Specific Absorption Rate (SAR) in the Human Head from Wireless Communications Devices: Measurement Techniques", Sep 2013
- [4] SPEAG DASY System Handbook
- [5] FCC KDB 248227 D01 v02r02, "SAR Guidance for IEEE 802.11 (WiFi) Transmitters", Oct 2015.
- [6] FCC KDB 447498 D01 v06, "Mobile and Portable Device RF Exposure Procedures and Equipment Authorization Policies", Oct 2015
- [7] FCC KDB 616217 D04 v01r02, "SAR Evaluation Considerations for Laptop, Notebook, Netbook and Tablet Computers", Oct 2015
- [8] FCC KDB 865664 D01 v01r04, "SAR Measurement Requirements for 100 MHz to 6 GHz", Aug 2015.
- [9] FCC KDB 865664 D02 v01r02, "RF Exposure Compliance Reporting and Documentation Considerations" Oct 2015.