



**FCC CFR47 PART 95H REQUIREMENT
CERTIFICATION TEST REPORT
FOR
MEDICAL TELEMETRY TRANSMITTER**

MODEL: ZM-940PA

FCC ID: B6BZS-940PA

REPORT NUMBER: 10J13419-1

ISSUE DATE: OCTOBER 18, 2010

**Prepared for
NIHON KOHDEN CORPORATION
1-31-4, NISHIOCHIAI SHINJUKU-KU
TOKYO 161-8560, JAPAN**

**Prepared by
COMPLIANCE CERTIFICATION SERVICES
47173 BENICIA STREET
FREMONT, CA 94538, U.S.A.
TEL: (510) 771-1000
FAX: (510) 661-0888**



NVLAP LAB CODE 200065-0

Revision History

<u>Rev.</u>	<u>Issue Date</u>	<u>Revisions</u>	<u>Revised By</u>
	10/18/10	Initial Issue	Thu Chan

TABLE OF CONTENTS

1. ATTESTATION OF TEST RESULTS	4
2. TEST METHODOLOGY	5
3. FACILITIES AND ACCREDITATION	5
4. CALIBRATION AND UNCERTAINTY	5
4.1. <i>MEASURING INSTRUMENT CALIBRATION</i>	5
4.2. <i>SAMPLE CALCULATION</i>	5
4.3. <i>MEASUREMENT UNCERTAINTY</i>	5
5. EQUIPMENT UNDER TEST	6
5.1. <i>DESCRIPTION OF EUT</i>	6
5.2. <i>DESCRIPTION OF CLASS II PERMISSIVE CHANGE</i>	6
5.3. <i>MAXIMUM OUTPUT POWER</i>	6
5.4. <i>DESCRIPTION OF AVAILABLE ANTENNAS</i>	6
5.5. <i>SOFTWARE AND FIRMWARE</i>	6
5.6. <i>WORST-CASE CONFIGURATION AND MODE</i>	6
5.7. <i>DESCRIPTION OF TEST SETUP</i>	7
6. TEST AND MEASUREMENT EQUIPMENT	9
7. RADIATED EMISSION TEST RESULTS	10
7.1. <i>FUNDAMENTAL OUTPUT POWER</i>	11
7.2. <i>RADIATED EMISSIONS BELOW 960 MHz</i>	12
7.3. <i>RADIATED EMISSIONS ABOVE 960 MHz</i>	19
8. SETUP PHOTOS	20

1. ATTESTATION OF TEST RESULTS

COMPANY NAME: NIHON KOHDEN CORPORATION
1-31-4, NISHIOCHIAI SHINJUKU-KU
TOKYO 161-8560, JAPAN

EUT DESCRIPTION: MEDICAL TELEMETRY TRANSMITTER

MODEL: ZS-940PA

SERIAL NUMBER: 00287

DATE TESTED: SEPTEMBER 24-25, 2010

APPLICABLE STANDARDS	
STANDARD	TEST RESULTS
FCC PART 95 SUBPART H	Pass

Compliance Certification Services, Inc. (CCS) tested the above equipment in accordance with the requirements set forth in the above standards. All indications of Pass/Fail in this report are opinions expressed by CCS based on interpretations and/or observations of test results. Measurement Uncertainties were not taken into account and are published for informational purposes only. The test results show that the equipment tested is capable of demonstrating compliance with the requirements as documented in this report.

Note: The results documented in this report apply only to the tested sample, under the conditions and modes of operation as described herein. This document may not be altered or revised in any way unless done so by CCS and all revisions are duly noted in the revisions section. Any alteration of this document not carried out by CCS will constitute fraud and shall nullify the document. This report must not be used by the client to claim product certification, approval, or endorsement by NVLAP, NIST, any agency of the Federal Government, or any agency of any government.

Approved & Released For CCS By:

Tested By:



THU CHAN
EMC MANAGER
COMPLIANCE CERTIFICATION SERVICES

CHIN PANG
EMC ENGINEER
COMPLIANCE CERTIFICATION SERVICES

2. TEST METHODOLOGY

The tests documented in this report were performed in accordance with ANSI/TIA-603-C-2004, FCC CFR 47 Part 2 and FCC CFR 47 Part 95.

3. FACILITIES AND ACCREDITATION

The test sites and measurement facilities used to collect data are located at 47173 Benicia Street, Fremont, California, USA.

CCS is accredited by NVLAP, Laboratory Code 200065-0. The full scope of accreditation can be viewed at <http://www.ccsemc.com>.

4. CALIBRATION AND UNCERTAINTY

4.1. MEASURING INSTRUMENT CALIBRATION

The measuring equipment utilized to perform the tests documented in this report has been calibrated in accordance with the manufacturer's recommendations, and is traceable to recognized national standards.

4.2. SAMPLE CALCULATION

Where relevant, the following sample calculation is provided:

$$\begin{aligned} \text{Field Strength (dBuV/m)} &= \text{Measured Voltage (dBuV)} + \text{Antenna Factor (dB/m)} + \\ &\text{Cable Loss (dB)} - \text{Preamp Gain (dB)} \\ 36.5 \text{ dBuV} + 18.7 \text{ dB/m} + 0.6 \text{ dB} - 26.9 \text{ dB} &= 28.9 \text{ dBuV/m} \end{aligned}$$

4.3. MEASUREMENT UNCERTAINTY

Where relevant, the following measurement uncertainty levels have been estimated for tests performed on the apparatus:

PARAMETER	UNCERTAINTY
Conducted Disturbance, 0.15 to 30 MHz	3.52 dB
Radiated Disturbance, 30 to 1000 MHz	4.94 dB

Uncertainty figures are valid to a confidence level of 95%.

5. EQUIPMENT UNDER TEST

5.1. DESCRIPTION OF EUT

- | | | |
|-----|----------------------------|---|
| a). | Type of EUT: | TELEMETRY MEDICAL TRANSMITTER |
| b). | Brand Name: | NIHON KOHDEN |
| c). | Model No: | ZS-940PA |
| d). | FCC ID: | B6BZM-940PA |
| e). | Battery Type: | Three AA (R6) |
| f). | Channel Number: | 608.0250 MHz (channel number 9002)
611.000MHz (Channel number 9240)
613.9750 MHz (channel number 9478) |
| g). | Frequency Range: | 608.025-613.975 MHz |
| h). | RF Conducted Output Power: | 1mW |
| i). | Channel Spacing: | 25kHz (12.5kHz when interleave) |
| j). | Type of Modulation: | F1D |
| k). | Antenna Type: | Internal |

5.2. DESCRIPTION OF CLASS II PERMISSIVE CHANGE

The major change filed under this application is changing the antenna.

5.3. MAXIMUM OUTPUT POWER

The test measurement passed within ± 0.5 dBm of the original output power.

5.4. DESCRIPTION OF AVAILABLE ANTENNAS

The radio utilizes a Helical Monopole antenna, with a maximum gain of 0 dBi.

5.5. SOFTWARE AND FIRMWARE

The test utility software used during testing was Channel Writer, rev. 02-01.

5.6. WORST-CASE CONFIGURATION AND MODE

The worst-case channel is determined as the channel with the highest output power.

During emission tests the antenna orientations as X, Y, and Z were investigated to determine the worst-case. The outcome showed that Y-orientation as the worst-case.

5.7. DESCRIPTION OF TEST SETUP

SUPPORT EQUIPMENT

PERIPHERAL SUPPORT EQUIPMENT LIST				
Description	Manufacturer	Model	Serial Number	FCC ID
Laptop	Lenovo	T61	L3-A1589	DoC
AC/DC Adapter	Lenovo	PA-1650-171	11S92P1160Z1ZBGH74LH2M	DoC
Channel Writer	Nihon Kohden	QI-901PK	28	N/A

I/O CABLES

I/O CABLE LIST						
Cable No.	Port	# of Identical Ports	Connector Type	Cable Type	Cable Length	Remarks
1	AC	1	US 115V	Un-shielded	2m	Connect Arm Cuff
2	Video	1	DB15	Shielded	1m	N/A
3	USB	1	USB	Un-shielded	1.2m	N/A
4	ECG	1	Channel Writer	Un-shielded	0.3m	N/A
5	NIBP	1	NIBP socket	Rubber	0.3 m	Connect Arm Cuff
6	ECG	1	ECG	Un-shielded	0.7 m	N/A
7	SpO2	1	SpO2	Un-shielded	1.6 m	Probe

TEST SETUP

The EUT is standalone unit and just use a host laptop computer to configure the mode during the tests. Test software exercised the radio card.

SETUP DIAGRAM FOR RADIATED TESTS

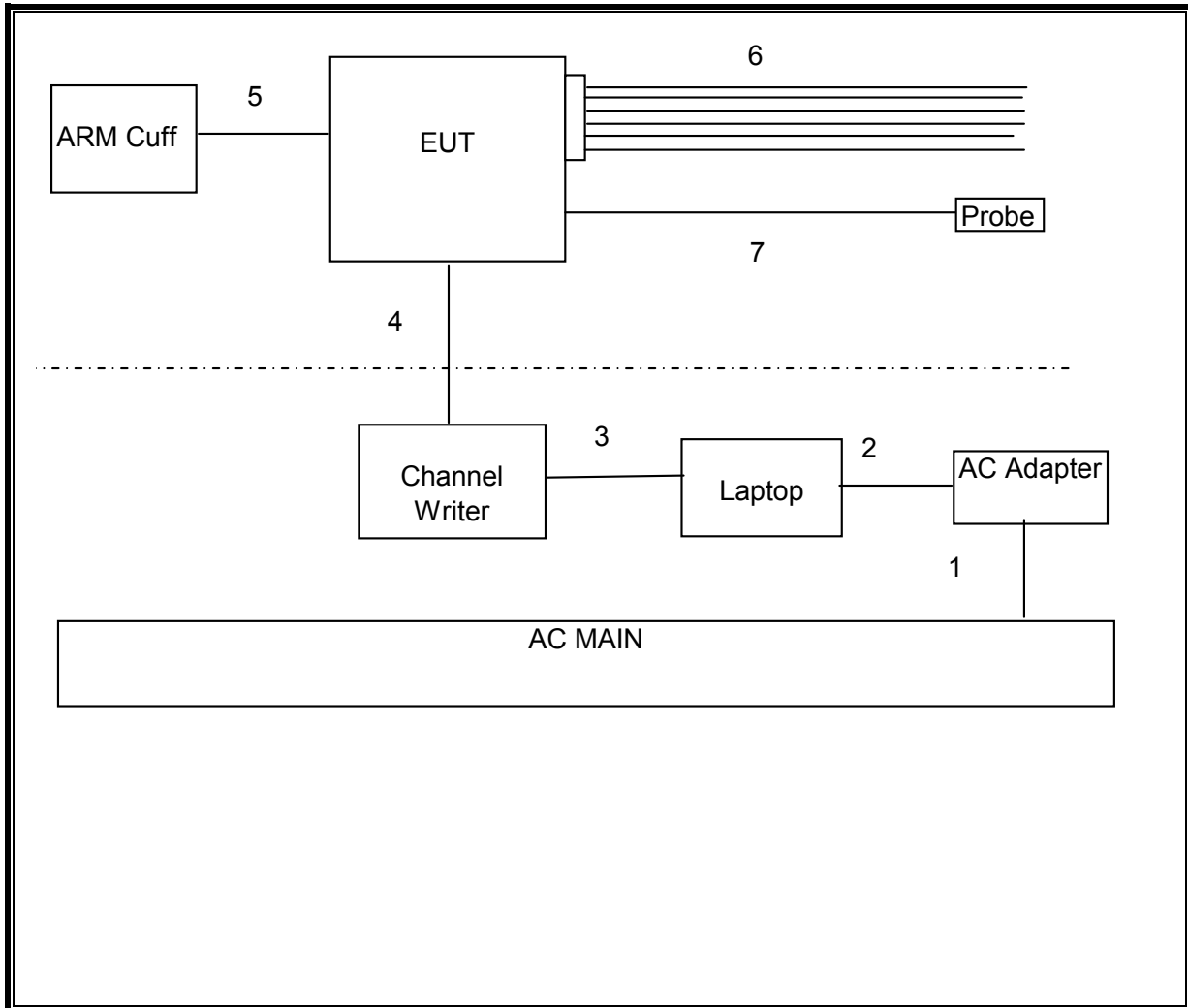

6. TEST AND MEASUREMENT EQUIPMENT

The following test and measurement equipment was utilized for the tests documented in this report:

TEST EQUIPMENT LIST				
Description	Manufacturer	Model	Asset	Cal Due
Spectrum Analyzer, 26.5 GHz	Agilent / HP	E4440A	C01176	8/102011
Preamplifier, 1300 MHz	Agilent / HP	8447D	C00778	01/16/11
Antenna, Bilog, 2 GHz	Sunol Sciences	JB1	C01011	07/12/11
Antenna, Horn, 18 GHz	EMCO	3115	C00783	06/29/11
Preamplifier, 26.5 GHz	Agilent / HP	8449B	C01063	07/14/11

7. RADIATED EMISSION TEST RESULTS

LIMITS

§95.115

(a) Field strength limits

(1) In the 608–614 MHz band, the maximum allowable field strength is 200 mV/m, as measured at a distance of 3 meters, using measuring instrumentation with a CISPR quasi-peak detector.

(b) Undesired emissions.

(1) Out-of-band emissions below 960 MHz are limited to 200 microvolts/meter, as measured at a distance of 3 meters, using measuring instrumentation with a CISPR quasi-peak detector.

(2) Out-of-band emissions above 960 MHz are limited to 500 microvolts/meter as measured at a distance of 3 meters, using measuring equipment with an averaging detector and a 1 MHz measurement bandwidth.

TEST PROCEDURE

ANSI/TIA-603-C-2004

RESULTS

7.1. FUNDAMENTAL OUTPUT POWER

30-1000MHz Frequency Measurement													
Compliance Certification Services, Fremont 5m Chamber													
Company:		Nihon Kohden											
EUT Description:		Medical Telemetry Transmitter											
Project #:		10J13419											
Date:		9/24/2010											
Test Engineer:		Chin Pang											
Configuration:		EUT Only											
Model:		ZM-940PA											
Mode:		TX											
f	Measurement Frequency	Amp	Preamp Gain	Margin	Margin vs. Limit								
Dist	Distance to Antenna	D Corr	Distance Correct to 3 meters										
Read	Analyzer Reading	Filter	Filter Insert Loss										
AF	Antenna Factor	Corr.	Calculated Field Strength										
CL	Cable Loss	Limit	Field Strength Limit										
f	Dist	Read	AF	CL	Amp	D Corr	Pad	Corr.	Limit	Margin	Ant. Pol	Det.	Notes
MHz	(m)	dBuV	dB/m	dB	dB	dB	dB	dBuV/m	dBuV/m	dB	V/H	P/A/QP	
608.025	3.0	96.8	18.3	2.4	29.6	0.0	0.0	87.9	106.0	-18.1	V	P	
608.025	3.0	106.0	18.3	2.4	29.6	0.0	0.0	97.1	106.0	-8.9	H	P	
611.00	3.0	96.2	18.4	2.4	29.6	0.0	0.0	87.4	106.0	-18.6	V	P	
611.00	3.0	104.0	18.4	2.4	29.6	0.0	0.0	95.2	106.0	-10.8	H	P	
613.975	3.0	98.7	18.4	2.4	29.6	0.0	0.0	89.8	106.0	-16.2	V	P	
613.975	3.0	103.0	18.4	2.4	29.6	0.0	0.0	94.2	106.0	-11.8	H	P	

7.2. RADIATED EMISSIONS BELOW 960 MHz

Note 1: The measurements in this section show that Peak values are less than the Quasi-Peak limit.

Note 2: Plots in the range of 960 to 1000 MHz in this section are shown for reporting purposes only.

SPURIOUS EMISSIONS 30 TO 960 MHz (DATA)

608.025MHz

30-1000MHz Frequency Measurement													
Compliance Certification Services, Fremont 5m Chamber													
Test Engr:		Chin Pang											
Date:		09/24/10											
Project #:		10J13419											
Company:		Nihon Kohden											
EUT Description:		Medical Telemetry Transmitter											
Test Target:		FCC Part 95H											
Model:		ZS-940PA											
Mode Oper:		TX, 608.025MHz											
f	Measurement Frequency	Amp	Preamp Gain		Margin	Margin vs. Limit							
Dist	Distance to Antenna	D Corr	Distance Correct to 3 meters										
Read	Analyzer Reading	Filter	Filter Insert Loss										
AF	Antenna Factor	Corr.	Calculated Field Strength										
CL	Cable Loss	Limit	Field Strength Limit										
f	Dist	Read	AF	CL	Amp	D Corr	Pad	Corr.	Limit	Margin	Ant. Pol.	Det.	Notes
MHz	(m)	dBuV	dB/m	dB	dB	dB	dB	dBuV/m	dBuV/m	dB	V/H	P/A/QP	
vert													
97.683	3.0	41.1	9.5	0.9	29.5	0.0	0.0	22.0	46.0	-24.0	V	P	
144.965	3.0	35.8	12.9	1.1	29.3	0.0	0.0	20.5	46.0	-25.5	V	P	
195.367	3.0	35.8	11.6	1.3	28.9	0.0	0.0	19.8	46.0	-26.2	V	P	
468.498	3.0	34.2	16.2	2.1	29.6	0.0	0.0	22.9	46.0	-23.1	V	P	
128.644	3.0	34.0	13.7	1.0	29.4	0.0	0.0	19.4	46.0	-26.6	H	P	
138.244	3.0	34.6	13.3	1.1	29.4	0.0	0.0	19.6	46.0	-26.4	H	P	
595.223	3.0	36.7	18.2	2.4	29.6	0.0	0.0	27.7	46.0	-18.3	H	P	

SPURIOUS EMISSIONS 30 TO 960 MHz (PLOTS)

608.025MHz

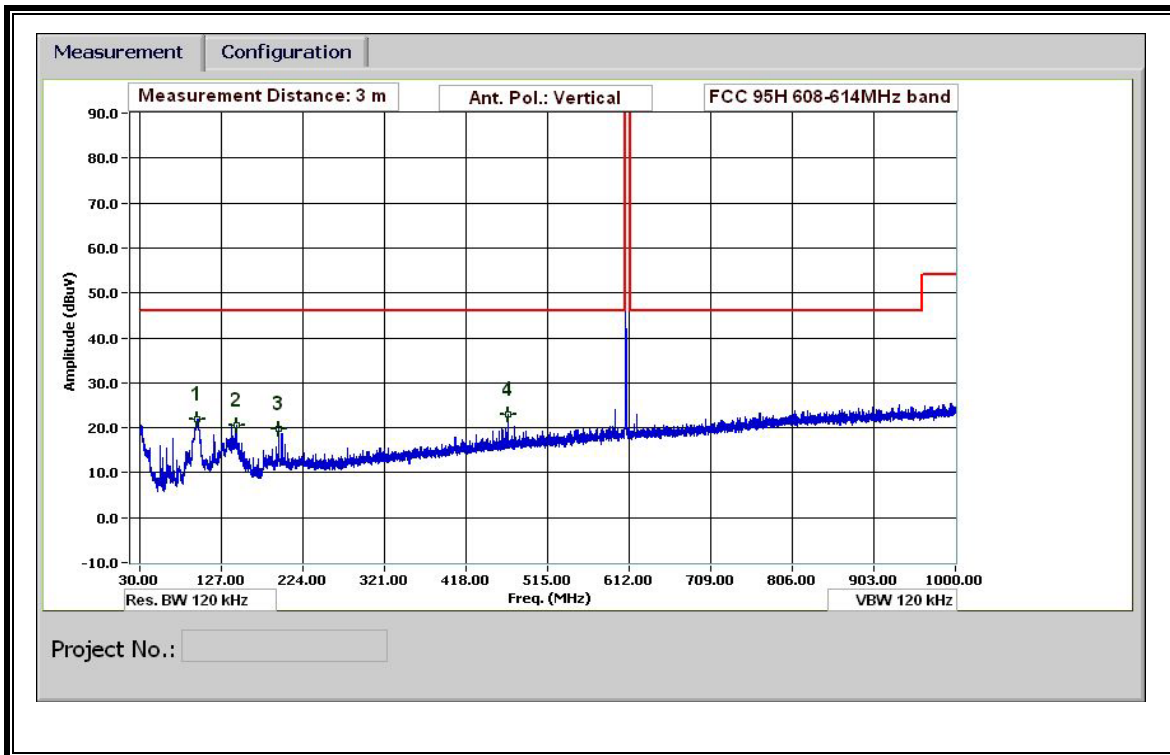
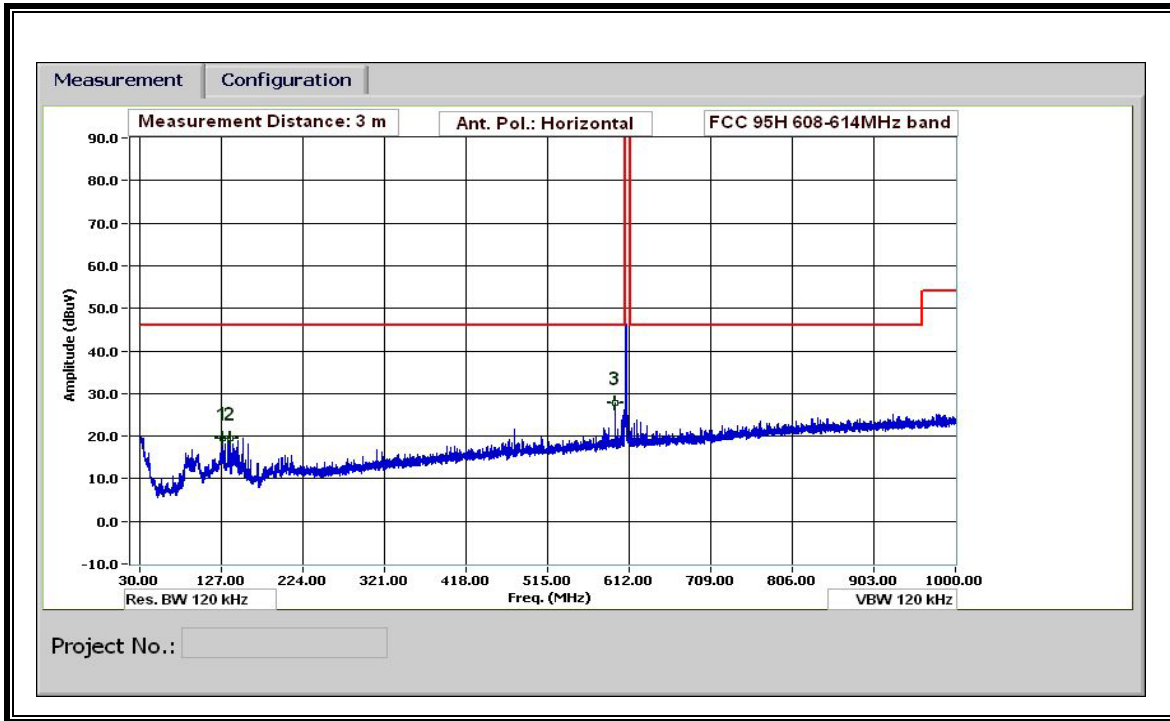

SPURIOUS EMISSIONS 30 TO 960 MHz (DATA)

611.000MHz

30-1000MHz Frequency Measurement													
Compliance Certification Services, Fremont 5m Chamber													
Test Engr:		Chin Pang											
Date:		09/24/10											
Project #:		10J13419											
Company:		Nihon Kohden											
EUT Description:		Medical Telemetry Transmitter											
Test Target:		FCC Part 95H											
Model:		ZS-940PA											
Mode Oper:		TX, 611MHz											
f	Measurement Frequency	Amp	Preamp Gain	Margin	Margin vs. Limit								
Dist	Distance to Antenna	D Corr	Distance Correct to 3 meters										
Read	Analyzer Reading	Filter	Filter Insert Loss										
AF	Antenna Factor	Corr.	Calculated Field Strength										
CL	Cable Loss	Limit	Field Strength Limit										
f	Dist	Read	AF	CL	Amp	D Corr	Pad	Corr.	Limit	Margin	Ant. Pol.	Det.	Notes
MHz	(m)	dBuV	dB/m	dB	dB	dB	dB	dBuV/m	dBuV/m	dB	V/H	P/A/QP	
vert													
55.801	3.0	38.0	7.9	0.6	29.6	0.0	0.0	16.9	46.0	-29.1	V	P	
136.204	3.0	32.8	13.4	1.0	29.4	0.0	0.0	17.8	46.0	-28.2	V	P	
598.223	3.0	35.5	18.2	2.4	29.6	0.0	0.0	26.5	46.0	-19.5	V	P	
117.124	3.0	39.9	13.2	1.0	29.5	0.0	0.0	24.6	46.0	-21.4	H	P	
145.685	3.0	36.1	12.9	1.1	29.3	0.0	0.0	20.8	46.0	-25.2	H	P	
483.859	3.0	33.7	16.5	2.1	29.7	0.0	0.0	22.7	46.0	-23.3	H	P	

SPURIOUS EMISSIONS 30 TO 960 MHz (PLOTS)

611MHz

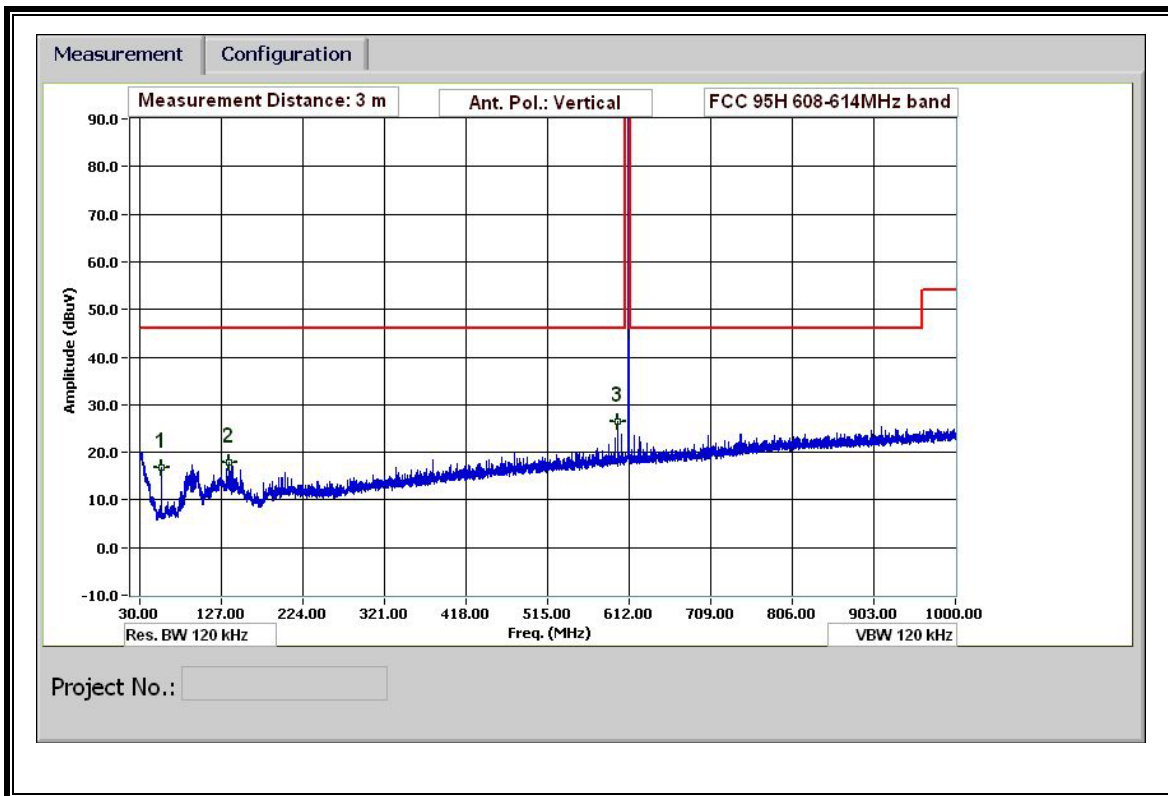
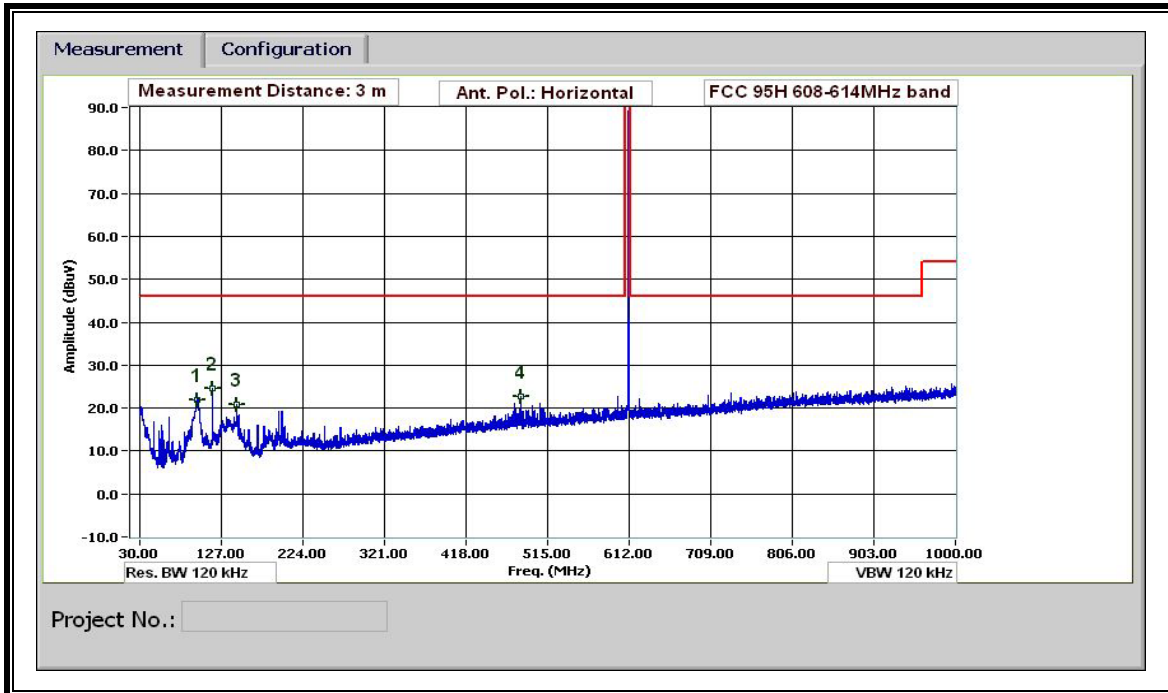

SPURIOUS EMISSIONS 30 TO 960 MHz

613.975MHz

30-1000MHz Frequency Measurement													
Compliance Certification Services, Fremont 5m Chamber													
Test Engr:		Chin Pang											
Date:		09/24/10											
Project #:		10J13419											
Company:		Nihon Kohden											
EUT Description:		Medical Telemetry Transmitter											
Test Target:		FCC Part 95H											
Model:		ZS-940PA											
Mode Oper:		TX, 613.975MHz											
f	Measurement Frequency	Amp	Preamp Gain	Margin	Margin vs. Limit								
Dist	Distance to Antenna	D Corr	Distance Correct to 3 meters										
Read	Analyzer Reading	Filter	Filter Insert Loss										
AF	Antenna Factor	Corr.	Calculated Field Strength										
CL	Cable Loss	Limit	Field Strength Limit										
f	Dist	Read	AF	CL	Amp	D Corr	Pad	Corr.	Limit	Margin	Ant. Pol.	Det.	Notes
MHz	(m)	dBuV	dB/m	dB	dB	dB	dB	dBuV/m	dBuV/m	dB	V/H	P/A/QP	
vert													
148.685	3.0	36.1	12.7	1.1	29.3	0.0	0.0	20.6	46.0	-25.4	V	P	
482.899	3.0	33.2	16.5	2.1	29.7	0.0	0.0	22.2	46.0	-23.8	V	P	
601.104	3.0	35.5	18.3	2.4	29.6	0.0	0.0	26.5	46.0	-19.5	V	P	
99.603	3.0	41.1	10.0	0.9	29.5	0.0	0.0	22.4	46.0	-23.6	H	P	
195.367	3.0	36.3	11.6	1.3	28.9	0.0	0.0	20.3	46.0	-25.7	H	P	
505.94	3.0	33.9	16.9	2.2	29.7	0.0	0.0	23.2	46.0	-22.8	H	P	

SPURIOUS EMISSIONS 30 TO 960 MHz (PLOTS)

613.975MHz

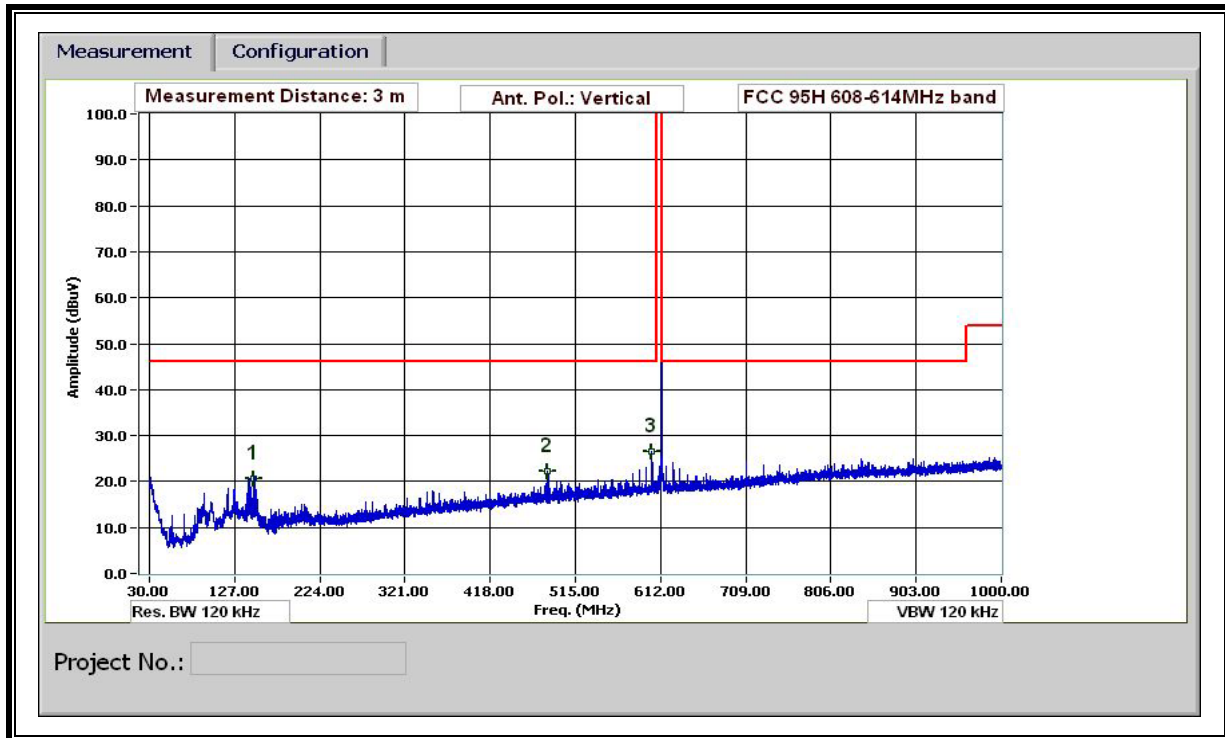
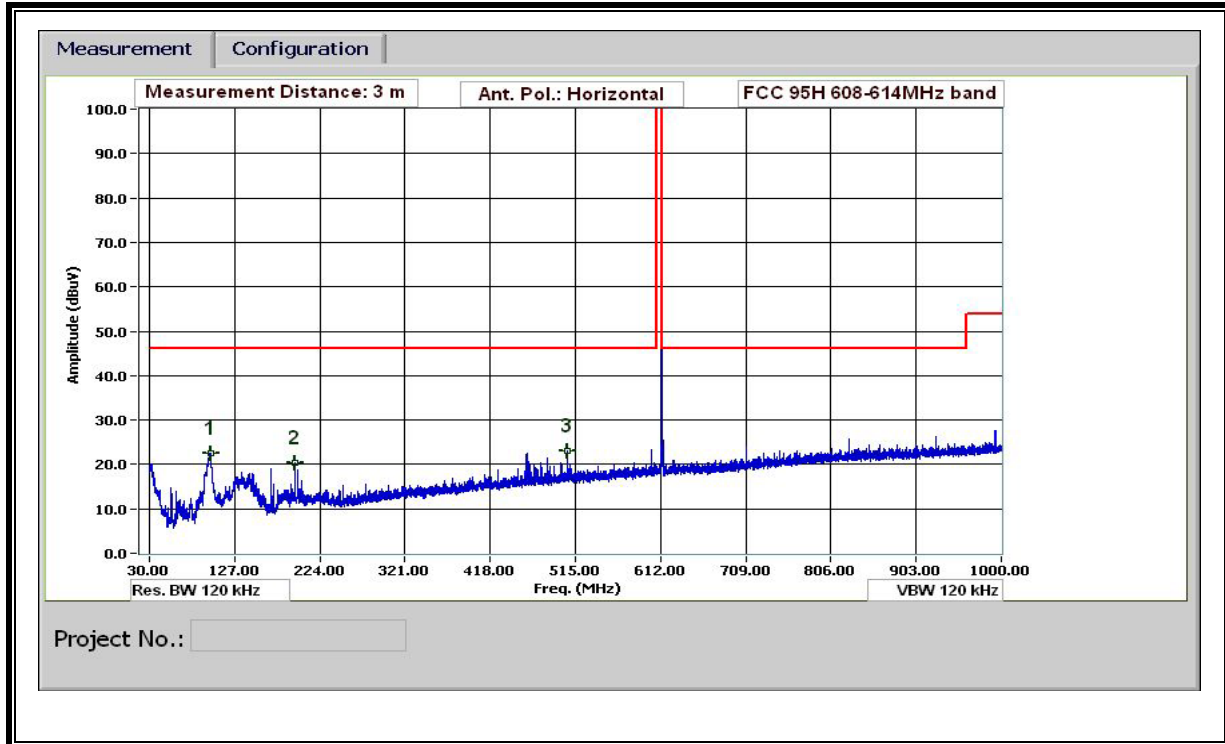

7.3. RADIATED EMISSIONS ABOVE 960 MHz

HARMONICS AND TX SPURIOUS EMISSIONS ABOVE 960 MHz

High Frequency Measurement
 Compliance Certification Services, Fremont 5m Chamber

Company: Nihon Kohden
 EUT Description: Medical Telemetry Transmitter
 Project #: 10J13419
 Date: 09/25/10
 Test Engineer: Chin Pang
 Configuration: EUT Only
 Model: ZS-940PA
 Mode: TX

Test Equipment:

Horn 1-18GHz	Pre-amplifier 1-26GHz	Pre-amplifier 26-40GHz	Horn > 18GHz	Limit
T59; S/N: 3245 @3m	T145 Agilent 3008A0056			FCC 15.209

Hi Frequency Cables

3' cable 22807700	12' cable 22807600	20' cable 22807500	HPF	Reject Filter	Peak Measurements RBW=VBW=1MHz
3' cable 22807700	12' cable 22807600	20' cable 22807500			Average Measurements RBW=1MHz; VBW=10Hz

f GHz	Dist (m)	Read dBuV	AF dB/m	CL dB	Amp dB	D Corr dB	Fltr dB	Corr. dBuV/m	Avg Lim dBuV/m	Det. P/A/QP	Margin dB	Notes (V/H)
Low CH 608.025 MHz												
1.216	3.0	47.9	24.7	2.6	-36.0	0.0	0.0	39.3	54	A	-14.7	V
1.824	3.0	41.0	27.0	3.3	-35.5	0.0	0.0	35.7	54	A	-18.3	V
3.040	3.0	40.0	30.1	4.4	-35.2	0.0	0.0	39.3	54	A	-14.7	V
1.216	3.0	43.5	24.7	2.6	-36.0	0.0	0.0	34.9	54	A	-19.1	H
1.824	3.0	40.7	27.0	3.3	-35.5	0.0	0.0	35.4	54	A	-18.6	H
3.040	3.0	40.2	30.1	4.4	-35.2	0.0	0.0	39.5	54	A	-14.5	H
Mid CH 611.000 MHz												
1.222	3.0	47.6	24.8	2.6	-36.0	0.0	0.0	39.0	54	A	-15.0	V
1.833	3.0	40.3	27.0	3.3	-35.5	0.0	0.0	35.1	54	A	-18.9	V
3.055	3.0	42.0	30.1	4.4	-35.2	0.0	0.0	41.3	54	A	-12.7	V
1.222	3.0	45.4	24.8	2.6	-36.0	0.0	0.0	36.8	54	A	-17.2	H
1.833	3.0	40.6	27.0	3.3	-35.5	0.0	0.0	35.4	54	A	-18.6	H
3.055	3.0	43.1	30.1	4.4	-35.2	0.0	0.0	42.4	54	A	-11.6	H
Hi CH 613.975 MHz												
1.228	3.0	46.8	24.8	2.6	-36.0	0.0	0.0	38.2	54	A	-15.8	V
1.842	3.0	40.6	27.0	3.3	-35.5	0.0	0.0	35.4	54	A	-18.6	V
3.061	3.0	43.8	30.2	4.4	-35.2	0.0	0.0	43.2	54	A	-10.8	V
1.228	3.0	45.0	24.8	2.6	-36.0	0.0	0.0	36.4	54	A	-17.6	H
1.842	3.0	40.2	27.0	3.3	-35.5	0.0	0.0	35.0	54	A	-19.0	H
3.061	3.0	44.0	30.2	4.4	-35.2	0.0	0.0	43.4	54	A	-10.6	H

Note: No other emissions were detected above the system noise floor.
 Rev. 11.10.08

f	Amp	Preamp Gain	Avg Lim	Average Field Strength Limit
Dist	D Corr	Distance Correct to 3 meters	Pk Lim	Peak Field Strength Limit
Read	Avg	Average Field Strength @ 3	Avg Mar	Margin vs. Average Limit
AF	Peak	Calculated Peak Field Streng	Pk Mar	Margin vs. Peak Limit
CL	HPF	High Pass Filter		

8. SETUP PHOTOS

RADIATED EMISSION FOR PORTABLE CONFIGURATION

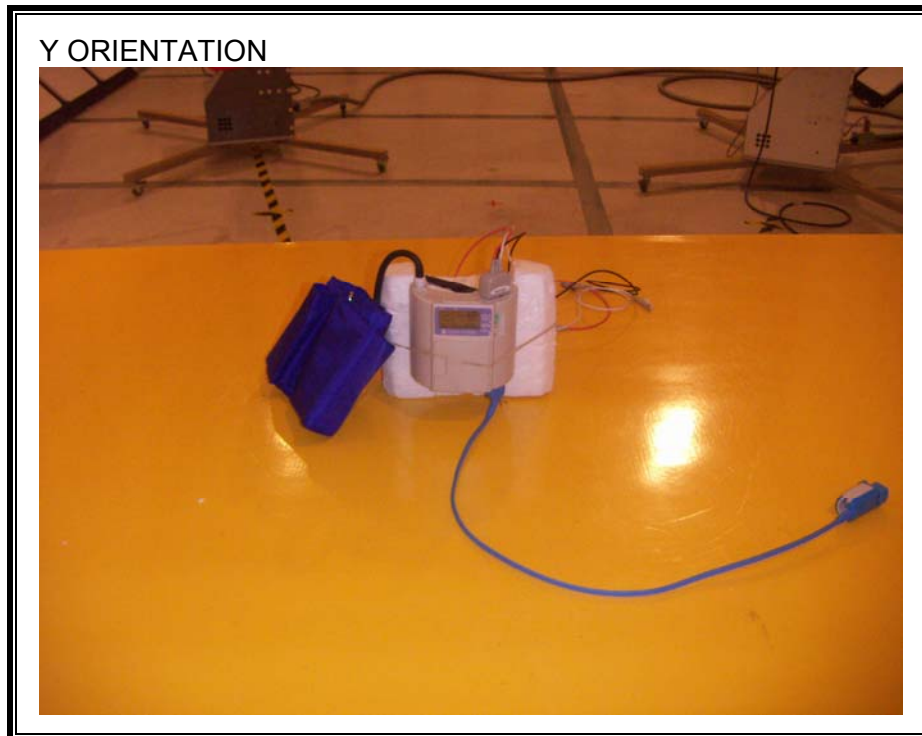
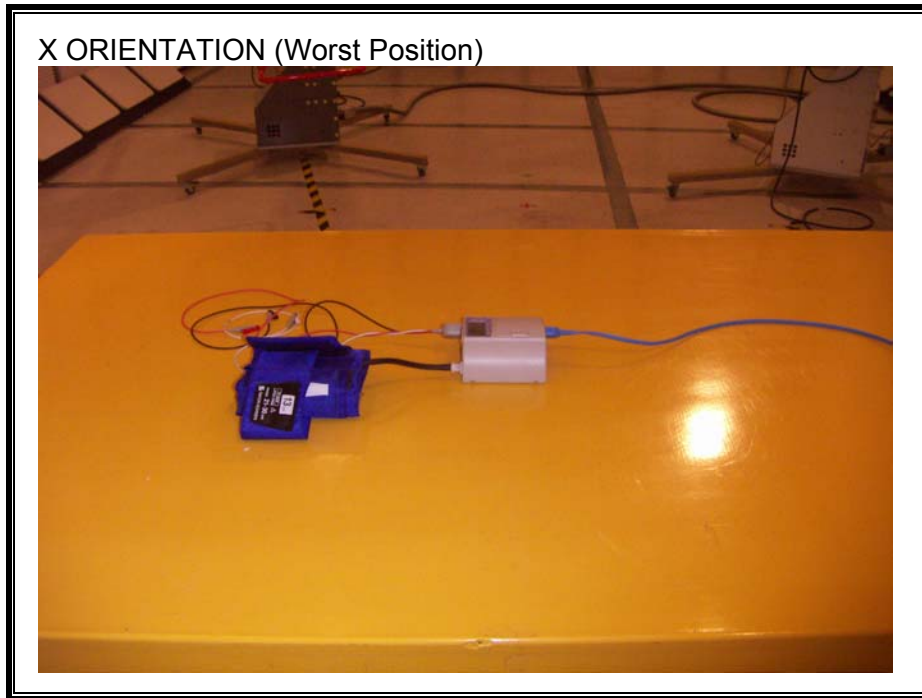

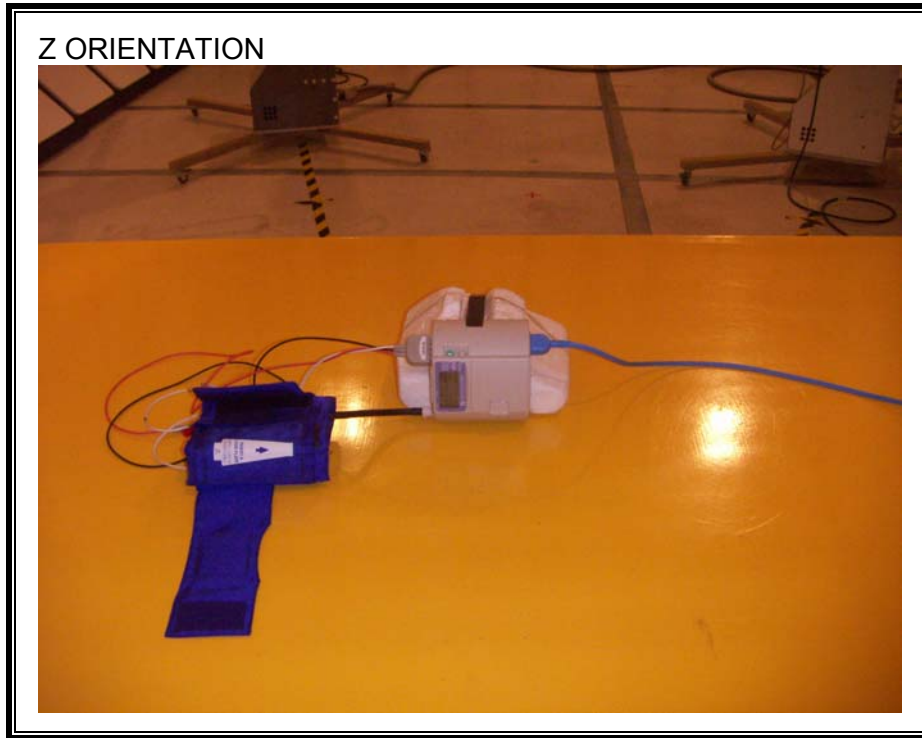

END OF REPORT