

# Operator's Manual

## Transmitter

ZM-540PA

ZM-541PA



## About This Manual

In order to use this product safely and fully understand all its functions, read this manual before using the product. Keep this manual near the instrument or in the reach of the operator and refer to it whenever the operation is unclear.

The manual is only included on the CD. We recommend printing a copy of the electronic data for reference in case of emergency. If you require printed version of the manual, contact your Nihon Kohden representative.

---

### Copyright Notice

The entire contents of this manual are copyrighted by Nihon Kohden. All rights are reserved. No part of this document may be reproduced, stored, or transmitted in any form or by any means (electronic, mechanical, photocopied, recorded, or otherwise) without the prior written permission of Nihon Kohden.

---

This product stores personal patient information. Manage the information appropriately. Patient names on the screen shots and recording examples in this manual are fictional and any resemblance to any person living or dead is purely coincidental. The contents of this manual are subject to change without notice. If you have any comments or suggestions on this manual, please contact us at: <https://www.nihonkohden.com/>

# Contents

Unpacking.....	i
GENERAL HANDLING PRECAUTIONS.....	I
WARRANTY POLICY.....	II
Equipment Authorization Requirement.....	III
EMC RELATED CAUTION .....	IV
Conventions Used in this Manual and Instrument.....	VI
Explanations of the Symbols in this Manual and Instrument .....	VII
Intended Use .....	1
General .....	1
Receiving Monitor .....	3
Panel Description .....	4
Front Panel .....	4
Rear Panel.....	6
Top Panel.....	7
Bottom Panel .....	7
Important Safety Information .....	9
General .....	9
Output Signal .....	15
Battery .....	15
Transmitter Channel Management .....	16
For Patients Using Implantable Pacemaker .....	16
ECG Monitoring .....	17
SpO <sub>2</sub> Monitoring.....	18
NIBP Monitoring.....	22
Maintenance .....	26
Preparation on Transmitter .....	27
Batteries.....	27
Handling Batteries .....	27
Battery Lifetime.....	27
Installing and Replacing Batteries .....	28
Situations Requiring Battery Replacement .....	29
Battery Level Indication .....	30
Turning On the Transmitter .....	31
Check Items Before Use.....	32
Check Items After Power On .....	32
Check Items After Use.....	33

Turning Off the Transmitter .....	33
Changing the Transmitter Channel .....	34
Changing Parameter and System Setup Settings .....	35
Notes on Parameter Settings.....	35
Changing PARAMETER SETUP Settings .....	36
Parameter Setup Setting List.....	36
Displaying the PARAMETER SETUP Screen.....	37
Changing Parameter Setup Settings .....	38
Changing SYSTEM SETUP Settings.....	44
System Setup Setting List.....	44
Displaying the SYSTEM SETUP Screen .....	45
Changing System Setup Settings .....	46
Initializing Settings .....	50
Attaching Electrodes, SpO <sub>2</sub> Probe and NIBP Cuff to the Patient .....	51
Attachment Example.....	51
Selecting Electrode Leads .....	52
Connecting the Electrode Lead to the Transmitter.....	52
Electrode Position.....	53
Attaching Electrodes to the Patient and Connecting the Electrode Leads to Disposable Electrodes.....	56
Checking ECG on the Transmitter Screen .....	57
Attaching the SpO <sub>2</sub> Probe.....	58
Selecting the SpO <sub>2</sub> Probe .....	58
Connecting the SpO <sub>2</sub> Probe to the Transmitter .....	61
Attaching the Probe to the Patient.....	62
Attaching the NIBP Cuff.....	64
Selecting the NIBP Cuff.....	64
Connecting the NIBP Cuff to the Transmitter .....	67
Attaching the NIBP Cuff to the Patient .....	67
Locking the Keys on the Transmitter .....	70
Monitoring.....	71
Screen Descriptions.....	71
Check Electrodes Screen .....	72
Numeric and Waveform Screen.....	73
Waveform Review Screen .....	74
Numeric Review Screen .....	75
Display Off .....	75
Basic Monitoring Operation .....	76
Using the Function Key.....	76
Suspending Alarms on the Receiving Monitor .....	77
Pausing Monitoring .....	78
Resuming Monitoring after Pause .....	80

Confirming the Patient .....	80
Turning the Display Off .....	81
Turning the Display On after It was Turned Off .....	82
ECG and Respiration Monitoring .....	82
Turning ECG Measurement On/Off .....	85
Turning Respiration Measurement On/Off.....	85
Electrode Detachment .....	85
SpO <sub>2</sub> Monitoring.....	86
Monitoring SpO <sub>2</sub> during NIBP Measurement.....	91
NIBP Monitoring.....	92
Selecting the Initial Cuff Inflation Pressure.....	92
Selecting the Measurement Mode and Interval.....	92
Measuring NIBP .....	94
Monitoring SpO <sub>2</sub> during NIBP Measurement.....	99
Indication and Message List.....	100
Indication .....	100
Messages .....	100
Message Display Priority .....	104
Troubleshooting .....	105
Transmitter.....	105
ECG/Respiration.....	106
SpO <sub>2</sub> .....	107
NIBP.....	107
Maintenance .....	109
1. External Check .....	110
2. Transmitter Channel .....	110
3. Transmitting/Receiving Signal .....	110
4. Display .....	111
5. Key Operation.....	112
6. ECG Check.....	113
7. Respiration Check .....	114
8. SpO <sub>2</sub> Check .....	114
With the AX-300T SpO <sub>2</sub> Checker .....	114
With the AX-410G Medical Instrument Checker.....	115
9. NIBP Check .....	116
10. NIBP Cuff for Attaching Transmitter to Patient Arm .....	119
Lifetime and Disposal .....	120
Disposing of Used Batteries .....	120
Battery Lifetime.....	120
Disposal .....	120
Disposing of Electrodes, SpO <sub>2</sub> Probes and NIBP Cuffs.....	120
Disposing of Transmitter .....	120



Cleaning, Disinfection and Sterilization .....	121
Transmitter and Electrode Leads .....	121
Cleaning .....	121
Disinfection .....	122
SpO <sub>2</sub> Probe .....	122
NIBP Cuff .....	122
Periodic Inspection .....	123
Repair Parts Availability Policy .....	123
Specifications .....	124
ZM-540PA .....	124
Measured Parameters .....	124
Transmitted Data.....	124
Display .....	124
Displayed Data.....	124
ECG .....	124
ECG Display and Heart Rate Count .....	125
Respiration Measurement.....	125
SpO <sub>2</sub> Measurement (ISO 9919: 2005 compliant) .....	125
Noninvasive Blood Pressure, NIBP (IEC 60601-2-30: 1999 compliant) .....	127
Transmitter .....	128
Power Requirements .....	128
Dimensions and Weight.....	128
Environment.....	128
Safety Standards .....	129
Electromagnetic Compatibility .....	129
Electromagnetic Emissions .....	130
Electromagnetic Immunity .....	131
Recommended Separation Distances between Portable and Mobile RF Communications Equipment .....	133
Recovery Time after Defibrillation .....	133
System Composition for EMC Test.....	133
ZM-541PA.....	134
Measured Parameters .....	134
Transmitted Data.....	134
Display .....	134
Displayed Data.....	134
ECG .....	134
Respiration Measurement.....	135
SpO <sub>2</sub> Measurement (ISO 9919: 2005 compliant) .....	135
Noninvasive Blood Pressure, NIBP (IEC 60601-2-30: 1999 compliant) .....	137

Transmitter .....	137
Power Requirements .....	138
Dimensions and Weight.....	138
Environment.....	138
Safety Standards .....	138
Electromagnetic Compatibility .....	139
Electromagnetic Emissions .....	139
Electromagnetic Immunity .....	140
Recommended Separation Distances between Portable and Mobile RF Communications Equipment .....	142
Recovery Time after Defibrillation .....	142
System Composition for EMC Test.....	142
Replaceable Part.....	143
Options .....	143
Transmitter.....	143
ECG/RESP .....	144
SpO <sub>2</sub> .....	144
NIBP.....	145
Transmission Frequencies .....	146

# Unpacking

Check that all the items are included in the package. If there are any missing items, contact your Nihon Kohden representative.

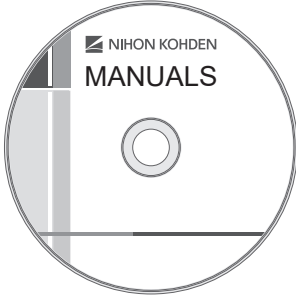
The name and quantity are described under the illustration.

 <p>ZM-540PA or ZM-541PA transmitter (1)</p>	 <p>Manuals CD (1)</p>	 <p>Certification (1)</p>
---	---	--



## GENERAL HANDLING PRECAUTIONS

This device is intended for use only by qualified medical personnel.

Use only Nihon Kohden approved products with this device. Use of non-approved products or in a non-approved manner may affect the performance specifications of the device. This includes, but is not limited to, batteries, recording paper, pens, extension cables, electrode leads, input boxes and AC power.

**Please read these precautions thoroughly before attempting to operate the instrument.**

- 1. To safely and effectively use the instrument, its operation must be fully understood.**
- 2. When installing or storing the instrument, take the following precautions.**
  - (1) Avoid moisture or contact with water, extreme atmospheric pressure, excessive humidity and temperatures, poorly ventilated areas, and dust, saline or sulphuric air.
  - (2) Place the instrument on an even, level floor. Avoid vibration and mechanical shock, even during transport.
  - (3) Avoid placing in an area where chemicals are stored or where there is danger of gas leakage.
  - (4) The power line source to be applied to the instrument must correspond in frequency and voltage to product specifications, and have sufficient current capacity.
  - (5) Choose a room where a proper grounding facility is available.
- 3. Before Operation**
  - (1) Check that the instrument is in perfect operating order.
  - (2) Check that the instrument is grounded properly.
  - (3) Check that all cords are connected properly.
  - (4) Pay extra attention when the instrument is in combination with other instruments to avoid misdiagnosis or other problems.
  - (5) All circuitry used for direct patient connection must be doubly checked.
  - (6) Check that battery level is acceptable and battery condition is good when using battery operated models.
- 4. During Operation**
  - (1) Both the instrument and the patient must receive continual, careful attention.
  - (2) Turn power off or remove electrodes and/or transducers when necessary to assure the patient's safety.
  - (3) Avoid direct contact between the instrument housing and the patient.
- 5. To Shutdown After Use**
  - (1) Turn power off with all controls returned to their original positions.
  - (2) Remove the cords gently; do not use force to remove them.
  - (3) Clean the instrument together with all accessories for their next use.
- 6. The instrument must receive expert, professional attention for maintenance and repairs. When the instrument is not functioning properly, it should be clearly marked to avoid operation while it is out of order.**
- 7. The instrument must not be altered or modified in any way.**

## 8. Maintenance and Inspection

- (1) The instrument and parts must undergo regular maintenance inspection at the interval which is specified after the GENERAL HANDLING PRECAUTIONS section.
- (2) If stored for extended periods without being used, make sure prior to operation that the instrument is in perfect operating condition.
- (3) Technical information such as parts list, descriptions, calibration instructions or other information is available for qualified user technical personnel upon request from your Nihon Kohden representative.

**9. When the instrument is used with an electrosurgical instrument, pay careful attention to the application and/or location of electrodes and/or transducers to avoid possible burn to the patient.**

**10. When the instrument is used with a defibrillator, make sure that the instrument is protected against defibrillator discharge. If not, remove patient cables and/or transducers from the instrument to avoid possible damage.**

## WARRANTY POLICY

Nihon Kohden Corporation (NKC) shall warrant its products against all defects in materials and workmanship for one year from the date of delivery. However, consumable materials such as recording paper, ink, stylus and battery are excluded from the warranty.

NKC or its authorized agents will repair or replace any products which prove to be defective during the warranty period, provided these products are used as prescribed by the operating instructions given in the operator's and service manuals.

No other party is authorized to make any warranty or assume liability for NKC's products.

NKC will not recognize any other warranty, either implied or in writing. In addition, service, technical modification or any other product change performed by someone other than NKC or its authorized agents without prior consent of NKC may be cause for voiding this warranty.

Defective products or parts must be returned to NKC or its authorized agents, along with an explanation of the failure. Shipping costs must be pre-paid.

This warranty does not apply to products that have been modified, disassembled, reinstalled or repaired without Nihon Kohden approval or which have been subjected to neglect or accident, damage due to accident, fire, lightning, vandalism, water or other casualty, improper installation or application, or on which the original identification marks have been removed.

In the USA and Canada other warranty policies may apply.

### CAUTION

United States law restricts this device to sale by or on the order of a physician.

## Equipment Authorization Requirement

### Compliance with FCC Requirements

This device complies with Part 15 of the FCC (Federal Communications Commission) Rules. Operation is subject to the following two conditions:

- (1) this device may not cause harmful interference, and
- (2) this device must accept any interference received, including interference that may cause undesired operation.

This device complies with Part 95 Subpart H of the FCC Rules to be used in wireless medical telemetry service.

Operation of this equipment requires the prior coordination with a frequency coordinator designated by FCC for the Wireless Medical Telemetry Service.

#### **CAUTION**

To comply with the FCC radio frequency (RF) exposure compliance requirements, no change to the antenna or the device is permitted. Any change to the antenna or the device could result in the device, exceeding the RF exposure requirements and void user's authority to operate this device.

- NOTE**
- Use this device only indoors.
  - This equipment complies with FCC radiation exposure limits set forth for an uncontrolled environment and meets the FCC radio frequency (RF) Exposure Guidelines as this equipment has very low levels of RF energy. This transmitter must not be co-located or operated in conjunction with any other antenna or transmitter.
  - The devices require registration and deployment by an authorized frequency coordinator. The ASHE (American Society for Healthcare Engineering) has been designated by the FCC to manage the WMTS frequencies. This device has frequency bands which may not be used in some areas. For details, contact your Nihon Kohden representative. For details on the guidelines, refer to the ASHE home page.

## EMC RELATED CAUTION

This equipment and/or system complies with IEC 60601-1-2 International Standard for electromagnetic compatibility for medical electrical equipment and/or system. However, an electromagnetic environment that exceeds the limits or levels stipulated in IEC 60601-1-2, can cause harmful interference to the equipment and/or system or cause the equipment and/or system to fail to perform its intended function or degrade its intended performance. Therefore, during the operation of the equipment and/or system, if there is any undesired deviation from its intended operational performance, you must avoid, identify and resolve the adverse electromagnetic effect before continuing to use the equipment and/or system.

The following describes some common interference sources and remedial actions:

1. Strong electromagnetic interference from a nearby emitter source such as an authorized radio station or cellular phone:  
Install the equipment and/or system at another location. Keep the emitter source such as cellular phone away from the equipment and/or system, or turn off the cellular phone.
2. Radio-frequency interference from other equipment through the AC power supply of the equipment and/or system:  
Identify the cause of this interference and if possible remove this interference source. If this is not possible, use a different power supply.
3. Effect of direct or indirect electrostatic discharge:  
Make sure all users and patients in contact with the equipment and/or system are free from direct or indirect electrostatic energy before using it. A humid room can help lessen this problem.
4. Electromagnetic interference with any radio wave receiver such as radio or television:  
If the equipment and/or system interferes with any radio wave receiver, locate the equipment and/or system as far as possible from the radio wave receiver.
5. Interference of lightning:  
When lightning occurs near the location where the equipment and/or system is installed, it may induce an excessive voltage in the equipment and/or system. In such a case, disconnect the AC power cord from the equipment and/or system and operate the equipment and/or system by battery power, or use an uninterruptible power supply.
6. Warning: Use with other equipment:  
When the equipment and/or system is adjacent to or stacked with other equipment, the equipment and/or system may affect the other equipment. Before use, check that the equipment and/or system operates normally with the other equipment.

Caution - continued

7. Warning: Use of unspecified accessory, transducer and/or cable:

When an unspecified accessory, transducer and/or cable is connected to this equipment and/or system, it may cause increased electromagnetic emission or decreased electromagnetic immunity. The specified configuration of this equipment and/or system complies with the electromagnetic requirements with the specified configuration. Only use this equipment and/or system with the specified configuration.

8. Use of unspecified configuration:

When the equipment and/or system is used with the unspecified system configuration different than the configuration of EMC testing, it may cause increased electromagnetic emission or decreased electromagnetic immunity. Only use this equipment and/or system with the specified configuration.

9. Measurement with excessive sensitivity:

The equipment and/or system is designed to measure bioelectrical signals with a specified sensitivity. If the equipment and/or system is used with excessive sensitivity, artifact may appear by electromagnetic interference and this may cause mis-diagnosis. When unexpected artifact appears, inspect the surrounding electromagnetic conditions and remove this artifact source.

10. Use with radiation therapy equipment:



When the equipment and/or system is used in a radiotherapy room, it may cause failure or malfunction due to electromagnetic radiation or corpuscular radiation.

When you bring the equipment and/or system into a radiotherapy room, constantly observe the operation. Prepare countermeasures in case of failure or malfunction.

If the above suggested remedial actions do not solve the problem, consult your Nihon Kohden representative for additional suggestions.

## Conventions Used in this Manual and Instrument













### Warnings and Cautions

Level	Description
 <b>WARNING</b>	A warning alerts the user to possible injury or death associated with the use or misuse of the instrument.
 <b>CAUTION</b>	A caution alerts the user to possible injury or problems with the instrument associated with its use or misuse such as instrument malfunction, instrument failure, damage to the instrument, or damage to other property.







## Explanations of the Symbols in this Manual and Instrument

The following symbols are used with this transmitter. The description of each symbol is shown in the table below.

### On Panel

Symbol	Description	Symbol	Description
	Change screen		Defibrillation proof type BF applied part
	Attention, consult operator's manual		Defibrillation proof type CF applied part
	Moves cursor, scrolls data		Serial number
	Direction for attaching battery cover		Date of manufacture
	Direction for inserting battery		RF transmitter Non-ionizing radiation
	Direct current		CSA mark

### On LCD

Symbol	Description	Symbol	Description
	Full battery		Battery very weak Cannot measure NIBP Replace battery
	Battery 1/3 full		Alarm suspended
	Battery weak Replace battery		QRS/pulse sync mark

## Intended Use

### General

The ZM-540PA and ZM-541PA transmitters transmit ECG, respiration and pulse waveforms, SpO<sub>2</sub> and NIBP data from a patient to a Nihon Kohden monitor for continuous monitoring. The front LCD displays ECG (or pulse wave), numeric values of monitoring parameters, NIBP measuring mode and interval, messages and battery condition.<sup>1</sup> They also display the compressed waveform and numeric data of the latest 10 minutes.

This transmitter is designed for use by qualified medical personnel in a medical facility such as a hospital or clinic. It is not designed for use outdoors or in a home environment, and is not designed to be operated by the patient themselves.

<sup>1</sup> Essential performance of this transmitter.

The difference between the ZM-540PA and ZM-541PA is the transmission frequency range.

ZM-540PA: 608.0250 to 613.9750 MHz (channel number 9002 to 9478)

ZM-541PA: 1395.0250 to 1399.9750 MHz (channel number E002 to E398)  
1427.0250 to 1431.9750 MHz (channel number E502 to E898)

- NOTE
- The transmitter channel can be changed with a QI-901PK channel writer.
  - Read the operator's manual for the receiving monitor together with this manual before use.

#### **WARNING**

Do not diagnose a patient based only on data acquired by the transmitter. Overall judgement must be performed by a physician who understands the features, limitations and characteristics of the transmitter and by reading the biomedical signals acquired by other instruments.

#### **WARNING**

Do not use this transmitter for monitoring a patient. Monitor the patient on a receiving monitor. This transmitter displays the waveforms and measured values but does not have an alarm function.



 **WARNING**

Do not use the same transmitter for more than one patient at the same time. Do not connect different sensors from different patients to the same transmitter.

 **A I N**

Do not use the same channel for different patients. If the same channel is used for two patients, the two patients' data will be lost due to mutual modulation interference, or another patient's data may appear on the receiving monitor screen.

Do not use two transmitters with adjacent channels in the same hospital. If transmitters with adjacent channels are used, their radio waves interfere with each other.

 **A I N**

Signal loss and artifact may occur because of the multipath cancellation when using a transmitter.

\* **Multipath Cancellation (Standing Wave Interference)**

When a radio wave reflects off a surface, there may be some points in the room where the reflected and direct waves are exactly out of phase. At these points in the room, the reflected and direct waves cancel each other out so that the signal strength is decreased.

Locations where signal loss occurs are called "null spots". If the transmitter is moving or nearby people or objects are moving, null spots can occur anytime and anywhere.

- NOTE**
- To prevent interference between channels, assign a channel administrator in the hospital and only he or she should manage channel assignment.
  - Use Nihon Kohden parts and accessories to assure maximum performance from your instrument.
  - For stable signal reception, it is recommended to use a diversity antenna system on the receiving monitor. Otherwise, spike noise from transient fading of electric field strength (for example, people moving) may interfere with the transmitter signal and may be mistaken as an arrhythmia on the receiving monitor.

- If the transmitter is used outside the specified environment, its performance cannot be guaranteed.
- For details on antennas and antenna construction, contact your Nihon Kohden representative. You can also refer to the Telemetry System Installation Guide.

---

## Receiving Monitor

Any Nihon Kohden receiving monitor (central monitor with multiple patient receiver) can receive signals from this transmitter as long as the protocol version and channel setting are the same on the receiving monitor and transmitter.

- NOTE
- For details on the receiving monitor and upgrade information, contact your Nihon Kohden representative.
  - The transmitter does not give any patient alarm, only a “no battery” alarm. Patient alarms must be managed on the receiving monitor.

# Panel Description

## Front Panel

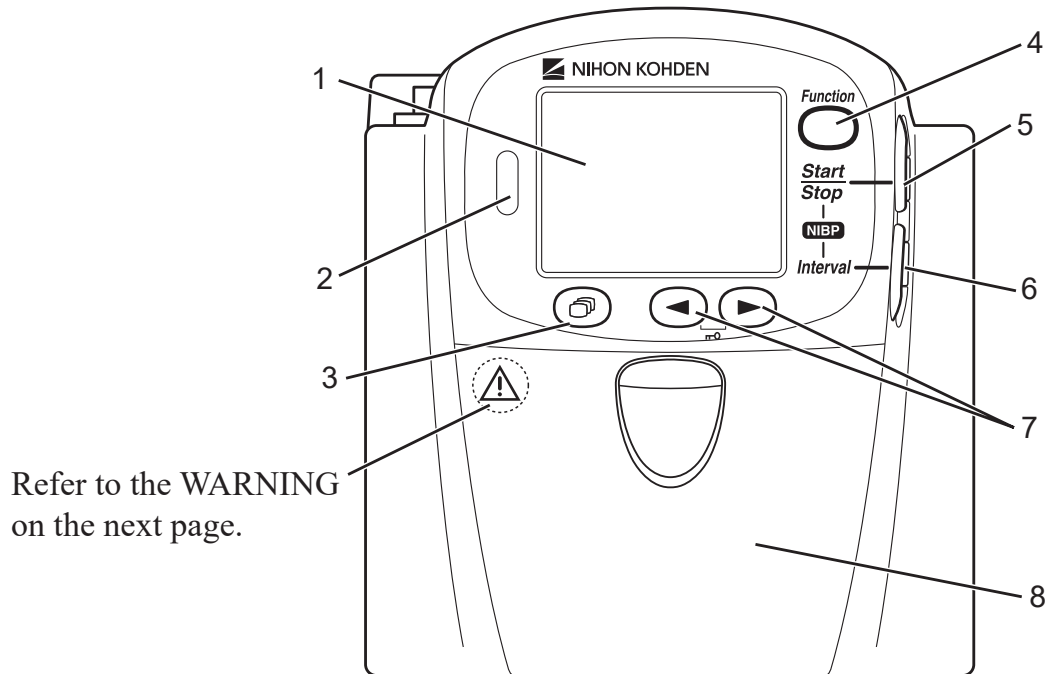

Refer to the WARNING on the next page.

### 1 LCD

Displays numeric values, ECG or pulse wave, NIBP measuring mode and interval, messages and battery status. For details, refer to the “Screen Descriptions” section.

### 2 Infrared receiver

Used for upgrading the transmitter software.

### 3 Screen key

Toggles the screen in the following order.

After power on: Start up → Check electrodes → Numeric and waveform → Waveform review → Numeric review → Display off → Check electrodes ...

After auto display off: Numeric and waveform → Waveform review → Numeric review → Display off → Check electrodes → Numeric and waveform ...

On a SETUP or CHECK screen, this key cancels changing setting or exits the screen.

### 4 Function key

Depending on the setting on the transmitter, this key suspends alarms, pauses monitoring on the receiving monitor or transmits “Patient confirmed” message.

On a SETUP screen, this key registers the selected setting and moves the cursor to the next setting item.

On a CHECK screen, this key starts or stops maintenance test.

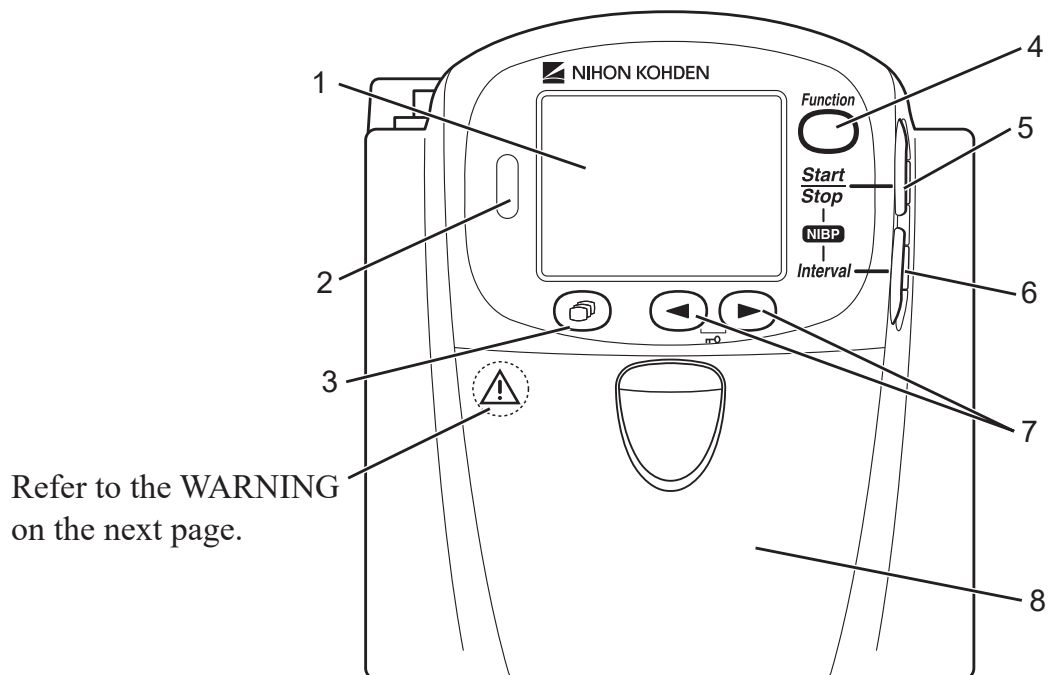

Refer to the WARNING on the next page.

**5 NIBP Start/Stop key**

Starts/stops NIBP measurement in selected mode.

**6 NIBP Interval key**

Selects NIBP measurement mode.

**7 Lead/Scroll keys**

On the numeric and waveform screen, these keys change the ECG lead.

On the waveform review screen, these keys scroll data.

On a SETUP screen, these keys move the cursor.

**8 Battery case**

Contains three 1.5 V dry cell batteries (AA TYPE).

**⚠ WARNING**

Do not lose the battery case cover during operation. If the transmitter is used with the battery case cover open, anyone who touches the opened battery case may receive an electrical shock when defibrillation is performed. Touching the opened battery case may cause electrostatic discharge and intermittently interfere with the waveform or data.

## Rear Panel

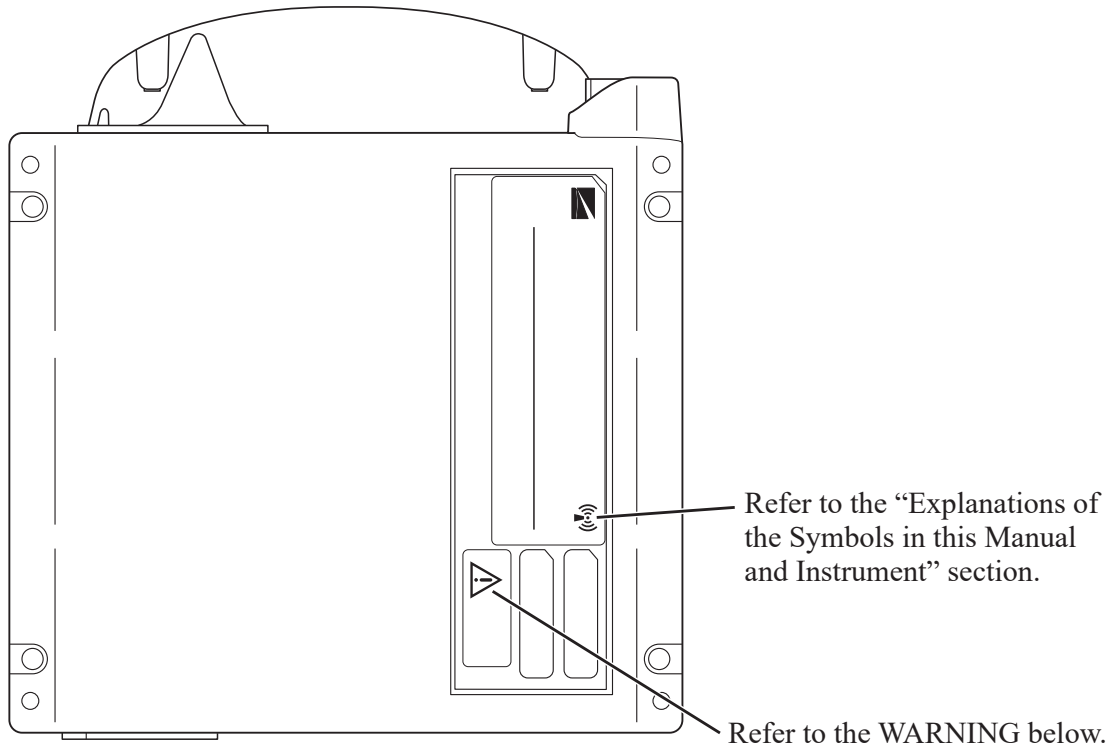

### WARNING

This transmitter is not waterproof. If detergent or liquid spills into the transmitter, stop using it and contact your physician or hospital representative. If a wet transmitter is used, the patient or operator may receive an electrical shock or injury.

## Top Panel

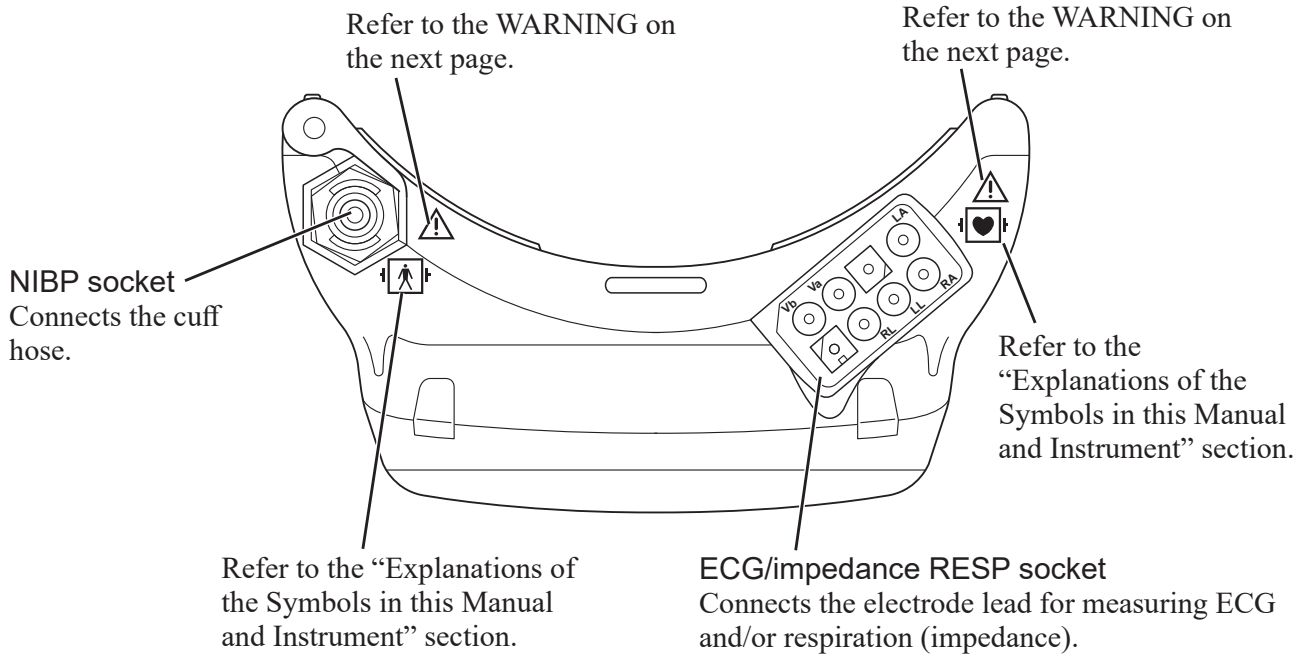

## Bottom Panel

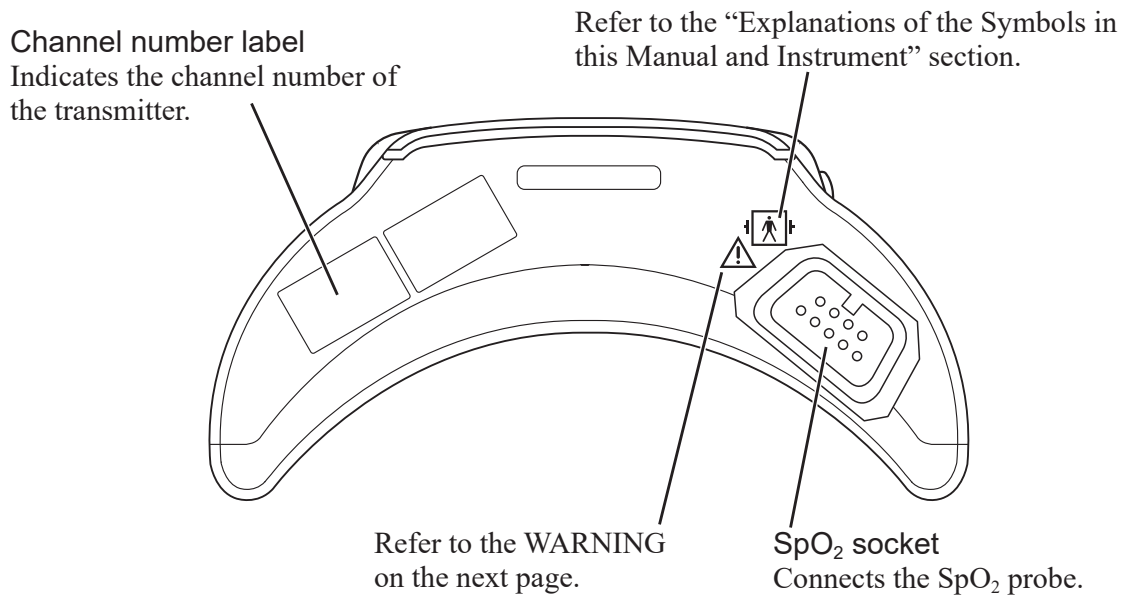

 WARNING

Before defibrillation, all persons must keep clear of the bed and must not touch the patient or any equipment or cord connected to the patient. Failure to follow this warning may cause electrical shock or injury.

 WARNING

When performing defibrillation, discharge as far as possible from electrodes, patches and any gel, cream or medicine on the chest of the patient. If there is a possibility that the defibrillator paddle could touch these materials, remove them from the patient. If the defibrillator paddle directly contacts these materials, the discharged energy may cause skin burn to the patient.

 WARNING

When the transmitter is used with an electrosurgical unit, firmly attach the entire area of the return plate. Otherwise, the current from the unit flows into the electrodes of the transmitter, causing electrical burn where the electrodes are attached. For details, refer to the manual.

 A I N

Do not shake or swing the transmitter while holding the leads or cables connected to the transmitter. The transmitter may come off and injure someone or damage surrounding instruments.

## Important Safety Information

### General

#### WARNING

Never use the transmitter in the presence of any flammable anesthetic gas or high concentration of oxygen atmosphere. Failure to follow this warning may cause explosion or fire.

#### WARNING

When performing a test, remove all electrodes and probe from the patient which are connected to this transmitter. Failure to follow this warning may cause serious burn on the patient. For details, refer to the user manual.

#### WARNING

Never use the transmitter in a hyperbaric oxygen chamber. Failure to follow this warning may cause explosion or fire.

#### WARNING

Do not take this transmitter into the test room. This transmitter is not designed to be used during tests.

#### WARNING

Before defibrillation, all persons must keep clear of the bed and must not touch the patient or any equipment or cord connected to the patient. Failure to follow this warning may cause electrical shock or injury.



 WARNING

When performing defibrillation, discharge as far as possible from electrodes, patches and any gel, cream or medicine on the chest of the patient. If there is a possibility that the defibrillator paddle could touch these materials, remove them from the patient. If the defibrillator paddle directly contacts these materials, the discharged energy may cause serious burn to the patient.

 WARNING

When the transmitter is used with an electrosurgical unit, firmly attach the entire area of the return plate. Otherwise, the current from the unit flows into the electrodes of the transmitter, causing electrical burn where the electrodes are attached. For details, refer to the manual.

 WARNING

Do not use the same transmitter for more than one patient at the same time. Do not connect different sensors from different patients to the same transmitter.

 WARNING

This transmitter is not waterproof. If detergent or liquid spills into the transmitter, stop using it and contact your Johnson & Johnson representative. If a wet transmitter is used, the patient or operator may receive an electrical shock or injury.

**⚠ WARNING**

Do not lose the battery case cover during operation. If the transmitter is used with the battery case cover open, anyone who touches the opened battery case may receive an electrical shock when defibrillation is performed. Touching the opened battery case may cause electrostatic discharge and intermittently interfere with the waveform or data.

**⚠ WARNING**

When the signal is unstable, keep the patient under close observation. When the signal is unstable, the monitoring and alarm are not reliable and the receiving monitor cannot detect a sudden change of the patient's condition. This may cause critical changes in the patient condition to be overlooked. Install an appropriate antenna system to ensure stable signal condition.

**⚠ WARNING**

While the **DD** message is displayed on the transmitter, all alarms on the receiving monitor are suspended so keep the patient under close observation.

**⚠ WARNING**

When the patient returns to the bed, turn on the transmitter and check that the monitoring is resumed on the receiving monitor.

**⚠ WARNING**

If the transmitter is not turned off and monitoring continues for the selected interval, pause monitoring is canceled and monitoring continues. Check that the monitoring is resumed on the receiving monitor.

**⚠ WARNING**

Do not allow the conductive part of the connector which is connected to the patient to contact other conductive parts including earth. This causes leakage current and incorrect measurement value and leads to wrong diagnosis.

**⚠ WARNING**

After admitting a patient on the central monitor and attaching electrodes and sensors on the patient and connecting cables to the transmitter, check that there is no error messages and that the waveforms and numeric data are appropriately displayed on the transmitter and central monitor screen. If there is an error message, or waveform or numeric data is not appropriate, check the electrodes and sensors attachment, patient condition and settings on the transmitter and remove the cause.

**⚠ CAUTION**

Only use Nihon Kohden specified electrodes, electrode leads, SpO<sub>2</sub> probes, and NIBP cuffs. Otherwise, the maximum performance from the transmitter cannot be guaranteed.

**⚠ MAIN**

Do not reuse disposable parts and accessories.

**⚠ MAIN**

For handling and precautions on electrodes, electrode leads, pO<sub>2</sub> probes and NIBP cuffs, refer to the manual.

⚠ A I N

The measurement values and displayed waveforms on the transmitter and receiving monitor may be different due to timing delay of the display or difference in detection settings.

⚠ A I N

Do not shake or swing the transmitter while holding the leads or cables connected to the transmitter.

The transmitter may come off and injure someone or damage surrounding instruments.

⚠ A I N

Signal loss and artifact may occur because of the multipath cancellation when using a transmitter.

\* Multipath Cancellation (Standing Wave Interference)

When a radio wave reflects off a surface, there may be some points in the room where the reflected and direct waves are exactly out of phase. At these points in the room, the reflected and direct waves cancel each other out so that the signal strength is decreased.

Locations where signal loss occurs are called “null spots”. If the transmitter is moving or nearby people or objects are moving, null spots can occur anytime and anywhere.

⚠ A I N

Turn off the power of mobile phones, small wireless devices and other devices which produce strong electromagnetic interference around a patient except for devices allowed by the hospital administrator. Radio waves from devices such as mobile phones or small wireless devices may be mistaken as pulse waves or respiration waves and the displayed data may be incorrect.

 A I N

When monitoring respiration is needed, measure respiration with an instrument. The transmitter calculates  $pO_2$  of arterial blood based on the principle of pulse oximetry and does not measure respiration.

 A I N

Do not use the same channel for different patients. If the same channel is used for two patients, the two patients' data will be lost due to mutual modulation interference, or another patient's data may appear on the receiving monitor screen.

Do not use two transmitters with adjacent channels in the same hospital. If transmitters with adjacent channels are used, their radio waves interfere with each other.

 A I N

When monitoring  $pO_2$  only, detection of arrhythmia and asystole is not available and arrhythmia alarms such as  $PO_2$ ,  $PR$ , or  $PR$  are not available. If the patient requires monitoring, monitor the  $PR$ .

 A I N

When monitoring  $pO_2$  only without monitoring  $PR$ , turn on both the upper and lower limit alarms for  $PR$  and  $pO_2$  on the receiving monitor. If the patient's pulse is not detected during asystole or other condition, a  $PO_2$   $OD$  or  $PO_2$  alarm occurs instead of an  $pO_2$  limit alarm. Furthermore, if the patient has no pulse, noise from probe movement could be misjudged as a pulse and cause an incorrect  $PR$  or  $pO_2$  value to be displayed.

**⚠ A I N**

Always lock the battery cover while using the transmitter. Otherwise the battery cover may come off and correct measurement might not be performed.

---

## Output Signal

**⚠ WARNING**

Do not use the output signal from the receiving monitor as the synchronization signal for other equipment such as , , echocardiography or defibrillator. There may be time delay between the monitor and the other equipment caused by waveform transmission delay and spike noise may interfere on the output signal and be mistaken as a trigger.

---

## Battery

**⚠ A I N**

Battery replacement must be performed by the operator. When replacing the batteries of a transmitter that is currently used for a patient, disconnect the electrode leads from the transmitter before replacing batteries or do not touch the patient during replacement.

**⚠ A I N**

Refer to the battery and battery charger manuals for details on handling the batteries.

## Transmitter Channel Management

### WARNING

The following actions must be taken to properly receive the transmitter signal of the correct patient on the receiving instrument. Otherwise, there may be signal loss or signals may mix causing a serious accident, such as monitoring a different patient.

Assign a channel administrator in the hospital and only he or she should manage channel assignment.

The channel administrator must manage the channels in the facility so that there is no signal interference.

When the transmitter channel is changed, the channel administrator must check that the channel on the receiving monitor is also changed and the signal is properly received.

The channel administrator must replace the channel number label on the transmitter with the new one after changing the channel.

---

## For Patients Using Implantable Pacemaker

### WARNING

The bioelectric impedance measurement sensor of a minute ventilation rate adaptive implantable pacemaker may be affected by transmitter which is connected to the same patient. If this occurs, the pacemaker may pace at its maximum rate and the transmitter may give incorrect data to the monitor.

If this occurs, disconnect the electrode leads from the patient or change the setting on the pacemaker by referring to the pacemaker's manual. For more details, contact your pacemaker representative or physician representative.

## ECG Monitoring

### ⚠ WARNING

Turn the pacing pulse detection to OFF on the receiving monitor when monitoring a pacemaker patient. Otherwise the pacemaker pulse is not rejected. However, even when the pacing pulse detection is set to OFF, the pacemaker pulse might not be rejected. When the pacemaker pulse is not rejected, the pacemaker pulse is detected as a normal pulse and false heart rate may be indicated or critical arrhythmia such as asystole may be overlooked. Keep pacemaker patients under close observation.

For the pacemaker pulse rejection capability of the ZM-540PA and ZM-541PA transmitters refer to the “Specifications - ECG” section.

### ⚠ WARNING

Even when the pacing pulse detection is set to OFF on the receiving monitor, the pacemaker pulse can be overlooked or detected as a normal pulse. You cannot confirm the pacemaker operation only from the detected pacemaker pulse.

### ⚠ MAIN

Only use the recommended specified electrodes and electrode leads. When other type of electrodes or electrode leads are used, the ECG message may be displayed and monitoring may stop.

### ⚠ MAIN

When the ECG message is displayed on the receiving monitor, the patient is not monitored properly and the ECG alarm does not function. In this case, the electrode, electrode leads, and if necessary, replace with new ones.



## SpO<sub>2</sub> Monitoring

**⚠ WARNING**

pO<sub>2</sub> measurement may be incorrect in the following cases.

When the patient's carboxyhemoglobin or methemoglobin increases abnormally.

When dye is injected in the blood.

During

When measuring at a site with venous pulse.

When there is body movement.

When the pulse wave is small insufficient peripheral circulation.

**⚠ WARNING**

When monitoring pO<sub>2</sub> of a patient who is receiving photodynamic therapy, the light from the finger probe sensor may cause a burn.

Photodynamic therapy uses a photosensitizing agent that has a side effect of photosensitivity.

The SpO<sub>2</sub> probes manufactured by Nihon Kohden have two wavelengths with peaks in the range of 650 and 950 nm. The maximum light intensity is less than 5.5 mW.

**⚠ WARNING**

When not monitoring pO<sub>2</sub>, disconnect the pO<sub>2</sub> cable from the transmitter. Otherwise, noise from the probe sensor may interfere and incorrect data is displayed on the screen.

**⚠ WARNING**

When using the \_\_\_\_\_ finger probe, do not fasten the probe and cable to the finger by wrapping with tape. This may cause burn, congestion or pressure necrosis from poor blood circulation.

When using probes other than the \_\_\_\_\_ finger probe, to avoid poor circulation, do not wrap the tape too tight. Check the blood circulation condition by observing the \_\_\_\_\_ skin color and congestion at the \_\_\_\_\_ skin peripheral to the probe attachment site. Even for short term monitoring, there may be burn or pressure necrosis from poor blood circulation, especially on neonates or low birth weight infants whose \_\_\_\_\_ skin is delicate. Accurate measurement cannot be performed on a site with poor peripheral circulation.

**⚠ WARNING**

Check the circulation condition by observing the \_\_\_\_\_ skin color at the measurement site and pulse waveform. Change the measurement site every \_\_\_\_\_ hours for disposable probes and every \_\_\_\_\_ hours for reusable probes every \_\_\_\_\_ hours for \_\_\_\_\_ series probe. The \_\_\_\_\_ skin temperature may increase at the attached site by \_\_\_\_\_ or \_\_\_\_\_ and cause a burn or pressure necrosis. When using the probe on the following patients, take extreme care and change the measurement site more frequently according to symptoms and degree.

- \_\_\_\_\_ patient with a fever
- \_\_\_\_\_ patient with insufficient peripheral circulation
- \_\_\_\_\_ neonate or low birth weight infant with delicate \_\_\_\_\_ skin

 A I N

The disposable probe is not sterilized. Use the disposable probe only for a single patient. Never reuse the disposable probe for another patient because it causes cross infection.

 A I N

If the attachment site is dirty with blood or bodily fluids, clean the attachment site before attaching the probe. If there is nail polish on the attachment site, remove the polish. Otherwise, the amount of transmitted light decreases, and measured value may be incorrect or measurement cannot be performed.

 A I N

If the skin gets irritated or redness appears on the skin from the probe, change the attachment site or stop using the probe. Take extreme care for the patients with delicate skin.

 A I N

While a patient is on medication which causes vasodilation, the pulse waveform may change and in rare cases the  $pO_2$  value might not be displayed.

**⚠ A I N**

and pO<sub>2</sub> can be measured on the same limb, but the pO<sub>2</sub> monitoring might not be accurate during SpO<sub>2</sub> measurement. Be careful when reading the pO<sub>2</sub> values.

\* **Monitoring SpO<sub>2</sub> during NIBP Measurement**

When the SpO<sub>2</sub> probe is attached to the same limb as the NIBP cuff, the blood flow decreases during NIBP measurement and pulse wave cannot be detected and SpO<sub>2</sub> cannot be monitored properly. When “INHIBIT SpO<sub>2</sub> DURING NIBP” on the PARAMETER SETUP screen is set to ON (factory default setting), SpO<sub>2</sub> monitoring is paused during NIBP measurement to avoid SpO<sub>2</sub> alarm occurrence. However, when monitoring SpO<sub>2</sub> on the same limb as the NIBP, be careful when reading SpO<sub>2</sub> values.

**⚠ A I N**

Normal external light does not affect monitoring but strong light such as a surgical light or sunlight may affect monitoring. If affected, cover the measuring site with a blanket.

**⚠ A I N**

When a message indicates a faulty probe, stop monitoring and replace the probe with a new one.

**⚠ CAUTION**

Handle the probe cable according to the following cautions. Failure to follow these cautions may cause cable discontinuity or short circuit of the probe cable which may cause incorrect measurement data or inability to perform measurement. Also in rare cases, the probe temperature may increase and cause skin burn on the patient. If the probe cable is damaged, replace the probe with a new one.

- Do not pull or bend the probe cable.
- Do not let caster feet run over the probe cable.

 A I N

Do not use a probe which is deteriorated by aging. Accurate measurement cannot be performed.

 A I N

Do not use a damaged or disassembled probe. It causes incorrect measurement and may injure the patient.

 A I N

When the probe is attached on an appropriate site with sufficient thickness and the error message confirming the probe attachment repeatedly appears, the probe may be deteriorated. Replace it with a new one.

---

## NIBP Monitoring

 WARNING

Be careful when measuring on a patient with known bleeding disorders or coagulation. After measurement, there may be dot hemorrhage, or circulatory disorder by thrombus where the cuff is attached.

**⚠ WARNING**

measurement may be incorrect in the following situations.

- when using an
- body movement
- small pulse wave
- too many arrhythmias
- heating from an external source
- rapid blood pressure change

**During**

- low pulse
- low blood pressure
- small pulse pressure
- cuff is too tight or too loose
- cuff does not fit the arm
- cuff is wrapped over thick clothing
- cuff is deteriorated
- arterial sclerosis
- poor perfusion

**Diabetes**

- age
- pregnancy
- pre-eclampsia
- renal disease
- shivering
- trembling

**⚠ WARNING**

When performing measurements in mode or minute intervals, periodically remove the cuff from the patient for ventilation. The skin temperature may increase at the cuff attachment site by or or . When measuring a patient with a fever or peripheral circulation insufficiency, it may cause a burn.

**⚠ WARNING**

Do not attach the cuff on a limb which is being used for intravascular access or therapy, or an arterio venous shunt. It may cause reflux of blood or medicinal solution or block injection of medicinal solution due to poor blood circulation.

**⚠ WARNING**

Do not attach the cuff on an arm which is the same side as a mastectomy. It may cause circulatory disorder such as swelling from poor blood circulation.

**⚠ WARNING**

While measuring, if the cuff and other medical equipment are attached to the same limb, the medical equipment might not function temporarily.

**⚠ WARNING**

While measuring, check the patient condition and confirm that the cuff does not affect blood circulation.

**⚠ WARNING**

When performing long term measurement at intervals less than 10 minutes, perform measurements while observing the state of the patient, blood vessels and limb to ensure adequate circulation. Congestion may occur at the measurement site. When performing periodic measurement for a long time, periodically check the circulation condition.

 **A I N**

Do not wrap the cuff on an arm or thigh which is used for injection.      measurement on an arm or thigh which is used for injection may cause reflux of blood and stop injection.

 **A I N**

Do not wrap the cuff too tight.      t may cause poor blood circulation and congestion.      f the cuff is wrapped too loosely, the      value may increase.

 **A I N**

Do not attach the cuff to the site where there is injury or inflammation.      f the s      in gets irritated or redness appears on the s      in from the cuff, change the attachment site or stop using the cuff.      a      e      e      treme care on the patients with delicate s      in.

 **A I N**

When using an e      tension hose, check that the e      tension hose is not bent or squeezed. Otherwise, the cuff might not inflate or deflate.      f the cuff cannot deflate, it may cause congestion on the patient at the cuff attachment site.

 **A I N**

When performing      measurement repeatedly, have a rest between measurements to recover adequate circulation.



## Maintenance

 A I N

If detergent or liquid spills into the transmitter, stop cleaning or disinfecting it and contact your Johnson & Johnson representative. The transmitter needs to be checked for safety and function before use.

 A I N

Before maintenance, cleaning or disinfection, turn the transmitter power off and remove the batteries. Failure to follow this instruction may result in electrical shock and transmitter malfunction.

 A I N

Never disassemble or repair the transmitter. If there is any problem with the transmitter, contact your Johnson & Johnson representative.

 A I N

Dispose of Johnson & Johnson products according to your local laws and your facility's guidelines for waste disposal. Otherwise, it may affect the environment. If there is a possibility that the product may have been contaminated with infection, dispose of it as medical waste according to your local laws and your facility's guidelines for medical waste. Otherwise, it may cause infection.

# Preparation on Transmitter

## Batteries

### Handling Batteries

**⚠ WARNING**

Do not handle the batteries with wet hands.

**⚠ WARNING**

When the transmitter is not in use, remove the batteries. When the batteries are installed, battery power is consumed even when measurement is not performed. When the batteries are left in the transmitter when it is not used, the batteries may overdischarge and leak liquid which makes the batteries unusable and damages the transmitter.

**⚠ A I N**

Refer to the battery and battery charger manuals for details on handling the batteries.

- NOTE**
- Remove the batteries from the transmitter before disposing of it.
  - Use either new alkaline batteries or fully charged rechargeable NiMH batteries. Using unspecified batteries, previously used batteries or batteries that have been stored for long periods may result in short battery life or reduced performance resulting in unstable measurement.

### Battery Lifetime

Use three AA type alkaline dry cell batteries. NiMH batteries can also be used but the lifetime of alkaline batteries is longer. The lifetime of NiMH batteries is about 1/2 of alkaline batteries (when fully charged).

With new Nihon Kohden recommended alkaline batteries, the transmitter can continuously measure ECG, respiration, SpO<sub>2</sub> and NIBP for approximately 1 day. The measurement is performed at room temperature, NIBP is measured in auto mode at 60 minute intervals and SpO<sub>2</sub> is measured on an index finger of a male patient with weight 60 kg. Operation time depends on the thickness of the SpO<sub>2</sub> probe attachment site.

## Recommended batteries

NiMH secondary: Panasonic eneloop

Alkaline primary: Nihon Kohden Medipower (equivalent to Panasonic LR6 (G))

## Installing and Replacing Batteries

### ⚠ A I N

Battery replacement must be performed by the operator. When replacing the batteries of a transmitter that is currently used for a patient, disconnect the electrode leads from the transmitter before replacing batteries or do not touch the patient during replacement.

If electrode leads are attached to the patient and the person replacing batteries touches the patient during battery replacement, excess patient leakage current may flow into the patient.

- NOTE**
- Replace all batteries at the same time.
  - Do not use different types of batteries together.
  - Insert the batteries with the correct polarity (+ and -).
  - The capacity of rechargeable NiMH batteries is reduced if the batteries are recharged before they are fully discharged. For details, refer to the battery operator's manual.

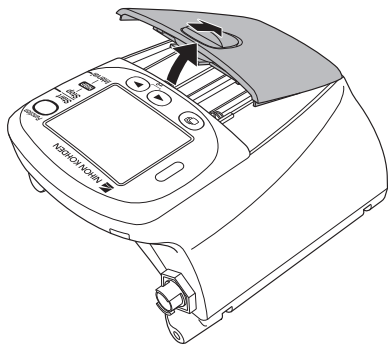

**1** Remove the battery case cover.

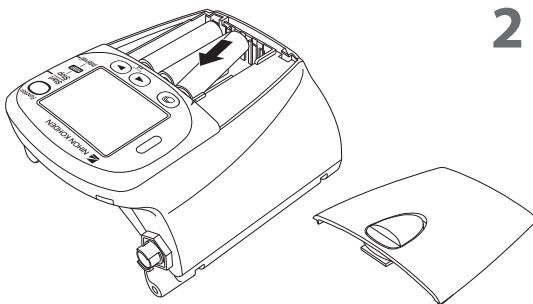

**2** Insert three new or fully charged batteries into the battery case observing the correct polarity.

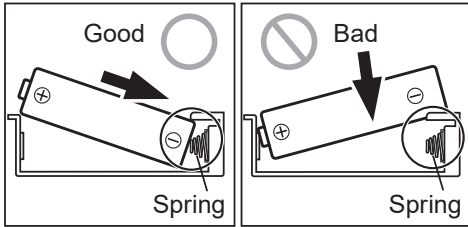

- NOTE**
- As shown in the diagram, slide each battery into the compartment so the negative terminal of the battery is pressing against the spring. Inserting a battery at the wrong angle may deform the spring and cause a short circuit or damage the battery compartment.
  - Inserting the positive terminal first and then forcing the battery into the compartment may damage the battery or the transmitter.

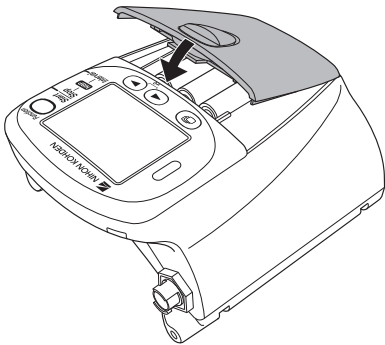

### 3 Close the cover.

The transmitter is automatically turned on when the batteries are installed and the cover is closed.

#### **A I N**

Always lock the battery cover while using the transmitter. Otherwise the battery cover may come off and correct measurement might not be performed.

## Situations Requiring Battery Replacement





Replace the batteries when any of the following occurs:

- The transmitter displays the “BATTERY WEAK” message or  icon.
- The transmitter generates a constant alarm (continuous “peep” sound).
- The transmitter LCD does not display anything when the power is turned on.
- The receiving monitor displays a battery replacement message.

**NOTE:** The battery replacement message or icon on the transmitter disappears after a short time depending on the type of battery. When the battery replacement indication appears, immediately replace the transmitter battery with a new one.

## Battery Level Indication

The following icons on the display indicate the battery level. When the screen is turned off, press the Screen key to check the battery level. When "PROTOCOL" of the SYSTEM SETUP screen is set to 57, the battery level indication is transmitted to the receiving monitor.

Indication	Battery Level	Message on the Receiving Monitor
	Fully charged batteries	There is no message on the monitor.
	Batteries are 1/3 full.	
	Batteries are weak. Replace batteries.	Message requiring battery replacement is displayed.
	Batteries are very weak. Cannot measure NIBP. Replace batteries.	
No indication	Dead batteries	No signal can be transmitted to the monitor. There is no indication on the monitor.

## Turning On the Transmitter

When the batteries are installed correctly, the power is turned on. A “peep” sounds for one second, the startup screen appears, then the check electrodes screen appears. (There is no “peep” sound when there is no battery power.)

NOTE: Check that the “COMMUNICATION LOSS” message is not displayed on the central monitor.



After checking that the ECG is stable on the check electrodes screen, press the Screen key to display the numeric and waveform screen.



For details on the screen, refer to the “Screen Descriptions” section.

## Check Items Before Use

Before turning on the transmitter power, check the following to confirm that the transmitter can be used in normal and safe condition.

### Operating Environment

If the transmitter has been stored in conditions such as low temperatures that are outside the usage environment range, place the transmitter in the usage environment for sufficient time for it to adjust to the room temperature before use. If the transmitter may be used constantly, store it within the usage environment range.

### Appearance

- There are no damaged or dirty parts on the outside of the transmitter (LCD, keys, sockets, battery case cover, battery case, etc.).
- The transmitter is completely dry.
- The electrodes, electrode lead, SpO<sub>2</sub> probe and NIBP cuff are not broken.

### Batteries

- The battery polarity is correct.
- The battery case spring is firmly attached and the battery is not loose.
- The battery case cover is firmly closed.

### Channel Setting

- The transmitter channel matches the receiving monitor channel.
- There is no nearby transmitter with the same channel.

### Other

The transmitter information is correctly sent to the receiving monitor when the transmitter is turned on or off.

## Check Items After Power On

After turning on the power, check the following.

### Power On

- The transmitter generates a one second “peep” sound and the startup screen appears.
- The transmitter displays the check electrodes screen.
- The transmitter is not too hot.
- The transmitter does not display the “BATTERY WEAK” message.
- The transmitter does not interfere with the operation of other medical instruments.

**Daily Check**

- The “signal loss” message is not displayed on the receiving monitor when the transmitter is inside the receiving range of the monitor.
- The battery replacement message is not displayed on the monitor.
- The keys on the transmitter function properly.
- The LCD brightness is appropriate. To adjust brightness, refer to the “Changing SYSTEM SETUP Settings” section.

**Check Items After Use**

To use the transmitter in safe and optimum condition for next time, check the following.

**Before Turning Power Off**

- Temporarily changed settings are changed back to the previous settings.
- There was no malfunction on the transmitter.

**Storage**

- ECG electrode leads, SpO<sub>2</sub> probe and NIBP cuff are cleaned and disinfected.
- If the transmitter got wet, liquid is wiped off and the transmitter is thoroughly dried.
- There are enough consumables, such as disposable electrodes.
- The transmitter power is turned off by removing batteries from the transmitter.
- Dead batteries are disposed of properly.

---

**Turning Off the Transmitter**

To turn off the power, remove the batteries. When the power is turned off, the saved waveform and numeric data are deleted.



## Changing the Transmitter Channel

The channel of the transmitter can be changed with an optional QI-901PK channel writer.

### ⚠ WARNING

The following actions must be taken to properly receive the transmitter signal of the correct patient on the receiving instrument. Otherwise, there may be signal loss or signals may mix causing a serious accident, such as monitoring a different patient.

Assign a channel administrator in the hospital and only he or she should manage channel assignment.

The channel administrator must manage the channels in the facility so that there is no signal interference.

When the transmitter channel is changed, the channel administrator must check that the channel on the receiving monitor is also changed and the signal is properly received.

The channel administrator must replace the channel number label on the transmitter with the new one after changing the channel.

- NOTE
- The software version of the QI-901PK channel writer must be 02-01 or later to change the channel on the transmitter.
  - The channel writer must be used outside the patient environment.

The channel is displayed in the upper left corner of the screen.



## Changing Parameter and System Setup Settings

The initial settings on the PARAMETER SETUP and SYSTEM SETUP screens can only be changed before monitoring. Changing these settings during monitoring interrupts monitoring.

**NOTE:** Changing Parameter and System Setup settings must be done by qualified personnel.

---

### Notes on Parameter Settings

When monitoring NIBP and SpO<sub>2</sub>, the following setting must be set as indicated in the table to properly transmit the monitoring data to the receiving monitor. Otherwise, SpO<sub>2</sub> cannot be monitored properly during NIBP measurement.

Some receiving monitors require the software to be upgraded. For details, contact your Nihon Kohden representative.

SpO <sub>2</sub> Probe Attachment Site	INHIBIT SpO <sub>2</sub> DURING NIBP SETTING
Probe attached to the same limb as the cuff <sup>1</sup>	ON
Probe attached to the limb without cuff	OFF

<sup>1</sup> When the SpO<sub>2</sub> probe is attached to the same limb as the NIBP cuff and the cuff is inflated, the SpO<sub>2</sub> value becomes unstable and SpO<sub>2</sub> or PR alarm may occur.

## Changing PARAMETER SETUP Settings

### Parameter Setup Setting List

The factory default settings are underlined.

Setting Item	Description	Settings
ECG ELECTRODES	Select the electrode lead type.	IEC, <u>AHA</u>
LEAD TYPE	Select the type of ECG leads.	<u>AUTO</u> , 6 LEADS
ECG MEASUREMENT	Turn ECG monitoring on or off. When electrodes are attached to the patient and ECG leads are connected, ECG monitoring starts even when this setting is set to OFF. If this setting is set to OFF, the same setting on the receiving monitor must also be set to OFF. <b>NOTE:</b> When "PROTOCOL" of the transmitter is set to 57 and the receiving monitor is able to receive protocol 57, ECG measurement on the receiving monitor is automatically set to OFF when this setting is set to OFF on the transmitter.	<u>ON</u> , OFF
RESP MEASUREMENT	Turn respiration monitoring on or off. When this setting is set to OFF, the same setting on the receiving monitor is automatically set to OFF.	<u>ON</u> , OFF
SpO <sub>2</sub> RESPONSE	Select the SpO <sub>2</sub> response mode.	FAST, NORMAL, <u>SLOW</u>
INHIBIT SpO <sub>2</sub> DURING NIBP	Turn SpO <sub>2</sub> monitoring on or off during NIBP measurement.	<u>ON</u> , OFF
SELECTABLE INTERVALS (min)	Select the NIBP measurement modes for the mode selection.	<u>MANUAL</u> , STAT, <u>5</u> , <u>10</u> , <u>15</u> , <u>30</u> , <u>60</u> , 120, 240
INITIAL INTERVAL (min)	Select the initial NIBP measurement mode at power on.	<u>MANUAL</u> , STAT, 5, 10, 15, 30, 60, 120, 240
NIBP MODE AFTER STAT (min)	Select the NIBP measurement mode after completing STAT measurement.	MANUAL, <u>5</u> , 10, 15, 30
START/FINISH SOUND	Turn ON or OFF the sound for NIBP measurement start/finish.	START: ON, <u>OFF</u> FINISH: ON, <u>OFF</u>
OLD NIBP DATA/ AFTER (min)	Select whether to hide or dim the NIBP data after measurement and how long to wait after measurement to dim or hide it.	DATA: HIDE, <u>DIM</u> AFTER: 5, 10, <u>30</u>
INITIAL CUFF PRESSURE (mmHg)	Select the NIBP cuff inflation pressure.	120, 150, <u>180</u> , 210, 240

## Displaying the PARAMETER SETUP Screen

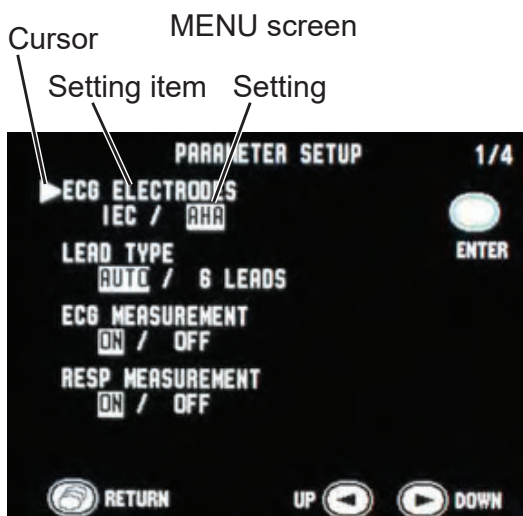
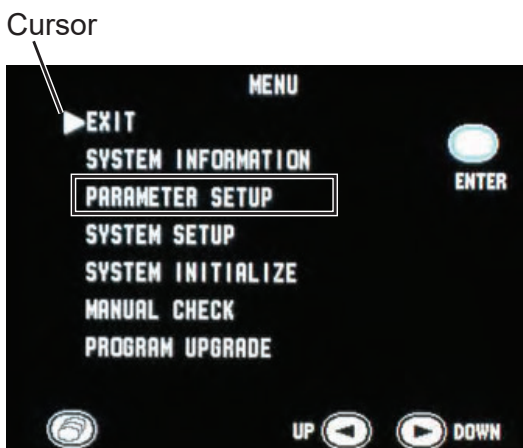

PARAMETER SETUP screen - page 1

- 1 Turn off the transmitter by removing one battery.
- 2 While pressing the Function key, turn on the transmitter by inserting the battery. The MENU screen appears.
- 3 Press the ► key to move the cursor to “PARAMETER SETUP”.
- 4 Press the Function key to enter PARAMETER SETUP. The current settings are highlighted.
- 5 Change settings.
  - To move the cursor and select the setting item, press the ◀ or ▶ key then press the Function key.
  - To select and register the setting, press the ◀ or ▶ key then press the Function key.
  - To cancel changing the setting of the selected item, press the Screen key.
- 6 When changing settings on the PARAMETER SETUP screen is complete, press the Screen key to return to the MENU screen.
- 7 Press the ◀ or ▶ key to move the cursor to “EXIT”.
- 8 Press the Function key. The numeric and waveform screen appears.

## Changing Parameter Setup Settings

### ECG ELECTRODES

Select the electrode lead type.

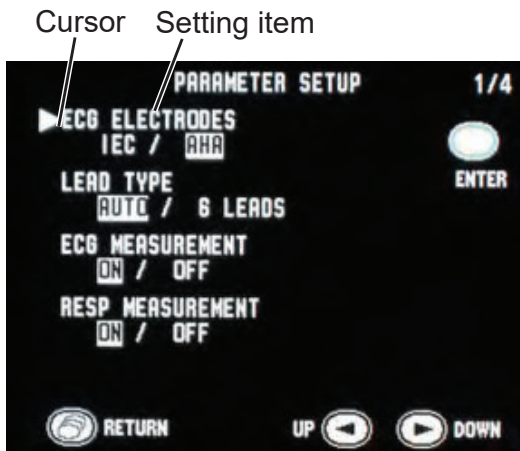

**1** On the PARAMETER SETUP screen, press the ► key to move the cursor to “ECG ELECTRODES”.

**2** Press the Function key. The cursor moves to the selection item.

**3** Press the ► key to select “IEC” or “AHA”.

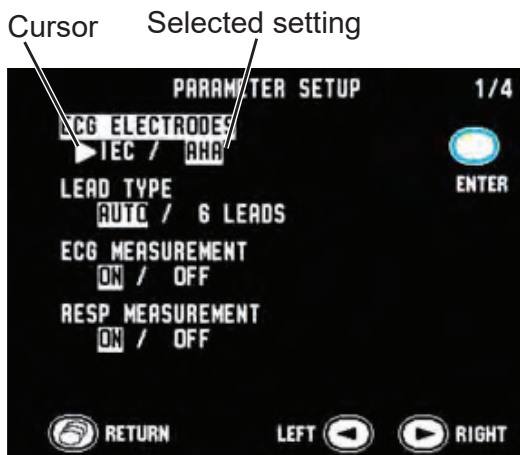

**4** Press the Function key to register the selected setting. The cursor returns to “ECG ELECTRODES”.

### LEAD TYPE

Select the type of ECG leads. In normal use, select “AUTO”. When using DIN type lead with 6 electrodes, select “6 LEADS”.

**1** On the PARAMETER SETUP screen, press the ► key to move the cursor to “LEAD TYPE”.

**2** Press the Function key.

**3** Press the ► key to select “AUTO” or “6 LEADS”.

**4** Press the Function key to register the selected setting. The cursor returns to “LEAD TYPE”.

## ECG MEASUREMENT

Turn ECG monitoring on or off. When electrodes are attached to the patient and ECG leads are connected, ECG monitoring starts even when this setting is set to OFF.

If this setting is set to OFF, the same setting on the receiving monitor must also be set to OFF.

**NOTE:** When "PROTOCOL" of the transmitter is set to 57 and the receiving monitor is able to receive protocol 57, ECG measurement on the receiving monitor is automatically set to OFF when this setting is set to OFF on the transmitter.

- 1** On the PARAMETER SETUP screen, press the ► key to move the cursor to "ECG MEASUREMENT".
- 2** Press the Function key.
- 3** Press the ► key to select "ON" or "OFF".
- 4** Press the Function key to register the selected setting. The cursor returns to "ECG MEASUREMENT".

## RESP MEASUREMENT

Turn respiration monitoring on or off. When this setting is set to OFF, the same setting on the receiving monitor is automatically set to OFF.

- 1** On the PARAMETER SETUP screen, press the ► key to move the cursor to "RESP MEASUREMENT".
- 2** Press the Function key.
- 3** Press the ► key to select "ON" or "OFF".
- 4** Press the Function key to register the selected setting. The cursor returns to "RESP MEASUREMENT".

## SpO<sub>2</sub> RESPONSE

Select the SpO<sub>2</sub> response mode from FAST, NORMAL or SLOW. For details on the response time, refer to the “Specifications - SpO<sub>2</sub> Measurement (ISO 9919: 2005 compliant)” section in this manual.

**NOTE:** When measurement condition is unstable due to strenuous movement of the patient, etc., response may become slower in all modes.

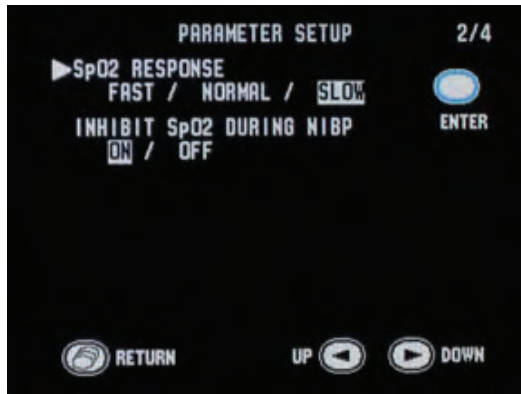

- 1 On the PARAMETER SETUP screen, press the ► key to move the cursor to “SpO<sub>2</sub> RESPONSE”. “SpO<sub>2</sub> RESPONSE” is on the second page of the PARAMETER SETUP screen.
- 2 Press the Function key.
- 3 Press the ► key to select “FAST”, “NORMAL” or “SLOW”.
- 4 Press the Function key to register the selected setting. The cursor returns to “SpO<sub>2</sub> RESPONSE”.

PARAMETER SETUP screen - page 2

## INHIBIT SpO<sub>2</sub> DURING NIBP

Turn SpO<sub>2</sub> monitoring on or off during NIBP measurement.

When the SpO<sub>2</sub> probe is attached to the same limb as the NIBP cuff and this setting is set to OFF, the pulse may become unstable and SpO<sub>2</sub> or PR alarm may occur. It is recommended to set this setting to ON so that SpO<sub>2</sub> is not measured during NIBP measurement.

When the SpO<sub>2</sub> probe is attached to the other limb from the NIBP cuff, this setting can be set to OFF.

**NOTE:** When this “INHIBIT SpO<sub>2</sub> DURING NIBP” is set to OFF, refer to the “Monitoring SpO<sub>2</sub> during NIBP Measurement” section.

- 1 On the PARAMETER SETUP screen, press the ► key to move the cursor to “INHIBIT SpO<sub>2</sub> DURING NIBP”. “INHIBIT SpO<sub>2</sub> DURING NIBP” is on the second page of the PARAMETER SETUP screen.
- 2 Press the Function key.
- 3 Press the ► key to select “ON” or “OFF”.
- 4 Press the Function key to register the selected setting. The cursor returns to “INHIBIT SpO<sub>2</sub> DURING NIBP”.

**SELECTABLE INTERVALS (min)**

When the NIBP INTERVAL key is pressed, the measurement mode changes according to the modes selected in this item. MANUAL mode is already selected for the mode selection.

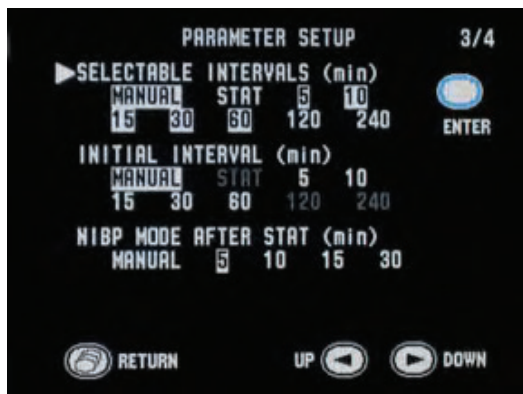

PARAMETER SETUP screen - page 3

- 1 On the PARAMETER SETUP screen, press the ► key to move the cursor to “SELECTABLE INTERVALS”. “SELECTABLE INTERVALS” is on the third page of the PARAMETER SETUP screen.
- 2 Press the Function key.
- 3 Press the ► key to select or unselect the mode. The selected modes are highlighted.
- 4 Press the Function key to register the selected setting. The cursor returns to “SELECTABLE INTERVALS”.

**INITIAL INTERVAL (min)**

Select the initial NIBP measurement mode at power on.

- 1 On the PARAMETER SETUP screen, press the ► key to move the cursor to “INITIAL INTERVAL”. “INITIAL INTERVAL” is on the third page of the PARAMETER SETUP screen.
- 2 Press the Function key.
- 3 Press the ► key to select the mode. Only the mode or interval selected for “SELECTABLE INTERVALS” are available.
- 4 Press the Function key to register the selected setting. The cursor returns to “INITIAL INTERVAL”.

**NIBP MODE AFTER STAT (min)**

Select the NIBP measurement mode after completing the STAT measurement.

- 1 On the PARAMETER SETUP screen, press the ► key to move the cursor to “NIBP MODE AFTER STAT”. “NIBP MODE AFTER STAT” is on the third page of the PARAMETER SETUP screen.
- 2 Press the Function key.
- 3 Press the ► key to select the mode. Only the mode or interval selected for “SELECTABLE INTERVALS” are available.
- 4 Press the Function key to register the selected setting. The cursor returns to “NIBP MODE AFTER STAT”.



## START/FINISH SOUND

Turn on or off the sound for NIBP measurement start and finish.



PARAMETER SETUP screen - page 4

- 1 On the PARAMETER SETUP screen, press the ▶ key to move the cursor to “START/FINISH SOUND”. “START/FINISH SOUND” is on the fourth page of the PARAMETER SETUP screen.
- 2 Press the Function key. The cursor moves to “START”.
- 3 Press the ▶ key to turn “ON” or “OFF” the sound for NIBP measurement start.
- 4 Press the Function key to register the setting for “START”. The cursor moves to “FINISH”.
- 5 Press the ▶ key to turn “ON” or “OFF” the sound for NIBP measurement finish.
- 6 Press the Function key to register the selected setting. The cursor returns to “START/FINISH SOUND”.

## OLD NIBP DATA/AFTER (min)

Select whether to dim or hide the NIBP data after measurement and how long to wait after NIBP measurement to dim or hide it.

- 1 On the PARAMETER SETUP screen, press the ▶ key to move the cursor to “OLD NIBP DATA/AFTER”. “OLD NIBP DATA/AFTER” is on the fourth page of the PARAMETER SETUP screen.
- 2 Press the Function key. The cursor moves to “DATA”.
- 3 Press the ▶ key to select “HIDE” or “DIM” the NIBP data.
- 4 Press the Function key to register the setting for “DATA”. The cursor moves to “AFTER”.
- 5 Press the ▶ key to select the interval after NIBP measurement to dim or hide.
- 6 Press the Function key to register the selected setting. The cursor returns to “OLD NIBP DATA/AFTER”.

## **INITIAL CUFF PRESSURE (mmHg)**

Select the NIBP cuff inflation pressure.

- 1** On the PARAMETER SETUP screen, press the ► key to move the cursor to “INITIAL CUFF PRESSURE”. “INITIAL CUFF PRESSURE” is on the fourth page of the PARAMETER SETUP screen.
- 2** Press the Function key.
- 3** Press the ► key to select the inflation pressure.
- 4** Press the Function key to register the selected setting. The cursor returns to “INITIAL CUFF PRESSURE”.

## Changing SYSTEM SETUP Settings

### System Setup Setting List

The factory default settings are underlined.

Setting Item	Description	Settings
PROTOCOL	<p>Select the transmitting protocol.</p> <p>57: New protocol. A central monitor with an ORG-9100A, ORG-9110A or ORG-9700A multiple patient receiver whose software version 02-01 or later can receive this protocol.</p> <p>42: Old protocol. A central monitor with an ORG-9100A, ORG-9110A or ORG-9700A multiple patient receiver can receive this protocol.</p> <p>NOTE: When 57 is set, the receiving monitor must be able to receive protocol 57. Otherwise, signals from the transmitter cannot be received.</p>	<u>57</u> , 42
BRIGHTNESS	Select the screen brightness.	<u>DARK</u> , BRIGHT
PRESSURE UNIT	Select the unit for NIBP.	<u>mmHg</u> , kPa
FUNCTION KEY	<p>Select the function of the Function key.</p> <p>SUSPEND ALARM &amp; PAUSE: Suspends alarm on the receiving monitor for 2 minutes. Pauses monitoring on the transmitter and receiving monitor.</p> <p>SUSPEND ALARM: Suspends alarm on the receiving monitor for 2 minutes.</p> <p>CONFIRM: Displays the "PATIENT CONFIRMED" message on the transmitter screen and transmits the message to the receiving monitor.</p> <p>OFF: No function.</p> <p>NOTE: "SUSPEND ALARM &amp; PAUSE" and "CONFIRM" can only be set when PROTOCOL is set to 57.</p>	<u>SUSPEND ALARM &amp; PAUSE</u> , SUSPEND ALARM, CONFIRM, OFF
AUTO RESUME AFTER PAUSE	Select the interval to resume monitoring after PAUSE.	10 s, <u>30 s</u> , 1 min, 2 min, 3 min
SELECTABLE SCREEN TIME OUT PERIOD (min)	Select the display time-out period.	5, 10, 15, <u>30</u> , 60, 120, 240

## Displaying the SYSTEM SETUP Screen

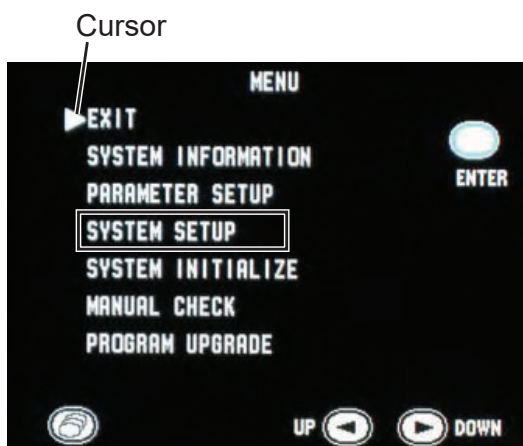

MENU screen

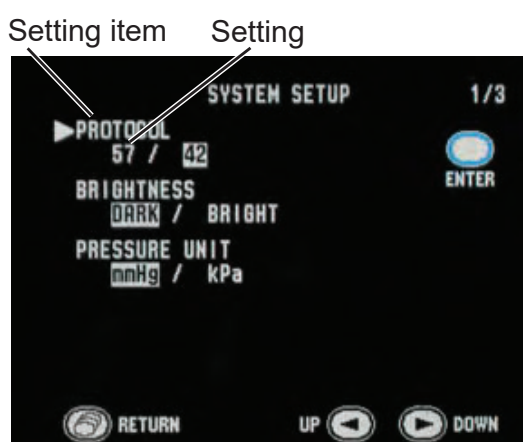

SYSTEM SETUP screen - page 1

- 1 Turn off the transmitter by removing one battery.
- 2 While pressing the Function key, turn on the transmitter by inserting the battery. The MENU screen appears.
- 3 Press the ► key to move the cursor to “SYSTEM SETUP”.
- 4 Press the Function key to enter SYSTEM SETUP. The current settings are highlighted.
- 5 Change settings.
  - To move the cursor and select the setting item, press the ◀ or ▶ key then press the Function key.
  - To select and register the setting, press the ◀ or ▶ key then press the Function key.
  - To cancel changing the setting of the selected item, press the Screen key.

The SYSTEM SETUP screen has two pages. To display the second page, press the ► key when the cursor is at “PRESSURE UNIT”.
- 6 When changing settings on the SYSTEM SETUP screen is complete, press the Screen key to return to the MENU screen.
- 7 Press the ◀ or ▶ key to move the cursor to “EXIT”.
- 8 Press the Function key. The numeric and waveform screen appears.

## Changing System Setup Settings

### PROTOCOL

Select the transmitting protocol. For differences between protocols, refer to the table below.

57: New protocol. A central monitor with an ORG-9100A, ORG-9110A or ORG-9700A multiple patient receiver whose software version 02-01 or later can receive this protocol.

42: Old protocol. A central monitor with ORG-9100A, ORG-9110A or ORG-9700A multiple patient receiver can receive this protocol.

**NOTE:** When 57 is set, the receiving monitor must be able to receive protocol 57. Otherwise, signals from the transmitter cannot be received.

### Differences Between Protocols

Function	Protocol 42	Protocol 57
Setting ECG MEASUREMENT to OFF on the transmitter automatically turns off the ECG measurement setting on the receiving monitor	No (ECG measurement must be turned off on the receiving monitor)	Yes
Pause monitoring on the receiving monitor from the transmitter	No	Yes
Transmit "PATIENT CONFIRMED" message	No	Yes
Display battery level of the transmitter on the receiving monitor	No	Yes
Transmit SpO <sub>2</sub> messages	Some messages (refer to the "Indication and Message List" section)	All messages

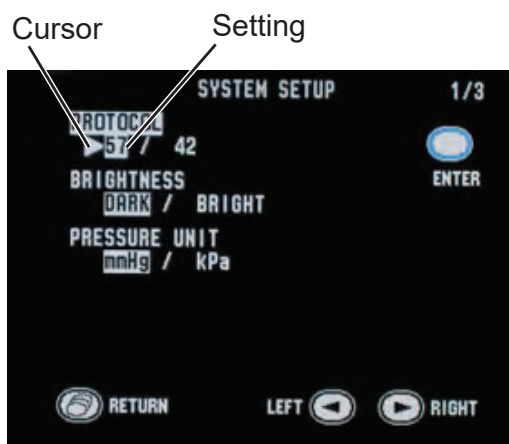

- 1 Press the ► key to move the cursor to "PROTOCOL".
- 2 Press the Function key.
- 3 Press the ► key to select "42" or "57".



NOTE: FUNCTION KEY (on the second page of the SYSTEM SETUP screen) can be set to “SUSPEND ALARM & PAUSE” or “CONFIRM” only when PROTOCOL is “57”. If PROTOCOL is changed to “42”, FUNCTION KEY is automatically changed to “OFF”.

- 4 Press the Function key to register the selected setting. The cursor returns to “PROTOCOL”.

## BRIGHTNESS

Select the screen brightness.

- 1 Press the ► key to move the cursor to “BRIGHTNESS”.
- 2 Press the Function key.
- 3 Press the ► key to select “DARK” or “BRIGHT”.
- 4 Press the Function key to register the selected setting. The cursor returns to “BRIGHTNESS”.

## PRESSURE UNIT

Select the unit for NIBP.

- 1 Press the ► key to move the cursor to “PRESSURE UNIT”.
- 2 Press the Function key.
- 3 Press the ► key to select “mmHg” or “kPa”.
- 4 Press the Function key to register the selected setting. The cursor returns to “PRESSURE UNIT”.

## FUNCTION KEY

Select the function of the Function key. For details on using these functions, refer to “Basic Monitoring Operation” in the “Monitoring” section.

**SUSPEND ALARM & PAUSE:** Suspends alarm on the receiving monitor for 2 minutes.  
Pauses monitoring on the transmitter and receiving monitor.

**SUSPEND ALARM:** Suspends alarm on the receiving monitor for 2 minutes.

**CONFIRM:** Displays the “PATIENT CONFIRMED” message on the transmitter screen and transmits the message to the receiving monitor.

**OFF:** No function.

**NOTE:** “SUSPEND ALARM & PAUSE” and “CONFIRM” can only be set when PROTOCOL is set to 57.

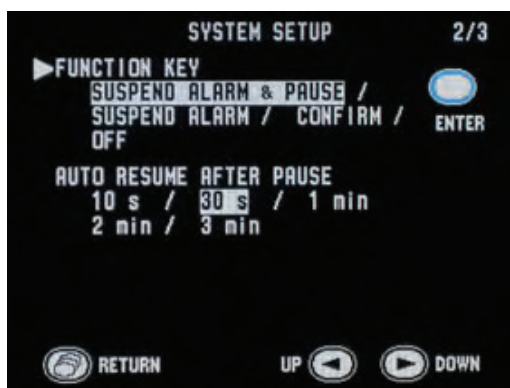

SYSTEM SETUP screen - page 2

- 1 On the SYSTEM SETUP screen, press the ► key to move the cursor to “FUNCTION KEY”. “FUNCTION KEY” is on the second page of the SYSTEM SETUP screen.
- 2 Press the Function key.
- 3 Press the ► key to select the function.
- 4 Press the Function key to register the selected setting. The cursor returns to “FUNCTION KEY”.

## AUTO RESUME AFTER PAUSE

Select the interval to resume monitoring after PAUSE. When either of the following conditions is met, monitoring resumes on the receiving monitor.

- Heart rate is properly monitored for the selected interval.
- SpO<sub>2</sub> is properly monitored for the selected interval.
- NIBP is properly measured and the SYS, DIA or MAP value is displayed.

- 1 Press the ► key to move the cursor to “AUTO RESUME AFTER PAUSE”. “AUTO RESUME AFTER PAUSE” is on the second page of the SYSTEM SETUP screen.
- 2 Press the Function key.
- 3 Press the ► key to select the interval.
- 4 Press the Function key to register the selected setting. The cursor returns to “AUTO RESUME AFTER PAUSE”.

**SELECTABLE SCREEN TIME OUT PERIOD (min)**

Select the display time-out period. If no key is pressed for the selected time, the display is automatically turned off. The selected time is shown on the Select Screen Time Out Period screen. Refer to the “Turning the Display Off” section for details.

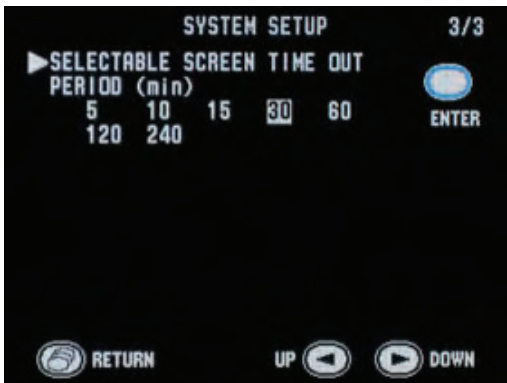

SYSTEM SETUP screen - page 2

- 1** Press the ► key to move the cursor to “SELECTABLE SCREEN TIME OUT PERIOD (min)”. It is on the third page of the SYSTEM SETUP screen.
- 2** Press the Function key.
- 3** Press the ◀ or ▶ key to select time-out period.
- 4** Press the Function key to register the selected setting. The cursor returns to “SELECTABLE SCREEN TIME OUT PERIOD (min)”.



## Initializing Settings

Do the following procedure to initialize all settings, except for channel, to the factory default settings.

Cursor

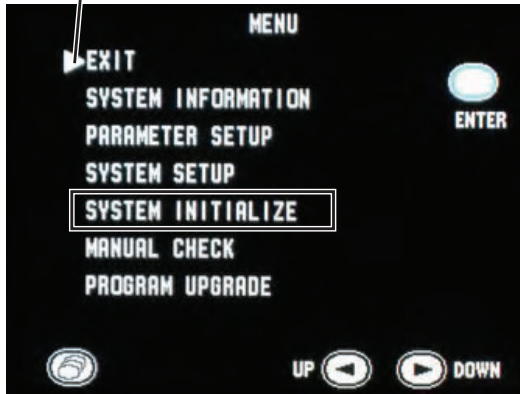

**1** Turn off the transmitter by removing a battery.

**2** While pressing the Function key, turn on the transmitter by inserting the battery. The MENU screen appears.

**3** Press the ► key to move the cursor to “SYSTEM INITIALIZE”.

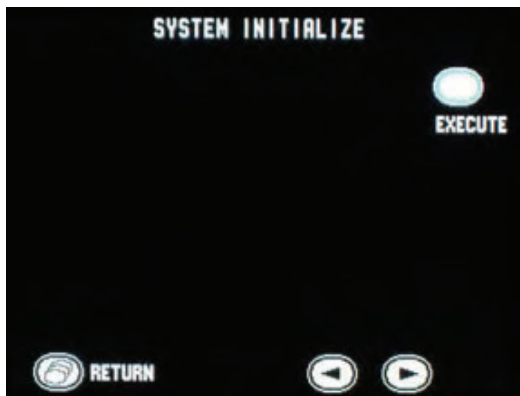

**4** Press the Function key to enter the SYSTEM INITIALIZE screen.

**5** Press the Function key. A confirmation message appears.

To return to the MENU screen without initializing, press the Screen key.

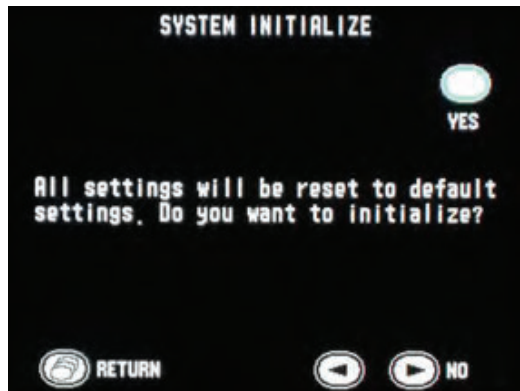

**6** Press the Function key to initialize settings. To cancel initializing, press the ► key. The screen returns to the MENU screen.

## Attaching Electrodes, SpO<sub>2</sub> Probe and NIBP Cuff to the Patient

The transmitter can be placed on the bedside. The required length of the electrode leads and SpO<sub>2</sub> probe cable depends on how the transmitter is to be attached to the patient.

### NOTE: Monitoring SpO<sub>2</sub> during NIBP Measurement

When the SpO<sub>2</sub> probe is attached to the same limb as the NIBP cuff, the blood flow decreases during NIBP measurement and pulse wave cannot be detected and SpO<sub>2</sub> cannot be monitored properly. When "INHIBIT SpO<sub>2</sub> DURING NIBP" on the PARAMETER SETUP screen is set to ON (factory default setting), SpO<sub>2</sub> monitoring is paused during NIBP measurement to avoid SpO<sub>2</sub> alarm occurrence. However, when monitoring SpO<sub>2</sub> on the same limb as NIBP, be careful when reading SpO<sub>2</sub> values.

When monitoring SpO<sub>2</sub> is important, attach the probe to the limb to which the NIBP cuff or catheter is not attached.

---

## Attachment Example

### When transmitter is placed on a bed

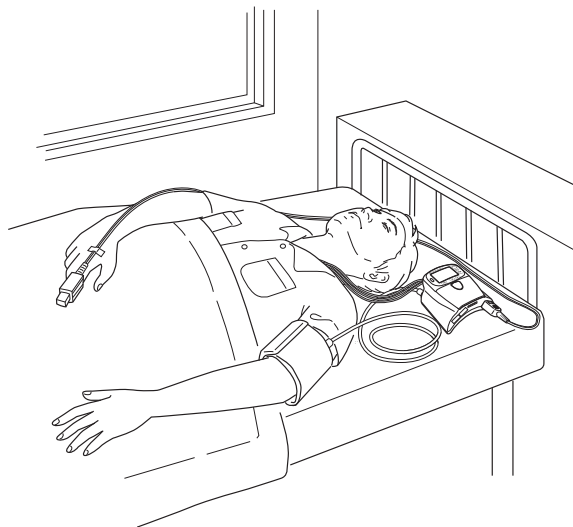

NOTE: When placing the transmitter on a bedside, place it on a stable and flat place. If the transmitter falls off, it may be damaged.

## Selecting Electrode Leads



Only use the electrodes and electrode leads specified in the manual. When other type of electrodes or electrode leads are used, the **OD** message may be displayed and monitoring may stop.

Select the disposable electrodes and electrode leads which are appropriate for the number of electrodes (leads). Refer to the “Options” section for details.

## Connecting the Electrode Lead to the Transmitter

Connect the electrode lead to the ECG/RESP socket on the transmitter.

**NOTE:** Hold the sides of the transmitter when connecting or disconnecting the electrode lead. Pressing the display while holding the transmitter may damage the transmitter.

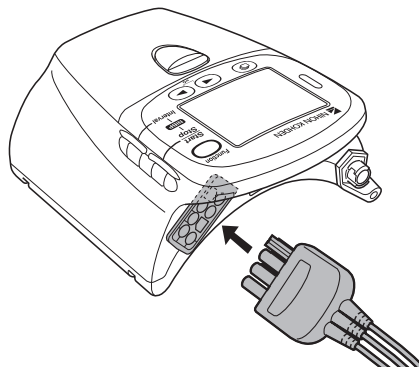

Do not shake or swing the transmitter while holding the leads or cables connected to the transmitter. The transmitter may come off and injure someone or damage surrounding instruments.



Hold the connector of the electrode lead when connecting or disconnecting the electrode lead. If you disconnect the electrode lead by pulling the lead, it damages the electrode lead.

## Electrode Position

Follow the physician's instructions for electrode placement when available.

For ECG monitoring, electrodes are attached only on the chest to allow patient movement and obtain continuous stable ECG. The following leads are examples. When also monitoring respiration, refer to the "Electrode Position for Respiration Monitoring" section.

**NOTE:** The optimum electrode positions for ECG measurement are not always optimum for respiration measurement. Select positions that are suitable for both ECG and respiration measurement or positions which give priority to either ECG or respiration measurement.

### Electrode Positions for ECG Monitoring

#### 6-electrode Leads

V<sub>a</sub> and V<sub>b</sub> can be any of the standard 12 leads V<sub>1</sub> to V<sub>6</sub>.

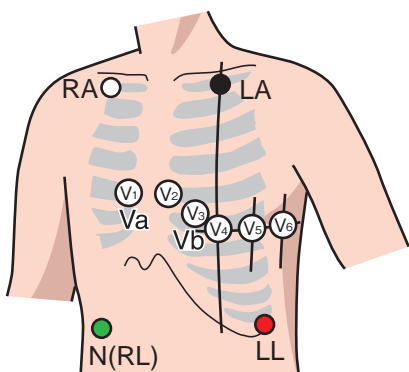

V<sub>1</sub>: Fourth intercostal space at the right border of the sternum

V<sub>2</sub>: Fourth intercostal space at the left border of the sternum

V<sub>3</sub>: Halfway between V<sub>2</sub> and V<sub>4</sub>

V<sub>4</sub>: Fifth intercostal space on the left midclavicular line

V<sub>5</sub>: Left anterior axillary line at the same level as V<sub>4</sub>

V<sub>6</sub>: Left midaxillary line at the same level as V<sub>4</sub>

Symbol	Electrode Lead		Electrode Placement
	Lead Color	Clip or Hook Color	
RA	White	White	Right infraclavicular fossa
LA	Black	Black	Left infraclavicular fossa
LL	Red	Red	Lowest rib on the left anterior axillary line
N (RL)	Green	Green	Right anterior axillary line at the same level as LL
V <sub>a</sub>	Brown - Red	Red	Any two of the V <sub>1</sub> to V <sub>6</sub> positions
V <sub>b</sub>	Brown - Green	Green	

N is the electrical reference point.

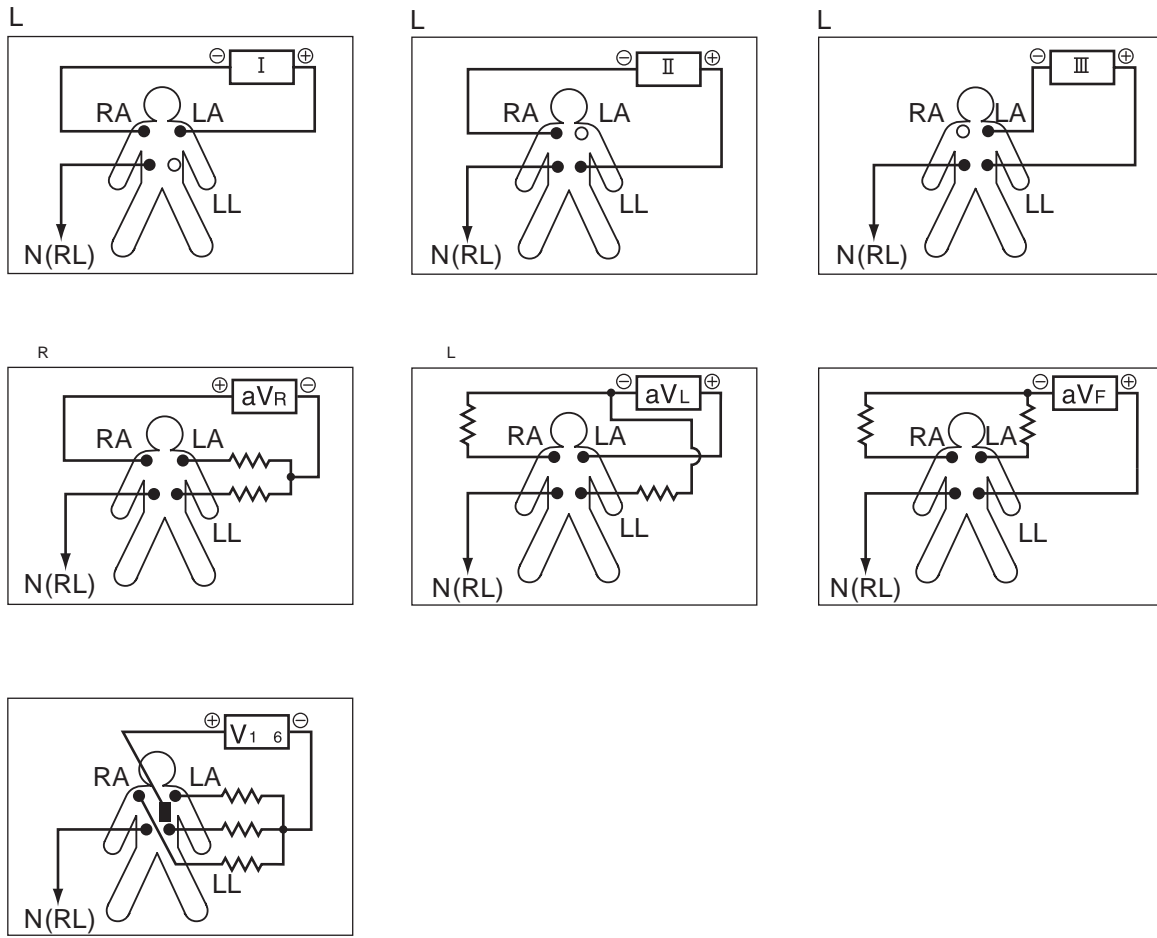

### 3-electrode Leads

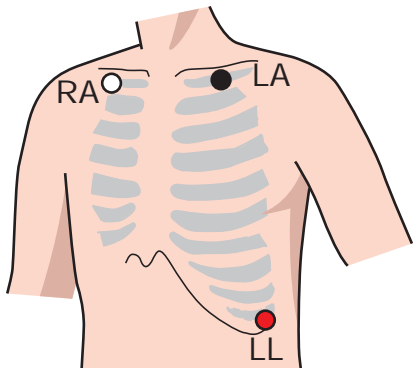

Symbol	Electrode Lead		Electrode Placement
	Lead Color	Clip or Hook Color	
RA	White	White	Right infraclavicular fossa
LA	Black	Black	Left infraclavicular fossa
LL	Red	Red	Lowest rib on the left anterior axillary line

N is the electrical reference point.

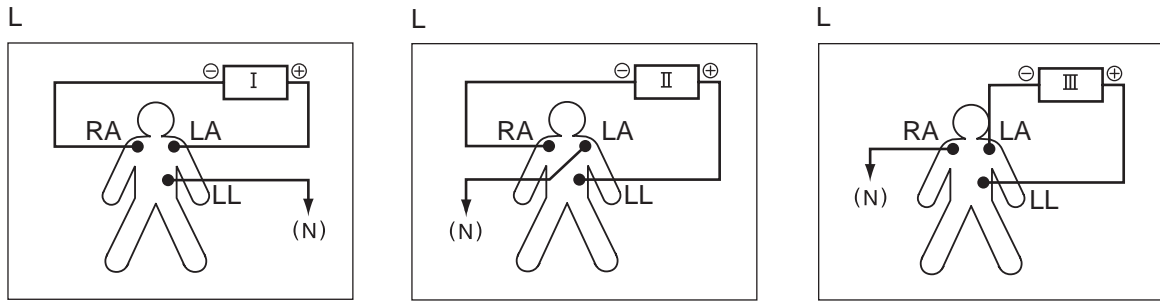

### Electrode Positions for Respiration Monitoring

Place the RA and LL electrodes so that the lungs are between the electrodes.

#### Position 1

In this position, respiration measurement is available; however, there is a difference in amplitude between different patients.

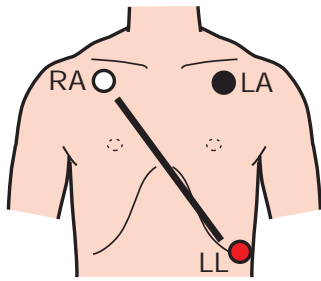

RA	LL
Right infraclavicular fossa	Fifth intercostal space on the left midclavicular line, V <sub>4</sub>

#### Position 2

In this position, the waveform amplitude is usually large and the ECG lead is similar to Lead MII. This position can be generally recommended.

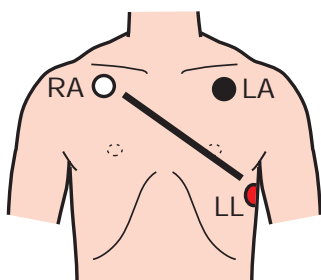

RA	LL
Right infraclavicular fossa	Fifth intercostal space on the left midaxillary line, V <sub>6</sub>

**Position 3**

In this position, the respiration waveform is optimum, but the ECG lead is unusual.

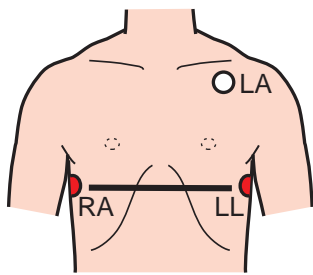

RA	LL
Right midaxillary at the horizontal level of V <sub>6</sub>	Fifth intercostal space on the left midaxillary line, V <sub>6</sub>

**Position 4**

In this position, the respiration measurement is influenced by the impedance variation of the abdomen, so the cardiac pulse wave included in the respiration wave is reduced. Note that the waveform is inverted in phase compared with the chest movement (the waveform goes down during inspiration). It is difficult to measure the ECG at the same time.

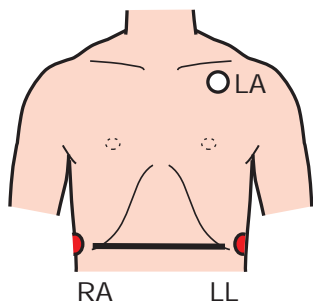

RA	LL
Lowest rib on the right anterior axillary line	Lowest rib on the left anterior axillary line

**Attaching Electrodes to the Patient and Connecting the Electrode Leads to Disposable Electrodes**

**Prepare the Patient Skin**

Shave off excessive body hair.

To reduce skin impedance, clean the electrode site with cream or with a cotton pad moistened with alcohol. Thoroughly dry the skin with a clean cotton pad.

- NOTE**
- For a patient with frequent body movement, rub the sites with Skinpure skin preparation gel. However, do not use Skinpure skin preparation gel on sensitive skin.
  - Do not place electrodes on a wound or on an inflamed, wrinkled or uneven skin surface.

## Attaching Electrodes to the Patient

⚠ A I N

Do not reuse disposable parts and accessories.

- NOTE**
- To maintain good contact between the electrode and skin, check that the paste of the disposable electrode is not dry.
  - When contact between the disposable electrode and skin becomes poor, replace electrodes with new ones immediately. Otherwise, contact impedance between the skin and the electrode increases and accurate ECG cannot be obtained.

Refer to the electrode operator's manual for details.

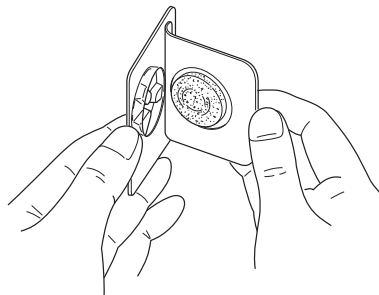

- 1** Carefully remove the backing paper from the electrode. Avoid touching the adhesive surface.
- 2** Place the electrode on the previously cleaned skin. Pay attention to the electrode lead color and symbol.
- 3** Clip the electrode lead to the electrode.
- 4** Fasten the electrode lead wire with surgical tape with an extra length of wire between the tape and the electrode. This lessens the movement of electrode leads by body movement and helps stable monitoring.

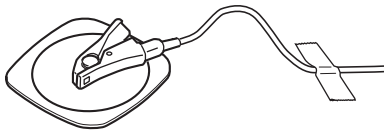

## Checking ECG on the Transmitter Screen

After attaching electrodes and connecting ECG leads, check that the electrodes are properly attached to the patient and the ECG waveform is acquired on the check electrodes screen. For details on the screen, refer to the "Screen Descriptions" section.



## Attaching the SpO<sub>2</sub> Probe

### Selecting the SpO<sub>2</sub> Probe

Select an appropriate probe for the patient.

**⚠ CAUTION**

Only use Nihon Kohden specified electrodes, electrode leads, SpO<sub>2</sub> probes, and NIBP cuffs. Otherwise, the maximum performance from the transmitter cannot be guaranteed.

**⚠ A I N**

Do not use a damaged or disassembled probe. It causes incorrect measurement and may injure the patient.

### Reusable Probes

When using a TL-201T finger probe, choose the appropriate cable length for attachment.

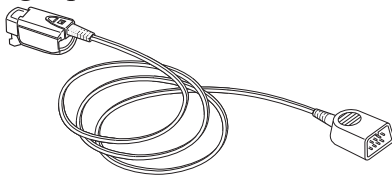
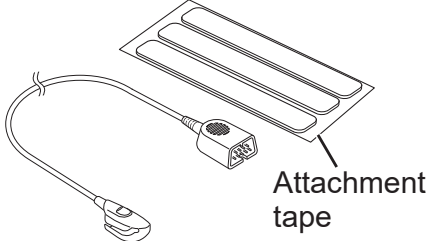
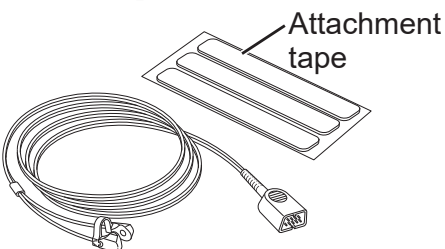
Probe	Cable Length	Patient	Attachment Site
Finger probe TL-201T 	0.6 m	Adult or child 20 kg or more	Finger
	1.6 m		
Finger probe TL-631T1, TL-631T3 	TL-631T1: 0.6 m	Adult or child 20 kg or more	Finger or toe
	TL-631T3: 1.6 m		
Multi-site probe TL-220T 	1.6 m	Adult or infant 3 kg or more	Finger or toe
		Neonate 3 kg or less	Instep and sole

## Disposable Probes

### ⚠ A I N

The disposable probe is not sterilized. Use the disposable probe only for a single patient. Never reuse the disposable probe for another patient because it causes cross infection.

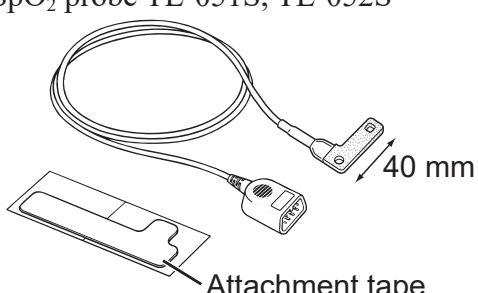
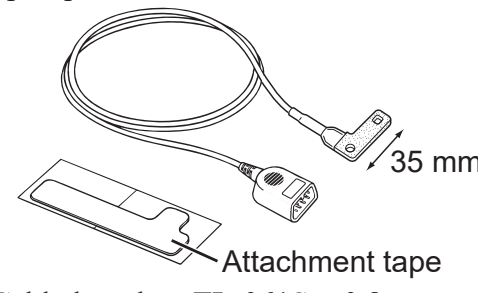
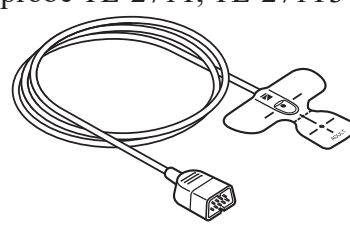
Probe	Patient	Attachment Site
SpO <sub>2</sub> probe TL-051S, TL-052S  Cable length TL-051S: 0.8 m TL-052S: 1.6 m	Adult 50 kg or more	Finger
	Neonate 3 kg or less	Instep and sole
SpO <sub>2</sub> probe TL-061S, TL-062S  Cable length TL-061S: 0.8 m TL-062S: 1.6 m	Adult or child 15 to 50 kg	Finger
	Infant 3 to 15 kg	Toe
SpO <sub>2</sub> probe TL-271T, TL-271T3  Cable length TL-271T: 0.8 m TL-271T3: 1.6 m	Adult 30 kg or more	Finger or toe

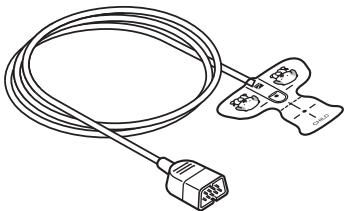
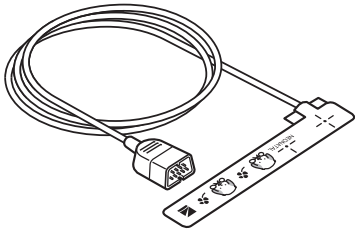
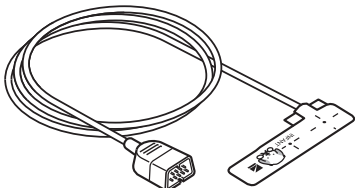
Probe	Patient	Attachment Site
<p>SpO<sub>2</sub> probe TL-272T, TL-272T3</p>  <p>Cable length TL-272T: 0.8 m TL-272T3: 1.6 m</p>	<p>Child 10 to 50 kg</p>	<p>Finger or toe</p>
<p>SpO<sub>2</sub> probe TL-273T, TL-273T3</p>  <p>Cable length TL-273T: 0.8 m TL-273T3: 1.6 m</p>	<p>Neonate 3 kg or less</p>	<p>Instep and sole</p>
<p>SpO<sub>2</sub> probe TL-274T, TL-274T3</p>  <p>Cable length TL-274T: 0.8 m TL-274T3: 1.6 m</p>	<p>Infant 3 to 20 kg</p>	<p>Finger or toe</p>

## Connecting the SpO<sub>2</sub> Probe to the Transmitter

Connect the probe to the SpO<sub>2</sub> socket on the transmitter.

**NOTE:** Hold the connector of the probe cable when connecting or disconnecting the probe. Pulling the cable may damage the probe.

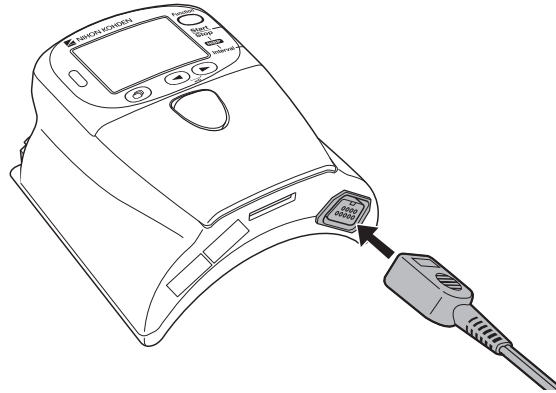

**⚠ A I N**

Do not shake or swing the transmitter while holding the leads or cables connected to the transmitter.

The transmitter may come off and injure someone or damage surrounding instruments.

**⚠ A I N**

Do not use a damaged or disassembled probe. It causes incorrect measurement and may injure the patient.

## Attaching the Probe to the Patient

Attach the probe to the patient by referring to the probe's manual. Make sure that the light emitter and photo detector of the probe face each other at the attachment site.

### WARNING

When using the \_\_\_\_\_ finger probe, do not fasten the probe and cable to the finger by wrapping with tape. This may cause burn, congestion or pressure necrosis from poor blood circulation.

When using probes other than the \_\_\_\_\_ finger probe, to avoid poor circulation, do not wrap the tape too tight. Check the blood circulation condition by observing the \_\_\_\_\_ in color and congestion at the \_\_\_\_\_ in peripheral to the probe attachment site. Even for short term monitoring, there may be burn or pressure necrosis from poor blood circulation, especially on neonates or low birth weight infants whose \_\_\_\_\_ is delicate. Accurate measurement cannot be performed on a site with poor peripheral circulation.

### WARNING

Check the circulation condition by observing the \_\_\_\_\_ in color at the measurement site and pulse waveform. Change the measurement site every \_\_\_\_\_ hours for disposable probes and every \_\_\_\_\_ hours for reusable probes every \_\_\_\_\_ hours for \_\_\_\_\_ series probe. The \_\_\_\_\_ in temperature may increase at the attached site by \_\_\_\_\_ or \_\_\_\_\_ and cause a burn or pressure necrosis. When using the probe on the following patients, take extreme care and change the measurement site more frequently according to symptoms and degree.

patient with a fever

patient with insufficient peripheral circulation

neonate or low birth weight infant with delicate \_\_\_\_\_ in

 WARNING

When monitoring  $pO_2$  of a patient who is receiving photodynamic therapy, the light from the finger probe sensor may cause a burn.

Photodynamic therapy uses a photosensitizing agent that has a side effect of photosensitivity.

The  $SpO_2$  probes manufactured by Nihon Kohden have two wavelengths with peaks in the range of 650 and 950 nm. The maximum light intensity is less than 5.5 mW.

 A I N

If the attachment site is dirty with blood or bodily fluids, clean the attachment site before attaching the probe. If there is nail polish on the attachment site, remove the polish. Otherwise, the amount of transmitted light decreases, and measured value may be incorrect or measurement cannot be performed.

 A I N

When the probe is attached on an appropriate site with sufficient thickness and the error message confirming the probe attachment repeatedly appears, the probe may be deteriorated. Replace it with a new one.

 A I N

If the skin gets irritated or redness appears on the skin from the probe, change the attachment site or stop using the probe. Take extreme care for the patients with delicate skin.

 A I N

Do not use a probe which is deteriorated by aging. Accurate measurement cannot be performed.

## Attaching the NIBP Cuff

### Selecting the NIBP Cuff

Select the NIBP cuff appropriate for the patient.

NOTE: NIBP cannot be measured on neonates using this transmitter.

### Reusable Cuffs

To use these cuffs, an optional YN-990P extension hose (1.5 m) is required.

Reusable Cuff		Model	Width (cm)	Air Hose Length (cm)
<b>YAWARA CUFF2</b>				
For infant		YP-710T	5	15
For child		YP-711T	7	
For adult	Small	YP-712T	10	
	Standard	YP-713T	13	
	Large	YP-714T	16	

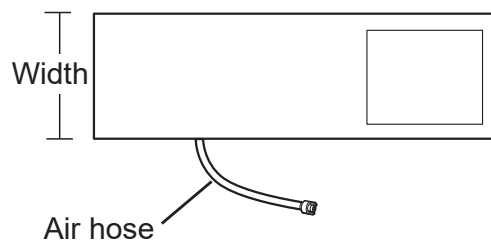

## Disposable Cuffs

### ⚠ A I N

Disposable cuffs are not sterilized. If necessary, sterilize the cuff using glutaraldehyde solution.

Disposable Cuff		Model	Width (cm)	Air Hose Length (cm)
For infant		YP-810P	6	17
For child		YP-811P	8	
For adult	Small	YP-812P	10	
	Standard	YP-813P	14	
	Medium large	YP-814P	15	
	Large	YP-815P	17	
Extra large		YP-816P	18	

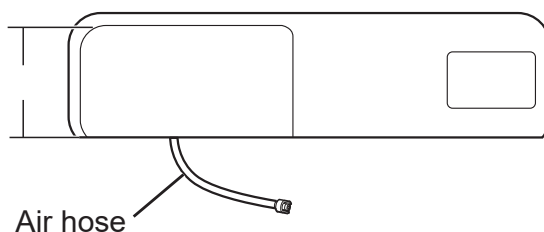

## Extension Hose

### ⚠ A I N

When using an extension hose, check that the extension hose is not bent or squeezed. Otherwise, the cuff might not inflate or deflate. If the cuff cannot deflate, it may cause congestion on the patient at the cuff attachment site.

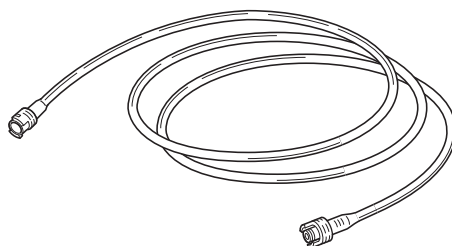

YN-990P extension hose, 150 cm



### Reference for selecting a cuff

The AHA (American Heart Association) recommends that the cuff width be 40% of the circumference of the upper arm. Refer to the following graph and select the cuff which suits the patient's arm.

- NOTE**
- If a range of arm circumference appropriate for the cuff is prescribed, use a cuff within that range.
  - To obtain accurate measured values, select a wide cuff which can be attached to the upper arm. Measuring with a very narrow cuff may result in measured values higher than the actual values.

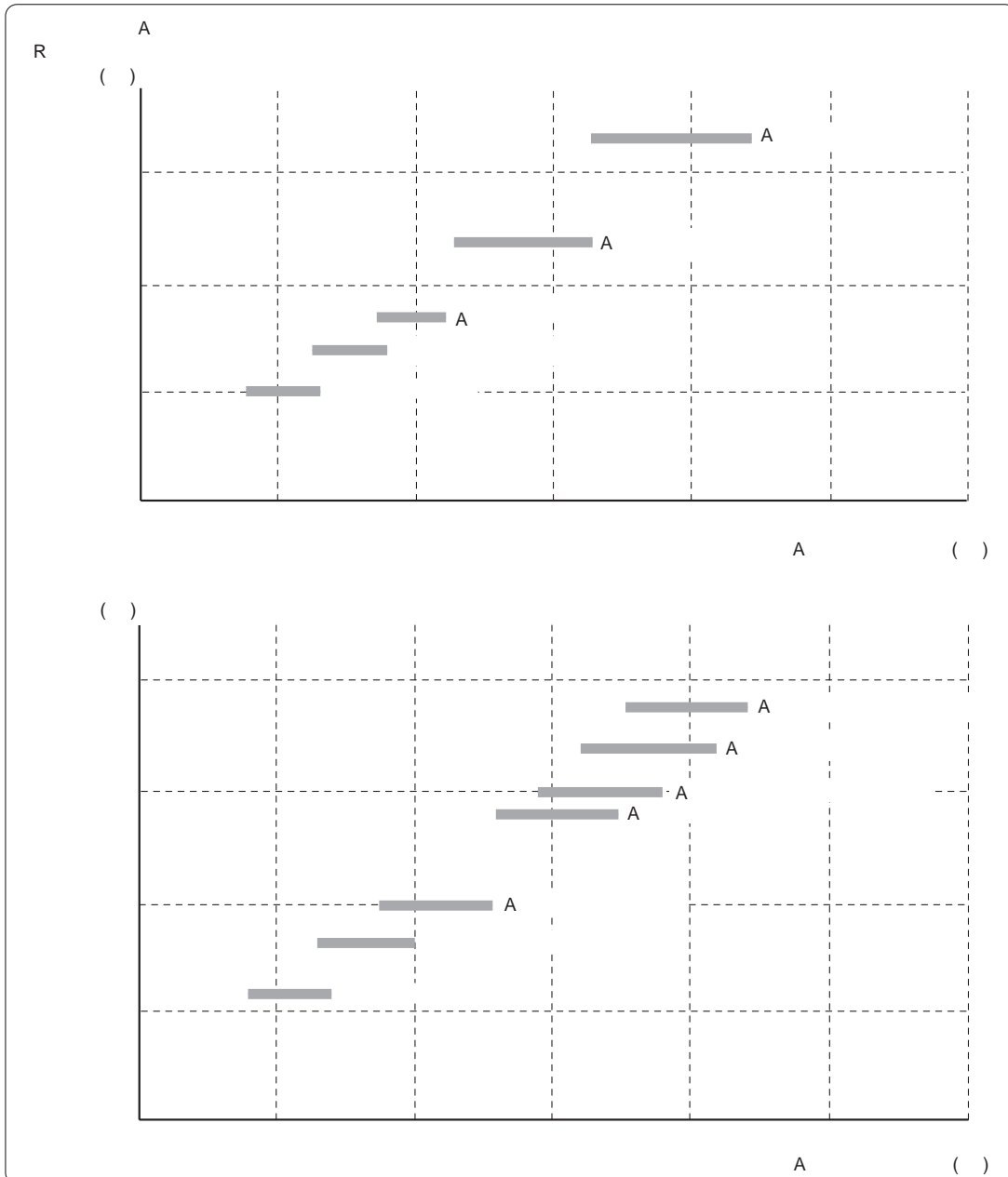

## Connecting the NIBP Cuff to the Transmitter

To use the YP-810P series disposable cuffs or YP-710T series reusable cuffs, an optional YN-990P extension hose (1.5 m) is required.

**NOTE:** Connect the joints properly. If there is an air leak, NIBP cannot be measured properly.

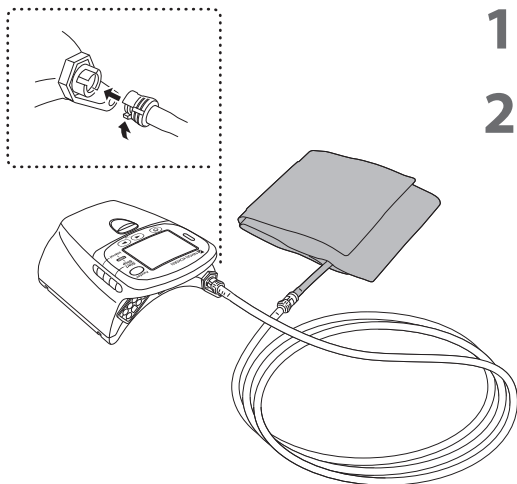

- 1** Connect the NIBP cuff to the extension hose.
- 2** Connect the other end of the extension hose to the NIBP socket on the transmitter. Turn the joint clockwise until it clicks.

To disconnect the cuff from the transmitter, turn the hose joint counterclockwise.

## Attaching the NIBP Cuff to the Patient

### ⚠ WARNING

Be careful when measuring on a patient with known bleeding disorders or coagulation. After measurement, there may be dot hemorrhage, or circulatory disorder by thrombus where the cuff is attached.

### ⚠ A I N

Do not wrap the cuff on an arm or thigh which is used for injection. Measurement on an arm or thigh which is used for injection may cause reflux of blood and stop injection.

### ⚠ A I N

Do not attach the cuff to the site where there is injury or inflammation. If the skin gets irritated or redness appears on the skin from the cuff, change the attachment site or stop using the cuff. Take extreme care on the patients with delicate skin.

 A I N

Do not wrap the cuff too tight. It may cause poor blood circulation and congestion. If the cuff is wrapped too loosely, the value may increase.

 A I N

Do not reuse disposable parts and accessories.

 A I N

and pO<sub>2</sub> can be measured on the same limb, but the pO<sub>2</sub> monitoring might not be accurate during measurement. Be careful when reading the pO<sub>2</sub> values.

\* Monitoring SpO<sub>2</sub> during NIBP Measurement

When the SpO<sub>2</sub> probe is attached to the same limb as the NIBP cuff, the blood flow decreases during NIBP measurement and pulse wave cannot be detected and SpO<sub>2</sub> cannot be monitored properly. When “INHIBIT SpO<sub>2</sub> DURING NIBP” on the PARAMETER SETUP screen is set to ON (factory default setting), SpO<sub>2</sub> monitoring is paused during NIBP measurement to avoid SpO<sub>2</sub> alarm occurrence. However, when monitoring SpO<sub>2</sub> on the same limb as the NIBP, be careful when reading SpO<sub>2</sub> values.

- NOTE
- Measuring NIBP at a site other than the upper arm gives different values from those measured at the upper arm. When making diagnosis based on the NIBP values, measure NIBP on an upper arm.
  - To accurately detect the pulsatile flow of the artery, the cuff should be wrapped around a bare upper arm.
  - Do not use an abnormal cuff. The cuff deteriorates from use and cleaning. Before use, check the cuff and confirm that there is no flaw, crack or hole in it. Be careful not to damage the inflation bag. If the inflation bag has a hole or a flaw, it may burst during use. Dispose of an abnormal cuff and replace it with a new one.
  - Refer to the NIBP cuff manual for details.

## Cuff Position

When placing the transmitter on a bed, make sure that the hose is not bent.

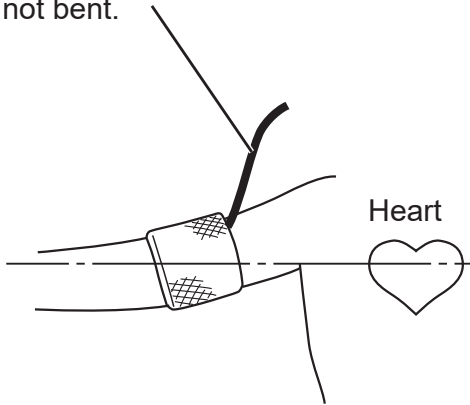

Place the cuffed upper arm (brachium) at the same height as the patient's heart. If the cuff is not at the same level as the heart, the weight of the blood affects the blood pressure reading. The pressure difference per unit height is 0.7 mmHg/cm. The blood pressure reading decreases when the arm is higher than the heart and increases when lower.

The best measuring condition is when the patient is lying on his/her back with arms and legs relaxed. If the cuff position cannot be on the same level as the heart, the displayed blood pressure reading must be mathematically adjusted.

## Placing the Transmitter on the Bed

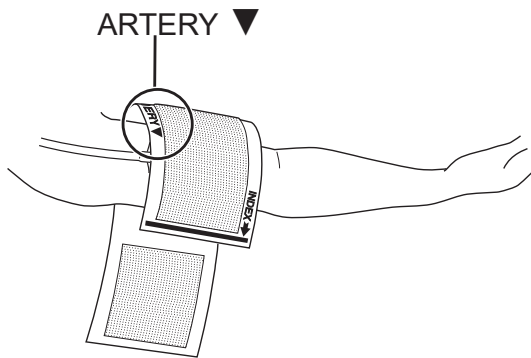

- 1 Put the cuff on the upper arm so that the ▼ mark of "ARTERY ▼" aligns with the artery of the patient.

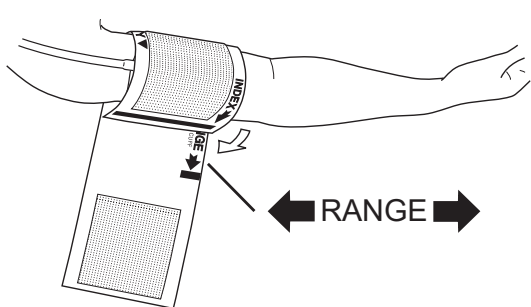

- 2 Wrap the cuff so that "INDEX →" comes within the "← RANGE →".  
If "Index →" is not within the "← RANGE →", change the cuff size.

## Locking the Keys on the Transmitter

To prevent the patient from pressing the keys on the transmitter during monitoring, you can lock the keys.

To lock the keys:

Press the ◀ and ▶ keys at the same time and hold for more than 3 seconds. The “Key locked” screen appears.



When the screen time-out period is set to “1 min” (factory default), the “Key locked” screen is displayed for 5 seconds, then the display turns off if there is no key operation.

When the screen time-out period is set to a certain number of minutes, the “Key locked” screen is displayed for 5 seconds, then it changes to the numeric and waveform screen. If there is no key operation, the display turns off when the remaining time elapses. Refer to the “Turning the Display Off” section for details.

To unlock the keys:

Press the ◀ and ▶ keys at the same time and hold for more than 3 seconds.

## Monitoring

⚠ A I N

The measurement values and displayed waveforms on the transmitter and receiving monitor may be different due to timing delay of the display or difference in detection settings.

- NOTE**
- The waveforms displayed on the check electrodes screen are just to check that the electrode or probe is attached to the patient properly. Do not use the displayed waveforms for other purposes.
  - Do not let the transmitter directly touch the patient's skin. The transmitter temperature rises and this may cause burn to the patient.

## Screen Descriptions

When the transmitter is turned on, the startup screen appears, then the check electrodes screen appears to check the electrode attachment.

The screen changes in the following order when the Screen key is pressed.

Check electrodes → numeric and waveform → waveform review → numeric review → display off → check electrodes . . .

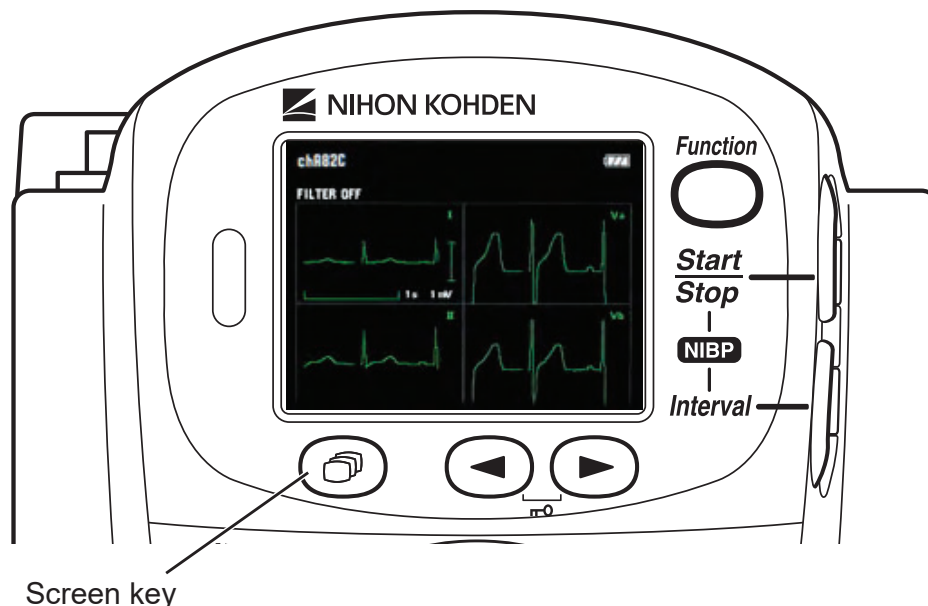

## Check Electrodes Screen

You can check whether the electrodes are properly attached to the patient and the ECG waveform is acquired.

When 6 leads are used, the I, II, Va and Vb lead waveforms are displayed.

When 3 leads are used, only the lead II waveform is displayed.

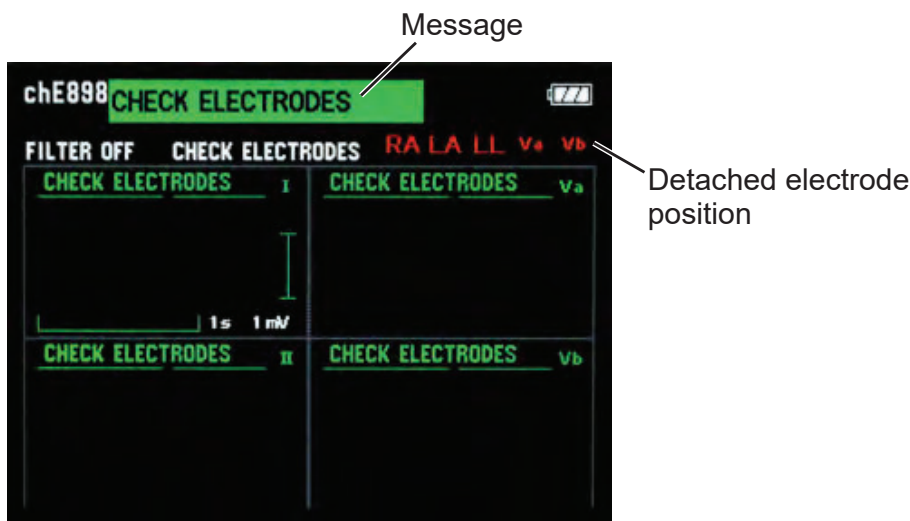
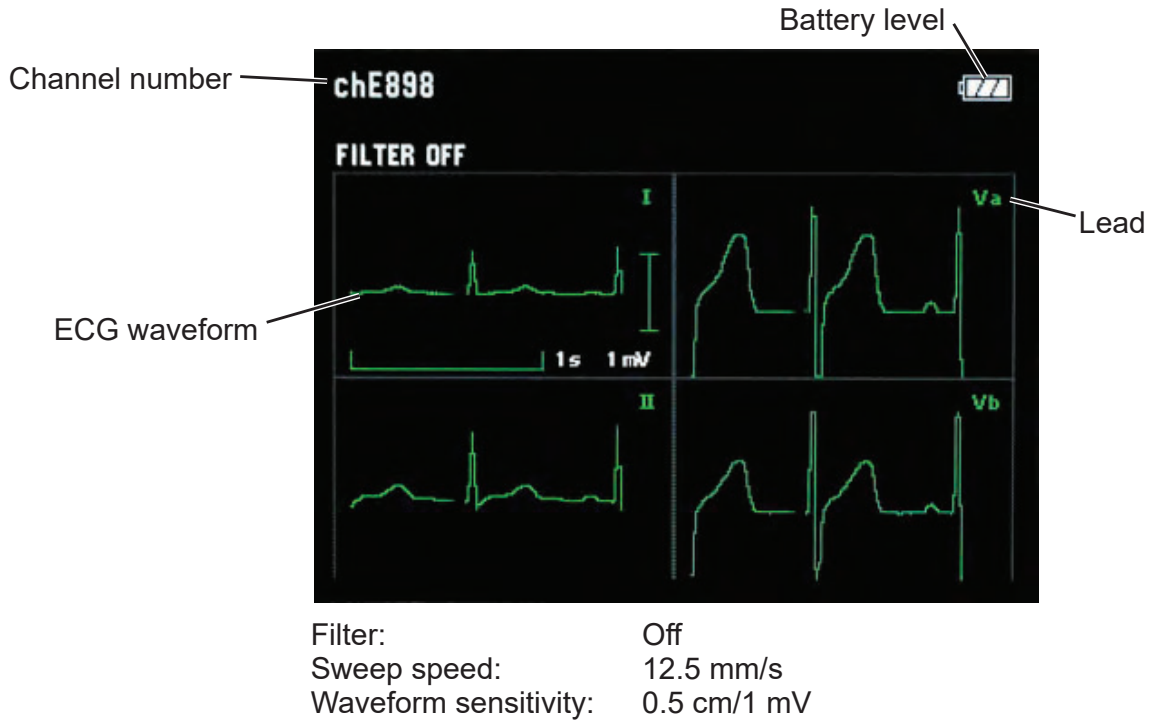

When electrodes are detached, the “CHECK ELECTRODES” message and detached electrode position appear on the screen.

**NOTE:** When ECG measurement is set to OFF on the PARAMETER SETUP screen, the check electrodes screen does not appear.

## Numeric and Waveform Screen

Numeric values and waveforms of the monitoring parameters are displayed. You can change the ECG lead with the ◀ and ▶ keys.

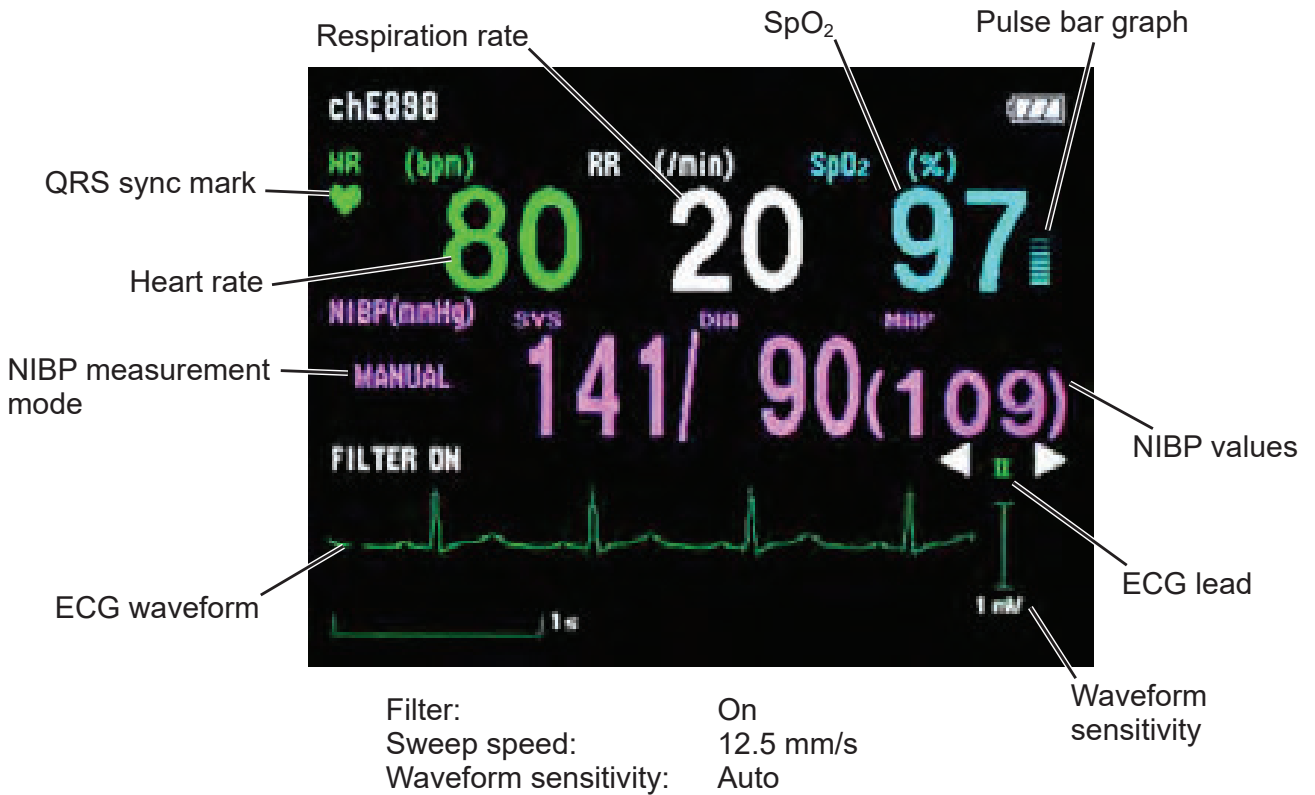

## When ECG and respiration measurement is turned off

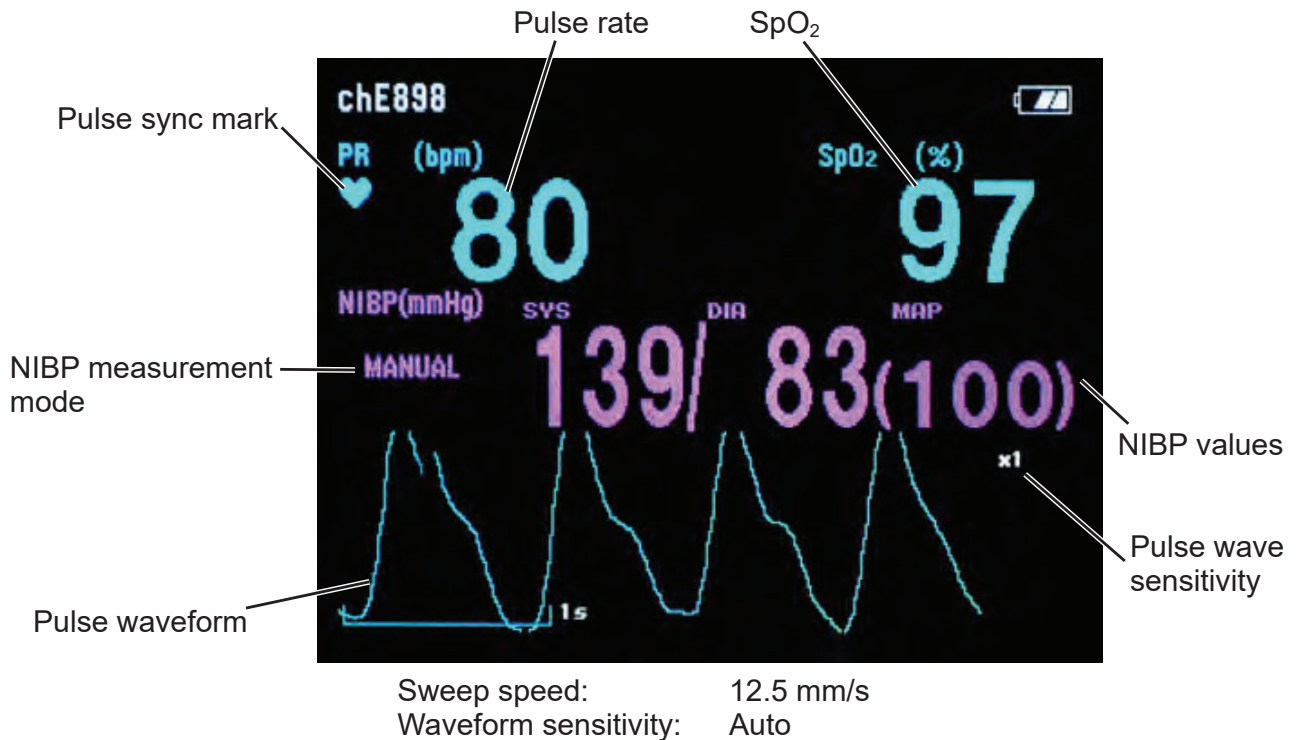

**NOTE:** The pulse wave amplitude varies according to the ratio of the pulsation component to the entire transmitted IR signal. When the pulsation component ratio is 1%, the pulse wave amplitude is about 5 mm at ×1 sensitivity on the screen.



## Waveform Review Screen

ECG full disclosure for up to 10 minutes can be saved and reviewed. When ECG measurement is turned off and SpO<sub>2</sub> is monitored, the pulse waveform is saved.

When ECG lead is changed on the numeric and waveform screen, the ECG full disclosure of the changed lead is saved.

The saved data is deleted when the transmitter is turned off.

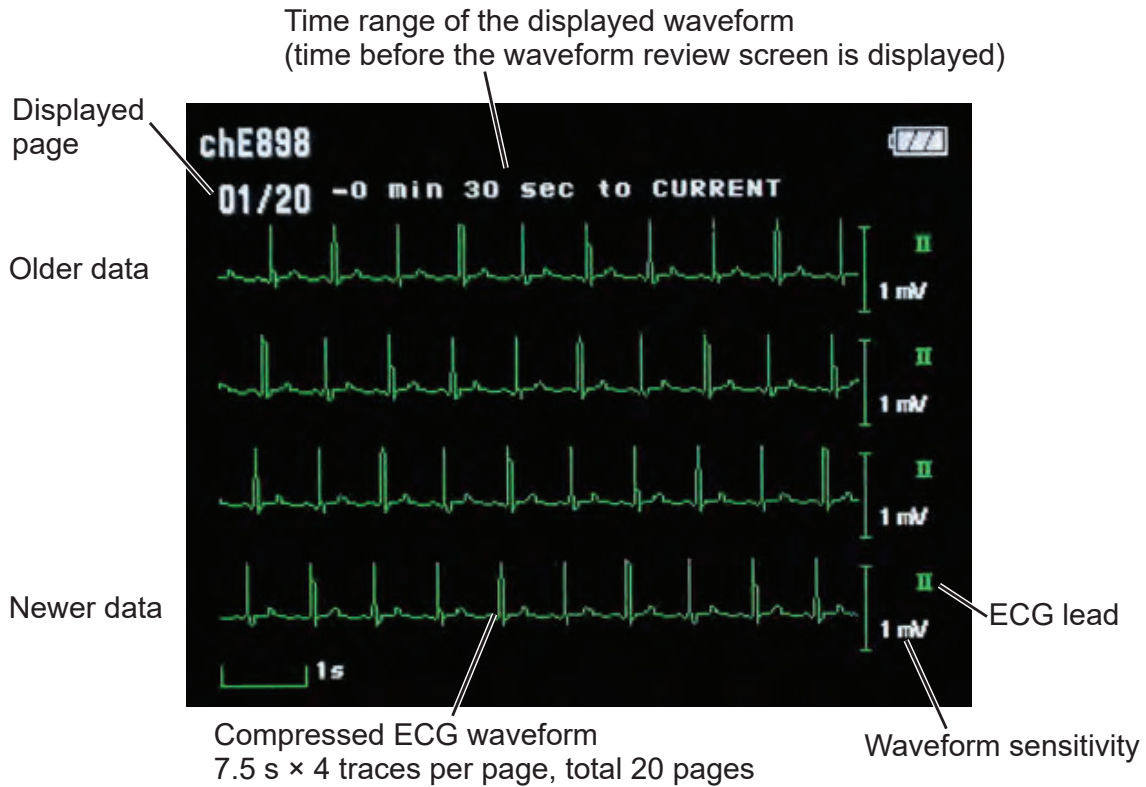

To scroll the waveform, press the ◀ or ▶ key. The waveform is scrolled by 30 seconds.

## Numeric Review Screen

Numeric data of heart rate (or pulse rate when ECG is turned off), SpO<sub>2</sub> and respiration rate for up to 10 minutes are saved at 1 minute intervals.

NOTE: NIBP measured values are not saved.

The saved data is deleted when the transmitter is turned off.

Older data

	HR (bpm)	SpO <sub>2</sub> (%)	RR (/min)
-10[min]	80	97	20
- 9[min]	80	97	20
- 8[min]	80	97	20
- 7[min]	80	97	20
- 6[min]	80	97	20
- 5[min]	80	97	20
- 4[min]	80	97	20
- 3[min]	80	97	20
- 2[min]	80	97	20
- 1[min]	80	97	20

Newer data

Time before the numeric review screen is displayed.

## Display Off

The display can be turned off any time. Refer to the “Turning the Display Off” section for details.

Select Screen Time Out Period.

10-second time bar

1 min    30 min    CONTINUE

RETURN    LEFT    RIGHT

## Basic Monitoring Operation

### Using the Function Key

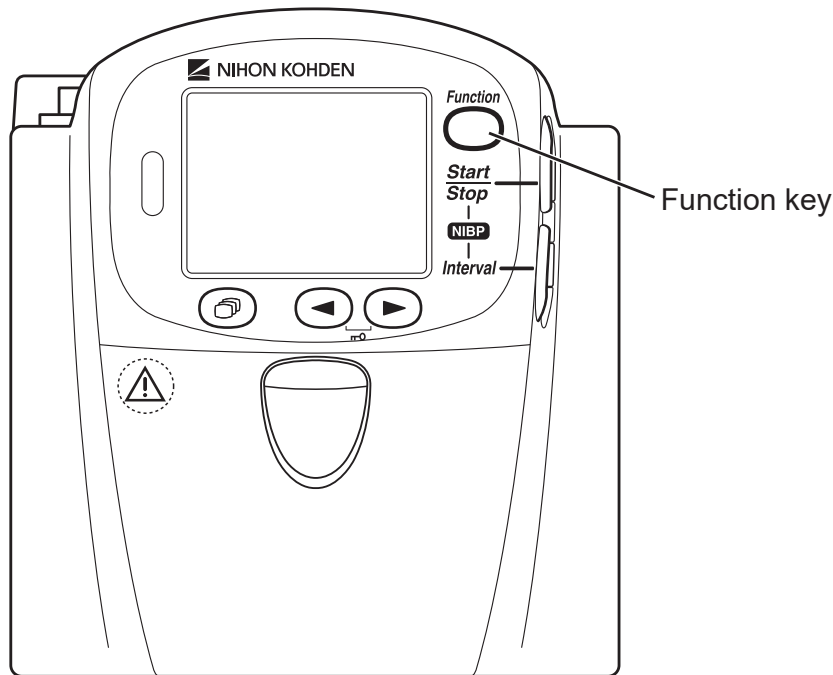

One of the following functions can be assigned to the Function key on the SYSTEM SETUP screen. Refer to the “Changing SYSTEM SETUP Settings” section.

**SUSPEND ALARM:** Suspends alarms on the receiving monitor, before they occur, for 2 minutes.

**PAUSE:** Pauses monitoring on the transmitter and receiving monitor.

**CONFIRM:** Transmits the signal that the patient is confirmed and displays the “PATIENT CONFIRMED” message on the transmitter.

**NOTE:** To use the Function key for pause or confirm, “PROTOCOL” on the SYSTEM SETUP screen of the transmitter must be set to 57 and the receiving monitor must be able to receive protocol 57. A central monitor with an ORG-9100A, ORG-9110A or ORG-9700A multiple patient receiver whose software version 02-01 or later can receive this protocol.

## Suspending Alarms on the Receiving Monitor

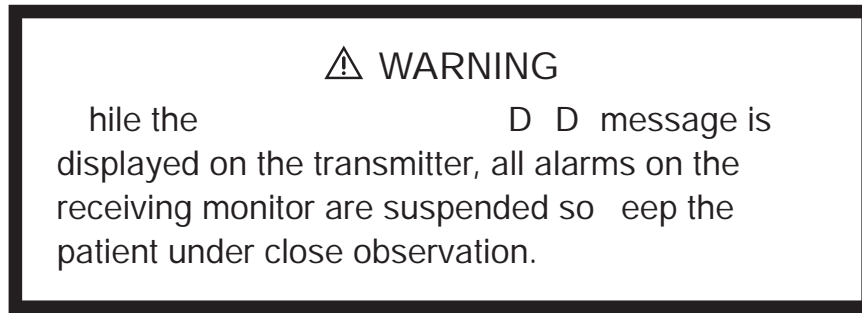

When the FUNCTION KEY is set to “SUSPEND ALARM” or “SUSPEND ALARM & PAUSE” on the SYSTEM SETUP screen, alarms can be suspended for 2 minutes on the receiving monitor before they occur.

To suspend alarms:

- 1 Press the Function key. The “Suspend alarms” confirmation screen appears.

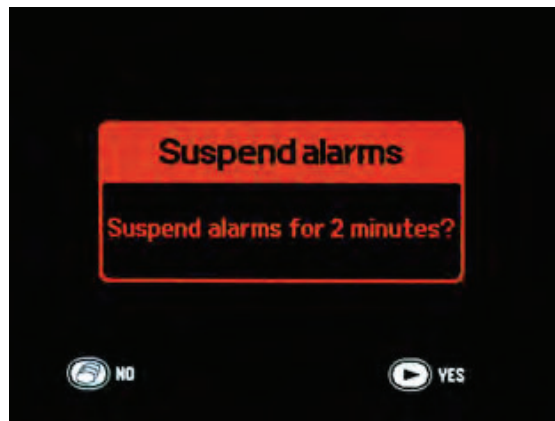

- 2 Press the ► key to suspend alarms.

To cancel suspending alarms and return to the previous screen, press the Screen key.

When the alarms are suspended, the “ALARMS SUSPENDED” message and alarm suspended icon with the remaining minutes in alarm suspension appear on the transmitter screen.

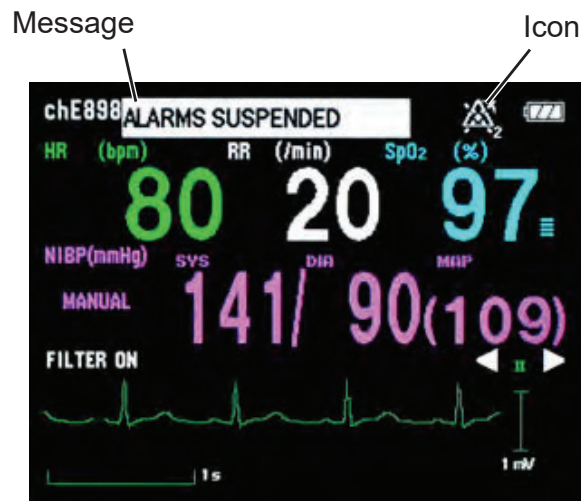

To cancel suspending alarms during 2 minute alarm suspension:

- 1 Press the Function key while the “ALARMS SUSPENDED” message is displayed. The confirmation screen appears.

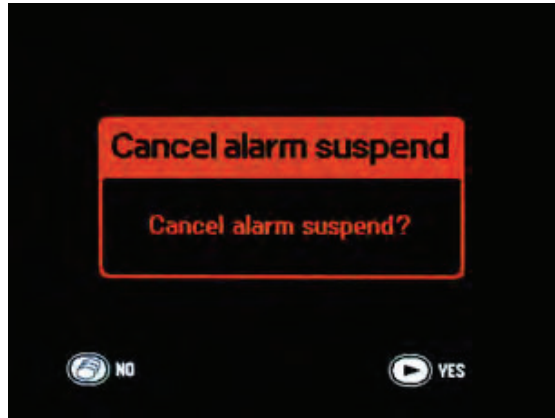

- 2 Press the ► key to cancel alarm suspension.  
Press the Screen key to not cancel alarm suspension.

## Pausing Monitoring

When FUNCTION KEY is set to “SUSPEND ALARM & PAUSE” on the SYSTEM SETUP screen, you can pause monitoring on the receiving monitor from the transmitter when the patient cannot be monitored, such as during X-ray examination.

**NOTE:** To use the Function key for pause, “PROTOCOL” on the SYSTEM screen of the transmitter must be set to 57 and the receiving monitor must be able to receive protocol 57.

Monitoring on the receiving monitor resumes when one of the following conditions is met. When OFF is selected for “AUTO RESUME AFTER PAUSE” on the SYSTEM SETUP screen, monitoring does not automatically resume.

- Heart rate is properly monitored on the transmitter for the interval selected for “AUTO RESUME AFTER PAUSE”
- SpO<sub>2</sub> is properly monitored on the transmitter for the interval selected for “AUTO RESUME AFTER PAUSE”
- NIBP is properly measured and the SYS, DIA or MAP value is displayed on the transmitter

To pause monitoring:

- 1 Press the Function key. The “Suspend alarms” confirmation screen appears.

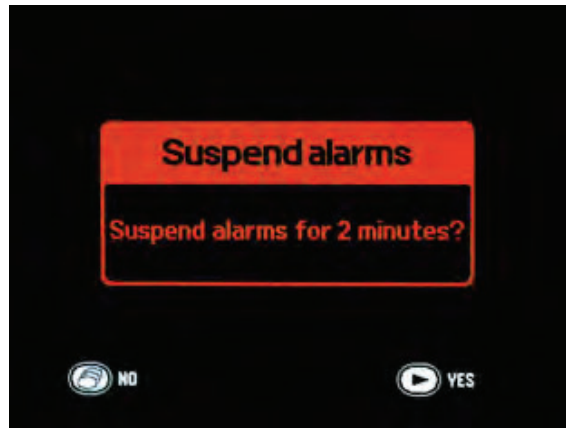

- 2 Press the Function key for 3 seconds to display the “Pause monitoring” confirmation screen.



- 3 Press the ► key to pause monitoring.  
To cancel pause monitoring, press the Screen key.
- 4 Wait about 5 seconds until the “Turn power off” screen appears.



**5** Turn off the transmitter.

If the transmitter is not turned off and monitoring continues for the interval set for “AUTO RESUME AFTER PAUSE” on the SYSTEM SETUP screen, pause monitoring is cancelled and monitoring continues.

**Resuming Monitoring after Pause**

To resume monitoring after pause, check that the electrodes, electrode leads and probe are attached to the patient then turn on the transmitter.

**⚠ WARNING**  
When the patient returns to the bed, turn on the transmitter and check that the monitoring is resumed on the receiving monitor.

**⚠ WARNING**  
If the transmitter is not turned off and monitoring continues for the selected interval, pause monitoring is canceled and monitoring continues. Check that the monitoring is resumed on the receiving monitor.

**Confirming the Patient**

When the FUNCTION KEY is set to “CONFIRM” on the SYSTEM SETUP screen, you can transmit signal to the receiving monitor to indicate that the patient is confirmed by a medical staff by pressing the Function key.

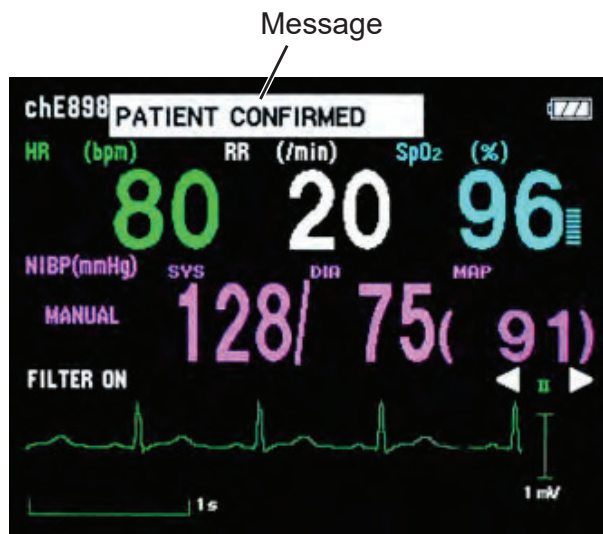

## Turning the Display Off

The display can be turned off any time. To turn off the display:

- 1 Press the Screen key several times until the following screen appears.

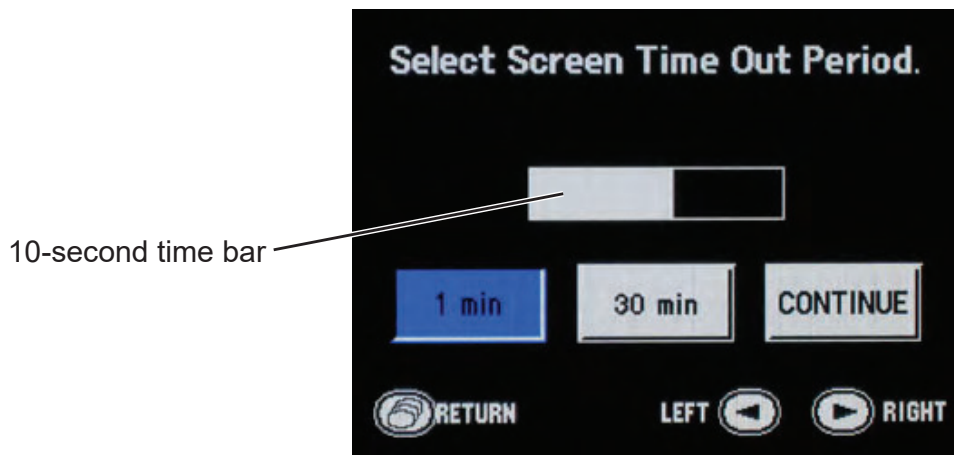

- 2 Select the timing for turning off the display with the ◀ or ▶ key. The selected item is highlighted in blue. A 10 second countdown starts. You can select a different time within the 10 second countdown.

1 min (factory default): Turns the display off 1 minute later.

5, 10, 15, 30, 60, 120 or 240 min: Turns the display off when the selected time elapses. To set the time, refer to “SELECTABLE SCREEN TIME OUT PERIOD (min)” in the “Changing System Setup Settings” section.

CONTINUE: Keep the display turned on.

NOTE: If longer than “1 min” is selected, it reduces the battery lifetime.

- 3 Wait 10 seconds until the countdown ends. When the countdown ends, the numeric and waveform screen appears.

Or, press the Screen key before the countdown ends. The check electrodes screen appears.

When the selected time elapses without any key operation, the display turns off automatically. If a key is pressed, the countdown resets.

- When displaying the check electrodes screen after selecting the time-out period, the screen automatically changes to the numeric and waveform screen 2 minutes later if there is no key operation, then the display turns off when the remaining time elapses.
- When displaying another screen after selecting the time-out period, the screen changes to the numeric and waveform screen 1 minute later if there is no key operation, then the display turns off when the remaining time elapses.
- When “1 min” is selected, the display turns off without changing to the numeric and waveform screen.

When the display is turned off automatically or the power is turned off, the setting returns to “1 min” (factory default).



## Turning the Display On after It was Turned Off

Press the Screen key. One of the following screens appears.

- The previous screen: The Screen key is pressed within 5 minutes after the display turned off.
- Numeric and waveform screen: The Screen key is pressed more than 5 minutes after the display turned off.
- “Key locked” screen: The Screen key is pressed after the display turned off and the “Key locked” screen was the last screen before the display turned off.

## ECG and Respiration Monitoring

When the electrodes are attached and the ECG leads are connected, the heart rate, ECG waveform, respiration rate and respiration waveform appear on the receiving monitor. Refer to the operator's manual of the receiving monitor for details.

When 6 leads are used on this transmitter, up to 8 leads (I, II, III, aVR, aVL, aVF, Va and Vb) of ECG waveforms can be displayed on the receiving monitor. The heart rate is also measured.

When 3 leads are used, one channel ECG waveform of lead II can be displayed on the receiving monitor. Refer to the operator's manual of the monitor for details.

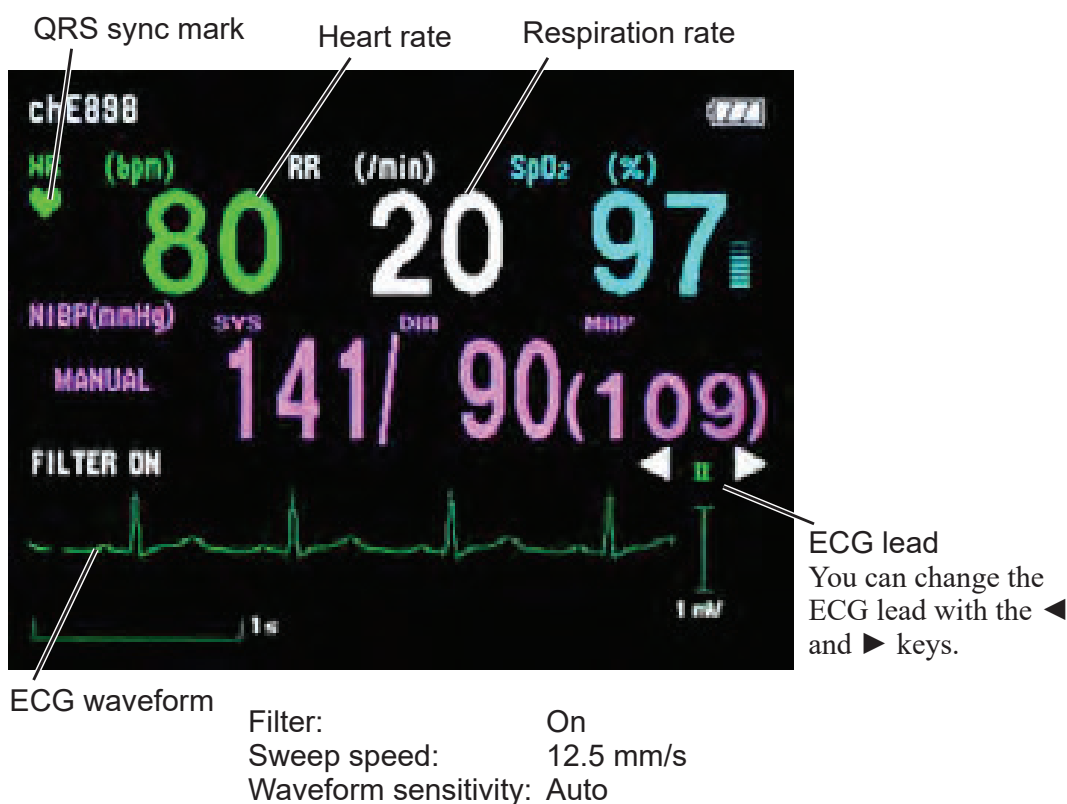

If the receiving monitor does not detect the pacemaker pulse, change the electrode positions. Attach the electrode lead clip to change the monitoring electrode.

**⚠ WARNING**

The bioelectric impedance measurement sensor of a minute ventilation rate adaptive implantable pacemaker may be affected by transmitter which is connected to the same patient. If this occurs, the pacemaker may pace at its maximum rate and the transmitter may give incorrect data to the monitor. If this occurs, disconnect the electrode leads from the patient or change the setting on the pacemaker by referring to the pacemaker's manual. For more details, contact your pacemaker representative or physician representative.

**⚠ WARNING**

Turn the pacing pulse detection to O on the receiving monitor when monitoring a pacemaker patient. Otherwise the pacemaker pulse is not rejected. However, even when the pacing pulse detection is set to O, the pacemaker pulse might not be rejected. When the pacemaker pulse is not rejected, the pacemaker pulse is detected as and false heart rate may be indicated or critical arrhythmia such as asystole may be overlooked. Keep pacemaker patients under close observation.

For the pacemaker pulse rejection capability of the ZM-540PA and ZM-541PA transmitters, refer to the "Specifications - ECG" section.

**⚠ WARNING**

Even when the pacing pulse detection is set to O on the receiving monitor, the pacemaker pulse can be overlooked or detected as . You cannot confirm the pacemaker operation only from the detected pacemaker pulse.

 **WARNING**

When the transmitter is used with an electrosurgical unit, firmly attach the entire area of the return plate. Otherwise, the current from the flows into the electrodes of the transmitter, causing electrical burn where the electrodes are attached. For details, refer to the manual.

 **CAUTION**

Turn off the power of mobile phones, small wireless devices and other devices which produce strong electromagnetic interference around a patient except for devices allowed by the hospital administrator. Radio waves from devices such as mobile phones or small wireless devices may be mistaken as pulse waves or respiration waves and the displayed data may be incorrect.

 **CAUTION**

When the **OK** message is displayed on the receiving monitor, is not monitored and the alarm does not function. Remove the cause by checking the electrodes, electrode leads, patient's body movement, and peripheral instruments grounding. Also make sure that an electric blanket is not used.

- NOTE**
- Noise generated from an electrosurgical unit may interfere on an ECG waveform, but will not damage it.
  - If an electric blanket is used and incorrect heart rate is displayed on the monitor, turn off the pacing spike detection on the monitor.
  - Turn the pacing spike detection to ON on the receiving monitor when monitoring a pacemaker patient. Pacing pulse is detected by the transmitter and transmitted to the monitor. If the pacing spike detection is turned OFF, QRS and pacemaker spike might not be distinguished and pacemaker failure might not be recognized.
  - If defibrillation may be necessary, set the filter to Monitor or Maximum on the receiving monitor. If defibrillation is performed while the setting is OFF, the waveform recovery may be slow.
  - ECG cannot be monitored on a neonate using this transmitter.

## Turning ECG Measurement On/Off

ECG measurement can be turned on or off on the PARAMETER SETUP screen. When electrodes are attached to the patient and ECG leads are connected, ECG monitoring starts even when ECG is turned off.

### When “PROTOCOL” on the SYSTEM screen is set to 57:

ECG measurement on the receiving monitor is automatically set to OFF. Also, ECG measurement on the transmitter cannot be turned on or off from the receiving monitor.

### When “PROTOCOL” on the SYSTEM screen is set to 42:

If ECG measurement is turned off on the transmitter, ECG measurement on the receiving monitor must also be turned off.

## Turning Respiration Measurement On/Off

Respiration measurement can be turned on or off on the PARAMETER SETUP screen. If respiration measurement is turned off, respiration measurement on the receiving monitor is also turned off.

## Electrode Detachment

In the following conditions, the “CHECK ELECTRODES” message is displayed on the transmitter and receiving monitor.

- Electrode is detached from skin.
- Electrode lead is disconnected from the electrode.
- Polarization voltage between the electrode and skin is excessively high.

In these cases, check the cause and if necessary, replace electrodes with new ones.

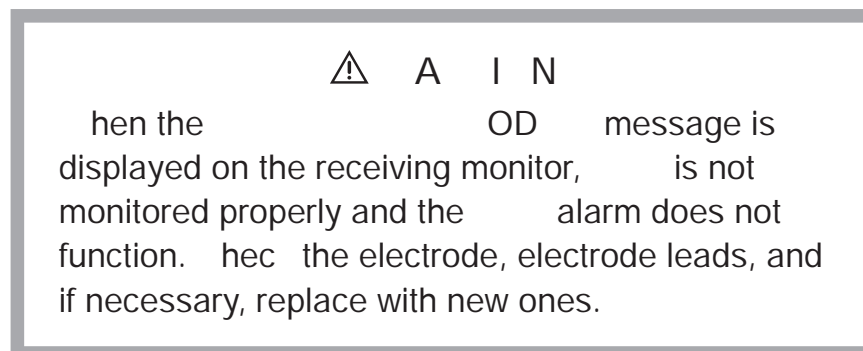

## SpO<sub>2</sub> Monitoring

When monitoring starts, SpO<sub>2</sub> and the pulse waveform are sent to the monitor and SpO<sub>2</sub> and the pulse level bar graph are displayed on the transmitter screen. When ECG is not measured, the pulse waveform and pulse rate are also displayed.

Check that pulse wave is displayed and that the “CHECK PROBE” message is not displayed. If the probe is detached, SpO<sub>2</sub>, pulse rate and pulse wave are not displayed on the display.

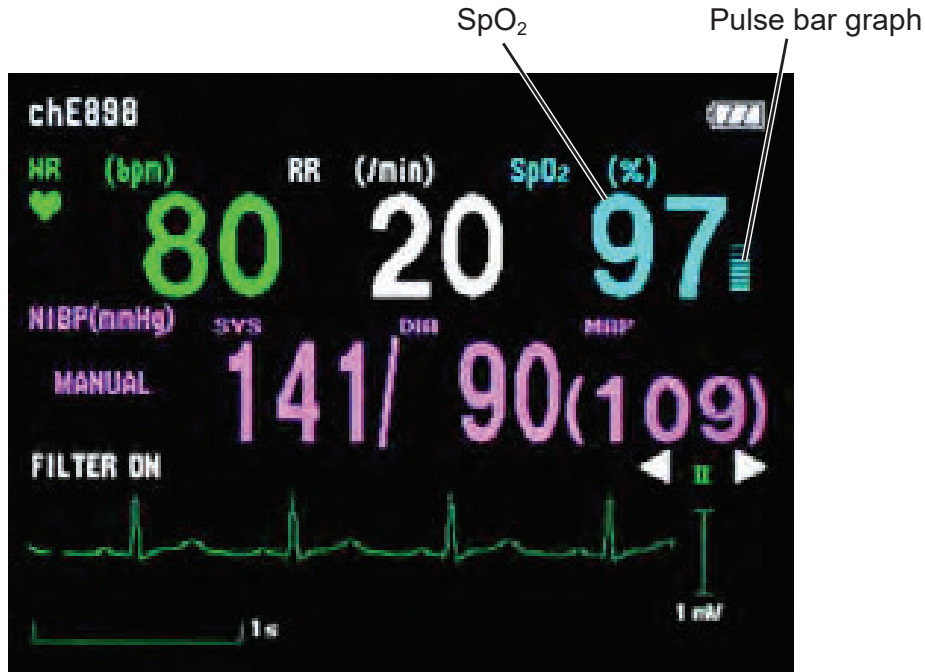

**NOTE:** During SpO<sub>2</sub> monitoring, the transmitter constantly checks the light intensity of the probe and adjusts the light intensity to maintain optimum measurement condition. During adjustment, the pulse wave becomes flat for about 0.5 seconds.



## Measuring Principle

SpO<sub>2</sub> is measured by attaching a probe to a place where light can easily penetrate, such as a finger. The probe has two light emitter diodes and one photo detector.

Light of two wavelengths, 660 nm and 940 nm, are emitted from the emitter diodes.

Oxygenated and deoxygenated blood absorb different wavelengths of light as shown in fig. 1 and 2. The light absorption of the skin, tissue, bone and venous blood is constant and can be eliminated. The pulsatile change represents arterial blood only, as shown in fig. 3, and this is measured to determine SpO<sub>2</sub>. The amount of unabsorbed light at each wavelength is detected by the photo detector. SpO<sub>2</sub> is calculated from the ratio of absorbed light of the two wavelengths (fig. 2).

SpO<sub>2</sub> can be measured correctly when there is an arterial pulse which causes change in the transmitted light of both wavelengths. When the patient has asystole and no arterial pulse, there is a chance that some external factor such as movement of the SpO<sub>2</sub> probe may cause change in the transmitted light and produce a pulse-like signal which causes an incorrect SpO<sub>2</sub> value to be displayed. This incorrect SpO<sub>2</sub> value depends on the optical properties of the change in transmitted light.

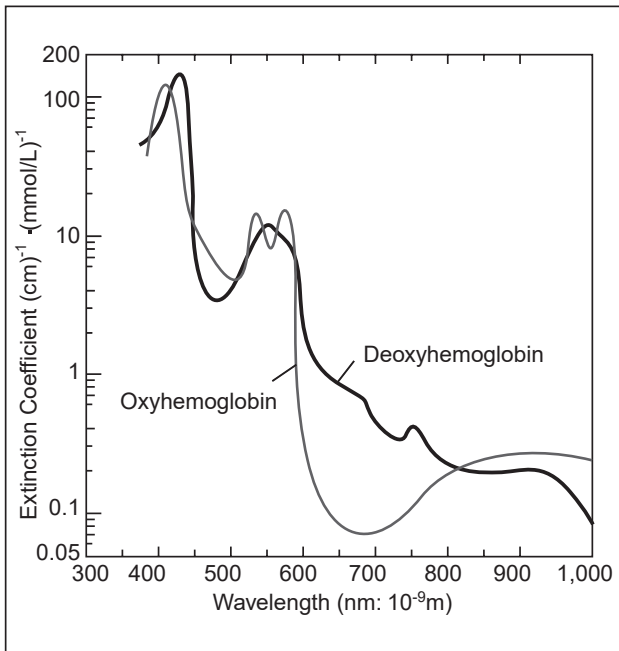

Fig. 1

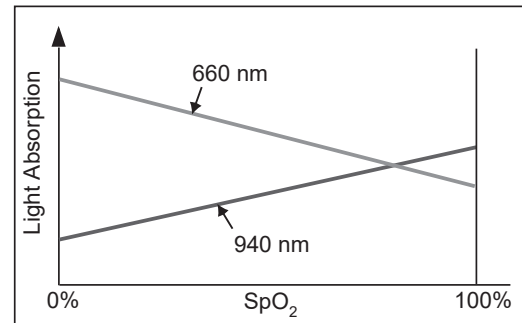

Fig. 2

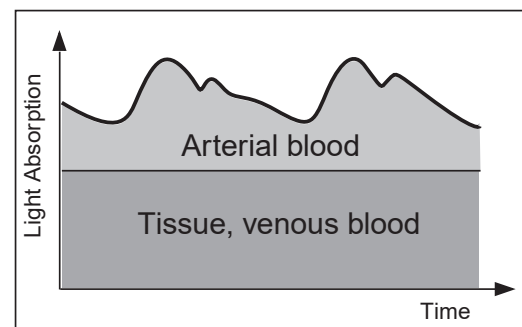

Fig. 3

**⚠ WARNING**

pO<sub>2</sub> measurement may be incorrect in the following cases.

When the patient's carboxyhemoglobin or methemoglobin increases abnormally.

When dye is injected in the blood.

During

When measuring at a site with venous pulse.

When there is body movement.

When the pulse wave is small insufficient peripheral circulation.

**⚠ WARNING**

Check the circulation condition by observing the skin in color at the measurement site and pulse waveform. Change the measurement site every 2 hours for disposable probes and every 4 hours for reusable probes every 4 hours for reusable series probe. The skin temperature may increase at the attached site by 1°C or more and cause a burn or pressure necrosis. When using the probe on the following patients, take extreme care and change the measurement site more frequently according to symptoms and degree.

Patient with a fever

Patient with insufficient peripheral circulation

Preterm neonate or low birth weight infant with delicate skin

**⚠ WARNING**

When monitoring pO<sub>2</sub> of a patient who is receiving photodynamic therapy, the light from the finger probe sensor may cause a burn.

Photodynamic therapy uses a photosensitizing agent that has a side effect of photosensitivity.

The SpO<sub>2</sub> probes manufactured by Nihon Kohden have two wavelengths with peaks in the range of 650 and 950 nm. The maximum light intensity is less than 5.5 mW.

**⚠ WARNING**

When not monitoring pO<sub>2</sub>, disconnect the pO<sub>2</sub> cable from the transmitter. Otherwise, noise from the probe sensor may interfere and incorrect data is displayed on the screen.

**⚠ A I N**

Turn off the power of mobile phones, small wireless devices and other devices which produce strong electromagnetic interference around a patient except for devices allowed by the hospital administrator. Radio waves from devices such as mobile phones or small wireless devices may be mistaken as pulse waves or respiration waves and the displayed data may be incorrect.

**⚠ CAUTION**

Handle the probe cable according to the following cautions. Failure to follow these cautions may cause cable discontinuity or short circuit of the probe cable which may cause incorrect measurement data or inability to perform measurement. Also in rare cases, the probe temperature may increase and cause skin burn on the patient. If the probe cable is damaged, replace the probe with a new one.

- Do not pull or bend the probe cable.
- Do not let caster feet run over the probe cable.

**⚠ A I N**

Normal external light does not affect monitoring but strong light such as a surgical light or sunlight may affect monitoring. If affected, cover the measuring site with a blanket.



 A I N

When the probe is attached on an appropriate site with sufficient thickness and the error message confirming the probe attachment repeatedly appears, the probe may be deteriorated. Replace it with a new one.

 A I N

When a message indicates a faulty probe, stop monitoring and replace the probe with a new one.

 A I N

While a patient is on medication which causes vasodilation, the pulse waveform may change and in rare cases the  $pO_2$  value might not be displayed.

 A I N

When monitoring  $pO_2$  only, detection of arrhythmia and asystole is not available and arrhythmia alarms such as  $PO_2$ , or are not available. If the patient requires monitoring, monitor the .

 A I N

When monitoring  $pO_2$  only without monitoring, turn on both the upper and lower limit alarms for and  $pO_2$  on the receiving monitor. If the patient's pulse is not detected during asystole or other condition, a  $PO_2$  or  $PO_2$  alarm occurs instead of an  $pO_2$  limit alarm. Furthermore, if the patient has no pulse, noise from probe movement could be misjudged as a pulse and cause an incorrect or  $pO_2$  value to be displayed.

- NOTE**
- In order to maintain sufficient blood circulation, keep the measurement site warm by covering it with a blanket or something similar. Warming the site is effective, especially for a patient with a small pulse amplitude.
  - When monitoring a patient who has an IABP and SpO<sub>2</sub> cannot be measured, monitor the patient on a wired monitor. If the monitor has a sensitivity mode, set the mode to “MAX”.
  - Unlike ECG monitoring, detection of arrhythmia and asystole is not available when monitoring SpO<sub>2</sub> only. If SpO<sub>2</sub> is monitored without ECG, PR and SpO<sub>2</sub> alarms do not occur during asystole because PR and SpO<sub>2</sub> values are not measured when there is no pulse. Furthermore, if the patient has no pulse, noise from probe movement could be misjudged as a pulse and cause an incorrect PR or SpO<sub>2</sub> value to be displayed.

## Monitoring SpO<sub>2</sub> during NIBP Measurement

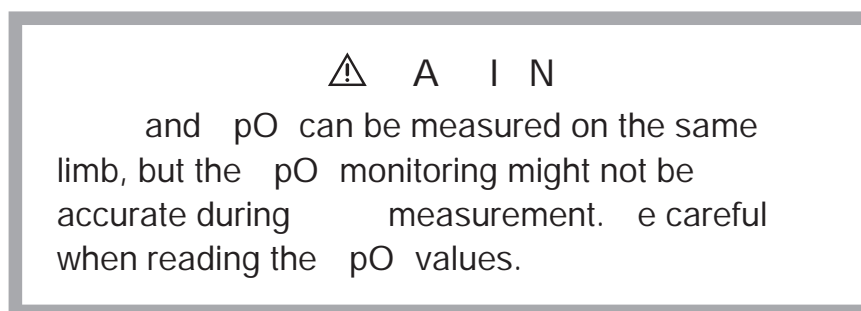

- \* When the SpO<sub>2</sub> probe is attached to the same limb as the NIBP cuff, the blood flow decreases during NIBP measurement and pulse wave cannot be detected and SpO<sub>2</sub> cannot be monitored properly. When “INHIBIT SpO<sub>2</sub> DURING NIBP” on the PARAMETER SETUP screen is set to ON (factory default setting), SpO<sub>2</sub> monitoring is paused during NIBP measurement to avoid SpO<sub>2</sub> alarm occurrence. However, when monitoring SpO<sub>2</sub> on the same limb as NIBP, be careful when reading SpO<sub>2</sub> values.

When monitoring SpO<sub>2</sub> is important, attach the probe to the limb to which the NIBP cuff or catheter is not attached.

When SpO<sub>2</sub> monitoring is paused during NIBP measurement, the SpO<sub>2</sub> value just before the start of NIBP measurement and an  mark are displayed on the transmitter for 30 seconds.

When NIBP measurement is not completed after 30 seconds, “— —” is displayed for the SpO<sub>2</sub> value. The same data also appears on the monitor screen.

- NOTE**
- When continuous SpO<sub>2</sub> monitoring is necessary, attach the probe to the limb to which the NIBP cuff is not attached and set “INHIBIT SpO<sub>2</sub> DURING NIBP” on the PARAMETER SETUP screen to OFF.
  - When the probe is attached to the same limb as the NIBP cuff, set the sync source to a parameter other than SpO<sub>2</sub> on the receiving monitor.
  - When monitoring SpO<sub>2</sub> during STAT NIBP measurement, attach the probe to the limb to which the NIBP cuff is not attached.

## NIBP Monitoring

### Selecting the Initial Cuff Inflation Pressure

The initial cuff inflation pressure can be changed on the PARAMETER SETUP screen. The default setting is 180 mmHg. To change the setting, refer to the “Changing PARAMETER SETUP Settings” section.

### Selecting the Measurement Mode and Interval

#### Measurement Modes

There are three measurement modes: manual, auto and STAT. The selected mode or interval is displayed on the screen.

The measurement mode and interval can be changed by pressing the NIBP Interval key.

When the key is pressed, the NIBP mode setting screen appears. The measurement modes selected at “SELECTABLE INTERVALS” on the PARAMETER SETUP screen are displayed (key color: white). Select the measurement mode with the ◀ and ▶ keys or NIBP Interval key and press the Function key.

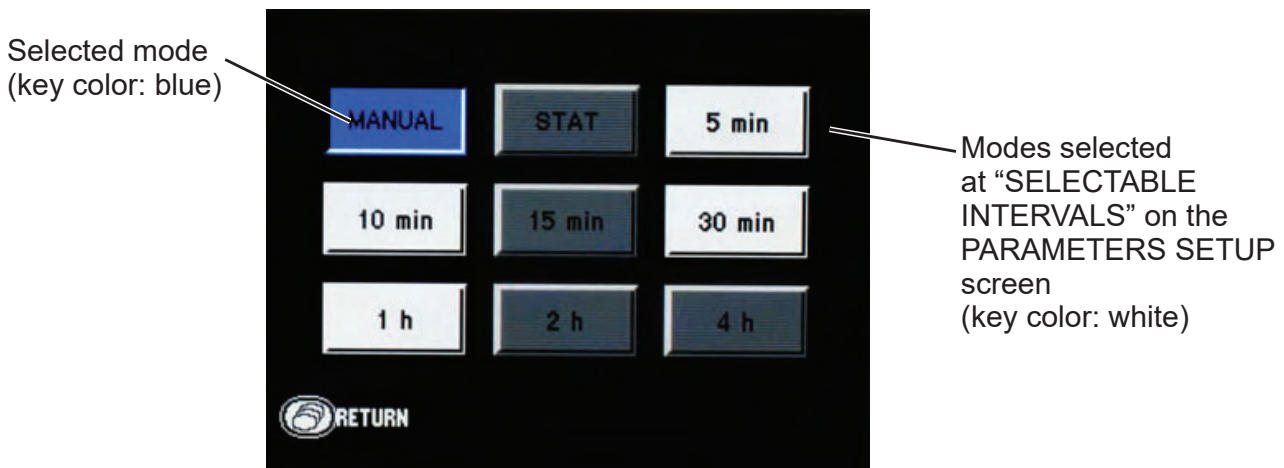

To select the modes to be displayed on the NIBP mode setting screen, refer to the “Changing PARAMETER SETUP Settings” section.

**Manual Measurement**

In Manual mode, a single NIBP measurement is performed when the NIBP Start/Stop key is pressed.

**STAT (Continuous) Measurement**

In STAT mode, measurement is continuously repeated for 15 minutes after the NIBP Start/Stop key is pressed.

When the STAT measurement for 15 minutes is completed, the measurement mode automatically changes to the Manual mode or Auto mode of selected interval depending on the "NIBP MODE AFTER STAT" setting on the PARAMETER SETUP screen. The default setting is Manual mode. Refer to the "Changing Parameter Setup Settings" section.

The STAT measurement completes within 15 minutes. When more than 12 minutes elapse from the start of measurement, there will be no more measurement performed and the measurement mode changes to the mode selected for "NIBP MODE AFTER STAT" on the PARAMETER SETUP screen.

**Auto Measurement**

In Auto mode, measurement is performed automatically at the preset time intervals.

In Auto mode, a single measurement can be performed by pressing the NIBP Start/Stop key between auto measurements.

## Measuring NIBP

### WARNING

Be careful when measuring on a patient with known bleeding disorders or coagulation. After measurement, there may be dot hemorrhage, or circulatory disorder by thrombus where the cuff is attached.

### WARNING

Measurement may be incorrect in the following situations.

- When using an
- Body movement
- Small pulse wave
- Too many arrhythmias
- Coming from an external source
- Rapid blood pressure change

During

- Low pulse
- Low blood pressure
- Small pulse pressure
- Cuff is too tight or too loose
- Cuff does not fit the arm
- Cuff is wrapped over thick clothing
- Cuff is deteriorated
- Arterial sclerosis
- Poor perfusion

Diabetes

- Pregnancy
- Eclampsia
- Renal disease
- Shivering
- Trembling

**⚠ WARNING**

When performing measurements in mode or minute intervals, periodically remove the cuff from the patient for ventilation. The skin temperature may increase at the cuff attachment site by or or . When measuring a patient with a fever or peripheral circulation insufficiency, it may cause a burn.

**⚠ WARNING**

When performing long term measurement at intervals less than minutes, perform measurements while observing the state of the patient, blood vessels and limb to ensure adequate circulation. Congestion may occur at the measurement site. When performing periodic measurement for a long time, periodically check the circulation condition.

**⚠ A I N**

When performing measurement repeatedly, have a rest between measurements to recover adequate circulation.

- NOTE**
- When measuring patients who are conscious, help the patient to relax. Measurement may not be accurate if the patient's arm is tense or if the patient talks.
  - The data for measurement on a leg tends to be higher than measurement on the arm. When making diagnosis based on the NIBP values, measure NIBP on an upper arm.
  - Do not apply pressure to the cuff or air hose. NIBP may not be measured correctly because of noise or NIBP measurement may stop due to the NIBP safety circuit.
  - If there is an abnormal noise generated during measurement, stop using the transmitter and contact your Nihon Kohden representative.
  - Do not measure NIBP of a patient on whom an IABP is being used. Measurement may be incorrect due to the mixing of the patient's own pulse and IABP pulse.
  - NIBP cannot be measured on a neonate using this transmitter.

### For Accurate NIBP Measurement

- Make sure the patient is comfortably seated. Do not perform measurement immediately after the patient is seated. Keep the patient in the resting state for five minutes before measurement.
- Make sure the patient has legs uncrossed, feet down on the floor, and back and back arm supported during measurement.

**1** Press the NIBP Interval key to display the NIBP mode setting screen.

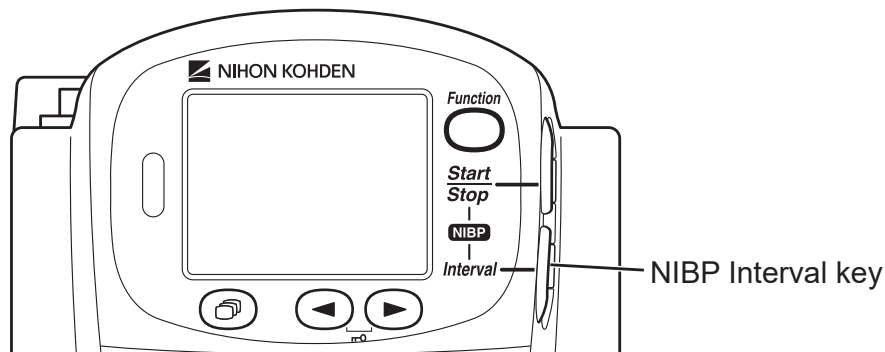

**2** Select the measurement mode by pressing the NIBP Interval key or and keys.

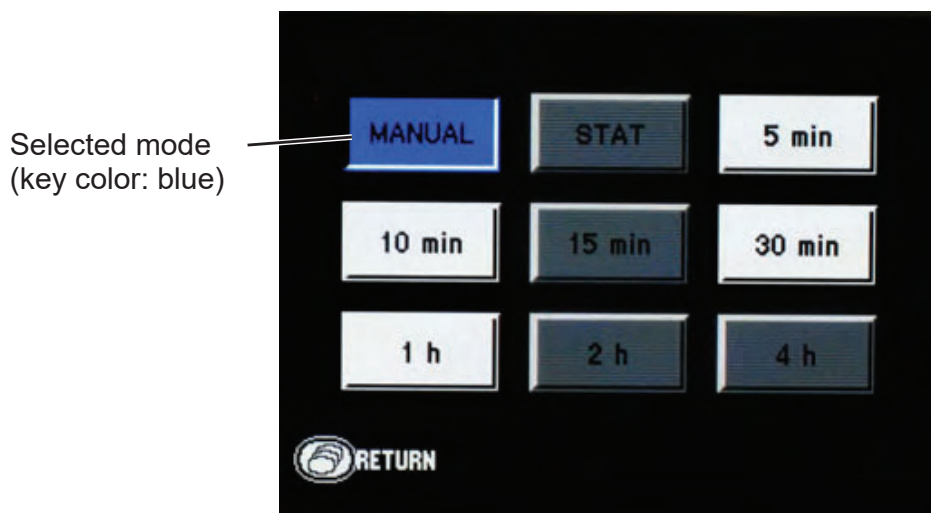

**3** Press the Function key.

**4** Press the NIBP Start/Stop key to perform measurement.

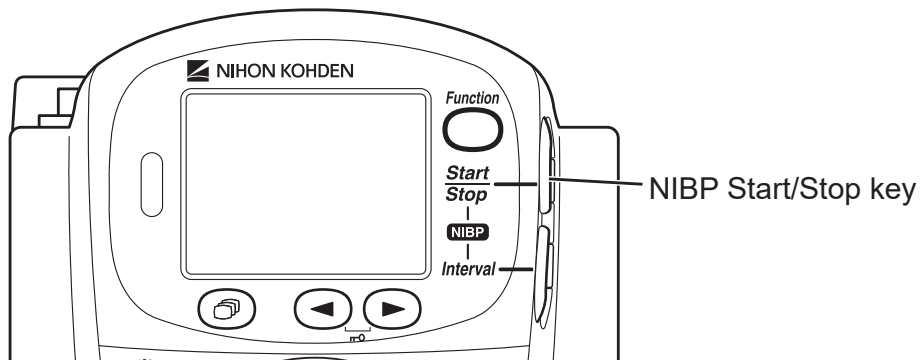

The cuff is inflated and the inflation pressure is displayed on the screen.



- In manual mode: Measurement is performed once.
- In STAT mode: Measurement is performed repeatedly for 15 minutes.
- In auto mode: The first measurement is performed when the NIBP Start/Stop key is pressed. The second measurement is performed when the current time in the transmitter reaches the selected time interval.

To stop measurement during measurement, press the NIBP Start/Stop key again.

In STAT mode, after completing the STAT measurement, the measurement mode changes to the mode set for “NIBP MODE AFTER STAT” on the PARAMETER SETUP screen.

In auto mode, to stop measurement in auto mode, change the mode to manual. To cancel one measurement, press the NIBP Start/Stop key during measurement.

After the measurement is complete, the measured data is displayed on the screen and is transmitted to the monitor.

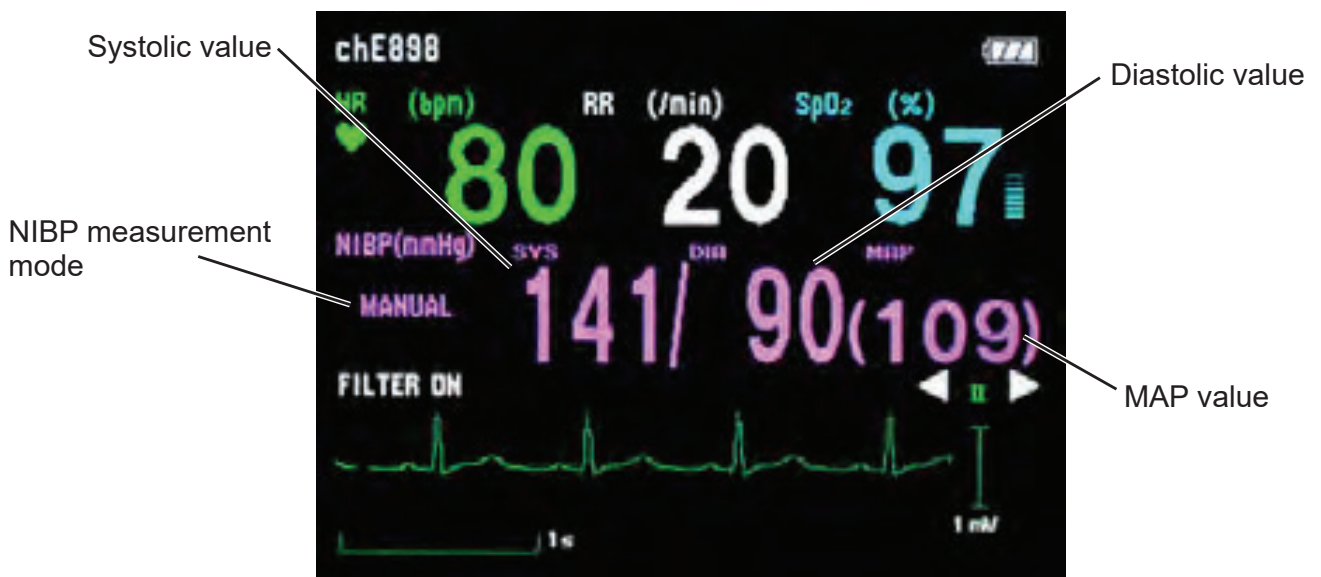

When ECG and SpO<sub>2</sub> are not monitored (ECG measurement is turned off and SpO<sub>2</sub> probe is not connected to the transmitter), the pulse rate at the end of NIBP measurement is displayed.



A buzzer can be set to sound at the start and end of NIBP measurement. Refer to the “Changing PARAMETER SETUP Settings” section.

### Auto Mode Measurement

When auto mode measurement is selected, “STANDBY” message is displayed on the screen until the NIBP Start key is pressed for the first time.



A time bar appears to indicate the interval between auto mode measurements.

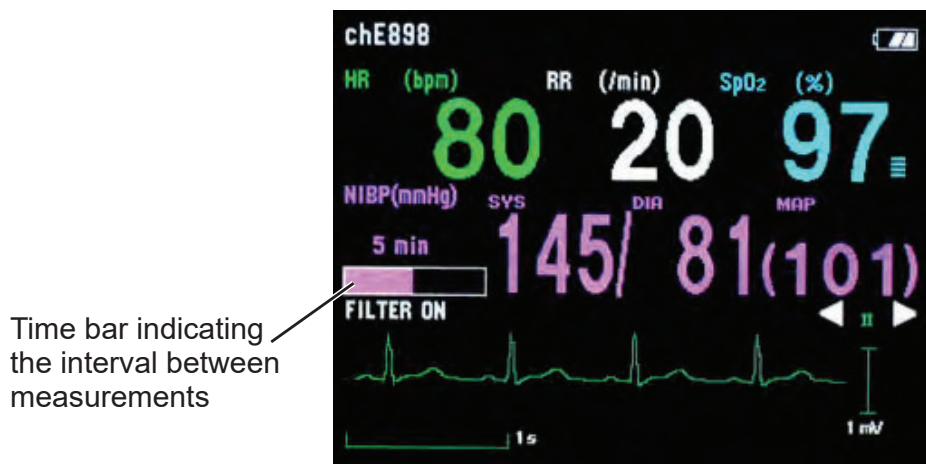

During auto mode measurement, the measurement mode can be changed. During the interval, press the NIBP Interval key to change the mode. When “MANUAL” is displayed for more than one second, the measurement in auto mode is stopped.

### Data Display After NIBP Measurement





When the time set at “OLD NIBP DATA” on the PARAMETER SETUP screen elapses after the last measurement, the NIBP data is dimmed or hidden. Whether to dim or hide the old data can also be selected at “OLD NIBP DATA”. Refer to the “Changing PARAMETER SETUP Settings” section.

## Monitoring SpO<sub>2</sub> during NIBP Measurement

When the SpO<sub>2</sub> probe is attached to the same limb as the NIBP cuff, the blood flow decreases during NIBP measurement and pulse wave cannot be detected and SpO<sub>2</sub> cannot be monitored properly. When “INHIBIT SpO<sub>2</sub> DURING NIBP” on the PARAMETER SETUP screen is set to ON (factory default setting), SpO<sub>2</sub> monitoring is paused during NIBP measurement to avoid SpO<sub>2</sub> alarm occurrence. However, when monitoring SpO<sub>2</sub> on the same limb as the NIBP, be careful when reading SpO<sub>2</sub> values.

# Indication and Message List

## Indication

Indication	Cause	Countermeasure
	Fully charged batteries	—
	Batteries are 1/3 full.	
	Batteries are weak.	Replace the batteries.
	Batteries are very weak. Cannot measure NIBP.	
	Alarms on the receiving monitor were suspended by pressing the Function key on the transmitter.	Alarms resume when the suspend interval elapses. To cancel alarm suspension, press the Function key again.

## Messages

When “PROTOCOL” on the SYSTEM screen is set to 57, all messages are transmitted to the receiving monitor. When “PROTOCOL” is set to 42, the messages marked with \* are not transmitted to the receiving monitor.

Message	Cause	Countermeasure
AIR LEAK	The cuff and extension hose are not properly connected	Connect them properly.
	The cuff hose (or extension hose) is not properly connected to the NIBP socket	
	The cuff or extension hose is damaged	Replace with a new one.
ALARMS SUSPENDED	Alarms on the receiving monitor is suspended by pressing the Function key on the transmitter	Alarms resume when the 2 minute suspend interval elapses. To cancel alarm suspension, press the Function key again.
BATTERY WEAK	Dead batteries	Replace batteries.

Message	Cause	Countermeasure
CANNOT DETECT PULSE* (displayed in blue)	Poor blood circulation for measuring the SpO <sub>2</sub> value	Check the patient condition, probe attachment or change the attachment site.
	The probe is attached too tightly and is obstructing the blood circulation	Reattach the probe.
	The probe is not attached to the patient properly	Attach the probe to the patient properly.
	“LIGHT INTERFERENCE”, “CHECK PROBE SITE” or “DETECTING PULSE” message is displayed for more than 30 seconds	Refer to the cause and countermeasure for each message in this Messages table and remove the cause.
CANNOT DETECT PULSE (displayed in pink)	The patient's pulse wave is too small to measure NIBP	Measure by palpation or auscultation.
	The cuff is not wrapped on the patient properly	Wrap the cuff on the patient properly.
CHECK ELECTRODES	Electrode lead is disconnected from the electrode	Firmly connect the electrode lead to the electrode.
	Electrode lead is disconnected from the transmitter	Firmly connect the electrode lead to the transmitter.
	Electrode lead discontinuity	Replace the electrode lead with a new one.
	Electrode is not firmly attached to the skin	Replace the electrode with a new one.
	Polarization voltage is abnormally high	
CHECK PROBE	The probe is not attached to the patient properly	Attach the probe to the patient properly.
	The probe is not attached at the appropriate site	Attach the probe to an appropriate site indicated in the probe manual.
	The probe is disconnected from the transmitter	Connect the probe cable to the transmitter.
	The probe is past its expiration date	Replace the probe with a new one.
CHECK PROBE SITE*	The probe is not attached at the appropriate site	Attach the probe to an appropriate site indicated in the probe manual.
	The probe is deteriorated	Replace the probe with a new one.
	The probe is past its expiration date	
CUFF OCCLUSION	Transmitter malfunction	Immediately remove the cuff from the patient and contact your Nihon Kohden representative.

Message	Cause	Countermeasure
DETECTING PULSE	Searching for the correct pulse wave for SpO <sub>2</sub> monitoring	Wait until the pulse wave is detected.
	The SpO <sub>2</sub> value cannot be obtained because the waveform is unstable	Attach the probe to the patient properly.
	The probe is not attached to the patient properly	
HIGH CUFF PRESS	Enormous pressure was applied by the pressure of the cuff	Remove the cause.
INFLATION PRESS LOW	Insufficient cuff inflation pressure	Wait for the remeasurement to be performed with increased cuff inflation pressure.
LIGHT INTERFERENCE	The SpO <sub>2</sub> measurement site is under fluorescent light, surgical light, sunlight, or other strong light	Cover the measurement site with a blanket or cloth.
	Considerable body movement	When the message is displayed frequently, check the patient condition and, if necessary, change the attachment site.
	The probe is not attached to the patient properly	
	SpO <sub>2</sub> monitoring is paused for NIBP measurement	Wait for NIBP measurement to finish.
MEAS TIME OUT	The NIBP measuring time exceeded the specified time due to arrhythmia, body movement, vibration or, cuff or air hose being squeezed	Remove the cause if the cause is body movement, vibration or squeezing of cuff or hose.
NIBP MODULE ERROR	Module malfunction	Contact your Nihon Kohden representative.
NO NIBP CHANGE BATTERIES	NIBP cannot be measured due to low battery	Replace batteries with new ones.
PATIENT CONFIRMED*	Function key is pressed and the "PATIENT CONFIRMED" signal is transmitted to the receiving monitor (when "PATIENT" is assigned as the function for the Function key on the SYSTEM SETUP screen)	—
PROBE FAILURE*	The probe is past its expiration date	Replace the probe with a new one.
	Probe is damaged or short-circuited	
REMEASURING	NIBP is being remeasured due to arrhythmia, body movement, vibration or, cuff or air hose being squeezed	If the message still appears after remeasurement, remove the cause if the cause is body movement, vibration or squeezing of cuff or hose.
SAFETY CIRCUIT ERROR	The NIBP safety circuit error	Immediately remove the cuff from the patient and contact your Nihon Kohden representative.

Message	Cause	Countermeasure
SAFETY CIRCUIT RUNNING (When this message is displayed, measurement cannot be performed for 40 seconds.)	NIBP measurement stopped by the safety circuit	Check that the hose is not bent or squeezed.
		Wait 40 seconds, then perform remeasurement. If the message still appears, contact your Nihon Kohden representative.
SpO <sub>2</sub> MODULE ERROR*	Transmitter failure	Contact your Nihon Kohden representative.
SYS OUT OF RANGE	The systolic blood pressure exceeded the 40 to 280 mmHg range and the blood pressure cannot be measured.	Measure by palpation or auscultation.
WEAK PULSE* (displayed in blue)	Poor peripheral circulation	Check the patient condition and change the probe attachment site.
	The probe is attached too tightly and is obstructing the blood circulation	Check the probe attachment condition and if necessary, reattach the probe.
WEAK PULSE (displayed in pink)	The patient's pulse wave is too small to measure NIBP	Measure NIBP by palpation or auscultation.
	The cuff is wrapped too loosely	Wrap the cuff properly.
	The cuff size is not appropriate	Use the appropriate cuff.
ZEROING	NIBP zero balance is being adjusted	Do not touch the cuff during zeroing. Wait for the message to disappear.

### Message Display Priority

When more than one message condition occurs on the transmitter, only the message with the highest priority is displayed.

Priority	Message
High	PATIENT CONFIRMED
↑	SAFETY CIRCUIT RUNNING
	CUFF OCCLUSION
	PROBE FAILURE
	CHECK ELECTRODES
	NIBP MODULE ERROR
	SYS OUT OF RANGE
	HIGH CUFF PRESS
	AIR LEAK
	MEAS TIME OUT
	CANNOT DETECT PULSE (NIBP)
	SpO <sub>2</sub> MODULE ERROR
	CHECK PROBE
	CHECK PROBE SITE
	CANNOT DETECT PULSE (SpO <sub>2</sub> )
	LIGHT INTERFERENCE
	REMEASURING
	INFLATION PRESS LOW
	WEAK PULSE (NIBP)
	ZEROING
	NO NIBP CHANGE BATTERIES
	DETECTING PULSE
	WEAK PULSE (SpO <sub>2</sub> )
	ALARMS SUSPENDED
Low	BATTERY WEAK

## Troubleshooting

If a problem occurs, use the following tables to find and fix it. If the problem still remains after troubleshooting according to these tables, contact your Nihon Kohden representative.

### Transmitter

Problem	Cause	Countermeasure
Nothing is displayed on the LCD after turning the power on.	Batteries are not installed correctly. The battery polarity is wrong.	Install the batteries correctly.
	Batteries are completely discharged.	Replace the batteries with new ones.
LCD is difficult to see (too dark or too light).	LCD brightness is not appropriate.	Change the LCD brightness on the SYSTEM SETUP screen. Refer to the "Changing SYSTEM SETUP Settings" section.
Nothing is displayed on the receiving monitor after turning the transmitter power on.	The channel of the transmitter and monitor does not match.	Set the correct channel on the monitor.
	The software version of the multiple patient receiver or central monitor is old.	Upgrade the multiple patient receiver or central monitor software to receive signal from the transmitter. The software version must be 01-09 or later.
	Protocol on the transmitter and monitor does not match.	Set the same protocol on the transmitter and monitor.
Signal receiving condition is poor.	Another transmitter with the same channel is used nearby.	Turn the transmitter power off. If the monitor still receives a signal, there is a high probability that another transmitter of the same channel is used nearby.  Follow the instruction of your channel administrator and use another transmitter with a different channel.
	Signals of another patient are mixing.	Follow the instructions of your channel administrator and use another transmitter of a different channel.
	The transmitter is damaged.	Contact your Nihon Kohden representative.



## ECG/Respiration

Problem	Cause	Countermeasure
The heart rate is unstable.	Pacing detection setting on the monitor is not correct.	Turn off the pacing detection setting on the monitor. When monitoring a pacemaker patient, turn on pacing detection.
The “CHECK ELECTRODES” message appears on the receiving monitor.	Electrode lead is disconnected from the electrode.	Firmly connect the electrode lead to the electrode.
	Electrode lead discontinuity	Replace the electrode lead with a new one.
	Electrode is not firmly attached to the skin.	Replace the electrode with a new one.
	Polarization voltage is abnormally high.	Use Nihon Kohden specified electrodes.
ECG baseline is thick (AC hum).	The gel on the electrode is dried out.	Replace the electrode with a new one.
	The gel on the electrode is coming off.	
	An electric blanket is used.	Cover the blanket with a shield cover.
	The hum filter is set to OFF on the monitor.	Set the filter to ON.
The heart rate of a patient who is using an electric blanket is unstable on the receiving monitor.	Pacing pulse detection is turned ON on the receiving monitor.	Turn OFF the pacing pulse detection on the receiving monitor.
No heart rate or ECG is displayed.	“ECG MEASUREMENT” on the PARAMETER SETUP screen is set to OFF.	If ECG monitoring is necessary, set “ECG MEASUREMENT” to ON.
Respiration waveform measurement is unstable.	The gel on the electrode is dried out.	Replace the electrode with a new one.
	The gel on the electrode is coming off.	
No respiration rate is displayed.	“RESP MEASUREMENT” on the PARAMETER SETUP screen is set to OFF.	If respiration monitoring is necessary, set “RESP MEASUREMENT” to ON.

## SpO<sub>2</sub>

Problem	Cause	Countermeasure
SpO <sub>2</sub> data is unstable and not reliable.	The probe size is not appropriate for the patient.	Use the appropriate probe for the patient.
	Probe attachment condition is poor. The probe is partly detached from the skin. External light is entering the probe.	Firmly attach the probe according to the procedure in the probe operator's manual.
	Measurement site is dirty. Patient is wearing nail polish.	Remove dirt and nail polish.
	The probe is attached to the same limb that is used for NIBP measurement.	Attach the probe to the opposite limb. Avoid a site where blood circulation condition changes greatly.

## NIBP

Problem	Cause	Countermeasure
Cuff inflation pressure is less than 10 mmHg.	The cuff hose is not connected to the NIBP socket properly.	Connect the cuff hose to the socket properly.
	The cuff is not wrapped around the arm or is wrapped too loosely.	Wrap the cuff around the upper arm.
The cuff does not inflate when the NIBP Start/Stop key is pressed.	The cuff hose is not connected to the NIBP socket.	Connect the cuff hose to the socket firmly.
	The cuff hose or extension hose may be folded or squeezed when the cuff pressure display on the screen increases quickly but the actual cuff does not inflate.	Check the cuff hose and air hose.
Abnormal measurement results are displayed.	The cuff size is not correct.	Select the cuff which fits the patient's limb circumference.
	The cuff is not wrapped around the arm correctly.	Wrap the cuff around the upper arm, not too tightly or too loosely.
	NIBP data is not correct because of body movement.	Prevent the patient from moving during measurement.
	Vibration on the cuff.	Check that nothing is touching the cuff during measurement. Change the measuring site.
The cuff is suddenly deflated during inflation.	The NIBP Start/Stop key is pressed during inflation.	—

<b>Problem</b>	<b>Cause</b>	<b>Countermeasure</b>
Auto mode measurement does not start even when the time interval has passed.	The NIBP Interval key is pressed and the measurement mode is changed.	Check the measurement mode and interval.
The cuff suddenly inflates.	The measurement mode is set to auto mode.	Check the time interval. If necessary, stop measurement.
Cannot connect cuff to the air hose.	Unspecified cuff is used.	Use a cuff specified by Nihon Kohden.
Cannot measure NIBP.	Vibration on the cuff.	Check that nothing is touching the cuff during measurement.
	The cuff hose or extension hose is bent or squeezed.	Remove the cause.
	The cuff has worn out.	Use a new cuff.
Blood congestion occurs.	Measuring over a long period of time at short intervals.	Increase the measuring interval.
		Do not measure NIBP over a long time.
Thrombus occurs.	Measuring on a patient with known bleeding disorders or coagulation.	Do not perform NIBP measurement on such a patient.
NIBP data on the screen is --- or dark.	The time set for "OLD NIBP DATA" on the PARAMETER SETUP screen elapsed from the last measurement.	When NIBP is measured again, the data is displayed in normal brightness.
Three loud pip sounds indicating NIBP measurement cannot be started.	The cuff is not deflated enough to start another measurement.	Wait 30 seconds and measure again.

## Maintenance

To use the transmitter in safe and optimum condition, perform maintenance check at least once every year.

The transmitter contains parts which gradually deteriorate with use. Original performance might not be delivered if any part of the transmitter is deteriorated. Perform regular maintenance checks to assure continued safe operation.

The following units are necessary for some checking items.

- AX-410G medical instrument checker
- AX-300T SpO<sub>2</sub> checker
- Electric or mercury manometer
- 700 mL dummy cuff
- Receiving monitor



A I N

ever disassemble or repair the transmitter. If there is any problem with the transmitter, contact your Johnson & Johnson representative.



A I N

Before maintenance, cleaning or disinfection, turn the transmitter power off and remove the batteries. Failure to follow this instruction may result in electrical shock and transmitter malfunction.

- NOTE**
- The measurement accuracy of the above units must be managed to perform accurate maintenance check.
  - For details on the operation of the above units, refer to the manuals provided with these units.

A maintenance check sheet is provided at the end of this operator's manual. Make a copy of this check sheet before performing maintenance check.

## 1. External Check

- There is no damage or dirt on the outside of the transmitter.
- The battery case cover is not damaged and can be closed firmly.
- No keys are damaged.
- NIBP socket is not damaged.
- No electrode leads are damaged.
- There are no blood or chemicals on the transmitter.
- The springs in the battery compartment are not damaged or detached.
- Terminals in the battery case are not corroded.

## 2. Transmitter Channel

- The channel number label on the transmitter is not torn or removed.
- The channel of the transmitter matches the label.

The transmitter channel is displayed in the upper left corner of the screen. The channel number also appears on the startup screen.



Startup screen

Channel numbers



Numeric and waveform screen

## 3. Transmitting/Receiving Signal

Use the AX-410G medical instrument checker and receiving monitor.

- 1 Connect the medical instrument checker to the transmitter only with the electrode leads.

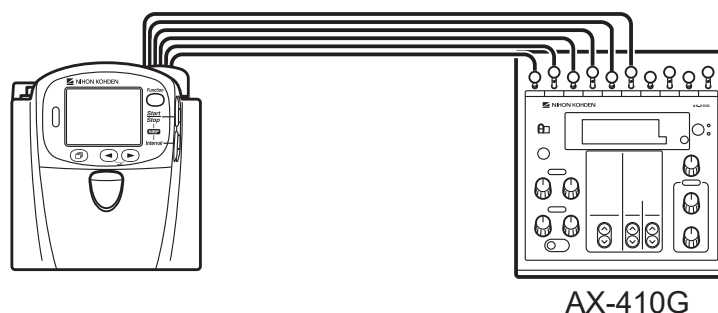

AX-410G

- 2 Place the transmitter 2 to 3 m from the receiving monitor.
- 3 Set the channel on the receiving monitor to the channel of the transmitter.
- 4 Turn on the transmitter and medical instrument checker.
- 5 Check that the ECG of the transmitter appears on the receiving monitor.
- 6 Turn off the transmitter.
- 7 Check that the ECG disappears from the receiving monitor.

## 4. Display

Check that there are no dots missing on the screen.

- 1 Turn off the transmitter.
- 2 While pressing the Function key, turn on the transmitter. The MENU screen appears.
- 3 Press the ► key to move the cursor to “MANUAL CHECK” and press the Function key.



- 4 Press the ◀ or ▶ key to move the cursor to “LCD TEST” and press the Function key.

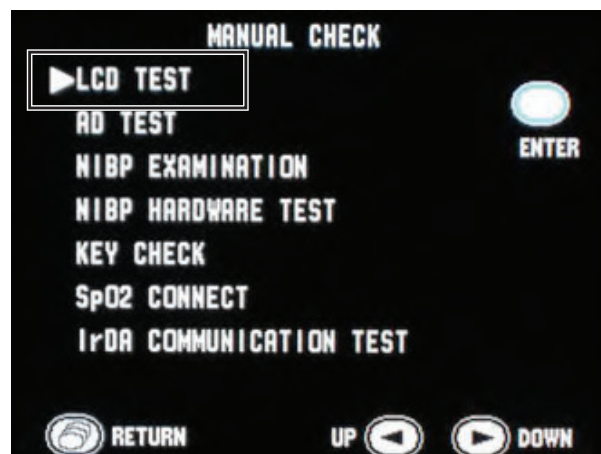

- 5** Each time the ► key is pressed, the screen changes as below. Check that no dots are missing.

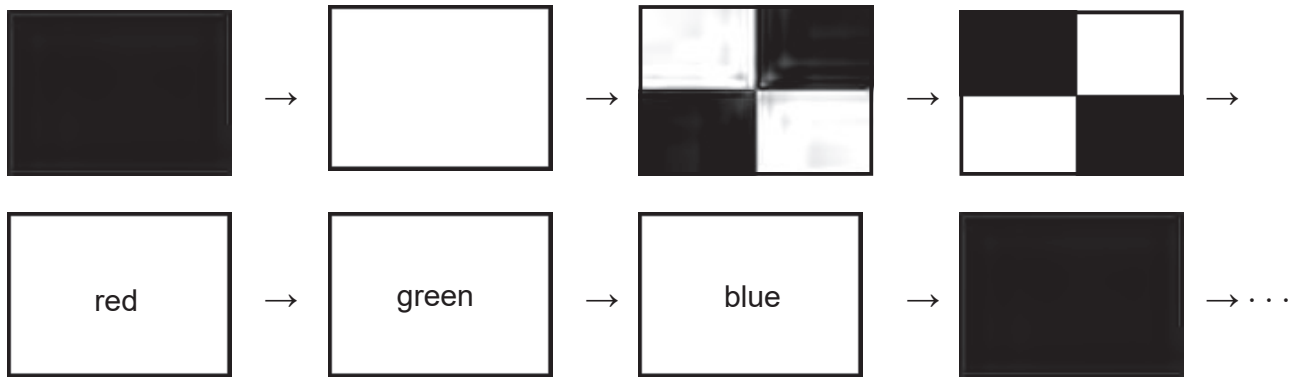

- 6** Press the Screen key to return to the MANUAL CHECK screen.

- 7** Press the Screen key again to return to the MENU screen.

## 5. Key Operation

- 1** Turn off the transmitter.
- 2** While pressing the Function key, turn on the transmitter. The MENU screen appears.
- 3** Press the ► key to move the cursor to “MANUAL CHECK” and press the Function key.

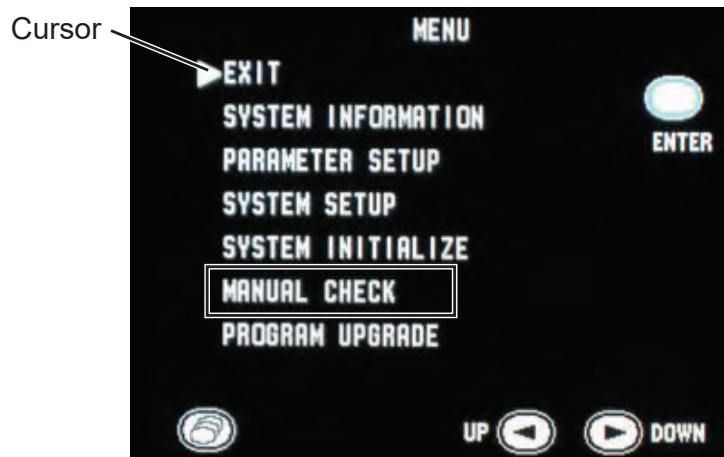

- 4 Press the ◀ or ▶ key to move the cursor to “KEY CHECK” and press the Function key.

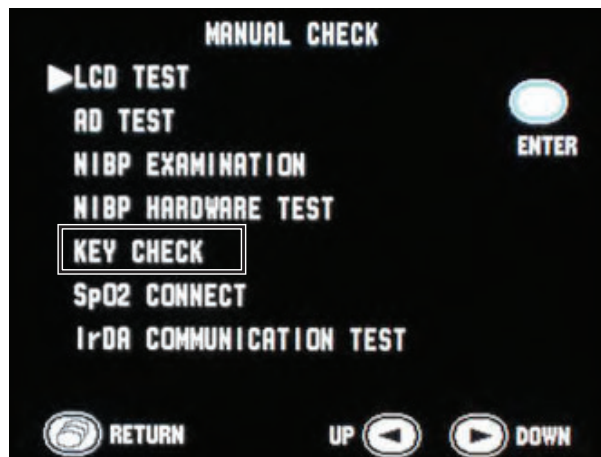

- 5 Press each key one at a time and check that the pressed key is highlighted on the screen.

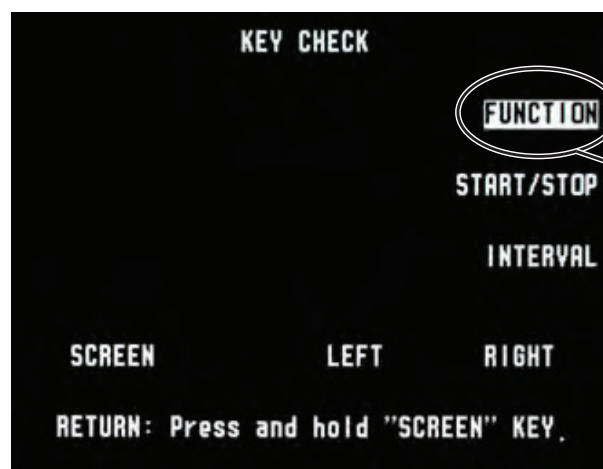

Example:  
When the Function key is pressed, the key name is highlighted.

- 6 After checking, press and hold the Screen key to return to the MANUAL CHECK screen.

## 6. ECG Check

- 1 Connect the medical instrument checker to the transmitter only with the electrode leads.

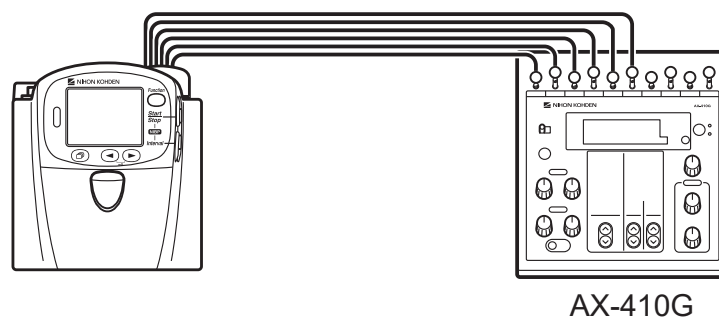

- 2 Place the transmitter 1 m from the receiving monitor.



- 3 Turn on the transmitter and medical instrument checker.
- 4 Check that the ECG of the transmitter appears on the receiving monitor.

---

## 7. Respiration Check

- 1 Connect the medical instrument checker to the transmitter only with the electrode leads.

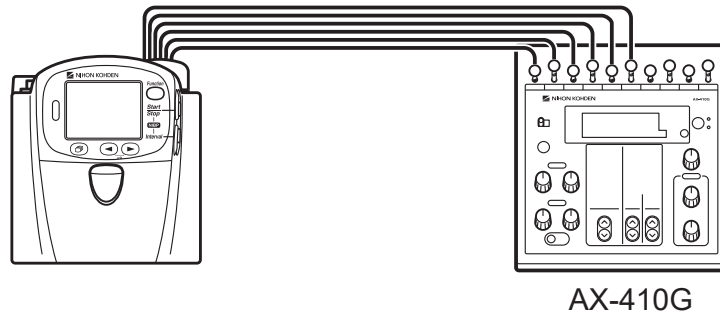

- 2 Place the transmitter 1 m from the receiving monitor.
- 3 Turn on the transmitter and medical instrument checker.
- 4 Check that the respiration waveform of the transmitter appears on the receiving monitor.

---

## 8. SpO<sub>2</sub> Check

SpO<sub>2</sub> can be checked with the AX-300T SpO<sub>2</sub> checker or AX-410G medical instrument checker.

### With the AX-300T SpO<sub>2</sub> Checker

- 1 Connect the SpO<sub>2</sub> checker to the transmitter only with the SpO<sub>2</sub> connection cable.

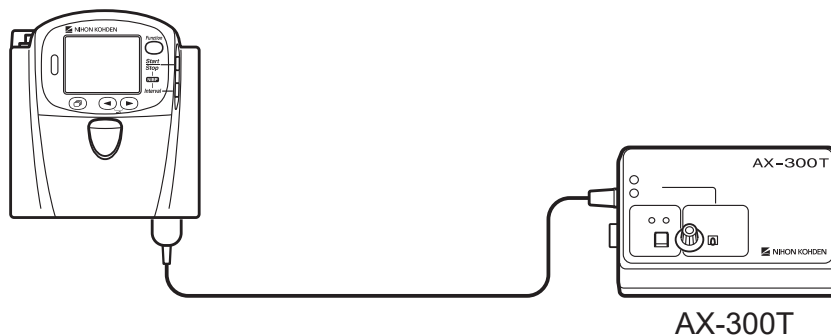

- 2 Place the transmitter 1 m from the receiving monitor.
- 3 Turn on the transmitter and SpO<sub>2</sub> checker.
- 4 Check that the pulse bar graph appears on the transmitter screen.

- 5** Check that SpO<sub>2</sub> and pulse rate on the transmitter is within the following range.

SpO <sub>2</sub> on the SpO <sub>2</sub> Checker		Range
SpO <sub>2</sub> <sup>1</sup>	97%	95 to 99%SpO <sub>2</sub> (±2 digits)
	80%	78 to 82%SpO <sub>2</sub> (±2 digits)
	70%	66 to 74%SpO <sub>2</sub> (±4 digits)
Pulse rate	60 beats/min	57 to 63 beats/min (±3% ±1 beat/min)
	120 beats/min	115 to 125 beats/min (±3% ±1 beat/min)

<sup>1</sup> The SpO<sub>2</sub> check by the SpO<sub>2</sub> checker is affected by the checker's tolerance to the SpO<sub>2</sub> measuring accuracy of the transmitter. (The measurement accuracy is described in the "Specifications" section.) For details, refer to the SpO<sub>2</sub> checker manual.

- 6** Check that the SpO<sub>2</sub> and pulse waveform of the transmitter appear on the receiving monitor.

### With the AX-410G Medical Instrument Checker

- 1** Connect the medical instrument checker to the transmitter only with the SpO<sub>2</sub> connection cable.

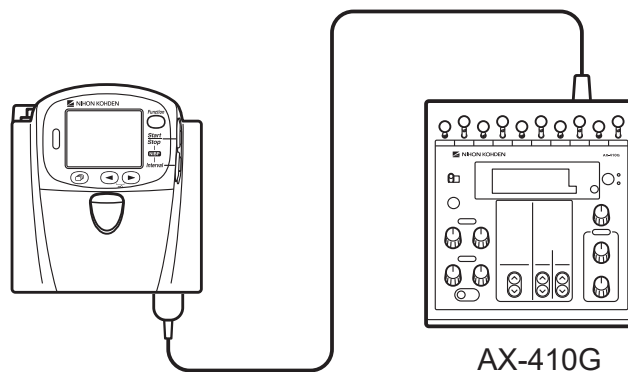

- 2** Place the transmitter 1 m from the receiving monitor.
- 3** Turn on the transmitter and medical instrument checker.
- 4** Check that the pulse bar graph appears on the transmitter screen.
- 5** Check that SpO<sub>2</sub> and pulse rate on the transmitter is within the following range.

Medical Instrument Checker		Range
SpO <sub>2</sub> <sup>1</sup>	97%SpO <sub>2</sub>	95 to 99%SpO <sub>2</sub> (97%SpO <sub>2</sub> ± 2 digit)
	80%SpO <sub>2</sub>	78 to 82%SpO <sub>2</sub> (80%SpO <sub>2</sub> ± 2 digit)
	70%SpO <sub>2</sub>	66 to 74%SpO <sub>2</sub> (70%SpO <sub>2</sub> ± 4 digit)
PR	60 bpm	57 to 63 bpm (120 bpm ± 3% ±1 bpm)

<sup>1</sup> The SpO<sub>2</sub> check by the medical instrument checker is affected by the checker's tolerance to the SpO<sub>2</sub> measuring accuracy of the transmitter. (The measurement accuracy is described in the "Specifications" section.) For details, refer to the medical instrument checker manual.

- 6 Check that the SpO<sub>2</sub> and ECG of the transmitter appear on the receiving monitor.

## 9. NIBP Check

Check that the transmitter displays the correct cuff pressure and that there is no air leak. Also check the pressure sensor. The following procedure uses an electric manometer.

- 1 Connect the electric manometer and dummy cuff to the transmitter.

NOTE: Air leaks from the rubber ball during inflation. Use a clip on the air hose of the rubber ball to stop air leaking.

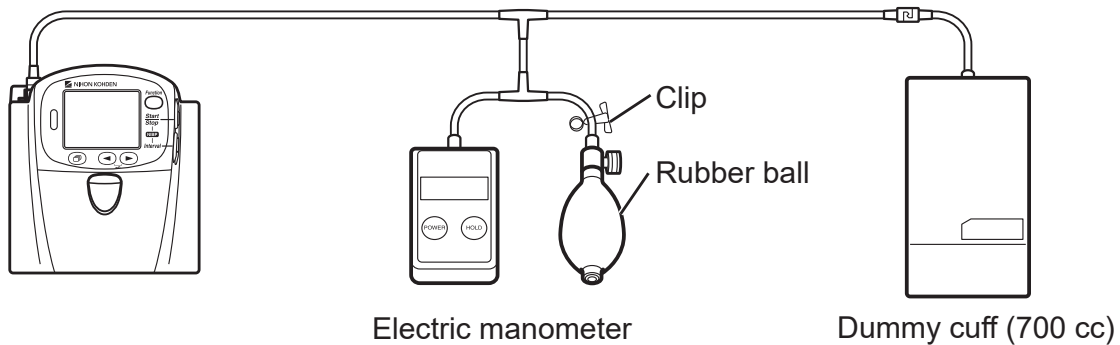

- 2 Turn on the electric manometer.
- 3 While pressing the Function key, turn on the transmitter. The MENU screen appears.
- 4 Press the ► key to move the cursor to “MANUAL CHECK” and press the Function key.

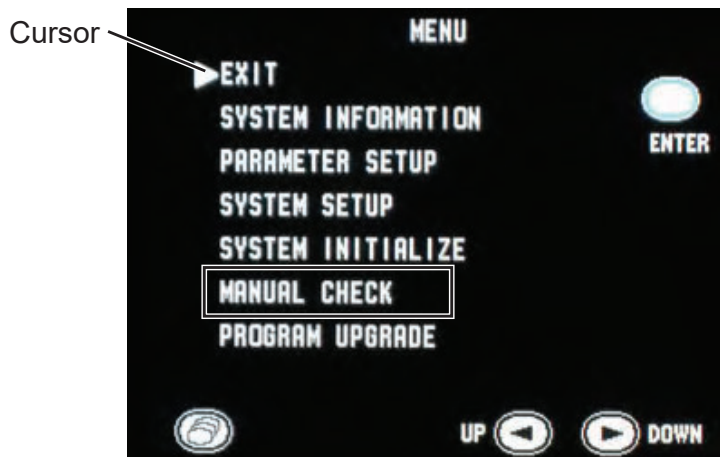

- 5 Press the ◀ or ▶ key to move the cursor to “NIBP HARDWARE TEST” and press the Function key.

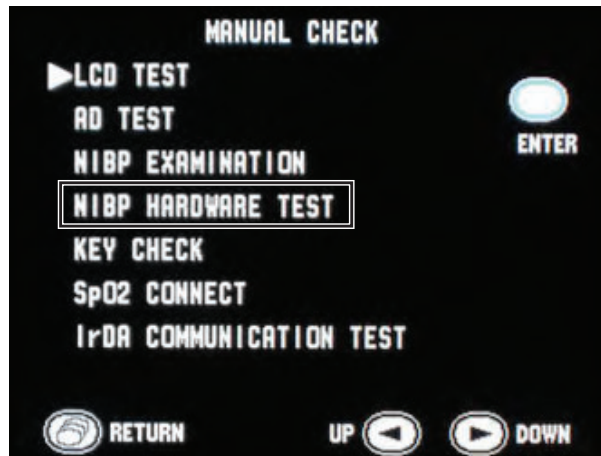

- 6 Press the ◀ or ▶ key to move the cursor to “AIR LEAK TEST” and press the Function key.

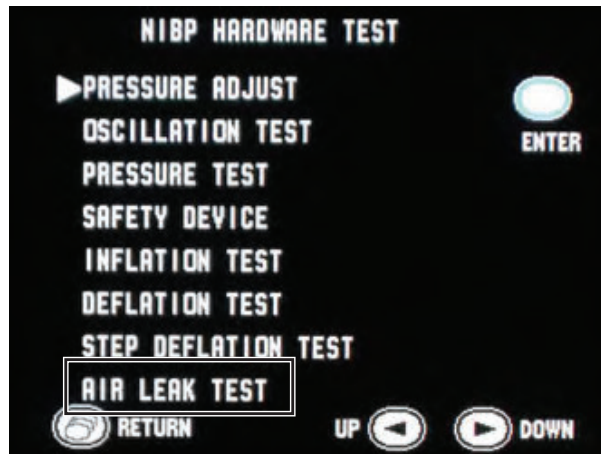

- 7 Press the ◀ or ▶ key to move the cursor to “AIRLEAK(AUTO)” and press the Function key.



The transmitter inflates the cuff up to about 250 mmHg and measures air leakage from 60 seconds to 120 seconds after inflation.

- 8 Check the following.
  - The value for “AIR LEAK (AUTO)” is below 10 mmHg.
  - The difference between the pressure value displayed on the manometer and transmitter is within  $\pm 6$  mmHg.
- 9 Press the Screen key to return to the NIBP HARDWARE TEST screen.
- 10 Press the ◀ or ▶ key to move the cursor to “PRESSURE TEST” and press the Function key.

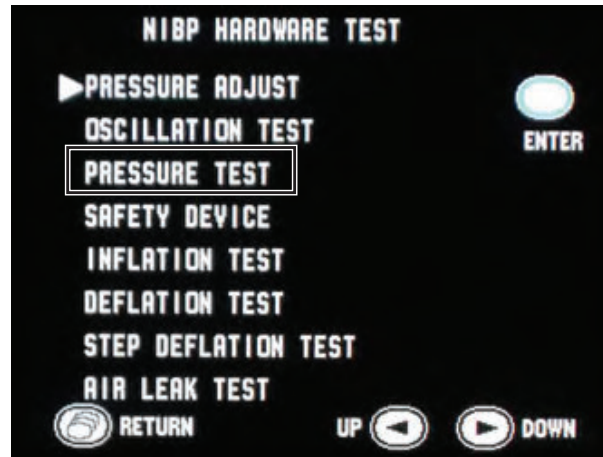

- 11 Remove the clip from the air hose of the rubber ball.

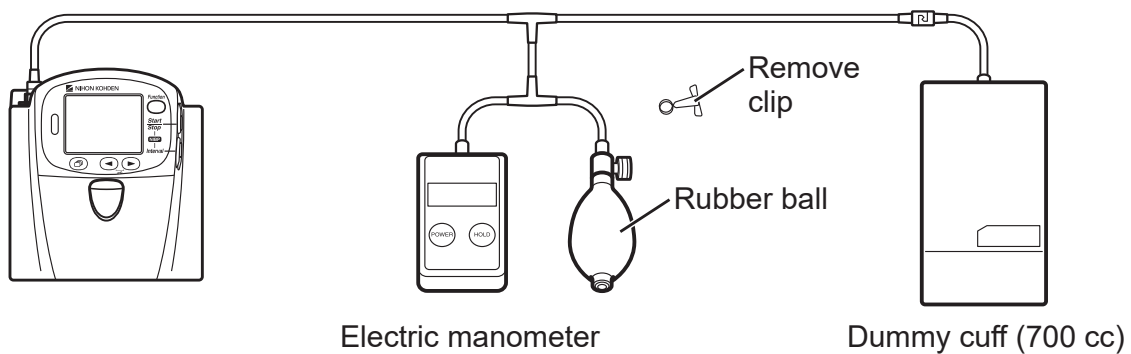

- 12 By squeezing the rubber ball, increase pressure up to 300 mmHg on the manometer.

**13** Check the following.

- The difference between the pressure value displayed on the manometer and “PRESS. (SAFETY)” value on the transmitter is within  $\pm 15$  mmHg.
- The difference between the pressure value displayed on the manometer and “PRESS” value on the transmitter is within  $\pm 6$  mmHg.

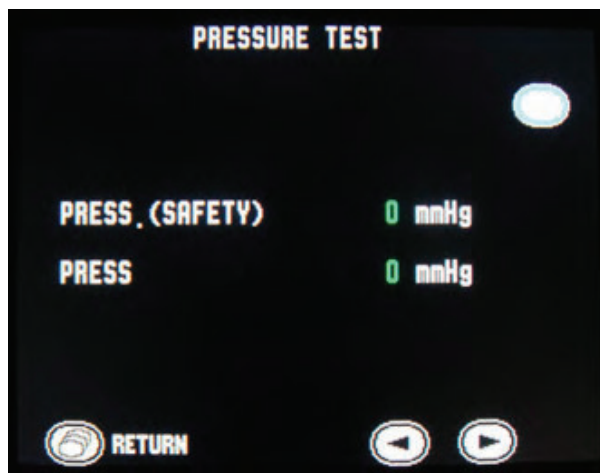

---

## 10. NIBP Cuff for Attaching Transmitter to Patient Arm

The NIBP cuff is a consumable. Check the following and when necessary, replace it with a new one.

**Appearance**

- There are no dirty parts.
- There are no broken stitches on the cuff.
- The label on the cuff is readable.
- The velcro tape on the cuff is not removed and there are no broken stitches.

**Inflation bag**

- The inflation bag is not torn or damaged.
- There is no water inside the inflation bag.
- The connector on the inflation bag is not damaged.

## Lifetime and Disposal



Dispose of infusion products according to your local laws and your facility's guidelines for waste disposal. Otherwise, it may affect the environment. If there is a possibility that the product may have been contaminated with infection, dispose of it as medical waste according to your local laws and your facility's guidelines for medical waste. Otherwise, it may cause infection.

---

### Disposing of Used Batteries

#### Battery Lifetime

Replace the batteries when the battery replacement indication appears on the transmitter. When using rechargeable batteries, recharge them.

#### Disposal

NOTE: Remove the batteries before disposing of the transmitter.

Before disposing of the batteries, check with your local solid waste officials for details in your area for proper disposal. It may be illegal to dispose of these batteries in the municipal waste stream.

---

### Disposing of Electrodes, SpO<sub>2</sub> Probes and NIBP Cuffs

Refer to the manual for each item.

---

### Disposing of Transmitter

Remove the batteries from the transmitter and dispose of the transmitter following your local laws for disposal.

# Cleaning, Disinfection and Sterilization

## Transmitter and Electrode Leads

### ⚠ A I N

If detergent or liquid spills into the transmitter, stop cleaning or disinfecting it and contact your physician's representative. The transmitter needs to be checked for safety and function before use.

- NOTE**
- The transmitter cannot be sterilized. Sterilizing the transmitter may damage it.
  - When cleaning or disinfecting the transmitter, disconnect it from the patient and remove the batteries beforehand. Otherwise it may result in malfunction.
  - Do not let the NIBP socket get wet during cleaning and disinfection.
  - Do not use a hair dryer etc. to dry the transmitter when it is wet. Doing so may cause the transmitter to deform or become damaged. It may also cause loss of the waterproofing function.
  - Do not use volatile liquids such as thinner or benzene because these will cause the materials to deform or crack.
  - Avoid using flammable disinfectants such as ethanol in a closed place. Ventilate the room if you use flammable disinfectants.
  - Wipe the transmitter with a dry cloth before use and dry it completely after cleaning and disinfecting.

Before cleaning or disinfecting the transmitter, disconnect it from the patient and remove the batteries from the transmitter. Be careful not to let any liquid get inside the transmitter.

### Cleaning

Wipe the transmitter and electrode leads with a soft cloth moistened with disinfecting alcohol or neutral detergent diluted with water. After cleaning, dry them completely.

Use cotton swab moistened with neutral detergent diluted with water to clean inside the battery compartment.



## Disinfection



Do not immerse the electrode lead connector in liquid.

Wipe the outside surface of the transmitter and electrode lead with a non-abrasive cloth moistened with any of the disinfectants listed below. For details on the disinfectants, refer to the instruction provided with the disinfectants. Use the recommended concentration.

<u>Disinfectant</u>	<u>Concentration (%)</u>
Glutaraldehyde solution	2.0
Alkyldiaminoethylglycine hydrochloride	0.5
Benzalkonium chloride	0.2
Benzethonium chloride solution	0.2
Chlorhexidine gluconate solution	0.5

---

## SpO<sub>2</sub> Probe

Refer to the probe manual.

---

## NIBP Cuff

Refer to the cuff manual.

## Periodic Inspection

If the periodic inspection is not performed, degradation or loss of function may go unnoticed and lead to misdiagnosis.

Service personnel should perform the periodic inspection at least once every year. Make sure that the transmitter operates properly and replace the consumables.

If you found abnormalities as a result of inspection and the transmitter is suspected to be faulty, attach an "Unusable" or "Repair request" label to the transmitter and contact your Nihon Kohden representative.

## Repair Parts Availability Policy

Nihon Kohden Corporation (NKC) shall stock repair parts (parts necessary to maintain the performance of the instrument) for a period of 8 years from the date of delivery. In that period NKC or its authorized agents will repair the instrument. This period may be shorter than 8 years if a board or part necessary for the faulty section is not available.

# Specifications

## ZM-540PA

### Measured Parameters

Waveforms:	ECG, impedance method respiration, pulse
Numeric data:	Heart rate, respiration rate, SpO <sub>2</sub> , NIBP, pulse rate

### Transmitted Data

Waveforms:	ECG, respiration, pulse wave
Numeric data:	SpO <sub>2</sub> , NIBP, pulse rate
Status information:	Battery replacement, battery level <sup>1</sup> , alarm suspended, pause monitoring <sup>1</sup> , patient confirmed <sup>1</sup> , ECG lead, pacing detection, electrode detachment, electrode impedance <sup>1</sup> , ECG off <sup>1</sup> , respiration method (impedance) <sup>1</sup> , SpO <sub>2</sub> status, NIBP status, channel ID, time constant (3.2 s), type of transmitter, transmitter code number <sup>1</sup> , transmitter serial number <sup>1</sup>

<sup>1</sup> Transmitted only when the protocol is "57".

### Display

Display size:	2.2 inch TFT color LCD
Viewing area:	44.16 (H) × 33.12 (V) mm
Resolution:	320 (H) × 240 (V) dots

### Displayed Data

Numeric and waveform screen:	ECG (one waveform from lead I, II, III, Va or Vb), heart rate, pulse rate, respiration rate, SpO <sub>2</sub> , NIBP (systolic, diastolic, MAP), message, battery level, QRS/pulse sync mark, pulse bar graph, NIBP measurement mode and status information, ECG lead
Waveform review screen:	ECG or pulse wave of past 10 minutes
Numeric review screen:	Heart rate or pulse rate, respiration rate and SpO <sub>2</sub> at 1 minute interval for past 10 minutes
Check electrodes screen:	ECG for checking electrode attachment

## ECG

### ECG Measurement

Channels:	4
Input dynamic range:	±10 mV or more
Electrode offset potential tolerance:	±500 mV or more
Input impedance:	5 MΩ or more
Common mode rejection ratio:	95 dB or more
	IEC 60601-2-27 50.102.10 compliant

Pacing pulse detection:	amplitude $\pm 2$ to 700 mV, duration 0.1 to 2 ms IEC 60601-2-27: 2005 compliant Based upon pacemaker pulse rejection capability
Defibrillation-proof:	ECG input protected against 400 Ws/DC 5 kV IEC 60601-2-27 17.101 compliant
ECG recovery time after defibrillation:	within 10 s
Electrode condition:	Displays CHECK ELECTRODES message
Tall T-wave rejection capability:	Complies with the heights of T-waves from 0 to 1.6 mV IEC 60601-2-27: 2005 50.102.17 compliant
Pacemaker pulse rejection capability, without overshoot:	Complies with the amplitudes of pacemaker pulses $\pm 2$ to $\pm 700$ mV and widths 0.1 to 2 ms (As defined by method B of IEC 60601-2-27: 2005 50.102.13, this corresponds to the pacemaker pulses amplitudes and widths of $\pm 2.8$ mV/2 ms to amplitudes $\pm 45.6$ mV/0.1 ms.)
Pacemaker pulse rejection capability, with overshoot:	Overshoot amplitudes and time constants of $\pm 0.12$ mV/100 ms to $\pm 2$ mV/4 ms (As defined by method B of IEC 60601-2-27: 2005 50.102.13, this corresponds to the pacemaker pulses amplitudes and widths of $\pm 2.8$ mV/2 ms to amplitudes $\pm 45.6$ mV/0.1 ms.)

## ECG Display and Heart Rate Count

Frequency characteristic:	filter on: 1 to 18 Hz, filter off: 0.05 to 60 Hz
Heart rate detection method:	Average
QRS detection:	70 to 120 ms: amplitude $\geq 0.5$ mV, rate 30 to 200 beats/min 40 to 120 ms: amplitude $\geq 0.5$ mV, rate 30 to 250 beats/min
Heart rate counting range:	0, 15 to 300 beats/min
Heart rate counting accuracy <sup>1</sup> :	$\pm 2$ beats/min, (0, 15 to 300 beats/min)

<sup>1</sup> Essential performance of this transmitter

## Respiration Measurement

Measuring method:	Impedance method
Measuring lead:	Between R and F
Impedance range:	2 k $\Omega$ or less
Respiration rate measuring accuracy <sup>1</sup> :	$\pm 2$ counts/min (at 0 to 150 counts/min)
Respiration rate counting range:	0 to 150 counts/min

<sup>1</sup> Essential performance of this transmitter

## SpO<sub>2</sub> Measurement (ISO 9919: 2005 compliant)

Measuring range:	0 to 100%SpO <sub>2</sub>
Declared range:	70 to 100%SpO <sub>2</sub>
Minimum display range:	1%SpO <sub>2</sub>
Display update cycle:	Every 3 seconds

Measuring accuracy (rms) <sup>1</sup> :	Accuracy assurance temperature: 18 to 40°C
Total accuracy including probe:	80%SpO <sub>2</sub> ≤ %SpO <sub>2</sub> ≤ 100%SpO <sub>2</sub> : ±2%SpO <sub>2</sub> 70%SpO <sub>2</sub> ≤ %SpO <sub>2</sub> < 80%SpO <sub>2</sub> : ±3%SpO <sub>2</sub> under 70%SpO <sub>2</sub> : not specified
Accuracy of the transmitter:	80%SpO <sub>2</sub> ≤ %SpO <sub>2</sub> ≤ 100%SpO <sub>2</sub> : ±1%SpO <sub>2</sub> 50%SpO <sub>2</sub> ≤ %SpO <sub>2</sub> < 80%SpO <sub>2</sub> : ±2%SpO <sub>2</sub> under 50%SpO <sub>2</sub> : not specified
Pulse rate measuring range:	30 to 300 bpm
Pulse rate display range:	30 to 300 bpm
Pulse rate accuracy (rms) <sup>1</sup> :	±3% ±1 bpm

<sup>1</sup> Essential performance of this transmitter

- NOTE**
- The SpO<sub>2</sub> measuring accuracy was tested using the TL-201T, TL-260T, TL-271T and TL-631T SpO<sub>2</sub> probes. The testing was performed during induced hypoxia on healthy volunteers (Ethnicity: 10 Caucasians, 2 Africans, 1 Asian and 3 Indians), (Skin: 8 light, 4 medium, 4 dark), (Age: 21 to 34), (5 women and 11 men) under the condition of no motion. Arterial blood was sampled and measured by a CO-oximeter. The difference between SpO<sub>2</sub> measured by the SpO<sub>2</sub> probe and functional SaO<sub>2</sub> measured by a CO-oximeter was calculated using the root-mean-square (rms) method. This measurement accuracy figure represents 2/3 of all test measurements.
  - A pulse oximeter tester that generates simulated signals can be used to check the difference from the design specification, but it cannot be used as a replacement for human signals for testings accuracy.

Response time:

Selectable from “Slow”, “Normal” and “Fast”.

The following graphs show response time for 0.6%/s SpO<sub>2</sub> change.

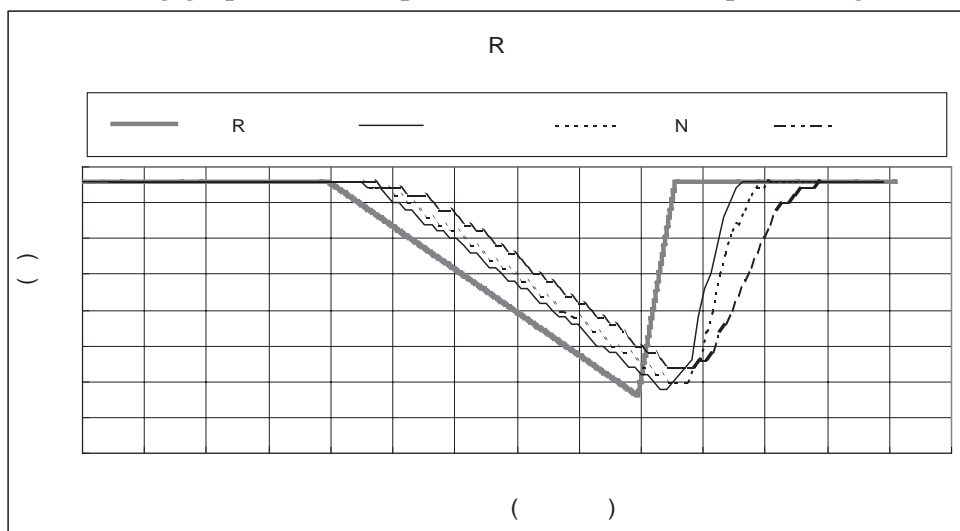

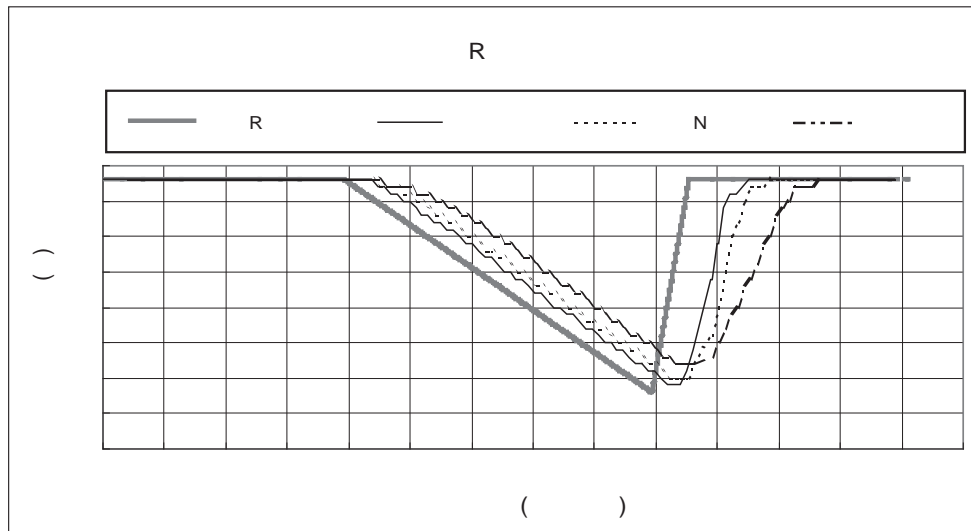

The following graph shows response time for 10 bpm/s pulse rate change.

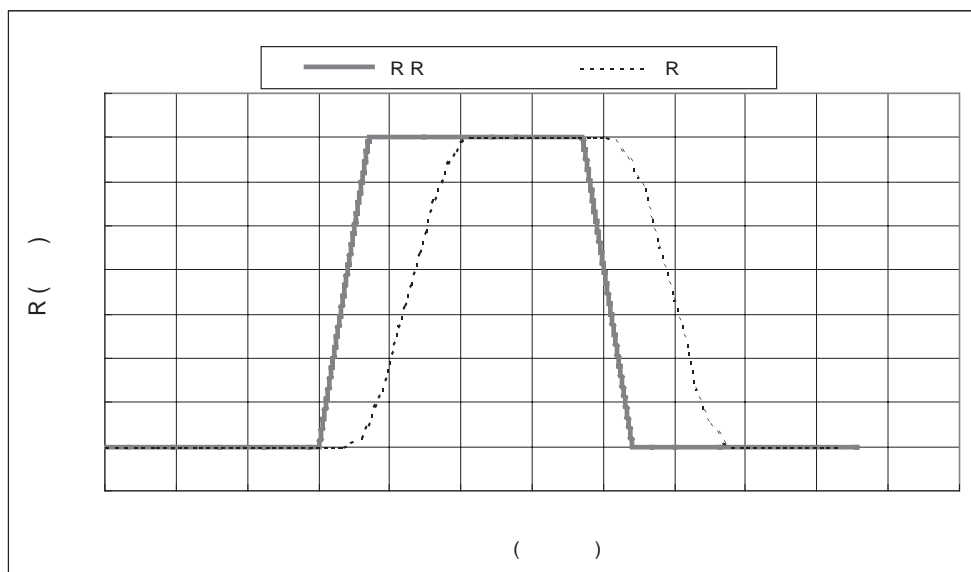

### Noninvasive Blood Pressure, NIBP (IEC 60601-2-30: 1999 compliant)

Measuring method:	Oscillometric
Measurement mode:	Manual, STAT ( $\leq 15$ min), Periodic
Intended patient type:	Adult, child
Measuring range:	0 to 300 mmHg
Pressure display range:	0 to 300 mmHg
Measuring accuracy <sup>1</sup> :	$\pm 3$ mmHg ( $0 \text{ mmHg} \leq \text{NIBP} \leq 300 \text{ mmHg}$ ) AAMI SP-10: 2002 compliant
Cuff inflation time:	$\leq 20$ s (700 cc), 0 to 200 mmHg $\leq 15$ s (70 cc), 0 to 200 mmHg
Pressure retention:	$\leq 5$ mmHg (250 cc at 250 mmHg inflation for 10 seconds)
Air leakage:	$\leq 3$ mmHg/min (700 cc at 300 mmHg inflation)
Maximum temperature at cuff attachment site:	43°C (109°F)
Power discontinuity:	Deflate immediately after power down

Safety:	Maximum pressurization value cuff inflation limiter:	300 to 330 mmHg
	Cuff inflation time limiter:	≤ 180 s
	Interval time limiter:	≤ 30 s

<sup>1</sup> Essential performance of this transmitter

## Transmitter

FCC regulation:	FCC part 95 Subpart H Wireless Medical Telemetry Service (WMTS)
Field strength limits:	< 200 mV/m (at 3 m)
Undesired emissions:	
FCC part 95 95.2379 (a), (b):	≤ 960 MHz: 200 μV/m (at 3 m) ≥ 960 MHz: 500 μV/m (at 3 m)
Antenna:	Internal
Transmission channel:	Indicated on the transmitter
Transmission frequency range:	608.0250 to 613.9750 MHz
Channel spacing:	50 kHz or 37.5 kHz (12.5 kHz when interleaved)
Modulation:	FSK (frequency shift keying)
Type of emission:	F1D
Occupied bandwidth:	< 20 kHz
Effective radiated power:	1.0 mW

## Power Requirements

Rated voltage:	3.6 V
Operating voltage:	3.2 to 4.8 V
Battery type:	Three AA (R6) type NiMH secondary batteries Three AA (R6) type alkaline dry cell primary batteries
Battery lifetime (with alkaline batteries, at room temperature):	approximately 1 day (measuring ECG, respiration, SpO <sub>2</sub> of approximately 60 kg weight adult male patient at the index finger, NIBP at 60 minute intervals)

## Dimensions and Weight

Dimensions:	114 W × 125 H × 63 D (mm)
Weight:	about 340 g (excluding batteries and other accessories) about 410 g (including batteries, excluding other accessories)

## Environment

### Operating environment

Temperature:	5 to 40°C (41 to 104°F)
Humidity:	30 to 85% (noncondensing)
Atmospheric pressure:	700 to 1060 hPa

**Storage and transport environment**

Temperature:	-20 to +65°C (-4 to +149°F)
Humidity:	10 to 95%
Atmospheric pressure:	700 to 1060 hPa

**Safety Standards**

Safety standard:	CAN/CSA-C22.2 No. 601-1 M90
	CAN/CSA-C22.2 No. 601-1. 1S1-94
	CAN/CSA-C22.2 No. 601-1. 1B-90
	CAN/CSA-C22.2 No. 60601-2-49-04
	CAN/CSA-C22.2 No. 60601-2-27-06
	CAN/CSA-C22.2 No. 60601-2-30-02
	IEC 60601-1:1988
	IEC 60601-1 Amendment 1: 1991
	IEC 60601-1 Amendment 2: 1995
	IEC 60601-2-27: 2005
	IEC 60601-2-30: 1999
	IEC 60601-2-49: 2001
	ISO 9919: 2005
UL 60601-1: 2003	

Type of protection against electrical shock:

INTERNALLY POWERED EQUIPMENT

Degree of protection against electrical shock:

ECG and impedance method respiration:

DEFIBRILLATION-PROOF TYPE CF APPLIED PART

SpO<sub>2</sub> and NIBP:

DEFIBRILLATION-PROOF TYPE BF APPLIED PART

Degree of protection against harmful ingress of water:

IPX0 (non-protected)

Degree of safety of application in the presence of a FLAMMABLE ANAESTHETIC MIXTURE WITH AIR, OR WITH OXYGEN OR NITROUS OXIDE:

Equipment not suitable for use in the presence of FLAMMABLE ANAESTHETIC MIXTURE WITH AIR, OR WITH OXYGEN OR NITROUS OXIDE

Mode of operation:

CONTINUOUS OPERATION

**Electromagnetic Compatibility**

IEC 60601-1-2: 2001

IEC 60601-1-2 Amendment 1: 2004



## Electromagnetic Emissions

This ZM-540PA is intended for use in the electromagnetic environment specified below. The customer or the user of the ZM-540PA should assure that it is used in such an environment.

Emissions test	Compliance	Electromagnetic environment - guidance
RF emissions CISPR 11	Group 1	The ZM-540PA uses RF energy only for its internal function. Therefore, its RF emissions are very low and are not likely to cause any interference in nearby electronic equipment.
RF emissions CISPR 11	Class B	The ZM-540PA is suitable for use in all establishments, including domestic establishments.
Harmonic emissions IEC 61000-3-2	Not applicable	
Voltage fluctuations/ flicker emissions IEC 61000-3-3	Not applicable	

## Electromagnetic Immunity

This ZM-540PA is intended for use in the electromagnetic environment specified below. The customer or the user of the ZM-540PA should assure that it is used in such an environment.

Immunity test	IEC 60601 test level	Compliance level	Electromagnetic environment - guidance
Electrostatic discharge (ESD) IEC 61000-4-2	±6 kV contact ±8 kV air	±6 kV contact ±8 kV air	Floors should be wood, concrete or ceramic tile. If floors are covered with synthetic material, the relative humidity should be at least 30%.
Electrical fast transient/ burst IEC 61000-4-4	±2 kV for power supply lines ±1 kV for input/output lines	Not applicable	—
Surge IEC 61000-4-5	±1 kV differential mode ±2 kV common mode	Not applicable	—
Voltage dips, short interruptions and voltage variations on power supply input lines IEC 61000-4-11	<5% $U_T$ (>95% dip in $U_T$ ) for 0.5 cycles 40% $U_T$ (60% dip in $U_T$ ) for 5 cycles 70% $U_T$ (30% dip in $U_T$ ) for 25 cycles <5% $U_T$ (>95% dip in $U_T$ ) for 5 s	Not applicable	—
Power frequency (50/60 Hz) magnetic field IEC 61000-4-8	3 A/m	3 A/m	Power frequency magnetic fields should be at levels characteristic of a typical location in a typical commercial or hospital environment.
NOTE: $U_T$ is the AC mains voltage prior to application of the test level.			

### Avoiding Electromagnetic Interference (Impedance Respiration)

Impedance respiration measurement is very sensitive and affected by electromagnetic interference. Technological limitations do not allow immunity levels higher than 1 V/m for radiated RF electromagnetic fields. Electromagnetic fields with field strengths above 1 V/m may cause measurement error. Do not use electrically radiating equipment near the impedance respiration measurements.

Immunity test	IEC 60601 test level	Compliance level	Electromagnetic environment - guidance
<p>Conducted RF IEC 61000-4-6</p> <p>Radiated RF IEC 61000-4-3</p>	<p>3 Vrms 150 kHz to 80 MHz</p> <p>3 V/m 80 MHz to 2.5 GHz</p>	<p>3 Vrms</p> <p>3 V/m 80 MHz to 2.5 GHz</p> <p>(1 V/m 80 MHz to 2.5 GHz for respiration)</p>	<p>Portable and mobile RF communications equipment should be used no closer to any part of the ZM-540PA, including cables, than the recommended separation distance calculated from the equation applicable to the frequency of the transmitter.</p> <p><b>Recommended separation distance</b>  <math>d = 1.2\sqrt{P}</math></p> <p><math>d = 1.2\sqrt{P}</math> 80 MHz to 800 MHz  <math>d = 2.3\sqrt{P}</math> 800 MHz to 2.5 GHz</p> <p>(<math>d = 3.5\sqrt{P}</math> 80 MHz to 800 MHz for respiration  <math>d = 7.0\sqrt{P}</math> 800 MHz to 2.5 GHz for respiration)</p> <p>where P is the maximum output power rating of the transmitter in watts (W) according to the transmitter manufacturer and d is the recommended separation distance in meters (m).</p> <p>Field strengths from fixed RF transmitters, as determined by an electromagnetic site survey<sup>1</sup>, should be less than the compliance level in each frequency range<sup>2</sup>.</p> <p>Interference may occur in the vicinity of equipment marked with the following symbol:  </p>
<p>NOTE 1: At 80 MHz and 800 MHz, the higher frequency range applies.</p>			
<p>NOTE 2: These guidelines may not apply in all situations. Electromagnetic propagation is affected by absorption and reflection from structures, objects and people.</p>			
<p><sup>1</sup> Field strengths from fixed transmitters, such as base stations for radio (cellular/cordless) telephones and land mobile radios, amateur radio, AM and FM radio broadcast and TV broadcast cannot be predicted theoretically with accuracy. To assess the electromagnetic environment due to fixed RF transmitters, an electromagnetic site survey should be considered. If the measured field strength in the location in which the ZM-540PA is used exceeds the applicable RF compliance level above, the ZM-540PA should be observed to verify normal operation. If abnormal performance is observed, additional measures may be necessary, such as re-orienting or relocating the ZM-540PA.</p> <p><sup>2</sup> Over the frequency range 150 kHz to 80 MHz, field strengths should be less than 1 V/m for respiration and 3 V/m for all other functions.</p>			

## Recommended Separation Distances between Portable and Mobile RF Communications Equipment

The ZM-540PA is intended for use in an electromagnetic environment in which radiated RF disturbances are controlled. The customer or the user of the ZM-540PA can help prevent electromagnetic interference by maintaining a minimum distance between portable and mobile RF communications equipment (transmitters) and the ZM-540PA as recommended below, according to the maximum output power of the communications equipment.

Rated maximum output power of transmitter (W)	Separation distance according to frequency of transmitter (m)		
	150 kHz to 80 MHz $d = 1.2\sqrt{P}$	80 MHz to 800 MHz $d = 1.2\sqrt{P}$ (For respiration: $d = 3.5\sqrt{P}$ )	800 MHz to 2.5 GHz $d = 2.3\sqrt{P}$ (For respiration: $d = 7.0\sqrt{P}$ )
0.01	0.12	0.12 (0.35 <sup>1</sup> )	0.23 (0.7 <sup>1</sup> )
0.1	0.38	0.38 (1.1 <sup>1</sup> )	0.73 (2.2 <sup>1</sup> )
1	1.2	1.2 (3.5 <sup>1</sup> )	2.3 (7.0 <sup>1</sup> )
10	3.8	3.8 (11 <sup>1</sup> )	7.3 (22 <sup>1</sup> )
100	12	12 (35 <sup>1</sup> )	23 (70 <sup>1</sup> )

For transmitters rated at a maximum output power not listed above, the recommended separation distance  $d$  in meters (m) can be estimated using the equation applicable to the frequency of the transmitter, where  $P$  is the maximum output power rating of the transmitter in watts (W) according to the transmitter manufacturer.

(<sup>1</sup> For respiration)

NOTE 1: At 80 MHz and 800 MHz, the separation distance for the higher frequency range applies.

NOTE 2: These guidelines may not apply in all situations. Electromagnetic propagation is affected by absorption and reflection from structures, objects and people.

## Recovery Time after Defibrillation

The transmitter returns to the normal operating mode within 10 seconds after defibrillation. The stored settings are not affected.

## System Composition for EMC Test

The ZM-540PA transmitter is tested to comply with IEC 60601-1-2:2001 and Amendment 1:2004 with the following composition. If any part which is not specified by Nihon Kohden is used, the EMC specifications might not comply.

Units	Cable Length
ZM-540PA transmitter	—
YP-503P NIBP cuff	0.15 m
BR-906P ECG electrode lead	0.8 m
TL-201T finger probe	1.6 m

## ZM-541PA

### Measured Parameters

Waveforms:	ECG, impedance method respiration, pulse
Numeric data:	Heart rate, respiration rate, SpO <sub>2</sub> , NIBP, pulse rate

### Transmitted Data

Waveforms:	ECG, respiration, pulse wave
Numeric data:	SpO <sub>2</sub> , NIBP, pulse rate
Status information:	Battery replacement, battery level <sup>1</sup> , alarm suspended, pause monitoring <sup>1</sup> , patient confirmed <sup>1</sup> , ECG lead, pacing detection, electrode detachment, electrode impedance <sup>1</sup> , ECG off <sup>1</sup> , respiration method (impedance) <sup>1</sup> , SpO <sub>2</sub> status, NIBP status, channel ID, time constant (3.2 s), type of transmitter, transmitter code number <sup>1</sup> , transmitter serial number <sup>1</sup>

<sup>1</sup> Transmitted only when the protocol is "57".

### Display

Display size:	2.2 inch TFT color LCD
Viewing area:	44.16 (H) × 33.12 (V) mm
Resolution:	320 (H) × 240 (V) dots

### Displayed Data

Numeric and waveform screen:	ECG (one waveform from lead I, II, III, Va or Vb), heart rate, pulse rate, respiration rate, SpO <sub>2</sub> , NIBP (systolic, diastolic, MAP), message, battery level, QRS/pulse sync mark, pulse bar graph, NIBP measurement mode and status information, ECG lead
Waveform review screen:	ECG or pulse wave of past 10 minutes
Numeric review screen:	Heart rate or pulse rate, respiration rate and SpO <sub>2</sub> at 1 minute interval for past 10 minutes
CHECK ELECTRODE screen:	ECG for checking electrode attachment

## ECG

### ECG Measurement

Channels:	4
Input dynamic range:	±10 mV or more
Electrode offset potential tolerance:	±500 mV or more
Input impedance:	5 MΩ or more
Common mode rejection ratio:	95 dB or more
Pacing pulse detection:	IEC 60601-2-27 50.102.10 compliant amplitude ±2 to 700 mV, duration 0.1 to 2 ms IEC 60601-2-27: 2005 compliant Based upon pacemaker pulse rejection capability
Defibrillation-proof:	ECG input protected against 400 Ws/DC 5 kV IEC 60601-2-27 17.101 compliant

ECG recovery time after defibrillation:	within 10 s
Electrode condition:	Displays CHECK ELECTRODES message
Tall T-wave rejection capability:	Complies with the heights of T-waves from 0 to 1.6 mV IEC 60601-2-27: 2005 50.102.17 compliant
Pacemaker pulse rejection capability, without overshoot:	Complies with the amplitudes of pacemaker pulses $\pm 2$ to $\pm 700$ mV and widths 0.1 to 2 ms (As defined by method B of IEC 60601-2-27: 2005 50.102.13, this corresponds to the pacemaker pulses amplitudes and widths of $\pm 2.8$ mV/2 ms to amplitudes $\pm 45.6$ mV/0.1 ms.)
Pacemaker pulse rejection capability, with overshoot:	Overshoot amplitudes and time constants of $\pm 0.12$ mV/100 ms to $\pm 2$ mV/4 ms (As defined by method B of IEC 60601-2-27: 2005 50.102.13, this corresponds to the pacemaker pulses amplitudes and widths of $\pm 2.8$ mV/2 ms to amplitudes $\pm 45.6$ mV/0.1 ms.)

### ECG Display and Heart Rate Count

Frequency characteristic:	filter on: 1 to 18 Hz, filter off: 0.05 to 60 Hz
Heart rate detection method:	Average
QRS detection:	70 to 120 ms: amplitude $\geq 0.5$ mV, rate 30 to 200 beats/min 40 to 120 ms: amplitude $\geq 0.5$ mV, rate 30 to 250 beats/min
Heart rate counting range:	0, 15 to 300 beats/min
Heart rate counting accuracy <sup>1</sup> :	$\pm 2$ beats/min, (0, 15 to 300 beats/min)

<sup>1</sup> Essential performance of this transmitter

### Respiration Measurement

Measuring method:	Impedance method
Measuring lead:	Between R and F
Impedance range:	2 k $\Omega$ or less
Respiration rate measuring accuracy <sup>1</sup> :	$\pm 2$ counts/min (at 0 to 150 counts/min)
Respiration rate counting range:	0 to 150 counts/min

<sup>1</sup> Essential performance of this transmitter

### SpO<sub>2</sub> Measurement (ISO 9919: 2005 compliant)

Measuring range:	0 to 100%SpO <sub>2</sub>
Declared range:	70 to 100%SpO <sub>2</sub>
Minimum display range:	1%SpO <sub>2</sub>
Display update cycle:	Every 3 seconds
Measuring accuracy (rms) <sup>1</sup> :	Accuracy assurance temperature: 18 to 40°C
Total accuracy including probe:	80%SpO <sub>2</sub> $\leq$ %SpO <sub>2</sub> $\leq$ 100%SpO <sub>2</sub> : $\pm 2\%$ SpO <sub>2</sub> 70%SpO <sub>2</sub> $\leq$ %SpO <sub>2</sub> $<$ 80%SpO <sub>2</sub> : $\pm 3\%$ SpO <sub>2</sub> under 70%SpO <sub>2</sub> : not specified
Accuracy of the transmitter:	80%SpO <sub>2</sub> $\leq$ %SpO <sub>2</sub> $\leq$ 100%SpO <sub>2</sub> : $\pm 1\%$ SpO <sub>2</sub> 50%SpO <sub>2</sub> $\leq$ %SpO <sub>2</sub> $<$ 80%SpO <sub>2</sub> : $\pm 2\%$ SpO <sub>2</sub> under 50%SpO <sub>2</sub> : not specified

Pulse rate measuring range: 30 to 300 bpm  
 Pulse rate display range: 30 to 300 bpm  
 Pulse rate accuracy (rms)<sup>1</sup>:  $\pm 3\% \pm 1$  bpm

<sup>1</sup> Essential performance of this transmitter

- NOTE**
- The SpO<sub>2</sub> measuring accuracy was tested using the TL-201T, TL-260T, TL-271T and TL-631T SpO<sub>2</sub> probes. The testing was performed during induced hypoxia on healthy volunteers (Ethnicity: 10 Caucasians, 2 Africans, 1 Asian and 3 Indians), (Skin: 8 light, 4 medium, 4 dark), (Age: 21 to 34), (5 women and 11 men) under the condition of no motion. Arterial blood was sampled and measured by a CO-oximeter. The difference between SpO<sub>2</sub> measured by the SpO<sub>2</sub> probe and functional SaO<sub>2</sub> measured by a CO-oximeter was calculated using the root-mean-square (rms) method according to ISO 9919: 2005. This measurement accuracy figure represents 2/3 of all test measurements.
  - A pulse oximeter tester that generates simulated signals can be used to check the difference from the design specification, but it cannot be used as a replacement for human signals for testings accuracy.

Response time:

Selectable from “Slow”, “Normal” and “Fast”.

The following graphs show response time for 0.6%/s SpO<sub>2</sub> change.

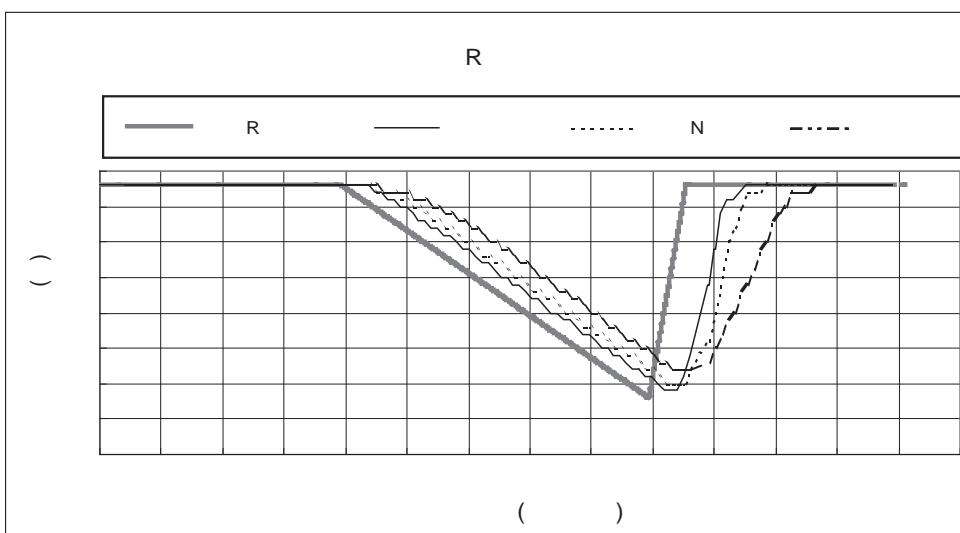
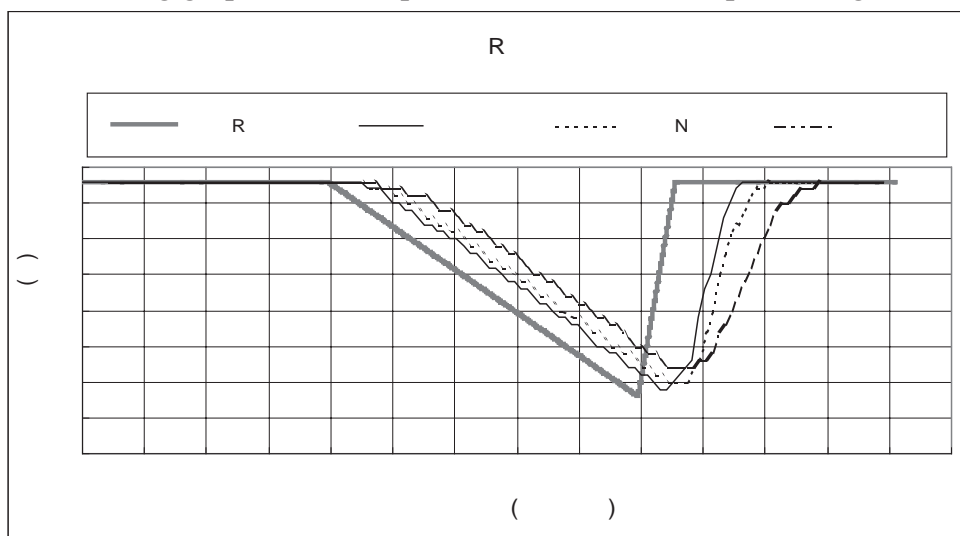

The following graph shows the response time example when pulse rate changes 10 bpm/s.

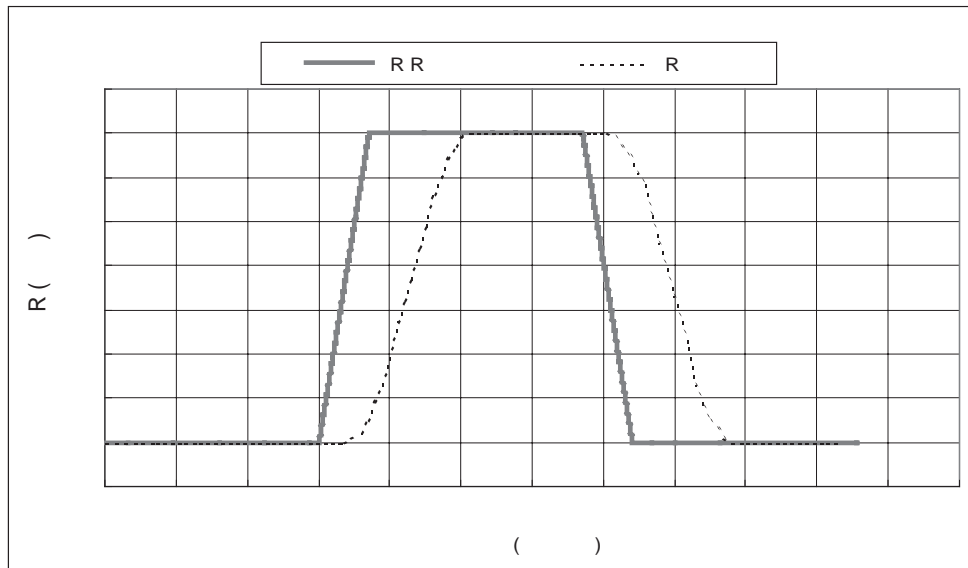

### Noninvasive Blood Pressure, NIBP (IEC 60601-2-30: 1999 compliant)

Measuring method:	Oscillometric
Measurement mode:	Manual, STAT ( $\leq 15$ min), Periodic
Intended patient type:	Adult, child
Measuring range:	0 to 300 mmHg
Pressure display range:	0 to 300 mmHg
Measuring accuracy <sup>1</sup> :	$\pm 3$ mmHg ( $0 \text{ mmHg} \leq \text{NIBP} \leq 300 \text{ mmHg}$ )
	AAMI SP-10: 2002 compliant
Cuff inflation time:	$\leq 20$ s (700 cc), 0 to 200 mmHg $\leq 15$ s (70 cc), 0 to 200 mmHg
Pressure retention:	$\leq 5$ mmHg (250 cc at 250 mmHg inflation for 10 seconds)
Air leakage:	$\leq 3$ mmHg/min (700 cc at 300 mmHg inflation)
Power discontinuity:	Deflate immediately after power down
Safety:	Maximum pressurization value cuff inflation limiter: 300 to 330 mmHg
	Cuff inflation time limiter: $\leq 180$ s
	Interval time limiter: $\leq 30$ s

<sup>1</sup> Essential performance of this transmitter

### Transmitter

FCC regulation:	FCC part 95 Subpart H Wireless Medical Telemetry Service (WMTS)
Field strength limits:	$< 740$ mV/m (at 3 m)
Undesired emissions:	
FCC part 95 95.2379 (a), (b):	below 960 MHz: $< 200$ $\mu\text{V/m}$ (at 3 m) above 960 MHz: $< 500$ $\mu\text{V/m}$ (at 3 m)
Antenna:	Internal
Transmission channel:	Indicated on the transmitter
Transmission frequency range:	1395.0250 to 1399.9750 MHz 1427.0250 to 1431.9750 MHz
Channel spacing:	50 kHz or 37.5 kHz (12.5 kHz when interleaved)



Modulation:	FSK (frequency shift keying)
Type of emission:	F1D
Occupied bandwidth:	< 20 kHz
Effective radiated power:	5.0 mW
	Can be changed to 1.0 mW if required

## Power Requirements

Rated voltage:	3.6 V
Operating voltage:	3.2 to 4.8 V
Battery type:	Three AA (R6) type NiMH secondary batteries Three AA (R6) type alkaline dry cell primary batteries
Battery lifetime (with alkaline batteries, at room temperature):	approximately 1 day (measuring ECG, respiration, SpO <sub>2</sub> of approximately 60 kg weight adult male patient at the index finger, NIBP at 60 minute intervals)

## Dimensions and Weight

Dimensions:	114 W × 125 H × 63 D (mm)
Weight:	about 340 g (excluding batteries and other accessories) about 410 g (including batteries, excluding other accessories)

## Environment

### Operating environment

Temperature:	5 to 40°C (41 to 104°F)
Humidity:	30 to 85% (noncondensing)
Atmospheric pressure:	700 to 1060 hPa

### Storage and transport environment

Temperature:	-20 to +65°C (-4 to +149°F)
Humidity:	10 to 95%
Atmospheric pressure:	700 to 1060 hPa

## Safety Standards

Safety standard:	CAN/CSA-C22.2 No. 601-1 M90 CAN/CSA-C22.2 No. 601-1. 1S1-94 CAN/CSA-C22.2 No. 601-1. 1B-90 CAN/CSA-C22.2 No. 60601-2-49-04 CAN/CSA-C22.2 No. 60601-2-27-06 CAN/CSA-C22.2 No. 60601-2-30-02 IEC 60601-1:1988 IEC 60601-1 Amendment 1: 1991 IEC 60601-1 Amendment 2: 1995 IEC 60601-2-27: 2005 IEC 60601-2-30: 1999 IEC 60601-2-49: 2001
------------------	---

ISO 9919: 2005

UL 60601-1: 2003

Type of protection against electrical shock:

INTERNALLY POWERED EQUIPMENT

Degree of protection against electrical shock:

ECG and impedance method respiration:

DEFIBRILLATION-PROOF TYPE CF APPLIED  
PARTSpO<sub>2</sub> and NIBP:DEFIBRILLATION-PROOF TYPE BF APPLIED  
PART

Degree of protection against harmful ingress of water:

IPX0 (non-protected)

Degree of safety of application in the presence of a FLAMMABLE ANAESTHETIC  
MIXTURE WITH AIR, OR WITH OXYGEN OR NITROUS OXIDE:Equipment not suitable for use in the presence of  
FLAMMABLE ANAESTHETIC MIXTURE WITH  
AIR, OR WITH OXYGEN OR NITROUS OXIDE

Mode of operation:

CONTINUOUS OPERATION

## Electromagnetic Compatibility

IEC 60601-1-2: 2001

IEC 60601-1-2 Amendment 1: 2004

## Electromagnetic Emissions

This ZM-541PA is intended for use in the electromagnetic environment specified below.

The customer or the user of the ZM-541PA should assure that it is used in such an environment.

<b>Emissions test</b>	<b>Compliance</b>	<b>Electromagnetic environment - guidance</b>
RF emissions CISPR 11	Group 1	The ZM-541PA uses RF energy only for its internal function. Therefore, its RF emissions are very low and are not likely to cause any interference in nearby electronic equipment.
RF emissions CISPR 11	Class B	The ZM-541PA is suitable for use in all establishments, including domestic establishments.
Harmonic emissions IEC 61000-3-2	Not applicable	
Voltage fluctuations/ flicker emissions IEC 61000-3-3	Not applicable	

## Electromagnetic Immunity

This ZM-541PA is intended for use in the electromagnetic environment specified below.

The customer or the user of the ZM-541PA should assure that it is used in such an environment.

Immunity test	IEC 60601 test level	Compliance level	Electromagnetic environment - guidance
Electrostatic discharge (ESD) IEC 61000-4-2	±6 kV contact ±8 kV air	±6 kV contact ±8 kV air	Floors should be wood, concrete or ceramic tile. If floors are covered with synthetic material, the relative humidity should be at least 30%.
Electrical fast transient/ burst IEC 61000-4-4	±2 kV for power supply lines ±1 kV for input/output lines	Not applicable	—
Surge IEC 61000-4-5	±1 kV differential mode ±2 kV common mode	Not applicable	—
Voltage dips, short interruptions and voltage variations on power supply input lines IEC 61000-4-11	<5% $U_T$ (>95% dip in $U_T$ ) for 0.5 cycles 40% $U_T$ (60% dip in $U_T$ ) for 5 cycles 70% $U_T$ (30% dip in $U_T$ ) for 25 cycles <5% $U_T$ (>95% dip in $U_T$ ) for 5 s	Not applicable	—
Power frequency (50/60 Hz) magnetic field IEC 61000-4-8	3 A/m	3 A/m	Power frequency magnetic fields should be at levels characteristic of a typical location in a typical commercial or hospital environment.
NOTE: $U_T$ is the AC mains voltage prior to application of the test level.			

### Avoiding Electromagnetic Interference (Impedance Respiration)

Impedance respiration measurement is very sensitive and affected by electromagnetic interference. Technological limitations do not allow immunity levels higher than 1 V/m for radiated RF electromagnetic fields. Electromagnetic fields with field strengths above 1 V/m may cause measurement error. Do not use electrically radiating equipment near the impedance respiration measurements.

Immunity test	IEC 60601 test level	Compliance level	Electromagnetic environment - guidance
<p>Conducted RF IEC 61000-4-6</p> <p>Radiated RF IEC 61000-4-3</p>	<p>3 Vrms 150 kHz to 80 MHz</p> <p>3 V/m 80 MHz to 2.5 GHz</p>	<p>3 Vrms</p> <p>3 V/m 80 MHz to 2.5 GHz</p> <p>(1 V/m 80 MHz to 2.5 GHz for respiration)</p>	<p>Portable and mobile RF communications equipment should be used no closer to any part of the ZM-541PA, including cables, than the recommended separation distance calculated from the equation applicable to the frequency of the transmitter.</p> <p><b>Recommended separation distance</b></p> <p><math>d = 1.2\sqrt{P}</math></p> <p><math>d = 1.2\sqrt{P}</math> 80 MHz to 800 MHz  <math>d = 2.3\sqrt{P}</math> 800 MHz to 2.5 GHz</p> <p>(<math>d = 3.5\sqrt{P}</math> 80 MHz to 800 MHz for respiration  <math>d = 7.0\sqrt{P}</math> 800 MHz to 2.5 GHz for respiration)</p> <p>where P is the maximum output power rating of the transmitter in watts (W) according to the transmitter manufacturer and d is the recommended separation distance in meters (m).</p> <p>Field strengths from fixed RF transmitters, as determined by an electromagnetic site survey<sup>1</sup>, should be less than the compliance level in each frequency range<sup>2</sup>.</p> <p>Interference may occur in the vicinity of equipment marked with the following symbol:</p> 

NOTE 1: At 80 MHz and 800 MHz, the higher frequency range applies.

NOTE 2: These guidelines may not apply in all situations. Electromagnetic propagation is affected by absorption and reflection from structures, objects and people.

<sup>1</sup> Field strengths from fixed transmitters, such as base stations for radio (cellular/cordless) telephones and land mobile radios, amateur radio, AM and FM radio broadcast and TV broadcast cannot be predicted theoretically with accuracy. To assess the electromagnetic environment due to fixed RF transmitters, an electromagnetic site survey should be considered. If the measured field strength in the location in which the ZM-541PA is used exceeds the applicable RF compliance level above, the ZM-541PA should be observed to verify normal operation. If abnormal performance is observed, additional measures may be necessary, such as re-orienting or relocating the ZM-541PA.

<sup>2</sup> Over the frequency range 150 kHz to 80 MHz, field strengths should be less than 1 V/m for respiration and 3 V/m for all other functions.

## Recommended Separation Distances between Portable and Mobile RF Communications Equipment

The ZM-541PA is intended for use in an electromagnetic environment in which radiated RF disturbances are controlled. The customer or the user of the ZM-541PA can help prevent electromagnetic interference by maintaining a minimum distance between portable and mobile RF communications equipment (transmitters) and the ZM-541PA as recommended below, according to the maximum output power of the communications equipment.

Rated maximum output power of transmitter (W)	Separation distance according to frequency of transmitter (m)		
	150 kHz to 80 MHz $d = 1.2\sqrt{P}$	80 MHz to 800 MHz $d = 1.2\sqrt{P}$ (For respiration: $d = 3.5\sqrt{P}$ )	800 MHz to 2.5 GHz $d = 2.3\sqrt{P}$ (For respiration: $d = 7.0\sqrt{P}$ )
0.01	0.12	0.12 (0.35 <sup>1</sup> )	0.23 (0.7 <sup>1</sup> )
0.1	0.38	0.38 (1.1 <sup>1</sup> )	0.73 (2.2 <sup>1</sup> )
1	1.2	1.2 (3.5 <sup>1</sup> )	2.3 (7.0 <sup>1</sup> )
10	3.8	3.8 (11 <sup>1</sup> )	7.3 (22 <sup>1</sup> )
100	12	12 (35 <sup>1</sup> )	23 (70 <sup>1</sup> )

For transmitters rated at a maximum output power not listed above, the recommended separation distance  $d$  in meters (m) can be estimated using the equation applicable to the frequency of the transmitter, where  $P$  is the maximum output power rating of the transmitter in watts (W) according to the transmitter manufacturer.

(<sup>1</sup> For respiration)

NOTE 1: At 80 MHz and 800 MHz, the separation distance for the higher frequency range applies.

NOTE 2: These guidelines may not apply in all situations. Electromagnetic propagation is affected by absorption and reflection from structures, objects and people.

## Recovery Time after Defibrillation

The transmitter returns to the normal operating mode within 10 seconds after defibrillation. The stored settings are not affected.

## System Composition for EMC Test

The ZM-541PA transmitter is tested to comply with IEC 60601-1-2:2001 and Amendment 1:2004 with the following composition. If any part which is not specified by Nihon Kohden is used, the EMC specifications might not comply.

Units	Cable Length
ZM-541PA transmitter	—
YP-503P NIBP cuff	0.15 m
BR-906P ECG electrode lead	0.8 m
TL-201T finger probe	1.6 m

## Replaceable Part

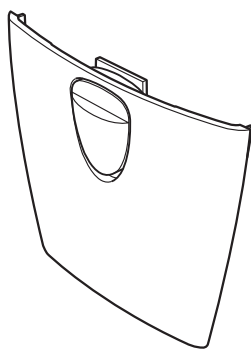

Name	Code No.	Qty
Battery case cover	6143-903101	1

## Options

**⚠ CAUTION**

Only use Nihon Kohden specified electrodes, electrode leads, SpO<sub>2</sub> probes, and NIBP cuffs. Otherwise, the maximum performance from the transmitter cannot be guaranteed.

---

## Transmitter

- QI-901PK channel writer

## ECG/RESP

Name	Type	Length (m)	Model	Qty	Supply Code
Electrode lead	3 electrodes, AHA, clip type	0.8	BR-903PA	1	K911A
	3 electrodes, AHA, snap type	0.8	BR-913PA	1	K910B
	3 electrodes, AHA, clip type	0.8	BR-933PA	1	K903B
	3 electrodes, AHA, hook type	0.8	BR-943PA	1	K904B
	6 electrodes, AHA, clip type	0.8	BR-936PA	1	K903D
	6 electrodes, AHA, hook type	0.8	BR-946PA	1	K904D

## SpO<sub>2</sub>

Name	Lead Length (m)	Model	Qty	Supply Code	
Finger probe (reusable)	0.6	TL-201T	1	P225H	
	1.6			P225F	
Multi-site probe (reusable)	1.6	TL-220T		P225G	
Finger probe (reusable)	0.6	TL-631T1		P311A	
	1.6	TL-631T3		P311C	
SpO <sub>2</sub> probe (for adult, disposable)	0.8	TL-271T		24	P203A
	1.6	TL-271T3	P203E		
SpO <sub>2</sub> probe (for child, disposable)	0.8	TL-272T	P203B		
	1.6	TL-272T3	P203F		
SpO <sub>2</sub> probe (for neonate/adult, disposable)	0.8	TL-273T	P203C		
	1.6	TL-273T3	P203G		
SpO <sub>2</sub> probe (for infant, disposable)	0.8	TL-274T	P203D		
	1.6	TL-274T3	P203H		
SpO <sub>2</sub> probe (for neonate/adult, disposable)	0.8	TL-051S	5		P228A
	1.6	TL-052S			P228B
SpO <sub>2</sub> probe (for child/infant, disposable)	0.8	TL-061S			P229A
	1.6	TL-062S			P229B
TL-05X TL-06X foam tape	—	—	4 × 25	P260, P260D <sup>1</sup>	
BLUPRO attachment tape	—	—	3 × 30	P263, P263A <sup>1</sup>	
Probe fastener	—	YS-093P2	30	P267	

<sup>1</sup> There is more than one supply code. The supply code to be used depends on the country where the probe is used. Contact your Nihon Kohden representative for further details.

## NIBP

Name		Width (cm)	Length (m)	Qty	Model	Supply Code
Extension hose		—	1.5	1	YN-990P	S903
<b>Reusable cuff</b>						
NIBP cuff, infant, YAWARA CUFF2		5	0.15	1	YP-710T	S951A
NIBP cuff, child, YAWARA CUFF2		7	0.15	1	YP-711T	S951B
NIBP cuff, adult, small, YAWARA CUFF2	Small	10	0.15	1	YP-712T	S951C
NIBP cuff, adult, small, YAWARA CUFF2	Standard	13	0.15	1	YP-713T	S951D
NIBP cuff, adult, small, YAWARA CUFF2	Large	16	0.15	1	YP-714T	S951E
<b>Disposable cuff</b>						
Disposable cuff, infant		6	0.17	20	YP-810P	S945C
Disposable cuff, child		8	0.17	20	YP-811P	S945D
Disposable cuff, adult	Small	10	0.17	20	YP-812P	S946E
	Standard	14	0.17	20	YP-813P	S946F
	Medium large	15	0.17	20	YP-814P	S946G
	Large	17	0.17	20	YP-815P	S946H
	Extra large	18	0.17	20	YP-816P	S946I



# Transmission Frequencies

Channel: 9002 to 9478

Channel (HEX)	Frequency (MHz)	Channel (HEX)	Frequency (MHz)	Channel (HEX)	Frequency (MHz)
9002	608.0250	9040	608.5000	9078	608.9750
9003	608.0375	9041	608.5125	9079	608.9875
9004	608.0500	9042	608.5250	9080	609.0000
9005	608.0625	9043	608.5375	9081	609.0125
9006	608.0750	9044	608.5500	9082	609.0250
9007	608.0875	9045	608.5625	9083	609.0375
9008	608.1000	9046	608.5750	9084	609.0500
9009	608.1125	9047	608.5875	9085	609.0625
9010	608.1250	9048	608.6000	9086	609.0750
9011	608.1375	9049	608.6125	9087	609.0875
9012	608.1500	9050	608.6250	9088	609.1000
9013	608.1625	9051	608.6375	9089	609.1125
9014	608.1750	9052	608.6500	9090	609.1250
9015	608.1875	9053	608.6625	9091	609.1375
9016	608.2000	9054	608.6750	9092	609.1500
9017	608.2125	9055	608.6875	9093	609.1625
9018	608.2250	9056	608.7000	9094	609.1750
9019	608.2375	9057	608.7125	9095	609.1875
9020	608.2500	9058	608.7250	9096	609.2000
9021	608.2625	9059	608.7375	9097	609.2125
9022	608.2750	9060	608.7500	9098	609.2250
9023	608.2875	9061	608.7625	9099	609.2375
9024	608.3000	9062	608.7750	9100	609.2500
9025	608.3125	9063	608.7875	9101	609.2625
9026	608.3250	9064	608.8000	9102	609.2750
9027	608.3375	9065	608.8125	9103	609.2875
9028	608.3500	9066	608.8250	9104	609.3000
9029	608.3625	9067	608.8375	9105	609.3125
9030	608.3750	9068	608.8500	9106	609.3250
9031	608.3875	9069	608.8625	9107	609.3375
9032	608.4000	9070	608.8750	9108	609.3500
9033	608.4125	9071	608.8875	9109	609.3625
9034	608.4250	9072	608.9000	9110	609.3750
9035	608.4375	9073	608.9125	9111	609.3875
9036	608.4500	9074	608.9250	9112	609.4000
9037	608.4625	9075	608.9375	9113	609.4125
9038	608.4750	9076	608.9500	9114	609.4250
9039	608.4875	9077	608.9625	9115	609.4375

Channel (HEX)	Frequency (MHz)	Channel (HEX)	Frequency (MHz)	Channel (HEX)	Frequency (MHz)
9116	609.4500	9159	609.9875	9202	610.5250
9117	609.4625	9160	610.0000	9203	610.5375
9118	609.4750	9161	610.0125	9204	610.5500
9119	609.4875	9162	610.0250	9205	610.5625
9120	609.5000	9163	610.0375	9206	610.5750
9121	609.5125	9164	610.0500	9207	610.5875
9122	609.5250	9165	610.0625	9208	610.6000
9123	609.5375	9166	610.0750	9209	610.6125
9124	609.5500	9167	610.0875	9210	610.6250
9125	609.5625	9168	610.1000	9211	610.6375
9126	609.5750	9169	610.1125	9212	610.6500
9127	609.5875	9170	610.1250	9213	610.6625
9128	609.6000	9171	610.1375	9214	610.6750
9129	609.6125	9172	610.1500	9215	610.6875
9130	609.6250	9173	610.1625	9216	610.7000
9131	609.6375	9174	610.1750	9217	610.7125
9132	609.6500	9175	610.1875	9218	610.7250
9133	609.6625	9176	610.2000	9219	610.7375
9134	609.6750	9177	610.2125	9220	610.7500
9135	609.6875	9178	610.2250	9221	610.7625
9136	609.7000	9179	610.2375	9222	610.7750
9137	609.7125	9180	610.2500	9223	610.7875
9138	609.7250	9181	610.2625	9224	610.8000
9139	609.7375	9182	610.2750	9225	610.8125
9140	609.7500	9183	610.2875	9226	610.8250
9141	609.7625	9184	610.3000	9227	610.8375
9142	609.7750	9185	610.3125	9228	610.8500
9143	609.7875	9186	610.3250	9229	610.8625
9144	609.8000	9187	610.3375	9230	610.8750
9145	609.8125	9188	610.3500	9231	610.8875
9146	609.8250	9189	610.3625	9232	610.9000
9147	609.8375	9190	610.3750	9233	610.9125
9148	609.8500	9191	610.3875	9234	610.9250
9149	609.8625	9192	610.4000	9235	610.9375
9150	609.8750	9193	610.4125	9236	610.9500
9151	609.8875	9194	610.4250	9237	610.9625
9152	609.9000	9195	610.4375	9238	610.9750
9153	609.9125	9196	610.4500	9239	610.9875
9154	609.9250	9197	610.4625	9240	611.0000
9155	609.9375	9198	610.4750	9241	611.0125
9156	609.9500	9199	610.4875	9242	611.0250
9157	609.9625	9200	610.5000	9243	611.0375
9158	609.9750	9201	610.5125	9244	611.0500

Channel (HEX)	Frequency (MHz)	Channel (HEX)	Frequency (MHz)	Channel (HEX)	Frequency (MHz)
9245	611.0625	9288	611.6000	9331	612.1375
9246	611.0750	9289	611.6125	9332	612.1500
9247	611.0875	9290	611.6250	9333	612.1625
9248	611.1000	9291	611.6375	9334	612.1750
9249	611.1125	9292	611.6500	9335	612.1875
9250	611.1250	9293	611.6625	9336	612.2000
9251	611.1375	9294	611.6750	9337	612.2125
9252	611.1500	9295	611.6875	9338	612.2250
9253	611.1625	9296	611.7000	9339	612.2375
9254	611.1750	9297	611.7125	9340	612.2500
9255	611.1875	9298	611.7250	9341	612.2625
9256	611.2000	9299	611.7375	9342	612.2750
9257	611.2125	9300	611.7500	9343	612.2875
9258	611.2250	9301	611.7625	9344	612.3000
9259	611.2375	9302	611.7750	9345	612.3125
9260	611.2500	9303	611.7875	9346	612.3250
9261	611.2625	9304	611.8000	9347	612.3375
9262	611.2750	9305	611.8125	9348	612.3500
9263	611.2875	9306	611.8250	9349	612.3625
9264	611.3000	9307	611.8375	9350	612.3750
9265	611.3125	9308	611.8500	9351	612.3875
9266	611.3250	9309	611.8625	9352	612.4000
9267	611.3375	9310	611.8750	9353	612.4125
9268	611.3500	9311	611.8875	9354	612.4250
9269	611.3625	9312	611.9000	9355	612.4375
9270	611.3750	9313	611.9125	9356	612.4500
9271	611.3875	9314	611.9250	9357	612.4625
9272	611.4000	9315	611.9375	9358	612.4750
9273	611.4125	9316	611.9500	9359	612.4875
9274	611.4250	9317	611.9625	9360	612.5000
9275	611.4375	9318	611.9750	9361	612.5125
9276	611.4500	9319	611.9875	9362	612.5250
9277	611.4625	9320	612.0000	9363	612.5375
9278	611.4750	9321	612.0125	9364	612.5500
9279	611.4875	9322	612.0250	9365	612.5625
9280	611.5000	9323	612.0375	9366	612.5750
9281	611.5125	9324	612.0500	9367	612.5875
9282	611.5250	9325	612.0625	9368	612.6000
9283	611.5375	9326	612.0750	9369	612.6125
9284	611.5500	9327	612.0875	9370	612.6250
9285	611.5625	9328	612.1000	9371	612.6375
9286	611.5750	9329	612.1125	9372	612.6500
9287	611.5875	9330	612.1250	9373	612.6625

Channel (HEX)	Frequency (MHz)	Channel (HEX)	Frequency (MHz)	Channel (HEX)	Frequency (MHz)
9374	612.6750	9417	613.2125	9460	613.7500
9375	612.6875	9418	613.2250	9461	613.7625
9376	612.7000	9419	613.2375	9462	613.7750
9377	612.7125	9420	613.2500	9463	613.7875
9378	612.7250	9421	613.2625	9464	613.8000
9379	612.7375	9422	613.2750	9465	613.8125
9380	612.7500	9423	613.2875	9466	613.8250
9381	612.7625	9424	613.3000	9467	613.8375
9382	612.7750	9425	613.3125	9468	613.8500
9383	612.7875	9426	613.3250	9469	613.8625
9384	612.8000	9427	613.3375	9470	613.8750
9385	612.8125	9428	613.3500	9471	613.8875
9386	612.8250	9429	613.3625	9472	613.9000
9387	612.8375	9430	613.3750	9473	613.9125
9388	612.8500	9431	613.3875	9474	613.9250
9389	612.8625	9432	613.4000	9475	613.9375
9390	612.8750	9433	613.4125	9476	613.9500
9391	612.8875	9434	613.4250	9477	613.9625
9392	612.9000	9435	613.4375	9478	613.9750
9393	612.9125	9436	613.4500		
9394	612.9250	9437	613.4625		
9395	612.9375	9438	613.4750		
9396	612.9500	9439	613.4875		
9397	612.9625	9440	613.5000		
9398	612.9750	9441	613.5125		
9399	612.9875	9442	613.5250		
9400	613.0000	9443	613.5375		
9401	613.0125	9444	613.5500		
9402	613.0250	9445	613.5625		
9403	613.0375	9446	613.5750		
9404	613.0500	9447	613.5875		
9405	613.0625	9448	613.6000		
9406	613.0750	9449	613.6125		
9407	613.0875	9450	613.6250		
9408	613.1000	9451	613.6375		
9409	613.1125	9452	613.6500		
9410	613.1250	9453	613.6625		
9411	613.1375	9454	613.6750		
9412	613.1500	9455	613.6875		
9413	613.1625	9456	613.7000		
9414	613.1750	9457	613.7125		
9415	613.1875	9458	613.7250		
9416	613.2000	9459	613.7375		

Channel: E002 to E398

Channel (HEX)	Frequency (MHz)	Channel (HEX)	Frequency (MHz)	Channel (HEX)	Frequency (MHz)
E002	1395.0250	E040	1395.5000	E078	1395.9750
E003	1395.0375	E041	1395.5125	E079	1395.9875
E004	1395.0500	E042	1395.5250	E080	1396.0000
E005	1395.0625	E043	1395.5375	E081	1396.0125
E006	1395.0750	E044	1395.5500	E082	1396.0250
E007	1395.0875	E045	1395.5625	E083	1396.0375
E008	1395.1000	E046	1395.5750	E084	1396.0500
E009	1395.1125	E047	1395.5875	E085	1396.0625
E010	1395.1250	E048	1395.6000	E086	1396.0750
E011	1395.1375	E049	1395.6125	E087	1396.0875
E012	1395.1500	E050	1395.6250	E088	1396.1000
E013	1395.1625	E051	1395.6375	E089	1396.1125
E014	1395.1750	E052	1395.6500	E090	1396.1250
E015	1395.1875	E053	1395.6625	E091	1396.1375
E016	1395.2000	E054	1395.6750	E092	1396.1500
E017	1395.2125	E055	1395.6875	E093	1396.1625
E018	1395.2250	E056	1395.7000	E094	1396.1750
E019	1395.2375	E057	1395.7125	E095	1396.1875
E020	1395.2500	E058	1395.7250	E096	1396.2000
E021	1395.2625	E059	1395.7375	E097	1396.2125
E022	1395.2750	E060	1395.7500	E098	1396.2250
E023	1395.2875	E061	1395.7625	E099	1396.2375
E024	1395.3000	E062	1395.7750	E100	1396.2500
E025	1395.3125	E063	1395.7875	E101	1396.2625
E026	1395.3250	E064	1395.8000	E102	1396.2750
E027	1395.3375	E065	1395.8125	E103	1396.2875
E028	1395.3500	E066	1395.8250	E104	1396.3000
E029	1395.3625	E067	1395.8375	E105	1396.3125
E030	1395.3750	E068	1395.8500	E106	1396.3250
E031	1395.3875	E069	1395.8625	E107	1396.3375
E032	1395.4000	E070	1395.8750	E108	1396.3500
E033	1395.4125	E071	1395.8875	E109	1396.3625
E034	1395.4250	E072	1395.9000	E110	1396.3750
E035	1395.4375	E073	1395.9125	E111	1396.3875
E036	1395.4500	E074	1395.9250	E112	1396.4000
E037	1395.4625	E075	1395.9375	E113	1396.4125
E038	1395.4750	E076	1395.9500	E114	1396.4250
E039	1395.4875	E077	1395.9625	E115	1396.4375

Channel (HEX)	Frequency (MHz)	Channel (HEX)	Frequency (MHz)	Channel (HEX)	Frequency (MHz)
E116	1396.4500	E155	1396.9375	E194	1397.4250
E117	1396.4625	E156	1396.9500	E195	1397.4375
E118	1396.4750	E157	1396.9625	E196	1397.4500
E119	1396.4875	E158	1396.9750	E197	1397.4625
E120	1396.5000	E159	1396.9875	E198	1397.4750
E121	1396.5125	E160	1397.0000	E199	1397.4875
E122	1396.5250	E161	1397.0125	E200	1397.5000
E123	1396.5375	E162	1397.0250	E201	1397.5125
E124	1396.5500	E163	1397.0375	E202	1397.5250
E125	1396.5625	E164	1397.0500	E203	1397.5375
E126	1396.5750	E165	1397.0625	E204	1397.5500
E127	1396.5875	E166	1397.0750	E205	1397.5625
E128	1396.6000	E167	1397.0875	E206	1397.5750
E129	1396.6125	E168	1397.1000	E207	1397.5875
E130	1396.6250	E169	1397.1125	E208	1397.6000
E131	1396.6375	E170	1397.1250	E209	1397.6125
E132	1396.6500	E171	1397.1375	E210	1397.6250
E133	1396.6625	E172	1397.1500	E211	1397.6375
E134	1396.6750	E173	1397.1625	E212	1397.6500
E135	1396.6875	E174	1397.1750	E213	1397.6625
E136	1396.7000	E175	1397.1875	E214	1397.6750
E137	1396.7125	E176	1397.2000	E215	1397.6875
E138	1396.7250	E177	1397.2125	E216	1397.7000
E139	1396.7375	E178	1397.2250	E217	1397.7125
E140	1396.7500	E179	1397.2375	E218	1397.7250
E141	1396.7625	E180	1397.2500	E219	1397.7375
E142	1396.7750	E181	1397.2625	E220	1397.7500
E143	1396.7875	E182	1397.2750	E221	1397.7625
E144	1396.8000	E183	1397.2875	E222	1397.7750
E145	1396.8125	E184	1397.3000	E223	1397.7875
E146	1396.8250	E185	1397.3125	E224	1397.8000
E147	1396.8375	E186	1397.3250	E225	1397.8125
E148	1396.8500	E187	1397.3375	E226	1397.8250
E149	1396.8625	E188	1397.3500	E227	1397.8375
E150	1396.8750	E189	1397.3625	E228	1397.8500
E151	1396.8875	E190	1397.3750	E229	1397.8625
E152	1396.9000	E191	1397.3875	E230	1397.8750
E153	1396.9125	E192	1397.4000	E231	1397.8875
E154	1396.9250	E193	1397.4125	E232	1397.9000

Channel (HEX)	Frequency (MHz)	Channel (HEX)	Frequency (MHz)	Channel (HEX)	Frequency (MHz)
E233	1397.9125	E272	1398.4000	E311	1398.8875
E234	1397.9250	E273	1398.4125	E312	1398.9000
E235	1397.9375	E274	1398.4250	E313	1398.9125
E236	1397.9500	E275	1398.4375	E314	1398.9250
E237	1397.9625	E276	1398.4500	E315	1398.9375
E238	1397.9750	E277	1398.4625	E316	1398.9500
E239	1397.9875	E278	1398.4750	E317	1398.9625
E240	1398.0000	E279	1398.4875	E318	1398.9750
E241	1398.0125	E280	1398.5000	E319	1398.9875
E242	1398.0250	E281	1398.5125	E320	1399.0000
E243	1398.0375	E282	1398.5250	E321	1399.0125
E244	1398.0500	E283	1398.5375	E322	1399.0250
E245	1398.0625	E284	1398.5500	E323	1399.0375
E246	1398.0750	E285	1398.5625	E324	1399.0500
E247	1398.0875	E286	1398.5750	E325	1399.0625
E248	1398.1000	E287	1398.5875	E326	1399.0750
E249	1398.1125	E288	1398.6000	E327	1399.0875
E250	1398.1250	E289	1398.6125	E328	1399.1000
E251	1398.1375	E290	1398.6250	E329	1399.1125
E252	1398.1500	E291	1398.6375	E330	1399.1250
E253	1398.1625	E292	1398.6500	E331	1399.1375
E254	1398.1750	E293	1398.6625	E332	1399.1500
E255	1398.1875	E294	1398.6750	E333	1399.1625
E256	1398.2000	E295	1398.6875	E334	1399.1750
E257	1398.2125	E296	1398.7000	E335	1399.1875
E258	1398.2250	E297	1398.7125	E336	1399.2000
E259	1398.2375	E298	1398.7250	E337	1399.2125
E260	1398.2500	E299	1398.7375	E338	1399.2250
E261	1398.2625	E300	1398.7500	E339	1399.2375
E262	1398.2750	E301	1398.7625	E340	1399.2500
E263	1398.2875	E302	1398.7750	E341	1399.2625
E264	1398.3000	E303	1398.7875	E342	1399.2750
E265	1398.3125	E304	1398.8000	E343	1399.2875
E266	1398.3250	E305	1398.8125	E344	1399.3000
E267	1398.3375	E306	1398.8250	E345	1399.3125
E268	1398.3500	E307	1398.8375	E346	1399.3250
E269	1398.3625	E308	1398.8500	E347	1399.3375
E270	1398.3750	E309	1398.8625	E348	1399.3500
E271	1398.3875	E310	1398.8750	E349	1399.3625

Channel (HEX)	Frequency (MHz)	Channel (HEX)	Frequency (MHz)
E350	1399.3750	E389	1399.8625
E351	1399.3875	E390	1399.8750
E352	1399.4000	E391	1399.8875
E353	1399.4125	E392	1399.9000
E354	1399.4250	E393	1399.9125
E355	1399.4375	E394	1399.9250
E356	1399.4500	E395	1399.9375
E357	1399.4625	E396	1399.9500
E358	1399.4750	E397	1399.9625
E359	1399.4875	E398	1399.9750
E360	1399.5000		
E361	1399.5125		
E362	1399.5250		
E363	1399.5375		
E364	1399.5500		
E365	1399.5625		
E366	1399.5750		
E367	1399.5875		
E368	1399.6000		
E369	1399.6125		
E370	1399.6250		
E371	1399.6375		
E372	1399.6500		
E373	1399.6625		
E374	1399.6750		
E375	1399.6875		
E376	1399.7000		
E377	1399.7125		
E378	1399.7250		
E379	1399.7375		
E380	1399.7500		
E381	1399.7625		
E382	1399.7750		
E383	1399.7875		
E384	1399.8000		
E385	1399.8125		
E386	1399.8250		
E387	1399.8375		
E388	1399.8500		



Channel: E502 to E898

Channel (HEX)	Frequency (MHz)	Channel (HEX)	Frequency (MHz)	Channel (HEX)	Frequency (MHz)
E502	1427.0250	E544	1427.5500	E586	1428.0750
E503	1427.0375	E545	1427.5625	E587	1428.0875
E504	1427.0500	E546	1427.5750	E588	1428.1000
E505	1427.0625	E547	1427.5875	E589	1428.1125
E506	1427.0750	E548	1427.6000	E590	1428.1250
E507	1427.0875	E549	1427.6125	E591	1428.1375
E508	1427.1000	E550	1427.6250	E592	1428.1500
E509	1427.1125	E551	1427.6375	E593	1428.1625
E510	1427.1250	E552	1427.6500	E594	1428.1750
E511	1427.1375	E553	1427.6625	E595	1428.1875
E512	1427.1500	E554	1427.6750	E596	1428.2000
E513	1427.1625	E555	1427.6875	E597	1428.2125
E514	1427.1750	E556	1427.7000	E598	1428.2250
E515	1427.1875	E557	1427.7125	E599	1428.2375
E516	1427.2000	E558	1427.7250	E600	1428.2500
E517	1427.2125	E559	1427.7375	E601	1428.2625
E518	1427.2250	E560	1427.7500	E602	1428.2750
E519	1427.2375	E561	1427.7625	E603	1428.2875
E520	1427.2500	E562	1427.7750	E604	1428.3000
E521	1427.2625	E563	1427.7875	E605	1428.3125
E522	1427.2750	E564	1427.8000	E606	1428.3250
E523	1427.2875	E565	1427.8125	E607	1428.3375
E524	1427.3000	E566	1427.8250	E608	1428.3500
E525	1427.3125	E567	1427.8375	E609	1428.3625
E526	1427.3250	E568	1427.8500	E610	1428.3750
E527	1427.3375	E569	1427.8625	E611	1428.3875
E528	1427.3500	E570	1427.8750	E612	1428.4000
E529	1427.3625	E571	1427.8875	E613	1428.4125
E530	1427.3750	E572	1427.9000	E614	1428.4250
E531	1427.3875	E573	1427.9125	E615	1428.4375
E532	1427.4000	E574	1427.9250	E616	1428.4500
E533	1427.4125	E575	1427.9375	E617	1428.4625
E534	1427.4250	E576	1427.9500	E618	1428.4750
E535	1427.4375	E577	1427.9625	E619	1428.4875
E536	1427.4500	E578	1427.9750	E620	1428.5000
E537	1427.4625	E579	1427.9875	E621	1428.5125
E538	1427.4750	E580	1428.0000	E622	1428.5250
E539	1427.4875	E581	1428.0125	E623	1428.5375
E540	1427.5000	E582	1428.0250	E624	1428.5500
E541	1427.5125	E583	1428.0375	E625	1428.5625
E542	1427.5250	E584	1428.0500	E626	1428.5750
E543	1427.5375	E585	1428.0625	E627	1428.5875

Channel (HEX)	Frequency (MHz)	Channel (HEX)	Frequency (MHz)	Channel (HEX)	Frequency (MHz)
E628	1428.6000	E671	1429.1375	E714	1429.6750
E629	1428.6125	E672	1429.1500	E715	1429.6875
E630	1428.6250	E673	1429.1625	E716	1429.7000
E631	1428.6375	E674	1429.1750	E717	1429.7125
E632	1428.6500	E675	1429.1875	E718	1429.7250
E633	1428.6625	E676	1429.2000	E719	1429.7375
E634	1428.6750	E677	1429.2125	E720	1429.7500
E635	1428.6875	E678	1429.2250	E721	1429.7625
E636	1428.7000	E679	1429.2375	E722	1429.7750
E637	1428.7125	E680	1429.2500	E723	1429.7875
E638	1428.7250	E681	1429.2625	E724	1429.8000
E639	1428.7375	E682	1429.2750	E725	1429.8125
E640	1428.7500	E683	1429.2875	E726	1429.8250
E641	1428.7625	E684	1429.3000	E727	1429.8375
E642	1428.7750	E685	1429.3125	E728	1429.8500
E643	1428.7875	E686	1429.3250	E729	1429.8625
E644	1428.8000	E687	1429.3375	E730	1429.8750
E645	1428.8125	E688	1429.3500	E731	1429.8875
E646	1428.8250	E689	1429.3625	E732	1429.9000
E647	1428.8375	E690	1429.3750	E733	1429.9125
E648	1428.8500	E691	1429.3875	E734	1429.9250
E649	1428.8625	E692	1429.4000	E735	1429.9375
E650	1428.8750	E693	1429.4125	E736	1429.9500
E651	1428.8875	E694	1429.4250	E737	1429.9625
E652	1428.9000	E695	1429.4375	E738	1429.9750
E653	1428.9125	E696	1429.4500	E739	1429.9875
E654	1428.9250	E697	1429.4625	E740	1430.0000
E655	1428.9375	E698	1429.4750	E741	1430.0125
E656	1428.9500	E699	1429.4875	E742	1430.0250
E657	1428.9625	E700	1429.5000	E743	1430.0375
E658	1428.9750	E701	1429.5125	E744	1430.0500
E659	1428.9875	E702	1429.5250	E745	1430.0625
E660	1429.0000	E703	1429.5375	E746	1430.0750
E661	1429.0125	E704	1429.5500	E747	1430.0875
E662	1429.0250	E705	1429.5625	E748	1430.1000
E663	1429.0375	E706	1429.5750	E749	1430.1125
E664	1429.0500	E707	1429.5875	E750	1430.1250
E665	1429.0625	E708	1429.6000	E751	1430.1375
E666	1429.0750	E709	1429.6125	E752	1430.1500
E667	1429.0875	E710	1429.6250	E753	1430.1625
E668	1429.1000	E711	1429.6375	E754	1430.1750
E669	1429.1125	E712	1429.6500	E755	1430.1875
E670	1429.1250	E713	1429.6625	E756	1430.2000

Channel (HEX)	Frequency (MHz)	Channel (HEX)	Frequency (MHz)	Channel (HEX)	Frequency (MHz)
E757	1430.2125	E800	1430.7500	E843	1431.2875
E758	1430.2250	E801	1430.7625	E844	1431.3000
E759	1430.2375	E802	1430.7750	E845	1431.3125
E760	1430.2500	E803	1430.7875	E846	1431.3250
E761	1430.2625	E804	1430.8000	E847	1431.3375
E762	1430.2750	E805	1430.8125	E848	1431.3500
E763	1430.2875	E806	1430.8250	E849	1431.3625
E764	1430.3000	E807	1430.8375	E850	1431.3750
E765	1430.3125	E808	1430.8500	E851	1431.3875
E766	1430.3250	E809	1430.8625	E852	1431.4000
E767	1430.3375	E810	1430.8750	E853	1431.4125
E768	1430.3500	E811	1430.8875	E854	1431.4250
E769	1430.3625	E812	1430.9000	E855	1431.4375
E770	1430.3750	E813	1430.9125	E856	1431.4500
E771	1430.3875	E814	1430.9250	E857	1431.4625
E772	1430.4000	E815	1430.9375	E858	1431.4750
E773	1430.4125	E816	1430.9500	E859	1431.4875
E774	1430.4250	E817	1430.9625	E860	1431.5000
E775	1430.4375	E818	1430.9750	E861	1431.5125
E776	1430.4500	E819	1430.9875	E862	1431.5250
E777	1430.4625	E820	1431.0000	E863	1431.5375
E778	1430.4750	E821	1431.0125	E864	1431.5500
E779	1430.4875	E822	1431.0250	E865	1431.5625
E780	1430.5000	E823	1431.0375	E866	1431.5750
E781	1430.5125	E824	1431.0500	E867	1431.5875
E782	1430.5250	E825	1431.0625	E868	1431.6000
E783	1430.5375	E826	1431.0750	E869	1431.6125
E784	1430.5500	E827	1431.0875	E870	1431.6250
E785	1430.5625	E828	1431.1000	E871	1431.6375
E786	1430.5750	E829	1431.1125	E872	1431.6500
E787	1430.5875	E830	1431.1250	E873	1431.6625
E788	1430.6000	E831	1431.1375	E874	1431.6750
E789	1430.6125	E832	1431.1500	E875	1431.6875
E790	1430.6250	E833	1431.1625	E876	1431.7000
E791	1430.6375	E834	1431.1750	E877	1431.7125
E792	1430.6500	E835	1431.1875	E878	1431.7250
E793	1430.6625	E836	1431.2000	E879	1431.7375
E794	1430.6750	E837	1431.2125	E880	1431.7500
E795	1430.6875	E838	1431.2250	E881	1431.7625
E796	1430.7000	E839	1431.2375	E882	1431.7750
E797	1430.7125	E840	1431.2500	E883	1431.7875
E798	1430.7250	E841	1431.2625	E884	1431.8000
E799	1430.7375	E842	1431.2750	E885	1431.8125

<b>Channel (HEX)</b>	<b>Frequency (MHz)</b>
E886	1431.8250
E887	1431.8375
E888	1431.8500
E889	1431.8625
E890	1431.8750
E891	1431.8875
E892	1431.9000
E893	1431.9125
E894	1431.9250
E895	1431.9375
E896	1431.9500
E897	1431.9625
E898	1431.9750

## Maintenance Check Sheet

Hospital/Organization: \_\_\_\_\_

Service Personnel: \_\_\_\_\_

Instrument Name: Transmitter

Instrument Model: ZM-540PA, ZM-541PA

Instrument Serial Number: \_\_\_\_\_

Hardware Revision Number: \_\_\_\_\_

Software Revision Number: \_\_\_\_\_

1. External Check	Pass	Fail
2. Transmitter Channel	Pass	Fail
3. Transmitting/Receiving Signal	Pass	Fail
4. Display	Pass	Fail
5. Key Operation	Pass	Fail
6. ECG Check	Pass	Fail
7. Respiration Check	Pass	Fail
8. SpO <sub>2</sub> Check	Pass	Fail
9. NIBP Check	Pass	Fail
10. NIBP Cuff for Attaching Transmitter to Patient Arm	Pass	Fail

### Overall Judgement

- OK
- Can be used but needs maintenance
- Maintenance required. Cannot be used.



**NIHON KOHDEN CORPORATION**  
 1-31-4 Nishiochiai, Shinjuku-ku Tokyo 161-8560, Japan  
 Phone +81 3-5996-8041

**NIHON KOHDEN ITALIA S.r.l.**  
 Via Fratelli Bronzetti 28, 24124 Bergamo, Italy  
 Phone +39 035-219543  
 Fax +39 035-232546

## North and South America

**NIHON KOHDEN AMERICA, INC.**  
 15353 Barranca Parkway, Irvine, CA 92618, U.S.A.  
 Toll-free +1-800-325-0283  
 Phone +1 949-580-1555  
 Fax +1 949-580-1550

UK Responsible Person  
**NIHON KOHDEN UK LTD.**  
 Unit 3, Heyworth Business Park,  
 Old Portsmouth Road, Peasmarsh,  
 Guildford, Surrey, GU3 1AF, UK  
 Phone +44 14-8333-1328

**NIHON KOHDEN MEXICO S.A. DE C.V.**  
 Insurgentes Sur 730, Piso 9 Oriente, Col. Del Valle  
 C.P. 03100, Delegacion Benito Juarez, Ciudad de Mexico  
 Phone +52 55-8851-5550  
 Fax +52 55-8851-5580

## Asia

**SHANGHAI KOHDEN  
 MEDICAL ELECTRONIC INSTRUMENT CORP.**  
 No. 567 Huancheng Bei Road  
 Shanghai Comprehensive Industrial Development Zone  
 Fengxian District, Shanghai 201401, China  
 Phone +86 21-5743-6998

**NIHON KOHDEN DO BRASIL LTDA.**  
 Rua Diadema, 89, 1º andar, conjuntos 11 a 17, bairro Mauá  
 no Município de São Caetano do Sul, Estado de São Paulo  
 CEP 09580-670, Brasil  
 Phone +55 11-3044-1700  
 Fax +55 11-3044-0463

**NIHON KOHDEN SINGAPORE PTE LTD**  
 1 Maritime Square, #10-34 HarbourFront Centre  
 Singapore 099253  
 Phone +65 6376-2210  
 Fax +65 6376-2264

## Europe

**EC REP** European Representative

**NIHON KOHDEN EUROPE GmbH**  
 Raiffeisenstrasse 10, 61191 Rosbach, Germany  
 Phone +49 6003-827-0  
 Fax +49 6003-827-599

**NIHON KOHDEN INDIA PVT. LTD.**  
 308, Tower A, Spazedge, Sector 47, Sohna Road  
 Gurgaon-122 002 Haryana, India  
 Toll-free +91 1800-103-8182  
 Phone +91 124-493-1000  
 Fax +91 124-493-1029

**NIHON KOHDEN DEUTSCHLAND GmbH**  
 Raiffeisenstrasse 10, 61191 Rosbach, Germany  
 Phone +49 6003-827-0  
 Fax +49 6003-827-599

**NIHON KOHDEN MIDDLE EAST FZE**  
 JAFZA One Tower A, 19th floor, Office No. 1912  
 P.O. Box 261516, Jebel Ali Free Zone, Dubai, U.A.E.  
 Phone +971 4-884-0080  
 Fax +971 4-880-0122

**NIHON KOHDEN FRANCE SARL**  
 Centre d’Affaires La Boursidière, Bât C – RDC,  
 92357 Le Plessis Robinson, France  
 Phone +33 1-49-08-05-50  
 Fax +33 1-49-08-93-32

**NIHON KOHDEN KOREA, INC.**  
 3F, Cheongok Bldg., 88, Dongmak-ro, Mapo-gu,  
 Seoul, 04075, Republic of Korea  
 Phone +82 2-3273-2310  
 Fax +82 2-3273-2352

**NIHON KOHDEN IBERICA S.L.**  
 Calle Toronga 23, Oficina 1 28043 Madrid, Spain  
 Phone +34 917-161-080  
 Fax +34 913-004-676

Contact information is accurate as of Sep 2022. Visit <https://www.nihonkohden.com/> for the latest information.

The model and serial number of your device are identified on the rear or bottom of the unit.  
 Write the model and serial number in the spaces provided below. Whenever you call your representative concerning this device,  
 mention these two pieces of information for quick and accurate service.

Model \_\_\_\_\_

Serial Number \_\_\_\_\_

Your Representative

Note for users in the territory of the EEA and Switzerland:  
 Any serious incident that has occurred in relation to the device should be reported to the European Representative designated by the  
 manufacturer and the Competent Authority of the Member State of the EEA and Switzerland in which the user and/or patient is established.

ZM-540PA, ZM-541PA\_0614-902754K



**NIHON KOHDEN CORPORATION**  
1-31-4 Nishiochiai, Shinjuku-ku, Tokyo 161-8560, Japan  
Phone +81 3-5996-8041  
<https://www.nihonkohden.com/>