



FCC CFR47 PART 95H REQUIREMENT

CERTIFICATION TEST REPORT

FOR

MEDICAL TELEMETRY TRANSMITTER

MODEL: ZM-531PA

FCC ID: B6BZM-531PA

REPORT NUMBER: 31KE0332-HO-A

ISSUE DATE: JULY 06, 2011

**Prepared for
NIHON KOHDEN CORPORATION
1-31-4, NISHIOCHIAI SHINJUKU-KU
TOKYO 161-8560, JAPAN**

**Prepared by
UL Japan, Inc.
Head Office EMC Lab.
4383-326 Asama-cho, Ise-shi, Mie-ken 516-0021 JAPAN
TEL: +81 596 24 8116
FAX: +81 596 24 8124**



NVLAP LAB CODE: 200572-0

This laboratory is accredited by the NVLAP LAB CODE 200572-0, U.S.A. The tests reported herein have been performed in accordance with its terms of accreditation. *As for the range of Accreditation in NVLAP, you may refer to the WEB address, <http://www.ul.com/japan/jpn/pages/services/emc/about/mark1/index.jsp#nvlap>

Revision History

<u>Rev.</u>	<u>Issue Date</u>	<u>Revisions</u>	<u>Revised By</u>
--	07/06/11	Initial Issue	T. Hatakeda

TABLE OF CONTENTS

1. ATTESTATION OF TEST RESULTS	4
2. TEST METHODOLOGY	5
3. FACILITIES AND ACCREDITATION	5
4. CALIBRATION AND UNCERTAINTY	5
4.1. <i>MEASURING INSTRUMENT CALIBRATION.....</i>	<i>5</i>
4.2. <i>SAMPLE CALCULATION.....</i>	<i>5</i>
4.3. <i>MEASUREMENT UNCERTAINTY</i>	<i>6</i>
5. EQUIPMENT UNDER TEST	7
5.1. <i>DESCRIPTION OF EUT.....</i>	<i>7</i>
5.2. <i>PLL SUBSTITUTION MODEL.....</i>	<i>7</i>
5.3. <i>DESCRIPTION OF AVAILABLE ANTENNAS.....</i>	<i>7</i>
5.4. <i>SOFTWARE AND FIRMWARE.....</i>	<i>7</i>
5.5. <i>WORST-CASE CONFIGURATION AND MODE</i>	<i>8</i>
5.6. <i>DESCRIPTION OF TEST SETUP</i>	<i>8</i>
6. TEST AND MEASUREMENT EQUIPMENT	11
7. ANTENNA PORT TEST RESULTS.....	13
7.1. <i>26 dB AND 99% BW</i>	<i>13</i>
7.2. <i>PEAK OUTPUT POWER.....</i>	<i>18</i>
7.3. <i>AVERAGE POWER</i>	<i>19</i>
7.4. <i>SPURIOUS EMISSIONS AT ANTENNA TERMINAL.....</i>	<i>20</i>
7.5. <i>FREQUENCY STABILITY MEASUREMENT.....</i>	<i>23</i>
8. RADIATED EMISSION TEST RESULTS.....	29
8.1. <i>FUNDAMENTAL OUTPUT POWER.....</i>	<i>30</i>
8.2. <i>RADIATED EMISSIONS BELOW 960 MHz.....</i>	<i>32</i>
8.3. <i>RADIATED EMISSIONS ABOVE 960 MHz.....</i>	<i>43</i>
9. SETUP PHOTOS.....	48

1. ATTESTATION OF TEST RESULTS

COMPANY NAME: NIHON KOHDEN CORPORATION
1-31-4, NISHIOCHIAI SHINJUKU-KU
TOKYO 161-8560, JAPAN

EUT DESCRIPTION: MEDICAL TELEMETRY TRANSMITTER

MODEL: ZM-531PA

SERIAL NUMBER: 93002

DATE TESTED: MAY 20 – JULY 02, 2011

APPLICABLE STANDARDS	
STANDARD	TEST RESULTS
FCC PART 95 SUBPART H	Pass

UL Japan, Inc. tested the above equipment in accordance with the requirements set forth in the above standards. All indications of Pass/Fail in this report are opinions expressed by UL Japan, Inc. based on interpretations and/or observations of test results. Measurement Uncertainties were not taken into account and are published for informational purposes only. The test results show that the equipment tested is capable of demonstrating compliance with the requirements as documented in this report.

Note: The results documented in this report apply only to the tested sample, under the conditions and modes of operation as described herein. This document may not be altered or revised in any way unless done so by UL Japan, Inc. and all revisions are duly noted in the revisions section. Any alteration of this document not carried out by UL Japan, Inc. will constitute fraud and shall nullify the document. This report must not be used by the client to claim product certification, approval, or endorsement by NVLAP, NIST, any agency of the Federal Government, or any agency of any government.

Approved & Released For UL Japan, Inc. By:

Tested By:



TAKAHIRO HATAKEDA
Leader of WiSE Japan
UL Verification Services
UL Japan, Inc.



KATSUNORI OKAI
Engineer of WiSE Japan
UL Verification Services
UL Japan, Inc.

2. TEST METHODOLOGY

The tests documented in this report were performed in accordance with ANSI/TIA-603-C-2004, FCC CFR 47 Part 2 and FCC CFR 47 Part 95.

3. FACILITIES AND ACCREDITATION

The test sites and measurement facilities used to collect data are located at 4383-326 Asama-cho, Ise-shi, Mie-ken 516-0021 JAPAN.

UL Japan, Inc. is accredited by NVLAP, Laboratory Code 200572-0
The full scope of accreditation can be viewed at
<http://www.ul.com/japan/jpn/pages/services/emc/about/mark1/index.jsp#nvlap>

4. CALIBRATION AND UNCERTAINTY

4.1. MEASURING INSTRUMENT CALIBRATION

The measuring equipment utilized to perform the tests documented in this report has been calibrated in accordance with the manufacturer's recommendations, and is traceable to recognized national standards.

4.2. SAMPLE CALCULATION

Where relevant, the following sample calculation is provided:

$$\begin{aligned} \text{Field Strength (dBuV/m)} &= \text{Measured Voltage (dBuV)} + \text{Antenna Factor (dB/m)} + \text{Cable} \\ &\text{Loss (dB)} - \text{Preamp Gain (dB)} \\ 36.5 \text{ dBuV} + 18.7 \text{ dB/m} + 0.6 \text{ dB} - 26.9 \text{ dB} &= 28.9 \text{ dBuV/m} \end{aligned}$$

4.3. MEASUREMENT UNCERTAINTY

Where relevant, the following measurement uncertainty levels have been estimated for tests performed on the apparatus:

The following uncertainties have been calculated to provide a confidence level of 95% using a coverage factor k=2.

Test room (semi-anechoic chamber)	Radiated emission						
	(3m*)(+dB)				(1m*)(+dB)		(0.5m*)(+dB)
	9kHz -30MHz	30MHz - 300MHz	300MHz -1GHz	1GHz -10GHz	10GHz -18GHz	18GHz -26.5GHz	26.5GHz -40GHz
No.1	3.5dB	5.1dB	5.2dB	4.8dB	5.1dB	4.4dB	4.3dB
No.2	4.0dB	5.1dB	5.2dB	4.8dB	5.0dB	4.3dB	4.2dB
No.3	4.2dB	4.7dB	5.2dB	4.8dB	5.0dB	4.5dB	4.2dB
No.4	4.0dB	5.0dB	5.1dB	4.8dB	5.0dB	5.1dB	4.2dB

*3m/1m/0.5m = Measurement distance

Power meter (+dB)	
Below 1GHz	Above 1GHz
1.0dB	1.0dB

Antenna terminal conducted emission and Power density (+dB)			Antenna terminal conducted emission (+dB)		Channel power (+dB)
Below 1GHz	1GHz-3GHz	3GHz-18GHz	18GHz-26.5GHz	26.5GHz-40GHz	
1.0dB	1.1dB	2.7dB	3.2dB	3.3dB	1.5dB

5. EQUIPMENT UNDER TEST

5.1. DESCRIPTION OF EUT

- | | | |
|-----|----------------------------|---|
| a). | Type of EUT: | WMTS TRANSMITTER |
| b). | Brand Name: | NIHON KOHDEN |
| c). | Model No: | ZM-531PA |
| d). | FCC ID: | B6BZM-531PA |
| e). | Battery Type: | Two AA (LR6) |
| f). | Channel Number: | 1395.0250 MHz (channel number E002) to
1399.9750 MHz (channel number E398), and
1427.0250 MHz (channel number E502) to 1431.9750 MHz
(channel number E898) |
| g). | Frequency Range: | 1395.025-1399.975 MHz and
1427.025-1431.975 MHz bands |
| h). | RF Conducted Output Power: | 5mW (factory default setting) or 1mW |
| i). | Channel Spacing: | 50 KHz or 37.5 kHz (12.5 KHz when interleave) |
| j). | Modulation | Frequency Shift Keying |
| k). | Type of Modulation: | F1D |
| l). | Occupied Bandwidth | <20 kHz |
| m). | Antenna Type: | Internal |

5.2. PLL SUBSTITUTION MODEL

PLL Substitution Model is available for ZM-531PA. The substituted PLL is pin for pin compatible, and the same basic function as the original PLL. There is no change in radio frequency, RF output power, radio frequency circuitry, Antenna, PCB and functional capabilities.

5.3. DESCRIPTION OF AVAILABLE ANTENNAS

The radio utilizes a Helical Monopole antenna, with a maximum gain of 0 dBi.

5.4. SOFTWARE AND FIRMWARE

The test utility software used during testing was Channel Writer, ver. 02-04.
The test utility firmware used during testing was EUT, ver. 01-01.

5.5. WORST-CASE CONFIGURATION AND MODE

The worst-case channel is determined as the channel with the highest output power.

During emission tests the antenna orientations as X, Y, and Z were investigated to determine the worst-case. The outcome showed that Z-orientation for Horizontal and Y-orientation for Vertical as the worst-case.

5.6. DESCRIPTION OF TEST SETUP

SUPPORT EQUIPMENT

PERIPHERAL SUPPORT EQUIPMENT LIST				
Description	Manufacturer	Model	Serial Number	FCC ID
Laptop	IBM	T42	L3NHT3F	DoC
AC/DC Adapter	IBM	92P1020	11S92P1020Z1Z9RM64CH86	DoC
Channel Writer	Nihon Kohden	QI-901PK	00349	N/A

[PLL Substitution model]

PERIPHERAL SUPPORT EQUIPMENT LIST				
Description	Manufacturer	Model	Serial Number	FCC ID
Laptop	Lenovo	7661-CB9	L3R2056	DoC
AC/DC Adaptor	Lenovo	92P1160	11S92P1160Z1ZBGH7B99A8	DoC
Channel Writer	Nihon Kohden	QI-901PK	00349	N/A

I/O CABLES

I/O CABLE LIST						
Cable No.	Port	# of Identica Ports	Connector Type	Cable Type	Cable Length	Remarks
1	AC	1	US120V	Un-shielded	1.0m	N/A
2	DC	1	DC	Un-shielded	1.8m	Ferrite on laptop's end
3	USB	1	USB	Shielded	1.8m	No
4	ECG	1	ECG	Un-shielded	0.3m	No
5	ECG	1	ECG	Un-shielded	0.7 / 0.9 m	N/A
6	Sp02	1	Sp02	Un-shielded	1.6 m	Probe

TEST SETUP

The EUT is standalone unit and just use a host laptop computer to configure the mode during the tests. Test software exercised the radio card.

SETUP DIAGRAM FOR TESTS

RF Conducted test

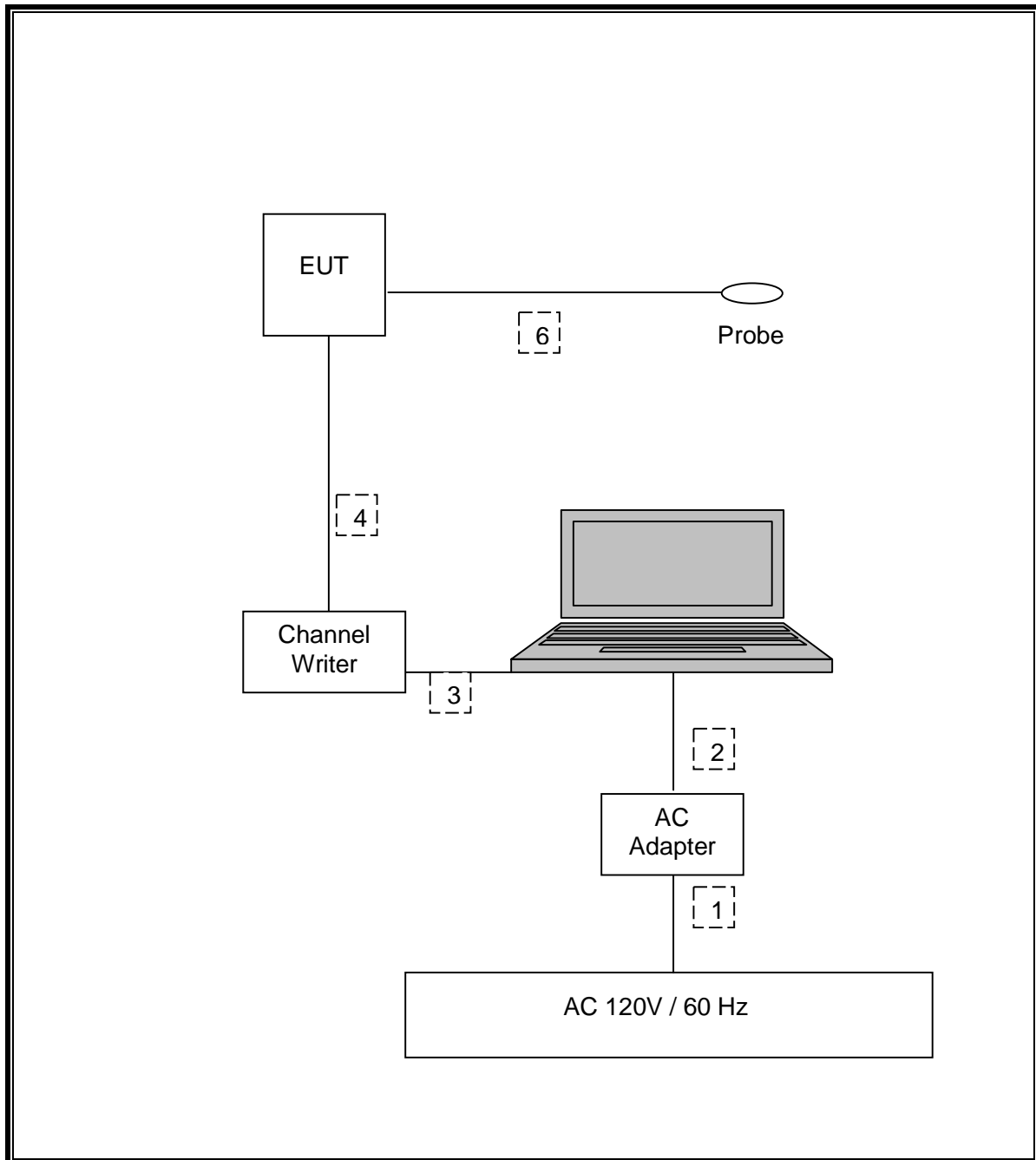

SETUP DIAGRAM FOR TESTS

RF Radiated test

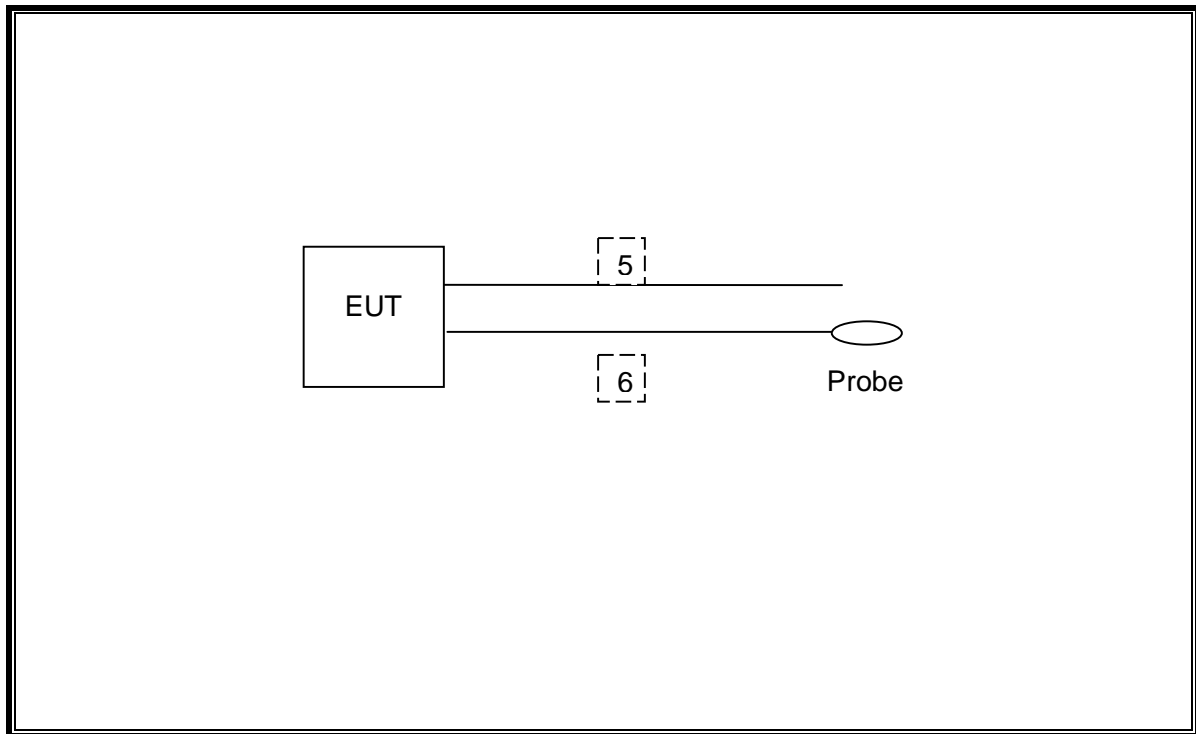

6. TEST AND MEASUREMENT EQUIPMENT

The following test and measurement equipment was utilized for the tests documented in this report:

Control No.	Instrument	Manufacturer	Model No	Serial No	Calibration Date * Interval(month)
MAEC-04	Semi Anechoic Chamber(NSA)	TDK	Semi Anechoic Chamber 3m	DA-10005	2011/03/01 * 12
MOS-15	Thermo-Hygrometer	Custom	CTH-180	-	2011/02/23 * 12
MJM-07	Measure	PROMART	SEN1955	-	-
COTS-MEMI	EMI measurement program	TSJ	TEPTO-DV	-	-
MSA-04	Spectrum Analyzer	Agilent	E4448A	US44300523	2011/04/08 * 12
MHA-21	Horn Antenna 1-18GHz	Schwarzbeck	BBHA9120D	9120D-557	2010/08/08 * 12
MCC-56	Microwave Cable	Suhner	SUCOFLEX104	270875/4(1m) / 284655(5m)	2011/03/02 * 12
MAEC-03	Semi Anechoic Chamber(NSA)	TDK	Semi Anechoic Chamber 3m	DA-10005	2011/02/22 * 12
MOS-13	Thermo-Hygrometer	Custom	CTH-180	-	2011/02/23 * 12
MJM-06	Measure	PROMART	SEN1955	-	-
MSA-03	Spectrum Analyzer	Agilent	E4448A	MY44020357	2010/11/30 * 12
MTR-08	Test Receiver	Rohde & Schwarz	ESCI	100767	2010/08/23 * 12
MBA-03	Biconical Antenna	Schwarzbeck	BBA9106	1915	2010/10/11 * 12
MLA-03	Logperiodic Antenna	Schwarzbeck	USLP9143	174	2010/10/11 * 12
MCC-51	Coaxial cable	UL Japan	-	-	2010/07/06 * 12
MAT-09	Attenuator(6dB)	Weinschel Corp	2	BK7973	2010/11/05 * 12
MPA-13	Pre Amplifier	SONOMA INSTRUMENT	310	260834	2011/03/04 * 12
MHA-20	Horn Antenna 1-18GHz	Schwarzbeck	BBHA9120D	258	2011/05/23 * 12
MCC-58	Microwave Cable	Suhner	SUCOFLEX104	246770(1m) / 250655(5m)	2011/03/02 * 12
MPA-11	MicroWave System Amplifier	Agilent	83017A	MY39500779	2011/03/10 * 12
MBF-09	Band Pass Filter	M-City	BPF4250-01	UL0004	2011/05/23 * 12
MBF-02	SHF Bandpass Filter	M-City	8GHz BPF	AI0001-02	2011/05/13 * 12
MCC-76	Microwave Cable 1G-26.5GHz	Suhner	SUCOFLEX104	278967/4	2010/12/03 * 12
MHA-21	Horn Antenna 1-18GHz	Schwarzbeck	BBHA9120D	9120D-557	2010/08/08 * 12
MHF-19	High Pass Filter 3.5-18.0GHz	TOKIMEC	TF323DCA	602	2010/09/21 * 12
MCC-18	Microwave Cable 1G-26.5GHz	Suhner	SUCOFLEX 104	148048-143(1m) / 292410(5m)	2010/09/30 * 12
MCC-67	Microwave Cable 1G-40GHz	Suhner	SUCOFLEX102	28635/2	2011/04/22 * 12
MAT-23	Attenuator(10dB) 1-18GHz	Orient Microwave	BX10-0476-00	-	2011/03/14 * 12

Control No.	Instrument	Manufacturer	Model No	Serial No	Calibration Date * Interval(month)
MCC-64	Microwave Cable 1G-40GHz	Suhner	SUCOFLEX102	28635/2	2011/04/22 * 12
MOS-04	Digital Humidity Indicator	N.T	NT-1800	MOS04	2011/02/23 * 12
MBM-11	Barometer	Sunoh	SBR121	839	2010/12/13 * 36
MPM-12	Power Meter	Anritsu	ML2495A	0825002	2010/08/20 * 12
MPSE-17	Power sensor	Anritsu	MA2411B	0738285	2010/08/20 * 12
MSA-10	Spectrum Analyzer	Agilent	E4448A	MY46180655	2011/02/15 * 12
MTR-03	Test Receiver	Rohde & Schwarz	ESCI	100300	2011/04/15 * 12
MBA-05	Biconical Antenna	Schwarzbeck	BBA9106	1302	2010/10/11 * 12
MLA-08	Logperiodic Antenna	Schwarzbeck	UKLP9140-A	N/A	2010/10/11 * 12
MCC-50	Coaxial Cable	UL Japan	-	-	2011/03/25 * 12
MAT-51	Attenuator(6dB)	Weinschel	2	AS3557	2011/01/14 * 12
MPA-14	Pre Amplifier	SONOMA INSTRUMENT	310	260833	2011/03/04 * 12
MPA-12	MicroWave System Amplifier	Agilent	83017A	MY39500780	2011/03/10 * 12
MHF-06	High Pass Filter 3.5-24GHz	TOKIMEC	TF323DCA	601	2011/05/16 * 12

The expiration date of the calibration is the end of the expired month.

All equipment is calibrated with valid calibrations. Each measurement data is traceable to the national or international standards.

As for some calibrations performed after the tested dates, those test equipment have been controlled by means of an unbroken chains of calibrations.

7. ANTENNA PORT TEST RESULTS

7.1. 26 dB AND 99% BW

LIMITS

§2.1049, for reporting purposes only, also the 26dB bandwidth shall be less than 20 KHz (F1D).

TEST PROCEDURE

ANSI C63.4

The transmitter output is connected to the spectrum analyzer.

26dB Bandwidth: The RBW is set to 1% to 3% of the 26dB bandwidth. The VBW is set to 3 times the RBW. The sweep time is coupled. The spectrum analyzer internal 26dB bandwidth function is utilized.

99% Bandwidth: The RBW is set to 1% to 3% of the 99 % bandwidth. The VBW is set to 3 times the RBW. The sweep time is coupled. The spectrum analyzer internal 99% bandwidth function is utilized.

RESULTS

26dB Bandwidth

Channel	Frequency (MHz)	26dB Bandwidth (kHz)
E002	1395.025	18.276
E398	1399.975	17.605
E502	1427.025	18.026
E898	1431.975	18.580

99% Bandwidth

Channel	Frequency (MHz)	99% Bandwidth (kHz)
E002	1395.025	13.805
E398	1399.975	13.447
E502	1427.025	15.321
E898	1431.975	14.084

[PLL Substitution model]

26dB Bandwidth

Channel	Frequency (MHz)	26dB Bandwidth (kHz)
E898	1431.975	17.605

99% Bandwidth

Channel	Frequency (MHz)	99% Bandwidth (kHz)
E898	1431.975	14.113

20dB and 99% BANDWIDTH

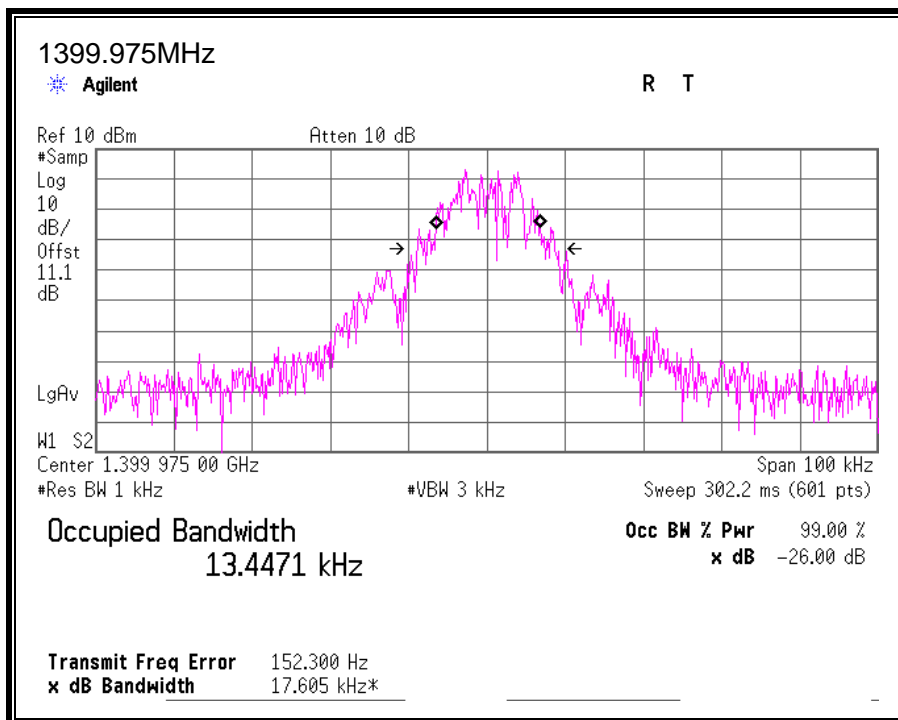
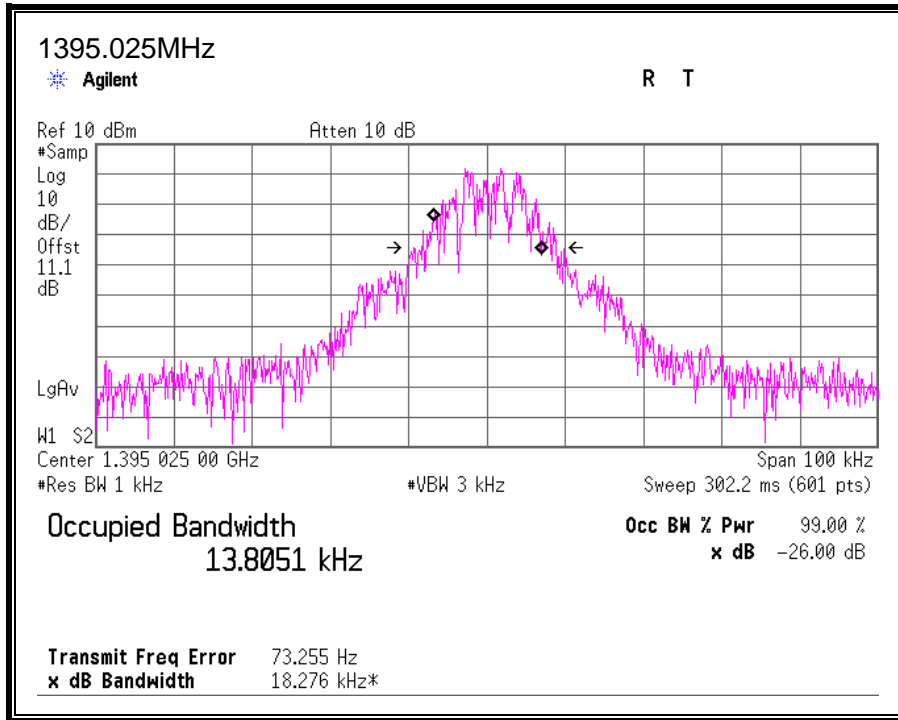

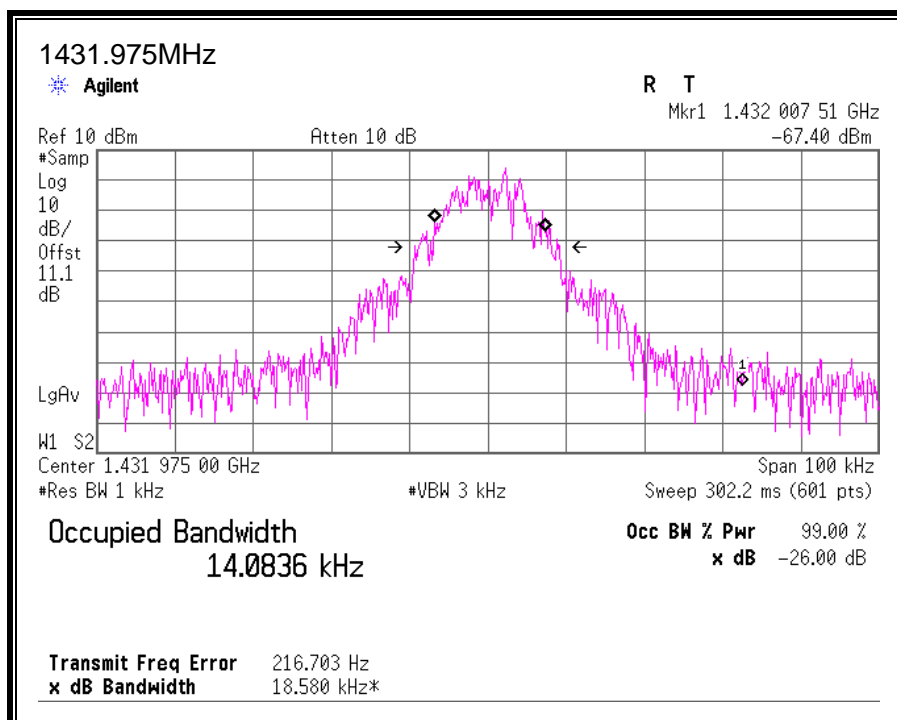
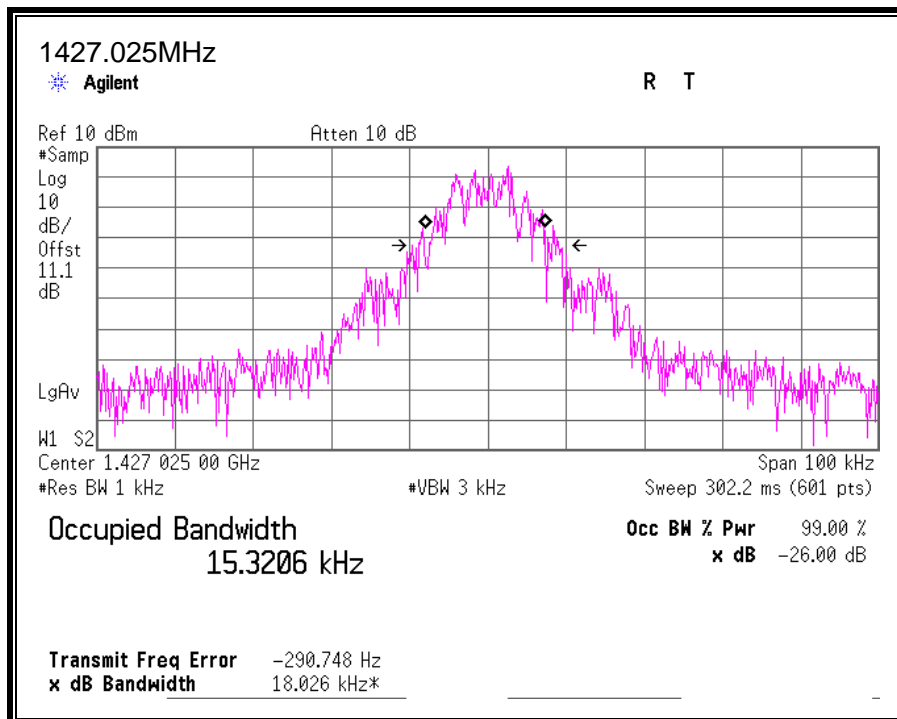

[PLL Substitution model]

20dB and 99% BANDWIDTH

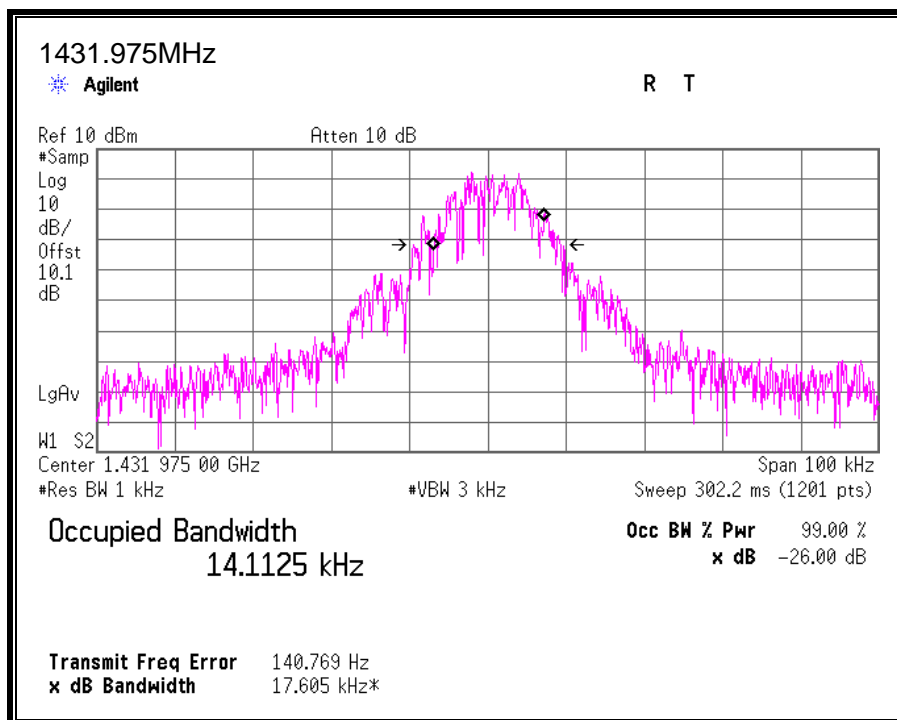

7.2. PEAK OUTPUT POWER

LIMITS

§2.1046, for reporting purposes only.

TEST PROCEDURE

The transmitter output is connected to a power meter.

RESULTS

The cable assembly insertion loss of 10 dB (including 10dB pad) was entered as an offset in the power meter to allow for direct reading of power.

Channel	Frequency (MHz)	Output Power (dBm)
E002	1395.025	6.30
E398	1399.975	6.53
E502	1427.025	6.93
E898	1431.975	6.95

[PLL Substitution model]

Channel	Frequency (MHz)	Output Power (dBm)
E898	1431.975	6.78

7.3. AVERAGE POWER

LIMITS

None; for reporting purposes only.

TEST PROCEDURE

The transmitter output is connected to a power meter.

RESULTS

The cable assembly insertion loss of 11.1 dB (including 10dB pad & 1.1dB cable loss) was entered as an offset in the power meter to allow for direct reading of power.

Channel	Frequency (MHz)	Output Power (dBm)
E002	1395.025	6.24
E398	1399.975	6.46
E502	1427.025	6.82
E898	1431.975	6.86

[PLL Substitution model]

Channel	Frequency (MHz)	Output Power (dBm)
E898	1431.975	6.65

7.4. SPURIOUS EMISSIONS AT ANTENNA TERMINAL

LIMIT

§2.1051 All the conducted emission spurious level shall be at least -20dBc below the band that contains the highest level of desired power.

TEST PROCEDURE

The transmitter output is connected to a spectrum analyzer. The RBW=1MHz, VBW=3MHz.

The spectrum from 30 MHz to 10th harmonic is investigated with the transmitter set to the lowest and highest channels.

TEST RESULTS

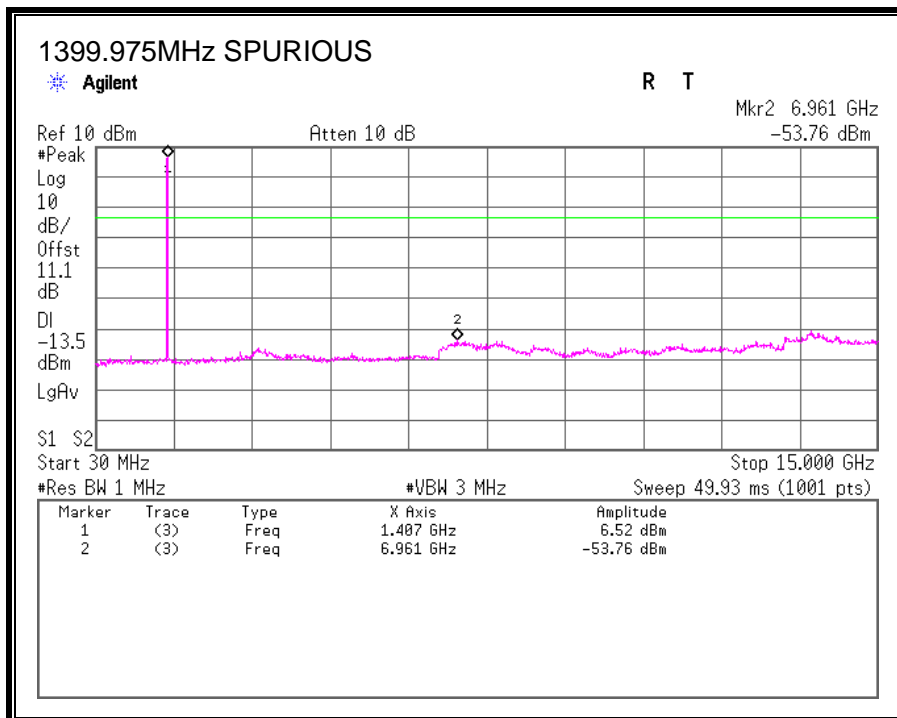
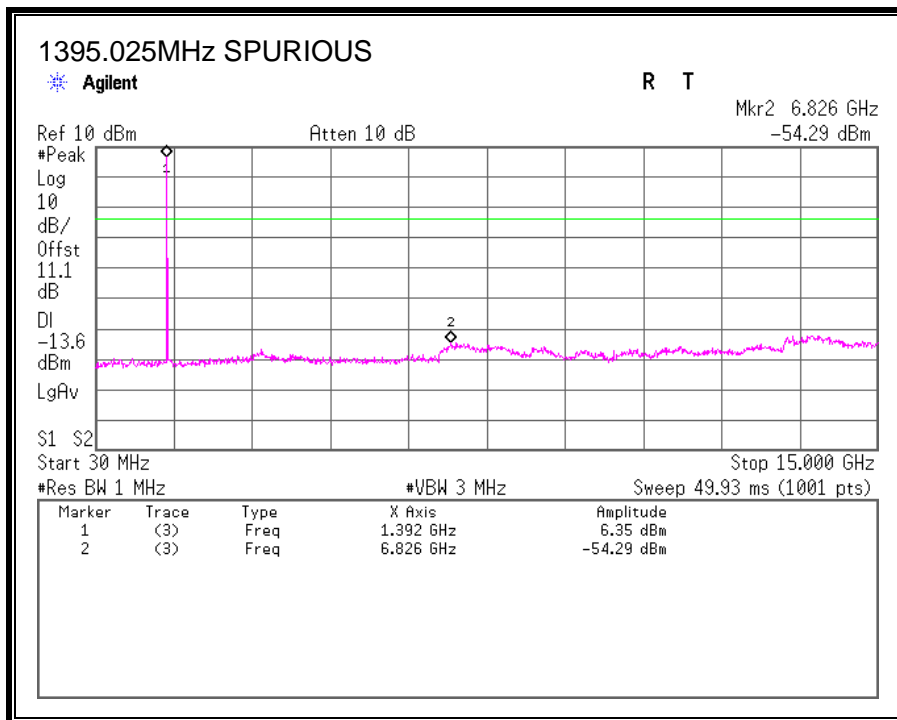

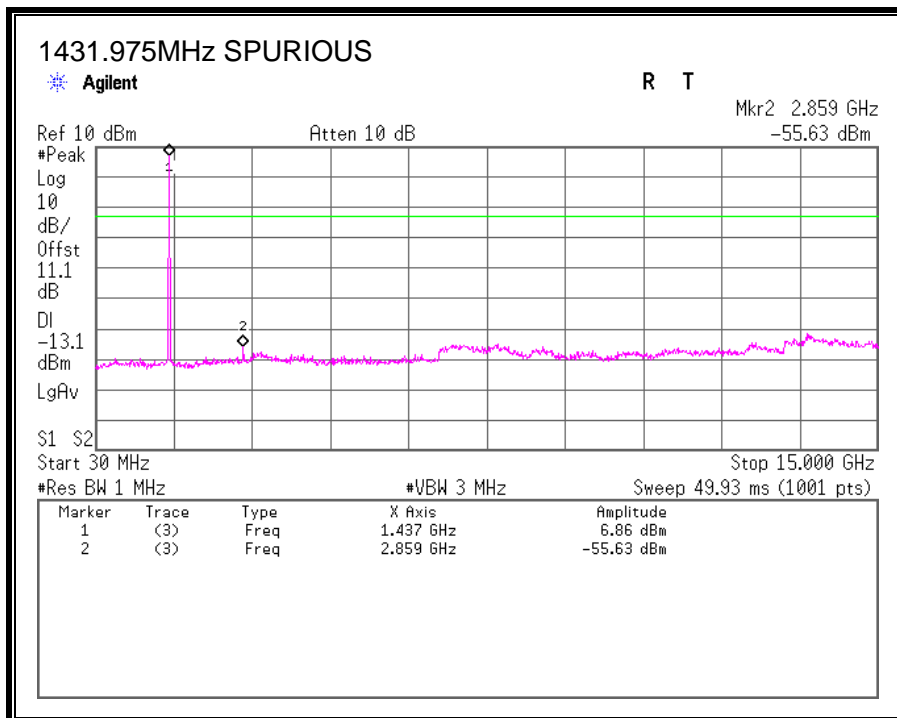
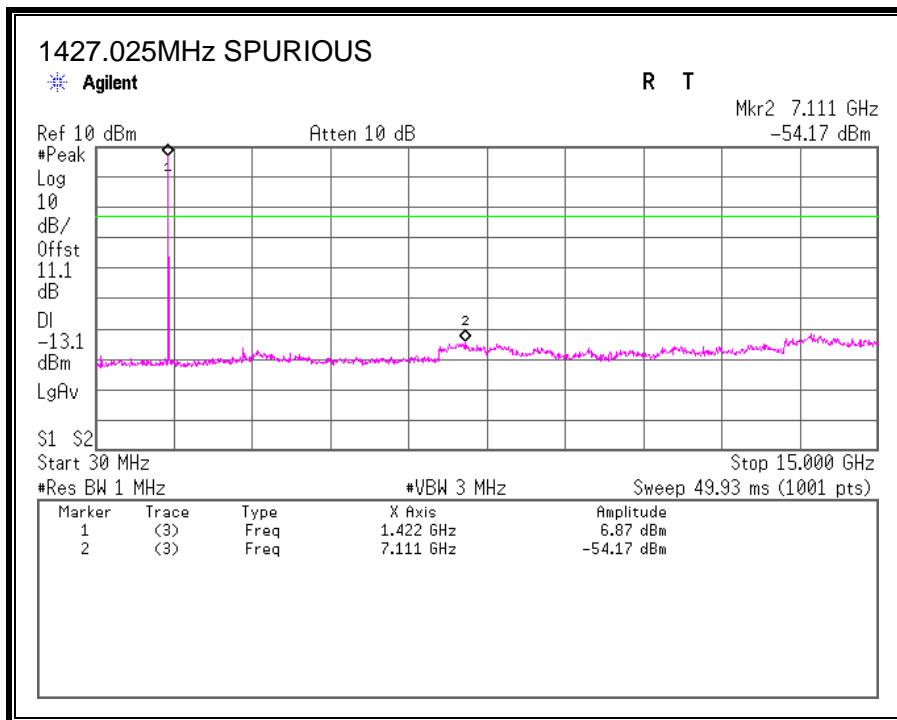

7.5. FREQUENCY STABILITY MEASUREMENT

LIMIT

§95.115 (e) Frequency stability.

Manufacturers of wireless medical telemetry devices are responsible for ensuring frequency stability such that an emission is maintained within the band of operation under all of the manufacturer's specified conditions.

TEST PROCEDURE

Frequency stability versus environmental temperature

- 1) Set the temperature of chamber to 25°C @ low/high channel. Allow sufficient time (approximately 30 min) for the temperature of the chamber to stabilize. While maintaining a constant temperature inside the chamber, turn the EUT on and measure the EUT operating frequency.
- 2) Set SA Resolution Bandwidth to 300 Hz and Video Resolution Bandwidth to 300 Hz and Frequency Span to 20 KHz. Record this frequency as reference frequency.
- 3) Repeat step 2 with a 10°C decreased per stage until the lowest temperature -30°C is measured, record all measured frequencies on each temperature step.
- 3) Repeat step 2 with a 10°C increased per stage until the highest temperature +50°C is measured; record all measured frequencies on each temperature step.

Frequency stability versus input voltage

- 1). Setup the configuration as shown below for frequencies measured at temperature if it is 25°C.
- 2). Set SA center frequency to the EUT radiated frequency. Set SA Resolution Bandwidth to 300 Hz and Video Resolution Bandwidth to 300 Hz and Frequency Span to 20 KHz. Record this frequency as reference frequency.
- 3). For battery operated only device, supply the EUT primary voltage at the operating end point which is specified by manufacturer and record the frequency.

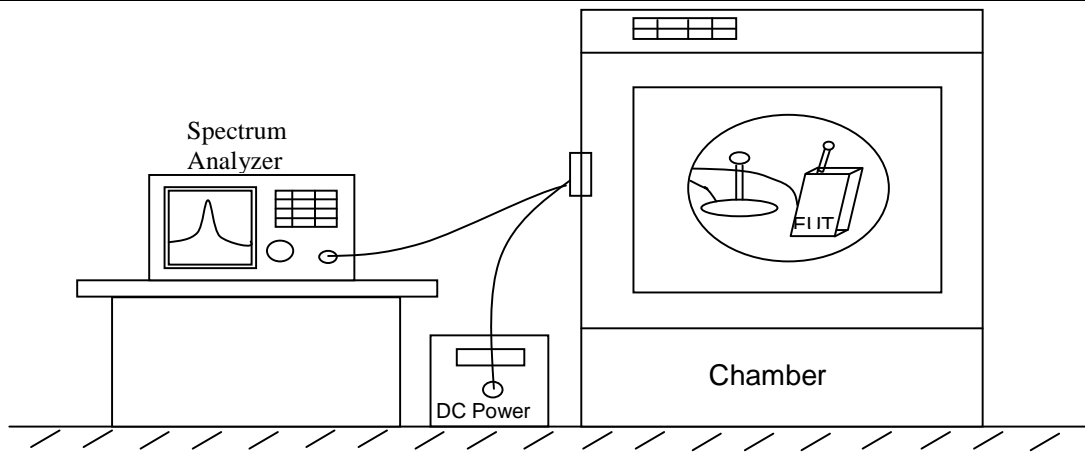

Frequency stability measurement configuration

TEST RESULTS

LOW CHANNEL

20°C Reference Frequency:		1395.025000		MHz	
Limit: +/-	2.5	ppm =	0.003488		MHz
Power Supply		Environment	Frequency	Delta (MHz)	Limit +/- (MHz)
VDC		Temperature (°C)	(MHz)		
3.00	Normal (100%)	50	1395.025121	0.000121	0.003488
		40	1395.024969	-0.000031	0.003488
		30	1395.024815	-0.000185	0.003488
		20	1395.025041	0.000041	0.003488
		10	1395.024831	-0.000169	0.003488
		0	1395.024991	-0.000009	0.003488
		-10	1395.025049	0.000049	0.003488
		-20	1395.025261	0.000261	0.003488
		-30	1395.024847	-0.000153	0.003488
3.00	Normal		1395.025041	0.000041	0.003488
1.10	Low		1395.025149	0.000149	0.003488
1.00	End Point				

HIGH CHANNEL

20°C Reference Frequency:		1431.975000		MHz	
Limit: +/- 2.5 ppm =		0.003580		MHz	
Power Supply	Environment	Frequency	Delta (MHz)	Limit +/- (MHz)	
VDC	Temperature (°C)	(MHz)			
3.00	Normal (100%)	50	1431.975159	0.000159	0.003580
		40	1431.974000	-0.001000	0.003580
		30	1431.974781	-0.000219	0.003580
		20	1431.975025	0.000025	0.003580
		10	1431.974765	-0.000235	0.003580
		0	1431.974996	-0.000004	0.003580
		-10	1431.975095	0.000095	0.003580
		-20	1431.975082	0.000082	0.003580
		-30	1431.975223	0.000223	0.003580
3.00	Normal	1431.975025	0.000025	0.003580	
1.10	Low	1431.975156	0.000156	0.003580	
1.00	End Point				

[PLL Substitution model]

LOW CHANNEL

20°C Reference Frequency:		1395.025000		MHz	
Limit: +/-	2.5	ppm =	0.003488		MHz
Power Supply		Environment	Frequency	Delta (MHz)	Limit +/- (MHz)
VDC		Temperature (°C)	(MHz)		
3.00	Normal (100%)	50	1395.025169	0.000169	0.003488
		40	1395.025149	0.000149	0.003488
		30	1395.025164	0.000164	0.003488
		20	1395.025135	0.000135	0.003488
		10	1395.025137	0.000137	0.003488
		0	1395.024777	-0.000223	0.003488
		-10	1395.024690	-0.000310	0.003488
		-20	1395.024674	-0.000326	0.003488
		-30	1395.024985	-0.000015	0.003488
3.00	Normal		1395.025135	0.000135	0.003488
1.00	Low		1395.025138	0.000138	0.003488
0.90	End Point				

[PLL Substitution model]

HIGH CHANNEL

20°C Reference Frequency:		1431.975000		MHz	
Limit: +/- 2.5 ppm =		0.003580		MHz	
Power Supply	Environment	Frequency	Delta (MHz)	Limit +/- (MHz)	
VDC	Temperature (°C)	(MHz)			
3.00	Normal (100%)	50	1431.975136	0.000136	0.003580
		40	1431.975283	0.000283	0.003580
		30	1431.975320	0.000320	0.003580
		20	1431.975406	0.000406	0.003580
		10	1431.975408	0.000408	0.003580
		0	1431.975460	0.000460	0.003580
		-10	1431.975034	0.000034	0.003580
		-20	1431.975060	0.000060	0.003580
		-30	1431.975261	0.000261	0.003580
3.00	Normal	1431.975406	0.000406	0.003580	
1.00	Low	1431.975414	0.000414	0.003580	
0.90	End Point				

8. RADIATED EMISSION TEST RESULTS

LIMITS

§95.115

(a) Field strength limits

(2) In the 1395–1400 MHz and 1427–1432 MHz bands, the maximum allowable field strength is 740 mV/m as measured at a distance of 3 meters, using measuring equipment with an averaging detector and a 1 MHz measurement bandwidth.

(b) Undesired emissions.

(1) Out-of-band emissions below 960 MHz are limited to 200 microvolts/meter, as measured at a distance of 3 meters, using measuring instrumentation with a CISPR quasi-peak detector.

(2) Out-of-band emissions above 960 MHz are limited to 500 microvolts/meter as measured at a distance of 3 meters, using measuring equipment with an averaging detector and a 1 MHz measurement bandwidth.

TEST PROCEDURE

ANSI/TIA-603-C-2004

RESULTS

8.1. FUNDAMENTAL OUTPUT POWER

Report No. : 31KE0332-HO
 Test Place : Head Office EMC Lab.
 Semi Anechoic Chamber: : No. 4
 Date : 2011/05/24
 Temperature/Humidity : 23 deg.C / 48% RH
 Engineer: : Takeshi Choda
 Mode: : Tx

Polarity	Frequency [MHz]	Detector	Reading [dBuV]	Ant.Fac. [dB/m]	Loss [dB]	Gain [dB]	Result [dBuV/m]	Limit [dBuV/m]	Margin [dB]	Remark
Hori	1395.025	AV	110.6	26.5	2.0	34.2	104.9	117.4	12.5	Z-axis
Vert	1395.025	AV	106.5	26.5	2.0	34.2	100.8	117.4	16.6	Y-axis
Hori	1399.975	AV	107.3	25.4	2.0	34.2	100.5	117.4	16.9	Z-axis
Vert	1399.975	AV	107.1	25.4	2.0	34.2	100.3	117.4	17.1	Y-axis
Hori	1427.025	AV	108.0	25.5	2.0	34.1	101.4	117.4	16.0	Z-axis
Vert	1427.025	AV	107.8	25.5	2.0	34.1	101.2	117.4	16.2	Y-axis
Hori	1431.975	AV	109.3	25.6	2.0	34.1	102.8	117.4	14.6	Z-axis
Vert	1431.975	AV	107.4	25.6	2.0	34.1	100.9	117.4	16.5	Y-axis

Result = Reading + Ant Factor + Loss (Cable+Attenuator+Filter) - Gain(Amplifier)

[PLL Substitution model]

Report No. : 31KE0332-HO
 Test Place : Head Office EMC Lab.
 Semi Anechoic Chamber: : No. 4
 Date : 2011/07/01
 Temperature/Humidity : 22 deg.C / 62 % RH
 Engineer: : Katsunori Okai
 Mode: : Tx

Polarity	Frequency [MHz]	Detector	Reading [dBuV]	Ant.Fac. [dB/m]	Loss [dB]	Gain [dB]	Result [dBuV/m]	Limit [dBuV/m]	Margin [dB]	Remark
Hori	1395.025	AV	74.6	25.4	1.9	0.0	101.9	117.4	15.5	
Vert	1395.025	AV	70.6	25.4	1.9	0.0	97.9	117.4	19.5	
Hori	1431.975	AV	73.1	25.6	1.9	0.0	100.6	117.4	16.8	
Vert	1431.975	AV	69.7	25.6	1.9	0.0	97.2	117.4	20.2	

Result = Reading + Ant Factor + Loss (Cable+Attenuator+Filter) - Gain(Amplifier)

8.2. RADIATED EMISSIONS BELOW 960 MHz

Note 1: The measurements in this section show that Peak values are less than the Quasi-Peak limit.

Note 2: Plots in the range of 960 to 1000 MHz in this section are shown for reporting purposes only.

SPURIOUS EMISSIONS 30 TO 960 MHz (HORIZONTAL)

1395.025MHz

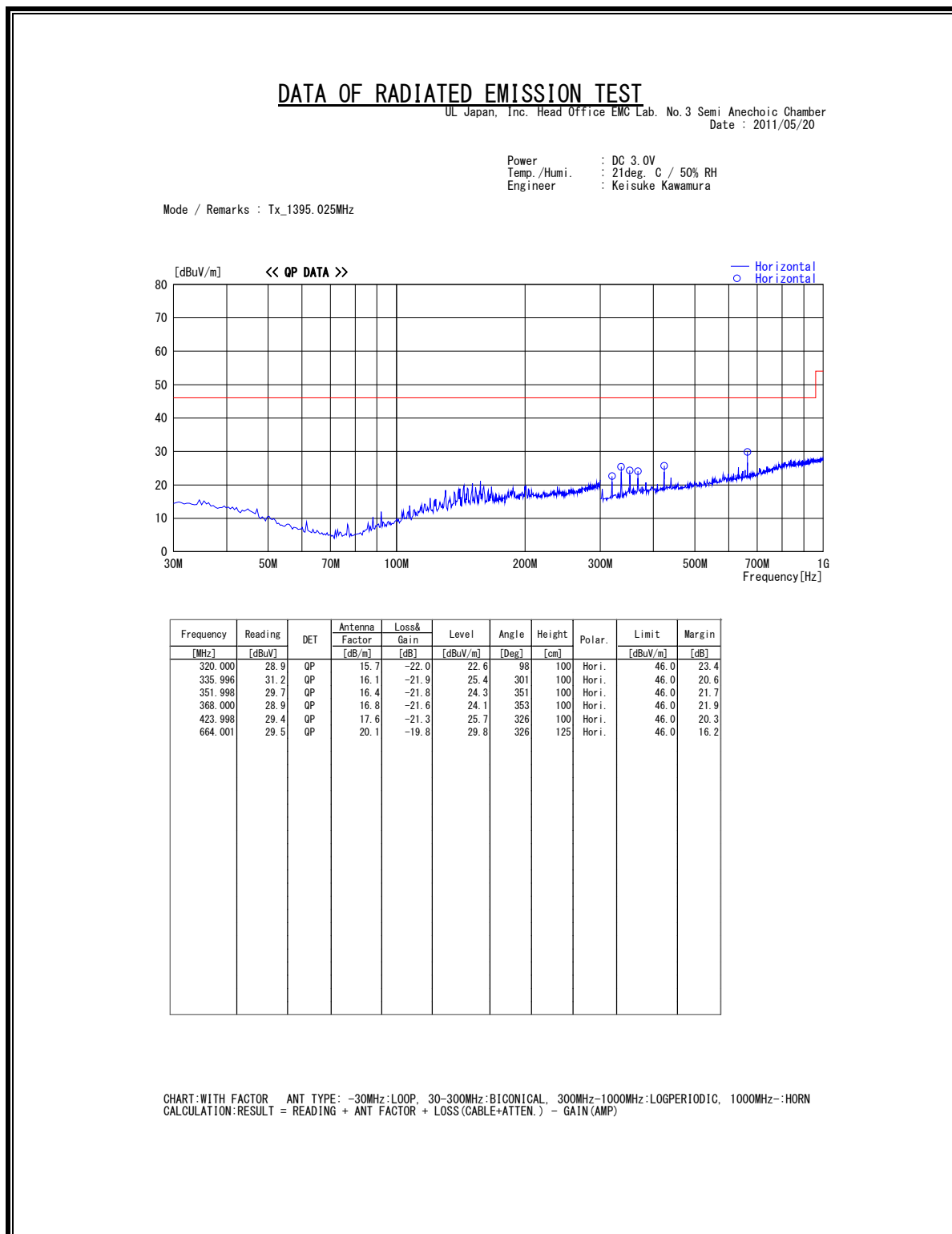

SPURIOUS EMISSIONS 30 TO 960 MHz (VERTICAL)

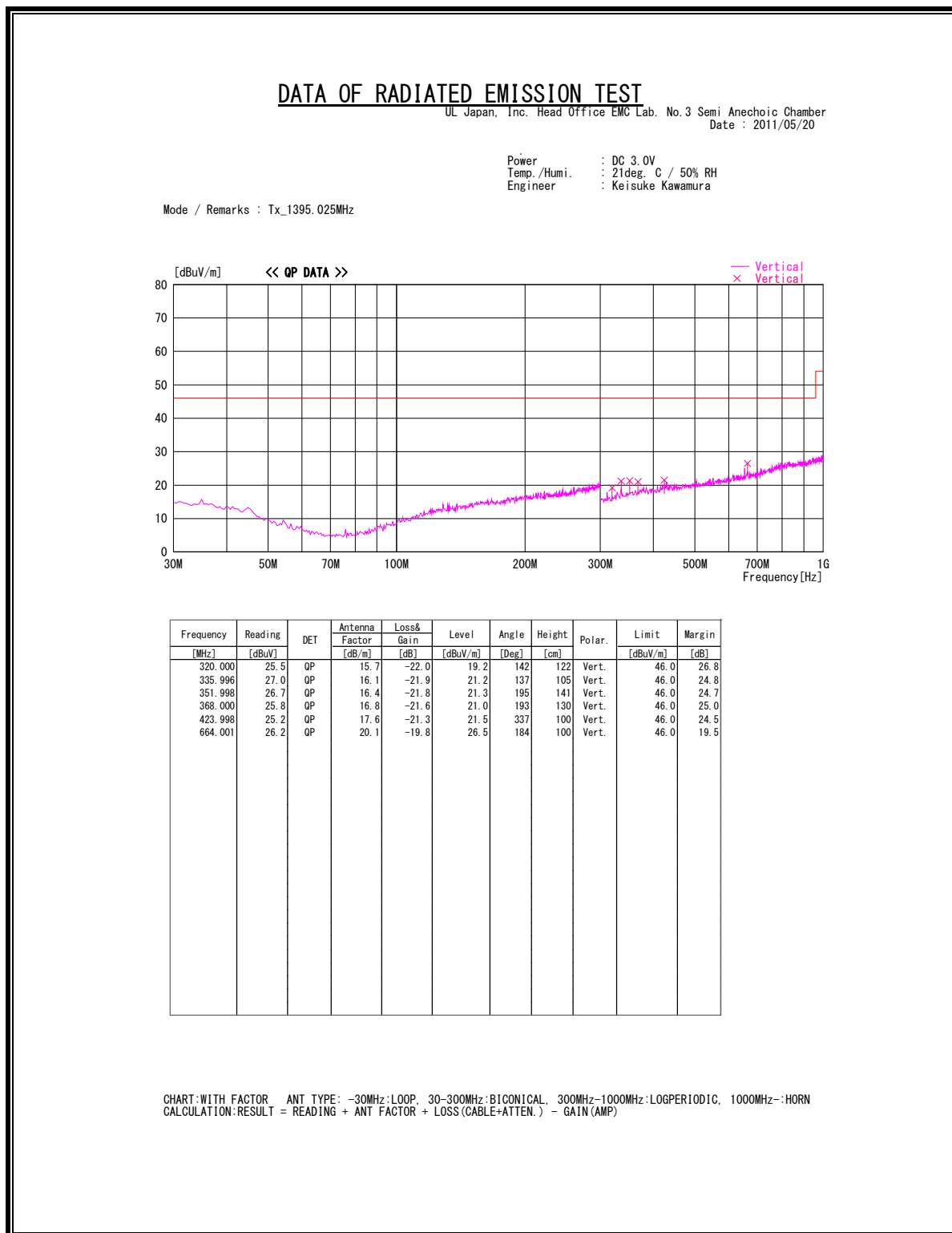

SPURIOUS EMISSIONS 30 TO 960 MHz (HORIZONTAL)

1399.975MHz

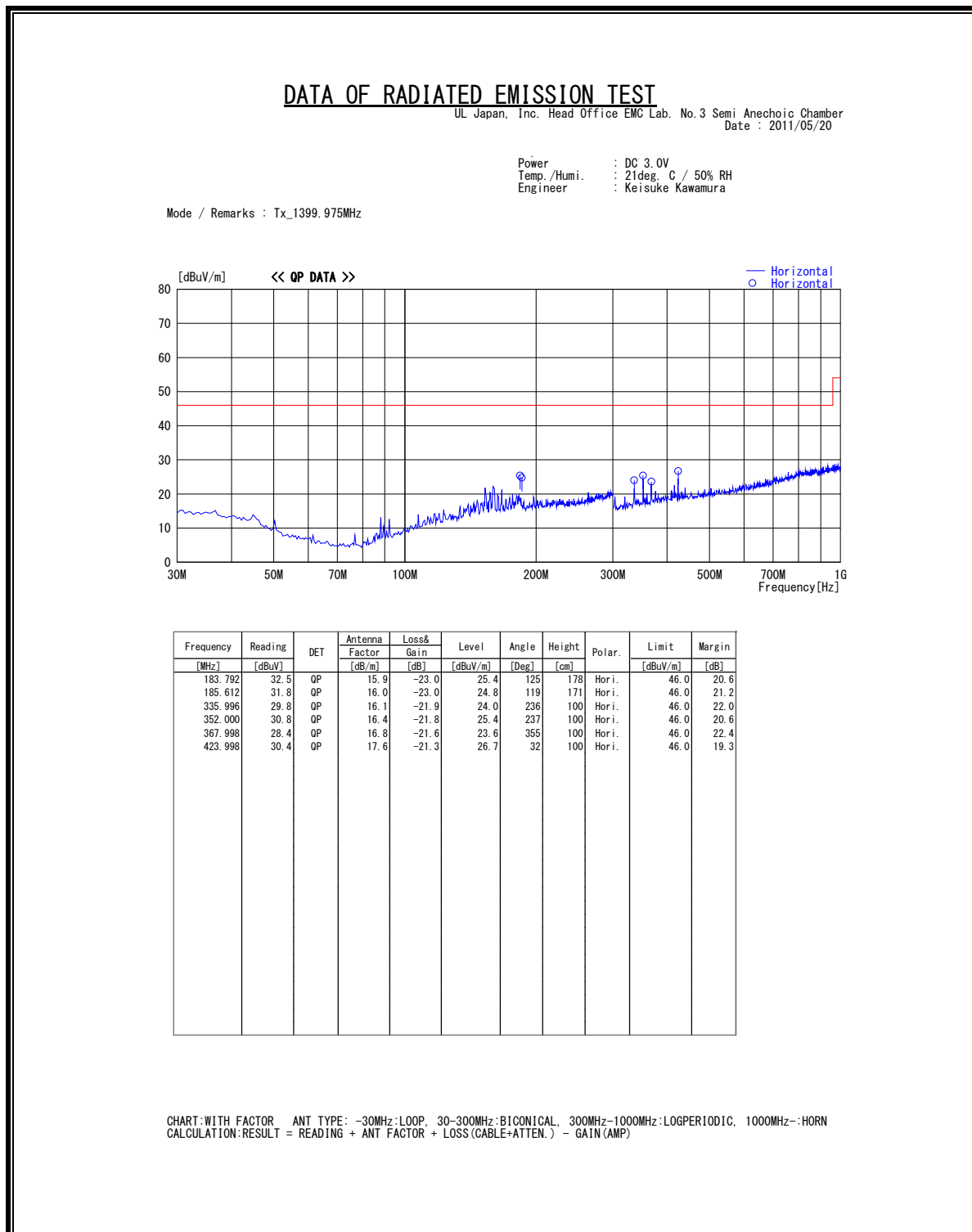

SPURIOUS EMISSIONS 30 TO 960 MHz (VERTICAL)

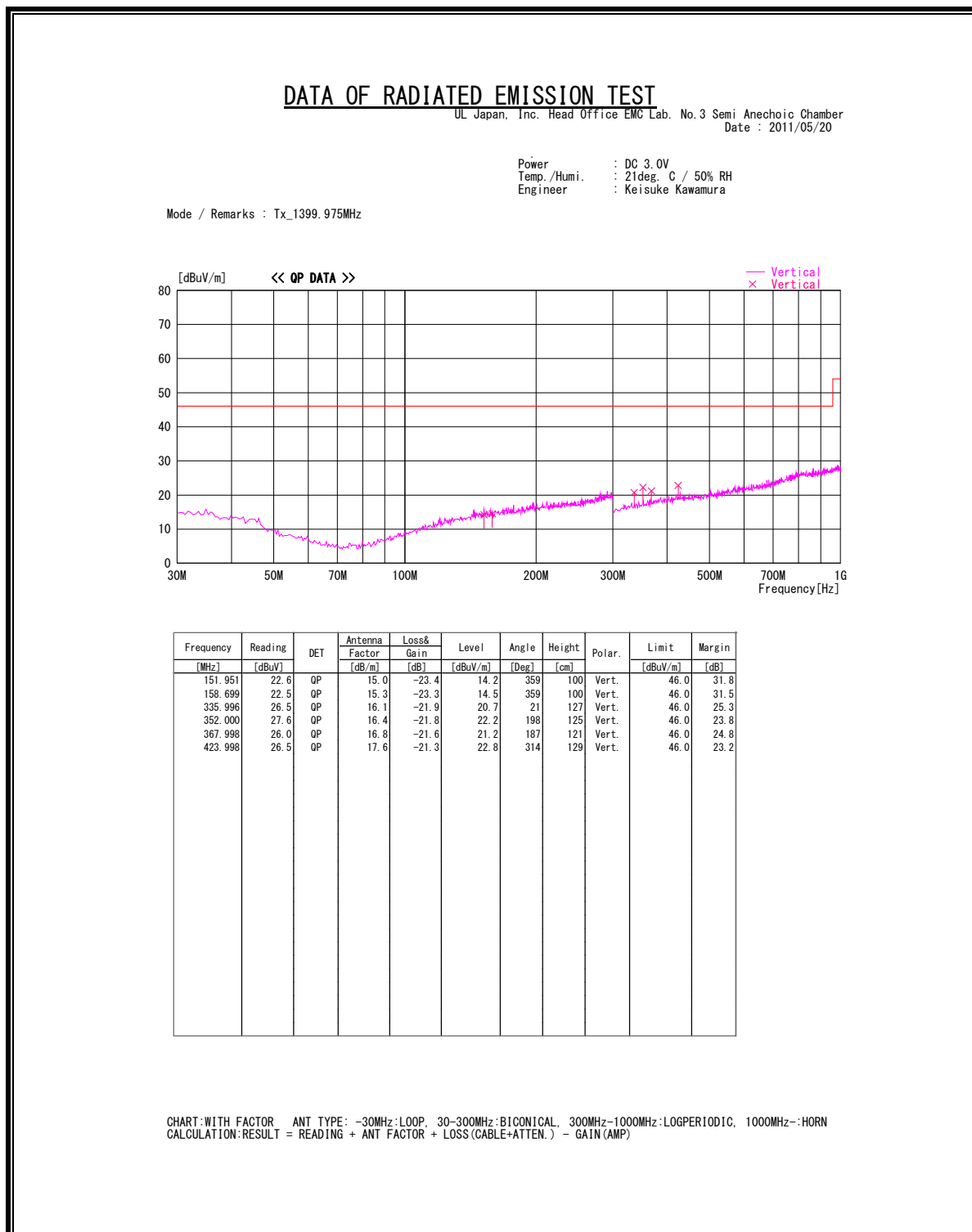

SPURIOUS EMISSIONS 30 TO 960 MHz (HORIZONTAL)

1427.025MHz

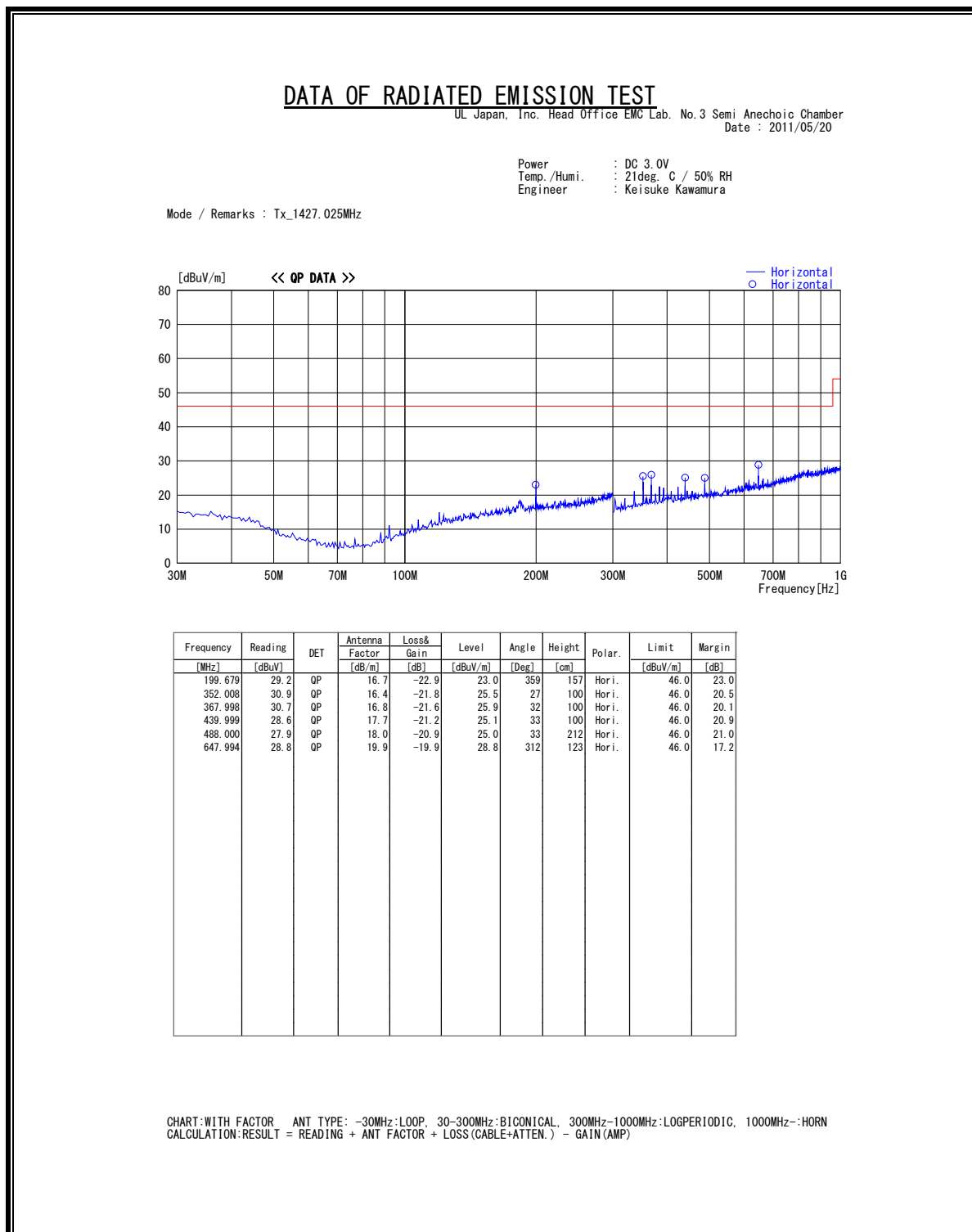

SPURIOUS EMISSIONS 30 TO 960 MHz (VERTICAL)

DATA OF RADIATED EMISSION TEST

UL Japan, Inc. Head Office EMC Lab. No. 3 Semi Anechoic Chamber
 Date : 2011/05/20

Power : DC 3.0V
 Temp./Humi. : 21deg. C / 50% RH
 Engineer : Keisuke Kawamura

Mode / Remarks : Tx_1427.025MHz

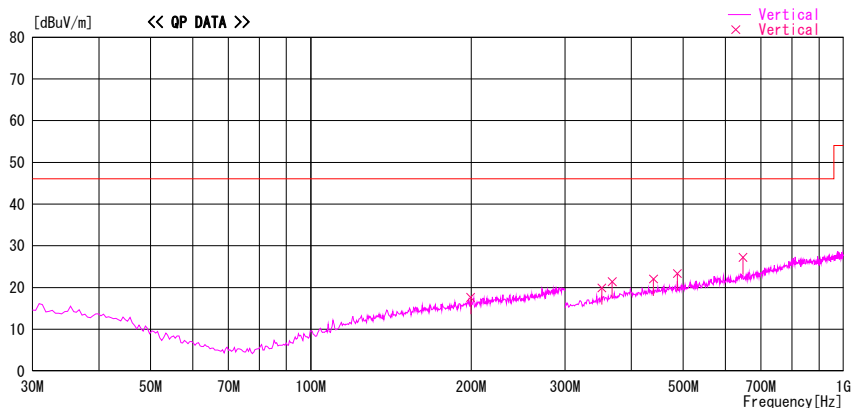

Frequency [MHz]	Reading [dBuV]	DET	Antenna		Level [dBuV/m]	Angle [Deg]	Height [cm]	Polar.	Limit [dBuV/m]	Margin [dB]
			Factor [dB/m]	Loss & Gain [dB]						
199.679	23.8	QP	16.7	-22.9	17.6	46	208	Vert.	46.0	28.4
352.008	25.3	QP	16.4	-21.8	19.9	188	138	Vert.	46.0	26.1
367.998	26.2	QP	16.8	-21.6	21.4	185	126	Vert.	46.0	24.6
439.999	25.5	QP	17.7	-21.2	22.0	341	100	Vert.	46.0	24.0
488.000	26.2	QP	18.0	-20.9	23.3	81	100	Vert.	46.0	22.7
647.994	27.2	QP	19.9	-19.9	27.2	132	100	Vert.	46.0	18.8

CHART: WITH FACTOR ANT TYPE: -30MHz: LOOP, 30-300MHz: BICONICAL, 300MHz-1000MHz: LOGPERIODIC, 1000MHz-: HORN
 CALCULATION: RESULT = READING + ANT FACTOR + LOSS (CABLE+ATTEN.) - GAIN (AMP)

SPURIOUS EMISSIONS 30 TO 960 MHz (HORIZONTAL)

1431.975MHz

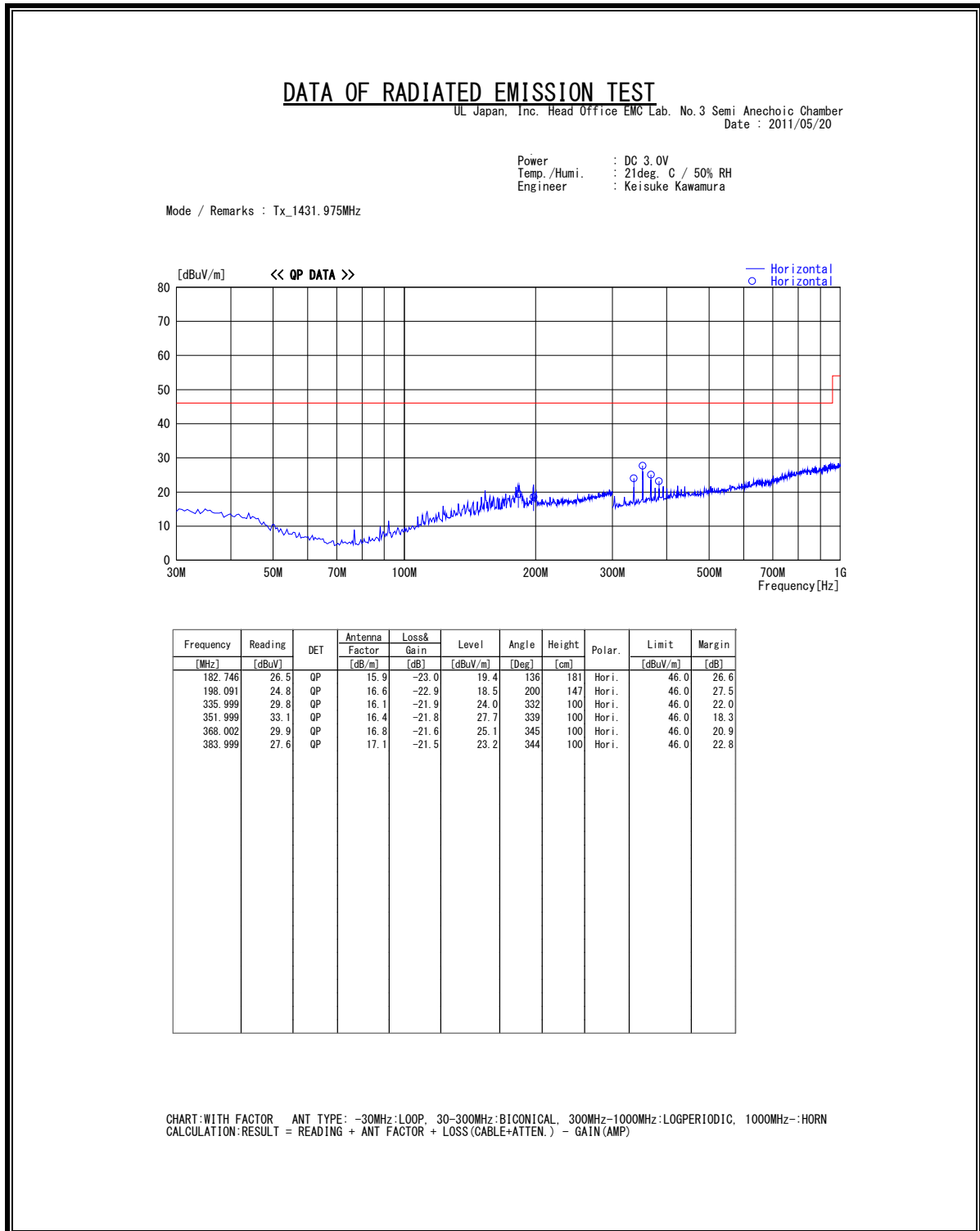

SPURIOUS EMISSIONS 30 TO 960 MHz (VERTICAL)

DATA OF RADIATED EMISSION TEST

UL Japan, Inc. Head Office EMC Lab. No. 3 Semi Anechoic Chamber
 Date : 2011/05/20

Power : DC 3.0V
 Temp./Humi. : 21deg. C / 50% RH
 Engineer : Keisuke Kawamura

Mode / Remarks : Tx_1431.975MHz

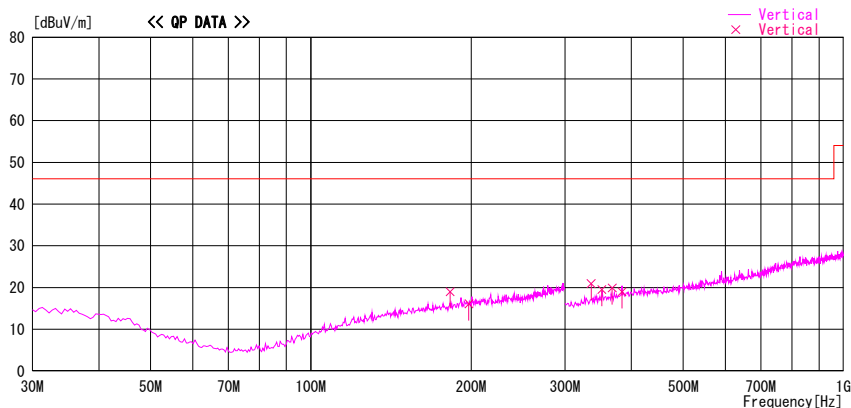

Frequency [MHz]	Reading [dBuV]	DET	Antenna	Loss &	Level [dBuV/m]	Angle [Deg]	Height [cm]	Polar.	Limit [dBuV/m]	Margin [dB]
			Factor [dB/m]	Gain [dB]						
182.746	26.1	QP	15.9	-23.0	19.0	15	246	Vert.	46.0	27.0
198.091	22.4	QP	16.6	-22.9	16.1	86	100	Vert.	46.0	29.9
335.999	26.7	QP	16.1	-21.9	20.9	129	274	Vert.	46.0	25.1
351.999	24.9	QP	16.4	-21.8	19.5	185	142	Vert.	46.0	26.5
368.002	24.7	QP	16.8	-21.6	19.9	33	144	Vert.	46.0	26.1
383.999	23.4	QP	17.1	-21.5	19.0	166	132	Vert.	46.0	27.0

CHART: WITH FACTOR ANT TYPE: -30MHz: LOOP, 30-300MHz: BICONICAL, 300MHz-1000MHz: LOGPERIODIC, 1000MHz-: HORN
 CALCULATION: RESULT = READING + ANT FACTOR + LOSS (CABLE+ATTEN.) - GAIN (AMP)

[PLL Substitution model]

SPURIOUS EMISSIONS 30 TO 960 MHz (HORIZONTAL)

1395.025MHz

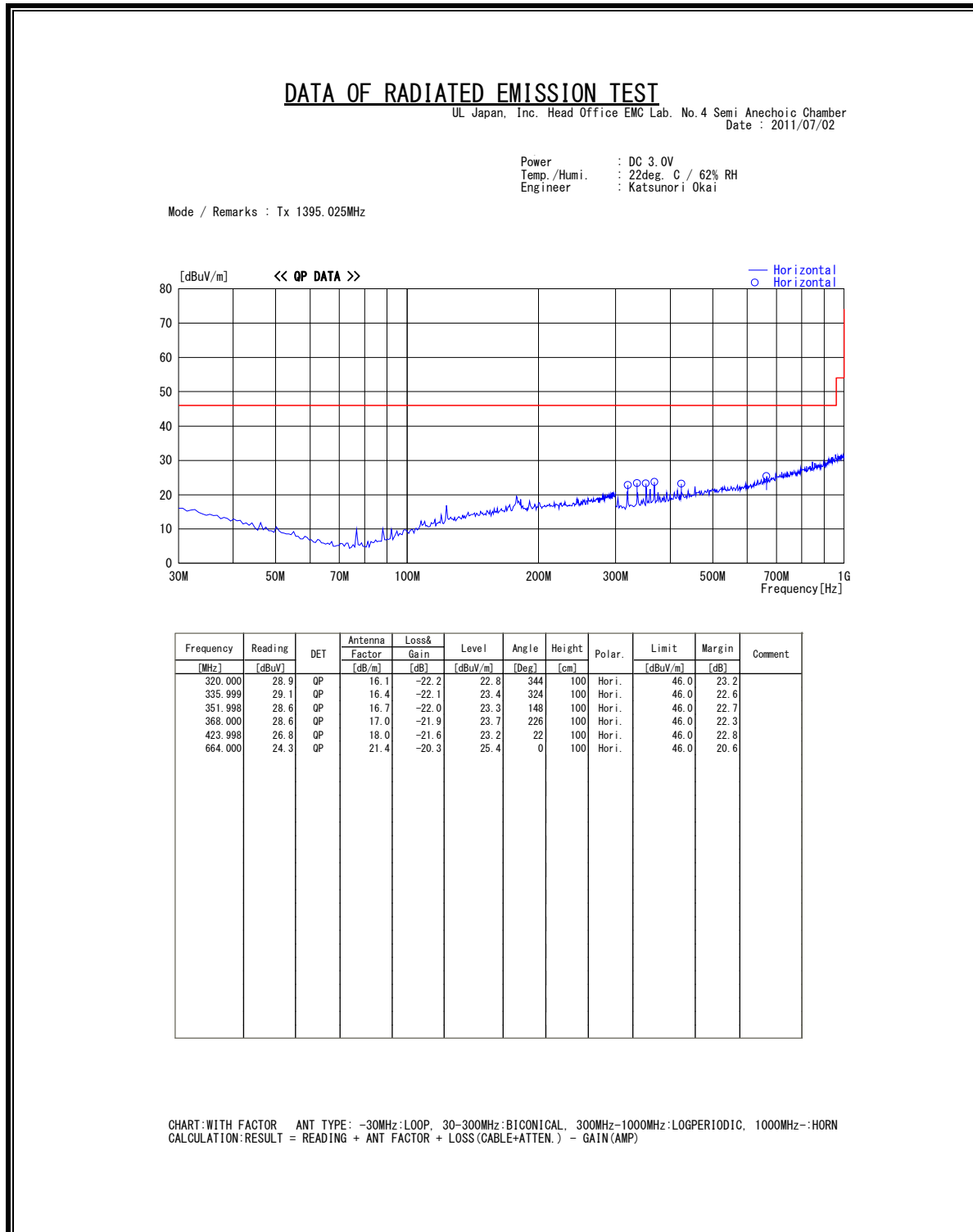

[PLL Substitution model]

SPURIOUS EMISSIONS 30 TO 960 MHz (VERTICAL)

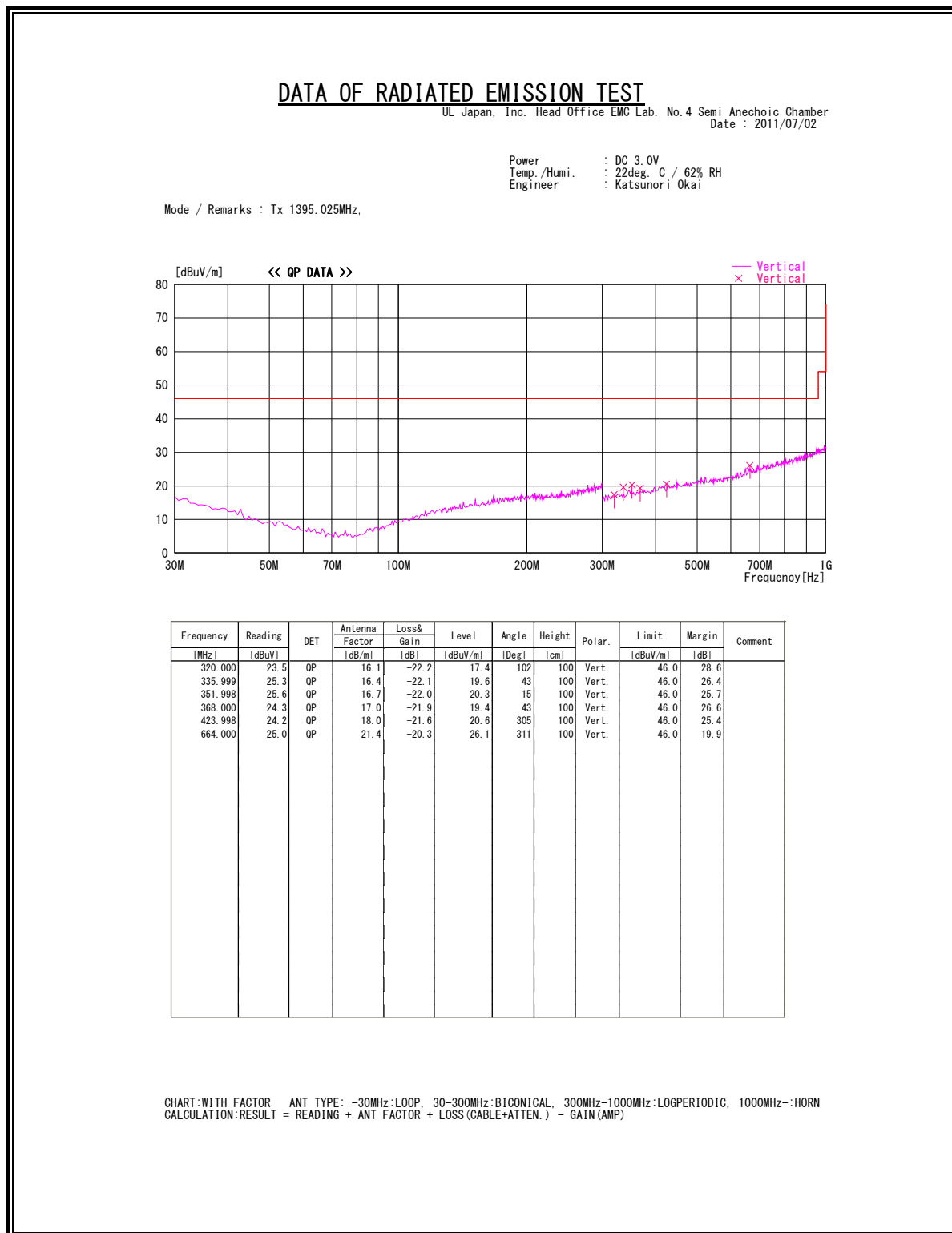

8.3. RADIATED EMISSIONS ABOVE 960 MHz
HARMONICS AND TX SPURIOUS EMISSIONS ABOVE 960 MHz
1395.025MHz

Report No. : 31KE0332-HO
 Test Place : Head Office EMC Lab.
 Semi Anechoic Chamber: : No. 4
 Date : 2011/05/23
 Temperature/Humidity : 23 deg.C / 48 % RH
 Engineer: : Takeshi Choda
 Mode: : Tx 1395.025MHz

Polarity	Frequency [MHz]	Detector	Reading [dBuV]	Ant.Fac. [dB/m]	Loss [dB]	Gain [dB]	Result [dBuV/m]	Limit [dBuV/m]	Margin [dB]	Remark
Hori	2790.050	AV	31.4	28.5	3.8	32.4	31.3	54.0	22.7	
Hori	4185.075	AV	34.2	30.3	4.3	31.9	36.9	54.0	17.1	
Hori	5580.100	AV	38.7	32.4	5.5	32.0	44.6	54.0	9.4	
Hori	6975.125	AV	36.2	36.1	6.2	32.3	46.2	54.0	7.8	
Hori	8370.150	AV	33.8	36.8	6.7	32.7	44.6	54.0	9.4	
Hori	9765.175	AV	34.3	38.1	7.1	32.9	46.6	54.0	7.4	
Vert	2790.050	AV	31.3	28.5	3.8	32.4	31.2	54.0	22.8	
Vert	4185.075	AV	39.4	30.3	4.3	31.9	42.1	54.0	11.9	
Vert	5580.100	AV	39.1	32.4	5.5	32.0	45.0	54.0	9.0	
Vert	6975.125	AV	33.7	36.1	6.2	32.3	43.7	54.0	10.3	
Vert	8370.150	AV	33.8	36.8	6.7	32.7	44.6	54.0	9.4	
Vert	9765.175	AV	32.6	38.1	7.1	32.9	44.9	54.0	9.1	

Result = Reading + Ant Factor + Loss (Cable+Attenuator+Filter-Distance factor) - Gain(Amplifier)

HARMONICS AND TX SPURIOUS EMISSIONS ABOVE 960 MHz
1399.975MHz

Report No. : 31KE0332-HO
 Test Place : Head Office EMC Lab.
 Semi Anechoic Chamber: : No. 4
 Date : 2011/05/23
 Temperature/Humidity : 23 deg.C / 48 % RH
 Engineer: : Takeshi Choda
 Mode: : Tx 1399.975MHz

Polarity	Frequency [MHz]	Detector	Reading [dBuV]	Ant.Fac. [dB/m]	Loss [dB]	Gain [dB]	Result [dBuV/m]	Limit [dBuV/m]	Margin [dB]	Remark
Hori	2799.950	AV	31.8	27.7	3.7	32.4	30.8	54.0	23.2	
Hori	4199.925	AV	32.3	29.7	4.3	31.9	34.4	54.0	19.6	
Hori	5599.900	AV	37.9	32.1	5.5	32.0	43.5	54.0	10.5	
Hori	6999.875	AV	34.6	35.3	6.2	32.3	43.8	54.0	10.2	
Hori	8399.850	AV	33.6	36.5	6.7	32.7	44.1	54.0	9.9	
Hori	9799.825	AV	33.2	38.0	7.1	32.9	45.4	54.0	8.6	
Vert	2799.950	AV	31.3	27.7	3.7	32.4	30.3	54.0	23.7	
Vert	4199.925	AV	34.2	29.7	4.3	31.9	36.3	54.0	17.7	
Vert	5599.900	AV	32.1	32.1	5.5	32.0	37.7	54.0	16.3	
Vert	6999.875	AV	32.5	35.3	6.2	32.3	41.7	54.0	12.3	
Vert	8399.850	AV	33.1	36.5	6.7	32.7	43.6	54.0	10.4	
Vert	9799.825	AV	32.1	38.0	7.1	32.9	44.3	54.0	9.7	

Result = Reading + Ant Factor + Loss (Cable+Attenuator+Filter-Distance factor) - Gain(Amplifier)

**HARMONICS AND TX SPURIOUS EMISSIONS ABOVE 960 MHz
 1427.025MHz**

Report No. : 31KE0332-HO
 Test Place : Head Office EMC Lab.
 Semi Anechoic Chamber: : No. 4
 Date : 2011/05/23
 Temperature/Humidity : 23 deg.C / 48 % RH
 Engineer: : Takeshi Choda
 Mode: : Tx 1427.025MHz

Polarity	Frequency [MHz]	Detector	Reading [dBuV]	Ant.Fac. [dB/m]	Loss [dB]	Gain [dB]	Result [dBuV/m]	Limit [dBuV/m]	Margin [dB]	Remark
Hori	2854.050	AV	33.9	27.7	3.8	32.3	33.1	54.0	20.9	
Hori	4281.075	AV	31.2	29.7	4.4	31.9	33.4	54.0	20.6	
Hori	5708.100	AV	37.5	32.3	5.6	32.0	43.4	54.0	10.6	
Hori	7135.125	AV	32.6	35.6	6.3	32.3	42.2	54.0	11.8	
Hori	8562.150	AV	31.7	36.4	6.7	32.7	42.1	54.0	11.9	
Hori	9989.175	AV	30.9	38.3	7.1	32.9	43.4	54.0	10.6	
Vert	2854.050	AV	34.2	27.7	3.8	32.3	33.4	54.0	20.6	
Vert	4281.075	AV	29.9	29.7	4.4	31.9	32.1	54.0	21.9	
Vert	5708.100	AV	35.7	32.3	5.6	32.0	41.6	54.0	12.4	
Vert	7135.125	AV	32.3	35.6	6.3	32.3	41.9	54.0	12.1	
Vert	8562.150	AV	31.2	36.4	6.7	32.7	41.6	54.0	12.4	
Vert	9989.175	AV	30.6	38.3	7.1	32.9	43.1	54.0	10.9	

Result = Reading + Ant Factor + Loss (Cable+Attenuator+Filter-Distance factor) - Gain(Amplifier)

**HARMONICS AND TX SPURIOUS EMISSIONS ABOVE 960 MHz
 1431.975MHz**

Report No. : 31KE0332-HO
 Test Place : Head Office EMC Lab.
 Semi Anechoic Chamber: : No. 4
 Date : 2011/05/23
 Temperature/Humidity : 23 deg.C / 48 % RH
 Engineer: : Takeshi Choda
 Mode: : Tx 1431.975MHz

Polarity	Frequency [MHz]	Detector	Reading [dBuV]	Ant.Fac. [dB/m]	Loss [dB]	Gain [dB]	Result [dBuV/m]	Limit [dBuV/m]	Margin [dB]	Remark
Hori	2863.950	AV	34.5	27.7	3.8	32.3	33.7	54.0	20.3	
Hori	4295.925	AV	29.0	29.7	4.4	31.9	31.2	54.0	22.8	
Hori	5727.900	AV	33.2	32.4	5.6	32.0	39.2	54.0	14.8	
Hori	7159.875	AV	31.8	35.6	6.4	32.4	41.4	54.0	12.6	
Hori	8591.850	AV	31.5	36.5	6.7	32.7	42.0	54.0	12.0	
Vert	2863.950	AV	33.5	27.7	3.8	32.3	32.7	54.0	21.3	
Vert	4295.925	AV	29.6	29.7	4.4	31.9	31.8	54.0	22.2	
Vert	5727.900	AV	35.4	32.4	5.6	32.0	41.4	54.0	12.6	
Vert	7159.875	AV	30.6	35.6	6.4	32.4	40.2	54.0	13.8	
Vert	8591.850	AV	31.2	36.5	6.7	32.7	41.7	54.0	12.3	

Result = Reading + Ant Factor + Loss (Cable+Attenuator+Filter-Distance factor) - Gain(Amplifier)

[PLL Substitution model]

HARMONICS AND TX SPURIOUS EMISSIONS ABOVE 960 MHz
1395.025MHz

Report No. : 31KE0332-HO
 Test Place : Head Office EMC Lab.
 Semi Anechoic Chamber: : No. 4
 Date : 2011/07/01
 Temperature/Humidity : 22 deg.C / 62 % RH
 Engineer: : Katsunori Okai
 Mode: : Tx

Polarity	Frequency [MHz]	Detector	Reading [dBuV]	Ant.Fac. [dB/m]	Loss [dB]	Gain [dB]	Result [dBuV/m]	Limit [dBuV/m]	Margin [dB]	Remark
Hori	2790.050	AV	31.9	27.6	3.4	32.0	30.9	54.0	23.1	
Hori	4185.075	AV	42.4	30.3	3.5	31.5	44.7	54.0	9.3	
Hori	5580.100	AV	38.4	32.1	4.6	31.6	43.5	54.0	10.5	
Hori	6975.125	AV	41.0	35.3	5.1	32.3	49.1	54.0	4.9	
Hori	8370.150	AV	39.7	36.5	5.4	32.9	48.7	54.0	5.3	
Hori	9765.175	AV	33.6	38.0	6.0	33.2	44.4	54.0	9.6	
Vert	2790.050	AV	33.3	27.6	3.4	32.0	32.3	54.0	21.7	
Vert	4185.075	AV	39.8	29.6	4.2	31.6	42.0	54.0	12.0	
Vert	5580.100	AV	34.2	32.1	4.6	31.6	39.3	54.0	14.7	
Vert	6975.125	AV	35.5	35.3	5.1	32.3	43.6	54.0	10.4	
Vert	8370.150	AV	38.0	36.5	5.4	32.9	47.0	54.0	7.0	
Vert	9765.175	AV	31.9	38.0	6.0	33.2	42.7	54.0	11.3	

Result = Reading + Ant Factor + Loss (Cable+Attenuator+Filter-Distance factor(above 10GHz)) - Gain(Ampriifier)