



# SAR TEST REPORT

**Test Report No. : 11062800H-A-R1**

**Applicant** : NIHON KOHDEN CORPORATION  
**Type of Equipment** : cB-OWL253I-04-NK  
**Model No.** : cB-OWL253I-04-NK  
**FCC ID** : B6B0941  
**Test regulation** : FCC47CFR 2.1093  
**Test Result** : Complied  
**Reported SAR(1g) Value**      **The highest reported SAR(1g)**  
Body : 0.34 W/kg

1. This test report shall not be reproduced in full or partial, without the written approval of UL Japan, Inc.
2. The results in this report apply only to the sample tested.
3. This sample tested is in compliance with the limits of the above regulation.
4. The test results in this report are traceable to the national or international standards.
5. This test report must not be used by the customer to claim product certification, approval, or endorsement by NVLAP, NIST, or any agency of the Federal Government.
6. This test report covers SAR technical requirements. It does not cover administrative issues such as Manual or non-SAR test related Requirements. (if applicable)
7. This report is a revised version of 11062800H-A. 11062800H-A is replaced with this report.

**Date of test:** March 17 and 22, 2016

**Representative test engineer:** T. Nakagawa  
Tomohisa Nakagawa  
Engineer  
Consumer Technology Division

**Approved by :** Takayuki S.  
Takayuki Shimada  
Engineer  
Consumer Technology Division

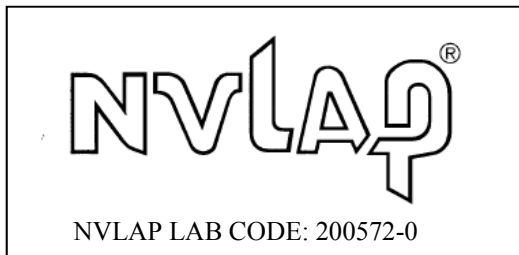

This laboratory is accredited by the NVLAP LAB CODE 200572-0, U.S.A. The tests reported herein have been performed in accordance with its terms of accreditation. \*As for the range of Accreditation in NVLAP, you may refer to the WEB address, [http://japan.ul.com/resources/emc\\_accredited/](http://japan.ul.com/resources/emc_accredited/)



<b>CONTENTS</b>	<b>PAGE</b>
<b>SECTION1: Customer information .....</b>	<b>4</b>
<b>SECTION2: Equipment under test (E.U.T.) .....</b>	<b>4</b>
2.1 Identification of E.U.T. ....	4
2.2 Product description .....	4
<b>SECTION3: Test standard information .....</b>	<b>5</b>
3.1 Test Specification .....	5
3.2 Procedure .....	5
3.3 Exposure limit.....	6
3.4 Test Location .....	6
<b>SECTION4: Test result .....</b>	<b>7</b>
4.1 Stand-alone SAR result.....	7
<b>SECTION5: RF Exposure Conditions (Test Configurations).....</b>	<b>8</b>
5.1 SAR test exclusion considerations according to KDB447498 D01 .....	8
5.2 Output Power and SAR test required.....	10
5.3 Procedure for SAR testing .....	13
5.4 Test position for Body setup.....	13
<b>SECTION6: Test surrounding.....</b>	<b>14</b>
6.1 Measurement uncertainty.....	14
<b>SECTION7: Parameter Check .....</b>	<b>16</b>
<b>SECTION8: System Check confirmation .....</b>	<b>18</b>
<b>SECTION9: SAR Test data for WLAN 2.4GHz .....</b>	<b>19</b>
9.1 Result of Body SAR .....	19
<b>SECTION10: SAR Test data for WLAN 5.2GHz .....</b>	<b>20</b>
10.1 Result of Body SAR.....	20
<b>SECTION11: SAR Test data for WLAN 5.6GHz .....</b>	<b>21</b>
11.1 Result of Body SAR.....	21
<b>SECTION12: SAR Test data for WLAN 5.8GHz .....</b>	<b>22</b>
12.1 Result of Body SAR.....	22
<b>SECTION13: Test instruments.....</b>	<b>23</b>
<b>APPENDIX 1 : SAR Measurement data.....</b>	<b>24</b>
<b>APPENDIX 2 : System Check .....</b>	<b>32</b>
<b>APPENDIX 3 : System specifications .....</b>	<b>40</b>
<b>APPENDIX 4 : Photographs of test setup .....</b>	<b>84</b>

**SECTION1: Customer information**

Company Name : NIHON KOHDEN CORPORATION  
Address : 1-31-4, NISHIOCHIAI SHINJUKU-KU TOKYO 161-8560, JAPAN  
Telephone Number : +81-3-5996-8066  
Facsimile Number : +81-3-5996-8327  
Contact Person : Yoshimoto Suzuki

**SECTION2: Equipment under test (E.U.T.)**

**2.1 Identification of E.U.T.**

**<Information of the EUT>**

Type of Equipment : cB-OWL253I-04-NK  
Model No. : cB-OWL253I-04-NK  
Serial No. : 00 12 F3 1F 79 56  
Rating : DC 5.0 V (DC 3.3 V to DC 5.5 V)  
Receipt Date of Sample : November 24, 2015  
Country of Mass-production : Japan  
Condition of EUT : Production model  
Modification of EUT : No Modification by the test lab

**2.2 Product description**

**General Specification**

Clock frequency(ies) : 32.468 kHz, 26 MHz, 40 MHz

**Radio Specification**

**WLAN (IEEE802.11b/g/n-20)**

Type of radio	IEEE802.11b	IEEE802.11g/n (20 M band)	IEEE802.11a/n (20 M band)
Frequency of operation (MHz)	2412 - 2462	2412 - 2462	5180 - 5240 5260 - 5320 5500 - 5700 5745 - 5825
Type of modulation	DSSS (CCK, DQPSK, DBPSK)	OFDM-CCK (64QAM, 16QAM, QPSK, BPSK)	OFDM (64QAM, 16QAM, QPSK, BPSK)
Channel spacing	5 MHz		20 MHz
Power supply	DC 3.3 V		
Antenna type	chip antenna		
Antenna Gain	3dBi		

**UL Japan, Inc.**

**Ise EMC Lab.**

4383-326 Asama-cho, Ise-shi, Mie-ken 516-0021 JAPAN  
Telephone: +81 596 24 8999  
Facsimile: +81 596 24 8124

### **SECTION3: Test standard information**

#### **3.1 Test Specification**

Title : **FCC47CFR 2.1093**  
Radiofrequency radiation exposure evaluation: portable devices.  
: **IEEE Std 1528-2013:**  
IEEE Recommended Practice for Determining the Peak Spatial-Average Specific Absorption Rate (SAR) in the Human Head from Wireless Communications Devices: Measurement Techniques.

: **Published RF exposure KDB procedures**

- KDB447498D01(v06)** Mobile and Portable Device RF Exposure Procedures and Equipment Authorization Policies
- KDB447498D02(v02r01)** SAR Measurement Procedures for USB Dongle Transmitters
- KDB648474D04(v01r03)** SAR Evaluation Considerations for Wireless Handsets
- KDB941225D01(v03r01)** 3G SAR MEASUREMENT PROCEDURES
- KDB941225D05(v02r05)** SAR for LTE Devices
- KDB941225D06(v02r01)** SAR test procedures for devices incorporating SAR Evaluation Procedures for Portable Devices with Wireless Router Capabilities (Hot Spot SAR)
- KDB941225D07(v01r02)** SAR Evaluation Procedures for UMPC Mini-Tablet Devices
- KDB616217D04(v01r02)** SAR Evaluation Considerations for Laptop, Notebook, Netbook and Tablet Computers
- KDB865664D01(v01r04)** SAR Measurement Requirements for 100MHz to 6 GHz
- KDB248227D01(v02r02)** SAR Measurement Procedures for 802.11(Wi-Fi) Transmitters

#### **Reference**

[1]SPEAG uncertainty document (AN 15-7/AN19-17) for DASY 5 System from SPEAG (Schmid & Partner Engineering AG).

#### **3.2 Procedure**

<b>Transmitter</b>	<b>WLAN</b>
<b>Test Procedure</b>	Published RF exposure KDB procedures
<b>Category</b>	FCC47CFR 2.1093
Note: UL Japan, Inc. 's SAR Work Procedures 13-EM-W0429 and 13-EM-W0430	

### 3.3 Exposure limit

(A) Limits for Occupational/Controlled Exposure (W/kg)

Spatial Average (averaged over the whole body)	Spatial Peak (averaged over any 1g of tissue)	Spatial Peak (hands/wrists/feet/ankles averaged over 10g)
0.4	8.0	20.0

(B) Limits for General population/Uncontrolled Exposure (W/kg)

Spatial Average (averaged over the whole body)	Spatial Peak (averaged over any 1g of tissue)	Spatial Peak (hands/wrists/feet/ankles averaged over 10g)
0.08	1.6	4.0

**Occupational/Controlled Environments:** are defined as locations where there is exposure that may be incurred by people who are aware of the potential for exposure, (i.e. as a result of employment or occupation).

**General Population/Uncontrolled Environments:** are defined as locations where there is the exposure of individuals who have no knowledge or control of their exposure.

**NOTE:GENERAL POPULATION/UNCONTROLLED EXPOSURE  
SPATIAL PEAK(averaged over any 1g of tissue) LIMIT  
1.6 W/kg**

### 3.4 Test Location

\*Shielded room for SAR testings

UL Japan, Inc. Ise EMC Lab. \*NVLAP Lab. code: 200572-0

4383-326 Asama-cho, Ise-shi, Mie-ken 516-0021 JAPAN

Telephone : +81 596 24 8999      Facsimile : +81 596 24 8124

---

**UL Japan, Inc.**

**Ise EMC Lab.**

4383-326 Asama-cho, Ise-shi, Mie-ken 516-0021 JAPAN

Telephone: +81 596 24 8999

Facsimile: +81 596 24 8124

**SECTION4: Test result**

**4.1 Stand-alone SAR result**

**Reported SAR**

Measured SAR is scaled to the maximum tune-up tolerance limit by the following formulas.

Reported SAR= Measured SAR [W/kg] · Scaled factor \*1

Maximum tune-up tolerance limit is by the specification from a customer.

**Body SAR**

Mode	Frequency [MHz]	Measured power [dBm]*2	Measured power [mW]	Maximum tune-up tolerance limit [dBm]*3	Maximum tune-up tolerance limit [mW]*3	Measured SAR [W/kg]	Scaled factor	Reported SAR [W/kg]
WLAN 11b (DTS : 2412 - 2462MHz band)	2412	13.63	23.07	14.00	25.12	0.056	1.089	<b>0.061</b>
WLAN 11a (UNII : 5180 - 5320MHz band)	5220	9.30	8.51	9.39	8.69	0.292	1.021	<b>0.298</b>
WLAN 11a (UNII : 5500 - 5700MHz band)	5500	9.53	8.97	9.54	8.99	0.336	1.002	<b>0.337</b>
WLAN 11a (UNII : 5745 - 5825MHz band)	5745	8.42	6.95	8.45	7.00	0.264	1.007	<b>0.266</b>

**Notes:**

1. Scaled factor = Maximum tune-up tolerance limit [mW] / Measured power [mW]
2. The sample used by the SAR test is within the tune-up tolerance but not more than 2 dB lower than the maximum tune-up tolerance limit.SAR maximum tune-up tolerance limit. That is, measured power is included the tune-up tolerance range.
3. Maximum tune-up tolerance limit is defined as maximum timed-average value. (Considering to maximum duty cycle of WLAN.)

**UL Japan, Inc.**

**Ise EMC Lab.**

4383-326 Asama-cho, Ise-shi, Mie-ken 516-0021 JAPAN

Telephone: +81 596 24 8999

Facsimile: +81 596 24 8124

**SECTION5: RF Exposure Conditions (Test Configurations)**

**5.1 SAR test exclusion considerations according to KDB447498 D01**

The following is based on KDB447498D01.

1) At 100 MHz to 6 GHz and for test separation distances < 50 mm, the SAR test exclusion threshold is determined according to the following.

SAR exclusion calculations for antenna <50mm from the user

Antenna	Tx Interface	Frequency (MHz)	Output Power		Separation Distances (mm)							Calculated Threshold Value					
			dBm	mW	Top tilt	Top	Bottom	Right	Left	Front	Rear	Top tilt	Top	Bottom	Right	Left	Front
Main	11b	2462	14.00	25	8.10	10.40	28.60	53.80	67.40	5.00	120.50	4.9	3.9	1.4	> 50 mm	> 50 mm	7.8
												-MEASURE-	-MEASURE-	-EXEMPT-			-MEASURE-
Main	11a	5240	9.39	9	8.10	10.40	28.60	53.80	67.40	5.00	120.50	2.6	2.1	0.7	> 50 mm	> 50 mm	4.1
												-EXEMPT-	-EXEMPT-	-EXEMPT-			-MEASURE-
Main	11a	5320	7.78	6	8.10	10.40	28.60	53.80	67.40	5.00	120.50	1.7	1.4	0.5	> 50 mm	> 50 mm	2.8
												-EXEMPT-	-EXEMPT-	-EXEMPT-			-EXEMPT-
Main	11a	5700	9.54	9	8.10	10.40	28.60	53.80	67.40	5.00	120.50	2.7	2.1	0.7	> 50 mm	> 50 mm	4.3
												-EXEMPT-	-EXEMPT-	-EXEMPT-			-MEASURE-
Main	11a	5825	8.45	7	8.10	10.40	28.60	53.80	67.40	5.00	120.50	2.1	1.7	0.6	> 50 mm	> 50 mm	3.4
												-EXEMPT-	-EXEMPT-	-EXEMPT-			-MEASURE-

**Notes:**

- The 1-g and 10-g SAR test exclusion thresholds for 100 MHz to 6 GHz at test separation distances ≤ 50 mm are determined by:  

$$[(\text{max. power of channel, including tune-up tolerance, mW}) / (\text{min. test separation distance, mm})] \cdot [\sqrt{f(\text{GHz})}] \leq 3.0$$
for 1-g SAR and ≤ 7.5 for 10-g extremity SAR.
- f(GHz) is the RF channel transmit frequency in GHz
- Power and distance are rounded to the nearest mW and mm before calculation
- The result is rounded to one decimal place for comparison
- The test exclusions are applicable only when the minimum test separation distance is ≤ 50 mm and for transmission frequencies between 100 MHz and 6 GHz. When the minimum test separation distance is < 5 mm, a distance of 5 mm is applied to determine SAR test exclusion.



2) At 100 MHz to 6 GHz and for test separation distances > 50 mm, the SAR test exclusion threshold is determined according to the following.

SAR exclusion calculations for antenna >50mm from the user

Antenna	Tx Interface	Frequency (MHz)	Output Power		Separation Distances (mm)							Calculated Threshold Value					
			dBm	mW	Top tilt	Top	Bottom	Right	Left	Front	Rear	Top tilt	Top	Bottom	Right	Left	Front
Main	11b	2462	14.00	25	8.10	10.40	28.60	53.80	67.40	5.00	120.50	< 50 mm	< 50 mm	< 50 mm	133.6 mW -EXEMPT-	269.6 mW -EXEMPT-	< 50 mm
Main	11a	5240	9.39	9	8.10	10.40	28.60	53.80	67.40	5.00	120.50	< 50 mm	< 50 mm	< 50 mm	103.5 mW -EXEMPT-	239.5 mW -EXEMPT-	< 50 mm
Main	11a	5320	7.78	6	8.10	10.40	28.60	53.80	67.40	5.00	120.50	< 50 mm	< 50 mm	< 50 mm	103 mW -EXEMPT-	239 mW -EXEMPT-	< 50 mm
Main	11a	5700	9.54	9	8.10	10.40	28.60	53.80	67.40	5.00	120.50	< 50 mm	< 50 mm	< 50 mm	100.8 mW -EXEMPT-	236.8 mW -EXEMPT-	< 50 mm
Main	11a	5825	8.45	7	8.10	10.40	28.60	53.80	67.40	5.00	120.50	< 50 mm	< 50 mm	< 50 mm	100.2 mW -EXEMPT-	236.2 mW -EXEMPT-	< 50 mm

**Notes:**

1. The upper frequency of the frequency band was used in order to calculate standalone SAR test exclusion considerations.
2. Based on KDB447498D01, minimum distance is 5mm. When the minimum test separation distance is < 5 mm, a distance of 5 mm is applied to determine SAR test exclusion and also § 4.1.5 if the antenna is at close proximity to user then the outer surface of the DUT should be treated as the radiating surface. The test separation distance is then determined by the smallest distance between the outer surface of the device and the user. For the purposes of this report close proximity has been defined as closer than 50 mm. For antennas <50 mm from the each edge the separation distance used for the SAR exclusion calculations is 0mm.
3. Maximum tune-up tolerance limit is by the specification from a customer.
4. Maximum tune-up tolerance limit(mW) is rounded to one decimal place.
5.  $[(3 \cdot 50) / (\sqrt{f(\text{GHz}})]) + (\text{test separation distance} - 50 \text{ mm}) \cdot (f(\text{MHz}) / 150)] \text{ mW}$  at > 100 MHz and ≤ 1500 MHz  
 $[(3 \cdot 50) / (\sqrt{f(\text{GHz}})]) + (\text{test separation distance} - 50 \text{ mm}) \cdot 10] \text{ mW}$  at > 1500 MHz and ≤ 6 GHz

## 5.2 Output Power and SAR test required

The initial test configuration for 2.4 GHz and 5 GHz OFDM transmission modes is determined by the 802.11 configuration with the highest maximum output power specified for production units, including tune-up tolerance, in each standalone and aggregated frequency band. SAR for the initial test configuration is measured using the highest maximum output power channel determined by the default power measurement procedures. When multiple configurations in a frequency band have the same specified maximum output power, the initial test configuration is determined according to the following steps applied sequentially.

1. The largest channel bandwidth configuration is selected among the multiple configurations with the same specified maximum output power.
2. If multiple configurations have the same specified maximum output power and largest channel bandwidth, the lowest order modulation among the largest channel bandwidth configurations is selected.
3. If multiple configurations have the same specified maximum output power, largest channel bandwidth and lowest order modulation, the lowest data rate configuration among these configurations is selected.
4. When multiple transmission modes (802.11a/g/n/ac) have the same specified maximum output power, largest channel bandwidth, lowest order modulation and lowest data rate, the lowest order 802.11 mode is selected; i.e., 802.11a is chosen over 802.11n then 802.11ac or 802.11g is chosen over 802.11n.

### 5.2.1 Wi-Fi 2.4GHz (DTS Band)

Band (GHz)	Mode	Data Rate	Ch #	Freq. (MHz)	Measured average Power (dBm)	Tune-up upper Power (dBm)	SAR Test (Yes/No)	Note(s)	setting
2.4	802.11b	1 Mbps	1	2412	13.63	14.0	Yes	2	77
			6	2437	13.61				77
			11	2462	13.23				77
	802.11g	6 Mbps	1	2412	5.20	5.5	No	1	53
			6	2437	5.21				53
			11	2462	4.44				53
	802.11n (HT20)	6.5 Mbps	1	2412	5.15	5.5	No	1	53
			6	2437	5.08				53
			11	2462	4.68				53

#### Note(s):

1. According to KDB248227D01, SAR is not required for 802.11g/n HT20 channels when the highest reported SAR for DSSS is adjusted by the ratio of OFDM to DSSS specified maximum output power and the adjusted SAR is  $\leq 1.2$  W/kg.
2. SAR test channel was chosen according to KDB248227D01. (shaded blue frame)

### 5.2.2 Wi-Fi 5GHz (U-NII-1 and U-NII-2A Bands)

Band (GHz)	Mode	Data Rate	Ch #	Freq. (MHz)	Measured average Power (dBm)	Tune-up upper Power (dBm)	SAR Test (Yes/No)	Note(s)	setting
5.2 (U-NII-1)	802.11a	6 Mbps	36	5180	9.28	9.39	Yes	3	90
			40	5200	9.30				90
			44	5220	9.30				89
			48	5240	9.29				88
	802.11n (HT20)	6.5 Mbps	36	5180	9.38	9.39	No	1	90
			40	5200	9.36				89
			44	5220	9.38				89
			48	5240	9.30				87
5.3 (U-NII-2A)	802.11a	6 Mbps	52	5260	7.54	7.78	No	1,2	81
			56	5280	7.69				81
			60	5300	7.67				80
			64	5320	7.59				79
	802.11n (HT20)	6.5 Mbps	52	5260	7.61	7.78	No	1,2	80
			56	5280	7.69				80
			60	5300	7.68				79
			64	5320	7.54				78

#### Note(s):

- When the same transmission mode configurations have the same maximum output power on the same channel for the 802.11 a/g/n/ac modes, the channel with the largest bandwidth and lowest data rate is selected (i.e. 802.11ac VHT80).
- When different maximum output power is specified for the bands, begin SAR measurement in the band with higher specified maximum output power. The highest reported SAR for the tested configuration is adjusted by the ratio of lower to higher specified maximum output power for the two bands.  
When the adjusted SAR is  $\leq 1.2$  W/kg, SAR is not required for the band with lower maximum output power in that test configuration; otherwise, each band is tested independently for SAR.
- SAR test channel was chosen according to KDB248227D01. (shaded blue frame)

### 5.2.3 Wi-Fi 5GHz (U-NII-2C Band)

Mode	Data Rate	Ch #	Freq. (MHz)	Measured average Power (dBm)	Tune-up upper Power (dBm)	SAR Test (Yes/No)	Note(s)	setting
802.11a	6 Mbps	100	5500	9.53	9.54	Yes	1,2	85
		120	5600	9.51				88
		140	5700	9.24				89
802.11n (HT20)	6.5 Mbps	100	5500	9.53	9.54	No	1	85
		120	5600	9.45				87
		140	5700	9.48				89

#### Note(s):

- When the same transmission mode configurations have the same maximum output power on the same channel for the 802.11 a/g/n/ac modes, the channel with the largest bandwidth and lowest data rate is selected (i.e. 802.11ac VHT80).
- SAR test channel was chosen according to KDB248227D01. (shaded blue frame)

### 5.2.4 Wi-Fi 5GHz (U-NII-3 Band)

Band (GHz)	Mode	Data Rate	Ch #	Freq. (MHz)	Measured average Power (dBm)	Tune-up upper	SAR Test (Yes/No)	Note(s)	setting
5.8 (U-NII-3)	802.11a	6 Mbps	149	5745	8.42	8.45	Yes	1,2	89
			157	5785	8.21				90
			165	5825	8.39				92
	802.11n (HT20)	6.5 Mbps	149	5745	8.42	8.45	No	1,2	88
			157	5785	8.31				89
			165	5825	8.30				93

#### Note(s):

- When the same transmission mode configurations have the same maximum output power on the same channel for the 802.11 a/g/n/ac modes, the channel with the largest bandwidth and lowest data rate is selected (i.e. 802.11ac VHT80).
- SAR test channel was chosen according to KDB248227D01. (shaded blue frame)

#### Software information

\*The power value of the EUT was set for testing as follows (setting value might be different from product specification value);

- Power Setting: Refer to the each power measurements table.

- Software: cb-OWL221a/cb-OWS451 PCI Tool Version 4.1.2

\*This setting of software is the worst case.

Any conditions under the normal use do not exceed the condition of setting.

In addition, end users cannot change the settings of the output power of the product.

### **5.3 Procedure for SAR testing**

-The tested procedure was performed according to the KDB 447498 D01 (Mobile and Portable Device RF Exposure Procedures and Equipment Authorization Policies)and the KDB 616217 D04.

### **5.4 Test position for Body setup**

No.	Position	Test distance	WLAN
			Tested
1	Front	0mm	<input checked="" type="checkbox"/>
2	Rear	0mm	<input type="checkbox"/>
3	Left	0mm	<input type="checkbox"/>
4	Right	0mm	<input type="checkbox"/>
5	Top	0mm	<input checked="" type="checkbox"/> tested only 2.4GHz band
6	Top tilt	0mm	<input checked="" type="checkbox"/> tested only 2.4GHz band
7	Bottom	0mm	<input type="checkbox"/>

**SECTION6: Test surrounding**

**6.1 Measurement uncertainty**

This measurement uncertainty budget is suggested by IEEE Std 1528(2013) and IEC62209-2:2010, and determined by Schmid & Partner Engineering AG (DASY5 Uncertainty Budget). Per KDB 865664 D01 SAR Measurement 100 MHz to 6 GHz v01r01 Section 2.8.1., when the highest measured SAR(1g) within a frequency band is < 1.5W/kg, the extensive SAR measurement uncertainty analysis described in IEEE Std.1528 (2013) is not required in SAR reports submitted for equipment approval.

<0.3 – 3GHz range Body>

Error Description	Uncertai value ±	Probability distribution	divisor	(ci) 1g	Standard (1g)
<b>Measurement System</b>					
Probe calibration	± 6.00	Normal	1	1	± 6.00
Axial isotropy of the probe	± 4.7	Rectangular	√3	0.7	± 1.9
Spherical isotropy of the probe	± 9.6	Rectangular	√3	0.7	± 3.9
Boundary effects	± 1.0	Rectangular	√3	1	± 0.6
Probe linearity	± 4.7	Rectangular	√3	1	± 2.7
Detection limit	± 1.0	Rectangular	√3	1	± 0.6
Modulation response	± 2.4	Rectangular	√3	1	± 1.4
Readout electronics	± 0.3	Normal	1	1	± 0.3
Response time	± 0.8	Rectangular	√3	1	± 0.5
Integration time	± 2.6	Rectangular	√3	1	± 1.5
RF ambient Noise	± 3.0	Rectangular	√3	1	± 1.7
RF ambient Reflections	± 3.0	Rectangular	√3	1	± 1.7
Probe Positioner	± 0.4	Rectangular	√3	1	± 0.2
Probe positioning	± 2.9	Rectangular	√3	1	± 1.7
MaxSAR Eval.	± 2.0	Rectangular	√3	1	± 1.2
<b>Test Sample Related</b>					
Device positioning	± 2.9	Normal	1	1	± 2.9
Device holder uncertainty	± 3.6	Normal	1	1	± 3.6
Power drift	± 5.0	Rectangular	√3	1	± 2.9
Power Scaling	+ 0.0	Rectangular	√3	1	± 0.0
<b>Phantom and Setup</b>					
Phantom uncertainty	± 6.1	Rectangular	√3	1	± 3.5
Algorithm for correcting SAR for deviations in permittivity and conductivity	± 1.9	Normal	1	1	± 1.9
Liquid conductivity (meas.)	+ 0.5	Rectangular	1	0.78	+ 0.4
Liquid permittivity (meas.)	- 4.4	Rectangular	1	0.23	- 1.0
Liquid conductivity - temp.unc (below 2deg.C.)	± 5.2	Rectangular	√3	0.78	± 2.3
Liquid permittivity - temp.unc (below 2deg.C.)	± 0.8	Rectangular	√3	0.23	± 0.1
<b>Combined Standard Uncertainty</b>					± <b>11.313</b>
<b>Expanded Uncertainty (k=2)</b>					± <b>22.6</b>

\*. Table of uncertainties are listed for ISO/IEC 17025.

**UL Japan, Inc.**

**Ise EMC Lab.**

4383-326 Asama-cho, Ise-shi, Mie-ken 516-0021 JAPAN

Telephone: +81 596 24 8999

Facsimile: +81 596 24 8124

<3 – 6GHz range Body >

Error Description	Uncertain value ±	Probability distribution	divisor	(ci) 1g	Standard (1g)
<b>Measurement System</b>					
Probe calibration	± 6.55	Normal	1	1	± 6.55
Axial isotropy of the probe	± 4.7	Rectangular	√3	0.7	± 1.9
Spherical isotropy of the probe	± 9.6	Rectangular	√3	0.7	± 3.9
Boundary effects	± 2.0	Rectangular	√3	1	± 1.2
Probe linearity	± 4.7	Rectangular	√3	1	± 2.7
Detection limit	± 1.0	Rectangular	√3	1	± 0.6
Modulation response	± 2.4	Rectangular	√3	1	± 1.4
Readout electronics	± 0.3	Normal	1	1	± 0.3
Response time	± 0.8	Rectangular	√3	1	± 0.5
Integration time	± 2.6	Rectangular	√3	1	± 1.5
RF ambient Noise	± 3.0	Rectangular	√3	1	± 1.7
RF ambient Reflections	± 3.0	Rectangular	√3	1	± 1.7
Probe Positioner	± 0.8	Rectangular	√3	1	± 0.5
Probe positioning	± 6.7	Rectangular	√3	1	± 3.9
MaxSAR Eval.	± 4.0	Rectangular	√3	1	± 2.3
<b>Test Sample Related</b>					
Device positioning	± 2.9	Normal	1	1	± 2.9
Device holder uncertainty	± 3.6	Normal	1	1	± 3.6
Power drift	± 5.0	Rectangular	√3	1	± 2.9
Power Scaling	+ 0.0	Rectangular	√3	1	± 0.0
<b>Phantom and Setup</b>					
Phantom uncertainty	± 6.6	Rectangular	√3	1	± 3.8
Algorithm for correcting SAR for deviations in permittivity and conductivity	± 1.9	Normal	1	1	± 1.9
Liquid conductivity (meas.)	+ 3.9	Rectangular	1	0.78	+ 3.0
Liquid permittivity (meas.)	- 2.0	Rectangular	1	0.23	- 0.5
Liquid conductivity - temp.unc (below 2deg.C.)	± 2.4	Rectangular	√3	0.78	± 1.1
Liquid permittivity - temp.unc (below 2deg.C.)	± 0.8	Rectangular	√3	0.23	± 0.1
<b>Combined Standard Uncertainty</b>					± <b>12.583</b>
<b>Expanded Uncertainty (k=2)</b>					± <b>25.2</b>

\*.Table of uncertainties are listed for ISO/IEC 17025.

**UL Japan, Inc.**

**Ise EMC Lab.**

4383-326 Asama-cho, Ise-shi, Mie-ken 516-0021 JAPAN

Telephone: +81 596 24 8999

Facsimile: +81 596 24 8124

**SECTION7: Parameter Check**

The dielectric parameters were checked prior to assessment using the DAK dielectric probe kit. The dielectric parameters measurement is reported in each correspondent section.

According to KDB865664 D01, +/- 5% tolerances are required for  $\epsilon_r$  and  $\sigma$  and then below table which is the target value of the simulated tissue liquid is quoted from KDB865664 D01.

Target Frequency (MHz)	Head		Body	
	$\epsilon_r$	$\sigma$ (S/m)	$\epsilon_r$	$\sigma$ (S/m)
150	52.3	0.76	61.9	0.80
300	45.3	0.87	58.2	0.92
450	43.5	0.87	56.7	0.94
835	41.5	0.90	55.2	0.97
900	41.5	0.97	55.0	1.05
915	41.5	0.98	55.0	1.06
1450	40.5	1.20	54.0	1.30
1610	40.3	1.29	53.8	1.40
1800 – 2000	40.0	1.40	53.3	1.52
2450	39.2	1.80	52.7	1.95
3000	38.5	2.40	52.0	2.73
5800	35.3	5.27	48.2	6.00

( $\epsilon_r$  = relative permittivity,  $\sigma$  = conductivity and  $\rho = 1000 \text{ kg/m}^3$ )

DIELECTRIC PARAMETERS MEASUREMENT RESULTS											
Date	Ambient Temp. [deg.c]	Relative Humidity [%]	Liquid type	Liquid Temp. [deg.c]	Measured Frequency [MHz]	Parameters	Target Value*1	Measured	Deviation [%]	Limit [%]	Remark
17-Mar	24.0	45	MSL2450	23.5	2450	$\epsilon_r$	52.7	50.3	-4.6	+/-5	*1
						$\sigma$ [mho/m]	1.95	1.97	1.2	+/-5	
17-Mar	24.0	45	MSL2450	23.5	2412	$\epsilon_r$	52.8	50.4	-4.4	+/-5	*2
						$\sigma$ [mho/m]	1.91	1.92	0.5	+/-5	
18-Mar	24.0	45	MBBL3500-5800	23.5	5250	$\epsilon_r$	48.9	48.1	-1.8	+/-5	*2
						$\sigma$ [mho/m]	5.36	5.36	0.0	+/-5	
18-Mar	24.0	45	MBBL3500-5800	23.5	5180	$\epsilon_r$	49.0	48.1	-2.0	+/-5	*2
						$\sigma$ [mho/m]	5.28	5.30	0.4	+/-5	
18-Mar	24.0	45	MBBL3500-5800	23.5	5600	$\epsilon_r$	48.5	47.6	-1.7	+/-5	*2
						$\sigma$ [mho/m]	5.77	5.70	-1.1	+/-5	
18-Mar	24.0	35	MBBL3500-5800	23.5	5500	$\epsilon_r$	48.6	47.9	-1.4	+/-5	*2
						$\sigma$ [mho/m]	5.65	5.62	-0.6	+/-5	
22-Mar	24.0	35	MBBL3500-5800	23.5	5750	$\epsilon_r$	48.3	47.5	-1.5	+/-5	*2
						$\sigma$ [mho/m]	5.94	6.17	3.9	+/-5	
22-Mar	24.0	45	MBBL3500-5800	23.5	5745	$\epsilon_r$	48.3	47.6	-1.5	+/-5	*2
						$\sigma$ [mho/m]	5.94	6.17	3.9	+/-5	

$\epsilon_r$ : Relative Permittivity /  $\sigma$ : Conductivity

\*1 The Target value is a parameter defined in KDB 865664D01.

\*2 The dielectric parameters should be linearly interpolated between the closest pair of target frequencies to determine the applicable dielectric parameters corresponding to the device test frequency.

Shaded cells are used for system check.

**UL Japan, Inc.**

**Ise EMC Lab.**

4383-326 Asama-cho, Ise-shi, Mie-ken 516-0021 JAPAN

Telephone: +81 596 24 8999

Facsimile: +81 596 24 8124



**Correlation confirmation with measured TSL parameters of the calibration certificate of system validation dipoles (Refer to Appendix 2)**

+/- 6% limit for deviation provided by manufacture tolerances are required for  $\epsilon_r$  and  $\sigma$  and then below table which is the target value of the simulated tissue liquid is quoted from data measured TSL parameters of dipole calibration.

Freq [MHz]	Model, S/N, Frequency	Body	
		$\epsilon_r$	$\sigma$ [mho/m]
2450	D2450,713 2450 MHz	52.2	2
5250	D5GHV2,1020 5250 MHz	47.0	5.44
5600	D5GHV2,1020 5600 MHz	46.4	5.91
5750	D5GHV2,1020 5750 MHz	46.1	6.12

$\epsilon_r$ : Relative Permittivity /  $\sigma$ : Conductivity

DIELECTRIC PARAMETERS MEASUREMENT RESULTS											
Date	Ambient Temp. [deg.c]	Relative Humidity [%]	Liquid type	Liquid Temp. [deg.c]	Measured Frequency [MHz]	Parameters	Target Value*1	Measured	Deviation [%]	Limit [%]	Remark
17-Mar	24.0	45	MSL2450	23.5	2450	$\epsilon_r$	52.2	50.3	-3.7	+/-6	
						$\sigma$ [mho/m]	2.00	1.97	-1.3	+/-6	
18-Mar	24.0	45	MBBL3500 - 5800	23.5	5250	$\epsilon_r$	47.0	48.1	2.3	+/-6	
						$\sigma$ [mho/m]	5.44	5.36	-1.5	+/-6	
18-Mar	24.0	45	MBBL3500 - 5800	23.5	5600	$\epsilon_r$	46.4	47.6	2.7	+/-6	
						$\sigma$ [mho/m]	5.91	5.70	-3.5	+/-6	
22-Mar	24.0	35	MBBL3500 - 5800	23.5	5750	$\epsilon_r$	46.1	47.5	3.1	+/-6	
						$\sigma$ [mho/m]	6.12	6.17	0.8	+/-6	

\*1 The Target value is a parameter defined in each dipole calibrated certificate.

**SECTION8: System Check confirmation**

The measurements were performed in the flat section of the TWIN SAM or ELI phantom, shell thickness: 2.0 ±0.2 mm (bottom plate) filled with Body or Head simulating liquid of the following parameters.

The depth of tissue-equivalent liquid in a phantom must be ≥ 15.0 cm ± 0.5 cm for SAR measurements ≤ 3 GHz and ≥ 10.0 cm ± 0.5 cm for measurements > 3 GHz.

The DASY system with an E-Field Probe was used for the measurements.

The dipole was mounted on the small tripod so that the dipole feed point was positioned below the center marking of the flat phantom section and the dipole was oriented parallel to the body axis (the long side of the phantom).

The standard measuring distance was 10 mm (above 1GHz to 6GHz) and 15 mm (below 1GHz) from dipole center to the simulating liquid surface.

The coarse grid with a grid spacing of 12 mm (1GHz to 3GHz) and 15 mm (below 1GHz) was aligned with the dipole.

For 5 GHz band - The coarse grid with a grid spacing of 10 mm was aligned with the dipole.

Special 7x7x7 (below 3 GHz) and/or 8x8x7 (above 3 GHz) fine cube was chosen for the cube.

Distance between probe sensors and phantom surface was set to 3 mm.

For 5 GHz band - Distance between probe sensors and phantom surface was set to 2.5 mm

The dipole input power (forward power) was 100 mW(For 5GHz band) or 250 mW(For other band).

The results are normalized to 1 W input power.

Freq [MHz]	Model, S/N, Frequency	Body *1	
		(SPEAG) 1g [W/kg]	(SPEAG) 10g[W/kg]
2450	D2450,713 2450 MHz	50.4	23.56
5250	D5GHV2,1020 5250 MHz	73.6	20.9
5600	D5GHV2,1020 5600 MHz	78.2	22.1
5750	D5GHV2,1020 5750 MHz	73.9	20.7

\*1 The target (reference) SAR values can be obtained from the calibration certificate of system validation dipoles (Refer to Appendix 3). The target SAR values are SAR measured value in the calibration certificate scaled to 1W.

Date Tested	Model,S/N,Frequency	T.S. Liquid		Measured Results		Target (Ref. Value)	Delta ±10 %
				Zoom Scan	Normalize to 1 W		
3/17/2016	D2450,713_2450 MHz	Body	(SPEAG) 1g [W/kg]	13.00	52.0	50.40	3.17
			(SPEAG) 10g[W/kg]	6.06	24.24	23.56	2.89
3/18/2016	D5GHV2,1020_5250 MHz	Body	(SPEAG) 1g [W/kg]	7.44	74.4	73.60	1.09
			(SPEAG) 10g[W/kg]	2.09	20.9	20.90	0.00
3/18/2016	D5GHV2,1020_5600 MHz	Body	(SPEAG) 1g [W/kg]	7.76	77.6	78.20	-0.77
			(SPEAG) 10g[W/kg]	2.14	21.4	22.10	-3.17
3/22/2016	D5GHV2,1020_5750 MHz	Body	(SPEAG) 1g [W/kg]	7.08	70.8	73.90	-4.19
			(SPEAG) 10g[W/kg]	1.97	19.7	20.70	-4.83

**UL Japan, Inc.**

**Ise EMC Lab.**

4383-326 Asama-cho, Ise-shi, Mie-ken 516-0021 JAPAN

Telephone: +81 596 24 8999

Facsimile: +81 596 24 8124

**SECTION9: SAR Test data for WLAN 2.4GHz**

**9.1 Result of Body SAR**

Test Position	Mode	Dist. (mm)	Ch #.	Freq. (MHz)	Power (dBm)		Scaled factor	1-g SAR (W/kg)	
					Tune-up limit	Meas.		Meas.	Scaled
Front	802.11b	0	1	2412	14.00	13.63	1.09	0.042	0.046
			6	2437	14.00	13.61	1.09		
			11	2462	14.00	13.23	1.19		
Top	802.11b	0	1	2412	14.00	13.63	1.09	0.038	0.041
			6	2437	14.00	13.61	1.09		
			11	2462	14.00	13.23	1.19		
Top tilt	802.11b	0	1	2412	14.00	13.63	1.09	0.056	0.061
			6	2437	14.00	13.61	1.09		
			11	2462	14.00	13.23	1.19		

**Note(s):**

- Highest reported SAR is  $\leq 0.4$  W/kg. Therefore, further SAR measurements within this exposure condition are not required.
- Highest reported SAR is  $> 0.4$  W/kg. Due to the highest reported SAR for this test position, other test positions in standalone exposure condition were evaluated until a SAR  $\leq 0.8$  W/kg was reported.
- For all positions/configurations tested using the initial test position and subsequent test positions, when the reported SAR is  $> 0.8$  W/kg, measure the SAR for these positions/configurations on the subsequent next highest measured output power channel(s) until the reported SAR is  $\leq 1.2$  W/kg or all required test channels are considered.
- Scaled factor = Maximum tune-up tolerance limit [mW] / Measured power [mW]
- Reported SAR= Measured SAR [W/kg] · Scaled factor

**OFDM was excluded from the following table according to KDB248227D01.**

Maximum tune-up tolerance limit DSSS		Maximum tune-up tolerance limit OFDM		OFDM scaled	Position	DSSS Reported SAR value [W/kg]	OFDM Estimated SAR value [W/kg] *4	Exclusion limit [W/kg]	Standalone SAR tested
[dBm]	[mW]	[dBm]	[mW]						
14.00	25.12	5.50	3.55	0.141	Top	0.056	0.008	< 1.2	No

**Notes:**

- Scaled factor = Maximum tune-up tolerance limit [mW] / Measured power [mW]
- Reported SAR= Measured SAR [W/kg] · Scaled factor
- OFDM scaled factor = Maximum tune-up tolerance limit of OFDM [mW] / Maximum tune-up tolerance limit of DSSS [mW]
- Estimated SAR of OFDM= Reported SAR of DSSS[W/kg] · OFDM scaled factor

**UL Japan, Inc.**

**Ise EMC Lab.**

4383-326 Asama-cho, Ise-shi, Mie-ken 516-0021 JAPAN

Telephone: +81 596 24 8999

Facsimile: +81 596 24 8124

**SECTION10: SAR Test data for WLAN 5.2GHz**

**10.1 Result of Body SAR**

Test Position	Mode	Dist. (mm)	Ch #.	Freq. (MHz)	Power (dBm)		Scaled factor	1-g SAR (W/kg)	
					Tune-up limit	Meas.		Meas.	Scaled
Front	802.11a	0	36	5180	9.39	9.28	1.03		
			40	5200	9.39	9.30	1.02		
			44	5220	9.39	9.30	1.02	0.292	0.298
			48	5240	9.39	9.29	1.02		

**Note(s):**

- Highest reported SAR is  $\leq 0.4$  W/kg. Therefore, further SAR measurements within this exposure condition are not required.
- Highest reported SAR is  $> 0.4$  W/kg. Due to the highest reported SAR for this test position, other test positions in standalone exposure condition were evaluated until a SAR  $\leq 0.8$  W/kg was reported.
- For all positions/configurations tested using the initial test position and subsequent test positions, when the reported SAR is  $> 0.8$  W/kg, measure the SAR for these positions/configurations on the subsequent next highest measured output power channel(s) until the reported SAR is  $\leq 1.2$  W/kg or all required test channels are considered.
- Scaled factor = Maximum tune-up tolerance limit [mW] / Measured power [mW]
- Reported SAR = Measured SAR [W/kg] · Scaled factor

**5.3GHz was excluded from the following table according to KDB248227D01.**

Maximum tune-up tolerance limit 5.2GHz		Maximum tune-up tolerance limit 5.3GHz		scaled factor	Position	5.2GHz Reported SAR value [W/kg]	5.3GHz Estimated SAR value [W/kg] *4	Exclusion limit [W/kg]	Standalone SAR tested
[dBm]	[mW]	[dBm]	[mW]						
9.39	8.69	7.78	6.00	0.690	Front	0.298	0.206	< 1.2	No

**Notes:**

- Scaled factor = Maximum tune-up tolerance limit [mW] at 5.3GHz / Maximum tune-up tolerance limit [mW] at 5.2GHz.
- 5.3GHz Estimated SAR value = 5.2GHz Reported SAR value [W/kg] · Scaled factor

**UL Japan, Inc.**

**Ise EMC Lab.**

4383-326 Asama-cho, Ise-shi, Mie-ken 516-0021 JAPAN

Telephone: +81 596 24 8999

Facsimile: +81 596 24 8124

**SECTION11: SAR Test data for WLAN 5.6GHz**

**11.1 Result of Body SAR**

Test Position	Mode	Dist. (mm)	Ch #.	Freq. (MHz)	Power (dBm)		Scaled factor	1-g SAR (W/kg)	
					Tune-up limit	Meas.		Meas.	Scaled
Front	802.11a	0	100	5500	9.54	9.53	1.003	0.336	0.337
			120	5600	9.54	9.51	1.008		
			140	5700	9.54	9.24	1.072		

**Note(s):**

- Highest reported SAR is  $\leq 0.4$  W/kg. Therefore, further SAR measurements within this exposure condition are not required.
- Highest reported SAR is  $> 0.4$  W/kg. Due to the highest reported SAR for this test position, other test positions in standalone exposure condition were evaluated until a SAR  $\leq 0.8$  W/kg was reported.
- For all positions/configurations tested using the initial test position and subsequent test positions, when the reported SAR is  $> 0.8$  W/kg, measure the SAR for these positions/configurations on the subsequent next highest measured output power channel(s) until the reported SAR is  $\leq 1.2$  W/kg or all required test channels are considered.
- Scaled factor = Maximum tune-up tolerance limit [mW] / Measured power [mW]
- Reported SAR = Measured SAR [W/kg] · Scaled factor

**UL Japan, Inc.**

**Ise EMC Lab.**

4383-326 Asama-cho, Ise-shi, Mie-ken 516-0021 JAPAN

Telephone: +81 596 24 8999

Facsimile: +81 596 24 8124

**SECTION12: SAR Test data for WLAN 5.8GHz**

**12.1 Result of Body SAR**

Test Position	Mode	Dist. (mm)	Ch #.	Freq. (MHz)	Power (dBm)		Scaled factor	1-g SAR (W/kg)	
					Tune-up limit	Meas.		Meas.	Scaled
Front	802.11a	0	149	5745	8.45	8.42	1.01	0.264	0.266
			157	5785	8.45	8.21	1.06		
			165	5825	8.45	8.39	1.01		

**Note(s):**

- Highest reported SAR is  $\leq 0.4$  W/kg. Therefore, further SAR measurements within this exposure condition are not required.
- Highest reported SAR is  $> 0.4$  W/kg. Due to the highest reported SAR for this test position, other test positions in standalone exposure condition were evaluated until a SAR  $\leq 0.8$  W/kg was reported.
- For all positions/configurations tested using the initial test position and subsequent test positions, when the reported SAR is  $> 0.8$  W/kg, measure the SAR for these positions/configurations on the subsequent next highest measured output power channel(s) until the reported SAR is  $\leq 1.2$  W/kg or all required test channels are considered.

**UL Japan, Inc.**

**Ise EMC Lab.**

4383-326 Asama-cho, Ise-shi, Mie-ken 516-0021 JAPAN

Telephone: +81 596 24 8999

Facsimile: +81 596 24 8124

**SECTION13: Test instruments**

Control No.	Instrument	Manufacturer	Model No	Serial No	Test Item	Calibration Date * Interval(month)
MNA-03	Vector Reflectometer	Copper Mountain Technologies	PLANAR R140	0030913	SAR	2015/10/30 * 12
MDPK-03	Dielectric assessment kit	Schmid&Partner Engineering AG	DAK-3.5	0008	SAR	2015/03/10 * 12
MOS-37	Digital thermometer	LKM electronic	DTM3000	-	SAR	2015/07/07 * 12
COTS-MSAR-04	Dielectric assessment software	Schmid&Partner Engineering AG	DAK		SAR	-
MPM-11	Dual Power Meter	Agilent	E4419B	MY45102060	SAR	2015/08/04 * 12
MPSE-15	Power sensor	Agilent	E9301A	MY41498311	SAR	2015/08/04 * 12
MPSE-16	Power sensor	Agilent	E9301A	MY41498313	SAR	2015/08/04 * 12
MRFA-24	Pre Amplifier	R&K	R&K CGA020M602-2633R	B30550	SAR	2015/06/15 * 12
MSG-10	Signal Generator	Agilent	N5181A	MY47421098	SAR	2015/11/16 * 12
MAT-78	Attenuator	Telegrafartner	J01156A0011	0042294119	SAR	Pre Check
MPM-15	Power Meter	Agilent	N1914A	MY53060017	SAR	2015/06/15 * 12
MPSE-21	Power sensor	Agilent	N8482H	MY52460010	SAR	2015/06/15 * 12
MHDC-21	Dual Directional Coupler	Agilent	778D	MY52180243	SAR(0.1-2GHz)	Pre Check
MHDC-12	Dual Directional Coupler	Hewlett Packard	772D	2839A0016	SAR(2-18GHz)	Pre Check
MDA-07	Dipole Antenna	Schmid&Partner Engineering AG	D2450V2	713	SAR(D2450)	2013/09/10 * 36
MMSL2450	Tissue simulation liquid (Body)	Schmid&Partner Engineering AG	MSL2450V2	SL AA 245 BA	SAR*Daily Check Target Value $\pm 5\%$	Pre Check
MDA-08	Dipole Antenna	Schmid&Partner Engineering AG	D5GHzV2	1020	SAR(D5G)	2016/01/20 * 12
MMBBL3.5-5.8	Tissue simulation liquid (Body)	Schmid&Partner Engineering AG	MBBL3500-5800V5	SL AAM 501 DA	SAR*Daily Check Target Value $\pm 5\%$	Pre Check
MDAE-01	Data Acquisition Electronics	Schmid&Partner Engineering AG	DAE4	509	SAR	2015/07/07 * 12
MPB-07	Dosimetric E-Field Probe	Schmid&Partner Engineering AG	EX3DV4	3825	SAR	2015/12/11 * 12
MPF-02	2mm Oval Flat Phantom	Schmid&Partner Engineering AG	QDOVA001BB	1045	SAR	2015/05/11 * 12
MDH-01	Device holder	Schmid&Partner Engineering AG	Mounting device for transmitter	-	SAR	Pre Check
MOS-26	Thermo-Hygrometer	CUSTOM	CTH-201	A08Q29	SAR	2015/04/28 * 12
COTS-MSAR-03	Dasy5	Schmid&Partner Engineering AG	DASY5	-	SAR	-
MRBT-02	SAR robot	Schmid&Partner Engineering AG	TX60 Lspeag	F10/5E3LA1/A/01	SAR	2015/05/29 * 12
MPM-09	Power Meter	Anritsu	ML2495A	6K00003348	SAR	2015/10/19 * 12
MPSE-12	Power sensor	Anritsu	MA2411B	011598	SAR	2015/10/19 * 12
MCC-206	Microwave Cable	RS Components	R-132G7210200CD	-	SAR	2016/02/08 * 12
MAT-89	Attenuator	Weinschel Associates	WA56-10	56100305	SAR	2015/06/01 * 12
MOS-29	Thermo-Hygrometer	Custom	CTH-201	2901	SAR	2016/01/21 * 12

\*1) This test equipment was used for the tests before the expiration date of the calibration.

The expiration date of the calibration is the end of the expired month.

All equipment is calibrated with valid calibrations. Each measurement data is traceable to the national or international standards.

As for some calibrations performed after the tested dates, those test equipment have been controlled by means of an unbroken chains of calibrations.

SAR room is checked before every testing and ambient noise is <0.012W/kg

**UL Japan, Inc.**

**Ise EMC Lab.**

4383-326 Asama-cho, Ise-shi, Mie-ken 516-0021 JAPAN

Telephone: +81 596 24 8999

Facsimile: +81 596 24 8124

## **APPENDIX 1 : SAR Measurement data**

### **Evaluation procedure**

**The evaluation was performed with the following procedure:**

**Step 1:** Measurement of the E-field at a fixed location above the ear point or central position of flat phantom was used as a reference value for assessing the power drop.

**Step 2:** The SAR distribution at the exposed side of head or body position was measured at a distance of each device from the inner surface of the shell. The area covered the entire dimension of the antenna of EUT and the horizontal grid spacing was 15 mm x 15 mm, 12 mm x 12 mm or 10mm x 10mm. Based on these data, the area of the maximum absorption was determined by spline interpolation.

**Step 3:** Around this point found in the Step 2 (area scan), a volume of 30mm x 30mm x 30mm or more was assessed by measuring 7 x 7 x 7 points at least for below 3GHz and a volume of 28 mm x 28mm x 22.5mm or more was assessed by measuring 8 x 8 x 6(ratio step method (\*1)) points at least for 5GHz band.

And for any secondary peaks found in the Step2 which are within 2dB of maximum peak and not with this Step3 (Zoom scan) is repeated. On the basis of this data set, the spatial peak SAR value was evaluated under the following procedure:

(1). The data at the surface were extrapolated, since the center of the dipoles is 1mm(EX3DV4) away from the tip of the probe and the distance between the surface and the lowest measuring point is 1.3 mm. The extrapolation was based on a least square algorithm [4]. A polynomial of the fourth order was calculated through the points in z-axes.

This polynomial was then used to evaluate the points between the surface and the probe tip.

(2). The maximum interpolated value was searched with a straightforward algorithm. Around this maximum the SAR values averaged over the spatial volumes (1 g or 10 g) were computed by the 3D-Spline interpolation algorithm. The 3D-Spline is composed of three one-dimensional splines with the "Not a knot"-condition (in x, y and z-directions) [4], [5]. The volume was integrated with the trapezoidal-algorithm. One thousand points (10 x 10 x 10) were interpolated to calculate the average.

(3). All neighboring volumes were evaluated until no neighboring volume with a higher average value was found.

**\*1. Ratio step method parameters used;**

**The first measurement point: 2mm from the phantom surface, the initial grid separation: 2mm, subsequent graded grid ratio: 1.5**  
**These parameters comply with the requirement of the KDB 865664D01.**



**Step 4:** Re-measurement of the E-field at the same location as in Step 1.

Confirmation after SAR testing

It was checked that the power drift [W] is within +/-5%. The verification of power drift during the SAR test is that DASY5 system calculates the power drift by measuring the e-field at the same location at beginning and the end of the scan measurement for each test position.

DASY5 system calculation Power drift value[dB] =  $20\log(E_a)/(E_b)$   
Before SAR testing :  $E_b$ [V/m]  
After SAR testing :  $E_a$ [V/m]

Limit of power drift[W] = +/-5%  
 $X[\text{dB}] = 10\log[P] = 10\log(1.05/1) = 10\log(1.05) - 10\log(1) = 0.212\text{dB}$

from E-field relations with power.

$$p = E^2/\eta = E^2/$$

Therefore, The correlation of power and the E-field

$$X_{\text{dB}} = 10\log(P) = 10\log(E)^2 = 20\log(E)$$

Therefore,

The calculated power drift of DASY5 System must be the less than +/-0.212dB.

### Measurement data 2.4GHz

#### WLAN 2.4G 11b 1Mbps 2412MHz Front 0mm

Communication System: UID 0, WLAN 11a/b/g/n (0); Communication System Band: 11b/g/n (2.4G); Frequency: 2412 MHz; Duty Cycle: 1:1

Medium parameters used (interpolated):  $f = 2412$  MHz;  $\sigma = 1.924$  S/m;  $\epsilon_r = 50.408$ ;  $\rho = 1000$  kg/m<sup>3</sup>

Phantom section: Flat Section

Measurement Standard: DASYS5 (IEEE/IEC/ANSI C63.19-2007)

DASY5 Configuration

Probe: EX3DV4 - SN3825; ConvF(7.29, 7.29, 7.29); Calibrated: 2015/12/11;

Sensor-Surface: 2mm (Mechanical Surface Detection)

Electronics: DAE4 Sn509; Calibrated: 2015/07/07

Phantom: ELI v4.0 (20deg probe tilt); Type: QDOVA001BB; Serial: TP:1045

Measurement SW: DASYS2, Version 52.8 (8); SEMCAD X Version 14.6.10 (7331)

**Area Scan 3 (71x101x1):** Interpolated grid: dx=1.200 mm, dy=1.200 mm

Maximum value of SAR (interpolated) = 0.0651 W/kg

**Zoom Scan (7x8x7)/Cube 0:** Measurement grid: dx=5mm, dy=5mm, dz=5mm

Reference Value = 6.415 V/m; Power Drift = -0.05 dB

Peak SAR (extrapolated) = 0.114 W/kg

**SAR(1 g) = 0.042 W/kg; SAR(10 g) = 0.018 W/kg**

Maximum value of SAR (measured) = 0.0703 W/kg

Date: 2016/03/17

Ambient Temp. : 24.0 degree.C. Liquid Temp.; 23.5 degree.C.

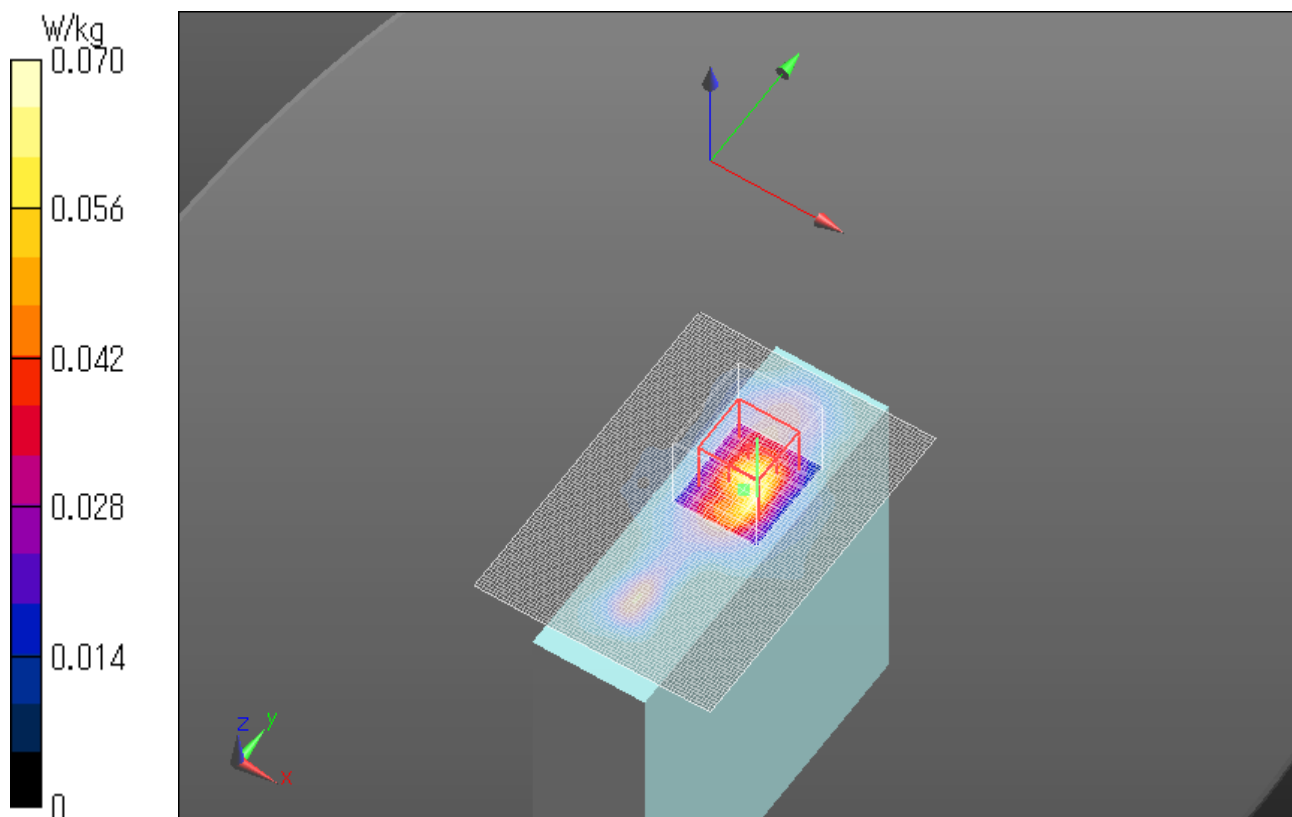

**UL Japan, Inc.**

**Ise EMC Lab.**

4383-326 Asama-cho, Ise-shi, Mie-ken 516-0021 JAPAN

Telephone: +81 596 24 8999

Facsimile: +81 596 24 8124

**WLAN 2.4G 11b 1Mbps 2412MHz Top 0mm**

Communication System: UID 0, WLAN 11a/b/g/n (0); Communication System Band: 11b/g/n (2.4G); Frequency: 2412 MHz; Duty Cycle: 1:1

Medium parameters used (interpolated):  $f = 2412$  MHz;  $\sigma = 1.924$  S/m;  $\epsilon_r = 50.408$ ;  $\rho = 1000$  kg/m<sup>3</sup>

Phantom section: Flat Section

Measurement Standard: DASY5 (IEEE/IEC/ANSI C63.19-2007)

DASY5 Configuration

Probe: EX3DV4 - SN3825; ConvF(7.29, 7.29, 7.29); Calibrated: 2015/12/11;

Sensor-Surface: 2mm (Mechanical Surface Detection)

Electronics: DAE4 Sn509; Calibrated: 2015/07/07

Phantom: ELI v4.0 (20deg probe tilt); Type: QDOVA001BB; Serial: TP:1045

Measurement SW: DASY52, Version 52.8 (8); SEMCAD X Version 14.6.10 (7331)

**Area Scan (51x101x1):** Interpolated grid: dx=1.200 mm, dy=1.200 mm

Maximum value of SAR (interpolated) = 0.0612 W/kg

**Zoom Scan (7x7x7)/Cube 0:** Measurement grid: dx=5mm, dy=5mm, dz=5mm

Reference Value = 6.177 V/m; Power Drift = -0.04 dB

Peak SAR (extrapolated) = 0.0840 W/kg

**SAR(1 g) = 0.038 W/kg; SAR(10 g) = 0.018 W/kg**

Maximum value of SAR (measured) = 0.0598 W/kg

Date: 2016/03/17

Ambient Temp. : 24.0 degree.C. Liquid Temp.; 23.5 degree.C.

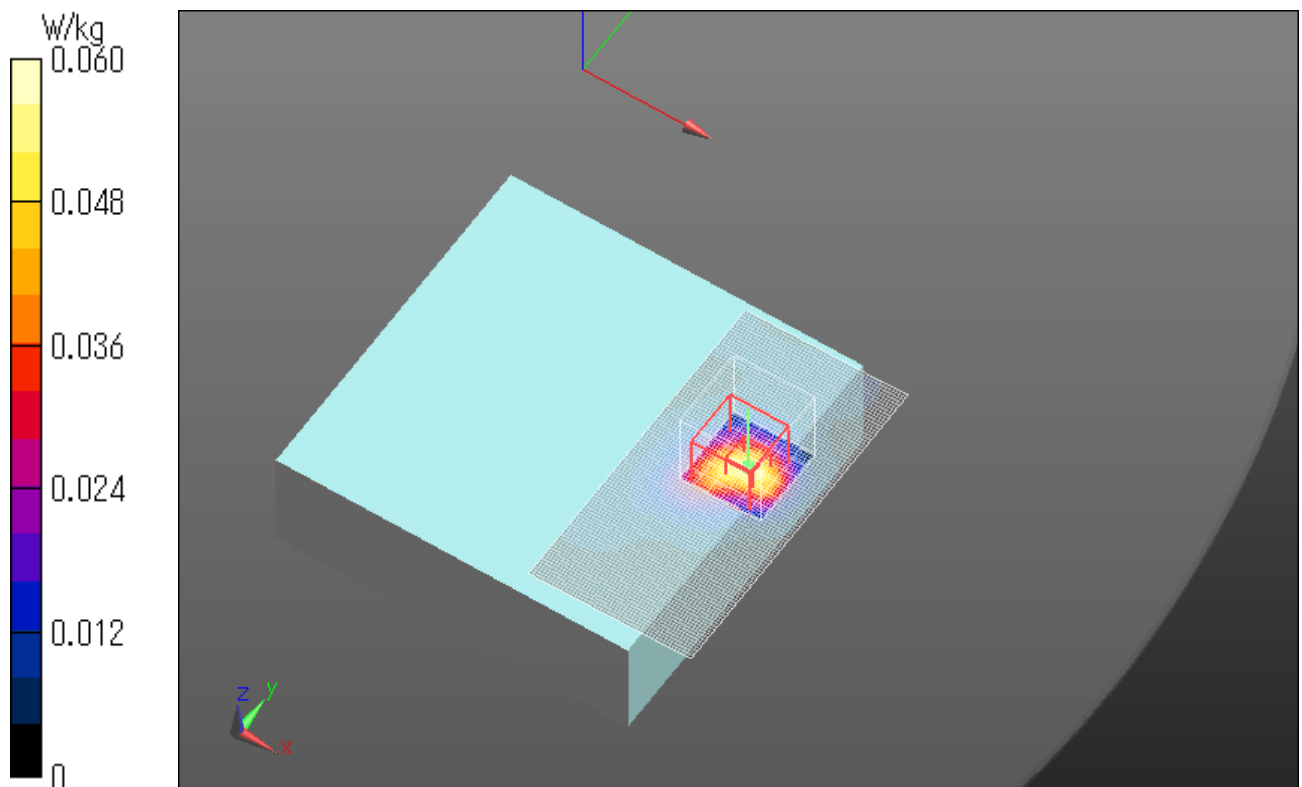

**UL Japan, Inc.**

**Ise EMC Lab.**

4383-326 Asama-cho, Ise-shi, Mie-ken 516-0021 JAPAN

Telephone: +81 596 24 8999

Facsimile: +81 596 24 8124

**WLAN 2.4G 11b 1Mbps 2412MHz Top tilt 0mm**

Communication System: UID 0, WLAN 11a/b/g/n (0); Communication System Band: 11b/g/n (2.4G); Frequency: 2412 MHz; Duty Cycle: 1:1

Medium parameters used (interpolated):  $f = 2412$  MHz;  $\sigma = 1.924$  S/m;  $\epsilon_r = 50.408$ ;  $\rho = 1000$  kg/m<sup>3</sup>

Phantom section: Flat Section

Measurement Standard: DASY5 (IEEE/IEC/ANSI C63.19-2007)

DASY5 Configuration

Probe: EX3DV4 - SN3825; ConvF(7.29, 7.29, 7.29); Calibrated: 2015/12/11;

Sensor-Surface: 2mm (Mechanical Surface Detection)

Electronics: DAE4 Sn509; Calibrated: 2015/07/07

Phantom: ELI v4.0 (20deg probe tilt); Type: QDOVA001BB; Serial: TP:1045

Measurement SW: DASY52, Version 52.8 (8); SEMCAD X Version 14.6.10 (7331)

**Area Scan (51x101x1):** Interpolated grid: dx=1.200 mm, dy=1.200 mm

Maximum value of SAR (interpolated) = 0.111 W/kg

**Zoom Scan (7x7x7)/Cube 0:** Measurement grid: dx=5mm, dy=5mm, dz=5mm

Reference Value = 7.206 V/m; Power Drift = -0.10 dB

Peak SAR (extrapolated) = 0.122 W/kg

**SAR(1 g) = 0.056 W/kg; SAR(10 g) = 0.027 W/kg**

Maximum value of SAR (measured) = 0.0837 W/kg

Date: 2016/03/17

Ambient Temp. : 24.0 degree.C. Liquid Temp.; 23.5 degree.C.

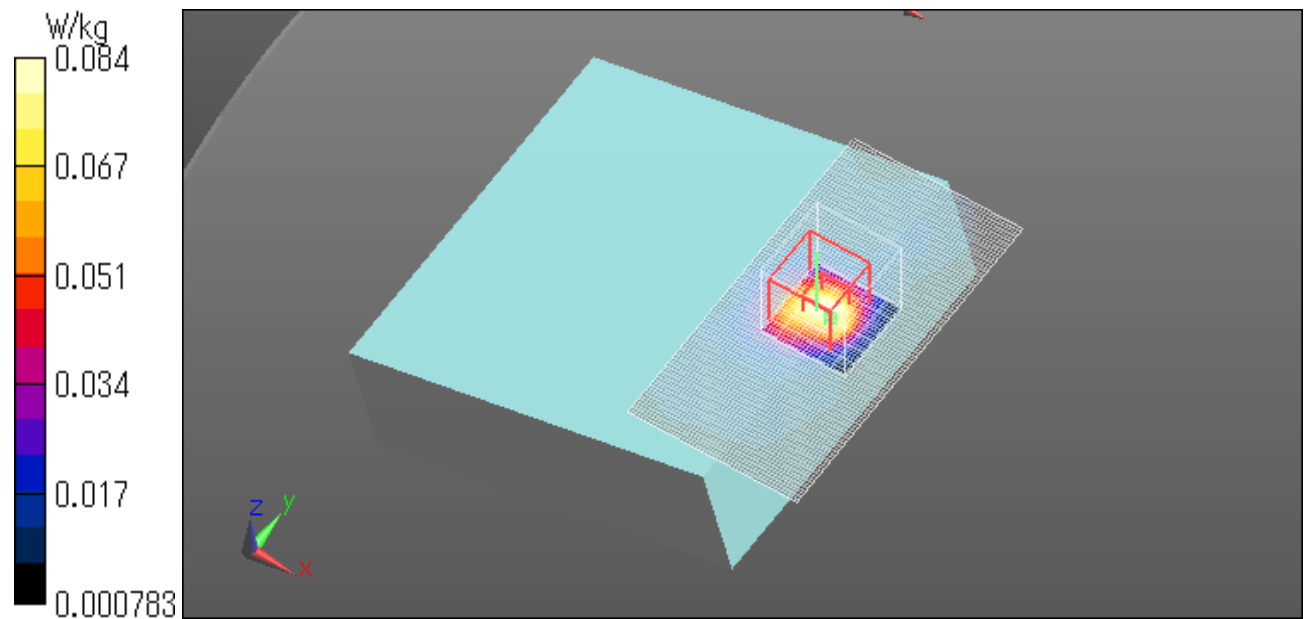

**UL Japan, Inc.**

**Ise EMC Lab.**

4383-326 Asama-cho, Ise-shi, Mie-ken 516-0021 JAPAN

Telephone: +81 596 24 8999

Facsimile: +81 596 24 8124

**Measurement data 5.2GHz**

**WLAN 5G 11a 6Mbps 5220MHz Front 0mm**

Communication System: UID 0, WLAN (0); Communication System Band: 11n40/ac40; Frequency: 5220 MHz; Duty Cycle: 1:1

Medium parameters used:  $f = 5220$  MHz;  $\sigma = 5.299$  S/m;  $\epsilon_r = 48.075$ ;  $\rho = 1000$  kg/m<sup>3</sup>

Phantom section: Flat Section

Measurement Standard: DASYS (IEEE/IEC/ANSI C63.19-2007)

DASY5 Configuration

Probe: EX3DV4 - SN3825; ConvF(4.25, 4.25, 4.25); Calibrated: 2015/12/11;

Sensor-Surface: 1.4mm (Mechanical Surface Detection)

Electronics: DAE4 Sn509; Calibrated: 2015/07/07

Phantom: ELI v4.0 (20deg probe tilt); Type: QDOVA001BB; Serial: TP:1045

Measurement SW: DASYS2, Version 52.8 (8); SEMCAD X Version 14.6.10 (7331)

**Configuration/Front/Area Scan (81x121x1):** Interpolated grid: dx=1.000 mm, dy=1.000 mm  
Maximum value of SAR (interpolated) = 0.715 W/kg

**Configuration/Front/Zoom Scan 2 (8x8x7)/Cube 0:** Measurement grid: dx=4mm, dy=4mm, dz=1.4mm

Reference Value = 13.56 V/m; Power Drift = -0.06 dB

Peak SAR (extrapolated) = 1.48 W/kg

**SAR(1 g) = 0.292 W/kg; SAR(10 g) = 0.076 W/kg**

Maximum value of SAR (measured) = 0.739 W/kg

Date: 2016/03/18

Ambient Temp. : 24.0 degree.C. Liquid Temp.; 23.5 degree.C.

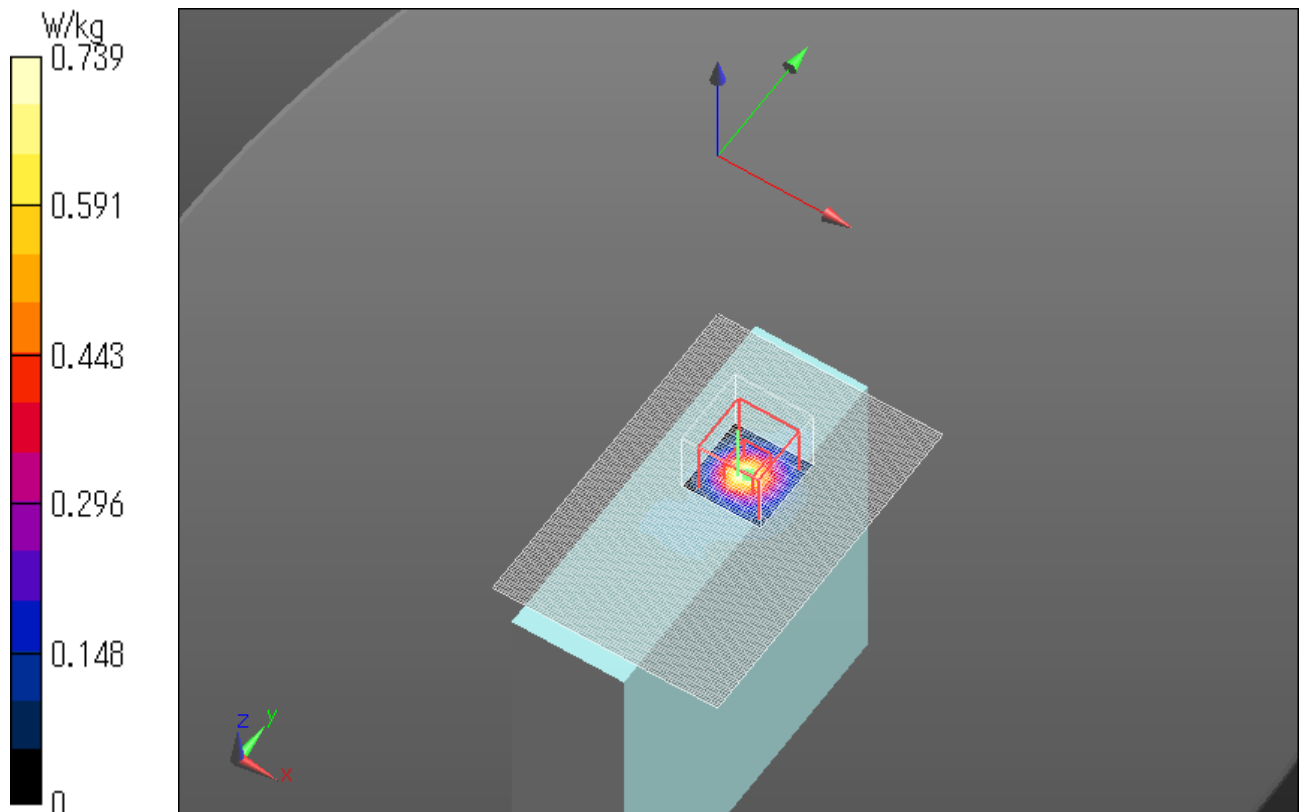

**UL Japan, Inc.**

**Ise EMC Lab.**

4383-326 Asama-cho, Ise-shi, Mie-ken 516-0021 JAPAN

Telephone: +81 596 24 8999

Facsimile: +81 596 24 8124

### Measurement data 5.6GHz

#### WLAN 5G 11a 6Mbps 5500MHz Front 0mm

Communication System: UID 0, WLAN 11a/b/g/n (0); Communication System Band: 11a/n (W56); Frequency: 5500 MHz;  
Duty Cycle: 1:1

Medium parameters used:  $f = 5500$  MHz;  $\sigma = 5.615$  S/m;  $\epsilon_r = 47.945$ ;  $\rho = 1000$  kg/m<sup>3</sup>

Phantom section: Flat Section

Measurement Standard: DASY5 (IEEE/IEC/ANSI C63.19-2007)

DASY5 Configuration

Probe: EX3DV4 - SN3825; ConvF(3.61, 3.61, 3.61); Calibrated: 2015/12/11;

Sensor-Surface: 1.4mm (Mechanical Surface Detection)

Electronics: DAE4 Sn509; Calibrated: 2015/07/07

Phantom: ELI v4.0 (20deg probe tilt); Type: QDOVA001BB; Serial: TP:1045

Measurement SW: DASY52, Version 52.8 (8); SEMCAD X Version 14.6.10 (7331)

**Area Scan (81x121x1):** Interpolated grid: dx=1.000 mm, dy=1.000 mm

Maximum value of SAR (interpolated) = 0.844 W/kg

**Zoom Scan (8x8x7)/Cube 0:** Measurement grid: dx=4mm, dy=4mm, dz=1.4mm

Reference Value = 14.47 V/m; Power Drift = -0.01 dB

Peak SAR (extrapolated) = 1.33 W/kg

**SAR(1 g) = 0.336 W/kg; SAR(10 g) = 0.092 W/kg**

Maximum value of SAR (measured) = 0.824 W/kg

Date: 2016/03/18

Ambient Temp. : 24.0 degree.C. Liquid Temp.; 23.5 degree.C.

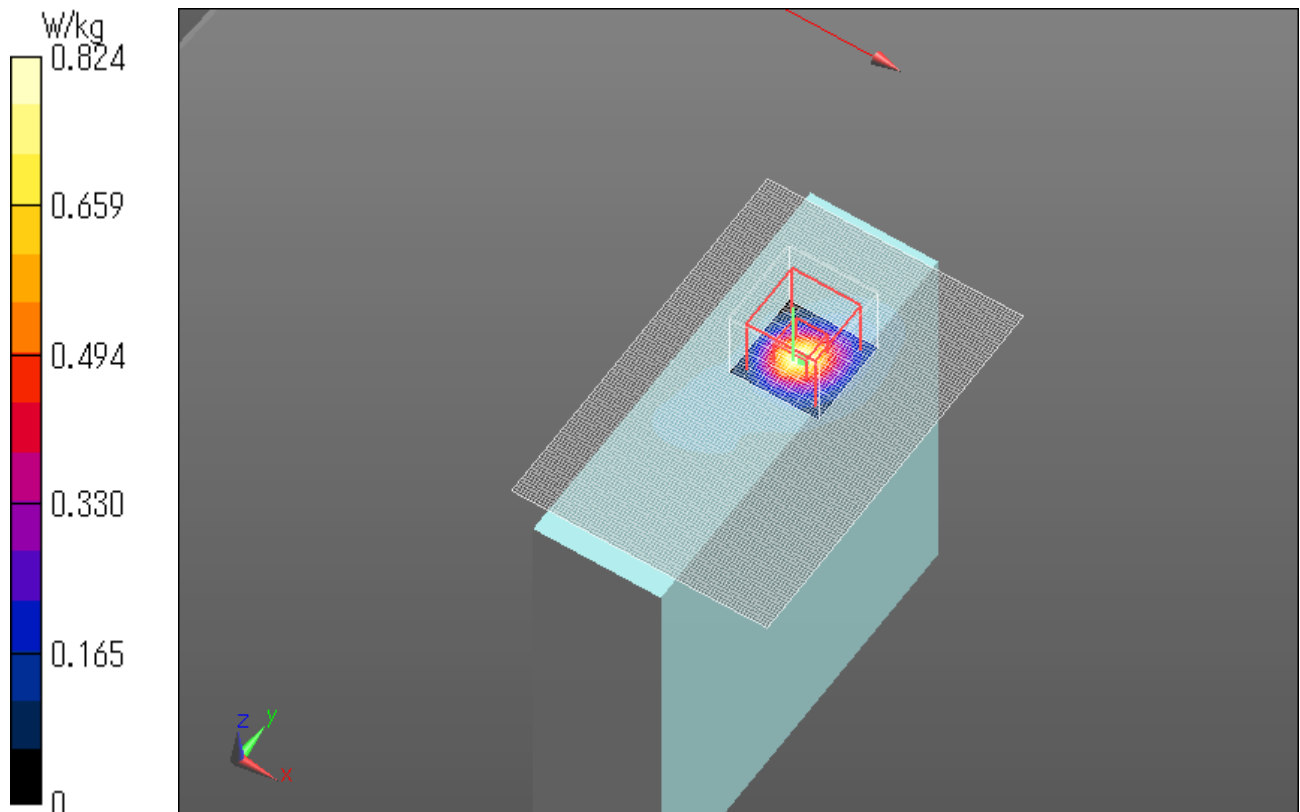

**UL Japan, Inc.**

**Ise EMC Lab.**

4383-326 Asama-cho, Ise-shi, Mie-ken 516-0021 JAPAN

Telephone: +81 596 24 8999

Facsimile: +81 596 24 8124

### Measurement data 5.8GHz

#### WLAN 5G 11a 6Mbps 5745MHz Front 0mm

Communication System: UID 0, WLAN 11a/b/g/n (0); Communication System Band: 11a/n (W58); Frequency: 5745 MHz;  
Duty Cycle: 1:1

Medium parameters used (interpolated):  $f = 5745$  MHz;  $\sigma = 6.166$  S/m;  $\epsilon_r = 47.564$ ;  $\rho = 1000$  kg/m<sup>3</sup>

Phantom section: Flat Section

Measurement Standard: DASYS5 (IEEE/IEC/ANSI C63.19-2007)

DASY5 Configuration

Probe: EX3DV4 - SN3825; ConvF(3.85, 3.85, 3.85); Calibrated: 2015/12/11;

Sensor-Surface: 1.4mm (Mechanical Surface Detection)

Electronics: DAE4 Sn509; Calibrated: 2015/07/07

Phantom: ELI v4.0 (20deg probe tilt); Type: QDOVA001BB; Serial: TP:1045

Measurement SW: DASYS52, Version 52.8 (8); SEMCAD X Version 14.6.10 (7331)

**Area Scan (81x121x1):** Interpolated grid: dx=1.000 mm, dy=1.000 mm

Maximum value of SAR (interpolated) = 0.768 W/kg

**Zoom Scan (8x8x7)/Cube 0:** Measurement grid: dx=4mm, dy=4mm, dz=1.4mm

Reference Value = 12.74 V/m; Power Drift = -0.06 dB

Peak SAR (extrapolated) = 1.12 W/kg

**SAR(1 g) = 0.264 W/kg; SAR(10 g) = 0.069 W/kg**

Maximum value of SAR (measured) = 0.667 W/kg

Date: 2016/03/22

Ambient Temp. : 24.0 degree.C. Liquid Temp.; 23.5 degree.C.

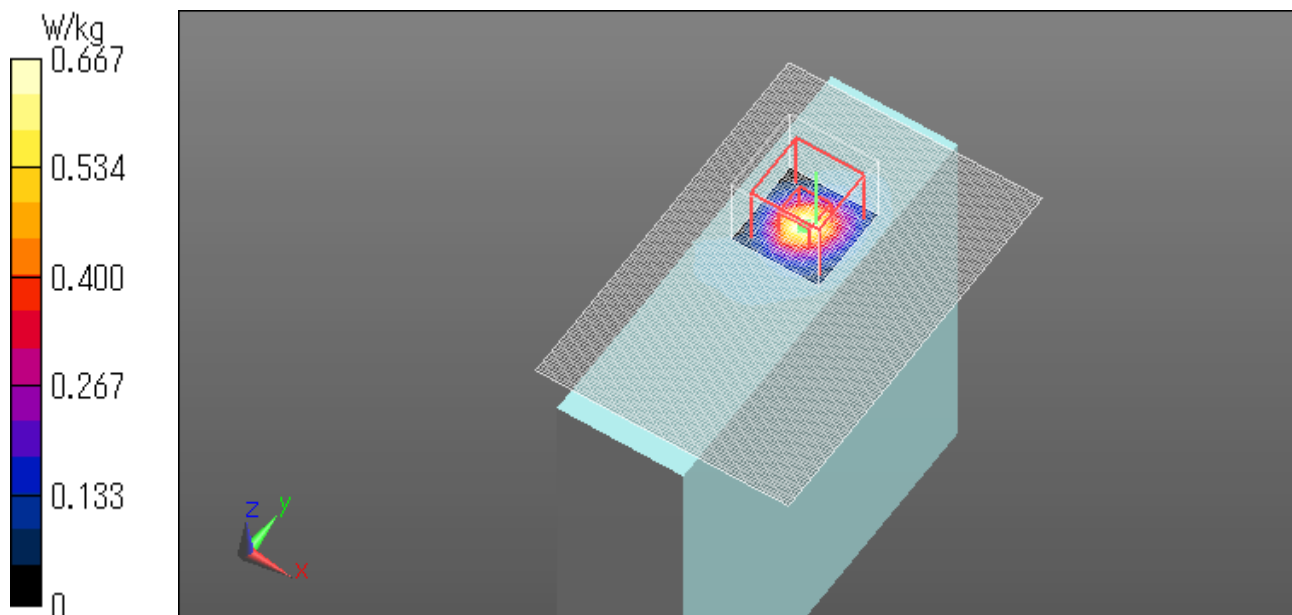

**UL Japan, Inc.**

**Ise EMC Lab.**

4383-326 Asama-cho, Ise-shi, Mie-ken 516-0021 JAPAN

Telephone: +81 596 24 8999

Facsimile: +81 596 24 8124

## APPENDIX 2 : System Check

### System check result Body 2450MHz

Communication System: UID 0, CW (0); Communication System Band: D2450 (2450.0 MHz); Frequency: 2450 MHz;  
Duty Cycle: 1:1

Medium parameters used:  $f = 2450$  MHz;  $\sigma = 1.973$  S/m;  $\epsilon_r = 50.26$ ;  $\rho = 1000$  kg/m<sup>3</sup>

Phantom section: Flat Section

Measurement Standard: DASY5 (IEEE/IEC/ANSI C63.19-2007)

DASY5 Configuration

Probe: EX3DV4 - SN3825; ConvF(7.29, 7.29, 7.29); Calibrated: 2015/12/11;

Sensor-Surface: 2mm (Mechanical Surface Detection)

Electronics: DAE4 Sn509; Calibrated: 2015/07/07

Phantom: ELI v4.0 (20deg probe tilt); Type: QDOVA001BB; Serial: TP:1045

Measurement SW: DASY52, Version 52.8 (8); SEMCAD X Version 14.6.10 (7331)

**Area Scan (81x71x1):** Interpolated grid: dx=1.200 mm, dy=1.200 mm

Maximum value of SAR (interpolated) = 19.9 W/kg

**Zoom Scan (7x7x7) (7x7x7)/Cube 0:** Measurement grid: dx=5mm, dy=5mm, dz=5mm

Reference Value = 101.1 V/m; Power Drift = -0.05 dB

Peak SAR (extrapolated) = 26.5 W/kg

**SAR(1 g) = 13 W/kg; SAR(10 g) = 6.06 W/kg**

Maximum value of SAR (measured) = 19.6 W/kg

Date: 2016/03/17

Ambient Temp. : 24.0 degree.C. Liquid Temp.; 23.5 degree.C.

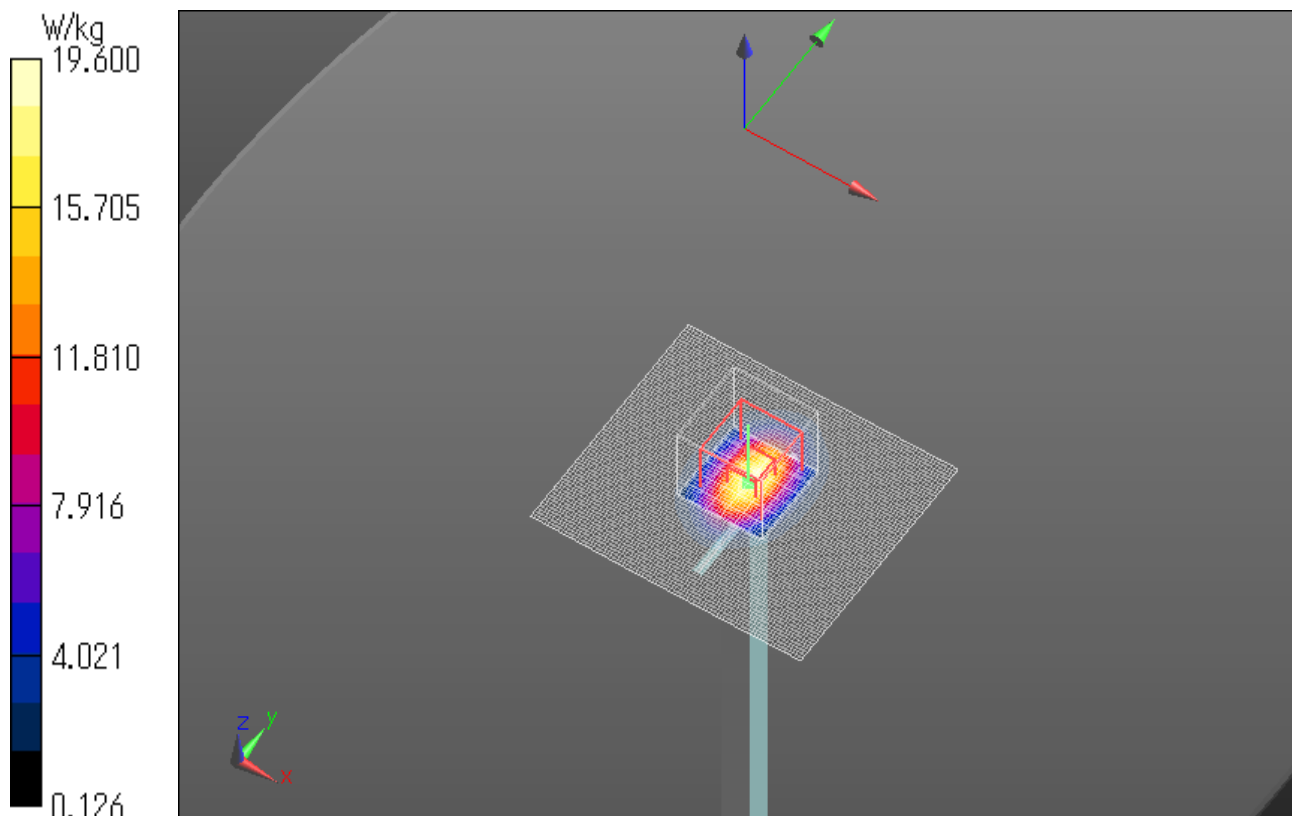

UL Japan, Inc.

Ise EMC Lab.

4383-326 Asama-cho, Ise-shi, Mie-ken 516-0021 JAPAN

Telephone: +81 596 24 8999

Facsimile: +81 596 24 8124



Communication System: UID 0, CW (0); Communication System Band: D2450 (2450.0 MHz); Frequency: 2450 MHz;  
Duty Cycle: 1:1

Medium parameters used:  $f = 2450$  MHz;  $\sigma = 1.973$  S/m;  $\epsilon_r = 50.26$ ;  $\rho = 1000$  kg/m<sup>3</sup>

Phantom section: Flat Section

Measurement Standard: DASYS (IEEE/IEC/ANSI C63.19-2007)

DASY5 Configuration

Probe: EX3DV4 - SN3825; ConvF(7.29, 7.29, 7.29); Calibrated: 2015/12/11;

Sensor-Surface: 0mm (Fix Surface)

Electronics: DAE4 Sn509; Calibrated: 2015/07/07

Phantom: ELI v4.0 (20deg probe tilt); Type: QDOVA001BB; Serial: TP:1045

Measurement SW: DASYS2, Version 52.8 (8); SEMCAD X Version 14.6.10 (7331)

**Z Scan (1x1x31):** Measurement grid: dx=20mm, dy=20mm, dz=5mm

Maximum value of SAR (measured) = 11.1 W/kg

Date: 2016/03/17

Ambient Temp. : 24.0 degree.C. Liquid Temp.; 23.5 degree.C.

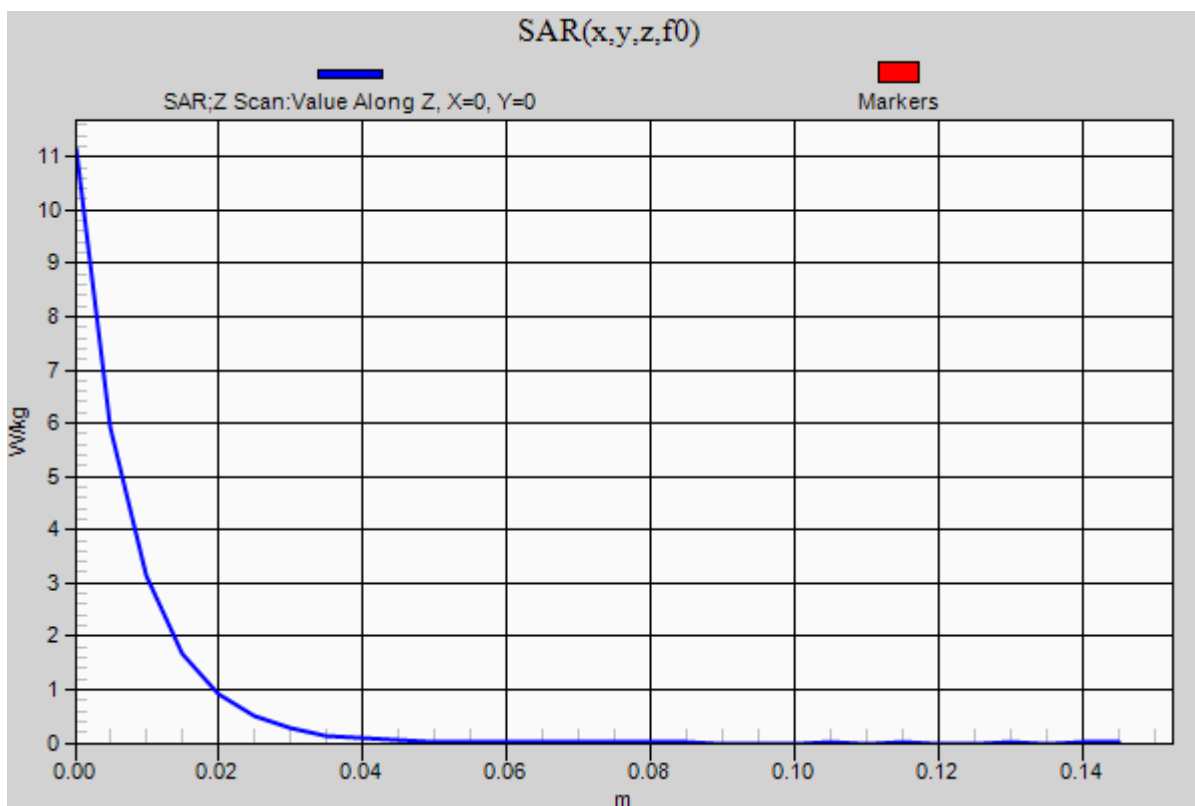

UL Japan, Inc.

Ise EMC Lab.

4383-326 Asama-cho, Ise-shi, Mie-ken 516-0021 JAPAN

Telephone: +81 596 24 8999

Facsimile: +81 596 24 8124

### System check result Body 5250MHz

Communication System: UID 0, CW; Communication System Band: D5GHz (5000.0 - 6000.0 MHz); Frequency: 5250 MHz; Duty Cycle: 1:1

Medium parameters used:  $f = 5250$  MHz;  $\sigma = 5.359$  S/m;  $\epsilon_r = 48.08$ ;  $\rho = 1000$  kg/m<sup>3</sup>

Phantom section: Flat Section

Measurement Standard: DASY5 (IEEE/IEC/ANSI C63.19-2011)

DASY5 Configuration

Probe: EX3DV4 - SN3825; ConvF(4.25, 4.25, 4.25); Calibrated: 2015/12/11;

Sensor-Surface: 1.4mm (Mechanical Surface Detection)

Electronics: DAE4 Sn509; Calibrated: 2015/07/07

Phantom: ELI v4.0 (20deg probe tilt); Type: QDOVA001BB; Serial: TP:1045

Measurement SW: DASY52, Version 52.8 (8); SEMCAD X Version 14.6.10 (7331)

**Area Scan (91x91x1):** Interpolated grid: dx=1.000 mm, dy=1.000 mm

Maximum value of SAR (interpolated) = 17.7 W/kg

**Zoom Scan (4x4x1.4mm, graded), dist=1.4mm (8x8x7)/Cube 0:** Measurement grid: dx=4mm, dy=4mm, dz=1.4mm

Reference Value = 60.43 V/m; Power Drift = -0.04 dB

Peak SAR (extrapolated) = 29.0 W/kg

**SAR(1 g) = 7.44 W/kg; SAR(10 g) = 2.09 W/kg**

Maximum value of SAR (measured) = 17.3 W/kg

Date: 2016/03/18

Ambient Temp. : 24.0 degree.C. Liquid Temp.; 23.5 degree.C.

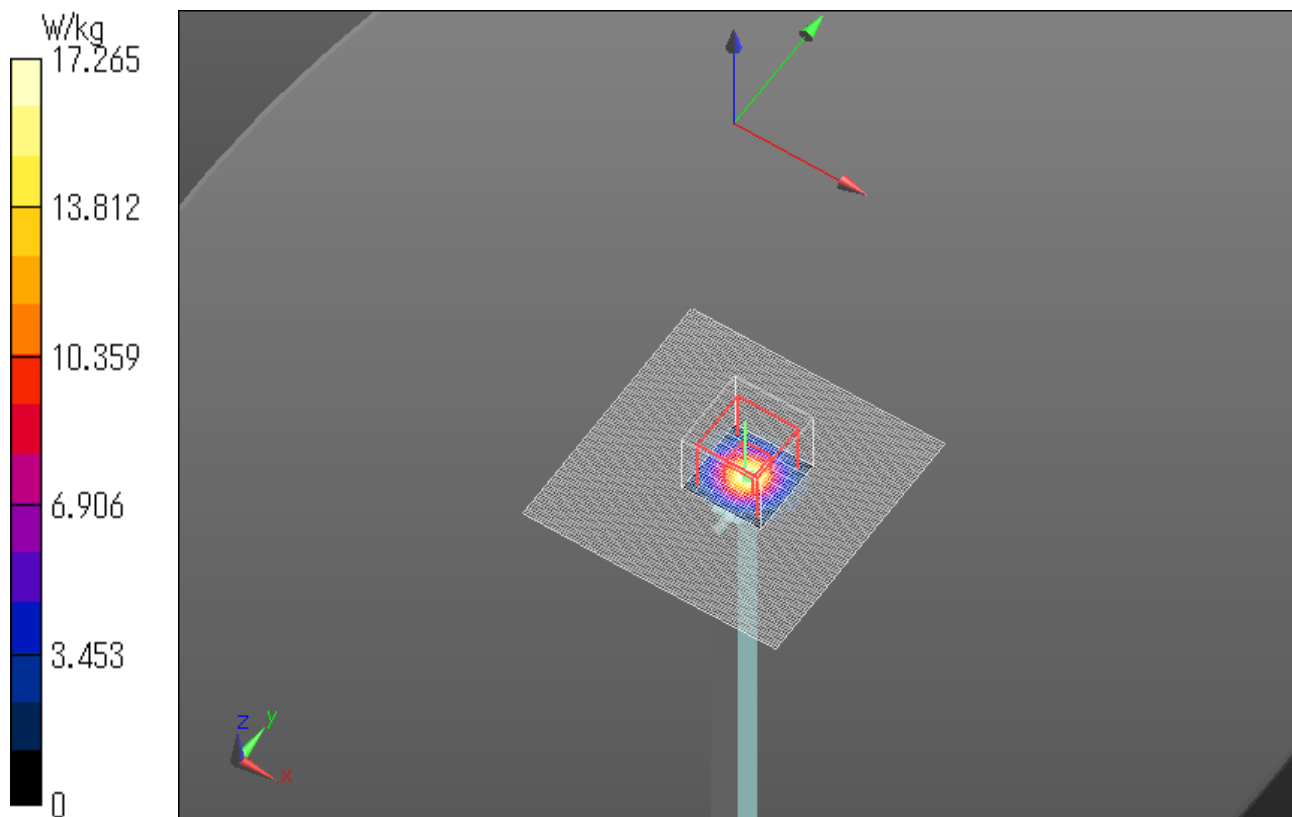

**UL Japan, Inc.**

**Ise EMC Lab.**

4383-326 Asama-cho, Ise-shi, Mie-ken 516-0021 JAPAN

Telephone: +81 596 24 8999

Facsimile: +81 596 24 8124

Communication System: UID 0, CW; Communication System Band: D5GHz (5000.0 - 6000.0 MHz); Frequency: 5250 MHz; Duty Cycle: 1:1

Medium parameters used:  $f = 5250$  MHz;  $\sigma = 5.359$  S/m;  $\epsilon_r = 48.08$ ;  $\rho = 1000$  kg/m<sup>3</sup>

Phantom section: Flat Section

Measurement Standard: DASYS5 (IEEE/IEC/ANSI C63.19-2011)

DASY5 Configuration

Probe: EX3DV4 - SN3825; ConvF(4.25, 4.25, 4.25); Calibrated: 2015/12/11;

Sensor-Surface: 0mm (Fix Surface)

Electronics: DAE4 Sn509; Calibrated: 2015/07/07

Phantom: ELI v4.0 (20deg probe tilt); Type: QDOVA001BB; Serial: TP:1045

Measurement SW: DASYS52, Version 52.8 (8); SEMCAD X Version 14.6.10 (7331)

**Z Scan (1x1x31):** Measurement grid: dx=20mm, dy=20mm, dz=5mm

Maximum value of SAR (measured) = 7.39 W/kg

Date: 2016/03/18

Ambient Temp. : 24.0 degree.C. Liquid Temp.; 23.5 degree.C.

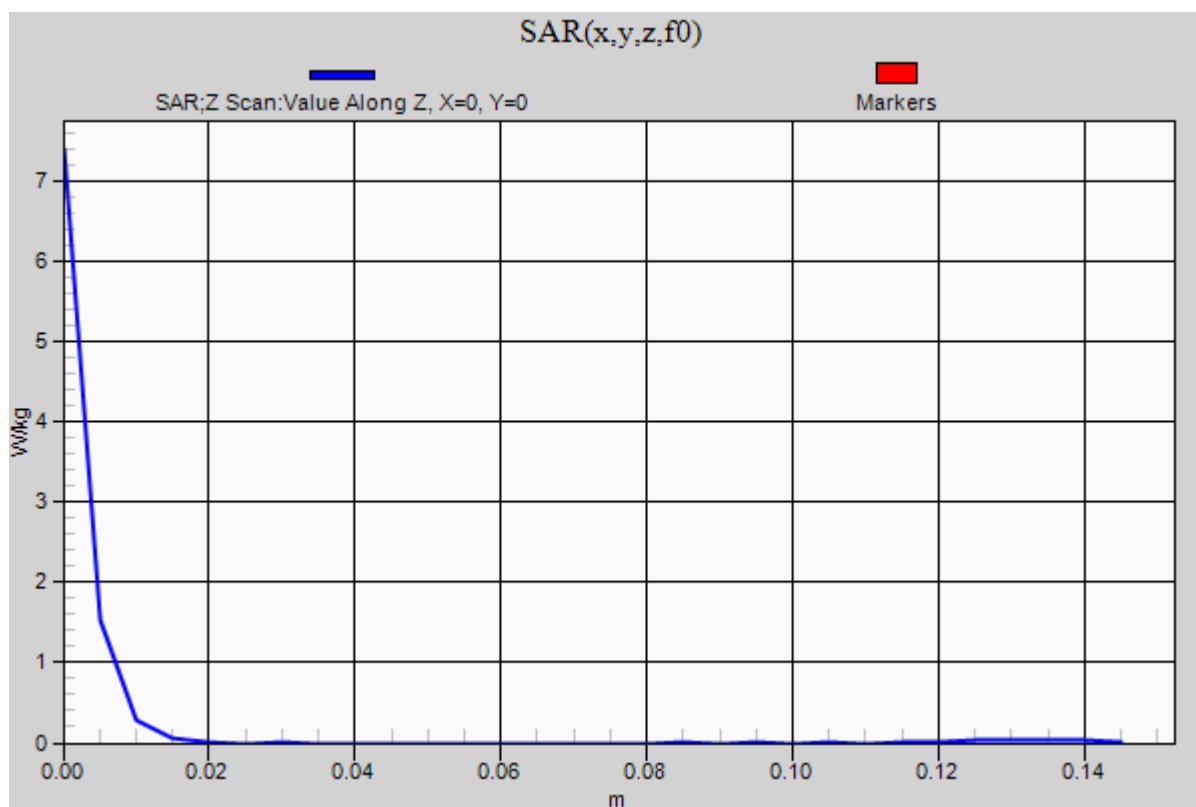

### System check result Body 5600MHz

Communication System: UID 0, CW; Communication System Band: D5GHz (5000.0 - 6000.0 MHz); Frequency: 5600 MHz; Duty Cycle: 1:1

Medium parameters used:  $f = 5600$  MHz;  $\sigma = 5.704$  S/m;  $\epsilon_r = 47.643$ ;  $\rho = 1000$  kg/m<sup>3</sup>

Phantom section: Flat Section

Measurement Standard: DASYS5 (IEEE/IEC/ANSI C63.19-2011)

DASY5 Configuration

Probe: EX3DV4 - SN3825; ConvF(3.61, 3.61, 3.61); Calibrated: 2015/12/11;

Sensor-Surface: 1.4mm (Mechanical Surface Detection)

Electronics: DAE4 Sn509; Calibrated: 2015/07/07

Phantom: ELI v4.0 (20deg probe tilt); Type: QDOVA001BB; Serial: TP:1045

Measurement SW: DASYS52, Version 52.8 (8); SEMCAD X Version 14.6.10 (7331)

**Area Scan (91x91x1):** Interpolated grid: dx=1.000 mm, dy=1.000 mm

Maximum value of SAR (interpolated) = 18.7 W/kg

**Zoom Scan (4x4x1.4mm, graded), dist=1.4mm (8x8x7)/Cube 0:** Measurement grid: dx=4mm, dy=4mm, dz=1.4mm

Reference Value = 62.82 V/m; Power Drift = -0.05 dB

Peak SAR (extrapolated) = 31.5 W/kg

**SAR(1 g) = 7.76 W/kg; SAR(10 g) = 2.14 W/kg**

Maximum value of SAR (measured) = 18.7 W/kg

Date: 2016/03/18

Ambient Temp. : 24.0 degree.C. Liquid Temp.; 23.5 degree.C.

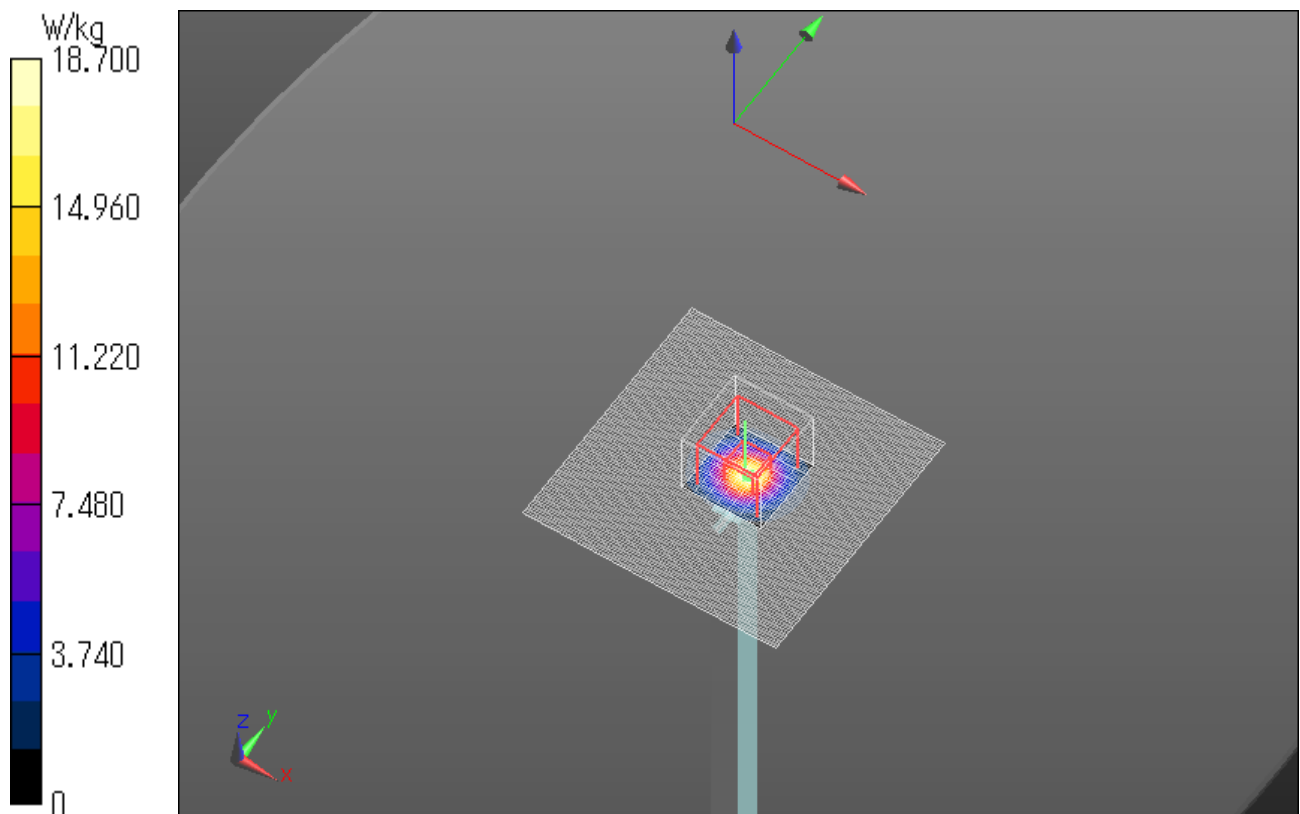

**UL Japan, Inc.**

**Ise EMC Lab.**

4383-326 Asama-cho, Ise-shi, Mie-ken 516-0021 JAPAN

Telephone: +81 596 24 8999

Facsimile: +81 596 24 8124

Communication System: UID 0, CW; Communication System Band: D5GHz (5000.0 - 6000.0 MHz); Frequency: 5600 MHz; Duty Cycle: 1:1

Medium parameters used:  $f = 5600$  MHz;  $\sigma = 5.704$  S/m;  $\epsilon_r = 47.643$ ;  $\rho = 1000$  kg/m<sup>3</sup>

Phantom section: Flat Section

Measurement Standard: DASYS (IEEE/IEC/ANSI C63.19-2011)

DASY5 Configuration

Probe: EX3DV4 - SN3825; ConvF(3.61, 3.61, 3.61); Calibrated: 2015/12/11;

Sensor-Surface: 0mm (Fix Surface)

Electronics: DAE4 Sn509; Calibrated: 2015/07/07

Phantom: ELI v4.0 (20deg probe tilt); Type: QDOVA001BB; Serial: TP:1045

Measurement SW: DASYS2, Version 52.8 (8); SEMCAD X Version 14.6.10 (7331)

**Z Scan (1x1x31):** Measurement grid: dx=20mm, dy=20mm, dz=5mm

Maximum value of SAR (measured) = 7.77 W/kg

Date: 2016/03/18

Ambient Temp. : 24.0 degree.C. Liquid Temp.; 23.5 degree.C.

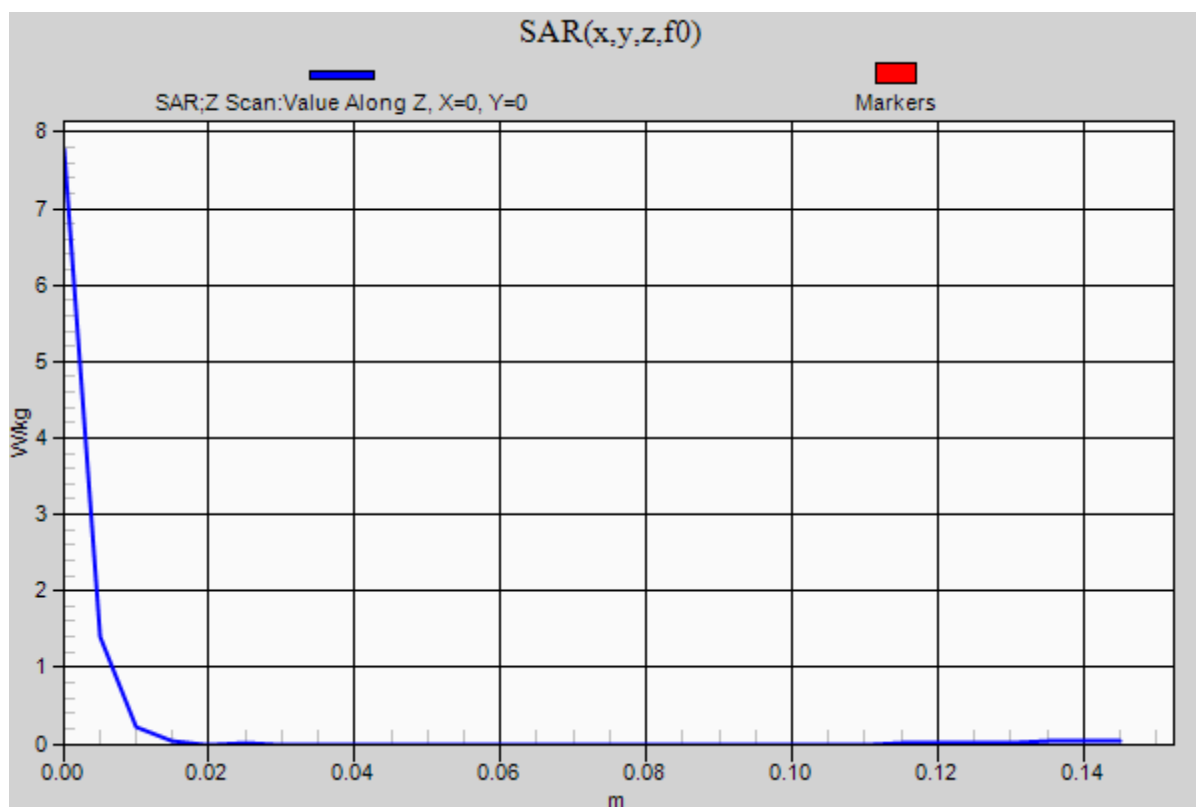

**System check result Body 5750MHz**

Communication System: UID 0, CW; Communication System Band: D5GHz (5000.0 - 6000.0 MHz); Frequency: 5750 MHz; Duty Cycle: 1:1

Medium parameters used:  $f = 5750$  MHz;  $\sigma = 6.172$  S/m;  $\epsilon_r = 47.531$ ;  $\rho = 1000$  kg/m<sup>3</sup>

Phantom section: Flat Section

Measurement Standard: DASY5 (IEEE/IEC/ANSI C63.19-2011)

DASY5 Configuration

Probe: EX3DV4 - SN3825; ConvF(3.85, 3.85, 3.85); Calibrated: 2015/12/11;

Sensor-Surface: 1.4mm (Mechanical Surface Detection)

Electronics: DAE4 Sn509; Calibrated: 2015/07/07

Phantom: ELI v4.0 (20deg probe tilt); Type: QDOVA001BB; Serial: TP:1045

Measurement SW: DASY52, Version 52.8 (8); SEMCAD X Version 14.6.10 (7331)

**Area Scan (91x91x1):** Interpolated grid: dx=1.000 mm, dy=1.000 mm

Maximum value of SAR (interpolated) = 17.6 W/kg

**Zoom Scan (8x8x7)/Cube 0:** Measurement grid: dx=4mm, dy=4mm, dz=1.4mm

Reference Value = 59.25 V/m; Power Drift = -0.02 dB

Peak SAR (extrapolated) = 29.2 W/kg

**SAR(1 g) = 7.08 W/kg; SAR(10 g) = 1.97 W/kg**

Maximum value of SAR (measured) = 16.8 W/kg

Date: 2016/03/22

Ambient Temp. : 24.0 degree.C. Liquid Temp.; 23.5 degree.C.

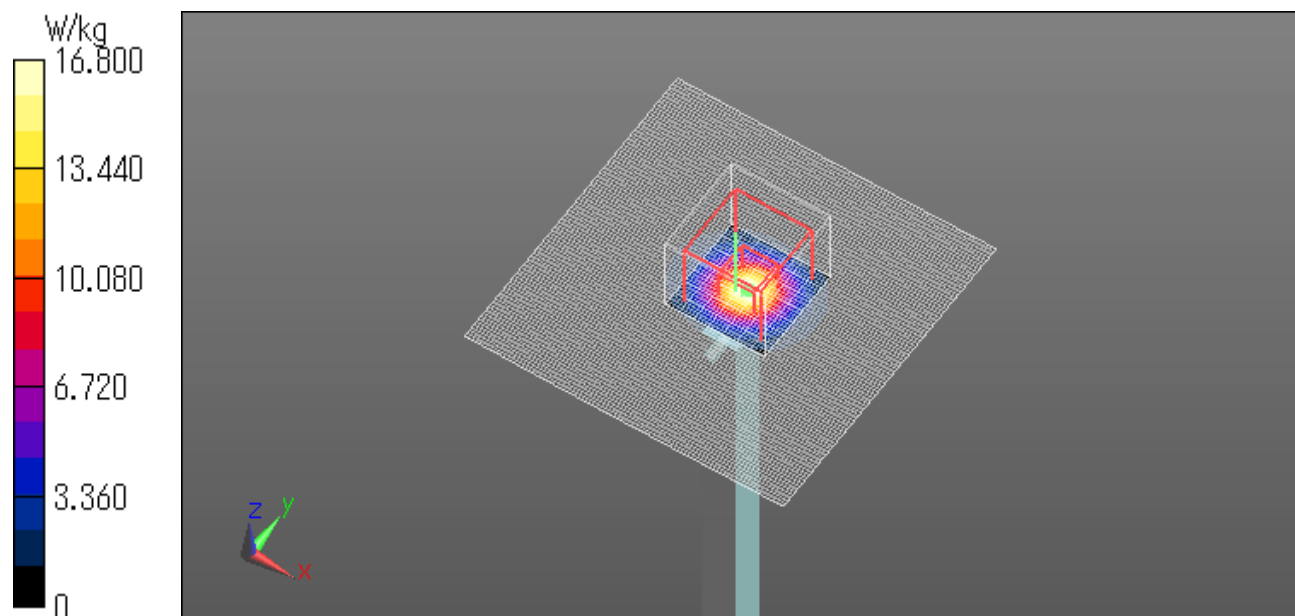

Communication System: UID 0, CW; Communication System Band: D5GHz (5000.0 - 6000.0 MHz); Frequency: 5750 MHz; Duty Cycle: 1:1

Medium parameters used:  $f = 5750$  MHz;  $\sigma = 6.172$  S/m;  $\epsilon_r = 47.531$ ;  $\rho = 1000$  kg/m<sup>3</sup>

Phantom section: Flat Section

Measurement Standard: DASYS (IEEE/IEC/ANSI C63.19-2011)

DASY5 Configuration

Probe: EX3DV4 - SN3825; ConvF(3.85, 3.85, 3.85); Calibrated: 2015/12/11;

Sensor-Surface: 0mm (Fix Surface)

Electronics: DAE4 Sn509; Calibrated: 2015/07/07

Phantom: ELI v4.0 (20deg probe tilt); Type: QDOVA001BB; Serial: TP:1045

Measurement SW: DASYS2, Version 52.8 (8); SEMCAD X Version 14.6.10 (7331)

**Z Scan (1x1x31):** Measurement grid: dx=20mm, dy=20mm, dz=5mm

Maximum value of SAR (measured) = 4.94 W/kg

Date: 2016/03/22

Ambient Temp. : 24.0 degree.C. Liquid Temp.; 23.5 degree.C.

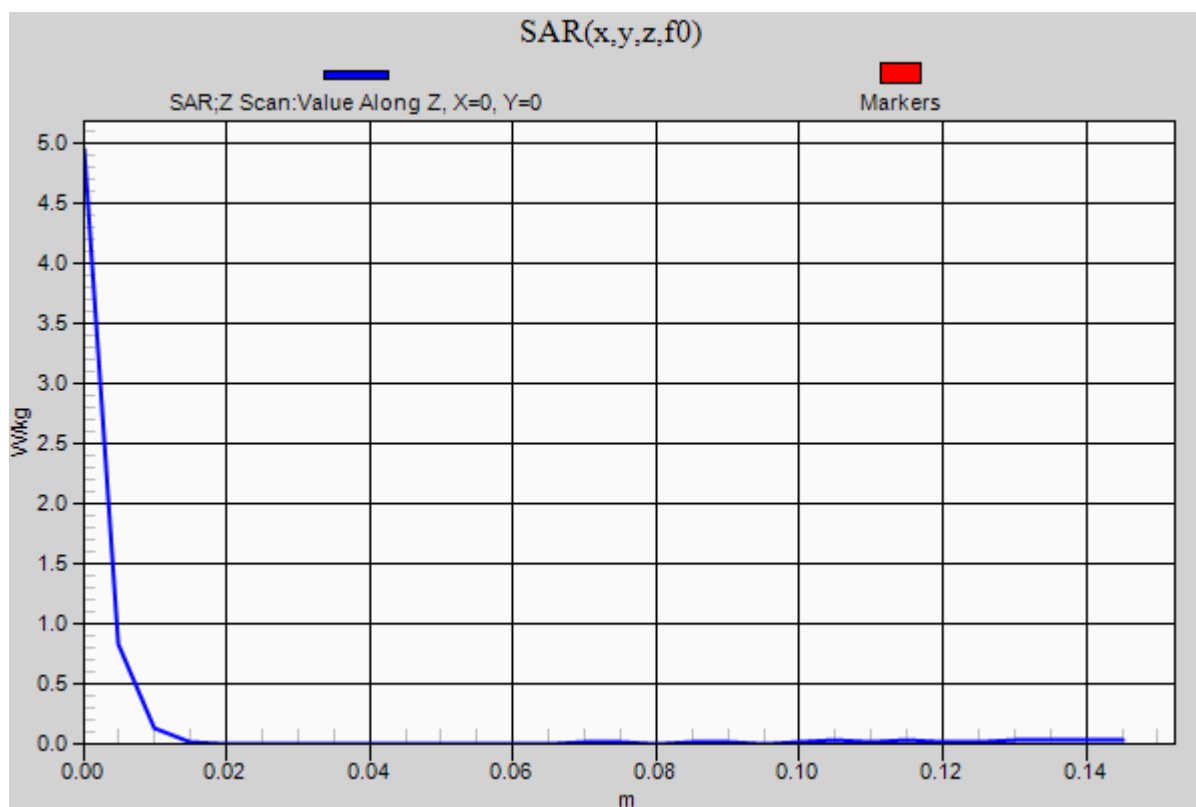

UL Japan, Inc.

Ise EMC Lab.

4383-326 Asama-cho, Ise-shi, Mie-ken 516-0021 JAPAN

Telephone: +81 596 24 8999

Facsimile: +81 596 24 8124

## APPENDIX 3 : System specifications

### Configuration and peripherals

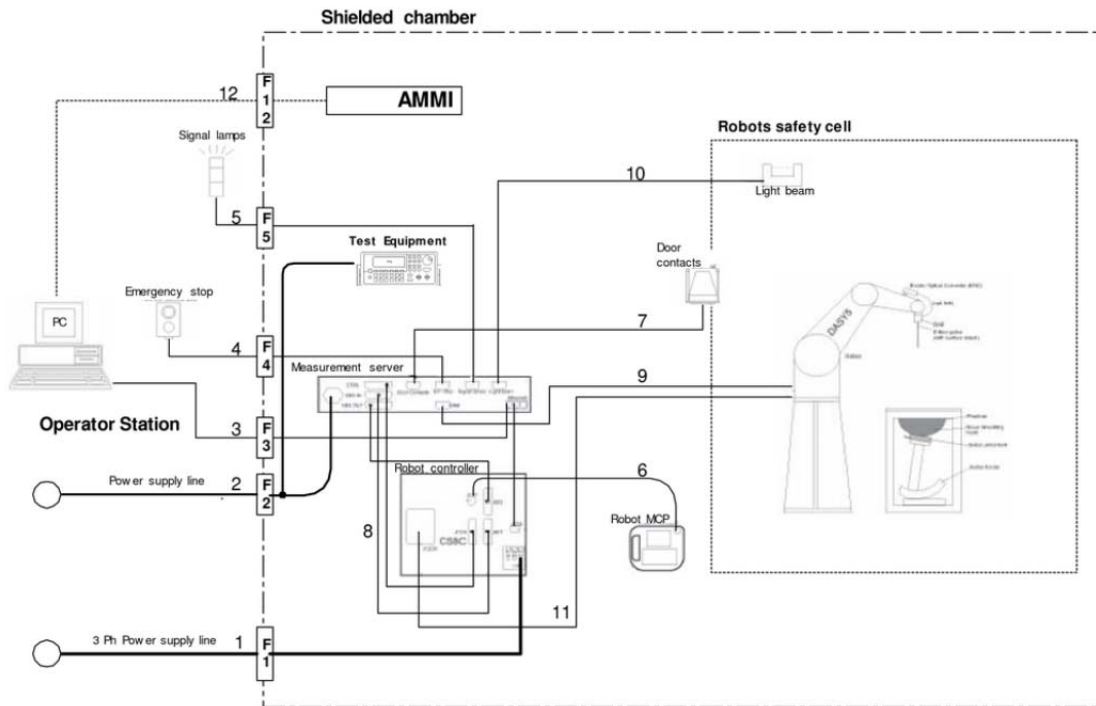

The DASYS system for performing compliance tests consist of the following items:

- a) A standard high precision 6-axis robot (Stäubli RX family) with controller and software.  
An arm extension for accommodating the data acquisition electronics (DAE).
- b) An isotropic field probe optimized and calibrated for the targeted measurement.
- c) A data acquisition electronic (DAE), which performs the signal amplification, signal multiplexing, AD-conversion, offset measurements, mechanical surface detection, collision detection, etc. The unit is battery powered with standard or rechargeable batteries. The signal is optically transmitted to the EOC.
- d) The Electro-optical converter (EOC) performs the conversion between optical and electrical of the signals for the digital communication to the DAE and for the analog signal from the optical surface detection.  
The EOC is connected to the measurement server.
- e) The function of the measurement server is to perform the time critical tasks such as signal filtering, control of the robot operation and fast movement interrupts.
- f) The Light Beam used is for probe alignment. This improves the (absolute) accuracy of the probe positioning.
- g) A computer running WinXP and the DASYS software.
- h) Remote control with teaches pendant and additional circuitry for robot safety such as warning lamps, etc.
- i) The phantom, the device holder and other accessories according to the targeted measurement.

**UL Japan, Inc.**

**Ise EMC Lab.**

4383-326 Asama-cho, Ise-shi, Mie-ken 516-0021 JAPAN

Telephone: +81 596 24 8999

Facsimile: +81 596 24 8124



## Specifications

### **a) Robot TX60L**

<b>Number of Axes</b>	:	6
<b>Nominal Load</b>	:	2 kg
<b>Maximum Load</b>	:	5kg
<b>Reach</b>	:	920mm
<b>Repeatability</b>	:	+/-0.03mm
<b>Control Unit</b>	:	CS8c
<b>Programming Language</b>	:	VAL3
<b>Weight</b>	:	52.2kg
<b>Manufacture</b>	:	Stäubli Robotics

### **b) E-Field Probe**

<b>Model</b>	:	EX3DV4
<b>Construction</b>	:	Symmetrical design with triangular core Built-in shielding against static charges PEEK enclosure material (resistant to organic solvents, e.g., glycol ether)
<b>Frequency</b>	:	10 MHz to > 6 GHz Linearity: $\pm 0.2$ dB (30 MHz to 6 GHz)
<b>Directivity</b>	:	+/-0.3 dB in HSL (rotation around probe axis) +/-0.5 dB in tissue material (rotation normal probe axis)
<b>Dynamic Range</b>	:	10 $\mu$ W/g to > 100 mW/g; Linearity +/-0.2 dB (noise: typically < 1 $\mu$ W/g)
<b>Dimensions</b>	:	Overall length: 337 mm (Tip: 20 mm) Tip diameter: 2.5mm (Body: 12 mm) Typical distance from probe tip to dipole centers: 1 mm
<b>Application</b>	:	Highprecision dosimetric measurement in any exposure scenario (e.g., very strong gradient fields). Only probe which enables compliance testing for frequencies up to 6GHz with precision of better 30%.
<b>Manufacture</b>	:	Schmid & Partner Engineering AG



**EX3DV4 E-field Probe**

#### **c)Data Acquisition Electronic (DAE4)**

<b>Features</b>	:	Signal amplifier, multiplexer, A/D converter and control logic Serial optical link for communication with DASY5 embedded system (fully remote controlled) Two step probe touch detector for mechanical surface detection and emergency robot stop
<b>Measurement Range</b>	:	-100 to +300 mV (16 bit resolution and two range settings: 4mV, 400mV)
<b>Input Offset voltage</b>	:	< 5 $\mu$ V (with auto zero)
<b>Input Resistance</b>	:	200 M $\Omega$
<b>Input Bias Current</b>	:	< 50 fA
<b>Battery Power</b>	:	> 10 h of operation (with two 9.6 V NiMH accus)
<b>Dimension</b>	:	60 x 60 x 68 mm
<b>Manufacture</b>	:	Schmid & Partner Engineering AG

#### **d)Electro-Optic Converter (EOC)**

<b>Version</b>	:	EOC 61
<b>Description</b>	:	for TX60 robot arm, including proximity sensor
<b>Manufacture</b>	:	Schmid & Partner Engineering AG

#### **e)DASY5 Measurement server**

<b>Features</b>	:	Intel ULV Celeron 400MHz 128MB chip disk and 128MB RAM 16 Bit A/D converter for surface detection system Vacuum Fluorescent Display Robot Interface Serial link to DAE (with watchdog supervision) Door contact port (Possibility to connect a light curtain) Emergency stop port (to connect the remote control) Signal lamps port Light beam port Three Ethernet connection ports Two USB 2.0 Ports Two serial links Expansion port for future applications
<b>Dimensions (L x W x H)</b>	:	440 x 241 x 89 mm
<b>Manufacture</b>	:	Schmid & Partner Engineering AG

#### **f) Light Beam Switches**

<b>Version</b>	:	LB5
<b>Dimensions (L x H)</b>	:	110 x 80 mm
<b>Thickness</b>	:	12 mm
<b>Beam-length</b>	:	80 mm
<b>Manufacture</b>	:	Schmid & Partner Engineering AG

#### **g)Software**

<b>Item</b>	:	Dosimetric Assessment System DASY5
<b>Type No.</b>	:	SD 000 401A, SD 000 402A
<b>Software version No.</b>	:	DASY52, Version 52.6 (1)
<b>Manufacture / Origin</b>	:	Schmid & Partner Engineering AG

#### **h)Robot Control Unit**

<b>Weight</b>	:	70 Kg
<b>AC Input Voltage</b>	:	selectable
<b>Manufacturer</b>	:	Stäubli Robotics

---

**UL Japan, Inc.**

**Ise EMC Lab.**

4383-326 Asama-cho, Ise-shi, Mie-ken 516-0021 JAPAN

Telephone: +81 596 24 8999

Facsimile: +81 596 24 8124

### i) Phantom and Device Holder

#### Phantom

<b>Type</b>	:	SAM Twin Phantom V4.0
<b>Description</b>	:	The shell corresponds to the specifications of the Specific Anthropomorphic Mannequin (SAM) phantom defined in IEEE 1528 and IEC 62209-1. It enables the dosimetric evaluation of left and right hand phone usage as well as body mounted usage at the flat phantom region. A cover prevents evaporation of the liquid. Reference markings on the phantom allow the complete setup of all predefined phantom positions and measurement grids by teaching three points with the robot.
<b>Material</b>	:	Vinylester, glass fiber reinforced (VE-GF)
<b>Shell Material</b>	:	Fiberglass
<b>Thickness</b>	:	2.0 +/-0.2 mm
<b>Dimensions</b>	:	Length: 1000 mm Width: 500 mm Height: adjustable feet
<b>Volume</b>	:	Approx. 25 liters
<b>Manufacture</b>	:	Schmid & Partner Engineering AG

<b>Type</b>	:	2mm Flat phantom ERI4.0
<b>Description</b>	:	Phantom for compliance testing of handheld and body-mounted wireless devices in the frequency range of 30 MHz to 6 GHz. ELI4 is fully compatible with the latest draft of the standard IEC 62209 Part II and all known tissue simulating liquids. ELI4 has been optimized regarding its performance and can be integrated into our standard phantom tables. A cover prevents evaporation of the liquid. Reference markings on the phantom allow installation of the complete setup, including all predefined phantom positions and measurement grids, by teaching three points. The phantom is supported by software version DASY4.5 and higher and is compatible with all SPEAG dosimetric probes and dipoles.
<b>Material</b>	:	Vinylester, glass fiber reinforced (VE-GF)
<b>Shell Thickness</b>	:	2.0 ± 0.2 mm (sagging: <1%)
<b>Filling Volume</b>	:	approx. 30 liters
<b>Dimensions</b>	:	Major ellipse axis: 600 mm Minor axis: 400 mm
<b>Manufacture</b>	:	Schmid & Partner Engineering AG

#### Device Holder

In combination with the Twin SAM Phantom V4.0/V4.0c or ELI4, the Mounting Device enables the rotation of the mounted transmitter device in spherical coordinates. Rotation point is the ear opening point. Transmitter devices can be easily and accurately positioned according to IEC, IEEE, FCC or other specifications. The device holder can be locked for positioning at different phantom sections (left head, right head, flat).

**Material** : POM

#### Laptio Extensions kit

Simple but effective and easy-to-use extension for Mounting Device that facilitates the testing of larger devices according to IEC 62209-2 (e.g., laptops, cameras, etc.). It is lightweight and fits easily on the upper part of the Mounting Device in place of the phone positioner. The extension is fully compatible with the Twin-SAM, ELI4 Phantoms.

**Material** : POM, Acrylic glass, Foam

#### Urethane

For this measurement, the urethane foam was used as device holder.

**j) Simulated Tissues (Liquid)**

The following tissue formulations are provided for reference only as some of the parameters have not been thoroughly verified. The composition of ingredients may be modified accordingly to achieve the desired target tissue parameters required for routine SAR evaluation.

Mixture (%)	Frequency (MHz)									
	450		900		1800		1950		2450	
Tissue Type	Head	Body	Head	Body	Head	Body	Head	Body	Head	Body
Water	38.91	46.21	40.29	50.75	55.24	70.17	55.41	69.79	55.0	68.64
Sugar	56.93	51.17	57.90	48.21	-	-	-	-	-	-
Cellulose	0.25	0.18	0.24	0.00	-	-	-	-	-	-
Salt (NaCl)	3.79	2.34	1.38	0.94	0.31	0.39	0.08	0.2	-	-
Preventol	0.12	0.08	0.18	0.10	-	-	-	-	-	-
DGMBE	-	-	-	-	44.45	29.44	44.51	30.0	45.0	31.37
Dielectric Constant	43.42	58.0	42.54	56.1	42.0	56.8	39.9	54.0	39.8	52.5
Conductivity (S/m)	0.85	0.83	0.91	0.95	1.0	1.07	1.42	1.45	1.88	1.78

Note: DGMBE (Diethylenglycol-monobuthyl ether)

The simulated tissue (liquid) of 1800MHz was used for the test frequency of 1700MHz to 1800MHz.

Mixture (%)	Frequency (MHz)	
	650&750	1450
Tissue Type	Head and Body	Head and Body
Water	35-58%	52-75%
Sugar	40-60%	-
Cellulose	<0.3%	-
Salt (NaCl)	0-6%	<1%
Preventol	0.1-0.7%	-
DGMBE	-	25-48%

Mixture (%)	Frequency (MHz)	
	5800	
Tissue Type	Head	Body
Water	64.0	78.0
Mineral Oil	18.0	11.0
Emulsifiers	15.0	9.0
Additives and salt	3.0	2.0

**System Check Dipole SAR Calibration Certificate -Dipole 2450MHz(D2450V2,S/N:713)**

**Calibration Laboratory of  
Schmid & Partner  
Engineering AG**  
Zeughausstrasse 43, 8004 Zurich, Switzerland



**S** Schweizerischer Kalibrierdienst  
**C** Service suisse d'étalonnage  
**S** Servizio svizzero di taratura  
**S** Swiss Calibration Service

Accredited by the Swiss Accreditation Service (SAS)  
The Swiss Accreditation Service is one of the signatories to the EA  
Multilateral Agreement for the recognition of calibration certificates

Accreditation No.: **SCS 108**

Client **UL Japan (PTT)**

Certificate No: **D2450V2-713\_Sep13**

**CALIBRATION CERTIFICATE**

Object	D2450V2 - SN: 713		
Calibration procedure(s)	QA CAL-05.v9 Calibration procedure for dipole validation kits above 700 MHz		
Calibration date:	September 10, 2013		
<p>This calibration certificate documents the traceability to national standards, which realize the physical units of measurements (SI).  The measurements and the uncertainties with confidence probability are given on the following pages and are part of the certificate.</p> <p>All calibrations have been conducted in the closed laboratory facility: environment temperature (22 ± 3)°C and humidity &lt; 70%.</p> <p>Calibration Equipment used (M&amp;TE critical for calibration)</p>			
Primary Standards	ID #	Cal Date (Certificate No.)	Scheduled Calibration
Power meter EPM-442A	GB37480704	01-Nov-12 (No. 217-01640)	Oct-13
Power sensor HP 8481A	US37292783	01-Nov-12 (No. 217-01640)	Oct-13
Reference 20 dB Attenuator	SN: 5058 (20k)	04-Apr-13 (No. 217-01736)	Apr-14
Type-N mismatch combination	SN: 5047.3 / 06327	04-Apr-13 (No. 217-01739)	Apr-14
Reference Probe ES3DV3	SN: 3205	28-Dec-12 (No. ES3-3205_Dec12)	Dec-13
DAE4	SN: 601	25-Apr-13 (No. DAE4-601_Apr13)	Apr-14
Secondary Standards	ID #	Check Date (in house)	Scheduled Check
Power sensor HP 8481A	MY41092317	18-Oct-02 (in house check Oct-11)	In house check: Oct-13
RF generator R&S SMT-06	100005	04-Aug-99 (in house check Oct-11)	In house check: Oct-13
Network Analyzer HP 8753E	US37390585 S4206	18-Oct-01 (in house check Oct-12)	In house check: Oct-13
Calibrated by:	Name Israe El-Naouq	Function Laboratory Technician	Signature 
Approved by:	Katja Pokovic	Technical Manager	
			Issued: September 10, 2013
This calibration certificate shall not be reproduced except in full without written approval of the laboratory.			

Certificate No: D2450V2-713\_Sep13

Page 1 of 8

**UL Japan, Inc.  
Ise EMC Lab.**

4383-326 Asama-cho, Ise-shi, Mie-ken 516-0021 JAPAN  
Telephone: +81 596 24 8999  
Facsimile: +81 596 24 8124

**Calibration Laboratory of**  
Schmid & Partner  
Engineering AG  
Zeughausstrasse 43, 8004 Zurich, Switzerland



**S** Schweizerischer Kalibrierdienst  
**C** Service suisse d'étalonnage  
**S** Servizio svizzero di taratura  
**S** Swiss Calibration Service

Accredited by the Swiss Accreditation Service (SAS)  
The Swiss Accreditation Service is one of the signatories to the EA  
Multilateral Agreement for the recognition of calibration certificates

Accreditation No.: **SCS 108**

**Glossary:**

TSL tissue simulating liquid  
ConvF sensitivity in TSL / NORM x,y,z  
N/A not applicable or not measured

**Calibration is Performed According to the Following Standards:**

- a) IEEE Std 1528-2003, "IEEE Recommended Practice for Determining the Peak Spatial-Averaged Specific Absorption Rate (SAR) in the Human Head from Wireless Communications Devices: Measurement Techniques", December 2003
- b) IEC 62209-1, "Procedure to measure the Specific Absorption Rate (SAR) for hand-held devices used in close proximity to the ear (frequency range of 300 MHz to 3 GHz)", February 2005
- c) KDB 865664, "SAR Measurement Requirements for 100 MHz to 6 GHz"

**Additional Documentation:**

- d) DASY4/5 System Handbook

**Methods Applied and Interpretation of Parameters:**

- *Measurement Conditions:* Further details are available from the Validation Report at the end of the certificate. All figures stated in the certificate are valid at the frequency indicated.
- *Antenna Parameters with TSL:* The dipole is mounted with the spacer to position its feed point exactly below the center marking of the flat phantom section, with the arms oriented parallel to the body axis.
- *Feed Point Impedance and Return Loss:* These parameters are measured with the dipole positioned under the liquid filled phantom. The impedance stated is transformed from the measurement at the SMA connector to the feed point. The Return Loss ensures low reflected power. No uncertainty required.
- *Electrical Delay:* One-way delay between the SMA connector and the antenna feed point. No uncertainty required.
- *SAR measured:* SAR measured at the stated antenna input power.
- *SAR normalized:* SAR as measured, normalized to an input power of 1 W at the antenna connector.
- *SAR for nominal TSL parameters:* The measured TSL parameters are used to calculate the nominal SAR result.

The reported uncertainty of measurement is stated as the standard uncertainty of measurement multiplied by the coverage factor  $k=2$ , which for a normal distribution corresponds to a coverage probability of approximately 95%.

### Measurement Conditions

DASY system configuration, as far as not given on page 1.

DASY Version	DASY5	V52.8.7
Extrapolation	Advanced Extrapolation	
Phantom	Modular Flat Phantom	
Distance Dipole Center - TSL	10 mm	with Spacer
Zoom Scan Resolution	dx, dy, dz = 5 mm	
Frequency	2450 MHz ± 1 MHz	

### Head TSL parameters

The following parameters and calculations were applied.

	Temperature	Permittivity	Conductivity
Nominal Head TSL parameters	22.0 °C	39.2	1.80 mho/m
Measured Head TSL parameters	(22.0 ± 0.2) °C	39.4 ± 6 %	1.83 mho/m ± 6 %
Head TSL temperature change during test	< 0.5 °C	----	----

### SAR result with Head TSL

SAR averaged over 1 cm <sup>3</sup> (1 g) of Head TSL	Condition	
SAR measured	250 mW input power	13.0 W/kg
SAR for nominal Head TSL parameters	normalized to 1W	51.6 W/kg ± 17.0 % (k=2)

SAR averaged over 10 cm <sup>3</sup> (10 g) of Head TSL	condition	
SAR measured	250 mW input power	6.05 W/kg
SAR for nominal Head TSL parameters	normalized to 1W	24.1 W/kg ± 16.5 % (k=2)

### Body TSL parameters

The following parameters and calculations were applied.

	Temperature	Permittivity	Conductivity
Nominal Body TSL parameters	22.0 °C	52.7	1.95 mho/m
Measured Body TSL parameters	(22.0 ± 0.2) °C	52.2 ± 6 %	2.00 mho/m ± 6 %
Body TSL temperature change during test	< 0.5 °C	----	----

### SAR result with Body TSL

SAR averaged over 1 cm <sup>3</sup> (1 g) of Body TSL	Condition	
SAR measured	250 mW input power	12.6 W/kg
SAR for nominal Body TSL parameters	normalized to 1W	49.7 W/kg ± 17.0 % (k=2)

SAR averaged over 10 cm <sup>3</sup> (10 g) of Body TSL	condition	
SAR measured	250 mW input power	5.89 W/kg
SAR for nominal Body TSL parameters	normalized to 1W	23.4 W/kg ± 16.5 % (k=2)

## Appendix

### Antenna Parameters with Head TSL

Impedance, transformed to feed point	51.8 $\Omega$ + 0.7 j $\Omega$
Return Loss	- 34.4 dB

### Antenna Parameters with Body TSL

Impedance, transformed to feed point	48.7 $\Omega$ + 2.8 j $\Omega$
Return Loss	- 30.0 dB

### General Antenna Parameters and Design

Electrical Delay (one direction)	1.162 ns
----------------------------------	----------

After long term use with 100W radiated power, only a slight warming of the dipole near the feedpoint can be measured.

The dipole is made of standard semirigid coaxial cable. The center conductor of the feeding line is directly connected to the second arm of the dipole. The antenna is therefore short-circuited for DC-signals. On some of the dipoles, small end caps are added to the dipole arms in order to improve matching when loaded according to the position as explained in the "Measurement Conditions" paragraph. The SAR data are not affected by this change. The overall dipole length is still according to the Standard.

No excessive force must be applied to the dipole arms, because they might bend or the soldered connections near the feedpoint may be damaged.

### Additional EUT Data

Manufactured by	SPEAG
Manufactured on	July 05, 2002



## DASY5 Validation Report for Head TSL

Date: 10.09.2013

Test Laboratory: SPEAG, Zurich, Switzerland

**DUT: Dipole 2450 MHz; Type: D2450V2; Serial: D2450V2 - SN: 713**

Communication System: UID 0 - CW; Frequency: 2450 MHz

Medium parameters used:  $f = 2450$  MHz;  $\sigma = 1.83$  S/m;  $\epsilon_r = 39.4$ ;  $\rho = 1000$  kg/m<sup>3</sup>

Phantom section: Flat Section

Measurement Standard: DASY5 (IEEE/IEC/ANSI C63.19-2007)

DASY52 Configuration:

- Probe: ES3DV3 - SN3205; ConvF(4.52, 4.52, 4.52); Calibrated: 28.12.2012;
- Sensor-Surface: 3mm (Mechanical Surface Detection)
- Electronics: DAE4 Sn601; Calibrated: 25.04.2013
- Phantom: Flat Phantom 5.0 (front); Type: QD000P50AA; Serial: 1001
- DASY52 52.8.7(1137); SEMCAD X 14.6.10(7164)

### Dipole Calibration for Head Tissue/Pin=250 mW, d=10mm/Zoom Scan (7x7x7)/Cube 0:

Measurement grid: dx=5mm, dy=5mm, dz=5mm

Reference Value = 94.095 V/m; Power Drift = 0.04 dB

Peak SAR (extrapolated) = 26.7 W/kg

**SAR(1 g) = 13 W/kg; SAR(10 g) = 6.05 W/kg**

Maximum value of SAR (measured) = 17.0 W/kg

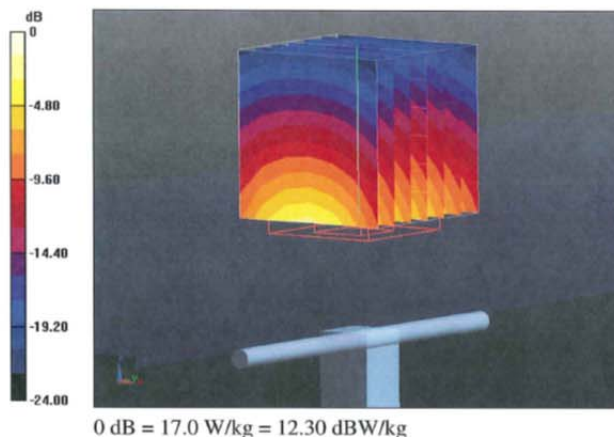

Impedance Measurement Plot for Head TSL

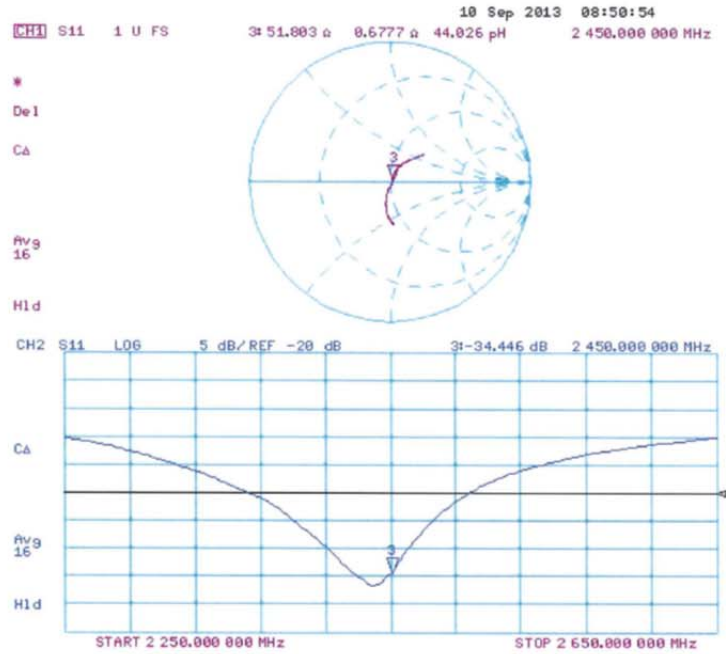

## DASY5 Validation Report for Body TSL

Date: 10.09.2013

Test Laboratory: SPEAG, Zurich, Switzerland

**DUT: Dipole 2450 MHz; Type: D2450V2; Serial: D2450V2 - SN: 713**

Communication System: UID 0 - CW; Frequency: 2450 MHz

Medium parameters used:  $f = 2450$  MHz;  $\sigma = 2$  S/m;  $\epsilon_r = 52.2$ ;  $\rho = 1000$  kg/m<sup>3</sup>

Phantom section: Flat Section

Measurement Standard: DASY5 (IEEE/IEC/ANSI C63.19-2007)

DASY52 Configuration:

- Probe: ES3DV3 - SN3205; ConvF(4.42, 4.42, 4.42); Calibrated: 28.12.2012;
- Sensor-Surface: 3mm (Mechanical Surface Detection)
- Electronics: DAE4 Sn601; Calibrated: 25.04.2013
- Phantom: Flat Phantom 5.0 (back); Type: QD000P50AA; Serial: 1002
- DASY52 52.8.7(1137); SEMCAD X 14.6.10(7164)

### Dipole Calibration for Body Tissue/Pin=250 mW, d=10mm/Zoom Scan (7x7x7)/Cube 0:

Measurement grid: dx=5mm, dy=5mm, dz=5mm

Reference Value = 94.095 V/m; Power Drift = 0.03 dB

Peak SAR (extrapolated) = 26.1 W/kg

**SAR(1 g) = 12.6 W/kg; SAR(10 g) = 5.89 W/kg**

Maximum value of SAR (measured) = 16.7 W/kg

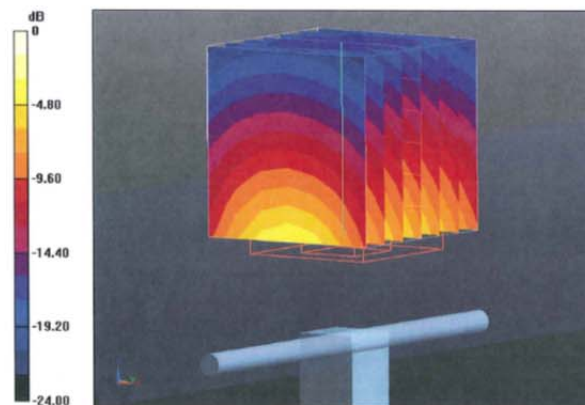

0 dB = 16.7 W/kg = 12.23 dBW/kg

Impedance Measurement Plot for Body TSL

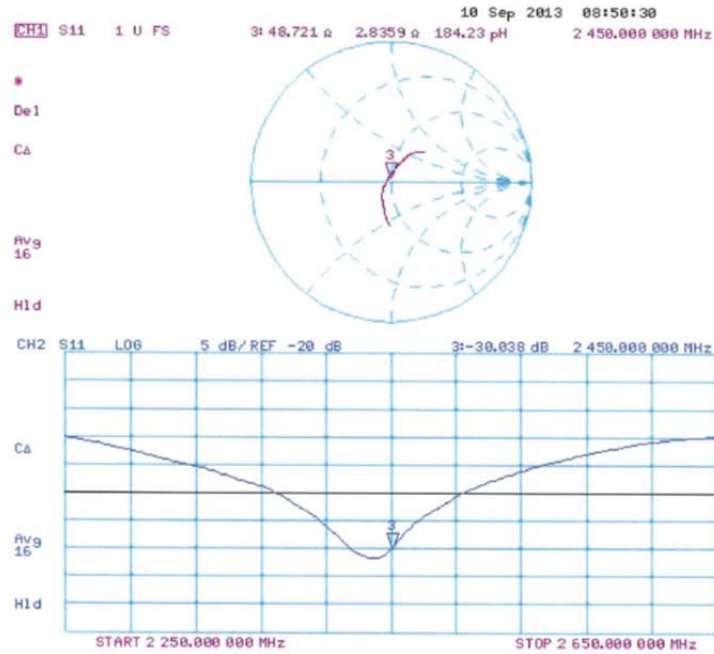

D2450V2 Calibration for Impedance and Return-loss

Equipment	Dipole Antenna	Model	D2450V2
Manufacture	Schmid&Partner Engineering AG	Serial	713
Tested by	Tomohisa Nakagawa		

**1. Test environment**

Date	July 21, 2014		
Ambient Temperature	24.0 deg.C	Relative humidity	50%RH

**2. Equipment used**

Control No.	Instrument	Manufacturer	Model No	Serial No	Test Item	Calibration Date * Interval(month)
EST-54	Network Analyzer	Hewlett Packard	8753ES	US39171615	SAR	2015/05/05 * 12
EST-08	Calibration Kit	Agilent	85032B	3217A12903	SAR	2015/05/04 * 12
MPF-04	2mm Oval Flat Phantom	Schmid&Partner Engineering AG	QDOVA001BB	1207	SAR	2015/05/11 * 12
MPSAM-04	SAM Phantom	Schmid&Partner Engineering AG	QD000P40CD	1762	SAR	2015/05/11 * 12
MOS-38	Digital thermometer	HANNA	Checktemp 4	-	SAR	2015/04/28 * 12
MOS-31	Thermo-Hygrometer	Custom	CTH-201	3101	SAR	2015/07/07 * 12
HSL2450						Daily check
MSL2450						Daily check
SAR room1						Daily check

**3. Test Result**

Impedance, Transformed to feed point	Head	Deviation	Tolerance	Result
Calibration (SPEAG) 2013/09/10	51.8 Ω+0.7jΩ	-	-	-
Calibration(ULJ)2015/7/21	50.94Ω+0.86jΩ	-0.9Ω+0.2jΩ	+/-5Ω+/-5jΩ	Complied

Return loss	Head	Deviation	Tolerance	Result
Calibration (SPEAG) 2013/09/10	-34.4dB	-	-	-
Calibration(ULJ)2015/7/21	-37.97dB	-3.5dB	-34.4 *+/-20%	Complied

Impedance, Transformed to feed point	Body	Deviation	Tolerance	Result
Calibration (SPEAG) 2013/09/10	48.7Ω+2.8jΩ	-	-	-
Calibration(ULJ)2015/7/21	50.53Ω+2.48jΩ	+1.8Ω+/-0.3jΩ	+/-5Ω+/-5jΩ	Complied

Return loss	Body	Deviation	Tolerance	Result
Calibration (SPEAG) 2013/09/10	-30.0dB	-	-	-
Calibration(ULJ)2015/7/21	-31.95dB	-1.95dB	-30.0 *+/-20%	Complied

\*Tolerance : According to the KDB450824D02

**UL Japan, Inc.**

**Ise EMC Lab.**

4383-326 Asama-cho, Ise-shi, Mie-ken 516-0021 JAPAN  
Telephone: +81 596 24 8999  
Facsimile: +81 596 24 8124

Measurement Plots

<Head Liquid>

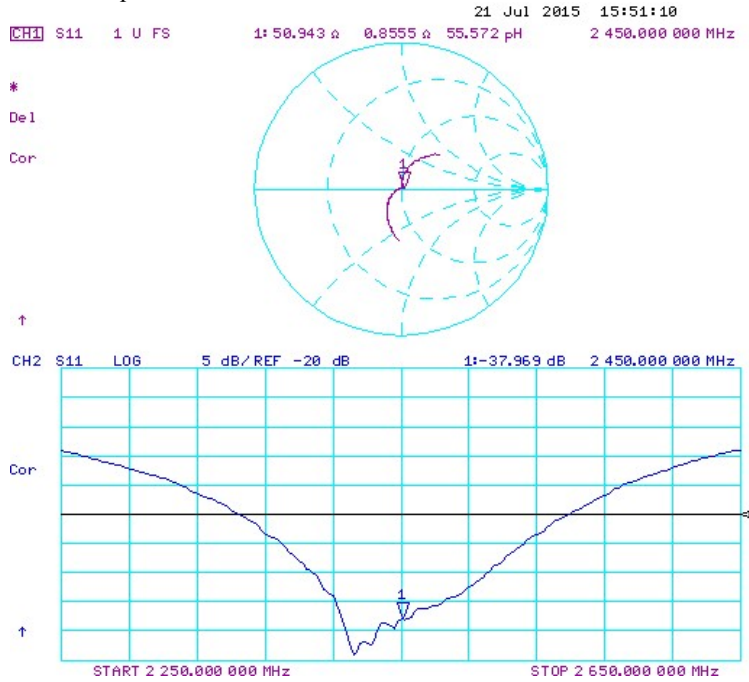

<Body Liquid>

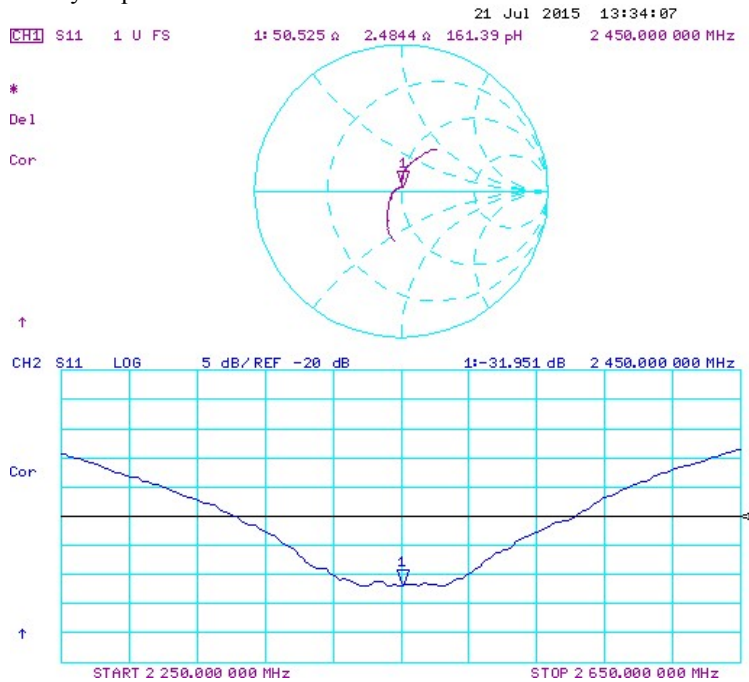

**System Check Dipole SAR Calibration Certificate -Dipole 5GHz(D5GHzV2,S/N:1020)**

**Calibration Laboratory of  
Schmid & Partner  
Engineering AG**  
Zeughausstrasse 43, 8004 Zurich, Switzerland



**S** Schweizerischer Kalibrierdienst  
**S** Service suisse d'étalonnage  
**S** Servizio svizzero di taratura  
**S** Swiss Calibration Service

Accredited by the Swiss Accreditation Service (SAS)  
The Swiss Accreditation Service is one of the signatories to the EA  
Multilateral Agreement for the recognition of calibration certificates

Accreditation No.: **SCS 0108**

Client **UL Japan HQ (Vitec)**

Certificate No: **D5GHzV2-1020\_Jan16**

CALIBRATION CERTIFICATE																																															
Object	D5GHzV2 - SN: 1020																																														
Calibration procedure(s)	QA CAL-22.v2 Calibration procedure for dipole validation kits between 3-6 GHz																																														
Calibration date:	January 20, 2016																																														
<p>This calibration certificate documents the traceability to national standards, which realize the physical units of measurements (SI).  The measurements and the uncertainties with confidence probability are given on the following pages and are part of the certificate.</p> <p>All calibrations have been conducted in the closed laboratory facility: environment temperature (22 ± 3)°C and humidity &lt; 70%.</p> <p>Calibration Equipment used (M&amp;TE critical for calibration)</p> <table border="1"> <thead> <tr> <th>Primary Standards</th> <th>ID #</th> <th>Cal Date (Certificate No.)</th> <th>Scheduled Calibration</th> </tr> </thead> <tbody> <tr> <td>Power meter EPM-442A</td> <td>GB37480704</td> <td>07-Oct-15 (No. 217-02222)</td> <td>Oct-16</td> </tr> <tr> <td>Power sensor HP 8431A</td> <td>US37292783</td> <td>07-Oct-15 (No. 217-02222)</td> <td>Oct-16</td> </tr> <tr> <td>Power sensor HP 8481A</td> <td>MY41092317</td> <td>07-Oct-15 (No. 217-02223)</td> <td>Oct-16</td> </tr> <tr> <td>Reference 20 dB Attenuator</td> <td>SN: 5058 (20k)</td> <td>01-Apr-15 (No. 217-02131)</td> <td>Mar-16</td> </tr> <tr> <td>Type-N mismatch combination</td> <td>SN: 5047.2 / 06327</td> <td>01-Apr-15 (No. 217-02134)</td> <td>Mar-16</td> </tr> <tr> <td>Reference Probe EX3DV4</td> <td>SN: 3503</td> <td>31-Dec-15 (No. EX3-3503_Dec15)</td> <td>Dec-16</td> </tr> <tr> <td>DAE4</td> <td>SN: 601</td> <td>30-Dec-15 (No. DAE4-601_Dec15)</td> <td>Dec-16</td> </tr> </tbody> </table> <table border="1"> <thead> <tr> <th>Secondary Standards</th> <th>ID #</th> <th>Check Date (in house)</th> <th>Scheduled Check</th> </tr> </thead> <tbody> <tr> <td>RF generator R&amp;S SMT-06</td> <td>100972</td> <td>15-Jun-15 (in house check Jun-15)</td> <td>In house check: Jun-18</td> </tr> <tr> <td>Network Analyzer HP 8753E</td> <td>US37390585 S4206</td> <td>18-Oct-01 (in house check Oct-15)</td> <td>In house check: Oct-16</td> </tr> </tbody> </table>				Primary Standards	ID #	Cal Date (Certificate No.)	Scheduled Calibration	Power meter EPM-442A	GB37480704	07-Oct-15 (No. 217-02222)	Oct-16	Power sensor HP 8431A	US37292783	07-Oct-15 (No. 217-02222)	Oct-16	Power sensor HP 8481A	MY41092317	07-Oct-15 (No. 217-02223)	Oct-16	Reference 20 dB Attenuator	SN: 5058 (20k)	01-Apr-15 (No. 217-02131)	Mar-16	Type-N mismatch combination	SN: 5047.2 / 06327	01-Apr-15 (No. 217-02134)	Mar-16	Reference Probe EX3DV4	SN: 3503	31-Dec-15 (No. EX3-3503_Dec15)	Dec-16	DAE4	SN: 601	30-Dec-15 (No. DAE4-601_Dec15)	Dec-16	Secondary Standards	ID #	Check Date (in house)	Scheduled Check	RF generator R&S SMT-06	100972	15-Jun-15 (in house check Jun-15)	In house check: Jun-18	Network Analyzer HP 8753E	US37390585 S4206	18-Oct-01 (in house check Oct-15)	In house check: Oct-16
Primary Standards	ID #	Cal Date (Certificate No.)	Scheduled Calibration																																												
Power meter EPM-442A	GB37480704	07-Oct-15 (No. 217-02222)	Oct-16																																												
Power sensor HP 8431A	US37292783	07-Oct-15 (No. 217-02222)	Oct-16																																												
Power sensor HP 8481A	MY41092317	07-Oct-15 (No. 217-02223)	Oct-16																																												
Reference 20 dB Attenuator	SN: 5058 (20k)	01-Apr-15 (No. 217-02131)	Mar-16																																												
Type-N mismatch combination	SN: 5047.2 / 06327	01-Apr-15 (No. 217-02134)	Mar-16																																												
Reference Probe EX3DV4	SN: 3503	31-Dec-15 (No. EX3-3503_Dec15)	Dec-16																																												
DAE4	SN: 601	30-Dec-15 (No. DAE4-601_Dec15)	Dec-16																																												
Secondary Standards	ID #	Check Date (in house)	Scheduled Check																																												
RF generator R&S SMT-06	100972	15-Jun-15 (in house check Jun-15)	In house check: Jun-18																																												
Network Analyzer HP 8753E	US37390585 S4206	18-Oct-01 (in house check Oct-15)	In house check: Oct-16																																												
Calibrated by:	Name Jeton Kastrati	Function Laboratory Technician	Signature 																																												
Approved by:	Name Katja Pokovic	Function Technical Manager	Signature 																																												
			Issued: January 20, 2016																																												
This calibration certificate shall not be reproduced except in full without written approval of the laboratory.																																															

**Calibration Laboratory of  
Schmid & Partner  
Engineering AG**  
Zeughausstrasse 43, 8004 Zurich, Switzerland



**S** Schweizerischer Kalibrierdienst  
**C** Service suisse d'étalonnage  
**S** Servizio svizzero di taratura  
**S** Swiss Calibration Service

Accredited by the Swiss Accreditation Service (SAS)  
The Swiss Accreditation Service is one of the signatories to the EA  
Multilateral Agreement for the recognition of calibration certificates

Accreditation No.: **SCS 0108**

**Glossary:**

TSL tissue simulating liquid  
ConvF sensitivity in TSL / NORM x,y,z  
N/A not applicable or not measured

**Calibration is Performed According to the Following Standards:**

- IEEE Std 1528-2013, "IEEE Recommended Practice for Determining the Peak Spatial-Averaged Specific Absorption Rate (SAR) in the Human Head from Wireless Communications Devices: Measurement Techniques", June 2013
- IEC 62209-2, "Procedure to determine the Specific Absorption Rate (SAR) for wireless communication devices used in close proximity to the human body (frequency range of 30 MHz to 6 GHz)", March 2010
- KDB 865664, "SAR Measurement Requirements for 100 MHz to 6 GHz"

**Additional Documentation:**

- DASY4/5 System Handbook

**Methods Applied and Interpretation of Parameters:**

- Measurement Conditions:* Further details are available from the Validation Report at the end of the certificate. All figures stated in the certificate are valid at the frequency indicated.
- Antenna Parameters with TSL:* The dipole is mounted with the spacer to position its feed point exactly below the center marking of the flat phantom section, with the arms oriented parallel to the body axis.
- Feed Point Impedance and Return Loss:* These parameters are measured with the dipole positioned under the liquid filled phantom. The impedance stated is transformed from the measurement at the SMA connector to the feed point. The Return Loss ensures low reflected power. No uncertainty required.
- Electrical Delay:* One-way delay between the SMA connector and the antenna feed point. No uncertainty required.
- SAR measured:* SAR measured at the stated antenna input power.
- SAR normalized:* SAR as measured, normalized to an input power of 1 W at the antenna connector.
- SAR for nominal TSL parameters:* The measured TSL parameters are used to calculate the nominal SAR result.

The reported uncertainty of measurement is stated as the standard uncertainty of measurement multiplied by the coverage factor  $k=2$ , which for a normal distribution corresponds to a coverage probability of approximately 95%.



**Measurement Conditions**

DASY system configuration, as far as not given on page 1.

DASY Version	DASY5	V52.8.8
Extrapolation	Advanced Extrapolation	
Phantom	Modular Flat Phantom V5.0	
Distance Dipole Center - TSL	10 mm	with Spacer
Zoom Scan Resolution	dx, dy = 4.0 mm, dz = 1.4 mm	Graded Ratio = 1.4 (Z direction)
Frequency	5200 MHz ± 1 MHz 5250 MHz ± 1 MHz 5300 MHz ± 1 MHz 5500 MHz ± 1 MHz 5600 MHz ± 1 MHz 5750 MHz ± 1 MHz 5800 MHz ± 1 MHz	

**Head TSL parameters at 5200 MHz**

The following parameters and calculations were applied.

	Temperature	Permittivity	Conductivity
Nominal Head TSL parameters	22.0 °C	36.0	4.66 mho/m
Measured Head TSL parameters	(22.0 ± 0.2) °C	35.2 ± 6 %	4.51 mho/m ± 6 %
Head TSL temperature change during test	< 0.5 °C	---	---

**SAR result with Head TSL at 5200 MHz**

SAR averaged over 1 cm <sup>3</sup> (1 g) of Head TSL	Condition	
SAR measured	100 mW input power	7.79 W/kg
SAR for nominal Head TSL parameters	normalized to 1W	77.5 W/kg ± 19.9 % (k=2)

SAR averaged over 10 cm <sup>3</sup> (10 g) of Head TSL	condition	
SAR measured	100 mW input power	2.25 W/kg
SAR for nominal Head TSL parameters	normalized to 1W	22.3 W/kg ± 19.5 % (k=2)

#### Head TSL parameters at 5250 MHz

The following parameters and calculations were applied.

	Temperature	Permittivity	Conductivity
Nominal Head TSL parameters	22.0 °C	35.9	4.71 mho/m
Measured Head TSL parameters	(22.0 ± 0.2) °C	35.2 ± 6 %	4.55 mho/m ± 6 %
Head TSL temperature change during test	< 0.5 °C	---	---

#### SAR result with Head TSL at 5250 MHz

SAR averaged over 1 cm <sup>3</sup> (1 g) of Head TSL	Condition	
SAR measured	100 mW input power	8.00 W/kg
SAR for nominal Head TSL parameters	normalized to 1W	<b>79.6 W/kg ± 19.9 % (k=2)</b>

SAR averaged over 10 cm <sup>3</sup> (10 g) of Head TSL	condition	
SAR measured	100 mW input power	2.31 W/kg
SAR for nominal Head TSL parameters	normalized to 1W	<b>22.9 W/kg ± 19.5 % (k=2)</b>

#### Head TSL parameters at 5300 MHz

The following parameters and calculations were applied.

	Temperature	Permittivity	Conductivity
Nominal Head TSL parameters	22.0 °C	35.9	4.76 mho/m
Measured Head TSL parameters	(22.0 ± 0.2) °C	35.1 ± 6 %	4.60 mho/m ± 6 %
Head TSL temperature change during test	< 0.5 °C	---	---

#### SAR result with Head TSL at 5300 MHz

SAR averaged over 1 cm <sup>3</sup> (1 g) of Head TSL	Condition	
SAR measured	100 mW input power	8.28 W/kg
SAR for nominal Head TSL parameters	normalized to 1W	<b>82.3 W/kg ± 19.9 % (k=2)</b>

SAR averaged over 10 cm <sup>3</sup> (10 g) of Head TSL	condition	
SAR measured	100 mW input power	2.39 W/kg
SAR for nominal Head TSL parameters	normalized to 1W	<b>23.7 W/kg ± 19.5 % (k=2)</b>

#### Head TSL parameters at 5500 MHz

The following parameters and calculations were applied.

	Temperature	Permittivity	Conductivity
Nominal Head TSL parameters	22.0 °C	35.6	4.96 mho/m
Measured Head TSL parameters	(22.0 ± 0.2) °C	34.8 ± 6 %	4.79 mho/m ± 6 %
Head TSL temperature change during test	< 0.5 °C	----	----

#### SAR result with Head TSL at 5500 MHz

SAR averaged over 1 cm <sup>3</sup> (1 g) of Head TSL	Condition	
SAR measured	100 mW input power	8.10 W/kg
SAR for nominal Head TSL parameters	normalized to 1W	<b>80.5 W/kg ± 19.9 % (k=2)</b>

SAR averaged over 10 cm <sup>3</sup> (10 g) of Head TSL	condition	
SAR measured	100 mW input power	2.32 W/kg
SAR for nominal Head TSL parameters	normalized to 1W	<b>23.0 W/kg ± 19.5 % (k=2)</b>

#### Head TSL parameters at 5600 MHz

The following parameters and calculations were applied.

	Temperature	Permittivity	Conductivity
Nominal Head TSL parameters	22.0 °C	35.5	5.07 mho/m
Measured Head TSL parameters	(22.0 ± 0.2) °C	34.7 ± 6 %	4.90 mho/m ± 6 %
Head TSL temperature change during test	< 0.5 °C	----	----

#### SAR result with Head TSL at 5600 MHz

SAR averaged over 1 cm <sup>3</sup> (1 g) of Head TSL	Condition	
SAR measured	100 mW input power	8.42 W/kg
SAR for nominal Head TSL parameters	normalized to 1W	<b>83.7 W/kg ± 19.9 % (k=2)</b>

SAR averaged over 10 cm <sup>3</sup> (10 g) of Head TSL	condition	
SAR measured	100 mW input power	2.43 W/kg
SAR for nominal Head TSL parameters	normalized to 1W	<b>24.1 W/kg ± 19.5 % (k=2)</b>

#### Head TSL parameters at 5750 MHz

The following parameters and calculations were applied.

	Temperature	Permittivity	Conductivity
Nominal Head TSL parameters	22.0 °C	35.4	5.22 mho/m
Measured Head TSL parameters	(22.0 ± 0.2) °C	34.5 ± 6 %	5.05 mho/m ± 6 %
Head TSL temperature change during test	< 0.5 °C	----	----

#### SAR result with Head TSL at 5750 MHz

SAR averaged over 1 cm <sup>3</sup> (1 g) of Head TSL	Condition	
SAR measured	100 mW input power	7.96 W/kg
SAR for nominal Head TSL parameters	normalized to 1W	79.1 W/kg ± 19.9 % (k=2)

SAR averaged over 10 cm <sup>3</sup> (10 g) of Head TSL	condition	
SAR measured	100 mW input power	2.28 W/kg
SAR for nominal Head TSL parameters	normalized to 1W	22.6 W/kg ± 19.5 % (k=2)

#### Head TSL parameters at 5800 MHz

The following parameters and calculations were applied.

	Temperature	Permittivity	Conductivity
Nominal Head TSL parameters	22.0 °C	35.3	5.27 mho/m
Measured Head TSL parameters	(22.0 ± 0.2) °C	34.4 ± 6 %	5.10 mho/m ± 6 %
Head TSL temperature change during test	< 0.5 °C	----	----

#### SAR result with Head TSL at 5800 MHz

SAR averaged over 1 cm <sup>3</sup> (1 g) of Head TSL	Condition	
SAR measured	100 mW input power	7.99 W/kg
SAR for nominal Head TSL parameters	normalized to 1W	79.4 W/kg ± 19.9 % (k=2)

SAR averaged over 10 cm <sup>3</sup> (10 g) of Head TSL	condition	
SAR measured	100 mW input power	2.29 W/kg
SAR for nominal Head TSL parameters	normalized to 1W	22.7 W/kg ± 19.5 % (k=2)

**Body TSL parameters at 5250 MHz**

The following parameters and calculations were applied.

	Temperature	Permittivity	Conductivity
Nominal Body TSL parameters	22.0 °C	48.9	5.36 mho/m
Measured Body TSL parameters	(22.0 ± 0.2) °C	47.0 ± 6 %	5.44 mho/m ± 6 %
Body TSL temperature change during test	< 0.5 °C	----	----

**SAR result with Body TSL at 5250 MHz**

SAR averaged over 1 cm <sup>3</sup> (1 g) of Body TSL	Condition	
SAR measured	100 mW input power	7.36 W/kg
SAR for nominal Body TSL parameters	normalized to 1W	<b>73.0 W/kg ± 19.9 % (k=2)</b>

SAR averaged over 10 cm <sup>3</sup> (10 g) of Body TSL	condition	
SAR measured	100 mW input power	2.09 W/kg
SAR for nominal Body TSL parameters	normalized to 1W	<b>20.7 W/kg ± 19.5 % (k=2)</b>

**Body TSL parameters at 5600 MHz**

The following parameters and calculations were applied.

	Temperature	Permittivity	Conductivity
Nominal Body TSL parameters	22.0 °C	48.5	5.77 mho/m
Measured Body TSL parameters	(22.0 ± 0.2) °C	46.4 ± 6 %	5.91 mho/m ± 6 %
Body TSL temperature change during test	< 0.5 °C	----	----

**SAR result with Body TSL at 5600 MHz**

SAR averaged over 1 cm <sup>3</sup> (1 g) of Body TSL	Condition	
SAR measured	100 mW input power	7.82 W/kg
SAR for nominal Body TSL parameters	normalized to 1W	<b>77.6 W/kg ± 19.9 % (k=2)</b>

SAR averaged over 10 cm <sup>3</sup> (10 g) of Body TSL	condition	
SAR measured	100 mW input power	2.21 W/kg
SAR for nominal Body TSL parameters	normalized to 1W	<b>21.9 W/kg ± 19.5 % (k=2)</b>

**Body TSL parameters at 5750 MHz**

The following parameters and calculations were applied.

	Temperature	Permittivity	Conductivity
Nominal Body TSL parameters	22.0 °C	48.3	5.94 mho/m
Measured Body TSL parameters	(22.0 ± 0.2) °C	46.1 ± 6 %	6.12 mho/m ± 6 %
Body TSL temperature change during test	< 0.5 °C	---	----

**SAR result with Body TSL at 5750 MHz**

SAR averaged over 1 cm <sup>3</sup> (1 g) of Body TSL	Condition	
SAR measured	100 mW input power	7.39 W/kg
SAR for nominal Body TSL parameters	normalized to 1W	73.3 W/kg ± 19.9 % (k=2)

SAR averaged over 10 cm <sup>3</sup> (10 g) of Body TSL	condition	
SAR measured	100 mW input power	2.07 W/kg
SAR for nominal Body TSL parameters	normalized to 1W	20.5 W/kg ± 19.5 % (k=2)

**Appendix (Additional assessments outside the scope of SCS 0108)**

**Antenna Parameters with Head TSL at 5200 MHz**

Impedance, transformed to feed point	49.4 $\Omega$ - 9.7 j $\Omega$
Return Loss	- 20.2 dB

**Antenna Parameters with Head TSL at 5250 MHz**

Impedance, transformed to feed point	49.4 $\Omega$ - 5.7 j $\Omega$
Return Loss	- 24.7 dB

**Antenna Parameters with Head TSL at 5300 MHz**

Impedance, transformed to feed point	51.7 $\Omega$ - 3.6 j $\Omega$
Return Loss	- 28.3 dB

**Antenna Parameters with Head TSL at 5500 MHz**

Impedance, transformed to feed point	49.2 $\Omega$ - 1.5 j $\Omega$
Return Loss	- 35.0 dB

**Antenna Parameters with Head TSL at 5600 MHz**

Impedance, transformed to feed point	54.8 $\Omega$ - 3.3 j $\Omega$
Return Loss	- 25.1 dB

**Antenna Parameters with Head TSL at 5750 MHz**

Impedance, transformed to feed point	57.5 $\Omega$ + 0.3 j $\Omega$
Return Loss	- 23.1 dB

**Antenna Parameters with Head TSL at 5800 MHz**

Impedance, transformed to feed point	56.0 $\Omega$ + 0.1 j $\Omega$
Return Loss	- 25.0 dB

**Antenna Parameters with Body TSL at 5250 MHz**

Impedance, transformed to feed point	51.8 $\Omega$ - 5.2 j $\Omega$
Return Loss	- 25.4 dB

**Antenna Parameters with Body TSL at 5600 MHz**

Impedance, transformed to feed point	54.4 $\Omega$ - 1.6 j $\Omega$
Return Loss	- 26.9 dB

**Antenna Parameters with Body TSL at 5750 MHz**

Impedance, transformed to feed point	58.8 $\Omega$ + 0.9 j $\Omega$
Return Loss	- 21.8 dB

**General Antenna Parameters and Design**

Electrical Delay (one direction)	1.199 ns
----------------------------------	----------

After long term use with 100W radiated power, only a slight warming of the dipole near the feedpoint can be measured.

The dipole is made of standard semirigid coaxial cable. The center conductor of the feeding line is directly connected to the second arm of the dipole. The antenna is therefore short-circuited for DC-signals. On some of the dipoles, small end caps are added to the dipole arms in order to improve matching when loaded according to the position as explained in the "Measurement Conditions" paragraph. The SAR data are not affected by this change. The overall dipole length is still according to the Standard.

No excessive force must be applied to the dipole arms, because they might bend or the soldered connections near the feedpoint may be damaged.

**Additional EUT Data**

Manufactured by	SPEAG
Manufactured on	February 05, 2004



## DASY5 Validation Report for Head TSL

Date: 20.01.2016

Test Laboratory: SPEAG, Zurich, Switzerland

**DUT: Dipole D5GHzV2; Type: D5GHzV2; Serial: D5GHzV2 - SN: 1020**

Communication System: UID 0 - CW; Frequency: 5200 MHz, Frequency: 5250 MHz, Frequency: 5300 MHz, Frequency: 5500 MHz, Frequency: 5600 MHz, Frequency: 5750 MHz, Frequency: 5800 MHz  
Medium parameters used:  $f = 5200$  MHz;  $\sigma = 4.51$  S/m;  $\epsilon_r = 35.2$ ;  $\rho = 1000$  kg/m<sup>3</sup>, Medium parameters used:  $f = 5250$  MHz;  $\sigma = 4.55$  S/m;  $\epsilon_r = 35.2$ ;  $\rho = 1000$  kg/m<sup>3</sup>, Medium parameters used:  $f = 5300$  MHz;  $\sigma = 4.6$  S/m;  $\epsilon_r = 35.1$ ;  $\rho = 1000$  kg/m<sup>3</sup>, Medium parameters used:  $f = 5500$  MHz;  $\sigma = 4.79$  S/m;  $\epsilon_r = 34.8$ ;  $\rho = 1000$  kg/m<sup>3</sup>, Medium parameters used:  $f = 5600$  MHz;  $\sigma = 4.9$  S/m;  $\epsilon_r = 34.7$ ;  $\rho = 1000$  kg/m<sup>3</sup>, Medium parameters used:  $f = 5750$  MHz;  $\sigma = 5.05$  S/m;  $\epsilon_r = 34.5$ ;  $\rho = 1000$  kg/m<sup>3</sup>, Medium parameters used:  $f = 5800$  MHz;  $\sigma = 5.1$  S/m;  $\epsilon_r = 34.4$ ;  $\rho = 1000$  kg/m<sup>3</sup>  
Phantom section: Flat Section  
Measurement Standard: DASY5 (IEEE/IEC/ANSI C63.19-2011)

DASY52 Configuration:

- Probe: EX3DV4 - SN3503; ConvF(5.59, 5.59, 5.59); Calibrated: 31.12.2015, ConvF(5.53, 5.53, 5.53); Calibrated: 31.12.2015, ConvF(5.25, 5.25, 5.25); Calibrated: 31.12.2015, ConvF(5.18, 5.18, 5.18); Calibrated: 31.12.2015, ConvF(4.99, 4.99, 4.99); Calibrated: 31.12.2015, ConvF(4.95, 4.95, 4.95); Calibrated: 31.12.2015; ConvF(4.95, 4.95, 4.95); Calibrated: 31.12.2015;
- Sensor-Surface: 1.4mm (Mechanical Surface Detection)
- Electronics: DAE4 Sn601; Calibrated: 30.12.2015
- Phantom: Flat Phantom 5.0 (front); Type: QD000P50AA; Serial: 1001
- DASY52 52.8.8(1258); SEMCAD X 14.6.10(7372)

**Dipole Calibration for Head Tissue 2/Pin=100mW, dist=10mm, f=5200 MHz/Zoom Scan, dist=1.4mm (8x8x7)/Cube 0:** Measurement grid: dx=4mm, dy=4mm, dz=1.4mm  
Reference Value = 72.07 V/m; Power Drift = 0.01 dB  
Peak SAR (extrapolated) = 28.1 W/kg  
**SAR(1 g) = 7.79 W/kg; SAR(10 g) = 2.25 W/kg**  
Maximum value of SAR (measured) = 18.2 W/kg

**Dipole Calibration for Head Tissue 2/Pin=100mW, dist=10mm, f=5250 MHz/Zoom Scan, dist=1.4mm (8x8x7)/Cube 0:** Measurement grid: dx=4mm, dy=4mm, dz=1.4mm  
Reference Value = 72.72 V/m; Power Drift = 0.06 dB  
Peak SAR (extrapolated) = 29.2 W/kg  
**SAR(1 g) = 8 W/kg; SAR(10 g) = 2.31 W/kg**  
Maximum value of SAR (measured) = 18.7 W/kg

**Dipole Calibration for Head Tissue 2/Pin=100mW, dist=10mm, f=5300 MHz/Zoom Scan, dist=1.4mm (8x8x7)/Cube 0:** Measurement grid: dx=4mm, dy=4mm, dz=1.4mm  
Reference Value = 73.60 V/m; Power Drift = 0.09 dB  
Peak SAR (extrapolated) = 31.2 W/kg  
**SAR(1 g) = 8.28 W/kg; SAR(10 g) = 2.39 W/kg**  
Maximum value of SAR (measured) = 19.6 W/kg

**Dipole Calibration for Head Tissue 2/Pin=100mW, dist=10mm, f=5500 MHz/Zoom Scan, dist=1.4mm**  
(8x8x7)/Cube 0: Measurement grid: dx=4mm, dy=4mm, dz=1.4mm  
Reference Value = 72.02 V/m; Power Drift = 0.06 dB  
Peak SAR (extrapolated) = 32.0 W/kg  
**SAR(1 g) = 8.1 W/kg; SAR(10 g) = 2.32 W/kg**  
Maximum value of SAR (measured) = 19.7 W/kg

**Dipole Calibration for Head Tissue 2/Pin=100mW, dist=10mm, f=5600 MHz/Zoom Scan, dist=1.4mm**  
(8x8x7)/Cube 0: Measurement grid: dx=4mm, dy=4mm, dz=1.4mm  
Reference Value = 72.66 V/m; Power Drift = 0.02 dB  
Peak SAR (extrapolated) = 32.9 W/kg  
**SAR(1 g) = 8.42 W/kg; SAR(10 g) = 2.43 W/kg**  
Maximum value of SAR (measured) = 20.5 W/kg

**Dipole Calibration for Head Tissue 2/Pin=100mW, dist=10mm, f=5750 MHz/Zoom Scan, dist=1.4mm**  
(8x8x7)/Cube 0: Measurement grid: dx=4mm, dy=4mm, dz=1.4mm  
Reference Value = 70.61 V/m; Power Drift = 0.05 dB  
Peak SAR (extrapolated) = 32.4 W/kg  
**SAR(1 g) = 7.96 W/kg; SAR(10 g) = 2.28 W/kg**  
Maximum value of SAR (measured) = 19.5 W/kg

**Dipole Calibration for Head Tissue 2/Pin=100mW, dist=10mm, f=5800 MHz/Zoom Scan, dist=1.4mm**  
(8x8x7)/Cube 0: Measurement grid: dx=4mm, dy=4mm, dz=1.4mm  
Reference Value = 70.21 V/m; Power Drift = 0.07 dB  
Peak SAR (extrapolated) = 32.7 W/kg  
**SAR(1 g) = 7.99 W/kg; SAR(10 g) = 2.29 W/kg**  
Maximum value of SAR (measured) = 19.8 W/kg

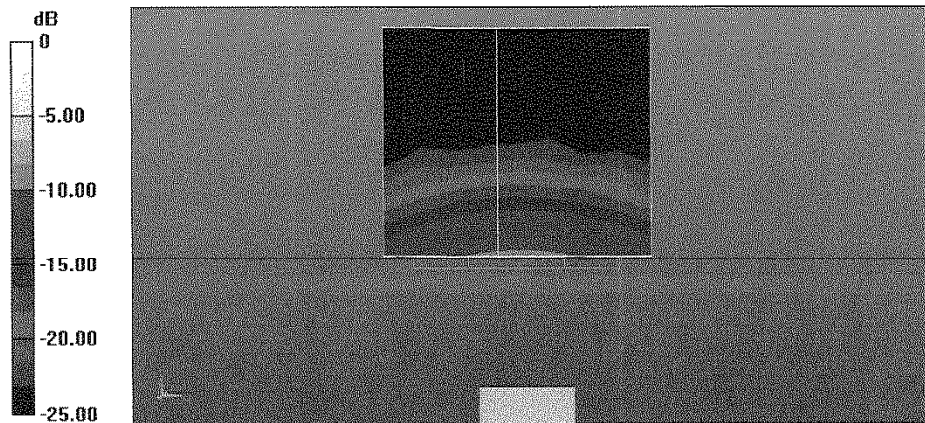

Impedance Measurement Plot for Head TSL (5200, 5300, 5600, 5800)

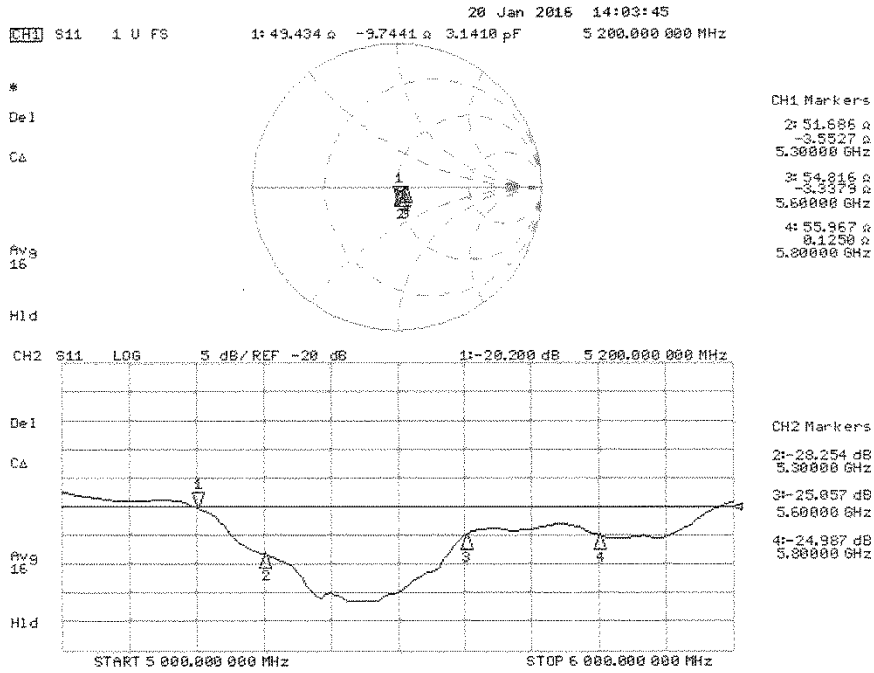

Impedance Measurement Plot for Head TSL (5250, 5500, 5750)

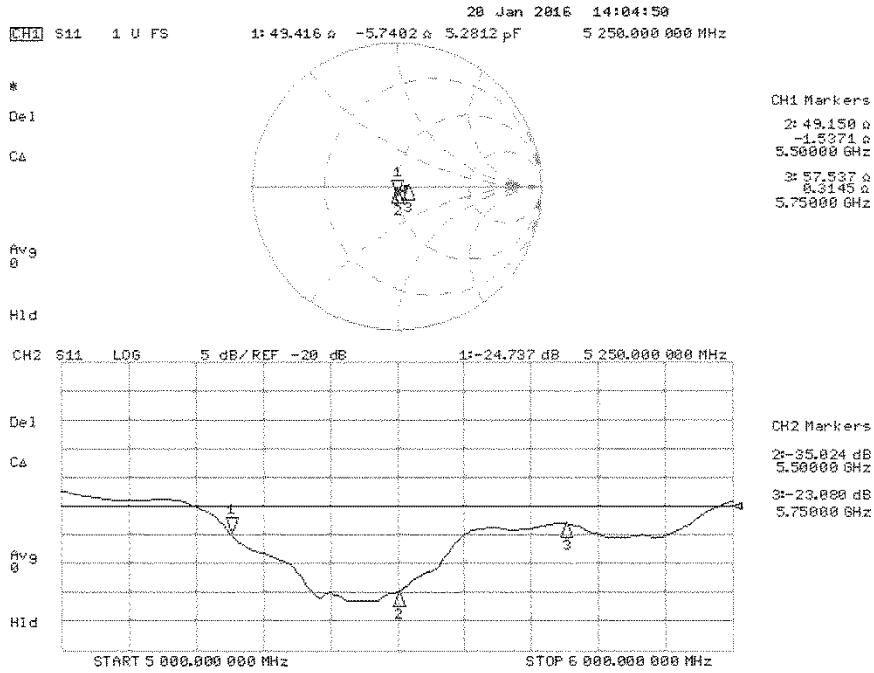

## DASY5 Validation Report for Body TSL

Date: 13.01.2016

Test Laboratory: SPEAG, Zurich, Switzerland

**DUT: Dipole 5GHz; Type: D5GHzV2; Serial: D5GHzV2 - SN: 1020**

Communication System: UID 0 - CW; Frequency: 5250 MHz, Frequency: 5600 MHz, Frequency: 5750 MHz  
Medium parameters used:  $f = 5250$  MHz;  $\sigma = 5.44$  S/m;  $\epsilon_r = 47$ ;  $\rho = 1000$  kg/m<sup>3</sup>, Medium parameters used:  $f = 5600$  MHz;  $\sigma = 5.91$  S/m;  $\epsilon_r = 46.4$ ;  $\rho = 1000$  kg/m<sup>3</sup>, Medium parameters used:  $f = 5750$  MHz;  $\sigma = 6.12$  S/m;  $\epsilon_r = 46.1$ ;  $\rho = 1000$  kg/m<sup>3</sup>

Phantom section: Flat Section

Measurement Standard: DASY5 (IEEE/IEC/ANSI C63.19-2011)

DASY52 Configuration:

- Probe: EX3DV4 - SN3503; ConvF(4.85, 4.85, 4.85); Calibrated: 31.12.2015, ConvF(4.35, 4.35, 4.35); Calibrated: 31.12.2015, ConvF(4.3, 4.3, 4.3); Calibrated: 31.12.2015;
- Sensor-Surface: 1.4mm (Mechanical Surface Detection)
- Electronics: DAE4 Sn601; Calibrated: 30.12.2015
- Phantom: Flat Phantom 5.0 (back); Type: QD000P50AA; Serial: 1002
- DASY52 52.8.8(1258); SEMCAD X 14.6.10(7372)

### Dipole Calibration for Body Tissue/Pin=100mW, dist=10mm, f=5250 MHz/Zoom Scan, dist=1.4mm

(8x8x7)/Cube 0: Measurement grid: dx=4mm, dy=4mm, dz=1.4mm

Reference Value = 66.83 V/m; Power Drift = -0.04 dB

Peak SAR (extrapolated) = 27.5 W/kg

**SAR(1 g) = 7.36 W/kg; SAR(10 g) = 2.09 W/kg**

Maximum value of SAR (measured) = 17.4 W/kg

### Dipole Calibration for Body Tissue/Pin=100mW, dist=10mm, f=5600 MHz/Zoom Scan, dist=1.4mm

(8x8x7)/Cube 0: Measurement grid: dx=4mm, dy=4mm, dz=1.4mm

Reference Value = 67.07 V/m; Power Drift = -0.01 dB

Peak SAR (extrapolated) = 31.9 W/kg

**SAR(1 g) = 7.82 W/kg; SAR(10 g) = 2.21 W/kg**

Maximum value of SAR (measured) = 19.1 W/kg

### Dipole Calibration for Body Tissue/Pin=100mW, dist=10mm, f=5750 MHz/Zoom Scan, dist=1.4mm

(8x8x7)/Cube 0: Measurement grid: dx=4mm, dy=4mm, dz=1.4mm

Reference Value = 64.16 V/m; Power Drift = 0.01 dB

Peak SAR (extrapolated) = 31.5 W/kg

**SAR(1 g) = 7.39 W/kg; SAR(10 g) = 2.07 W/kg**

Maximum value of SAR (measured) = 18.3 W/kg

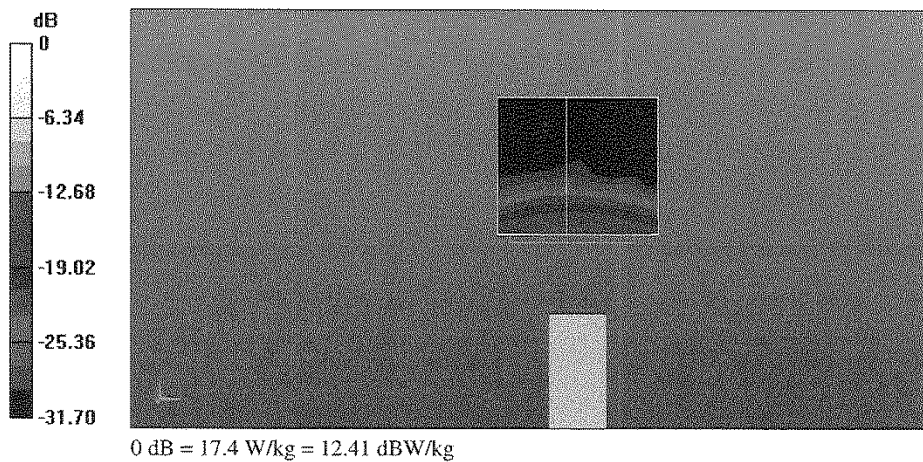

Impedance Measurement Plot for Body TSL

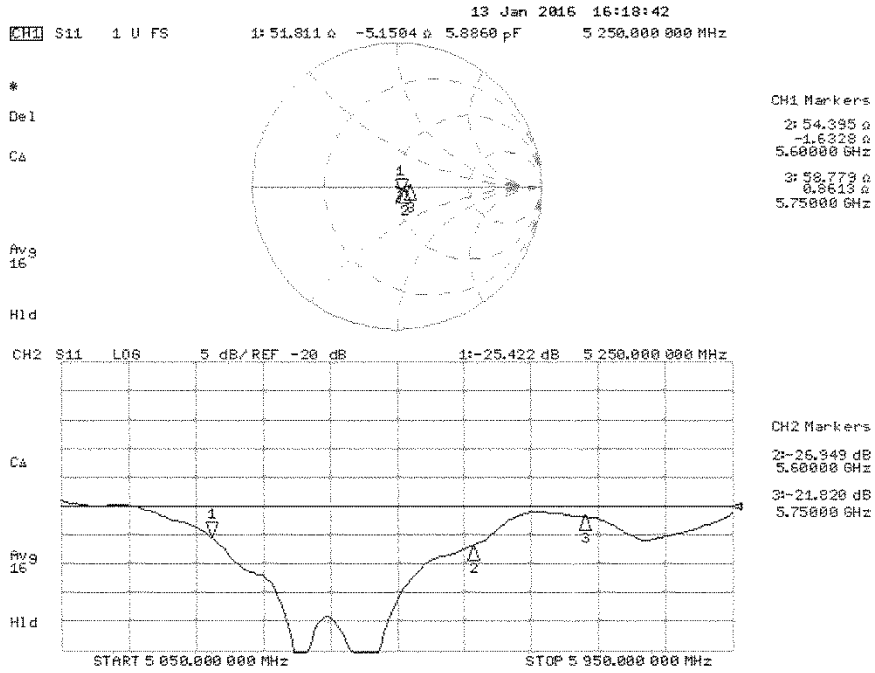

**Dosimetric E-Field Probe Calibration Certificate (EX3DV4, S/N: 3825)**

**Calibration Laboratory of  
 Schmid & Partner  
 Engineering AG**  
 Zeughausstrasse 43, 8004 Zurich, Switzerland



**S** Schweizerischer Kalibrierdienst  
**S** Service suisse d'étalonnage  
**S** Servizio svizzero di taratura  
**S** Swiss Calibration Service

Accredited by the Swiss Accreditation Service (SAS)  
 The Swiss Accreditation Service is one of the signatories to the EA  
 Multilateral Agreement for the recognition of calibration certificates

Accreditation No.: **SCS 0108**

Client **UL Japan (Vitec)**

Certificate No: **EX3-3825\_Dec15**

**CALIBRATION CERTIFICATE**

Object **EX3DV4 - SN:3825**

Calibration procedure(s) **QA CAL-01.v9, QA CAL-14.v4, QA CAL-23.v5, QA CAL-25.v6  
 Calibration procedure for dosimetric E-field probes**

Calibration date: **December 11, 2015**

This calibration certificate documents the traceability to national standards, which realize the physical units of measurements (SI).  
 The measurements and the uncertainties with confidence probability are given on the following pages and are part of the certificate.

All calibrations have been conducted in the closed laboratory facility: environment temperature (22 ± 3)°C and humidity < 70%.

Calibration Equipment used (M&TE critical for calibration)

Primary Standards	ID	Cal Date (Certificate No.)	Scheduled Calibration
Power meter E4419B	GB41293874	01-Apr-15 (No. 217-02128)	Mar-16
Power sensor E4412A	MY41498087	01-Apr-15 (No. 217-02128)	Mar-16
Reference 3 dB Attenuator	SN: S5054 (3c)	01-Apr-15 (No. 217-02129)	Mar-16
Reference 20 dB Attenuator	SN: S5277 (20x)	01-Apr-15 (No. 217-02132)	Mar-16
Reference 30 dB Attenuator	SN: S5129 (30b)	01-Apr-15 (No. 217-02133)	Mar-16
Reference Probe ES3DV2	SN: 3013	30-Dec-14 (No. ES3-3013_Dec14)	Dec-15
DAE4	SN: 660	14-Jan-15 (No. DAE4-660_Jan15)	Jan-16
Secondary Standards	ID	Check Date (in house)	Scheduled Check
RF generator HP 8648C	US3642U01700	4-Aug-99 (in house check Apr-13)	In house check: Apr-16
Network Analyzer HP 8753E	US37390585	18-Oct-01 (in house check Oct-15)	In house check: Oct-16

Calibrated by:	Name <b>Leif Klysner</b>	Function <b>Laboratory Technician</b>	Signature 
Approved by:	Name <b>Katja Pokovic</b>	Function <b>Technical Manager</b>	Signature 

Issued: December 15, 2015

This calibration certificate shall not be reproduced except in full without written approval of the laboratory.



Calibration Laboratory of  
Schmid & Partner  
Engineering AG  
Zeughausstrasse 43, 8004 Zurich, Switzerland



S Schweizerischer Kalibrierdienst  
C Service suisse d'étalonnage  
S Servizio svizzero di taratura  
Swiss Calibration Service

Accredited by the Swiss Accreditation Service (SAS)  
The Swiss Accreditation Service is one of the signatories to the EA  
Multilateral Agreement for the recognition of calibration certificates

Accreditation No.: SCS 0108

### Glossary:

TSL	tissue simulating liquid
NORM <sub>x,y,z</sub>	sensitivity in free space
ConvF	sensitivity in TSL / NORM <sub>x,y,z</sub>
DCP	diode compression point
CF	crest factor (1/duty_cycle) of the RF signal
A, B, C, D	modulation dependent linearization parameters
Polarization $\varphi$	$\varphi$ rotation around probe axis
Polarization $\vartheta$	$\vartheta$ rotation around an axis that is in the plane normal to probe axis (at measurement center), i.e., $\vartheta = 0$ is normal to probe axis
Connector Angle	information used in DASY system to align probe sensor X to the robot coordinate system

### Calibration is Performed According to the Following Standards:

- IEEE Std 1528-2013, "IEEE Recommended Practice for Determining the Peak Spatial-Averaged Specific Absorption Rate (SAR) in the Human Head from Wireless Communications Devices: Measurement Techniques", June 2013
- IEC 62209-1, "Procedure to measure the Specific Absorption Rate (SAR) for hand-held devices used in close proximity to the ear (frequency range of 300 MHz to 3 GHz)", February 2005
- IEC 62209-2, "Procedure to determine the Specific Absorption Rate (SAR) for wireless communication devices used in close proximity to the human body (frequency range of 30 MHz to 6 GHz)", March 2010
- KDB 865664, "SAR Measurement Requirements for 100 MHz to 6 GHz"

### Methods Applied and Interpretation of Parameters:

- NORM<sub>x,y,z</sub>**: Assessed for E-field polarization  $\vartheta = 0$  ( $f \leq 900$  MHz in TEM-cell;  $f > 1800$  MHz: R22 waveguide). NORM<sub>x,y,z</sub> are only intermediate values, i.e., the uncertainties of NORM<sub>x,y,z</sub> does not affect the E<sup>2</sup>-field uncertainty inside TSL (see below ConvF).
- NORM(f)<sub>x,y,z</sub> = NORM<sub>x,y,z</sub> \* frequency\_response** (see Frequency Response Chart). This linearization is implemented in DASY4 software versions later than 4.2. The uncertainty of the frequency response is included in the stated uncertainty of ConvF.
- DCP<sub>x,y,z</sub>**: DCP are numerical linearization parameters assessed based on the data of power sweep with CW signal (no uncertainty required). DCP does not depend on frequency nor media.
- PAR**: PAR is the Peak to Average Ratio that is not calibrated but determined based on the signal characteristics
- A<sub>x,y,z</sub>; B<sub>x,y,z</sub>; C<sub>x,y,z</sub>; D<sub>x,y,z</sub>; VR<sub>x,y,z</sub>; A, B, C, D** are numerical linearization parameters assessed based on the data of power sweep for specific modulation signal. The parameters do not depend on frequency nor media. VR is the maximum calibration range expressed in RMS voltage across the diode.
- ConvF and Boundary Effect Parameters**: Assessed in flat phantom using E-field (or Temperature Transfer Standard for  $f \leq 800$  MHz) and inside waveguide using analytical field distributions based on power measurements for  $f > 800$  MHz. The same setups are used for assessment of the parameters applied for boundary compensation (alpha, depth) of which typical uncertainty values are given. These parameters are used in DASY4 software to improve probe accuracy close to the boundary. The sensitivity in TSL corresponds to NORM<sub>x,y,z</sub> \* ConvF whereby the uncertainty corresponds to that given for ConvF. A frequency dependent ConvF is used in DASY version 4.4 and higher which allows extending the validity from  $\pm 50$  MHz to  $\pm 100$  MHz.
- Spherical isotropy (3D deviation from isotropy)**: in a field of low gradients realized using a flat phantom exposed by a patch antenna.
- Sensor Offset**: The sensor offset corresponds to the offset of virtual measurement center from the probe tip (on probe axis). No tolerance required.
- Connector Angle**: The angle is assessed using the information gained by determining the NORM<sub>x</sub> (no uncertainty required).

UL Japan, Inc.

Ise EMC Lab.

4383-326 Asama-cho, Ise-shi, Mie-ken 516-0021 JAPAN

Telephone: +81 596 24 8999

Facsimile: +81 596 24 8124

EX3DV4 – SN:3825

December 11, 2015

# Probe EX3DV4

## SN:3825

Manufactured: September 6, 2011  
Calibrated: December 11, 2015

Calibrated for DASYS/EASY Systems  
(Note: non-compatible with DASYS2 system!)

EX3DV4- SN:3825

December 11, 2015

## DASY/EASY - Parameters of Probe: EX3DV4 - SN:3825

### Basic Calibration Parameters

	Sensor X	Sensor Y	Sensor Z	Unc (k=2)
Norm ( $\mu\text{V}/(\text{V}/\text{m})^2$ ) <sup>A</sup>	0.43	0.39	0.43	$\pm 10.1 \%$
DCP (mV) <sup>B</sup>	101.4	102.7	100.2	

### Modulation Calibration Parameters

UID	Communication System Name		A dB	B dB $\sqrt{\mu\text{V}}$	C	D dB	VR mV	Unc <sup>E</sup> (k=2)
0	CW	X	0.0	0.0	1.0	0.00	143.6	$\pm 2.7 \%$
		Y	0.0	0.0	1.0		139.1	
		Z	0.0	0.0	1.0		153.8	

The reported uncertainty of measurement is stated as the standard uncertainty of measurement multiplied by the coverage factor k=2, which for a normal distribution corresponds to a coverage probability of approximately 95%.

<sup>A</sup> The uncertainties of Norm X,Y,Z do not affect the E<sup>2</sup>-field uncertainty inside TSL (see Pages 5 and 6).

<sup>B</sup> Numerical linearization parameter: uncertainty not required.

<sup>E</sup> Uncertainty is determined using the max. deviation from linear response applying rectangular distribution and is expressed for the square of the field value.

EX3DV4- SN:3825

December 11, 2015

## DASY/EASY - Parameters of Probe: EX3DV4 - SN:3825

### Calibration Parameter Determined in Head Tissue Simulating Media

f (MHz) <sup>C</sup>	Relative Permittivity <sup>F</sup>	Conductivity (S/m) <sup>F</sup>	ConvF X	ConvF Y	ConvF Z	Alpha <sup>G</sup>	Depth <sup>G</sup> (mm)	Unc (k=2)
750	41.9	0.89	9.79	9.79	9.79	0.23	1.25	± 12.0 %
835	41.5	0.90	9.49	9.49	9.49	0.21	1.30	± 12.0 %
900	41.5	0.97	9.23	9.23	9.23	0.24	1.24	± 12.0 %
1450	40.5	1.20	8.30	8.30	8.30	0.12	2.03	± 12.0 %
1750	40.1	1.37	8.18	8.18	8.18	0.24	0.95	± 12.0 %
1900	40.0	1.40	7.94	7.94	7.94	0.31	0.85	± 12.0 %
1950	40.0	1.40	7.69	7.69	7.69	0.31	0.85	± 12.0 %
2450	39.2	1.80	7.31	7.31	7.31	0.34	0.83	± 12.0 %
3500	37.9	2.91	6.91	6.91	6.91	0.28	1.25	± 13.1 %
5200	36.0	4.66	5.13	5.13	5.13	0.35	1.80	± 13.1 %
5250	35.9	4.71	5.06	5.06	5.06	0.35	1.80	± 13.1 %
5300	35.9	4.76	4.83	4.83	4.83	0.40	1.80	± 13.1 %
5500	35.6	4.96	4.60	4.60	4.60	0.45	1.80	± 13.1 %
5600	35.5	5.07	4.27	4.27	4.27	0.50	1.80	± 13.1 %
5750	35.4	5.22	4.44	4.44	4.44	0.50	1.80	± 13.1 %
5800	35.3	5.27	4.34	4.34	4.34	0.50	1.80	± 13.1 %

<sup>C</sup> Frequency validity above 300 MHz of ± 100 MHz only applies for DASY v4.4 and higher (see Page 2), else it is restricted to ± 50 MHz. The uncertainty is the RSS of the ConvF uncertainty at calibration frequency and the uncertainty for the indicated frequency band. Frequency validity below 300 MHz is ± 10, 25, 40, 50 and 70 MHz for ConvF assessments at 30, 64, 128, 150 and 220 MHz respectively. Above 5 GHz frequency validity can be extended to ± 110 MHz.

<sup>F</sup> At frequencies below 3 GHz, the validity of tissue parameters ( $\epsilon$  and  $\sigma$ ) can be relaxed to ± 10% if liquid compensation formula is applied to measured SAR values. At frequencies above 3 GHz, the validity of tissue parameters ( $\epsilon$  and  $\sigma$ ) is restricted to ± 5%. The uncertainty is the RSS of the ConvF uncertainty for indicated target tissue parameters.

<sup>G</sup> Alpha/Depth are determined during calibration. SPEAG warrants that the remaining deviation due to the boundary effect after compensation is always less than ± 1% for frequencies below 3 GHz and below ± 2% for frequencies between 3-6 GHz at any distance larger than half the probe tip diameter from the boundary.

## DASY/EASY - Parameters of Probe: EX3DV4 - SN:3825

### Calibration Parameter Determined in Body Tissue Simulating Media

f (MHz) <sup>C</sup>	Relative Permittivity <sup>F</sup>	Conductivity (S/m) <sup>F</sup>	ConvF X	ConvF Y	ConvF Z	Alpha <sup>G</sup>	Depth <sup>G</sup> (mm)	Unc (k=2)
750	55.5	0.96	9.89	9.89	9.89	0.35	0.92	± 12.0 %
835	55.2	0.97	9.67	9.67	9.67	0.23	1.22	± 12.0 %
900	55.0	1.05	9.56	9.56	9.56	0.30	0.98	± 12.0 %
1450	54.0	1.30	8.18	8.18	8.18	0.24	1.09	± 12.0 %
1750	53.4	1.49	7.94	7.94	7.94	0.32	0.88	± 12.0 %
1900	53.3	1.52	7.66	7.66	7.66	0.23	1.10	± 12.0 %
1950	53.3	1.52	7.93	7.93	7.93	0.29	0.96	± 12.0 %
2450	52.7	1.95	7.29	7.29	7.29	0.32	0.85	± 12.0 %
3500	51.3	3.31	6.39	6.39	6.39	0.36	1.06	± 13.1 %
5250	48.9	5.36	4.25	4.25	4.25	0.50	1.90	± 13.1 %
5600	48.5	5.77	3.61	3.61	3.61	0.60	1.90	± 13.1 %
5750	48.3	5.94	3.85	3.85	3.85	0.60	1.90	± 13.1 %

<sup>C</sup> Frequency validity above 300 MHz of ± 100 MHz only applies for DASY v4.4 and higher (see Page 2), else it is restricted to ± 50 MHz. The uncertainty is the RSS of the ConvF uncertainty at calibration frequency and the uncertainty for the indicated frequency band. Frequency validity below 300 MHz is ± 10, 25, 40, 50 and 70 MHz for ConvF assessments at 30, 64, 128, 150 and 220 MHz respectively. Above 5 GHz frequency validity can be extended to ± 110 MHz.

<sup>F</sup> At frequencies below 3 GHz, the validity of tissue parameters ( $\epsilon$  and  $\sigma$ ) can be relaxed to ± 10% if liquid compensation formula is applied to measured SAR values. At frequencies above 3 GHz, the validity of tissue parameters ( $\epsilon$  and  $\sigma$ ) is restricted to ± 5%. The uncertainty is the RSS of the ConvF uncertainty for indicated target tissue parameters.

<sup>G</sup> Alpha/Depth are determined during calibration. SPEAG warrants that the remaining deviation due to the boundary effect after compensation is always less than ± 1% for frequencies below 3 GHz and below ± 2% for frequencies between 3-6 GHz at any distance larger than half the probe tip diameter from the boundary.

EX3DV4- SN:3825

December 11, 2015

### Frequency Response of E-Field (TEM-Cell:ifi110 EXX, Waveguide: R22)

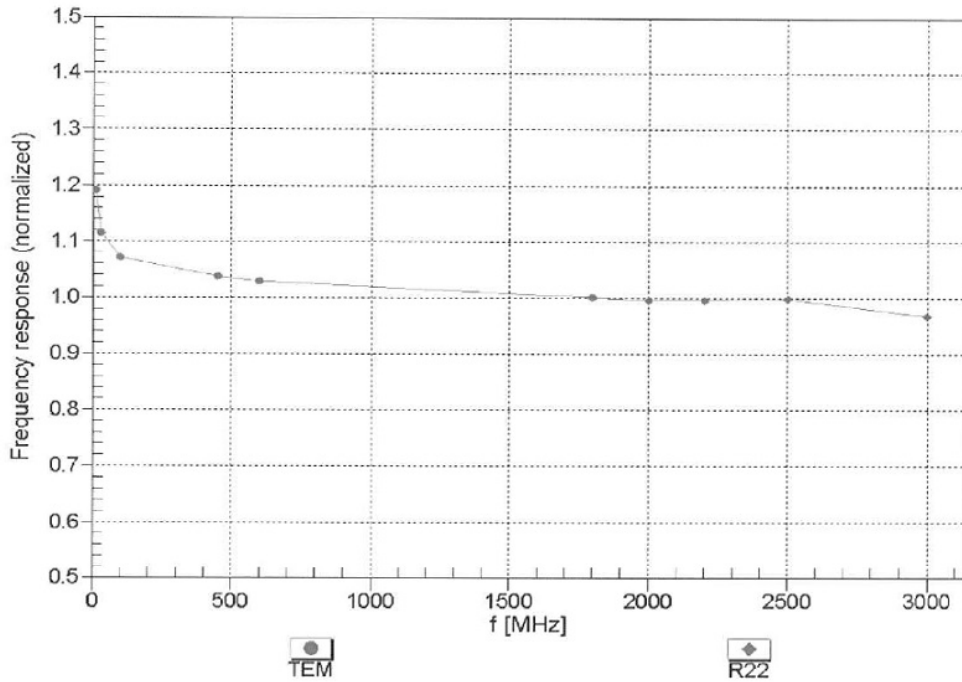

Uncertainty of Frequency Response of E-field:  $\pm 6.3\%$  (k=2)

EX3DV4- SN:3825

December 11, 2015

### Receiving Pattern ( $\phi$ ), $\theta = 0^\circ$

f=600 MHz,TEM

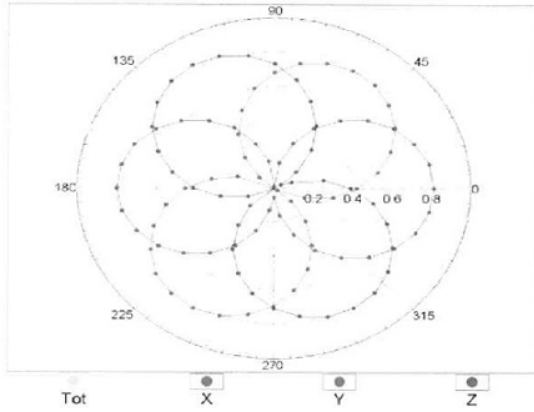

f=1800 MHz,R22

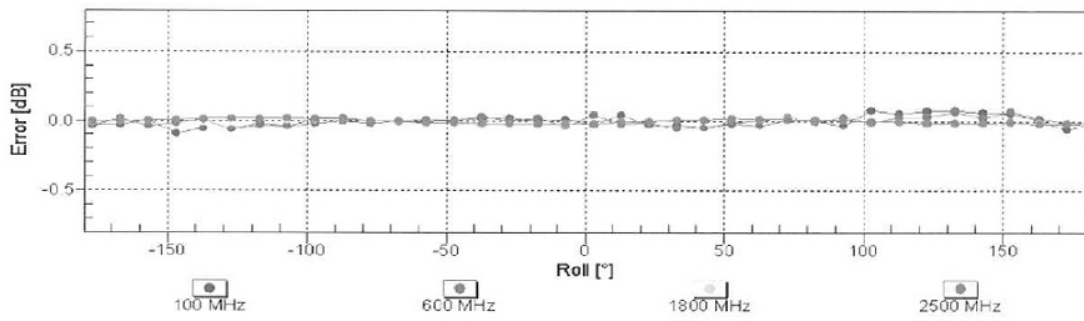
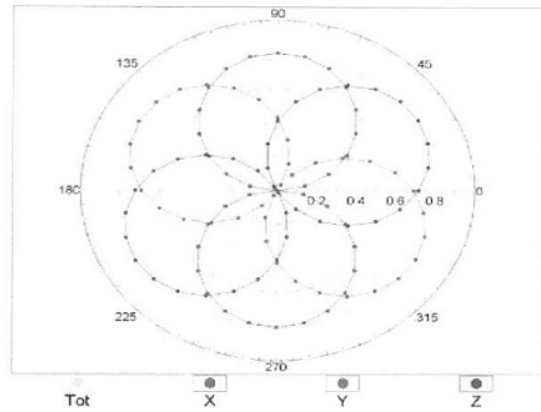

Uncertainty of Axial Isotropy Assessment:  $\pm 0.5\%$  (k=2)

EX3DV4- SN:3825

December 11, 2015

### Dynamic Range f(SAR<sub>head</sub>) (TEM cell , f<sub>eval</sub>= 1900 MHz)

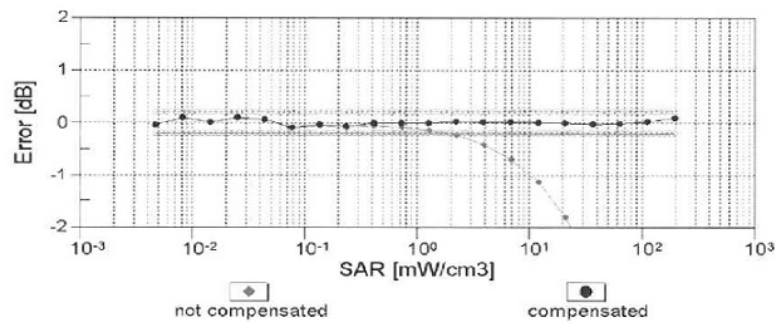
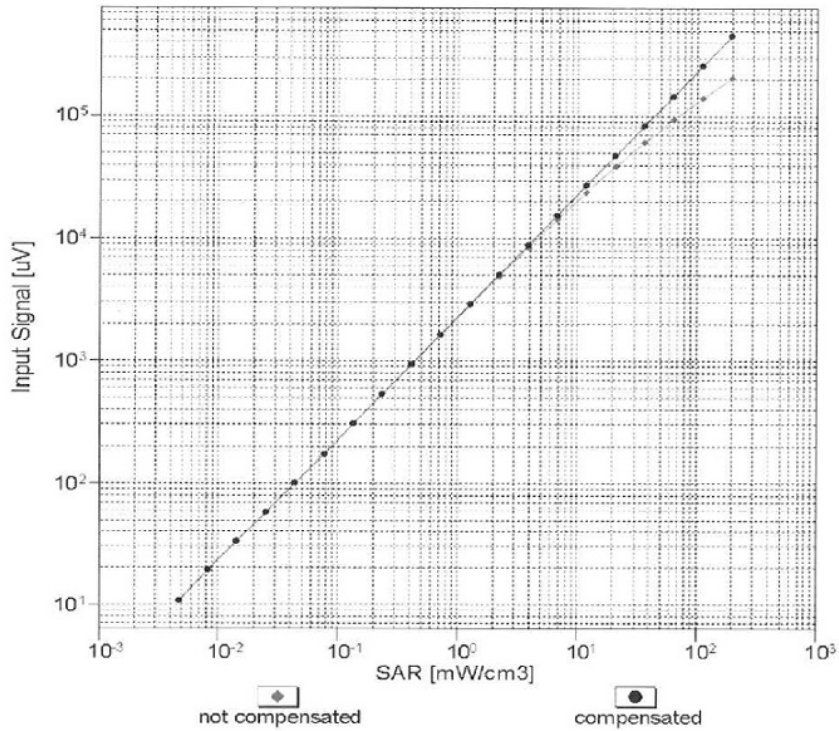

Uncertainty of Linearity Assessment: ± 0.6% (k=2)



EX3DV4- SN:3825

December 11, 2015

## Conversion Factor Assessment

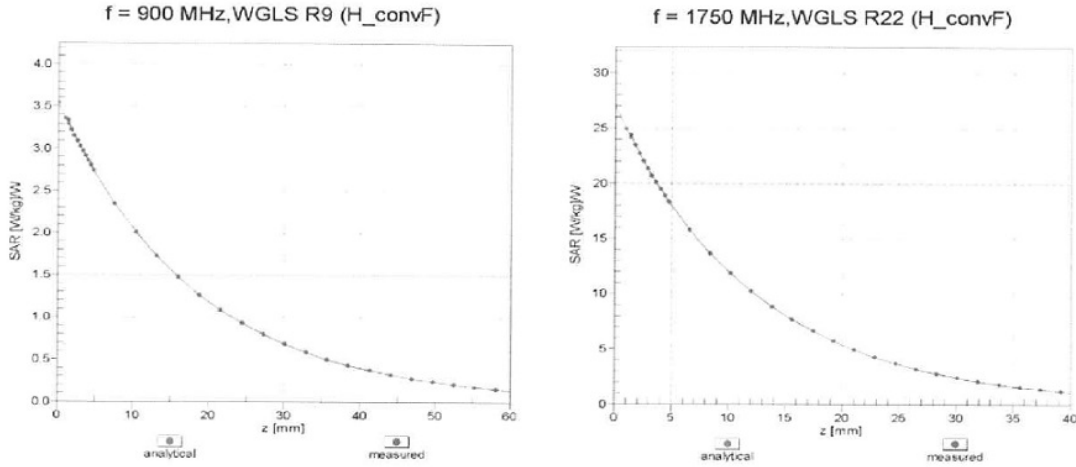

## Deviation from Isotropy in Liquid Error ( $\phi$ , $\theta$ ), f = 900 MHz

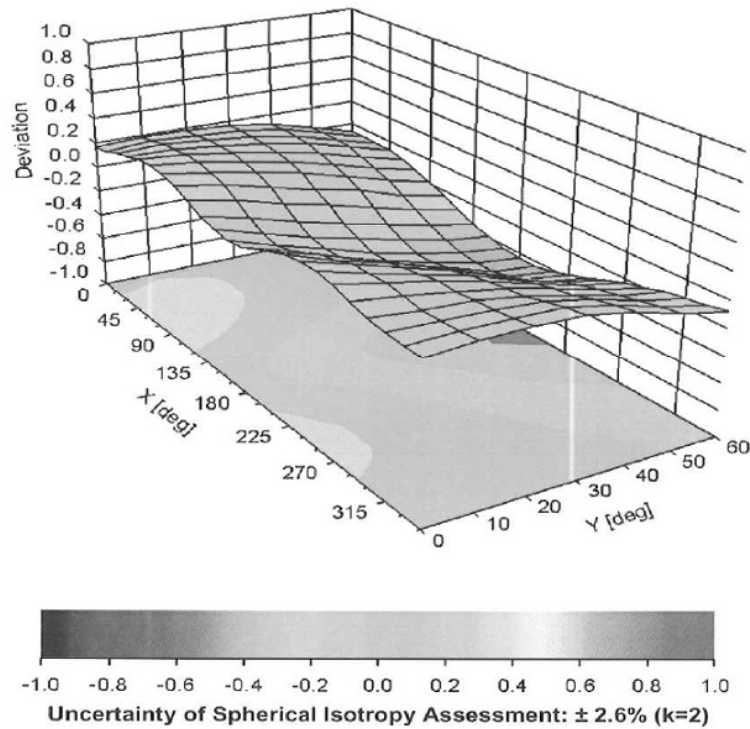

EX3DV4- SN:3825

December 11, 2015

## DASY/EASY - Parameters of Probe: EX3DV4 - SN:3825

### Other Probe Parameters

Sensor Arrangement	Triangular
Connector Angle (°)	-27.3
Mechanical Surface Detection Mode	enabled
Optical Surface Detection Mode	disabled
Probe Overall Length	337 mm
Probe Body Diameter	10 mm
Tip Length	9 mm
Tip Diameter	2.5 mm
Probe Tip to Sensor X Calibration Point	1 mm
Probe Tip to Sensor Y Calibration Point	1 mm
Probe Tip to Sensor Z Calibration Point	1 mm
Recommended Measurement Distance from Surface	1.4 mm

### System check uncertainty

The uncertainty budget has been determined for the DASY5 measurement system according to the SPEAG documents and is given in the following Table.

#### Repeatability Budget for System Check

<0.3 – 3GHz range Body>

Error Description	Uncertainty value ± %	Probability distribution	divisor	(ci) lg	Standard (lg)	vi or veff
<b>Measurement System</b>						
Probe calibration	± 1.8	Normal	1	1	± 1.8	∞
Axial isotropy of the probe	± 0.0	Rectangular	√3	1	± 0.0	∞
Spherical isotropy of the probe	± 0.0	Rectangular	√3	0	± 0.0	∞
Boundary effects	± 0.0	Rectangular	√3	1	± 0.0	∞
Probe linearity	± 0.0	Rectangular	√3	1	± 0.0	∞
Detection limit	± 0.0	Rectangular	√3	1	± 0.0	∞
Modulation response	± 0.0	Rectangular	√3	1	± 0.0	∞
Readout electronics	± 0.0	Normal	1	1	± 0.0	∞
Response time	± 0.0	Rectangular	√3	1	± 0.0	∞
Integration time	± 0.0	Rectangular	√3	1	± 0.0	∞
RF ambient Noise	± 0.0	Rectangular	√3	1	± 0.0	∞
RF ambient Reflections	± 0.0	Rectangular	√3	1	± 0.0	∞
Probe Positioner	± 0.4	Rectangular	√3	1	± 0.2	∞
Probe positioning	± 2.9	Rectangular	√3	1	± 1.7	∞
Max.SAR Eval.	± 0.0	Rectangular	√3	1	± 0.0	∞
<b>Test Sample Related</b>						
Deviation of wxp.dipole	± 0.0	Normal	√3	1	± 0.0	∞
Dipole Axis to Liquid Distance	± 2.0	Normal	√3	1	± 1.2	∞
Input power and SAR drift meas.	± 3.4	Rectangular	√3	1	± 2.0	∞
<b>Phantom and Setup</b>						
Phantom uncertainty	± 4.0	Rectangular	√3	1	± 2.3	∞
Algorithm for correcting SAR for deviations in permittivity and conductivity	± 1.9	Normal	1	1	± 1.9	∞
Liquid conductivity (meas.)	± 5.0	Rectangular	1	0.78	+ 3.9	∞
Liquid permittivity (meas.)	± 5.0	Rectangular	1	0.26	- 1.3	∞
Liquid conductivity - temp.unc (below 2deg.C.)	± 1.7	Rectangular	√3	0.78	± 0.8	∞
Liquid permittivity - temp.unc (below 2deg.C.)	± 0.3	Rectangular	√3	0.23	± 0.0	∞
<b>Combined Standard Uncertainty</b>					± 6.144	
<b>Expanded Uncertainty (k=2)</b>					± 12.3	

UL Japan, Inc.

Ise EMC Lab.

4383-326 Asama-cho, Ise-shi, Mie-ken 516-0021 JAPAN

Telephone: +81 596 24 8999

Facsimile: +81 596 24 8124