

Ericsson (China) Communications Company Ltd  
 Att. Hua Yang  
 Ericsson Tower  
 No. 5 Lize East Street  
 Chaoyang District, Beijing 100102  
 P. R. China

## Class II Permissive Change measurements on GSM Base station Transceiver Unit with FCC ID: B5KFKRC1311004-2

(8 appendices)

### Test object

Transceiver Unit dTRU-19, product KRC 131 1004/2, revision R4E

### Summary

Standard	Compliant	Appendix	Remarks
<b>FCC CFR 47</b>			
2.1046 RF Power output	Yes	2	-
2.1049 Occupied bandwidth	Yes	3	-
2.1051 Band Edge	Yes	4	-
2.1051 Spurious emission at antenna port	Yes	5	-
2.1053 Field strength of spurious radiation	Yes	6	-

### SP Technical Research Institute of Sweden Electronics - EMC

Performed by



Reinhold Reul

Examined by



Christer Karlsson

Laboratory is FCC listed with Reg. no. 93866 and IC recognized pursuant IC file no. 3482A.

---

#### SP Technical Research Institute of Sweden

Postal address  
 SP  
 Box 857  
 SE-501 15 BORÅS  
 Sweden

Office location  
 Västeråsen  
 Brinellgatan 4  
 SE-504 62 BORÅS

Phone / Fax / E-mail  
 +46 10 516 50 00  
 +46 33 13 55 02  
 info@sp.se

Laboratories are accredited by the Swedish Board for Accreditation and Conformity Assessment (SWEDAC) under the terms of Swedish legislation. This report may not be reproduced other than in full, except with the prior written approval of the issuing laboratory.



## Table of contents

Description of the test object	Appendix 1
Purpose of test	Appendix 1
Summary of results	Appendix 1
Tested configurations	Appendix 1
RF power output	Appendix 2
Occupied bandwidth	Appendix 3
Band edge	Appendix 4
Spurious emission at antenna terminals	Appendix 5
Field strength of spurious radiation	Appendix 6
Hardware list and software	Appendix 7
Photos of the test object	Appendix 8

## Appendix 1

### Description of the test object

Equipment: GSM Base station transceiver unit (dTRU) 1900 MHz

TX frequency range: 1930 - 1990 MHz

Modulations: GMSK, 8PSK, 16QAM, 32QAM, AQPSK

Declared maximum output power, RMS value in [dBm]	Modulations				
	GMSK	8PSK	16QAM	32QAM	AQPSK
Hybrid combined (HC) mode	41.5	38.2	36.8	36.4	38.1
Uncombined (UC) mode	44.8	41.5	40.1	39.7	41.4
TCC mode	47.5	44.2	42.8	42.4	44.1

Supply voltage 24 V DC

### Purpose of test

The purpose of this test is to justify a Class II Permissive Change of the test object to include the use of AQPSK modulation with SCPIR 0 dB. This report verifies maintained performance characteristics of affected items according FCC CFR47 by re-testing the updated equipment and comparing results for GMSK reference modulation with AQPSK modulation in SCPIR 0 dB. For band-edge performance the acceptable settings for the new implemented AQPSK modulation were determined.

### Summary of results

Measurement results are similar for all tested modulations, apart from output power, where GMSK modulation results in the highest RMS output power, and for band-edge performance, where restrictions apply as described in appendix 4. Where several modulations were compared, GMSK modulation shall be considered a worst case set-up.

### Tested configurations

All measurements were performed with the test object installed in a RBS 2206 V2 cabinet. The hardware list for radiated and conducted measurements is shown in appendix 7. Unless noted otherwise the test object was activated at maximum power, configured for TCC mode with RBS master 2E setting 49, resulting in the highest achievable output power. In all used configurations random data was transmitted by the activated TX in all time slots with the various tested modulations being activated one at a time.

## Appendix 1

### Conducted measurements

Conducted measurements were done at the output connector TX/RX 1 of CDU-G19.

### Radiated measurements

During radiated emission measurements the TX/RX 1 output of CDU-G19 was via a 50 ohm attenuator connected to a spectrum analyser to monitor the transmitted signal level. For the scope of this test it was deemed sufficient to measure radiated spurious emission at the TX band centre frequency for GMSK modulation as worst case reference modulation with the highest RMS power and compare it with results for the AQPSK modulation with SCPIR 0 dB.

### Frequencies used

Channel	ARFCN	Frequency	Comment
B	512	1930.2 MHz	TX frequency adjacent lower frequency band edge
B+1	513	1930.4 MHz	TX low alternate frequency, 1 channel inside band
M	661	1960.0 MHz	TX band centre frequency
T-1	809	1989.6 MHz	TX high alternate frequency, 1 channel inside band
T	810	1989.8 MHz	TX frequency adjacent higher frequency band edge

### Manufacturer's representative

Hua Yang, Ericsson (China) Communications Company Ltd

### References

Measurements were done according to relevant parts of the following standards:

ANSI C63.4-2009

ANSI/TIA/EIA-603-C-2004

ANSI/TIA/EIA 136-280-D-2002

CFR 47 part 2, October 1<sup>st</sup>, 2010

CFR 47 part 24, October 1<sup>st</sup>, 2010

### Reservation

The test results in this report apply only to the particular Equipment Under Test (EUT) as declared in the report.

### Delivery of test object

The test object was delivered on 13<sup>th</sup> June 2011.

Appendix 1

**Test equipment**

Measurement equipment	Calibration Due	SP number
Anechoic chamber, Hertz	2011-10	15:116
Boonton 4500A RF Peak power meter/analyser	2011-10	503 144
Boonton Power sensor 56518-S/4	2011-10	503 146
Rohde & Schwarz FSIQ40	2012-07	503 738
Rohde & Schwarz ESI40	2012-07	503 125
Rohde & Schwarz Vector Network Analyser	2012-07	503 687
Chase bilog antenna CBL 6121A	2011-10	502 460
Schaffner Reference Dipole BSRD6500	2012-03	502 181
EMCO Horn Antenna 3115	2014-01	502 175
EMCO Horn Antenna 3115	2014-01	501 548
MITEQ Low Noise Amplifier	2012-08	503 277
Flann Std gain horn 20240-20	2014-03	503 674
Attenuator 40 dB	2012-08	504 159
Attenuator 30 dB	2012-08	900 229
High pass filter	2012-08	504 200
High pass filter	2012-08	503 739
Multimeter Fluke 87	2012-05	502 190
Testo 615 temperature and humidity meter	2012-03	503 498
Testo 635 temperature and humidity meter	2013-05	504 203

**Uncertainties**

Measurement and test instrument uncertainties are described in the quality assurance documentation "SP-QD 10885". The uncertainties are calculated with a coverage factor  $k=2$  (95% level of confidence).

**Test engineers**

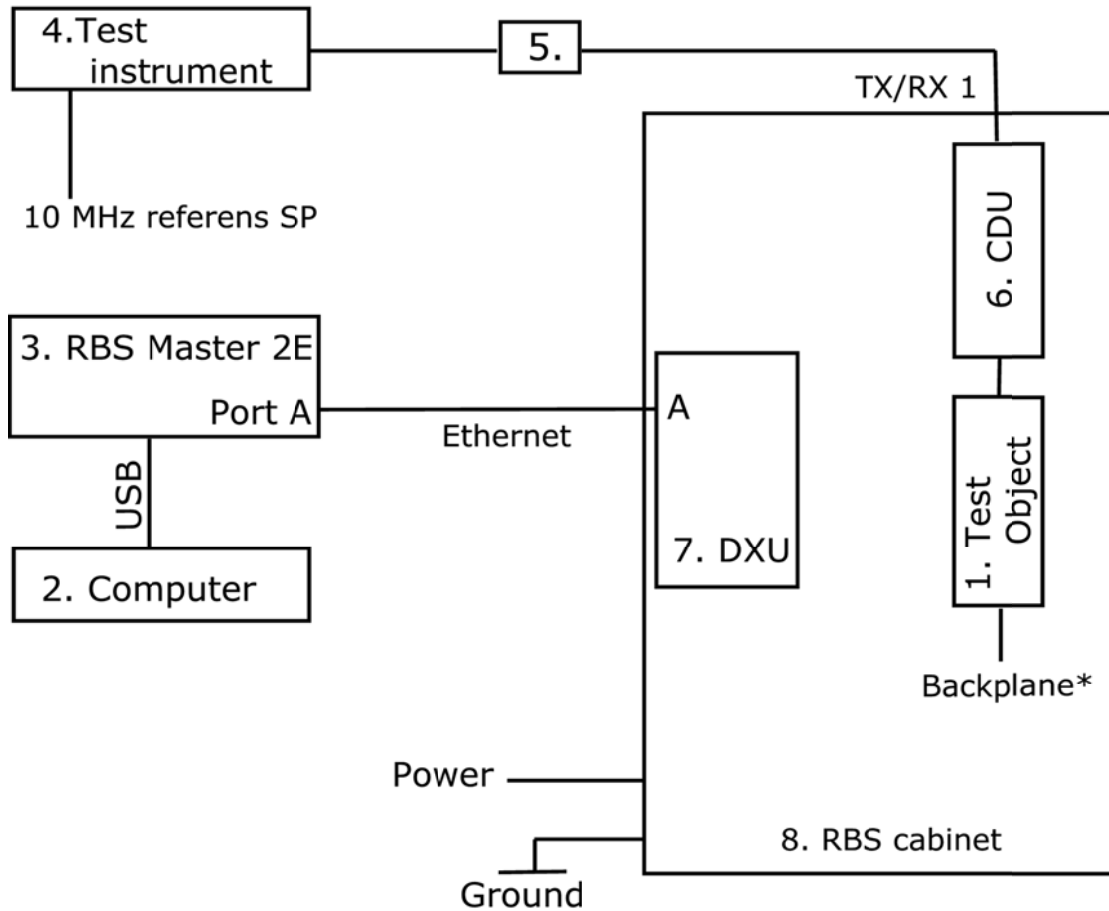
Jörgen Wassholm, Fredrik Isaksson, Martin Nilsson, Martin Forsberg and Reinhold Reul, SP

**Test witness**

-

Appendix 1

**Test set-up, conducted measurements**



\*) Power and data communication via backplane

**Test object**

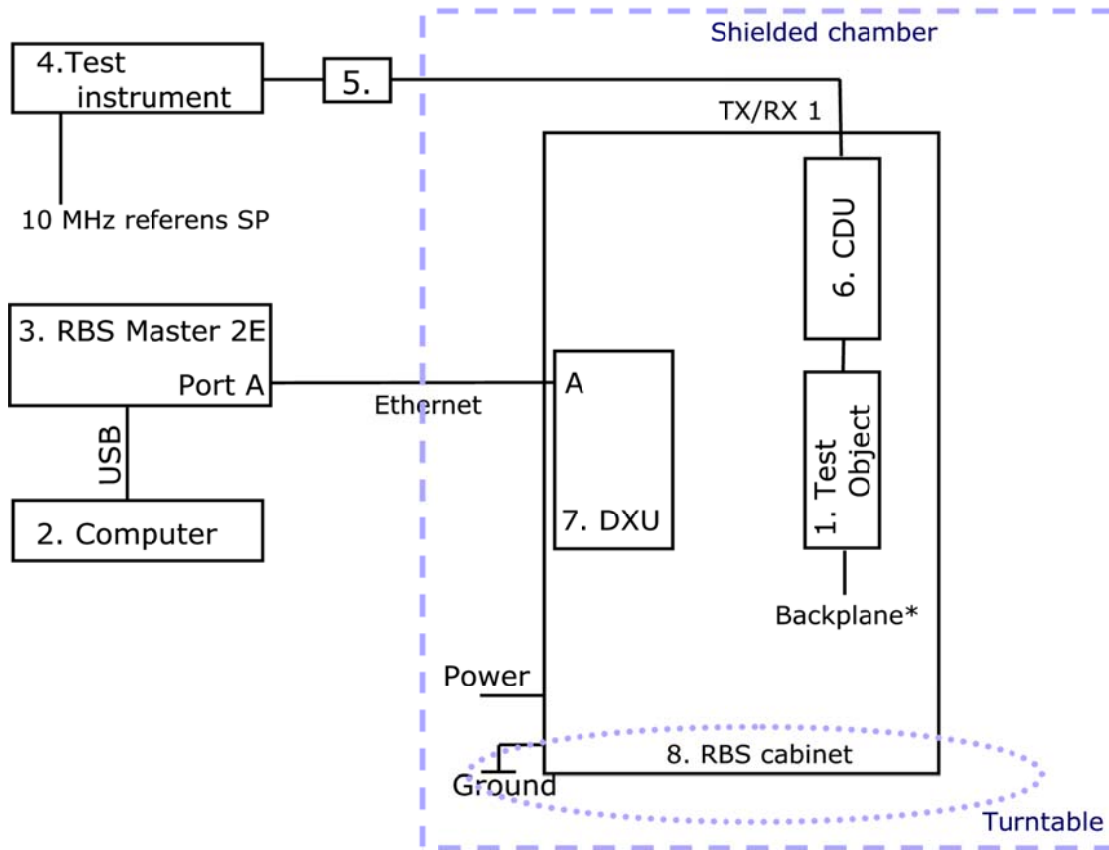
1. Transceiver Unit dTRU-19, product KRC 131 1004/2, revision R4E, SN AE55467552 with FCC ID: B5KFKRC1311004-2

**Functional test equipment**

2. HP laptop computer Compaq nc6000, product PM307ES#AB2, SN CNU51206GT, with RBS Master2 control software
3. Ericsson RBS Master 2E hardware, product LBY 107 1007/3, revision R1C BAMS 1000878365
4. Agilent MXA Signal Analyser model N9020A 20 Hz – 3.6 GHz, BAMS 1000785533, used to verify the modulation schemes and SP test equipment according respective appendix
5. Attenuator / filter listed as test equipment in respective appendix
6. CDU-G19, product BFL 119 153/1, revision R5F, serial number A40003X4CF
- 7./8. DXU and remaining RBS cabinet according hardware list in appendix 7

## Appendix 1

### Test set-up, radiated emission



\*) Power and data communication via backplane

### Test object

1. Transceiver Unit dTRU-19, product KRC 131 1004/2, revision R4E, SN AE55467552 with FCC ID: B5KFKRC1311004-2

### Functional test equipment

2. HP laptop computer model Compaq NC6400 SN CND72717JP with RBS Master2 control software
3. Ericsson RBS Master 2E hardware, product LBY 107 1007/3, revision R1C, BAMS 1000735211
4. Rohde & Schwarz FSIQ40 for signal monitoring
5. Attenuator 40 dB, SP 504 159
6. CDU-G19, product BFL 119 153/1, revision R5F, serial number A40003X4CF
- 7./8. DXU and RBS cabinet according hardware list in appendix 7

Appendix 1

**Test object connections**

**Interface**

Power via RBS backplane

TX 1 + TX 2 interconnection to CDU in TCC/HC mode

Interconnection TX 1 to CDU in UC mode

Interconnection TX 2 to CDU in UC mode

RX 1 to CXU10

RX 2 to CXU10

RX 3 not connected

RX 4 not connected

**Type of port**

DC power

RF interconnect

RF interconnect

RF interconnect

RF interconnect

RF interconnect

RF interconnect

**RBS cabinet external connections**

**Interface**

External supply 24 V DC

Active CDU TX/RX 1, used for measurement and monitoring

Active CDU TX/RX 2 and inactive CDU's outputs unconnected

Ethernet shielded multi-wire with RJ-45connector to RBS master

2E, port A, mode E1

External alarm not connected

ESB not connected

GPS not connected

OMT interface for configuration not connected

**Type of port:**

DC power

RF/Antenna

RF/Antenna

Telecom

Signal

Signal

Signal

O/M



Appendix 2

**RF Power output measurements according to CFR 47 2.1046**

Date 2011-12-05	Temperature 23 °C ± 3 °C	Humidity 23 % ± 5 %
--------------------	-----------------------------	------------------------

**Test set-up and procedure**

Measurements were made at the CDU output connector. The output was connected to a peak power analyser via a 50 ohm attenuator.

Measurement equipment	SP number
Boonton 4500A RF Peak power meter/analyser	503 144
Boonton Power sensor 56518-S/4	503 146
Attenuator	504 159
Multimeter Fluke 87	502 190
Testo 635 temperature and humidity meter	504 203

**Measurement uncertainty:** 0.7 dB

**Results**

Transmitter power (dBm)			
Channel	Modulation	Peak	RMS
M	GMSK	47.6	46.8
M	AQPSK	47.2	43.2

The maximum PAR measured above was 4.0 dB.

**Limits**

According to CFR § 24 there are no conducted limits at the antenna connector.

§ 24.232: The peak-to-average (PAR) ratio shall not exceed 13 dB. Base stations with an emission bandwidth of 1 MHz or less are limited to 1640 watts equivalent isotropically radiated power (EIRP).

Complies?	Yes
-----------	-----

Appendix 3

**Occupied bandwidth measurements according to 47CFR 2.1049**

Date	Temperature	Humidity
2011-12-05	23 °C ± 3 °C	23 % ± 5 %

**Test set-up and procedure**

The measurements were made per definition in §24.238 at the CDU output, which was connected to a spectrum analyser with the RMS detector activated. The spectrum analyser was connected to an external 10 MHz reference standard during the measurements.

Measurement equipment	SP number
R&S FSIQ	503 738
Attenuator	504 159
Multimeter Fluke 87	502 190
Testo 635 temperature and humidity meter	504 203

**Measurement uncertainty:** 3.7 dB, 1.33 kHz

**Results**

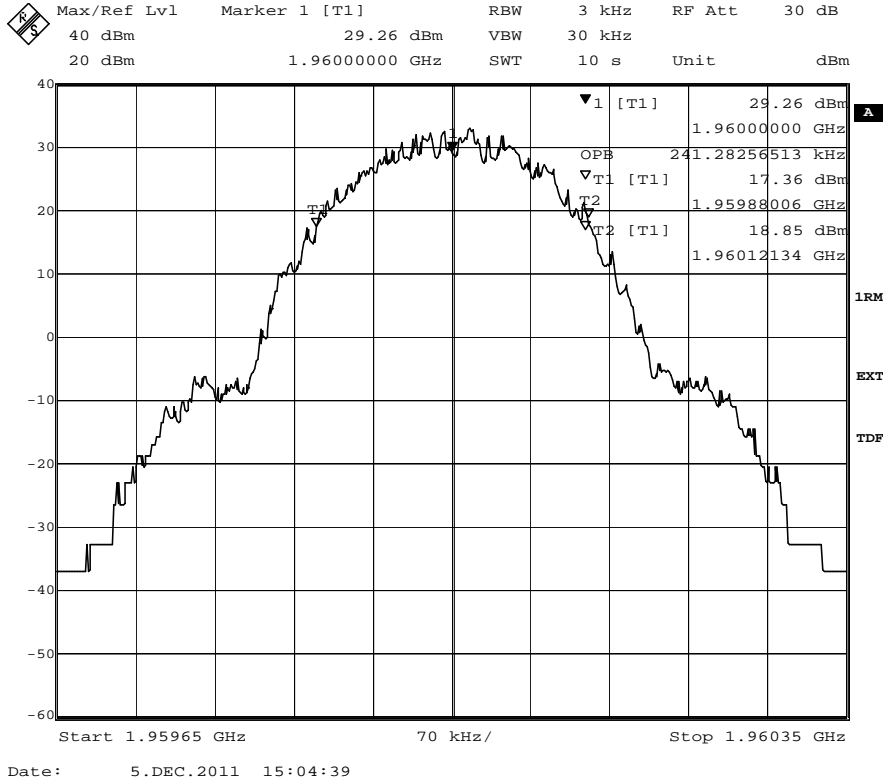
Configuration: TCC mode, RBS master 2E setting 49.

Diagram	Channel	Modulation	OBW
1	M	GMSK	241 kHz
2	M	AQPSK	237 kHz

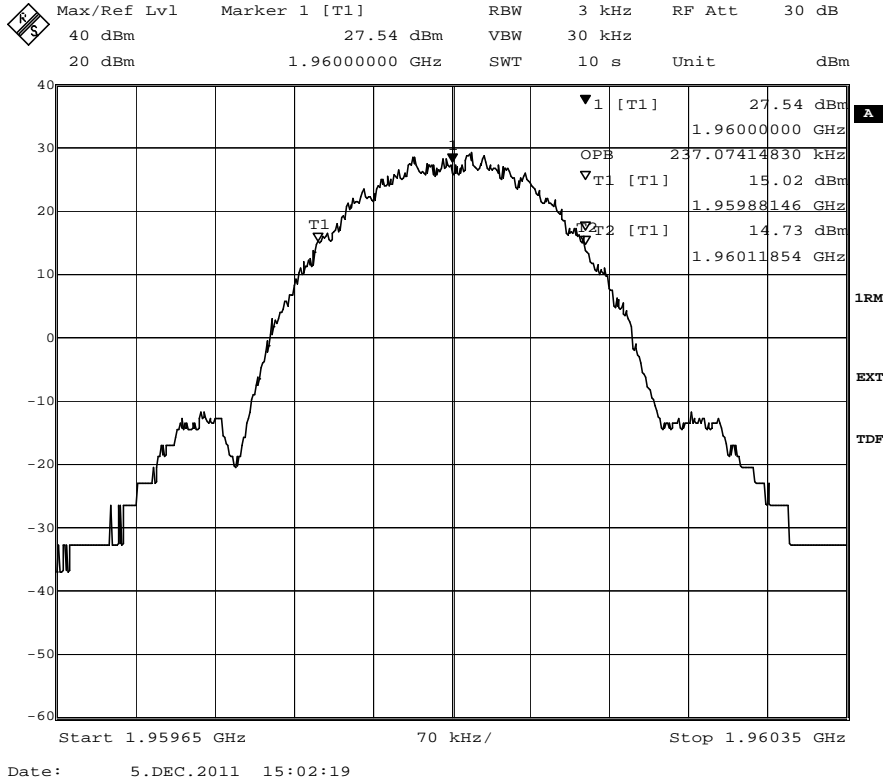
The diagrams are shown on the following page.

Appendix 3

**Diagram 1:**



**Diagram 2:**



Appendix 4

**Band edge measurements according to 47CFR 2.1051**

Date	Temperature	Humidity
2011-12-05	23 °C ± 3 °C	23 % ± 5 %

The measurements were made per definition in §24.238, with the CDU output connected to a spectrum analyser with the RMS detector activated. The spectrum analyser was connected to an external 10 MHz reference standard during the measurements.

FCC rules allow a resolution bandwidth of one per cent of the emission bandwidth of the fundamental emission within the first 1 MHz off the band edge. FCC rules require a resolution bandwidth of 1 MHz for measurements of emissions with band edge offsets exceeding 1 MHz.

Measurement bandwidths of 3 kHz, 50 kHz and 1MHz were used and the respective limit was adapted by  $[10 * \log(\text{RBWused}/\text{RBWrequired})]$  dB.

Measurement equipment	SP number
R&S FSIQ	503 738
Attenuator	504 159
Multimeter Fluke 87	502 190
Testo 635 temperature and humidity meter	504 203

**Measurement uncertainty: 3.7 dB**

**Results**

Diagram	Channel	Combiner configuration	RBS master 2E setting	Measured RMS power / [dBm]
1 a, b, c	B	UC mode	45	40.5
2 a, b, c	T	UC mode	45	40.5
3 a, b, c	B+1	TCC mode	49	42.8
4 a, b, c	T-1	TCC mode	49	42.8

The diagrams are shown on the following pages.

**Remark**

For channels B and T the above documented RMS output powers were found to represent the maximum acceptable values with AQPSK modulation using SCPIR 0 dB to meet band-edge requirements.

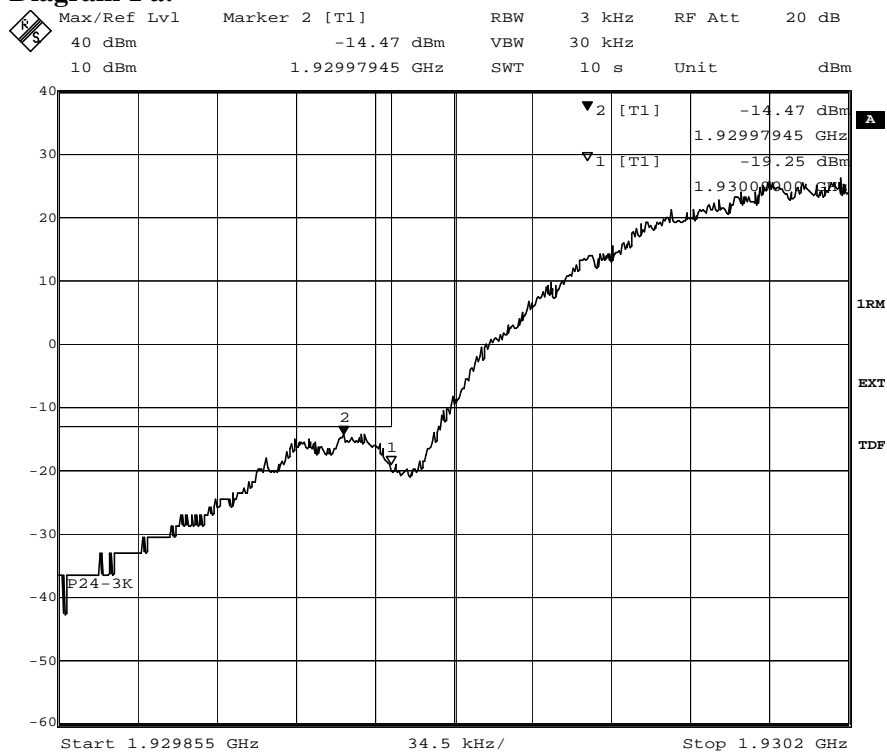
**Limits**

The power of any emission outside the frequency band shall be attenuated below the transmitter power (P) by at least  $43 + 10 \log P$  dB.

Complies?	Yes
-----------	-----

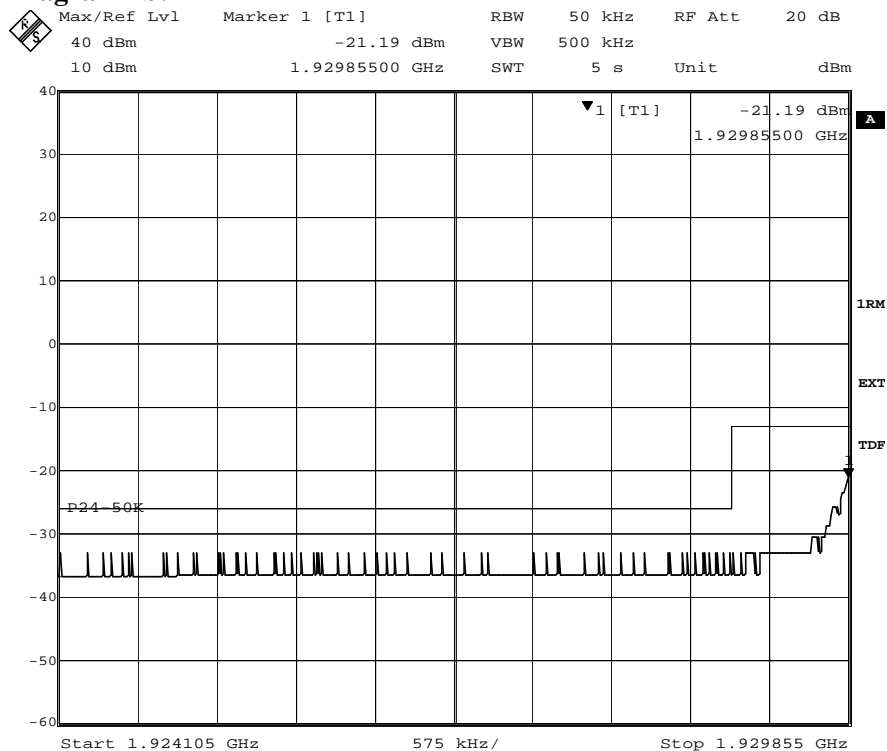
Appendix 4

**Diagram 1 a:**



Date: 5.DEC.2011 15:47:50

**Diagram 1 b:**

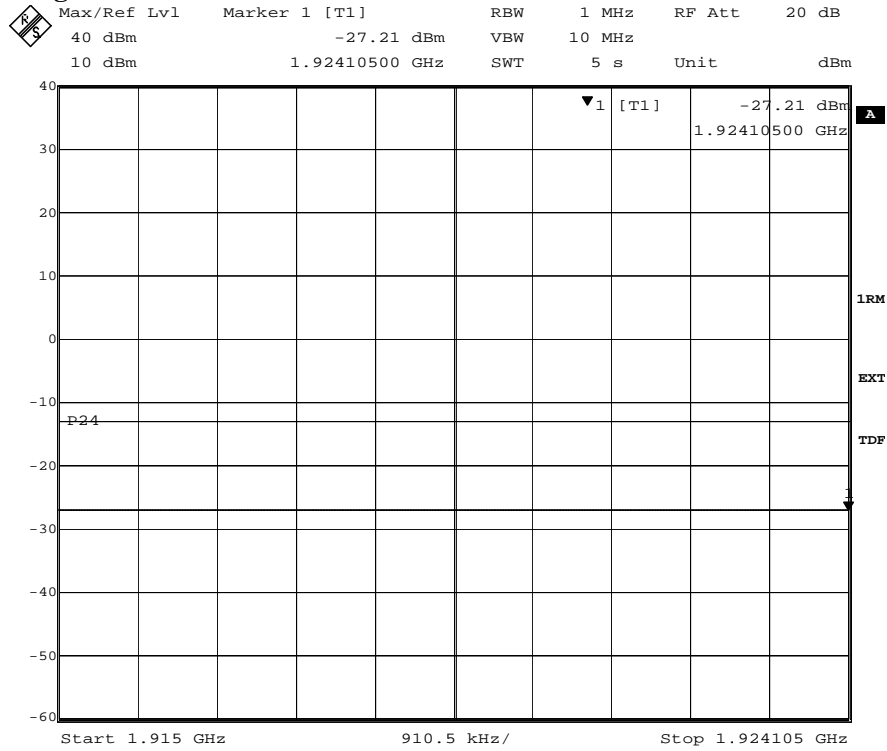


Date: 5.DEC.2011 15:48:44



Appendix 4

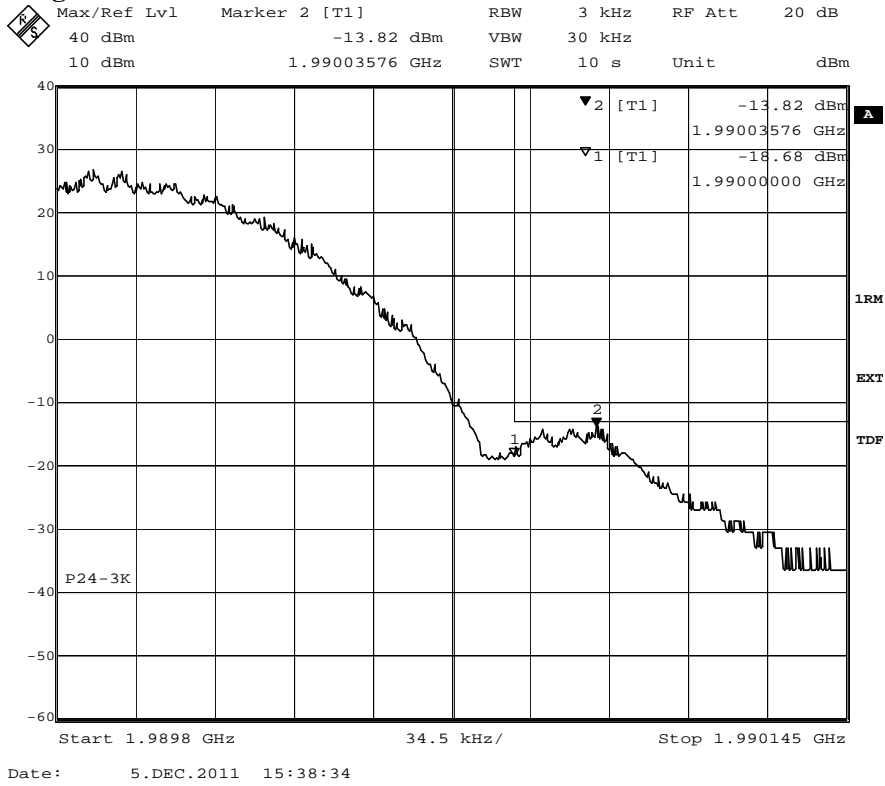
Diagram1 c:



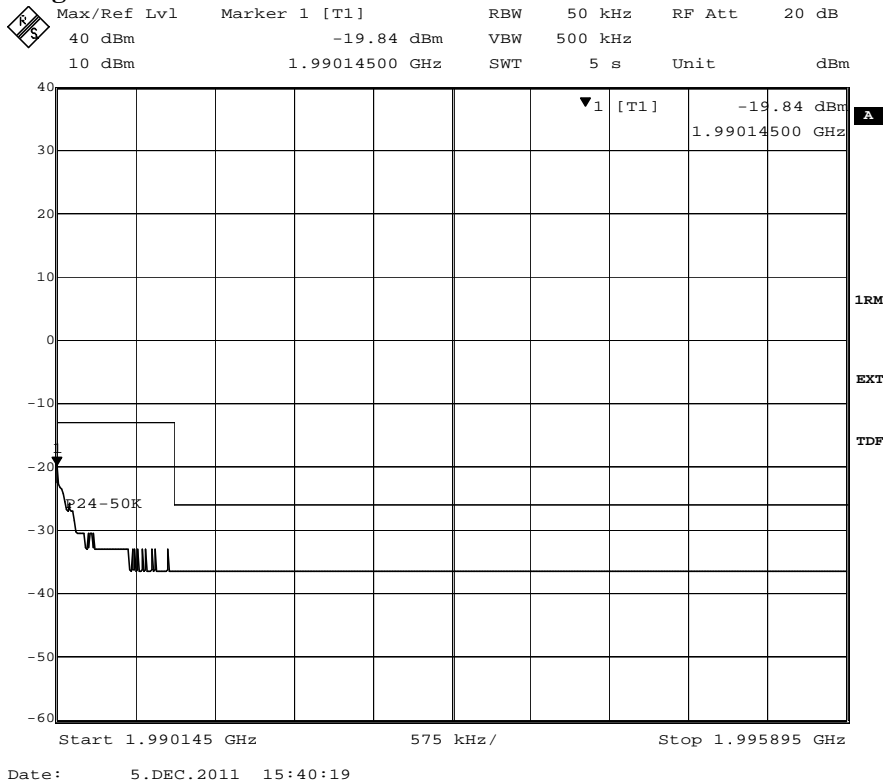
Date: 5.DEC.2011 15:49:42

Appendix 4

**Diagram 2 a:**

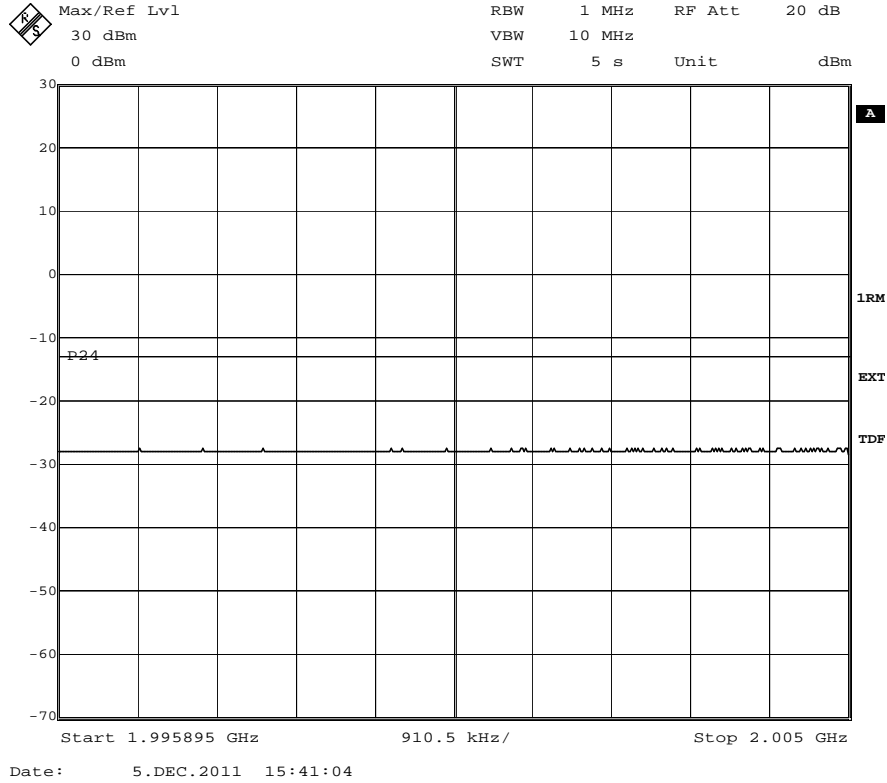


**Diagram 2 b:**



Appendix 4

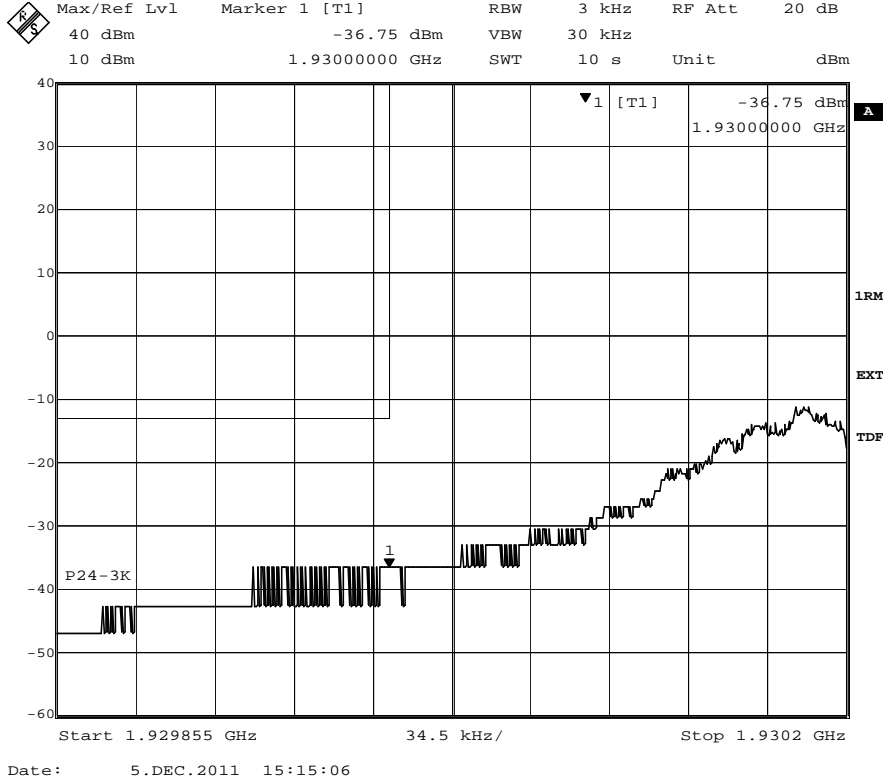
**Diagram 2 c:**



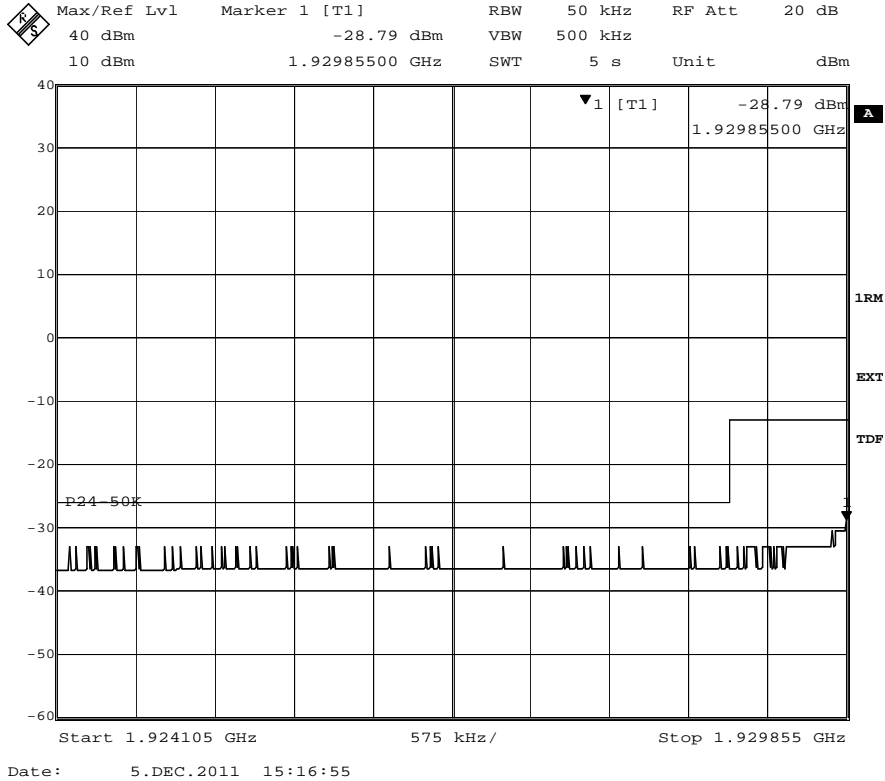


Appendix 4

**Diagram 3 a:**



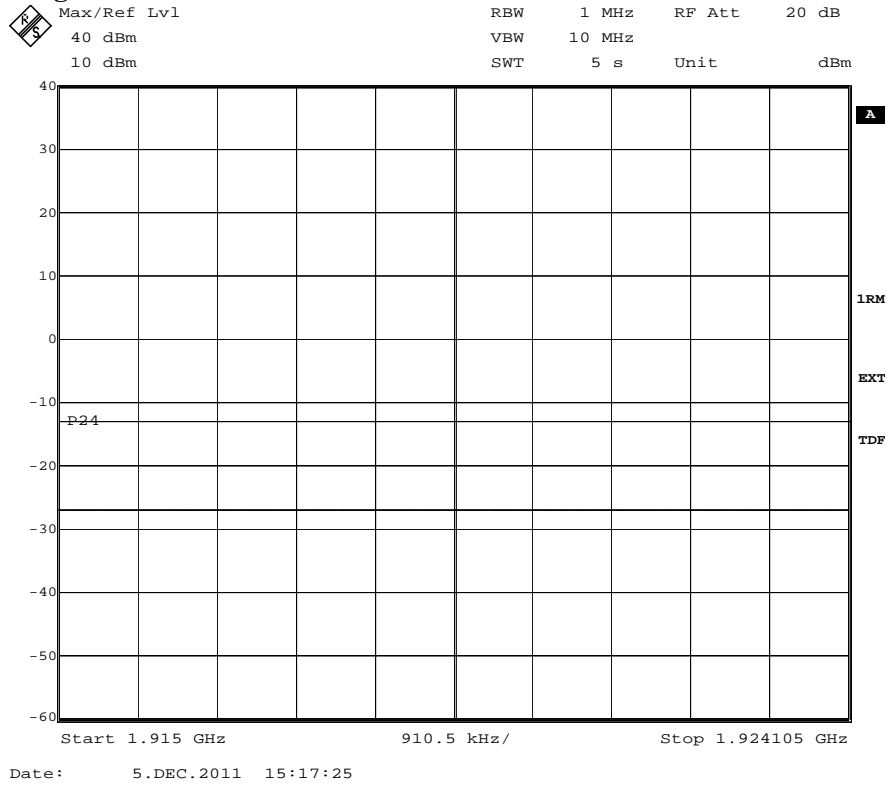
**Diagram 3 b:**





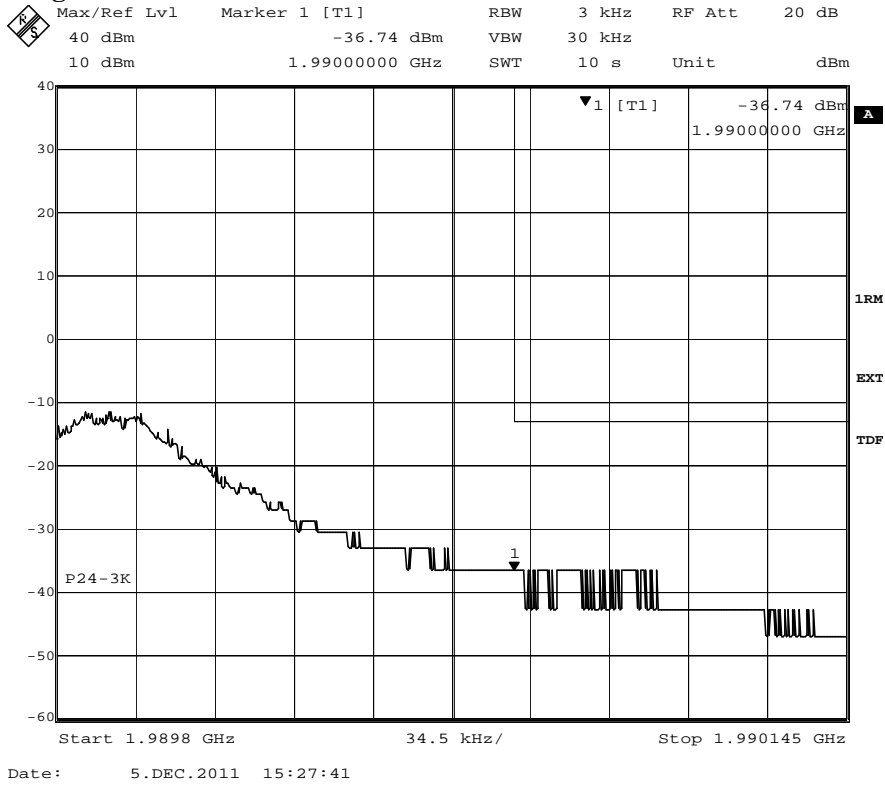
Appendix 4

Diagram 3 c:

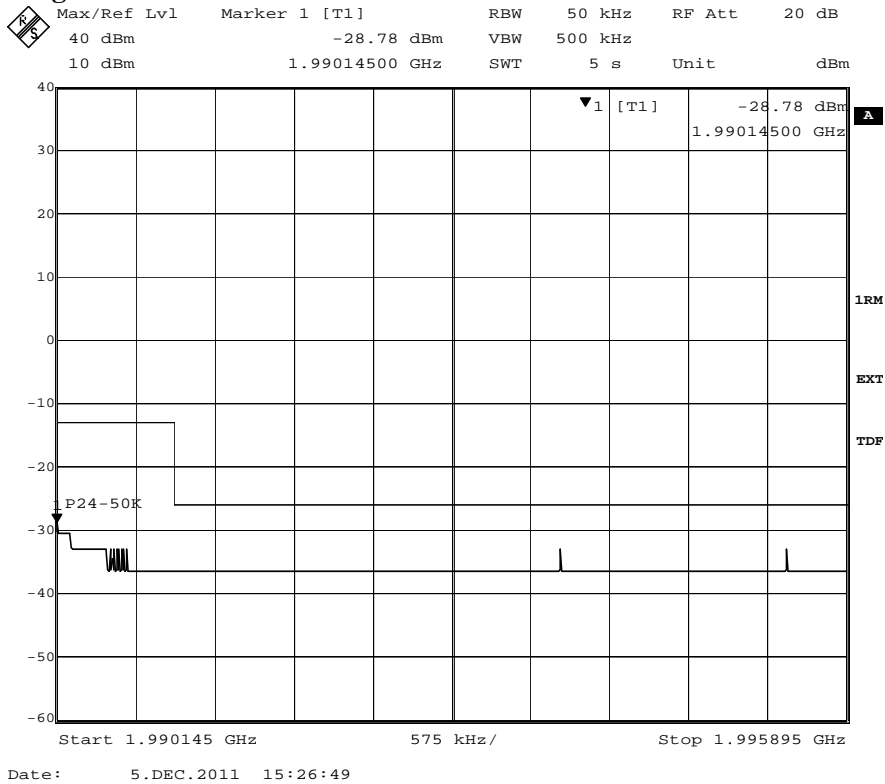


Appendix 4

**Diagram 4 a:**

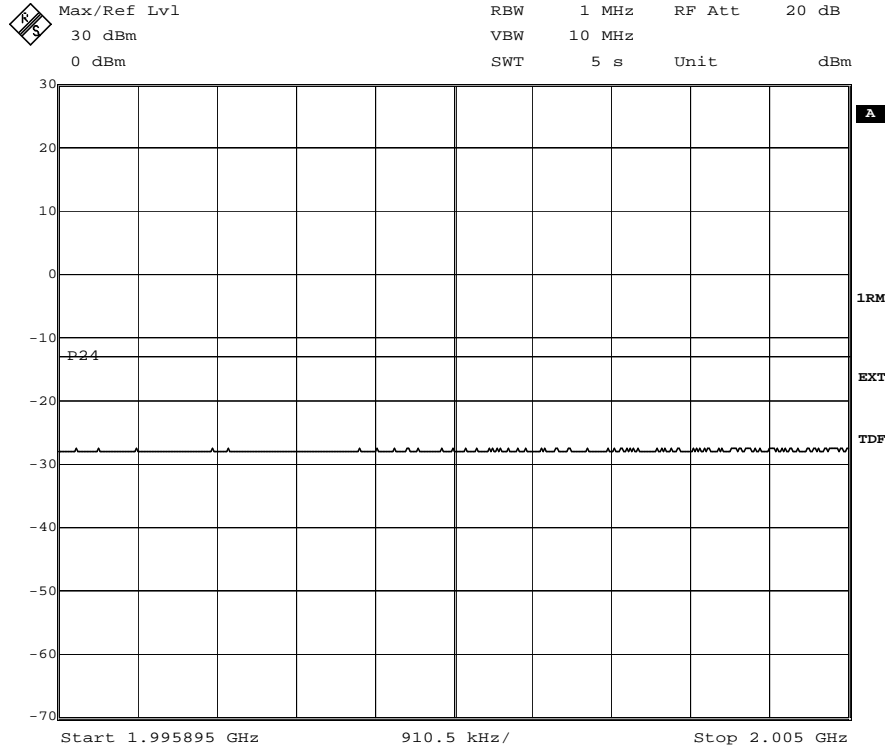


**Diagram 4 b:**



Appendix 4

**Diagram 4 c:**



Date: 5.DEC.2011 15:22:56

Appendix 5

**Conducted spurious emission measurements according to 47CFR 2.1051**

Date	Temperature	Humidity
2011-12-05	23 °C ± 3 °C	23 % ± 5 %

**Test set-up and procedure**

The measurements were made per definition in §24.238, with the CDU output connected to a spectrum analyser. A pre-measurement was performed with the PEAK detector activated. Emission close to or above the limit with the PEAK detector is measured with the RMS detector activated. The spectrum analyser was connected to an external 10 MHz reference standard during the measurements.

Measurement equipment	SP number
R&S FSIQ	503 738
Attenuator	504 159
High pass filter	504 200
Testo 635 temperature and humidity meter	504 203

**Measurement uncertainty:** 3.7 dB

**Results**

The results are shown in the diagrams below.

Configuration: TCC mode, RBS master 2E setting 49, ARFCN 661 (1960.0 MHz).

Diagram 1 a: GMSK, 9 KHz – 3 GHz

Diagram 1 b: GMSK, 3 GHz – 20 GHz

Diagram 2 a: AQPSK, 9 KHz – 3 GHz

Diagram 2 b: AQPSK, 3 GHz – 20 GHz

The diagrams are shown on the following pages.

**Limits**

The power of any emission outside the frequency band shall be attenuated below the transmitter power (P) by at least 43 + 10 log P dB.

Complies?	Yes
-----------	-----



Appendix 5

Diagram 1 a:

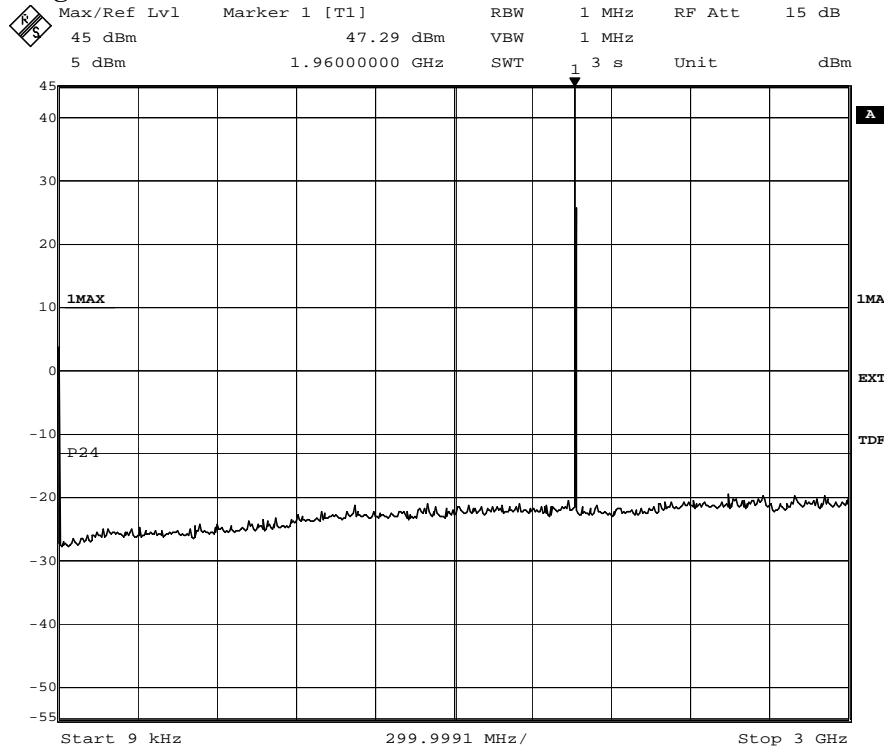
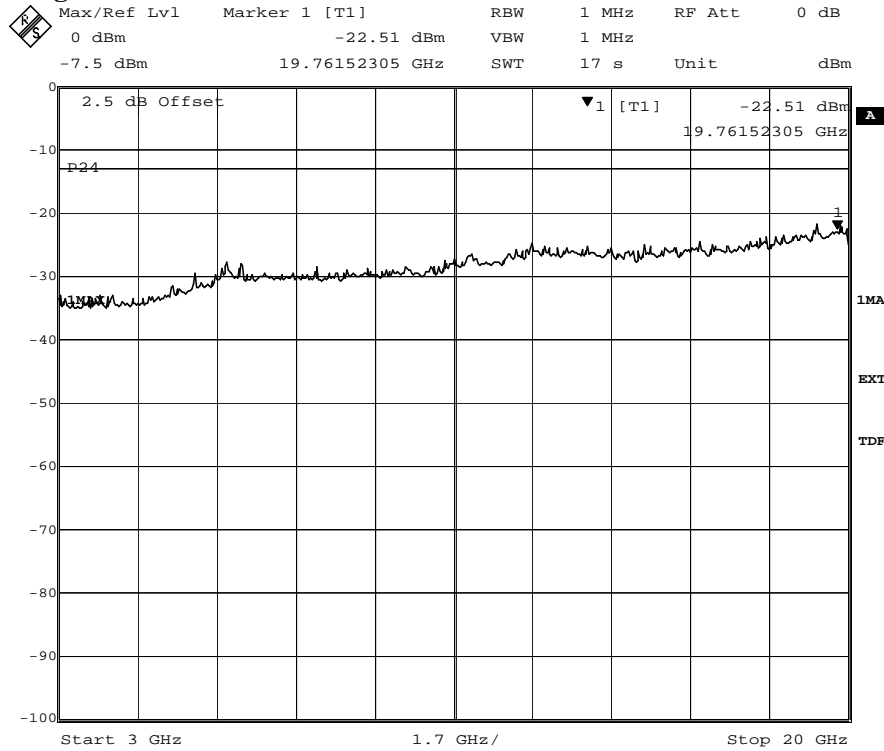
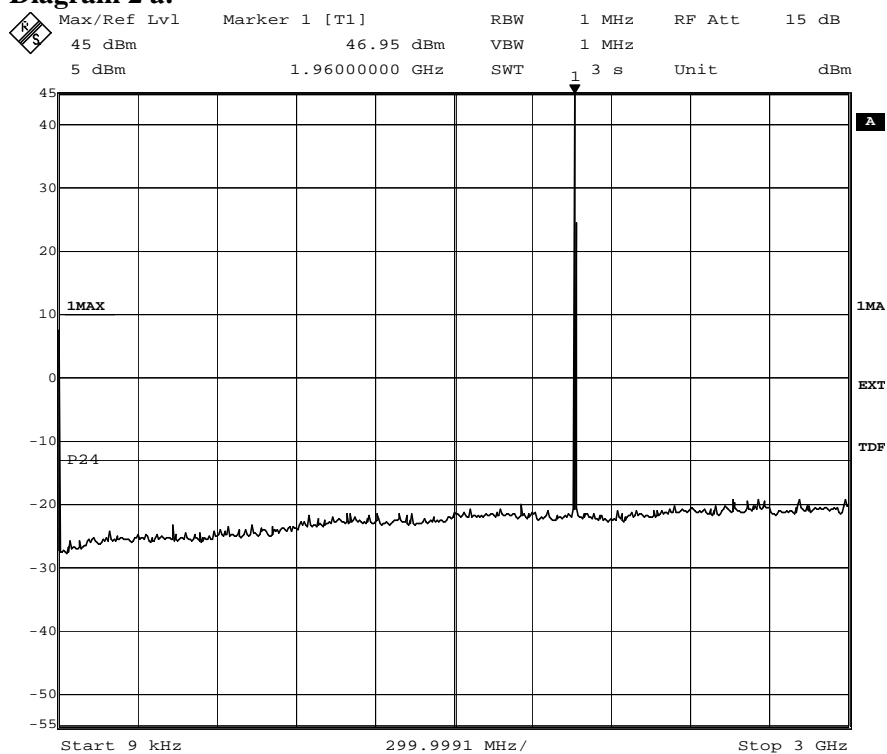


Diagram 1 b:



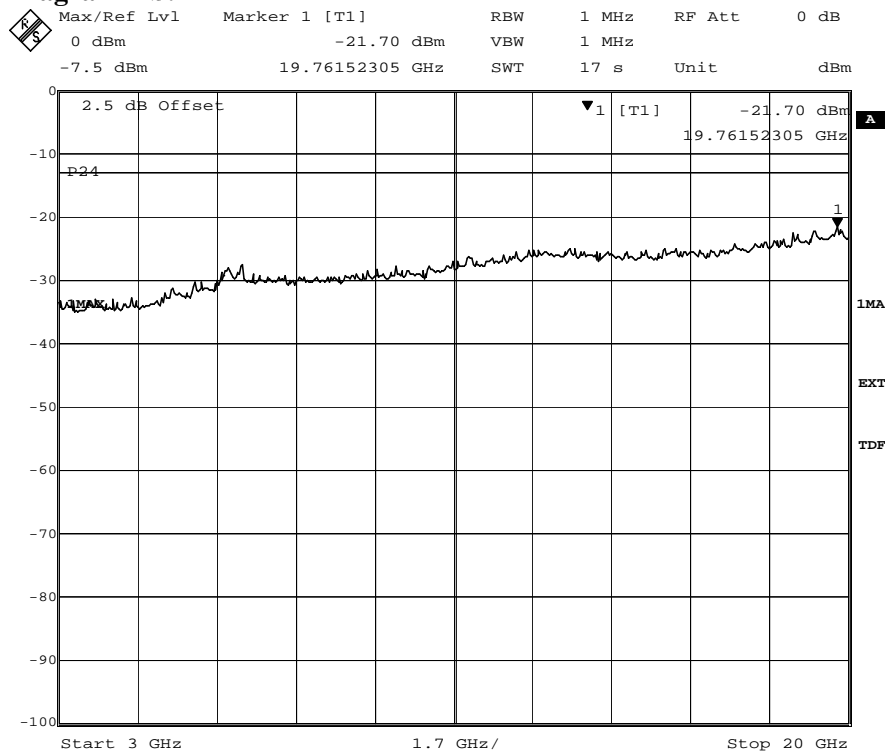
## Appendix 5

**Diagram 2 a:**



Date: 5.DEC.2011 15:08:20

**Diagram 2 b:**



Date: 5.DEC.2011 15:09:47

Appendix 6

**Field strength of spurious radiation measurements according to 47CFR 2.1053**

Date	Temperature	Humidity
2011-06-27	22 °C ± 3 °C	46 % ± 5 %

**Test set-up and procedure**

The measurements were performed with both horizontal and vertical polarization of the antenna. The antenna distance was 3 m in the frequency range 30 MHz – 18 GHz and 1m in the frequency range 18-20 GHz.

The measurements were performed in Effective Radiated Power (ERP). A fully anechoic chamber was used during the measurements. The chamber is regularly calibrated with the substitution method and from that calibration an ERP correction factor is derived. The correction factor was used as a transducer to get the readings in ERP.

The measurement procedure was as the following:

1. A pre-measurement was first performed with peak detector. The EUT was continuously measured in 360 degrees.
2. Spurious radiation on frequencies closer than 6 dB to the limit was re-measured with RMS detector and with the substitution method according to the standard.

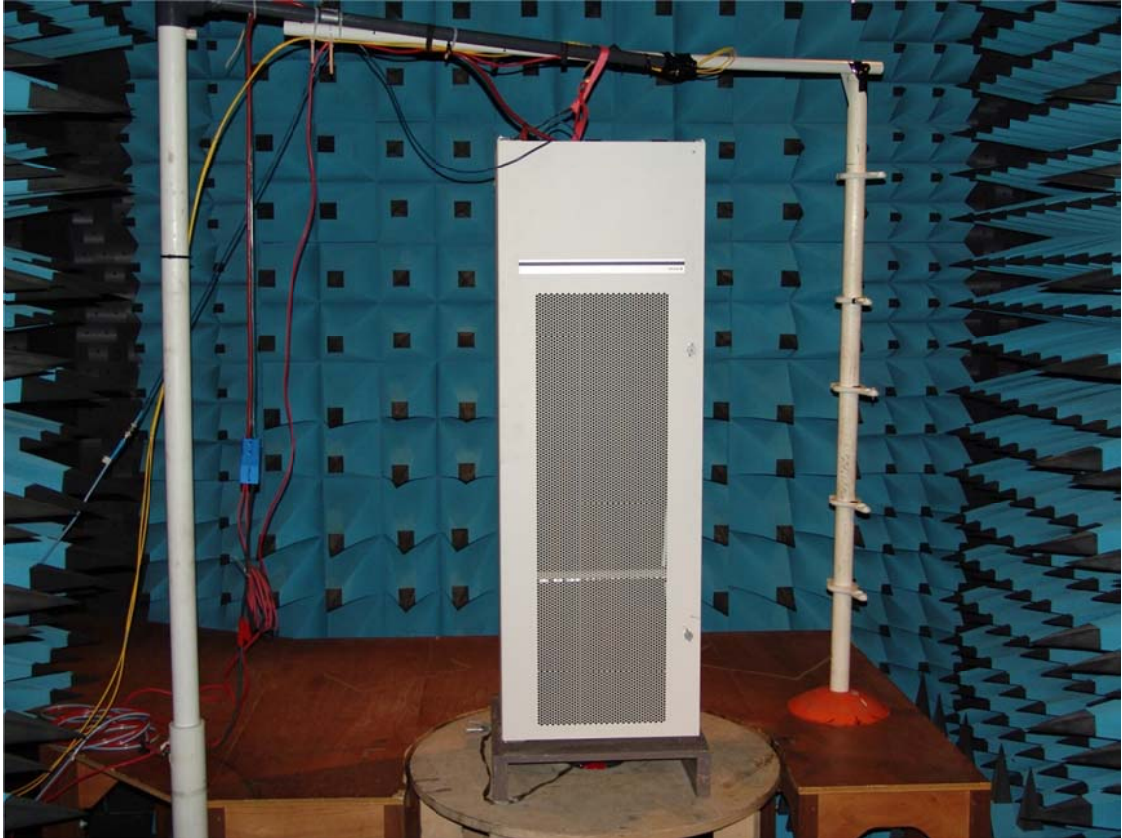
The test object was configured in TCC mode and RBS master 2E setting 49. TX ARFCN 661 (1960.0 MHz) was used.

Measurement equipment	SP number
Anechoic chamber, Hertz	15:116
Rohde & Schwarz FSIQ40 Signal Analyser	503 738
Rohde & Schwarz EMI Test Receiver ESI40	503 125
Chase bilog antenna CBL 6121A	502 460
Schaffner Reference Dipole BSRD6500	503 649
EMCO Horn Antenna 3115	502 175
EMCO Horn Antenna 3115	501 548
Flann Std gain horn 20240-20	503 674
MITEQ Low Noise Amplifier	503 277
Rohde & Schwarz Vector Network Analyser	503 687
Attenuator	504 159
High pass filter	503 739
Testo 615 temperature and humidity meter	503 498



## Appendix 6

The test set-up is shown in the picture below:



## Appendix 6

**Results**

## Modulation GMSK

Frequency (MHz)	Spurious emission level (dBm)	
	Vertical	Horizontal
30-20 000	All emission > 20 dB below limit	All emission > 20 dB below limit

## Modulation AQPSK

Frequency (MHz)	Spurious emission level (dBm)	
	Vertical	Horizontal
30-20 000	All emission > 20 dB below limit	All emission > 20 dB below limit

**Measurement uncertainty:** 3.1 dB

**Limits**

The power of any emission outside the frequency band shall be attenuated below the transmitter power (P) by at least  $43 + 10 \log P$  dB.

Complies?	Yes
-----------	-----

Appendix 7

**Hardware list RBS 2206 V2 used for conducted and radiated measurements**

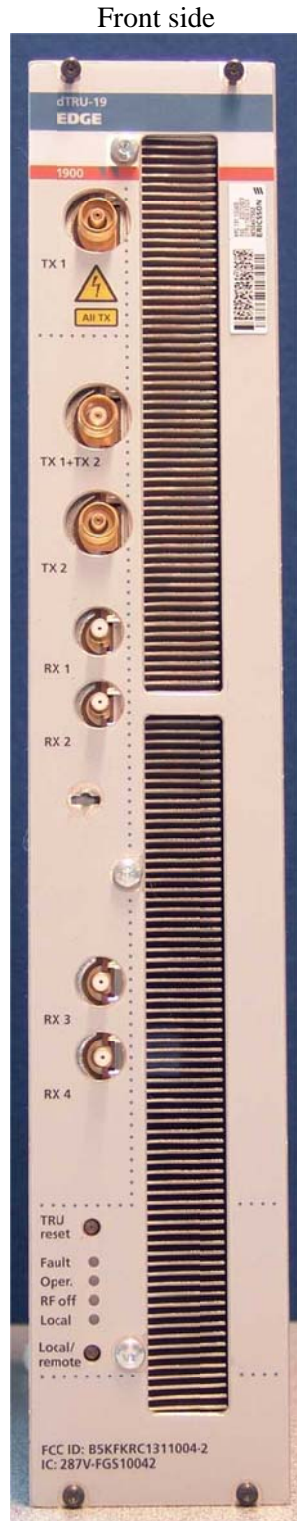
Pos.	Unit	Product Number	Revision	Serial Number
	Cabinet RBS 2206 V2	SEB 112 1154/1	R2A	AB2050402
	Door	SXK 109 7157/1	R1B	-
	DCCU-13	BMG 980 07/11	R1D	BH41057603
	ACCU-11	BMG 980 07/9	R1C	BH41113778
	Subrack	BFL 119 424/1	R2C	-
1	CDU-G19	BFL 119 153/1	R5F	A40003K3WX
2	CDU-G19	BFL 119 153/1	R5F	A40003X4CF
3	CDU-G19	BFL 119 153/1	R5F	TR40264562
	Dummy	SXK 107 5031/2	R1C	-
	CXU-10	KRY 101 1856/1	R4A	TR47918902
	Dummy	SXK 107 5031/1	R1C	-
	TRU subrack	BFL 119 425/1	R1C	-
	Backplane	BFX 101 107/3	R1B	-
1	dTRU-19	KRC 131 1004/2	R1G	AE50094077
2	dTRU-19	KRC 131 1004/2	R2F	AE51181689
3	dTRU-19	KRC 131 1004/2	R4E	AE55467552
4	dTRU-19	KRC 131 1004/2	R3A	AE52476769
5	dTRU-19	KRC 131 1004/2	R4A	AE54155371
6	dTRU-19	KRC 131 1004/2	R1G	AE50094075
	IDM-11	BMG 980 327/2	R1D	BH54675507
	PSU/DXU subrack	BFL 119 453/1	R1A	-
	Backplane	BFX 101 109/1	R1A	-
1	PSU-AC-32	BML 353 206/2	R1D	BW91030688
2	PSU-AC-32	BML 353 206/2	R1D	BW91030922
3	Dummy PSU	SXK 107 9314/1	R3A	-
4	Dummy PSU	SXK 107 9314/1	R3A	-
5	Metal cover plate 1 slot	-	-	-
6a	TMA-CM-02	SDK 107 881/1	R4A	BR60174802
6b	Metal cover plate ½ slot	-	-	-
7	DXU-23	BOE 602 21/1	R1C/B	TU8D486189

**Test object software during both radiated and conducted measurements**

Software	Revision
CXP 104 0007/05	R31E

Appendix 8

Photos of the test object



Appendix 8

Left side



Right side

