



REPORT

issued by an FCC listed Laboratory Reg. no. 93866.
The test site complies with RSS-Gen, file no: IC 3482A

Date
2010-08-16

Reference
FX009340-9

Page
1 (2)



Handled by, department
Reinhold Reul
Electronics
+46 10 516 55 84, reinhold.reul@sp.se

Ericsson (China) Communications Company Ltd
Att. Hua Yang
Ericsson Tower
No. 5 Lize East Street
Chaoyang District, Beijing 100102
P. R. China

Permissible change measurements on GSM Base station Transceiver unit with FCC ID: B5KDKRC1311004-2 (8 appendices)

Test object

Transceiver Unit dTRU 19 Edge, product KRC 131 1004/2, revision R3A, SN AE52476778

See appendix 1 for general information. Appendix 7 lists hardware and software.
Appendix 8 shows photos of the test object.

Summary

Standard	Compliant	Appendix	Remarks
FCC CFR 47			
2.1046 RF Power output	Yes	2	-
2.1049 Occupied bandwidth	Yes	3	-
2.1051 Band Edge	Yes	4	Note 1
2.1051 Spurious emission at antenna port	Yes	5	-
2.1053 Field strength of spurious radiation	Yes	6	-

Note 1: The maximum output power that can be used on the channels adjacent to the frequency band edges (channel 512 and 810) with CDU-G 19 is with the RBS master 2E control software configured with a value of 39, resulting in a maximum measured RMS output power of 38.0 dBm for 16QAM and 37.6 dBm for 32QAM modulation.

SP Technical Research Institute of Sweden
Electronics – EMC

Christer Karlsson
Technical Manager

Reinhold Reul
Technical Officer

SP Technical Research Institute of Sweden

Postal address
SP
Box 857
SE-501 15 Borås
SWEDEN

Office location
Västeråsen
Brinellgatan 4
SE-504 62 Borås
SWEDEN

Phone / Fax / E-mail
+46 10 516 50 00
+46 33 13 55 02
info@sp.se

Laboratories are accredited by the Swedish Board for Accreditation and Conformity Assessment (SWEDAC) under the terms of Swedish legislation. This report may not be reproduced other than in full, except with the prior written approval of the issuing laboratory.



FCC ID: B5KDKRC1311004-2

Table of contents

Description of the test object	Appendix 1
Operation mode during measurements	Appendix 1
Purpose of test	Appendix 1
Test setups	Appendix 1
RF power output	Appendix 2
Occupied bandwidth	Appendix 3
Band edge	Appendix 4
Spurious emission at antenna terminals	Appendix 5
Field strength of spurious radiation	Appendix 6
Hardware list and software	Appendix 7
Photos of the test object	Appendix 8

**Description - Equipment Under Test (EUT)**

Equipment: GSM Base station transceiver unit (dTRU) 1900 MHz

TX frequency range: 1930.2 - 1989.8 MHz

Modulations: GMSK, 8PSK, 16QAM and 32QAM

Nominal maximum output power, RMS value in [dBm]	Modulation			
	GMSK	8PSK	16QAM	32QAM
In uncombined (UC) mode	44.8	41.5	40.1	39.7
In combined (HC) mode	41.5	38.2	36.8	36.4
In TCC mode	47.5	44.2	42.8	42.4

Supply voltage to test object 27.2 V DC
supplied internally from backplane in the RBS 2206 V2.
The RBS backplane was powered by the PSU output.
The PSU was supplied from the AC mains.

Purpose of test

The purpose of this test is to justify a Class II permissive change of the test object to include the use of 16QAM and 32QAM modulation. This report verifies maintained performance characteristics of affected items according FCC CFR47 by re-testing the updated equipment with GMSK, 16QAM and 32QAM modulation.

Summary of results

Measurement results are near identical for all modulations, apart from RMS output power, where GMSK modulation results in the highest RMS output power. GMSK modulation can be considered a worst case set-up.

Tested configurations

All measurements were performed with the test object installed in a RBS 2206 V2 rack. The hardware lists for radiated and conducted measurements are shown in appendix 7. The test object was activated at maximum power and configured for TCC mode, resulting in the highest output power achievable. Random data was transmitted in all time slots with the various modulations being tested, one at a time. This set-up was considered a worst-case configuration.

An additional band edge measurement was done with the test object configured for uncombined (UC) mode and the output power reduced as far as necessary to meet band edge requirements on channels 512 and 810. In this configuration only test object TX(/RX) 1 was active. Random data was transmitted in all time slots with various modulations being tested, one at a time.

**Conducted measurements**

Conducted measurements were done at the output connector of CDU-G 19.

Radiated measurements

During radiated emission measurements the CDU-G 19 output TX(/RX) 0 was via a 50 ohm attenuator connected to a spectrum analyser to monitor the transmitted signal. For the scope of this test it was deemed sufficient to measure and compare radiated spurious emission at the TX band center frequency for GMSK, 16QAM and 32QAM modulation. GMSK modulation with approximately 3.5 dB higher RMS output power than 8PSK modulation was chosen as worst case reference modulation to compare the new 16QAM and 32QAM modulations with.

Frequencies used

ARFCN	Frequency		Comment
512	1930.2	MHz	Low TX frequency used in uncombined (UC) mode
513	1930.4	MHz	Low TX frequency used in TCC mode
661	1960.0	MHz	TX band center frequency used in TCC mode
809	1989.6	MHz	High TX frequency used in TCC mode
810	1989.8	MHz	High TX frequency used in uncombined (UC) mode

Manufacturer's representative

Hua Yang, Ericsson (China) Communications Company Ltd

References

Measurements were done according to relevant parts of the following standards:
ANSI/TIA/EIA-603-C-2004
ANSI/TIA/EIA 136-280-D-2002

Reservation

The test results in this report apply only to the particular Equipment Under Test (EUT) as declared in the report.

Delivery of test object

The test object was delivered: 2010-05-07

Test equipment

Measurement equipment	Calibration Due	SP number
Anechoic chamber, Hertz	2010-10	15:116
Boonton RF Peak power meter/analyzer	2010-09	503 144
Boonton Power sensor 56518-S/4	2012-02	503 146
Rohde & Schwarz FSQ40	2010-07	504 143
Rohde & Schwarz FSIQ40	2010-10	503 738
Rohde & Schwarz ESI40	2010-07	503 125
Rohde & Schwarz Vector Network Analyser	2010-07	503 687
Chase bilog antenna CBL 6121A	2011-10	502 460
Schaffner Reference Dipole BSRD6500	2012-03	502 181
EMCO Horn Antenna 3115	2011-01	502 175
EMCO Horn Antenna 3115	2011-02	501 548
Flann Std gain horn 20240-20	-	503 674
MITEQ Low Noise Amplifier	2010-06	503 277
Attenuator 40 dB	2010-06	504 159
Attenuator 30 dB	2010-08	900 229
Wainright high pass filter	2011-03	504 200
RLC Electronics HP-filter F-16149	2010-06	503 739
Multimeter Fluke 87	2011-01	502 190
Testo 615 temperature and humidity meter	2012-03	503 498

Uncertainties

Measurement and test instrument uncertainties are described in the quality assurance documentation "SP-QD 10885". The uncertainties are calculated with a coverage factor $k=2$ (95% level of confidence).

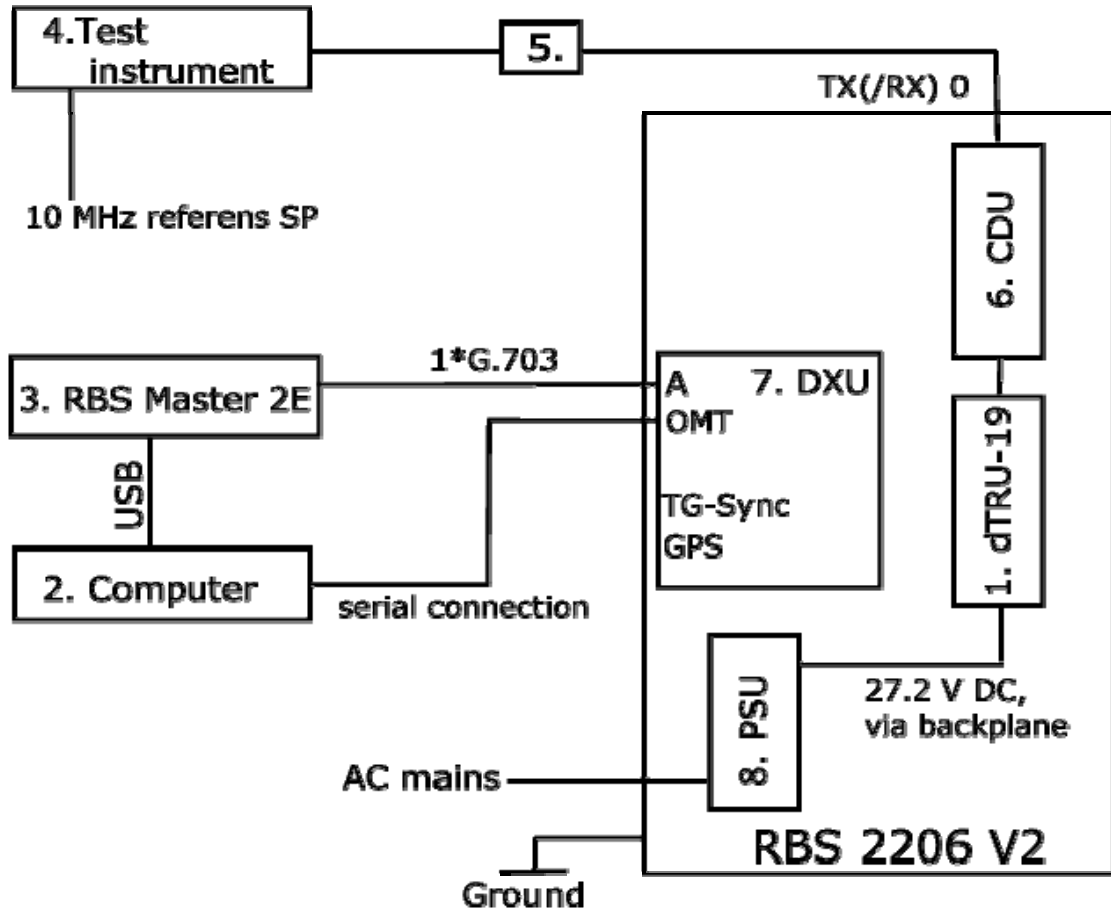
Test engineers

Fredrik Isaksson and Reinhold Reul

Test witnesses

Bo Zhao and Kevin Sun, Ericsson (China) Communications Company Ltd.

Test set-up, conducted measurements



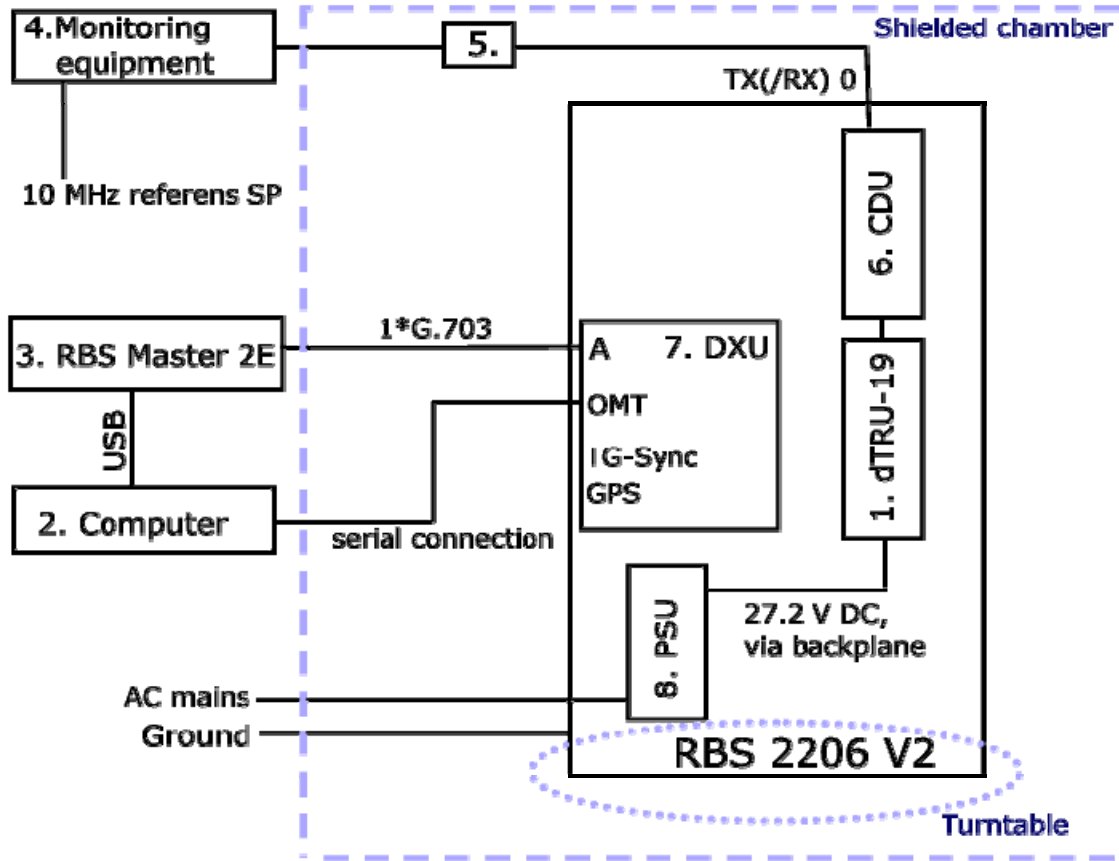
Test object

1. Transceiver Unit dTRU-19 Edge,
product number KRC 131 1004/2, revision R3A, SN AE52476778
with FCC ID: B5KDKRC1311004-2

Functional test equipment

2. HP laptop computer model Compaq NC6400,SN CND70310FD
With software RBS Master2 control software, revision R7D02
3. Ericsson RBS Master 2E hardware, product number LBY 107 1007/3, revision R1C
BAMS 1000735209
4. Measurement equipment specified in respective appendix
The modulation type was verified using client-supplied Agilent MXA Signal Analyser
model N9020A 20 Hz – 26.5 GHz, BAMS 1000737857
5. Attenuator / filter listed under test equipment in respective appendix
6. CDU G 19, product BFL 119 153/1, revision R5F, serial number A40003KLA1
7. DXU according RBS hardware list in appendix 7
8. PSU according RBS hardware list in appendix 7

Test set-up, radiated emission



Test object

1. Transceiver Unit dTRU-19 Edge,
product number KRC 131 1004/2, revision R3A, SN AE52476778
with FCC ID: B5KDKRC1311004-2

Functional test equipment

2. HP laptop computer model Compaq NC6400 SN CND72717JP
With software RBS Master2 control software, revision R7D02
3. Ericsson RBS Master 2E hardware, product number LBY 107 1007/3, revision R1C,
BAMS 1000735211
4. Rohde & Schwarz FSIQ40 for signal monitoring, SP 503738
5. Attenuator 30 dB, SP 900229
6. CDU G 19, product BFL 119 153/1, revision R5F, serial number A40003KLA1
7. DXU according RBS hardware list in appendix 7
8. PSU according RBS hardware list in appendix 7



Test object dTRU-19 connections

Interface

27.2 V DC via PSU & RBS backplane
TX 1 + TX 2, interconnection to CDU-G in TCC mode
Interconnection TX 1 + HC 1 in TCC mode
Interconnection TX 2 + HC 2 in TCC mode
RX 1 to CXU10
RX 2 to CXU10
RX 3 not connected
RX 4 not connected

Type of port

DC power
RF/Antenna
RF interconnect in
TCC mode
RF/Antenna
RF/Antenna
RF/Antenna
RF/Antenna

External RBS rack connections

Interface

AC mains
Used CDU TX(/RX) 0, used for measurement / monitoring
Used CDU TX(/RX) 1 and other CDU's outputs were unconnected
G.703, shielded multi-wire with RJ-45connector, mode E1
External alarm not connected
ESB not connected
GPS not connected
OMT interface (only configuration, not connected in normal use)

Type of port:

AC power
RF/Antenna
RF/Antenna
Telecom
Signal
Signal
Signal
O/M

RF Power output measurements according to CFR 47 2.1046

Date	Temperature	Humidity
2010-05-17	22 °C ± 3 °C	36 % ± 5 %
2010-05-18	23 °C ± 3 °C	37 % ± 5 %

Test set-up and procedure

Measurements were made at the CDU-G output connector. The output was connected to a Peak power analyser via a 50 ohm attenuator. The transmitters were modulated with pseudorandom data activated in all time slots during the measurements. The test object was configured for maximum nominal output power, using TCC mode configuration and RBS Master2E control setting 49.

Measurement equipment	SP number
Boonton RF Peak power meter/analyzer	503 144
Boonton Power sensor 56518-S/4	503 146
Multimeter Fluke 87	502 190
Testo 615 temperature and humidity meter	503 498

Measurement uncertainty: 0.7 dB

Results

The measurement was performed at ARFCN 661 (1960.0 MHz).

Test conditions Modulation		Transmitter power (dBm) Peak / RMS		
		GMSK	16QAM	32QAM
T _{nom} 22 °C	V _{nom} 27.2 V DC	46.8 / 46.0	46.9 / 42.1	46.9 / 41.2

Limits

According to CFR § 24 there are no conducted limits at the antenna connector.

§ 24.232: The peak-to-average (PAR) ratio shall not exceed 13 dB. Base stations with an emission bandwidth of 1 MHz or less are limited to 1640 watts equivalent isotropically radiated power (EIRP).

Complies?	Yes
-----------	-----

**Occupied bandwidth measurements according to 47CFR 2.1049**

Date	Temperature	Humidity
2010-05-17	22 °C ± 3 °C	36 % ± 5 %
2010-05-18	23 °C ± 3 °C	37 % ± 5 %

Test set-up and procedure

The measurements were made per definition in §24.238. Measurements were made at the output connector TX (/RX) 0 of CDU-G, which was connected to a spectrum analyser with the RMS detector activated. The spectrum analyser was connected to an external 10 MHz reference standard during the measurements. The transmitters were modulated with pseudorandom data activated in all time slots during the measurements. The test object was configured for maximum nominal output power, using TCC mode configuration and RBS Master 2E control setting 49.

Measurement equipment	SP number
Rohde & Schwarz FSQ40	504 143
Attenuator	504 159
Testo 615 temperature and humidity meter	503 498

Measurement uncertainty: 3.7 dB, 1.33 kHz

Results

The results are shown in appendix 3.1

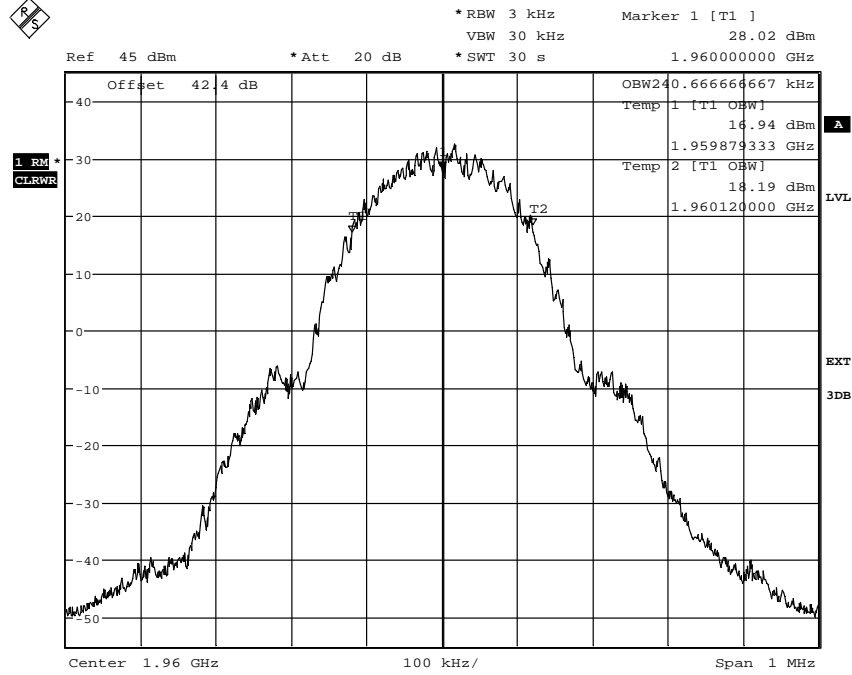
The measurement was performed at ARFCN 661 (1960.0 MHz).

	Modulation	OBW	
Diagram 1:	GMSK	240.7	kHz
Diagram 2:	16QAM	240.0	kHz
Diagram 3:	32QAM	240.7	kHz

Complies?	Yes
-----------	-----

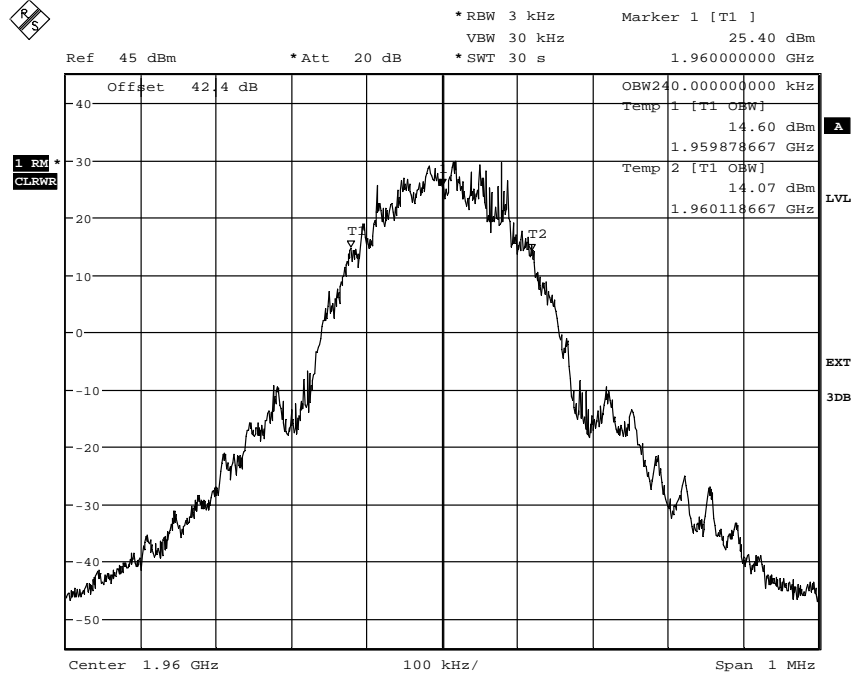


Diagram 1



Date: 17.MAY.2010 14:47:54

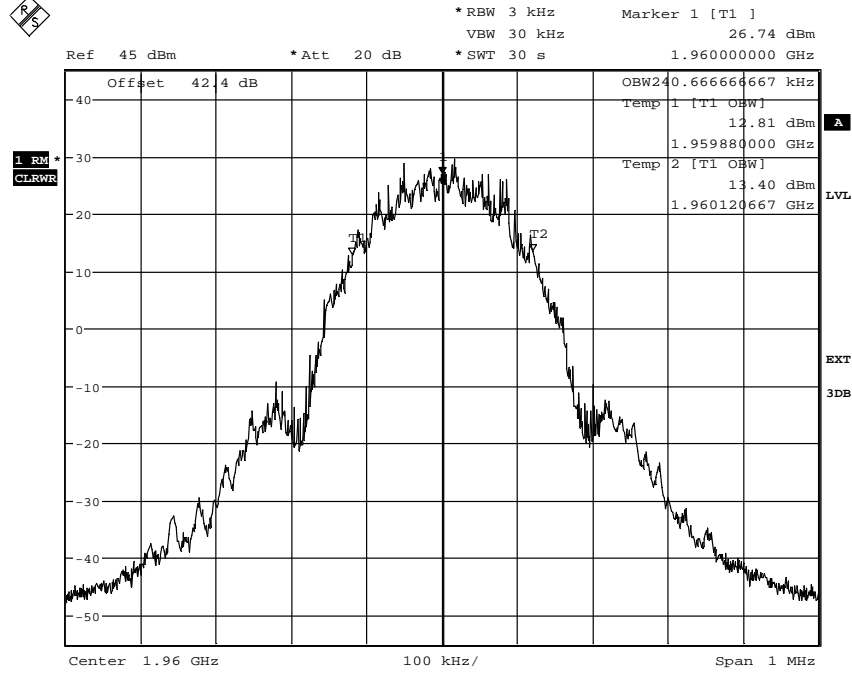
Diagram 2



Date: 18.MAY.2010 08:24:17



Diagram 3



Date: 18.MAY.2010 08:39:23

**Band edge measurements according to 47CFR 2.1051**

Date 2010-05-18	Temperature 23 °C ± 3 °C	Humidity 37 % ± 5 %
--------------------	-----------------------------	------------------------

Test set-up and procedure

The measurements were made per definition in §24.238. The measurements were made at CDU-G output connector. The output was connected to a spectrum analyzer with the RMS detector activated. The spectrum analyzer was connected to an external 10 MHz reference standard during the measurements. The transmitter was modulated with pseudorandom data during the measurements.

FCC rules specify a RBW of 1 MHz for measurements of emissions >1 MHz away from the band edges. For the measurement close to the band edges a resolution bandwidth of 3 kHz was used. The limit line was adapted to the reduced RBW by -25.2 dB ($10 \cdot \log(3/1000)$) to -38.2 dBm for frequencies >1 MHz away from the band edges. For the 10 MHz wide measurement beyond the first MHz off the band edges a RBW of 50 kHz was used and the limit was adapted by -13 dB ($10 \cdot \log(50/1000)$) to -26 dBm.

Measurement equipment	SP number
Rohde & Schwarz FSQ40	504 143
Attenuator	504 159
Testo 615 temperature and humidity meter	503 498

Measurement uncertainty: 3.7 dB**Results**

The results are shown in appendix 4.1

Configuration: Uncombined (UC) mode, RBS master 2E setting 39

- Diagram 1 16QAM, ARFCN 512 (1930.2 MHz)
- Diagram 2 16QAM, ARFCN 810 (1989.8 MHz)
- Diagram 3 32QAM, ARFCN 512 (1930.2 MHz)
- Diagram 4 32QAM, ARFCN 810 (1989.8 MHz)

Configuration: TCC mode, RBS master 2E setting 49

- Diagram 5 16QAM, ARFCN 513 (1930.4 MHz)
- Diagram 6 16QAM, ARFCN 809 (1989.6 MHz)
- Diagram 7 32QAM, ARFCN 513 (1930.4 MHz)
- Diagram 8 32QAM, ARFCN 809 (1989.6 MHz)



REPORT

Date
2010-08-16

Reference
FX009340-9

Page
2 (2)

FCC ID: B5KDKRC1311004-2

Appendix 4

Remark

The maximum output power that can be used on the channels adjacent to the frequency band edges (channel 512 and 810) with CDU-G 19 is with the RBS master 2E control software configured with a value of 39, resulting in a maximum measured RMS output power of 38.0 dBm for 16QAM and 37.6 dBm for 32QAM modulation.

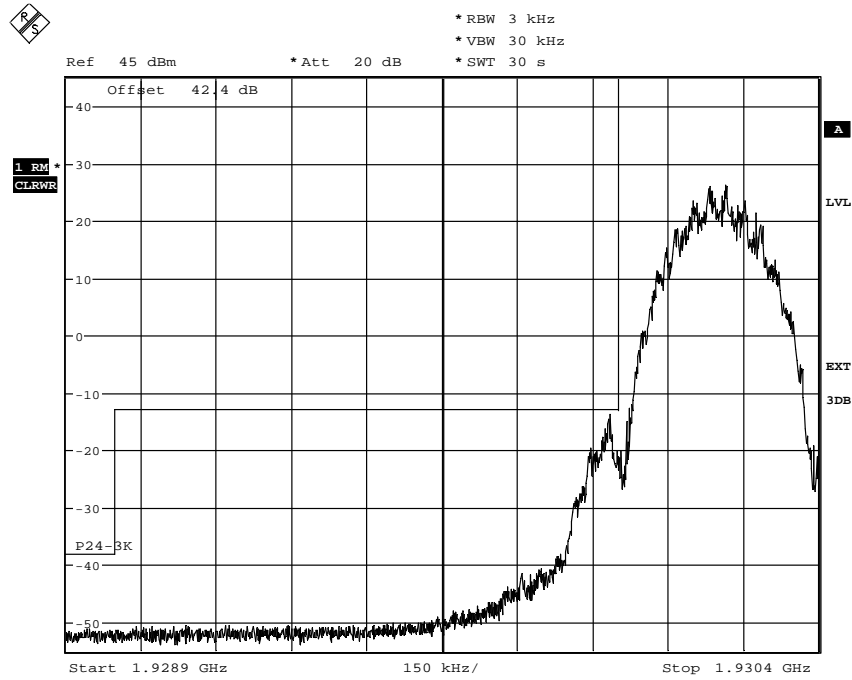
Limits

The power of any emission outside the frequency band shall be attenuated below the transmitter power (P) by at least $43 + 10 \log P$ dB.

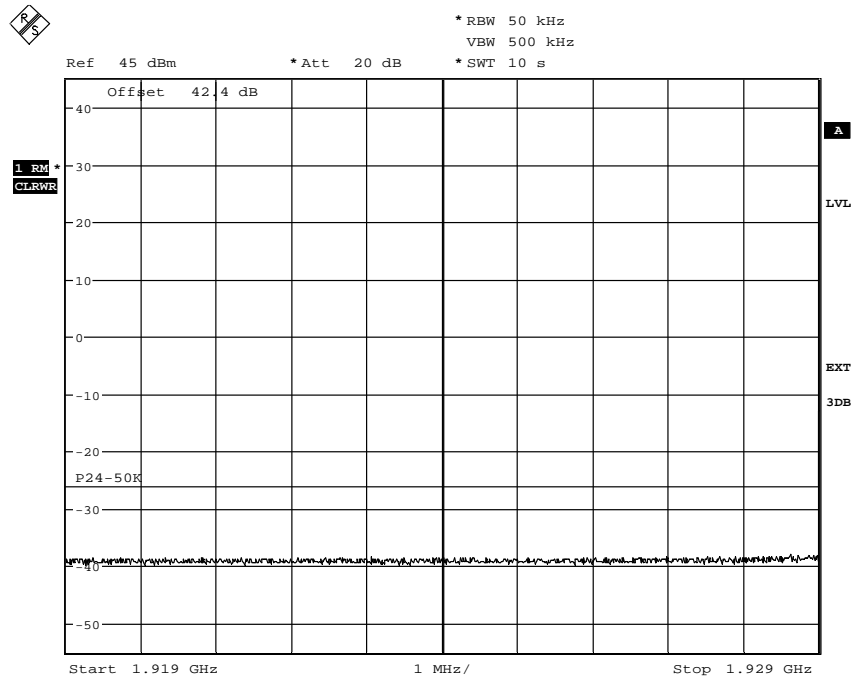
Complies?	Yes
-----------	-----



Diagram 1



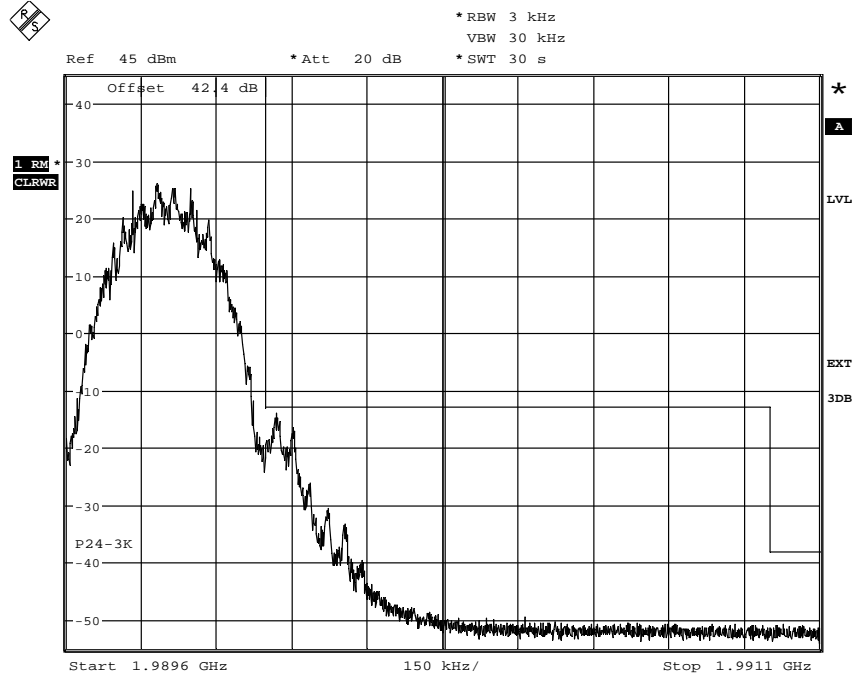
Date: 18.MAY.2010 10:07:15



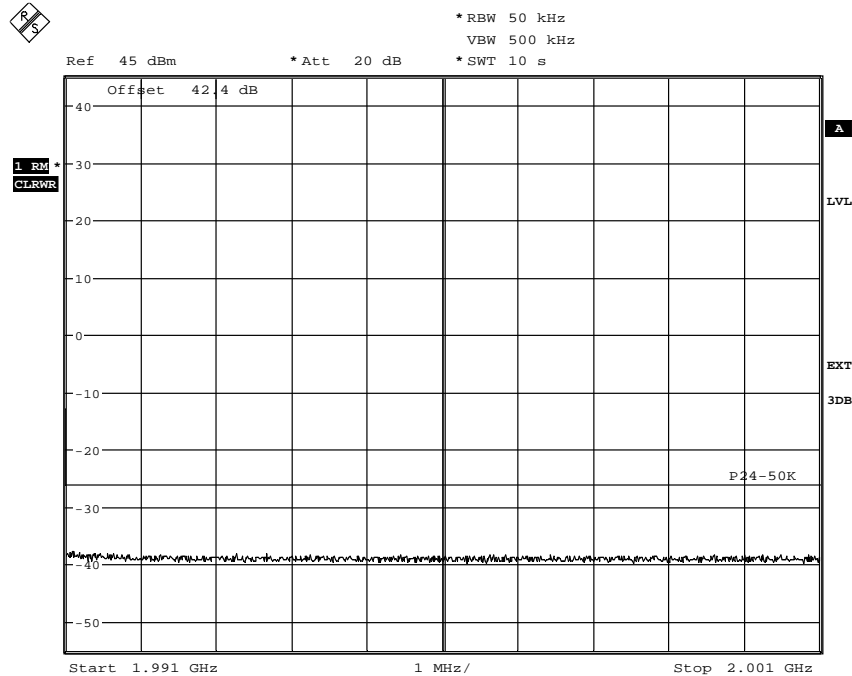
Date: 18.MAY.2010 10:11:12



Diagram 2



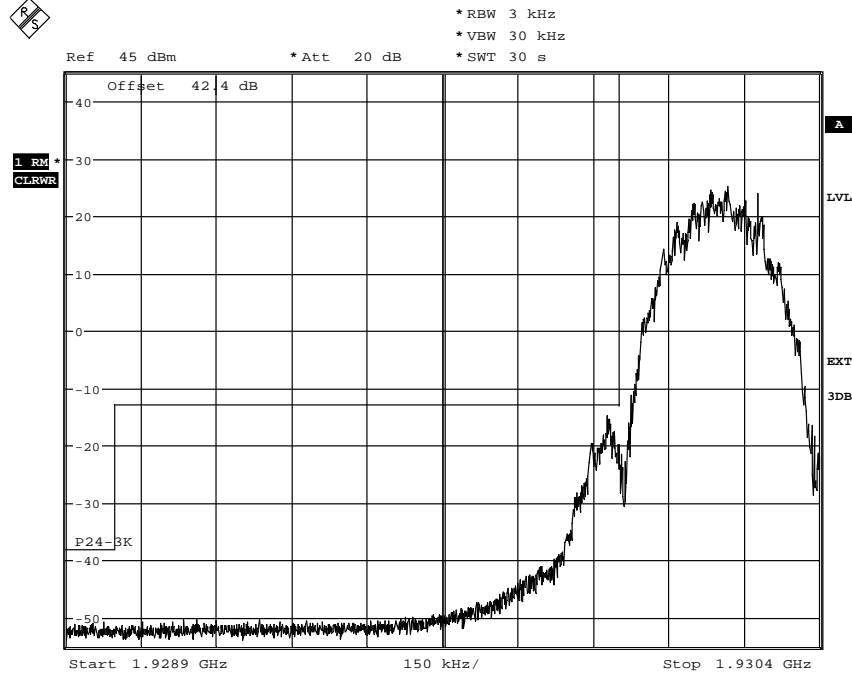
Date: 18.MAY.2010 10:30:31



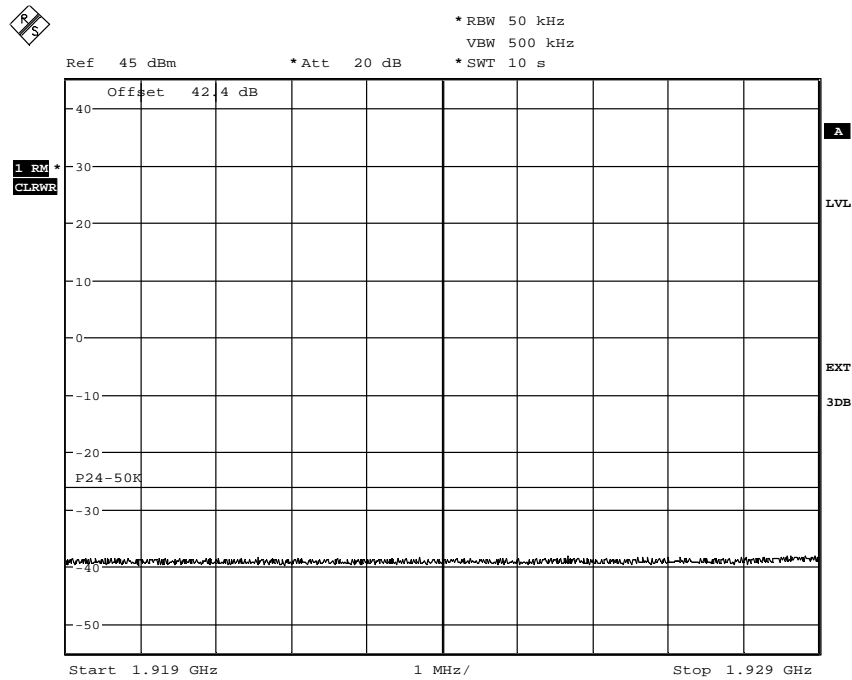
Date: 18.MAY.2010 10:34:09



Diagram 3



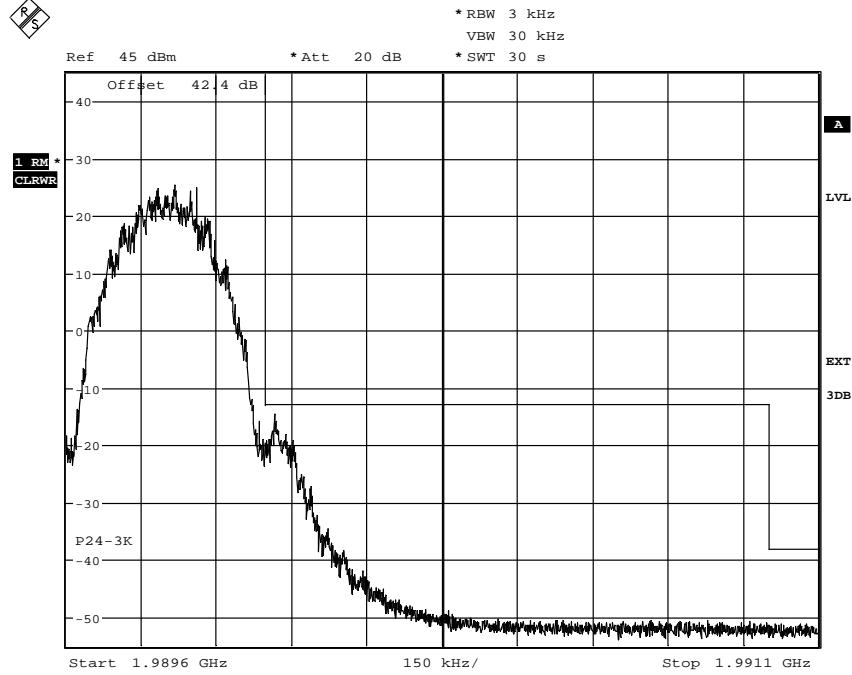
Date: 18.MAY.2010 10:15:48



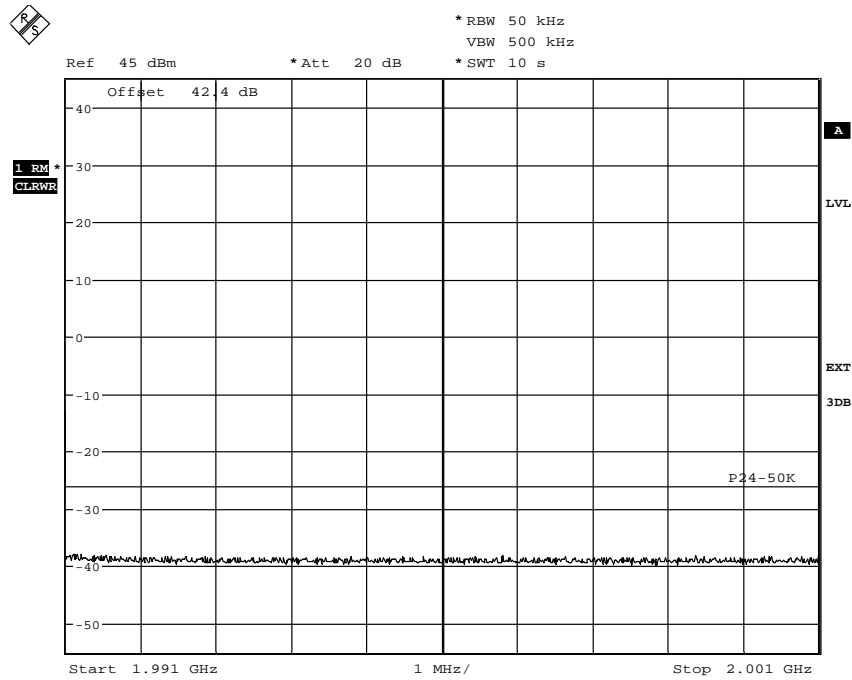
Date: 18.MAY.2010 10:21:54



Diagram 4



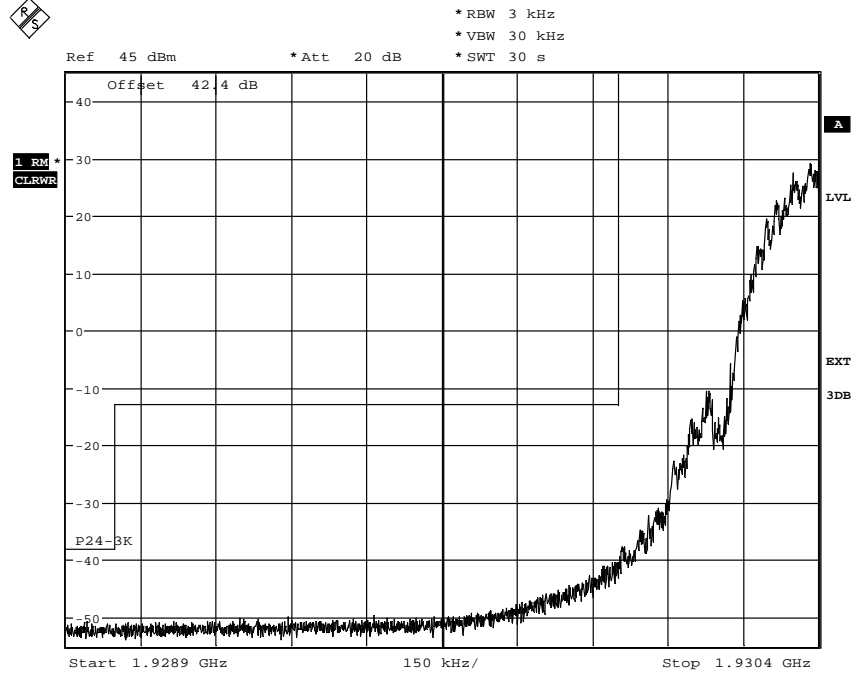
Date: 18.MAY.2010 10:37:53



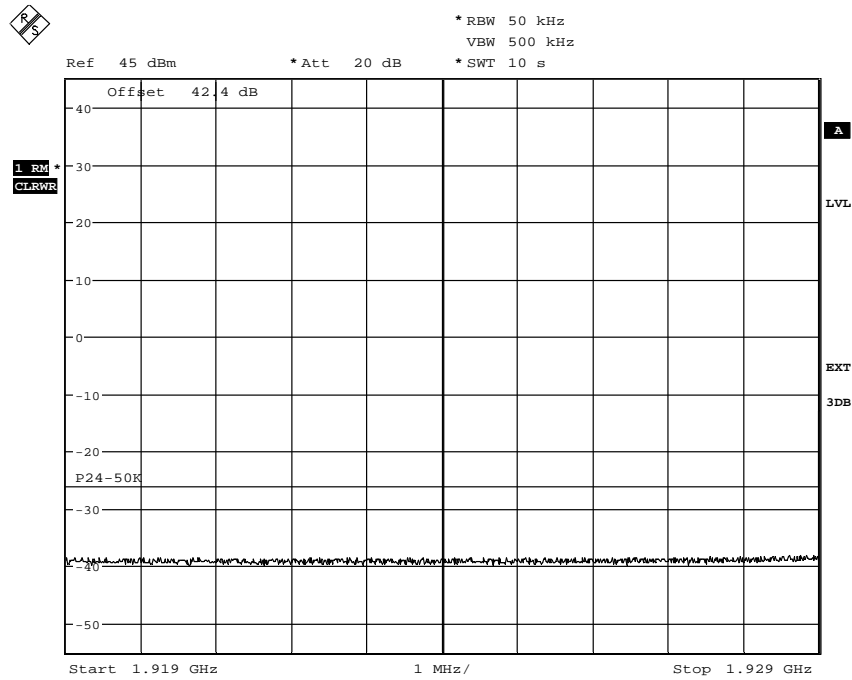
Date: 18.MAY.2010 10:40:07



Diagram 5



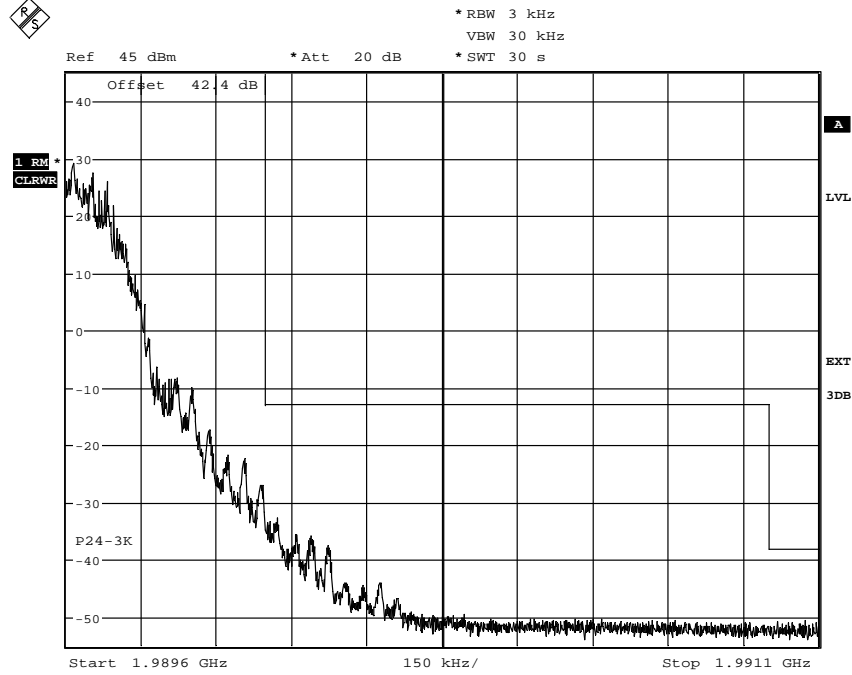
Date: 18.MAY.2010 09:05:08



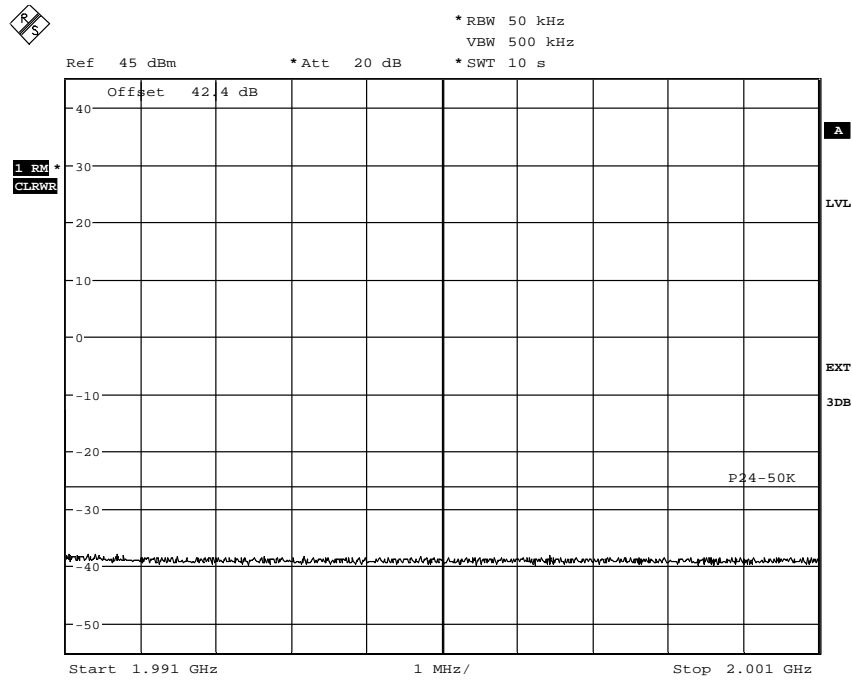
Date: 18.MAY.2010 09:06:00



Diagram 6



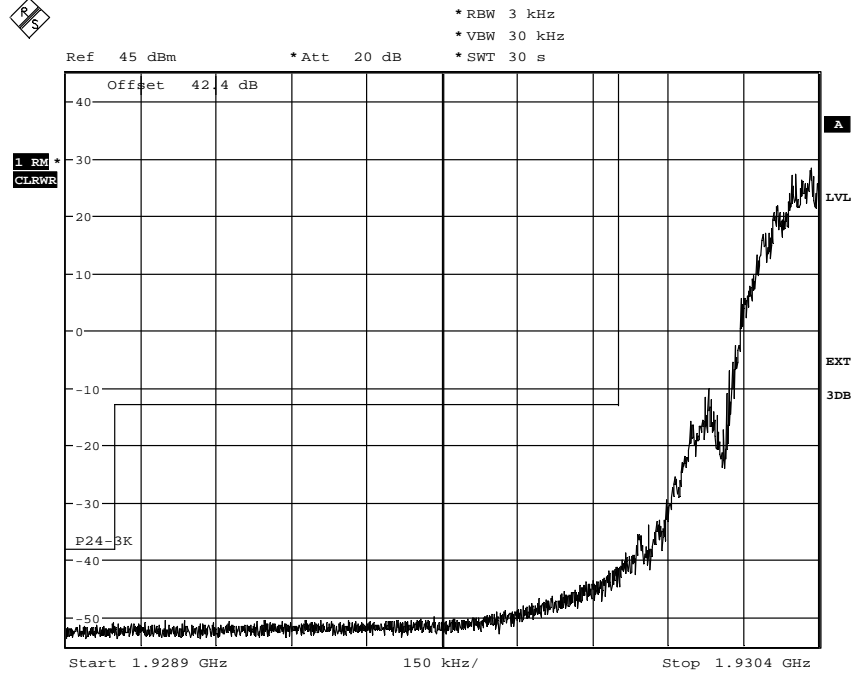
Date: 18.MAY.2010 09:21:31



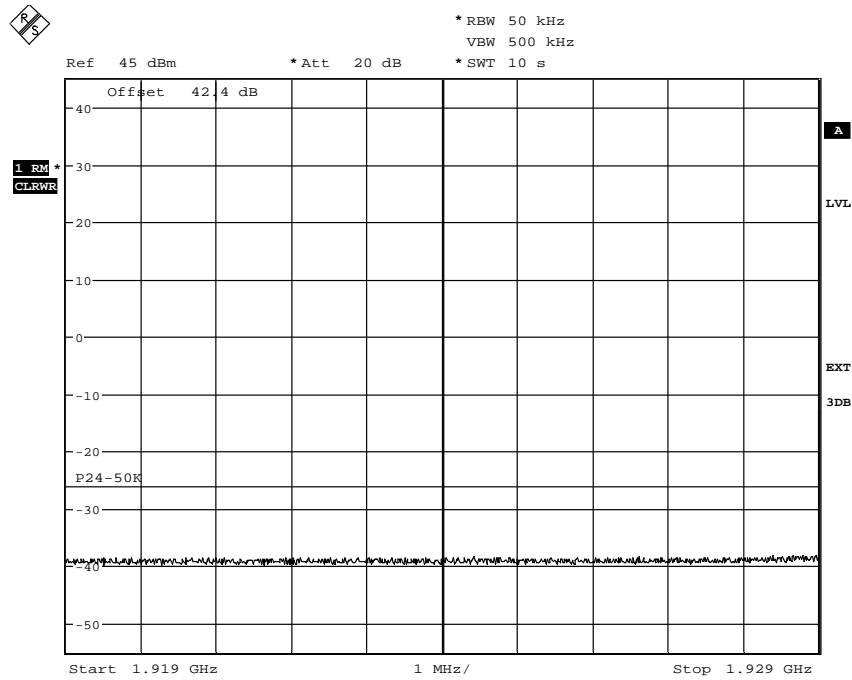
Date: 18.MAY.2010 09:22:40



Diagram 7



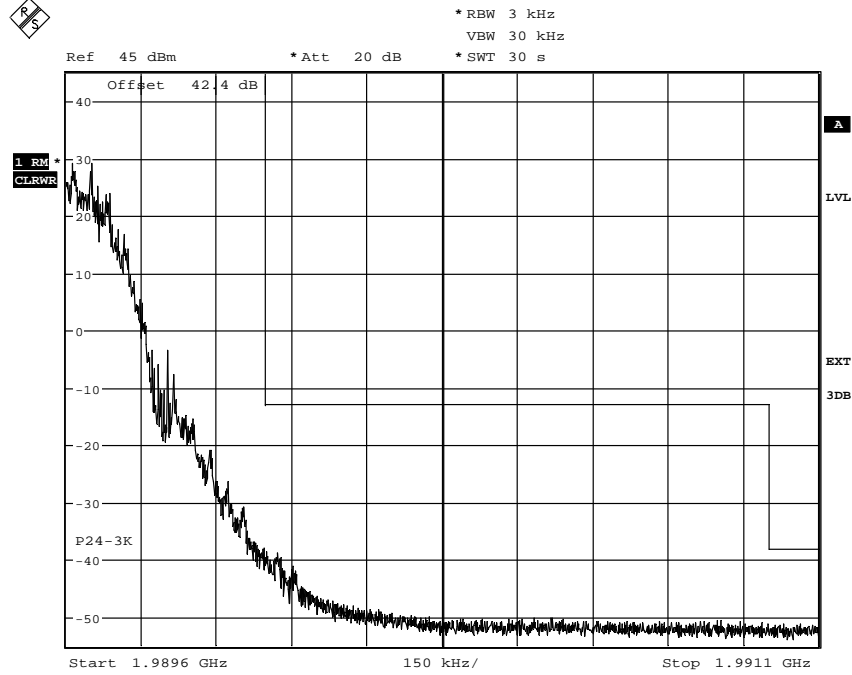
Date: 18.MAY.2010 09:14:51



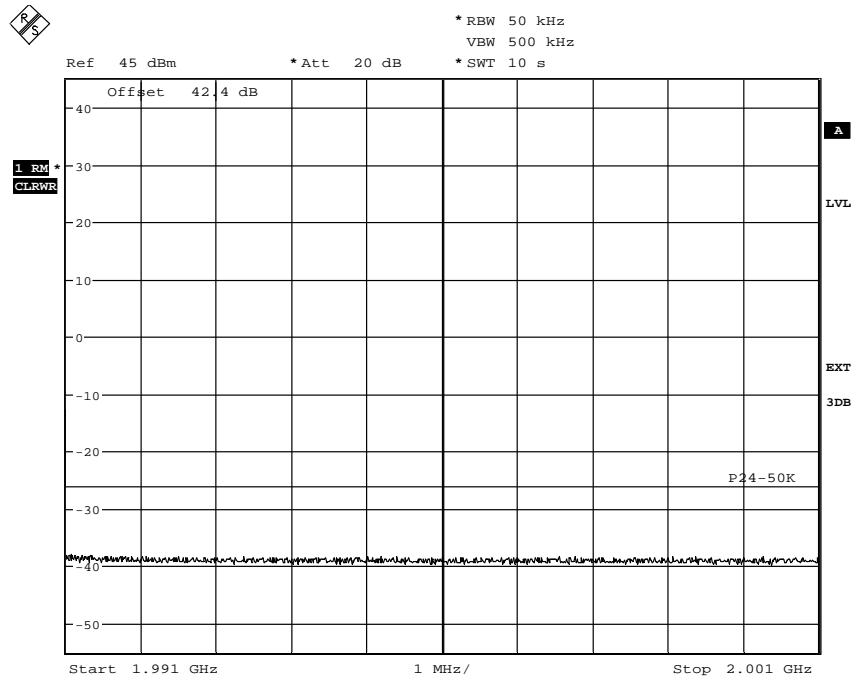
Date: 18.MAY.2010 09:15:37



Diagram 8



Date: 18.MAY.2010 09:31:02



Date: 18.MAY.2010 09:28:51



Conducted spurious emission measurements according to 47CFR 2.1051

Date	Temperature	Humidity
2010-05-17	22 °C ± 3 °C	36 % ± 5 %
2010-05-18	23 °C ± 3 °C	37 % ± 5 %

Test set-up and procedure

The measurements were made per definition in §24.238. Measurements were made at CDU-G output connector. The output was connected to a spectrum analyser. A pre-measurement was performed with the PEAK detector activated. Emission above the limit with the PEAK detector is measured with the RMS detector activated. The spectrum analyser was connected to an external 10 MHz reference standard during the measurements. The transmitter was activated at maximum output power and modulated with pseudorandom data during the measurements.

Measurement equipment	SP number
R&S FSQ	504 143
Attenuator	504 159
High pass filter	504 200
Testo 615 temperature and humidity meter	503 498

Measurement uncertainty: 3.7 dB

Results

The results are shown in appendix 5.1

Configuration 2: TCC mode

- Diagram 1: GMSK, 9 KHz – 3 GHz
- Diagram 2: GMSK, 3 GHz – 20 GHz

- Diagram 3: 16QAM, 9 KHz – 3 GHz
- Diagram 4: 16QAM, 3 GHz – 20 GHz

- Diagram 5: 32QAM, 9 KHz – 3 GHz
- Diagram 6: 32QAM, 3 GHz – 20 GHz

Remark

The emission at 9 kHz on some plots was not generated by the test object. A complementary measurement with a smaller RBW showed that it was related to the LO feedthrough.

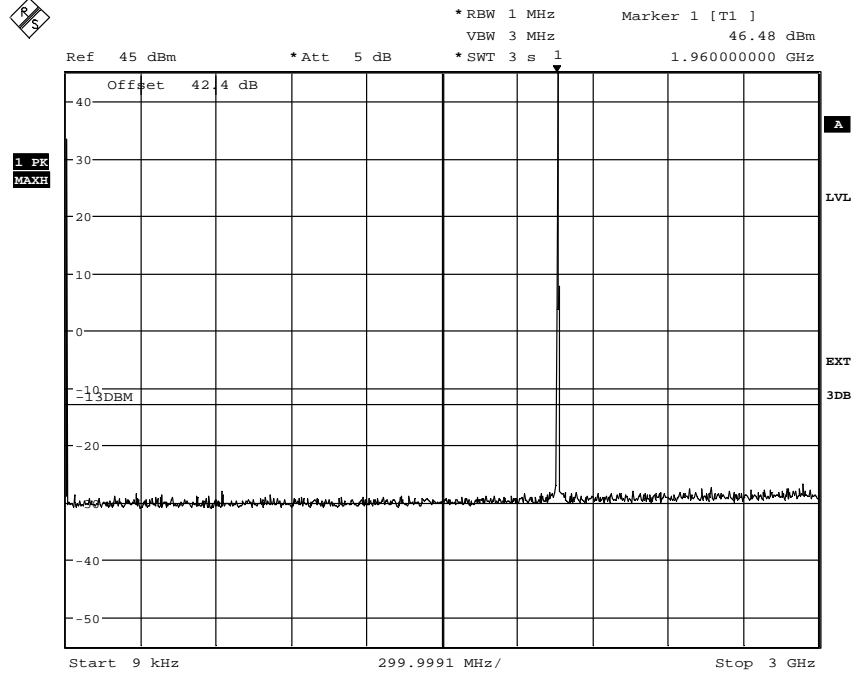
Limits

The power of any emission outside the frequency band shall be attenuated below the transmitter power (P) by at least 43 + 10 log P dB.

Complies?	Yes
-----------	-----

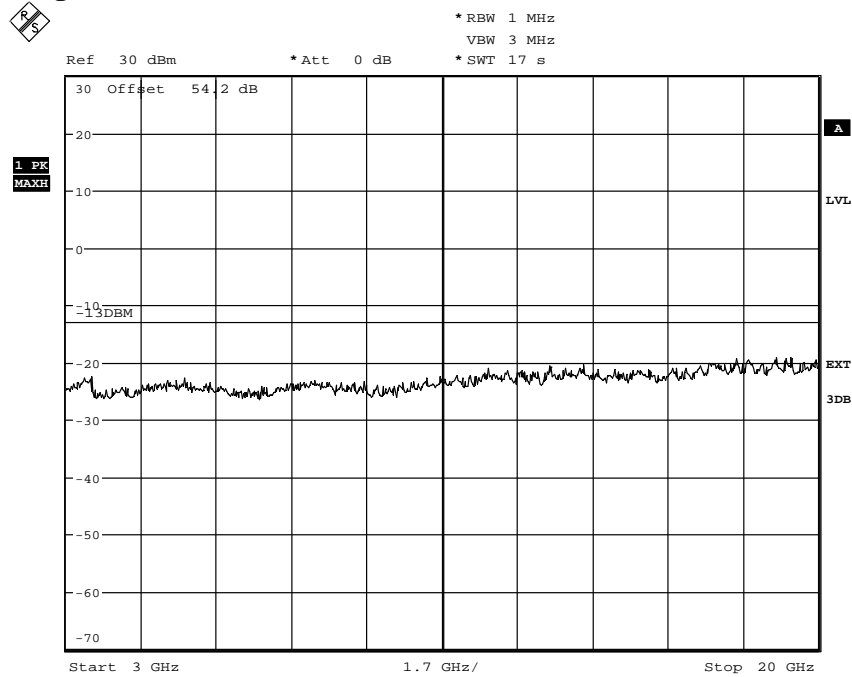


Diagram 1



Date: 17.MAY.2010 15:02:48

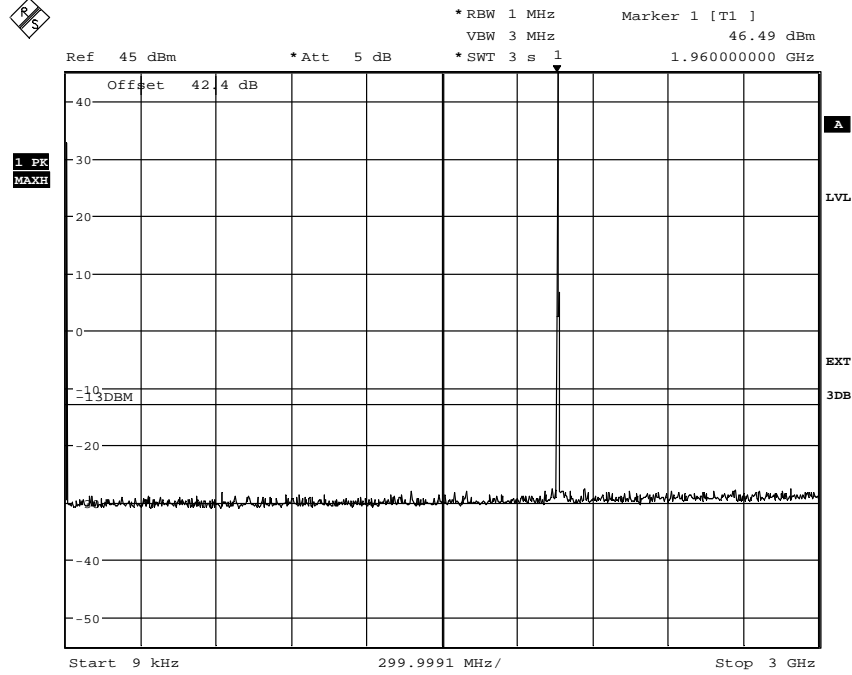
Diagram 2



Date: 17.MAY.2010 15:07:21

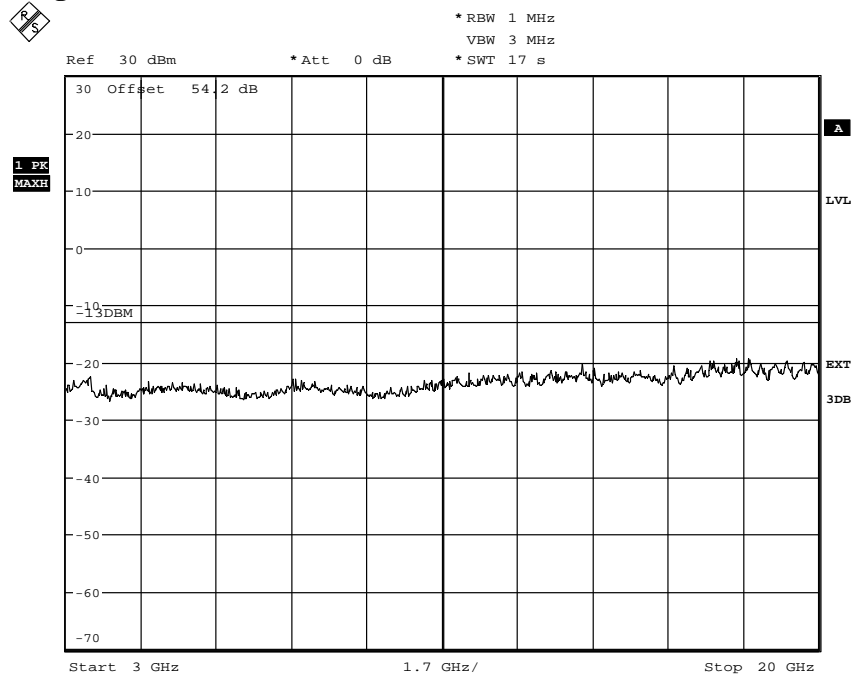


Diagram 3



Date: 18.MAY.2010 08:30:18

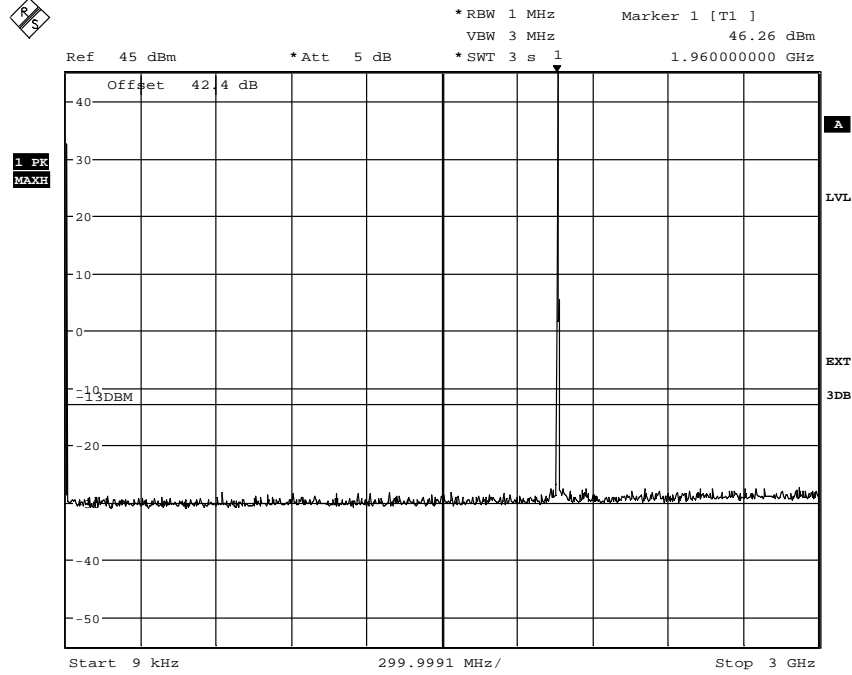
Diagram 4



Date: 18.MAY.2010 08:35:27

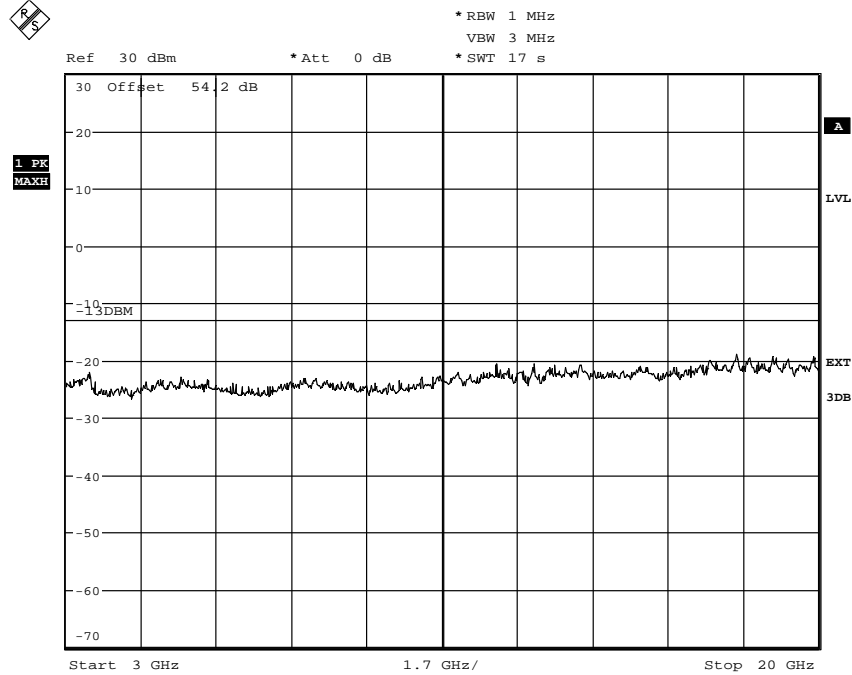


Diagram 5



Date: 18.MAY.2010 08:40:57

Diagram 6



Date: 18.MAY.2010 08:45:52

**Field strength of spurious radiation measurements according to 47CFR 2.1053**

Date	Temperature	Humidity
2010-05-25	22 °C ± 3 °C	34 % ± 5 %
2010-05-26	22 °C ± 3 °C	33 % ± 5 %

Test set-up and procedure

The measurements were performed with both horizontal and vertical polarisation of the antenna. The antenna distance was 3 m in the frequency range 30 MHz – 18 GHz and 1m in the frequency range 18-20 GHz.

The measurements were performed in Effective Radiated Power (ERP). A fully anechoic chamber was used during the measurements. The chamber is regularly calibrated with the substitution method and from that calibration an ERP correction factor is derived. The correction factor was used as a transducer to get the readings in ERP.

The measurement procedure was as the following:

1. A pre-measurement was first performed with peak detector. The EUT was continuously measured in 360 degrees.
2. Spurious radiation on frequencies closer than 6 dB to the limit was re-measured with RMS detector and with the substitution method according to the standard.

Configuration: TCC mode, RBS master 2E setting 49, TX ARFCN 661 (1960.0 MHz)

Measurement equipment	Calibration Due	SP number
Anechoic chamber, Hertz	2010-10	15:116
R&S FSIQ40 Signal Analyser	2010-07	503 738
R&S EMI Test Receiver ESI40	2010-07	503 125
Chase bilog antenna CBL 6121A	2011-10	502 460
Schaffner Reference Dipole BSRD6500	2012-03	503 649
EMCO Horn Antenna 3115	2011-01	502 175
EMCO Horn Antenna 3115	2011-02	501 548
Flann Std gain horn 20240-20	-	503 674
MITEQ Low Noise Amplifier	2010-06	503 277
R&S Vector Network Analyser	2010-07	503 687
RLC Electronics HP-filter F-16149	2010-06	503 739
Testo 615, Temperature and humidity meter	2012-03	503 498

The test set-up is shown in the picture below:





Results

Modulation GMSK

Frequency (MHz)	Spurious emission level (dBm)	
	Vertical	Horizontal
30-20 000	All emission > 20 dB below limit	All emission > 20 dB below limit

Modulation 16QAM

Frequency (MHz)	Spurious emission level (dBm)	
	Vertical	Horizontal
30-20 000	All emission > 20 dB below limit	All emission > 20 dB below limit

Modulation 32QAM

Frequency (MHz)	Spurious emission level (dBm)	
	Vertical	Horizontal
30-20 000	All emission > 20 dB below limit	All emission > 20 dB below limit

Measurement uncertainty: 3.2 dB up to 18 GHz, 3.6 dB above 18 GHz

Limits

The power of any emission outside the frequency band shall be attenuated below the transmitter power (P) by at least $43 + 10 \log P$ dB.

Complies?	Yes
-----------	-----



FCC ID: B5KDKRC1311004-2

Appendix 7

Hardware list RBS 2206 V2, conducted measurements

Unit	Product Number	Revision	Serial Number
Cabinet RBS 2206 V2	SEB 112 1154/1	R3A	AB20131926
Door	SXK 109 7157/1	R1B	-
ACCU-11	BMG 980 07/09	R1C	(S)BH41071675
Subrack	BFL 119 424/1	R2C	-
CDU-G19	BFL 119 153/1	R5F	A40003KLA1
CDU-G19	BFL 119 153/1	R5F	TR40177576
CDU-G19	BFL 119 153/1	R5F	A40003TYJ8
Dummy	SXK 107 5031/2	R1B	-
CXU-10	KRY 101 1856/1	R3D	TR43605527
Dummy	SXK 107 5031/1	R1B	-
TRU shelf	BFL 119 425/1	R1C	-
Backplane	BFX 101 107/3	R1B	-
Empty	-	-	-
Empty	-	-	-
dTRU-19	KRC 131 1004/2	R3A	AE52476778
Empty	-	-	-
Empty	-	-	-
Empty	-	-	-
IDM-11	BMG 980 327/2	R1B	X181175710
PSU-shelf	BFL 119 453/1	R1A	(S)BK41073473
Backplane	BFX 101 107/3	R1A	-
PSU-AC-32	BML 353 206/2	R1C	(S)BR80299542
PSU-AC-32	BML 353 206/2	R1C	(S)BR80397732
PSU-AC-32	BML 353 206/2	R1C	(S)BR80348807
Dummy	SXK 107 9314/1	R1C	-
Cover plate	-	-	-
(Empty gap)	-	-	-
DXU-23	BOE 602 21/1	R1C/A	TU8D176697

**Hardware list RBS 2206 V2, radiated measurements**

Unit	Product Number	Revision	Serial Number
Cabinet RBS 2206 V2	SEB 112 1154/1	R3A	AB20131926
Door	SXK 109 7157/1	R1B	-
ACCU-11	BMG 980 07/09	R1C	(S)BH41071675
Subrack	BFL 119 424/1	R2C	-
CDU-G19	BFL 119 153/1	R5F	TR40177576
CDU-G19	BFL 119 153/1	R5F	A40003KLA1
CDU-G19	BFL 119 153/1	R5F	A40003TYJ8
Dummy	SXK 107 5031/2	R1B	-
CXU-10	KRY 101 1856/1	R3D	TR43605527
Dummy	SXK 107 5031/1	R1B	-
TRU shelf	BFL 119 425/1	R1C	-
Backplane	BFX 101 107/3	R1B	-
Empty	-	-	-
Empty	-	-	-
dTRU-19	KRC 131 1004/2	R3A	AE52476778
Empty	-	-	-
Empty	-	-	-
Empty	-	-	-
IDM-11	BMG 980 327/2	R1B	X181175710
PSU-shelf	BFL 119 453/1	R1A	(S)BK41073473
Backplane	BFX 101 107/3	R1A	-
PSU-AC-32	BML 353 206/2	R1C	(S)BR80348807
Dummy	SXK 107 9314/1	R1C	-
Cover plate	-	-	-
(Empty gap)	-	-	-
DXU-23	BOE 602 21/1	R1C/A	TU8D176697

Test object software during both radiated and conducted measurements

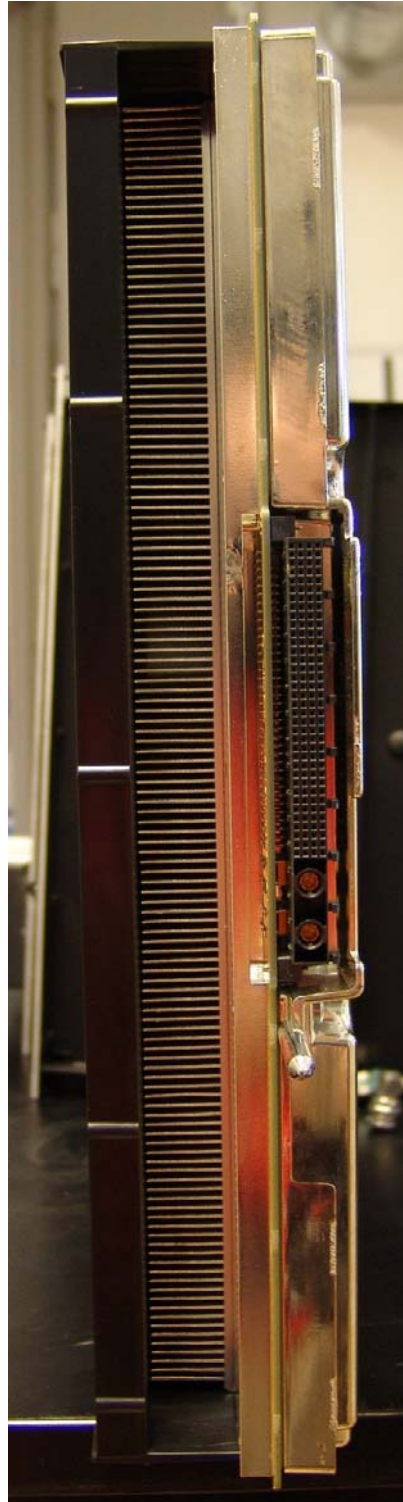
Software	Revision
CXP 104 0007/05	G11B

Photos of the test object

Front side



Rear side



Left side



Right side

