



REPORT

issued by an Accredited Testing Laboratory, FCC listed with Reg. no. 93866 and IC recognized pursuant IC file no. 3482A.

Contact person
Reinhold Reul
Electronics
+46 10 516 55 84
Reinhold.Reul@sp.se

Date
2012-03-29

Reference
FX108941-15

Page
1 (2)



Ericsson (China) Communications Company Ltd
Att. Hua Yang
Ericsson Tower
No. 5 Lize East Street
Chaoyang District, Beijing 100102
P. R. China

Class II Permissive Change measurements on RRU-M19 1900 MHz cellular radio equipment with FCC ID: B5KCKRC16184-3

(7 appendices)

Test object

RRU-M19, product KRC 161 84/3, revision R7E

Summary

Standard	Compliant	Appendix
FCC CFR 47		
2.1046 RF Power output	Yes	2
2.1049 Occupied bandwidth	Yes	3
2.1051 Band Edge	Yes	4
2.1051 Spurious emission at antenna port	Yes	5
2.1053 Field strength of spurious radiation	Yes	6

SP Technical Research Institute of Sweden Electronics - EMC

Performed by

Reinhold Reul

Examined by

Christer Karlsson

SP Technical Research Institute of Sweden

Postal address
SP
Box 857
SE-501 15 BORÅS
Sweden

Office location
Västeråsen
Brinellgatan 4
SE-504 62 BORÅS

Phone / Fax / E-mail
+46 10 516 50 00
+46 33 13 55 02
info@sp.se

Laboratories are accredited by the Swedish Board for Accreditation and Conformity Assessment (SWEDAC) under the terms of Swedish legislation. This report may not be reproduced other than in full, except with the prior written approval of the issuing laboratory.

Table of contents

Description of the test object	Appendix 1
Operation mode during measurements	Appendix 1
Purpose of test	Appendix 1
Test setups	Appendix 1
RF power output	Appendix 2
Occupied bandwidth	Appendix 3
Band edge	Appendix 4
Spurious emission at antenna terminals	Appendix 5
Field strength of spurious radiation	Appendix 6
Photos of the test object	Appendix 7

Appendix 1

Description - Equipment Under Test (EUT)

Equipment:	GSM Base Station Transceiver				
TX frequency band:	1930 - 1990 MHz				
Modulations:	GMSK, 8PSK, 16QAM, 32QAM and AQPSK				
Nominal maximum output power, RMS value in [dBm]:	Per modulation:				
	GMSK	8PSK	16QAM	32QAM	AQPSK
	33.5	30.2	28.8	28.4	30.1
Nominal supply voltage:	-48 V DC				

Purpose of test

The purpose of this test is to justify a Class II Permissive Change of the test object to include the use of AQSPK modulation in SCPIR 0 dB. This report verifies maintained performance characteristics of affected items by re-testing the updated equipment and comparing results for prior worst case modulation GMSK with results for the new modulation.

Tested configurations and set-ups

The EUT was tested as an integral part of a RBS 2308 as described below. The EUT was activated at maximum nominal RF output power, with RBS Master 2 setting 33, and random data was transmitted in all time slots, with the various modulations being tested one at time. Connections and reference points for measurements are shown in the set-ups below.

Test frequencies used

Channel	ARFCN	Frequency	Comment
B	512	1930.2 MHz	TX lowest frequency
M	661	1960.0 MHz	TX band center frequency
T	810	1989.8 MHz	TX highest frequency

Appendix 1

Test set-up, conducted measurements

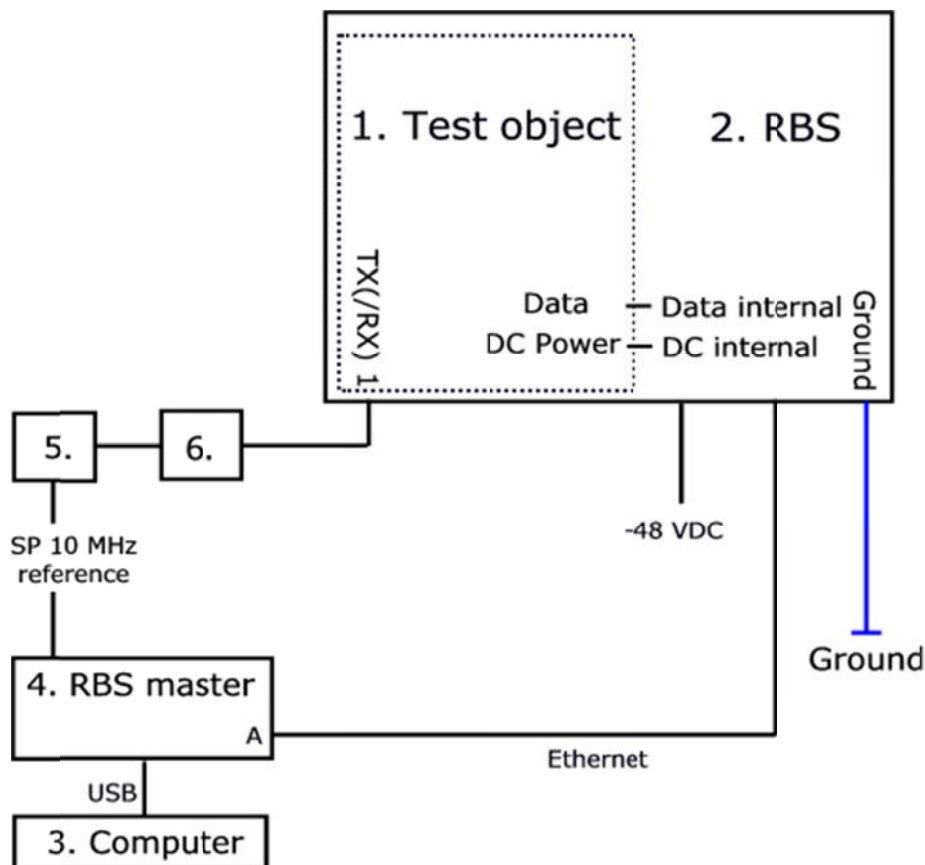

Note: Unconnected ports are omitted for simplicity.

Test object

1. RRU-M19, product KRC 161 84/3, revision R7E, SN CB4C638118 with FCC ID: B5KCKRC16184-3

Functional test equipment

2. RBS 2308, consisting of the test object and MBU-01, product SEB 112 1133/3, revision R3A, SN B340607738 and IXU-21, product BOE 602 15/2, revision R5C, SN AE53030513
3. Laptop Compaq nc6220, S/N: CNU54722NZ, BAMS 1000208319, with RBS Master 2E control software
4. RBS Master 2E hardware, product LPY 107 1007/3, revision R1C/A, SN T01E655543, BAMS 1000878432, with shielded Ethernet multi-wire connected to RBS internal data port, using transmission mode E1
5. Measurement equipment specified in respective appendix or client supplied Agilent MXA Signal Analyser model N9020A 20 Hz – 3.6 GHz, BAMS 1000785533 used to verify the modulation schemes
6. Attenuator / filter listed under test equipment in respective appendix

Appendix 1

Test set-up, radiated emission

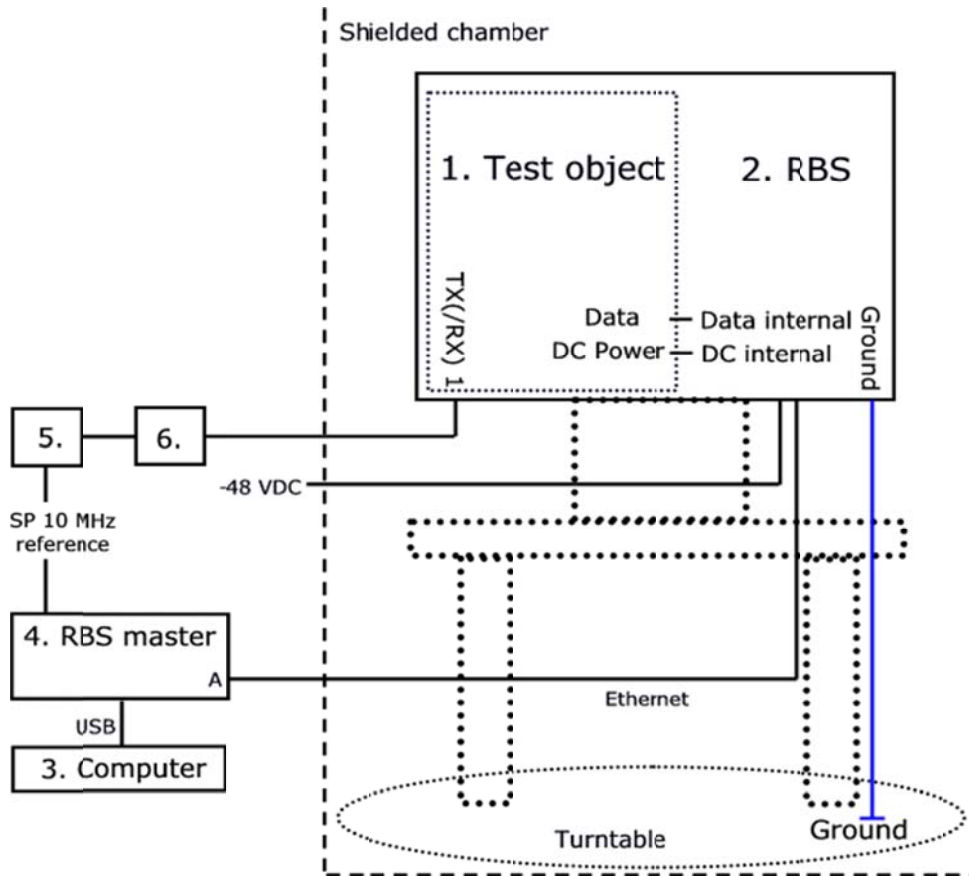

Note: Unconnected ports are omitted for simplicity.

Test object

1. RRU-M19, product KRC 161 84/3, revision R7E, SN CB4C638118 with FCC ID: B5KCKRC16184-3

Functional test equipment

2. RBS 2308, consisting of the test object and MBU-01, product SEB 112 1133/3, revision R3A, SN B340607738 and IXU-21, product BOE 602 15/2, revision R5C, SN AE53030513
3. Laptop Compaq nc6220, S/N: CNU54722NZ, BAMS 1000208319, with RBS Master 2E control software
4. RBS Master 2E hardware, product LPY 107 1007/3, revision R1C/A, SN T01E655543, BAMS 1000878432, with shielded Ethernet multi-wire connected to RBS internal data port, using transmission mode E1
5. Rohde & Schwarz ESI40 (SP 503 125) for signal monitoring or 50 ohm termination
6. Attenuator 30 dB, SP 900229

Appendix 1

Test object connections

Interface	Type of port
DC provided RBS internal, nominal -48 VDC	DC power
Ground connected to grounded RBS shell on top side	Ground
TX/(RX) 1, N female connector	Antenna
TX/(RX) 2, N female, unconnected	Antenna
RXBP 1 and RXBP 2, TNC female, unconnected,	Antenna
The RXBP ports may be used for connecting an optional RX band pass filter not used on the tested sample	
RBS internal Y-link for data, with IEEE-1394 connector	Signal

Note: Unconnected ports are omitted in the drawings above for simplicity. The photos in appendix 7 show EUT top & bottom views with all ports.

Test object software

Software	Revision
CXP 104 0007/05	R31E

References

Measurements were done according to relevant parts of the following standards:

- ANSI C63.4-2009
- ANSI/TIA/EIA-603-C-2004
- ANSI/TIA/EIA 136-280-D-2002
- CFR 47 part 2, October 1st, 2010
- CFR 47 part 24, October 1st, 2010

Reservation

The test results in this report apply only to the particular Equipment Under Test (EUT) as declared in the report.

Delivery of test object

The test object was delivered: 2011-06-07

Appendix 1

Test equipment

Measurement equipment	Calibration Due	SP number
Anechoic chamber, Hertz	2013-10	15:116
Boonton 4500A RF Peak power meter/analyser	2012-11	503 144
Boonton Power sensor 56518-S/4	2012-11	503 146
Rohde & Schwarz FSQ40	2012-07	504 143
Rohde & Schwarz FSIQ40	2012-07	503 738
Rohde & Schwarz ESI40	2012-07	503 125
Rohde & Schwarz Vector Network Analyser	2012-07	503 687
Chase bilog antenna CBL 6121A	2014-10	502 460
Schaffner Reference Dipole BSRD6500	2012-03	502 181
EMCO Horn Antenna 3115	2014-01	502 175
EMCO Horn Antenna 3115	2014-01	501 548
Flann Std gain horn 20240-20	2014-03	503 674
MITEQ Low Noise Amplifier	2012-08	503 277
Attenuator 40 dB	2012-08	504 159
Attenuator 30 dB	2012-08	900 229
High pass filter	2012-08	504 200
High pass filter	2012-08	503 739
Multimeter Fluke 87	2012-05	502 190
Testo 615 temperature and humidity meter	2012-03	503 498
Testo 635 temperature and humidity meter	2013-05	504 203

Uncertainties

Measurement and test instrument uncertainties are described in the quality assurance documentation "SP-QD 10885". The uncertainties are calculated with a coverage factor $k=2$ (95% level of confidence).

Reservation

The test results in this report apply only to the particular Equipment Under Test (EUT) as declared in the report.

Test engineers

Jörgen Wassholm, Martin Nilsson, Martin Forsberg and Reinhold Reul, SP

Manufacturer's representative

Hua Yang, Ericsson (China) Communications Company Ltd

Test witness

-

Appendix 2

RF Power output measurements according to CFR 47 2.1046

Date 2011-12-07	Temperature 22 °C ± 3 °C	Humidity 64 % ± 5 %
--------------------	-----------------------------	------------------------

Test set-up and procedure

Measurements were made with EUT port TX(/RX) 1 via a 50 ohm attenuator connected to a peak power analyser.

Measurement equipment	SP number
Boonton 4500A RF Peak power meter/analyzer	503 144
Boonton Power sensor 56518-S/4	503 146
Attenuator	504 159
Multimeter Fluke 87	502 190
Testo 615 temperature and humidity meter	503 498

Measurement uncertainty: 0.7 dB

Results

Configuration: RBS master 2E setting 33 for maximum nominal RF output power.

Transmitter power (dBm)		Peak / RMS
Modulation		Channel M
GMSK		34.0 / 33.3
AQPSK		33.7 / 29.8

The highest PAR measured above was 3.9 dB.

Limits

According to CFR § 24 there are no conducted limits at the antenna connector.

§ 24.232: The peak-to-average (PAR) ratio shall not exceed 13 dB. Base stations with an emission bandwidth of 1 MHz or less are limited to 1640 watts equivalent isotropically radiated power (EIRP).

Complies?	Yes
-----------	-----

Appendix 3

Occupied bandwidth measurements according to CFR 47 2.1049

Date 2011-12-07	Temperature 22 °C ± 3 °C	Humidity 64 % ± 5 %
--------------------	-----------------------------	------------------------

Test set-up and procedure

The measurements were made per definition in §24.238. Measurements were made with EUT port TX/(RX) 1 via a 50 ohm attenuator connected to a spectrum analyser with the RMS detector activated. The spectrum analyser was connected to an external 10 MHz reference standard during the measurements.

Measurement equipment	SP number
Rohde & Schwarz FSIQ40	503 738
Attenuator	504 159
Multimeter Fluke 87	502 190
Testo 615 temperature and humidity meter	503 498

Measurement uncertainty: 3.7 dB, 1.33 kHz

Results

Configuration: RBS master 2E setting 33 for maximum nominal output power.

	Channel	Modulation	OBW
Diagram 1:	M	GMSK	241 kHz
Diagram 2:	M	AQPSK	237 kHz

The diagrams are shown on the following page.

Appendix 3

Diagram 1:

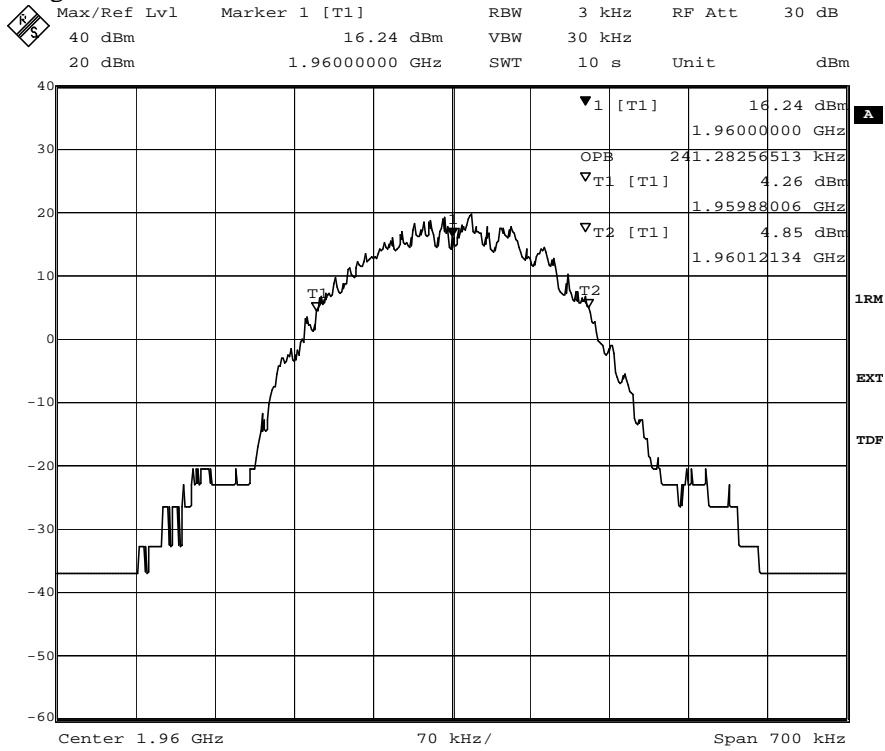

Date: 7.DEC.2011 13:28:14

Diagram 2:

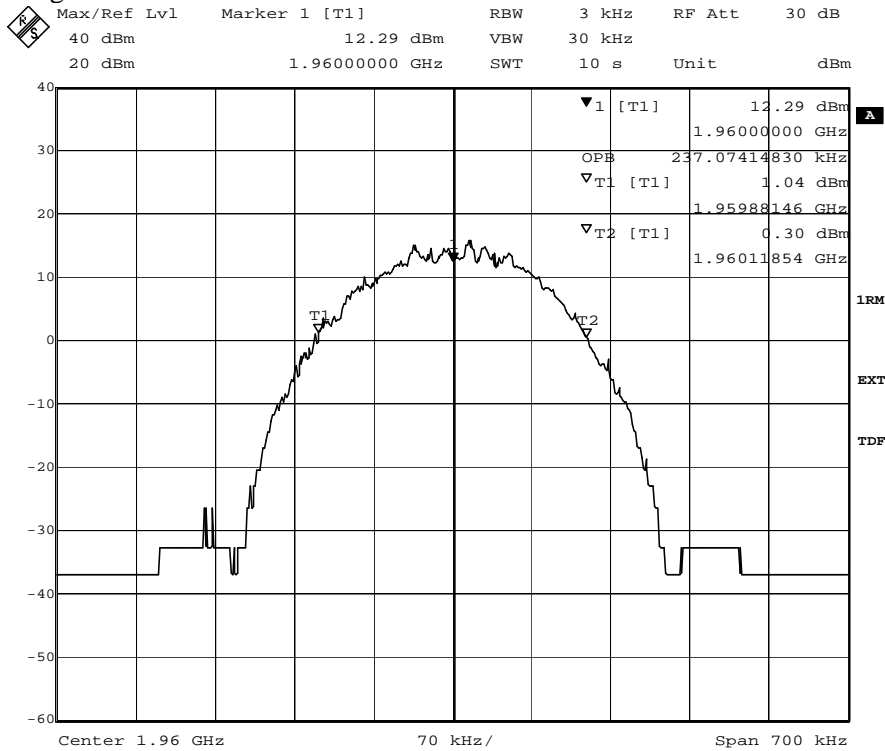

Date: 7.DEC.2011 13:34:54

Appendix 4

Band edge measurements according to CFR 47 2.1051

Date 2011-12-07	Temperature 22 °C ± 3 °C	Humidity 64 % ± 5 %
--------------------	-----------------------------	------------------------

Test set-up and procedure

The measurements were made per definition in §24.238. EUT port TX/(RX) 1 was via a 50 ohm attenuator connected to a spectrum analyzer with the RMS detector activated. The spectrum analyzer was connected to an external 10 MHz reference standard during the measurements.

The standard allows a RBW of 1% of the EBW within the 1st MHz off the band-edge and requires a RBW of 1 MHz for offsets beyond 1 MHz. Where a reduced RBW was used the limit line was adapted by $(10 \cdot \log(\text{RBW}_{\text{used}}/1 \text{ MHz})) \text{ dB}$.

Measurement equipment	SP number
Rohde & Schwarz FSIQ40	503 738
Attenuator	504 159
Multimeter Fluke 87	502 190
Testo 615 temperature and humidity meter	503 498

Measurement uncertainty: 3.7 dB

Results

Configuration: RBS master 2E setting 33 for maximum nominal output power.

Diagram	Channel	Modulation
1 a, b, c	B	AQPSK
2 a, b, c	T	AQPSK

The diagrams are shown on the following pages.

Limits

The power of any emission outside the frequency band shall be attenuated below the transmitter power (P) by at least $43 + 10 \log P \text{ dB}$.

Complies?	Yes
-----------	-----

Appendix 4

Diagram 1 a:

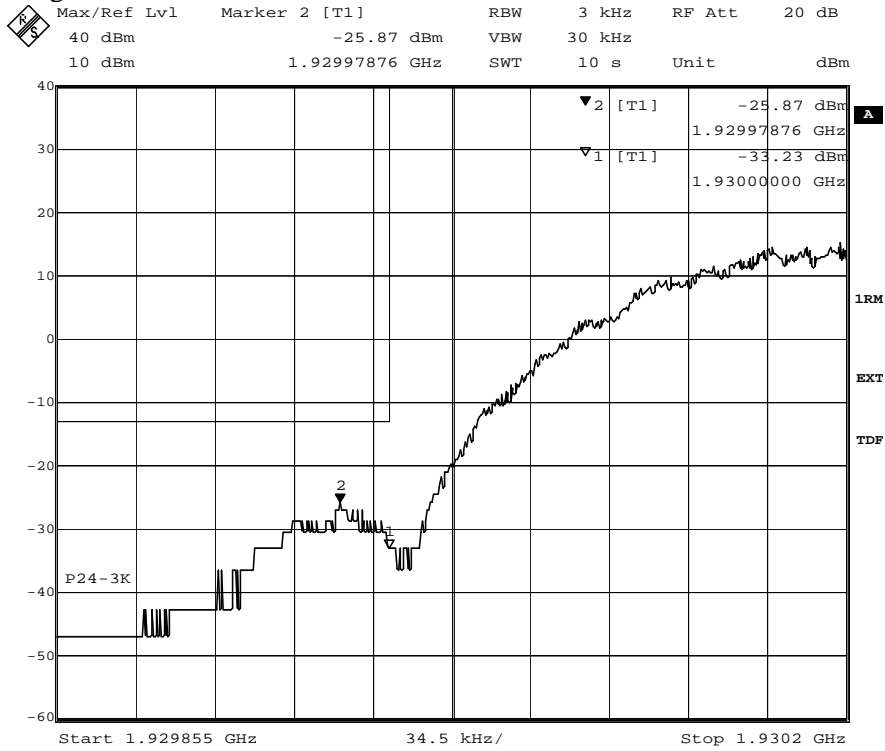

Date: 7.DEC.2011 13:08:09

Diagram 1 b:

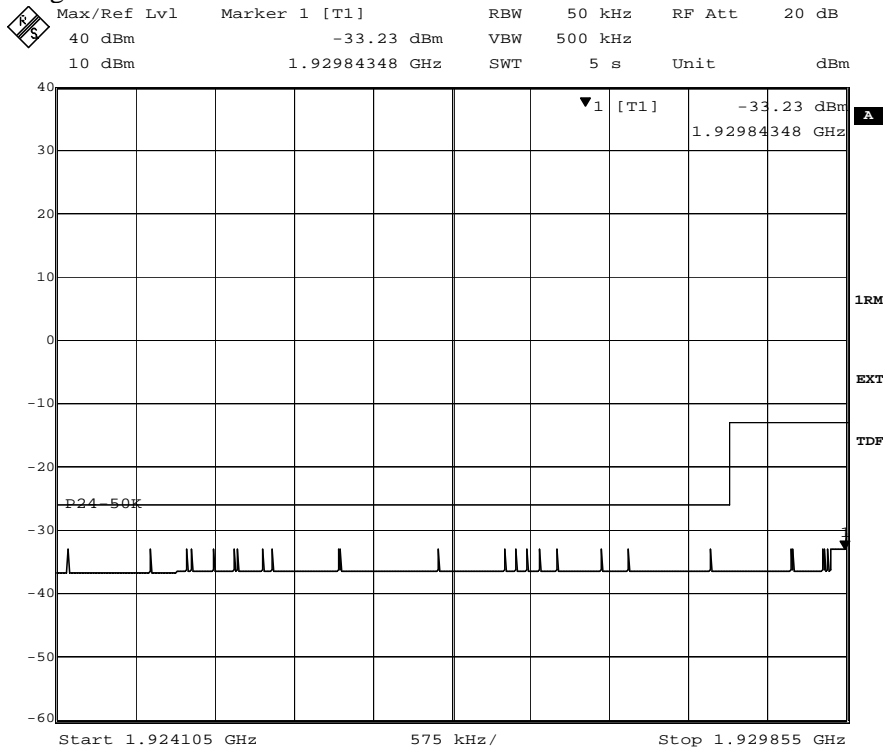

Date: 7.DEC.2011 13:13:23



Appendix 4

Diagram 1 c:

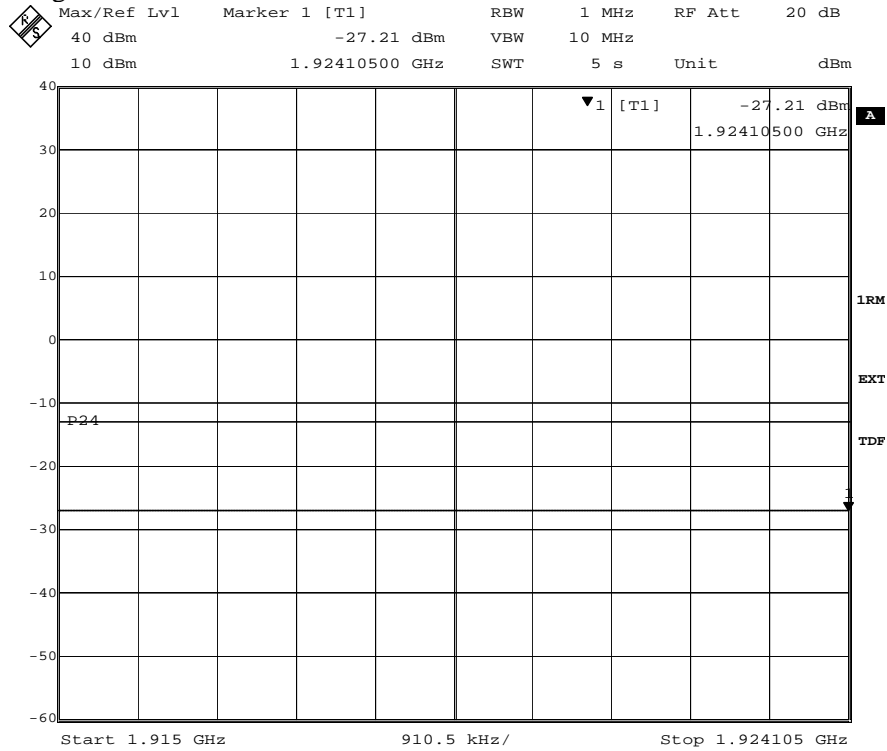

Date: 7.DEC.2011 13:14:08

Appendix 4

Diagram 2 a:

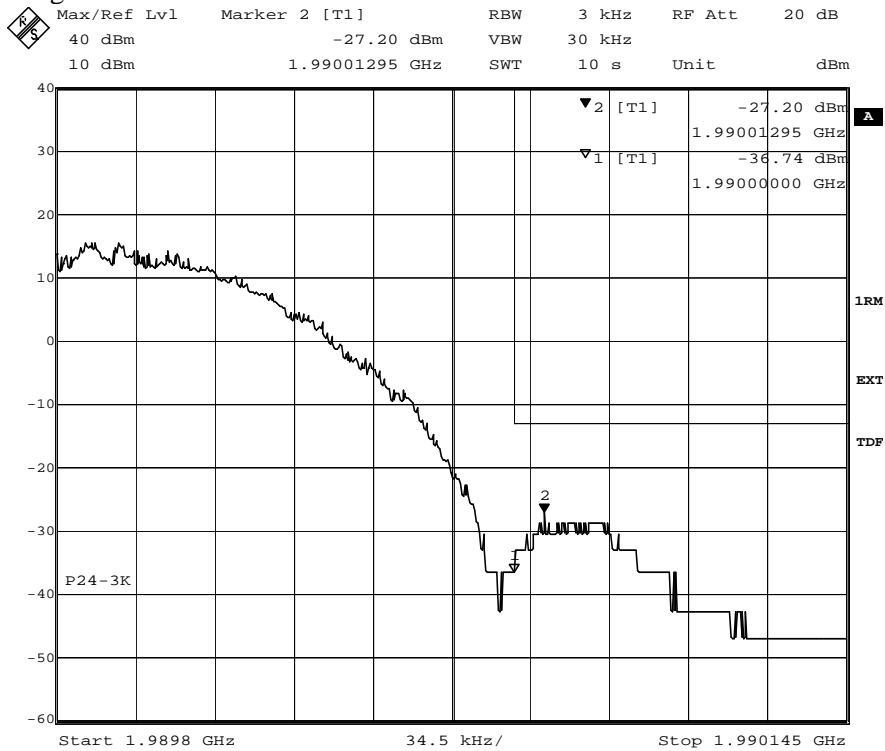

Date: 7.DEC.2011 13:21:46

Diagram 2 b:

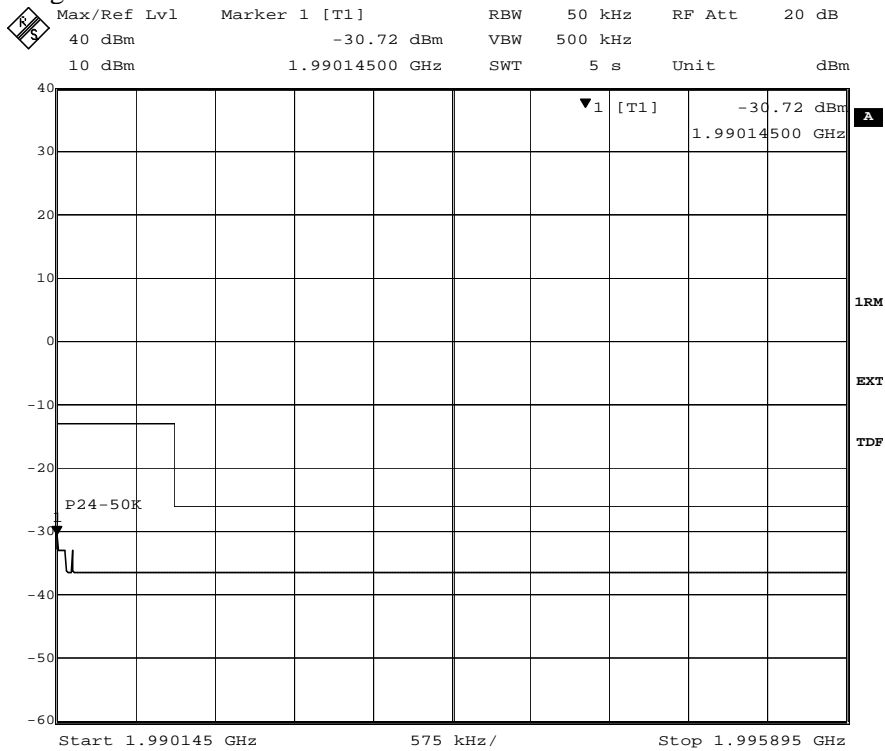

Date: 7.DEC.2011 13:22:37



Appendix 4

Diagram 2 c:

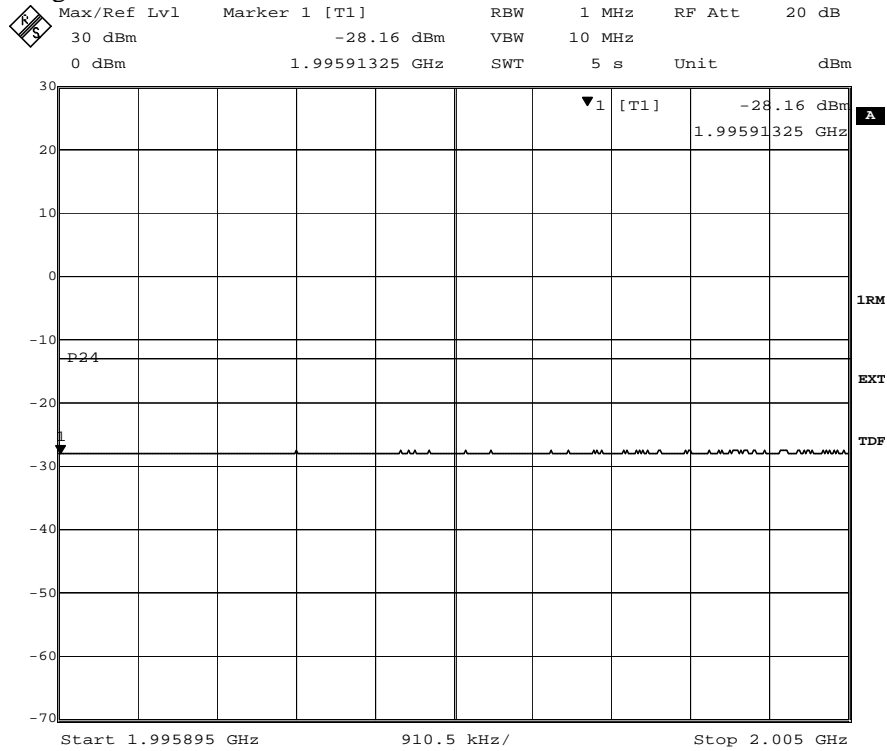

Date: 7.DEC.2011 13:23:19

Appendix 5

Conducted spurious emission measurements according to CFR 47 2.1051

Date	Temperature	Humidity
2011-12-07	22 °C ± 3 °C	64 % ± 5 %

Test set-up and procedure

The measurements were made per definition in §24.238. The measurements were made at EUT port TX/(RX) 1. The output was connected to a spectrum analyser. A pre-measurement was performed with the PEAK detector activated. Emission close to or above the limit with the PEAK detector is measured with the RMS detector activated. The spectrum analyser was connected to an external 10 MHz reference standard during the measurements.

Measurement equipment	SP number
Rohde & Schwarz FSIQ40	503 738
Attenuator	504 159
High pass filter	504 200
Multimeter Fluke 87	502 190
Testo 615 temperature and humidity meter	503 498

Measurement uncertainty: 3.7 dB

Results

Configuration: RBS master 2E setting 33 for maximum nominal output power.
The TX was activated on channel M.

Diagram	Modulation	Frequency range measured
1 a:	GMSK	9 kHz – 3 GHz
1 b:	GMSK	3 GHz – 20 GHz
2 a:	AQPSK	9 kHz – 3 GHz
2 b:	AQPSK	3 GHz – 20 GHz

The diagrams are shown on the following pages.

Remark

The emission at 9 kHz on some plots was not generated by the test object. A complementary measurement with a smaller RBW showed that it was related to the LO feed-through.

Limits

The power of any emission outside the frequency band shall be attenuated below the transmitter power (P) by at least 43 + 10 log P dB.

Complies?	Yes
-----------	-----

Appendix 6

Field strength of spurious radiation measurements according to 47CFR 2.1053

Date	Temperature	Humidity
2011-06-07	21 °C ± 3 °C	70 % ± 5 %

Test set-up and procedure

The measurements were performed with both horizontal and vertical polarization of the antenna. The antenna distance was 3 m in the frequency range 30 MHz – 18 GHz and 1m in the frequency range 18-20 GHz.

The measurements were performed in Effective Radiated Power (ERP). A fully anechoic chamber was used during the measurements. The chamber is regularly calibrated with the substitution method and from that calibration an ERP correction factor is derived. The correction factor was used as a transducer to get the readings in ERP.

The measurement procedure was as the following:

1. A pre-measurement was first performed with peak detector. The EUT was continuously measured in 360 degrees.
2. Spurious radiation on frequencies closer than 6 dB to the limit was re-measured with RMS detector and with the substitution method according to the standard.

Measurement equipment	SP number
Anechoic chamber, Hertz	15:116
Rohde & Schwarz FSIQ40 Signal Analyser	503 738
Rohde & Schwarz EMI Test Receiver ESI40	503 125
Chase bilog antenna CBL 6121A	502 460
Schaffner Reference Dipole BSRD6500	503 649
EMCO Horn Antenna 3115	502 175
EMCO Horn Antenna 3115	501 548
Flann Std gain horn 20240-20	503 674
MITEQ Low Noise Amplifier	503 277
Rohde & Schwarz Vector Network Analyser	503 687
Highpass filter	503 739
Testo 615 temperature and humidity meter	503 498

Appendix 6

The test set-up is shown in the picture below:

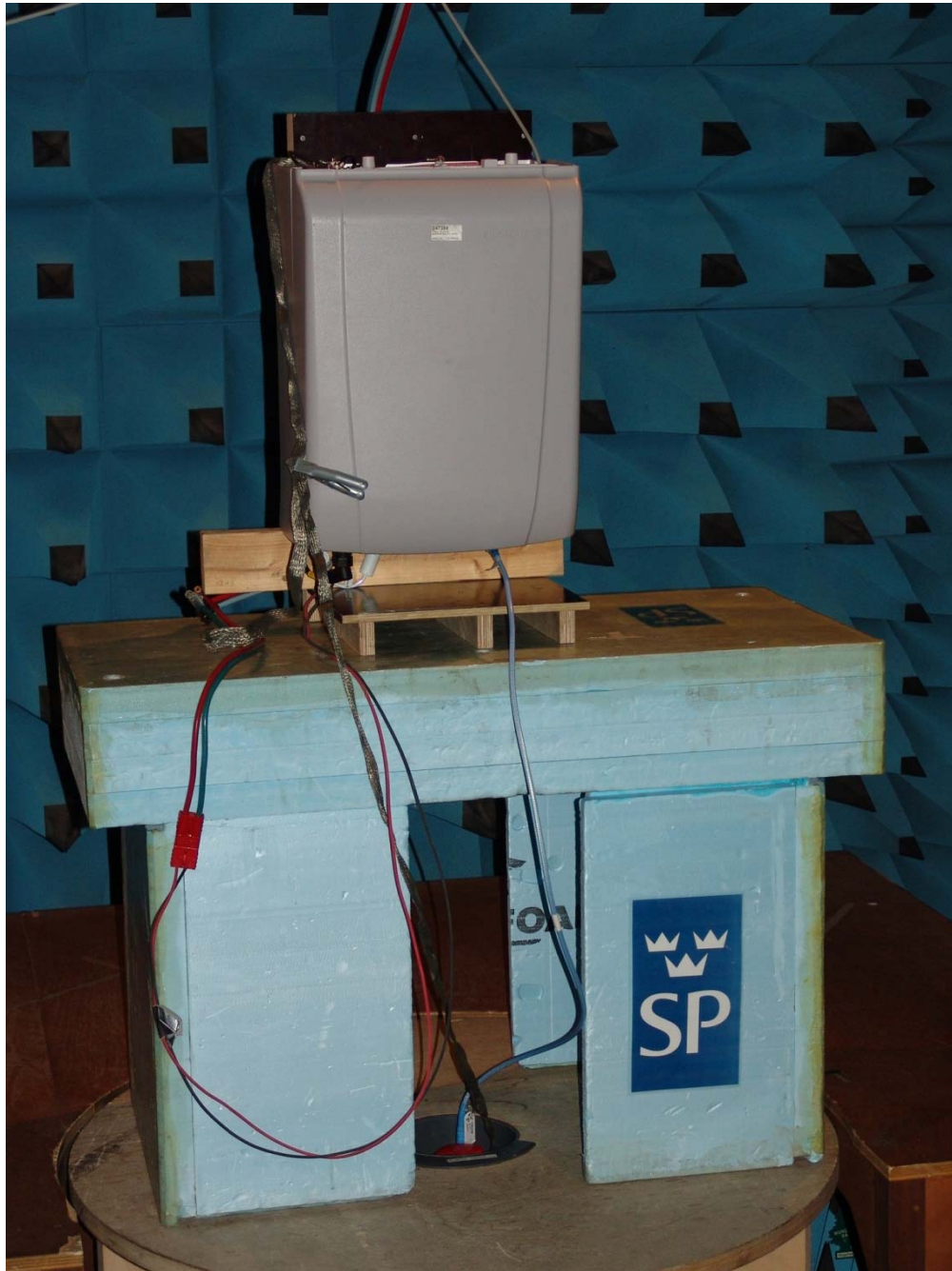

Note: The picture shows the EUT integrated into a complete RBS 2308.

Appendix 6

Results

Modulation GMSK

Frequency (MHz)	Spurious emission level (dBm)	
	Vertical	Horizontal
30-20 000	All emission > 20 dB below limit	All emission > 20 dB below limit

Modulation AQPSK in SCPIR 0 dB

Frequency (MHz)	Spurious emission level (dBm)	
	Vertical	Horizontal
30-20 000	All emission > 20 dB below limit	All emission > 20 dB below limit

Measurement uncertainty: 3.1

Limits

The power of any emission outside the frequency band shall be attenuated below the transmitter power (P) by at least $43 + 10 \log P$ dB.

Complies?	Yes
-----------	-----

Appendix 7

Photos of the test object

Front side



Back side

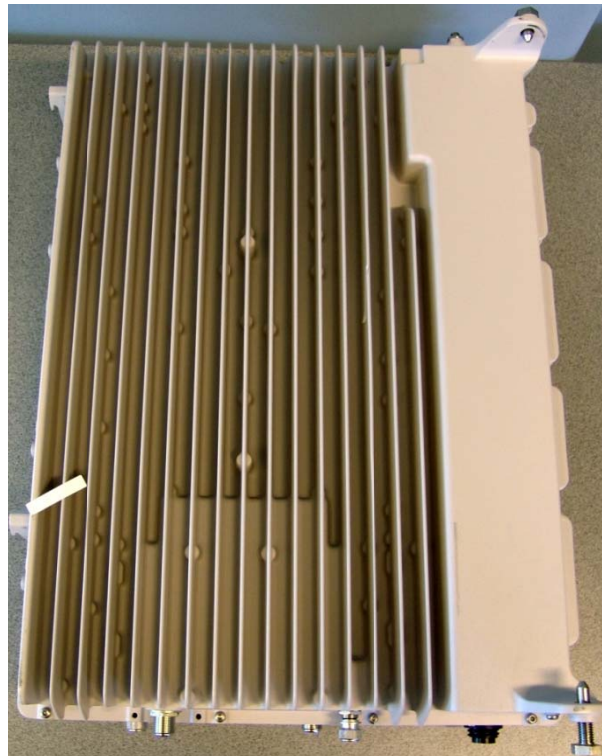

Appendix 7

Left side



Right side



Appendix 7

Top side

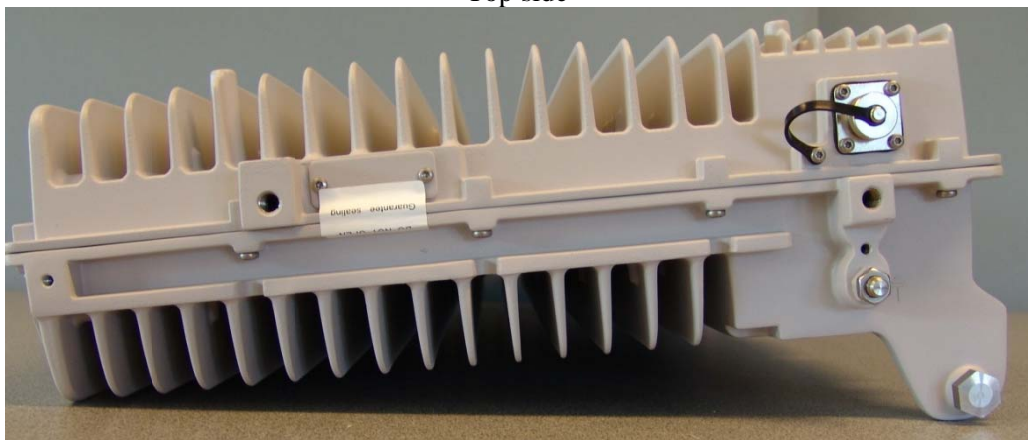

Bottom side

