

FCC ISED Test Report Part 74 & RSS-210

Report No.: FCC_IC_RF_SL19101602-BSS-009_TR-82N Rev_2.0

Product: Dual Receiver Narrowband UHF Wireless Intercom Beltpack

Models: TR-82N-FD, TR-82N-FE, TR-82N-HE

FCC ID: B5DM539

IC: 1321A-TR82NDE

Received Date: 12/09/2019

Test Date: 01/02/2020-01/19/2020

Issued Date: 04/06/2020

Applicant: Bosch Security Systems, Inc.

Applicant Address: 8601 East Cornhusker Hwy. Lincoln, NE 68507 USA

Manufacturer: Bosch Security Systems, Inc.

Manufacturer Address: 130 Perinton Parkway, Fairport, NY 14450 USA.

Issued By: Bureau Veritas Consumer Products Services, Inc.

Lab Address: 775 Montague Expressway, Milpitas, CA 95035

**FCC Registration /
Designation Number:** 540430

ISED# / CAB identifier: 4842D



This report is for your exclusive use. Any copying or replication of this report to or for any other person or entity, or use of our name or trademark, is permitted only with our prior written permission. This report sets forth our findings solely with respect to the test samples identified herein. The results set forth in this report are not indicative or representative of the quality or characteristics of the lot from which a test sample was taken or any similar or identical product unless specifically and expressly noted. Our report includes all of the tests requested by you and the results thereof based upon the information that you provided to us. You have 60 days from date of issuance of this report to notify us of any material error or omission caused by our negligence, provided, however, that such notice shall be in writing and shall specifically address the issue you wish to raise. A failure to raise such issue within the prescribed time shall constitute your unqualified acceptance of the completeness of this report, the tests conducted and the correctness of the report contents. Unless specific mention, the uncertainty of measurement has been explicitly taken into account to declare the compliance or non-compliance to the specification. The report must not be used by the client to claim product certification, approval, or endorsement by A2LA or any government agencies.

TABLE OF CONTENTS

RELEASE CONTROL RECORD	4
1 CERTIFICATE OF CONFORMITY	5
2 SUMMARY OF TEST RESULTS.....	6
2.1 MEASUREMENT UNCERTAINTY	7
3 GENERAL INFORMATION	8
3.1 GENERAL DESCRIPTION OF EUT	8
3.2 DESCRIPTION OF TEST MODES	9
3.2.1 GENERAL DESCRIPTION OF APPLIED STANDARDS	10
3.3 DESCRIPTION OF SUPPORT UNITS	10
3.3.1 CONFIGURATION OF SYSTEM UNDER TEST	11
4 TEST TYPES AND RESULTS.....	12
4.1 OUTPUT POWER MEASUREMENT.....	12
4.1.1 LIMITS OF OUTPUT POWER MEASUREMENT	12
4.1.2 TEST INSTRUMENTS.....	12
4.1.3 TEST PROCEDURES	12
4.1.4 TEST SETUP.....	13
4.1.5 EUT OPERATING CONDITIONS	13
4.1.6 TEST RESULTS	14
4.2 FREQUENCY STABILITY MEASUREMENT.....	15
4.2.1 LIMITS OF FREQUENCY STABILITY MEASUREMENT	15
4.2.2 TEST INSTRUMENTS.....	15
4.2.3 TEST PROCEDURE.....	16
4.2.4 TEST SETUP.....	16
4.2.5 TEST RESULTS	17
4.3 MODULATION DEVIATION MEASUREMENT	19
4.3.1 LIMITS OF MODULATION DEVIATION MEASUREMENT	19
4.3.2 TEST INSTRUMENTS.....	19
4.3.3 TEST PROCEDURE.....	20
4.3.4 TEST SETUP	21
4.3.5 TEST RESULTS	22
4.4 OCCUPIED BANDWIDTH AND EMISSION MASK MEASUREMENT	26
4.4.1 LIMITS OF OCCUPIED BANDWIDTH AND EMISSION MASK MEASUREMENT ...	26
4.4.2 TEST INSTRUMENTS.....	26
4.4.3 TEST SETUP.....	27
4.4.4 TEST PROCEDURES	28
4.4.5 TEST RESULTS	29
4.5 CONDUCTED SPURIOUS EMISSIONS	33
4.5.1 LIMITS OF CONDUCTED SPURIOUS EMISSIONS MEASUREMENT.....	33
4.5.2 TEST INSTRUMENTS.....	33
4.5.3 TEST PROCEDURE.....	34
4.5.4 TEST SETUP.....	34
4.5.5 EUT OPERATING CONDITIONS	34
4.5.6 TEST RESULTS	35

4.6	RADIATED EMISSION MEASUREMENT	37
4.6.1	LIMITS OF RADIATED EMISSION MEASUREMENT	37
4.6.2	TEST INSTRUMENTS.....	38
4.6.3	TEST PROCEDURES	39
4.6.4	DEVIATION FROM TEST STANDARD.....	39
4.6.5	TEST SETUP.....	40
4.6.6	EUT OPERATING CONDITIONS	40
4.6.7	TEST RESULTS	41
5	PHOTOGRAPHS OF THE TEST CONFIGURATION	45
6	INFORMATION OF THE TESTING LABORATORIES	46

Release Control Record

Issue No.	Reason for change	Date issued
FCC_IC_RF_SL19101602-BSS-009_TR-82N	Original release	02/11/2020
FCC_IC_RF_SL19101602-BSS-009_TR-82N Rev_1.0	Update Applicant & Manufacturer Address Per Customer Review	02/25/2020
FCC_IC_RF_SL19101602-BSS-009_TR-82N Rev_2.0	Redefine the highest frequency to meet IC requirements	04/06/2020

1 Certificate of Conformity

Product: Dual Receiver Narrowband UHF Wireless Intercom Beltpack
Brand: RTS
Test Model: TR-82N-FD, TR-82N-FE, TR-82N-HE
Sample Status: Engineering sample
Applicant: Bosch Security Systems, Inc.
Test standards: FCC 47 CFR Part 74
RSS-210 Issue 10 December 2019

The above equipment has been tested by **Bureau Veritas Consumer Products Services, Inc., Milpitas Branch**, and found compliance with the requirement of the above standards. The test record, data evaluation & equipment under test (EUT) configurations represented herein are true and accurate accounts of the measurements of the sample's EMC characteristics under the conditions specified in this report.

Prepared by :  , **Date:** 04/06/2020
Deon Dai / Test Engineer

Approved by :  , **Date:** 04/06/2020
Chen Ge / Engineer Reviewer

2 Summary of test results

The EUT has been tested according to the following specifications:

Applied standard: FCC Part74 & Part 2 RSS-210 Annex G			
Standard section	Test type and limit	Result	Remark
2.1046 74.861 RSS-210 G.1	RF Power Output	Pass	Meet the requirement of limit.
2.1055 74.861 RSS-210 G.3	Frequency Stability	Pass	Meet the requirement of limit.
2.1047 74.861 RSS-210 G.5	Modulation Deviation	Pass	Meet the requirement of limit.
2.1047 RSS-210 G.5	Audio Frequency Response	Pass	Meet the requirement of limit.
2.1049 74.861 RSS-210 G.2	Occupied Bandwidth	Pass	Meet the requirement of limit.
2.1051 74.861 RSS-210 G.4	Conducted Spurious Emissions	Pass	Meet the requirement of limit.
2.1051 74.861 RSS-210 G.4	Radiated Spurious Emissions	Pass	Meet the requirement of limit.

2.1 Measurement uncertainty

Where relevant, the following measurement uncertainty levels have been estimated for tests performed on the EUT:

This uncertainty represents an expanded uncertainty expressed at approximately the 95% confidence level using a coverage factor of $k=2$.

Measurement	Frequency	Expanded Uncertainty ($k=2$) (\pm)
Conducted Emissions at mains ports	150kHz ~ 30MHz	3.51dB
Radiated Emissions up to 1 GHz	30MHz ~ 1GHz	3.73dB
Radiated Emissions above 1 GHz	1GHz ~ 6GHz	4.64dB
	6GHz ~ 18GHz	4.82dB
	18GHz ~ 40GHz	4.91dB

3 General Information

3.1 General description of EUT

Product	Dual Receiver Narrowband UHF Wireless Intercom Beltpack
Brand	RTS
Test Model	TR-82N-FD, TR-82N-FE, TR-82N-HE
FCC ID	B5DM539
IC	1321A-TR82NDE
Power Supply	9.0 Vdc
Modulation	FM
Operating Frequency	TR-82N Band FD: TX:572-590MHz RX:482-500MHz TR-82N Band HE: TX:590-607.975MHz RX:500-518MHz
Channel Bandwidth	100kHz
Max. Conducted power	TR-82N Band F: 19.78 dBm TR-82N Band H: 20.04 dBm
Antenna type	¼- wave antenna
Antenna gain	0dBi
Associated Devices	N/A

Note:

1. The above EUT information was declared by the manufacturer and for more detailed features description, please refer to the manufacturer's specifications or user's manual.

3.2 Description of test modes

The following channels have been tested and presented.

TR-82N FD Band		TR-82N HE Band	
Channel	Frequency (MHz)	Channel	Frequency (MHz)
Low	572	Low	590
Middle	581	Middle	599
High	590	High	607.975

3.2.1 General Description of Applied Standards

The EUT has RF transmitter and receiver. According to the specifications of the manufacturer, it must comply with the requirements of the following standards:

FCC 47 CFR part 2

FCC 47 CFR part 74

RSS-210 Issue 10 December 2019

ANIS/TIA/EIA-603-e 2016

ANSI 63.26-2015

All test items have been performed and recorded as per the above standards.

3.3 Description of support units

The EUT has been tested as an independent unit together with other necessary accessories or support units. The following support units or accessories were used to form a representative test configuration during the tests.

No.	Product	Brand	Model no.	Serial no.	FCC ID
1					
2					
3					
4					
5					
6					

No.	Signal cable description of the above support units
1	
2	
3	
4	
5	
6	

Note: all power cords of the above support units are Non-shielded (1.8m).

3.3.1 Configuration of system under test

Work with battery

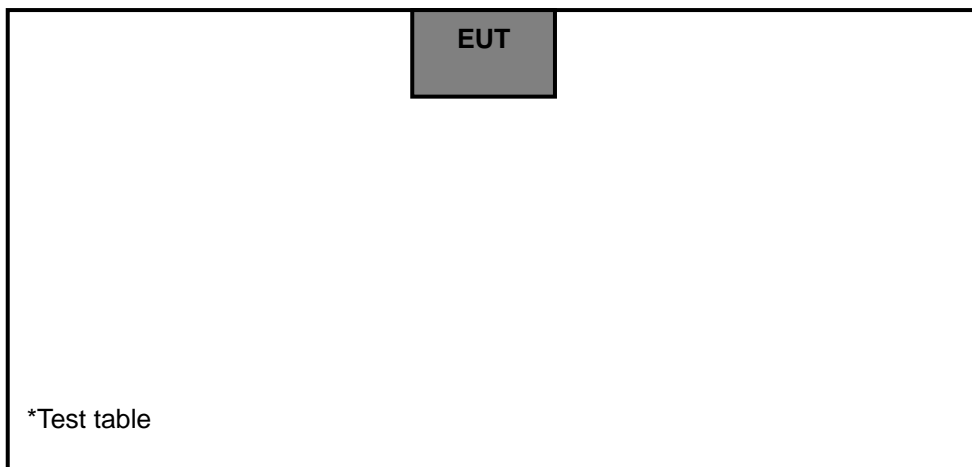

4 Test types and results

4.1 Output Power Measurement

4.1.1 Limits of output power measurement

LPAS operation in TV bands	
Frequency Band	Conducted Output Power
54 – 72MHz 76 – 88MHz 174 – 216MHz	50mW (17dBm) EIRP
470 – 608 614 - 698	250mW (24dBm)

LPAS operation in other than TV bands	
Conducted Power (W)	1

4.1.2 Test instruments

For conducted power:

Description & manufacturer	Model no.	Serial no.	Calibrated date	Calibrated until
USB Power Sensor	7002-006	159814	03/18/2019	03/18/2020*
30dB Attenuation	VAT-30W2	N/A	N/A	N/A

* 3 month extension from calibration date.

4.1.3 Test procedures

The transmitter output was connected to power meter through an attenuator. The test result was measured and recorded.

4.1.4 Test setup

Conducted power measurement:

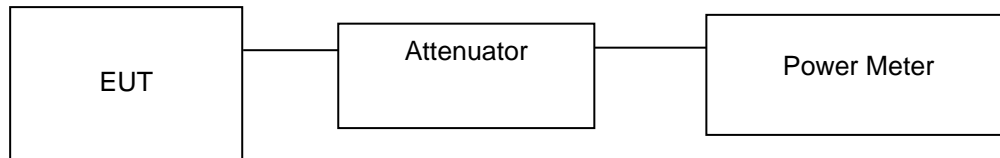

4.1.5 EUT operating conditions

- a. Placed the EUT on the testing table.
- b. Turn on the EUT power by battery.
- c. Enable EUT under transmission condition continuously at specific channel frequency.

4.1.6 Test results

Band	Frequency (MHz)	Output Power (dBm)	Output Power (mW)	Limit (mW)
TR-82N FD	572	19.78	95.06	250
	581	19.38	86.70	250
	590	19.54	89.95	250
TR-82N HE	590	19.87	97.05	250
	599	20.04	100.93	250
	607.975	19.43	89.74	250

4.2 Frequency stability measurement

4.2.1 Limits of frequency stability measurement

Frequency stability	Limit
Refer as FCC 74.861 (e)(4) RSS-210 G.3	0.005%

According to the FCC part 2.1055 shall be tested the frequency stability. The test extreme voltage is according to the 2.1055(d)(1) vary primary supply voltage from 85 to 115 percent of the nominal value for other than hand carried battery equipment and the extreme temperature rule is comply with specification of EUT -30°C ~ 50°C.

4.2.2 Test instruments

Description & manufacturer	Model no.	Serial no.	Calibrated date	Calibrated until
50GHz Spectrum Analyzer	N9030B (PXA)	MY57140597	06/05/2019	06/05/2020
Temperature/Humidity Chamber	1007H	61201	12/16/2019	12/16/2020

4.2.3 Test procedure

- a. Turn on EUT and set spectrum analyzer center frequency to the EUT operating frequency. Set spectrum analyzer Resolution Bandwidth to 1 kHz and Video Resolution Bandwidth to 1 kHz AND Frequency Span to 50 kHz, Record this frequency as reference frequency.
- b. Set the temperature of chamber to 50°C. Allow sufficient time (approximately 30 min) for the temperature of the chamber to stabilize. While maintaining a constant temperature inside the chamber. Turn the EUT on and measure the EUT operating frequency.
- c. Repeat set 2 with a 10°C decreased per stage until the lowest temperature -30°C is measured. Record all measured frequencies on each temperature step.
- d. Vary primary supply voltage from 85 to 115 percent of the nominal value for other than hand carried battery equipment.

4.2.4 Test setup

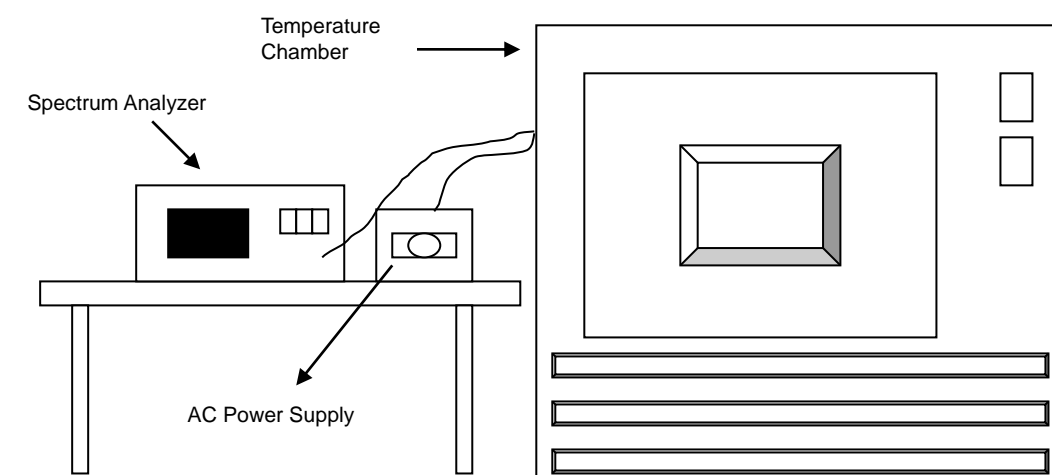

4.2.5 Test results

TR-82N FD:

Mode	Middle channel 581(MHz)	Input power	9.0 Vdc
Environmental conditions	20°C, 60%rh	Tested by	Deon Dai

Frequency error vs. Voltage								
Voltage (volts)	0minutes		2minutes		5minutes		10minutes	
	Frequency (MHz)	(%)	Frequency (MHz)	(%)	Frequency (MHz)	(%)	Frequency (MHz)	(%)
10.35	580.9989	-0.00019	580.9984	-0.00028	581.0012	0.00021	580.9982	-0.00031
9.0	580.9987	-0.00022	580.9983	-0.00029	580.9983	-0.00029	581.0003	0.00005
7.65	581.0015	0.00026	581.0002	0.00003	580.9982	-0.00031	580.9992	-0.00014

Frequency error vs. Temp								
Temp (°C)	0minutes		2minutes		5minutes		10minutes	
	Frequency (MHz)	(%)	Frequency (MHz)	(%)	Frequency (MHz)	(%)	Frequency (MHz)	(%)
50	581.0003	0.00005	581.0008	0.00014	581.0013	0.00022	581.0003	0.00005
40	581.0011	0.00019	581.0004	0.00007	581.0004	0.00007	581.0004	0.00007
30	580.9989	-0.00019	580.9985	-0.00026	580.9986	-0.00024	580.9986	-0.00024
20	581.0009	0.00015	581.0009	0.00015	581.0005	0.00009	581.0004	0.00007
10	580.9983	-0.00029	580.9987	-0.00022	580.9985	-0.00026	580.9983	-0.00029
0	581.0013	0.00022	581	0.00000	581.0007	0.00012	581.0007	0.00012
-10	580.9989	-0.00019	580.9982	-0.00031	580.9989	-0.00019	580.9982	-0.00031
-20	581.0007	0.00012	581.0003	0.00005	580.9983	-0.00029	580.9999	-0.00002
-30	580.9984	-0.00028	580.9992	-0.00014	580.9991	-0.00015	580.9996	-0.00007

TR-82N HE:

Mode	Middle channel 599(MHz)	Input power	9.0 Vdc
Environmental conditions	20°C, 60%rh	Tested by	Deon Dai

Frequency error vs. Voltage								
Voltage (volts)	0minutes		2minutes		5minutes		10minutes	
	Frequency (MHz)	(%)	Frequency (MHz)	(%)	Frequency (MHz)	(%)	Frequency (MHz)	(%)
10.35	599.001	0.00017	599.0012	0.00020	599.0009	0.00015	599.0001	0.00002
9.0	598.9992	-0.00013	599.0009	0.00015	599.0008	0.00013	599.0003	0.00005
7.65	598.9989	-0.00018	598.9983	-0.00028	598.9986	-0.00023	598.9996	-0.00007

Frequency error vs. Temp								
Temp (°C)	0minutes		2minutes		5minutes		10minutes	
	Frequency (MHz)	(%)	Frequency (MHz)	(%)	Frequency (MHz)	(%)	Frequency (MHz)	(%)
50	599.0012	0.00020	599.0008	0.00013	599.0005	0.00008	599.0003	0.00005
40	599.0006	0.00010	599.0012	0.00020	599.0003	0.00005	599.0006	0.00010
30	598.9993	-0.00012	598.9982	-0.00030	598.9988	-0.00020	598.9992	-0.00013
20	599.0009	0.00015	599.0005	0.00008	599.0003	0.00005	599.0003	0.00005
10	599.0012	0.00020	599.0013	0.00022	598.9981	-0.00032	599.0007	0.00012
0	598.9983	-0.00028	599.0008	0.00013	599.0003	0.00005	599.0004	0.00007
-10	598.9984	-0.00027	598.9987	-0.00022	598.9986	-0.00023	598.9996	-0.00007
-20	599.0009	0.00015	599.0007	0.00012	599.0002	0.00003	598.9989	-0.00018
-30	599.0004	0.00007	599.0013	0.00022	599.0011	0.00018	598.9995	-0.00008

4.3 Modulation Deviation measurement

4.3.1 Limits of modulation Deviation measurement

Modulation Deviation	Limit
Refer as FCC 74.861 (e) (3) RSS-210 G.5	±75 kHz

4.3.2 Test instruments

Description & manufacturer	Model no.	Serial no.	Calibrated date	Calibrated until
Modulation Analyzer	8901B	3226A04414	04/23/2019	04/23/2020
Function/Arbitrary Waveform Generator	33220A	MY44016131	03/11/2019*	03/11/2020*
50GHz Spectrum Analyzer	N9030B (PXA)	MY57140597	06/05/2019	06/05/2020

* 3 month extension from calibration date.

4.3.3 Test procedure

Audio frequency response

- a) Connect the equipment as illustrated.
- b) Set the test receiver to measure peak position deviation. Set the audio bandwidth for ≤ 50 Hz to ≥ 15000 Hz. Turn the de-emphasis function off.
- c) Adjust the transmitter per the manufacturer's procedure for full rated system deviation.
- d) Apply a 1000 Hz tone and adjust the audio frequency generator to produce 20% of the rated system deviation.
- e) Set the test receiver to measure rms deviation and record the deviation reading as DEV_{REF} .
- f) Set the audio frequency generator to the desired test frequency between 300 Hz and 3000 Hz.
- g) Record the test receiver deviation reading as DEV_{FREQ} .
- h) Calculate the audio frequency response at the present frequency as follows:

$$\text{audio frequency response} = 20\log_{10}\left(\frac{DEV_{FREQ}}{DEV_{REF}}\right)$$

- i) Repeat step f) through step h) for all the desired test frequencies.

Modulation limiting

- a) Connect the equipment as illustrated.
- b) Adjust the transmitter per the manufacturer's procedure for full rated system deviation.
- c) Set the test receiver to measure peak positive deviation. Set the audio bandwidth for ≤ 0.25 Hz to 15000 Hz. Turn the de-emphasis function off.
- d) Apply a 1000 Hz modulating signal to the transmitter from the audio frequency generator, and adjust the level to obtain 60% of full rated system deviation. This is the 0 dB reference level.
- e) Increase the level from the audio generator by 20 dB in 5 dB increments recording the deviation as measured from the test receiver in each step. Verify that the audio level used to make the OBW measurement is included in the sweep.
- f) Repeat for step e) at 300 Hz, 2500 Hz and 3000 Hz at a minimum using the 0 dB reference level obtained in step d).
- g) Set the test receiver to measure peak negative deviation and repeat step d) through step f).
- h) The values recorded in step f) and step g) are the modulation limiting.

4.3.4 Test setup

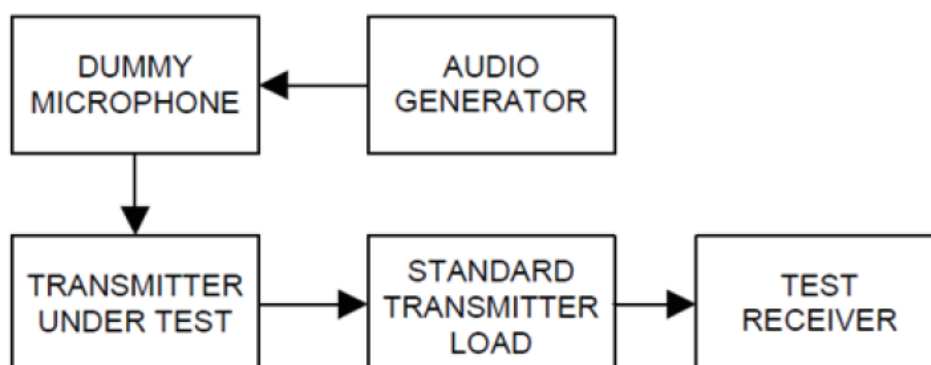

4.3.5 Test results

Modulation Limit

TR-82N FD

Carrier Frequency: 581 MHz

Modulation Level (dB)	Peak freq. Deviation (kHz)				Limit (kHz)
	300Hz	1000Hz	2500Hz	3000Hz	
-20	28.1	32.2	33.3	36.5	± 75
-15	27.9	31.8	32.8	34.7	± 75
-10	29.3	32.3	33.5	36.2	± 75
-5	29.9	35.3	35.7	37.0	± 75
0	33.2	43.5	46.4	51.4	± 75
5	44.5	59.7	59.2	61.4	± 75
10	55.8	61.2	60.3	63.4	± 75
15	62.0	65.0	61.9	65.0	± 75
20	63.8	65.9	65.2	66.8	± 75

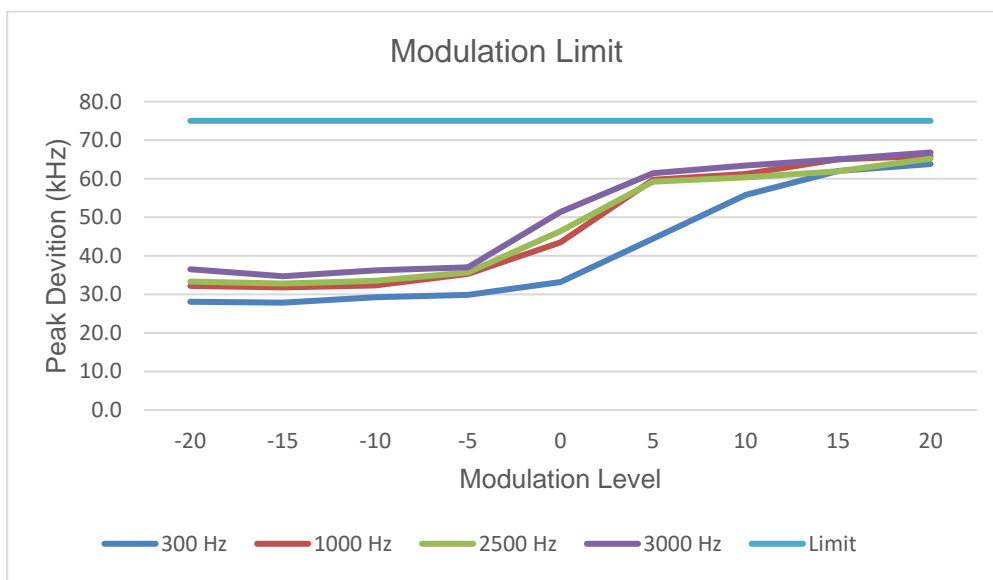

Audio Frequency Response (Middle Channel)

Modulation Frequency (Hz)	Input Level (mw)	Audio Frequency Response (dB)
100	25.02	1.39
300	23.98	1.02
500	22.83	0.59
700	21.57	0.10
1000	21.33	0.00
1500	19.24	-0.90
2000	17.26	-1.84
2500	14.8	-3.17
3500	13.12	-4.22
5000	11.28	-5.53

Note: AF Response = $20 \cdot \log (\text{AF Level} / \text{AF Level of 1 kHz})$

Modulation Limit

TR-82N HE

Carrier Frequency: 599 MHz

Modulation Level (dB)	Peak freq. Deviation (kHz)				Limit (kHz)
	300Hz	1000Hz	2500Hz	3000Hz	
-20	25.0	28.7	31.8	33.8	± 75
-15	26.1	29.4	32.1	34.9	± 75
-10	27.4	30.0	32.4	35.9	± 75
-5	28.0	32.3	33.9	37.2	± 75
0	31.2	40.3	42.6	51.3	± 75
5	43.8	55.7	54.7	60.7	± 75
10	54.4	60.4	57.2	62.7	± 75
15	58.6	62.6	61.6	65.2	± 75
20	60.8	64.3	64.3	66.4	± 75

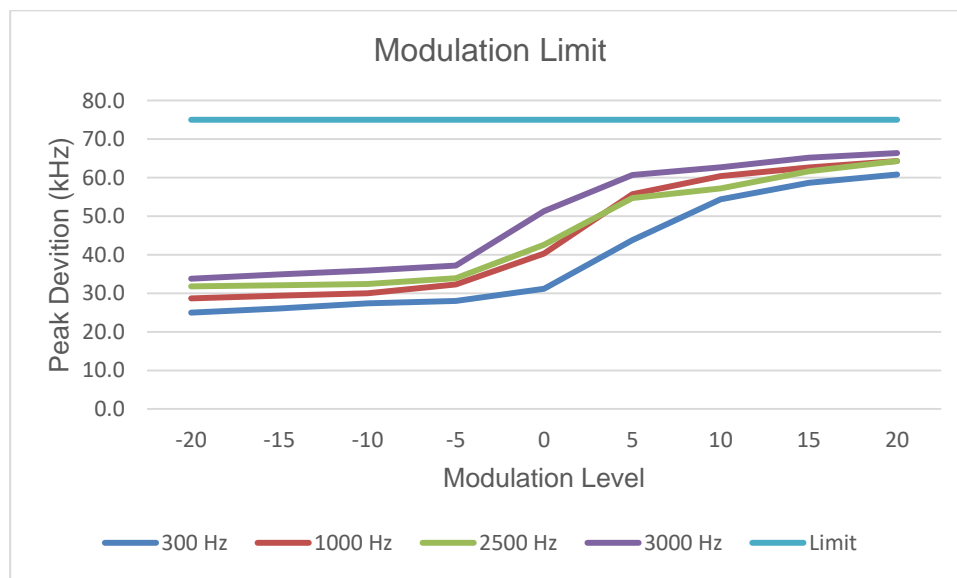

Audio Frequency Response (Middle Channel)

Modulation Frequency (Hz)	Input Level (mw)	Audio Frequency Response (dB)
100	26.02	1.66
300	24.66	1.19
500	23.2	0.66
700	21.98	0.19
1000	21.5	0.00
1500	18.97	-1.09
2000	17.47	-1.80
2500	15.29	-2.96
3500	13.25	-4.20
5000	11.29	-5.59

Note: AF Response = $20 \cdot \log(\text{AF Level} / \text{AF Level of 1 kHz})$

4.4 Occupied bandwidth and emission Mask measurement

4.4.1 Limits of occupied bandwidth and emission Mask measurement

According to FCC 74.861 (e) (3) any form of modulation may be used. A maximum deviation of ± 75 kHz is permitted when frequency modulation is employed.

(5) The operating bandwidth shall not exceed 200 kHz.

(7) Analog emissions within the band from one megahertz below to one megahertz above the carrier frequency shall comply with the emission mask in section 8.3.1.2 of the European Telecommunications Institute Standard ETSI EN 300 422-1 v1.4.2 (2011-08), Electromagnetic compatibility and Radio spectrum Matters (ERM); Wireless microphones in the 25 MHz to 3 GHz frequency range; part 1: Technical characteristics and methods of measurement. Digital emissions within the band from one megahertz below to one megahertz above the carrier frequency shall comply with the emission mask in section 8.3.2.2 (Figure 4) of the European Telecommunications Institute Standard ETSI EN 300 422-1 v1.4.2 (2011-08), Electromagnetic compatibility and Radio spectrum Matters (ERM); Wireless microphones in the 25 MHz to 3 GHz frequency range; part 1: Technical characteristics and methods of measurement. Beyond one megahertz below and above the carrier frequency, emissions shall comply with the limits specified in section 8.4 of ETSI EN 300 422-1 v1.4.2 (2011-08). The requirements of this paragraph (e)(7) shall not apply to applications for certification of equipment in these bands until nine months after release of the Commission's Channel Reassignment Public Notice, as defined in §73.3700(a)(2) of this chapter;

4.4.2 Test instruments

Description & manufacturer	Model no.	Serial no.	Calibrated date	Calibrated until
50GHz Spectrum Analyzer	N9030B (PXA)	MY57140597	06/05/2019	06/05/2020
Function/Arbitrary Waveform Generator	33220A	MY44016131	03/10/2019*	03/10/2020*
30dB Attenuation	VAT-30W2	N/A	N/A	N/A

* 3 month extension from calibration date.

4.4.3 Test setup

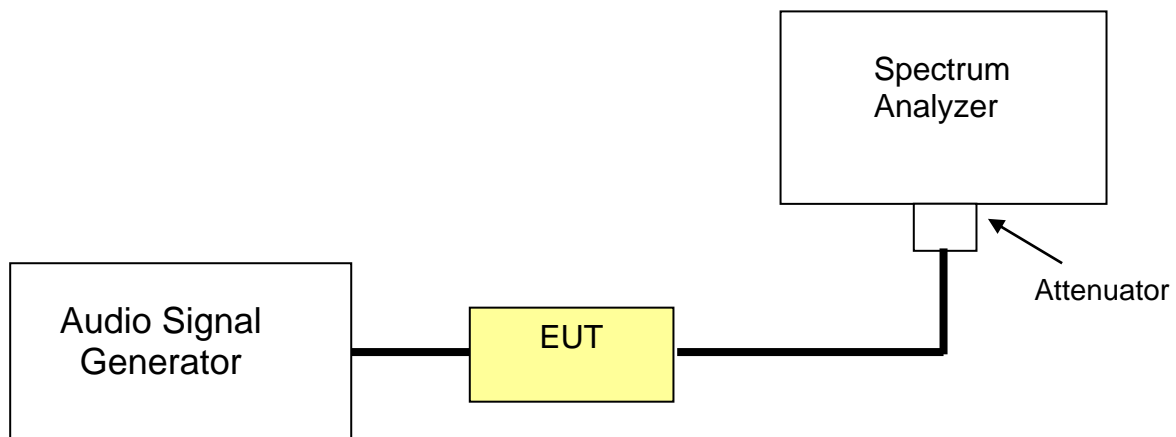

4.4.4 Test procedures

The OBW is according to KDB 971168 D01v03r01

The Emission Mask is according to section 8.3 of ETSI EN 300 422-1 V1.4.2 (2011-08).

4.4.5 Test results

Band	Frequency (MHz)	99% Bandwidth (kHz)	Limit (kHz)	Result
TR-82N FD	572	11.39	200	Pass
	581	10.98	200	Pass
	590	10.86	200	Pass
TR-82N HE	590	11.52	200	Pass
	599	11.29	200	Pass
	607.975	11.17	200	Pass

Bandwidth Test Plots

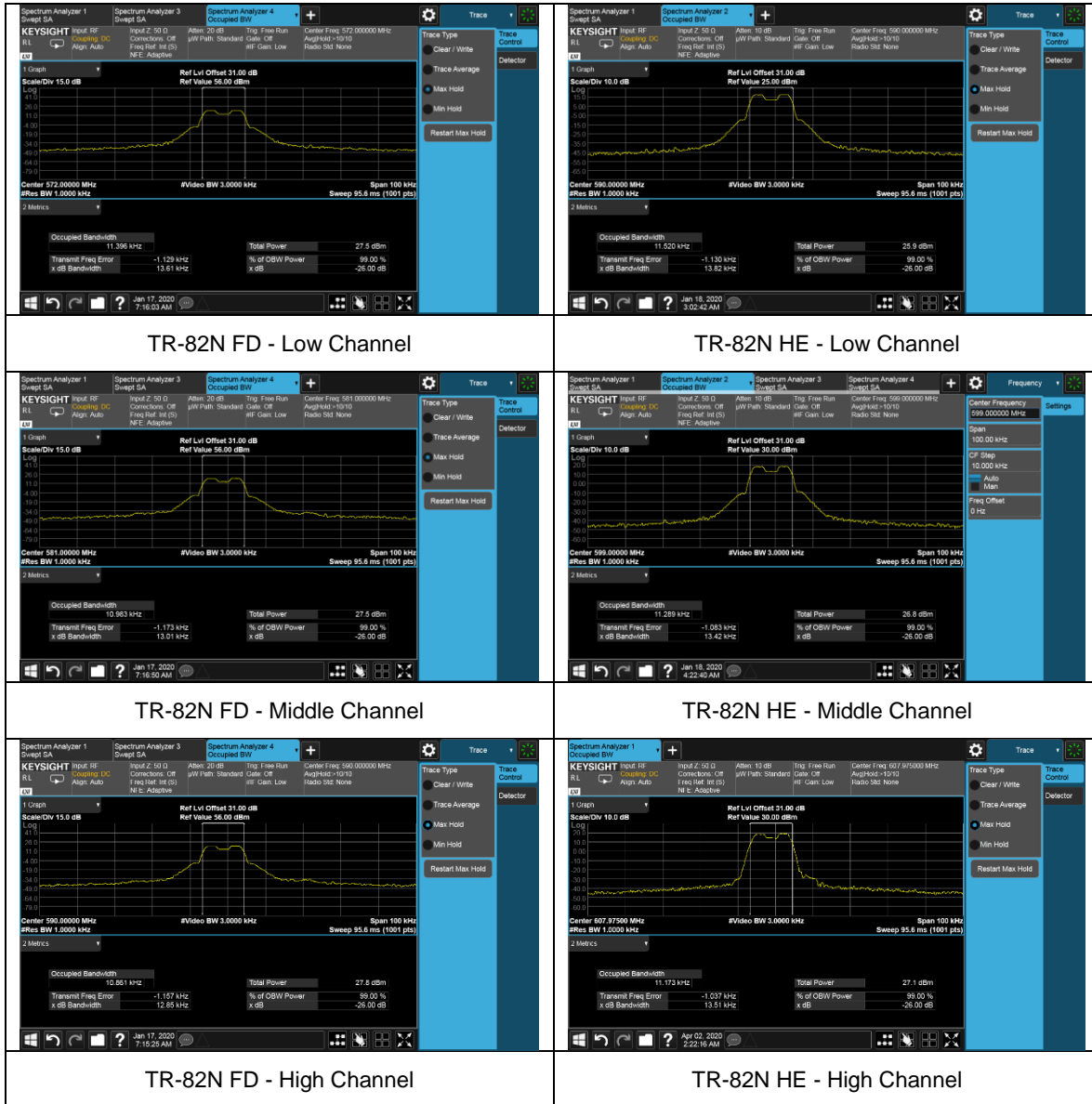

Emission Mask Test Plots

TR-82N FD:

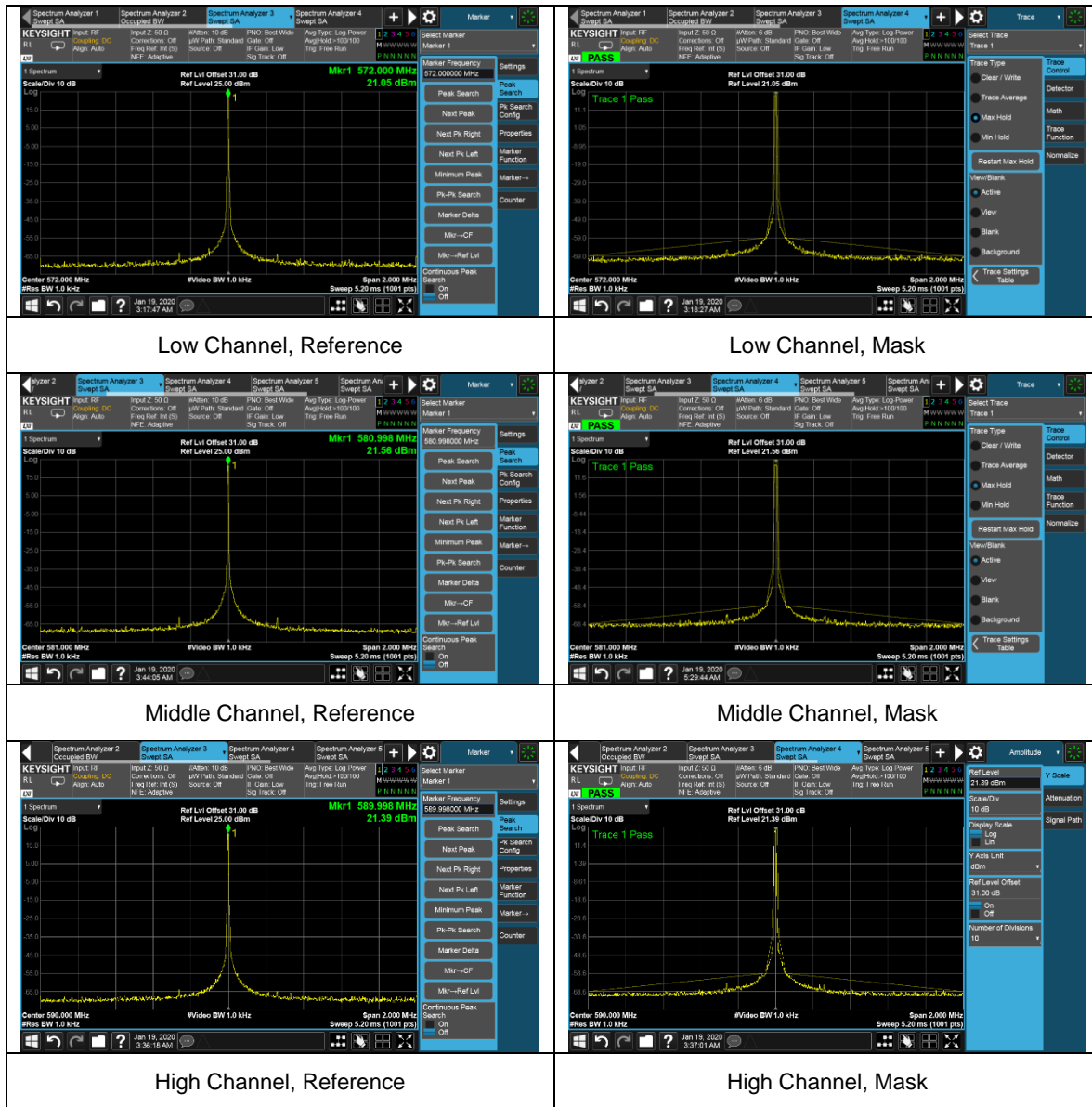

TR-82N HE:

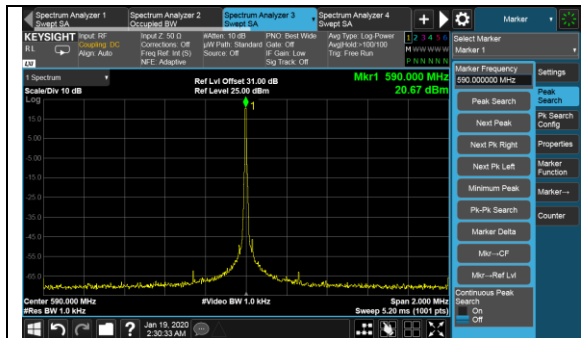

Low Channel, Reference

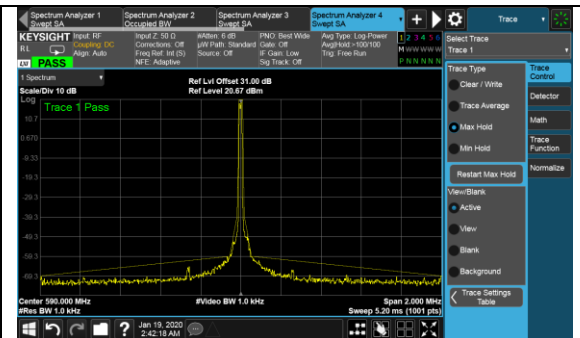

Low Channel, Mask

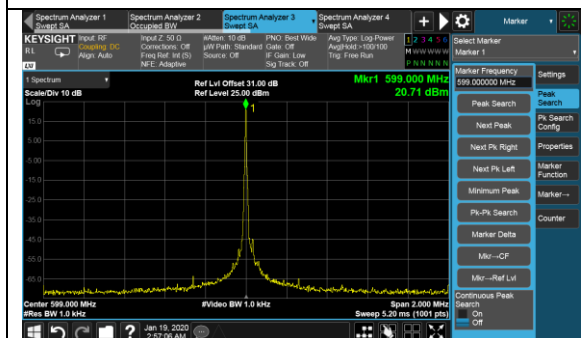

Middle Channel, Reference

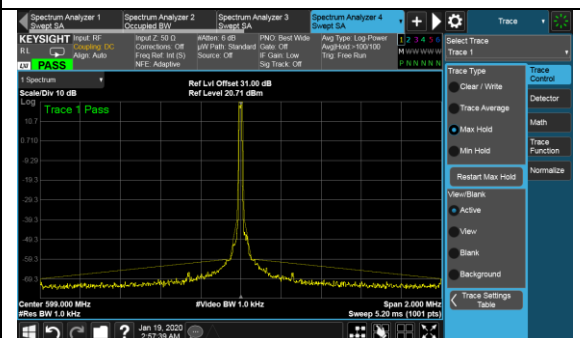

Middle Channel, Mask

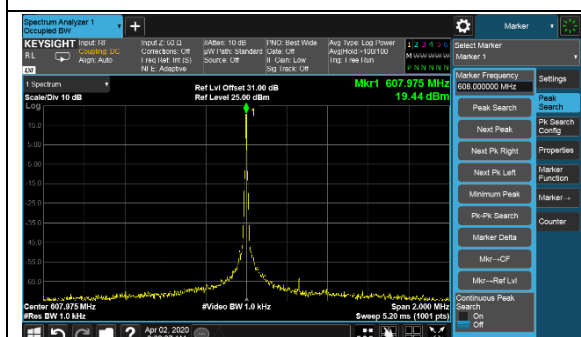

High Channel, Reference

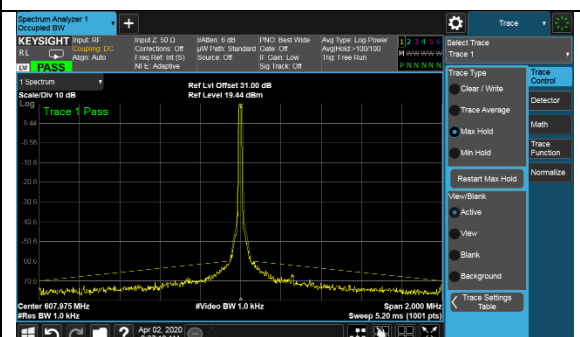

High Channel, Mask

4.5 Conducted spurious emissions

4.5.1 Limits of conducted spurious emissions measurement

According to FCC 74.861 (e) (7) Analog emissions within the band from one megahertz below to one megahertz above the carrier frequency shall comply with the emission mask in section 8.3.1.2 of the European Telecommunications Institute Standard ETSI EN 300 422-1 v1.4.2 (2011-08), Electromagnetic compatibility and Radio spectrum Matters (ERM); Wireless microphones in the 25 MHz to 3 GHz frequency range; part 1: Technical characteristics and methods of measurement. Digital emissions within the band from one megahertz below to one megahertz above the carrier frequency shall comply with the emission mask in section 8.3.2.2 (Figure 4) of the European Telecommunications Institute Standard ETSI EN 300 422-1 v1.4.2 (2011-08), Electromagnetic compatibility and Radio spectrum Matters (ERM); Wireless microphones in the 25 MHz to 3 GHz frequency range; part 1: Technical characteristics and methods of measurement. Beyond one megahertz below and above the carrier frequency, emissions shall comply with the limits specified in section 8.4 of ETSI EN 300 422-1 v1.4.2 (2011-08). The requirements of this paragraph (e)(7) shall not apply to applications for certification of equipment in these bands until nine months after release of the Commission's Channel Reassignment Public Notice, as defined in §73.3700(a)(2) of this chapter.

4.5.2 Test instruments

Description & manufacturer	Model no.	Serial no.	Calibrated date	Calibrated until
50GHz Spectrum Analyzer	N9030B (PXA)	MY57140597	06/05/2019	06/05/2020
30dB Attenuation	VAT-30W2	N/A	N/A	N/A

4.5.3 Test procedure

- a. The EUT was set up for the rated peak power. The power was measured with spectrum analyzer. All measurements were done at 3 channels: low, middle and high operational frequency range.
- b. When the spectrum scanned from 30 MHz to 26.5 GHz, it shall be connected to spectrum analyzer via an attenuator. The spectrum set RBW = 100 kHz, VBW = 300 kHz while below 1GHz and set RBW = 1 MHz, VBW = 3 MHz with above 1GHz.

4.5.4 Test setup

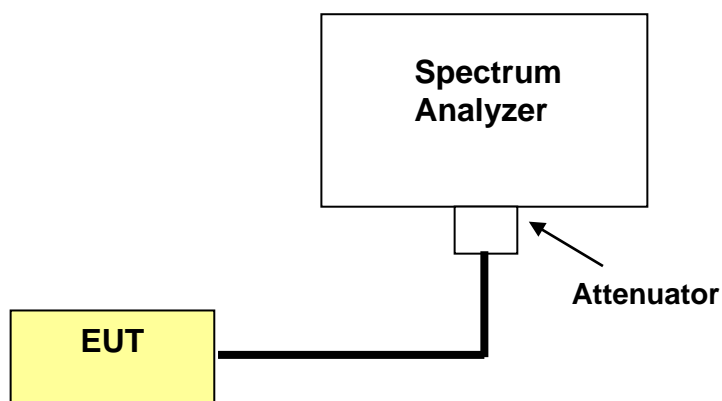

4.5.5 EUT operating conditions

Same as item 4.1.5

4.5.6 Test results

TR-82N FD:

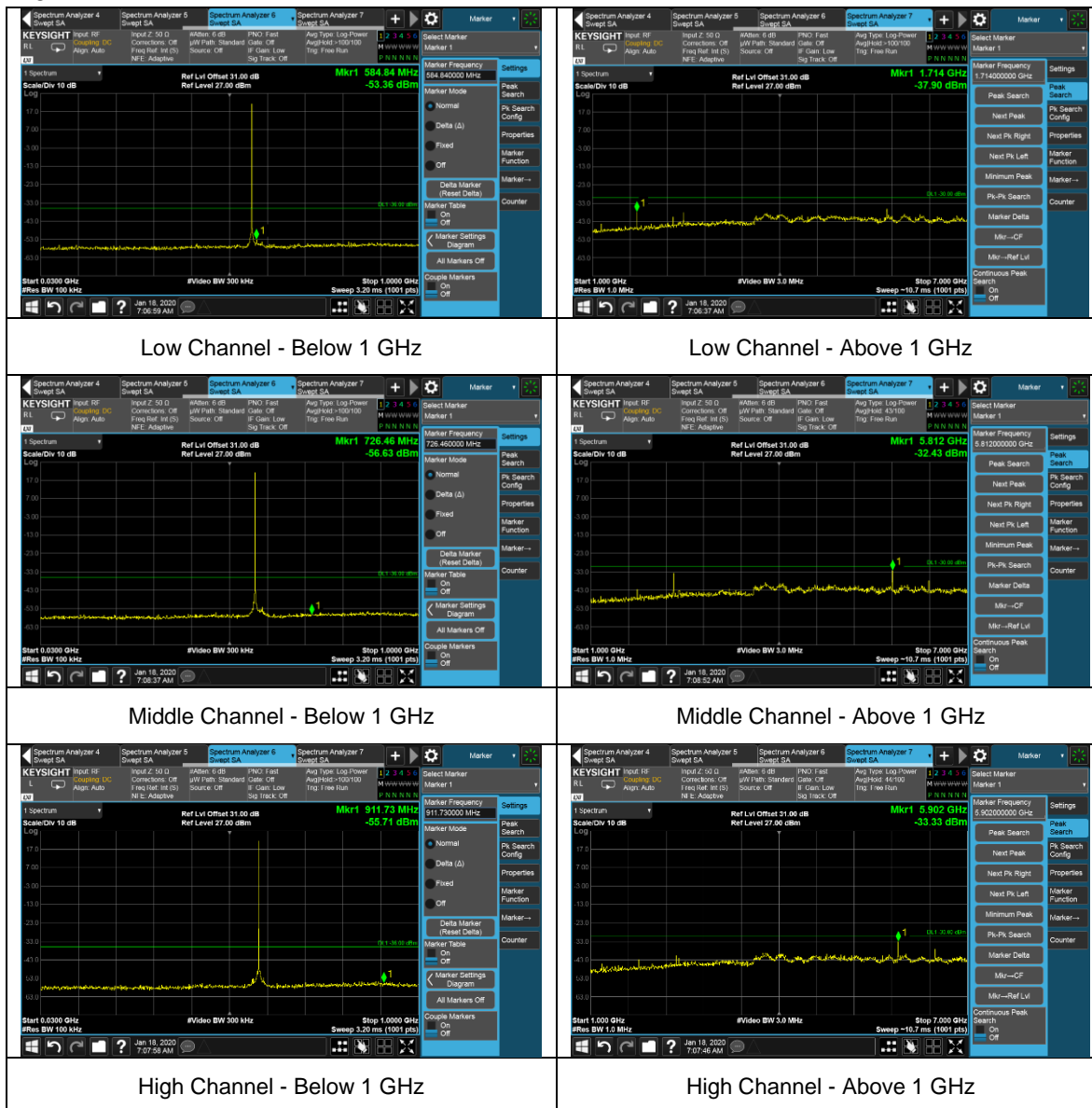

TR-82N HE:

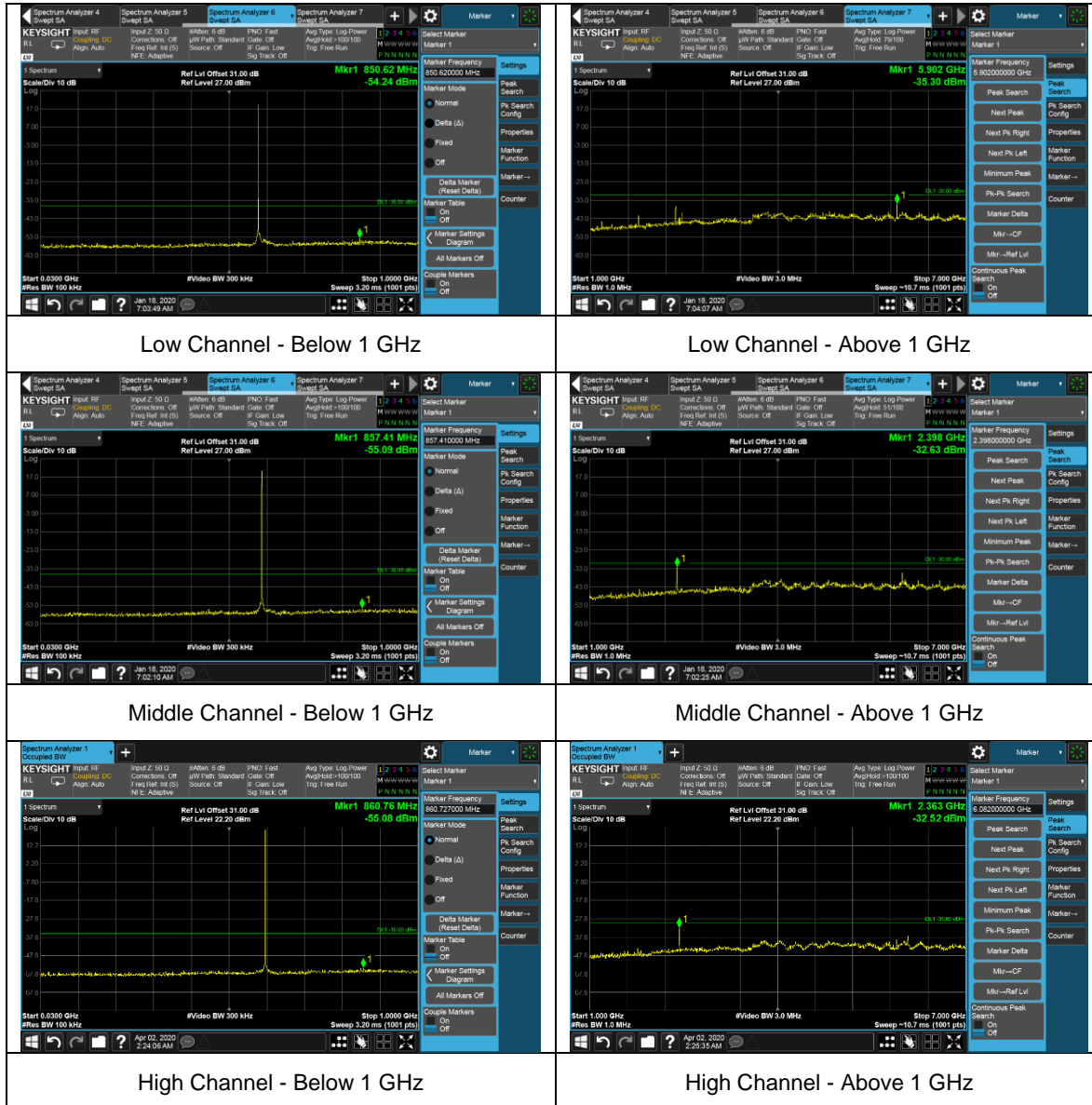

4.6 Radiated emission measurement

4.6.1 Limits of radiated emission measurement

According to FCC 74.861 (e) (7) Analog emissions within the band from one megahertz below to one megahertz above the carrier frequency shall comply with the emission mask in section 8.3.1.2 of the European Telecommunications Institute Standard ETSI EN 300 422-1 v1.4.2 (2011-08), Electromagnetic compatibility and Radio spectrum Matters (ERM); Wireless microphones in the 25 MHz to 3 GHz frequency range; part 1: Technical characteristics and methods of measurement. Digital emissions within the band from one megahertz below to one megahertz above the carrier frequency shall comply with the emission mask in section 8.3.2.2 (Figure 4) of the European Telecommunications Institute Standard ETSI EN 300 422-1 v1.4.2 (2011-08), Electromagnetic compatibility and Radio spectrum Matters (ERM); Wireless microphones in the 25 MHz to 3 GHz frequency range; part 1: Technical characteristics and methods of measurement. Beyond one megahertz below and above the carrier frequency, emissions shall comply with the limits specified in section 8.4 of ETSI EN 300 422-1 v1.4.2 (2011-08). The requirements of this paragraph (e)(7) shall not apply to applications for certification of equipment in these bands until nine months after release of the Commission's Channel Reassignment Public Notice, as defined in §73.3700(a)(2) of this chapter.

According to RSS-210 Annex G.4 Transmitter unwanted emissions

The transmitter unwanted emissions shall meet and be measured according to the requirements in sections 8.3 and 8.4 of ETSI EN 300 422-1.

4.6.2 Test instruments

Description & Manufacturer	Model No.	Serial No.	Calibrated Date	Calibrated Until
Keysight Signal Generator	MXG N5182A	MY47071065	06/28/2019	06/28/2020
50GHz Spectrum Analyzer	N9030B (PXA)	MY57140374	07/22/2019	07/22/2020
Preamplifier RF-Lambda	RAMP00M50GA	17032300047	09/19/2019	09/19/2020
RF Preamplifier	LPA-6-30	11170602	05/06/2019	05/06/2020
Hybrid Antenna SUNAR	JB6	A111717	03/09/2019*	03/09/2020*
DRG Horn Antenna ETS LINDGREN	3117	214309	11/22/2019	11/22/2020
Tuned Dipole Antenna 30 - 1000 MHz (4pcs set)	AD-100	40133	01/23/2018*	01/23/2020*

* 3 month extension from calibration date.

4.6.3 Test procedures

1. The power was measured with spectrum analyzer. All measurements were done at the worst channel. (low, middle and high channel of operational frequency range.)
2. Substitution method is used for EIRP measurement. In the open area test site, EUT placed on the 0.8m height of turn table, rotated the table around 360 degrees to search the maximum radiation power and receiver antenna shall be rotated vertical and horizontal polarization and moved height from 1m to 4m to find the maximum polar radiated power. The “read value” is the spectrum reading the maximum power value.
3. The substitution antenna is substituted for EUT at the same position and signals generator export the CW signal to the substitution antenna via a TX cable. Rotated the turn table and moved receiving antenna to find the maximum radiation power. Adjust output power level of S.G to get a value of spectrum reading equal to “read value “ of step b. Record the power level of S.G
4. $EIRP = \text{output power level of S.G} - \text{TX cable loss} + \text{antenna gain of substitution antenna}$.

Note: the resolution bandwidth and video bandwidth of test receiver/spectrum analyzer is 1MHz/3MHz

4.6.4 Deviation from test standard

No deviation

4.6.5 Test setup

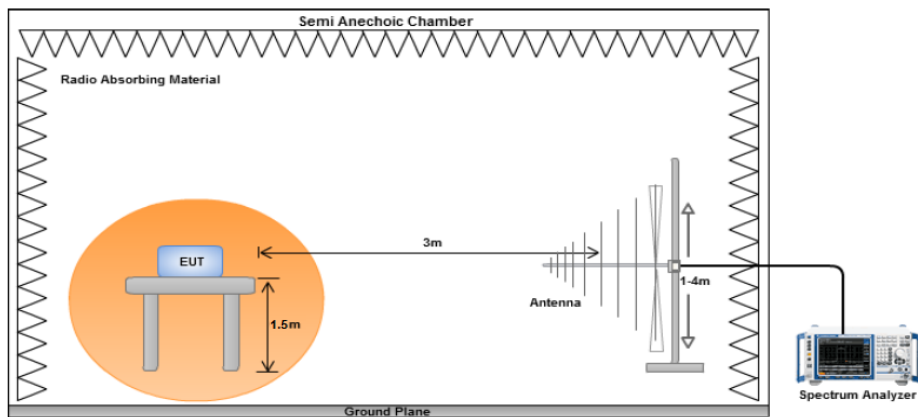

Test Setup below 1GHz

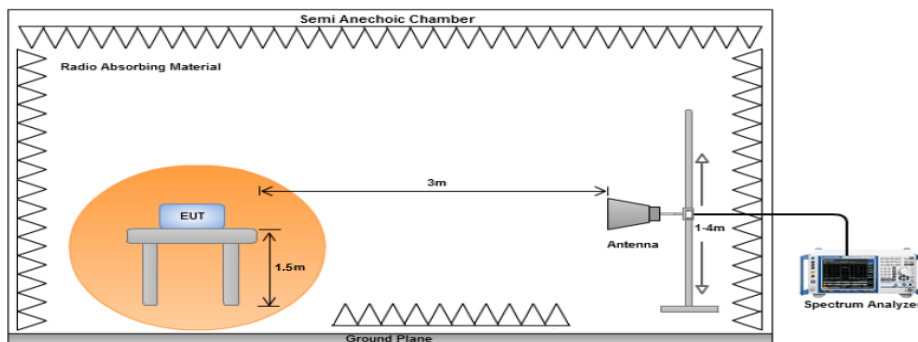

Test Setup above 1GHz

For the actual test configuration, please refer to the related item – photographs of the test configuration.

4.6.6 EUT operating conditions

Same as item 4.1.5

4.6.7 Test results

TR-82N FD:

Below 1GHz Worst-case Data

OPERATING STATE	Transmitting	SPURIOUS EMISSION FREQUENCY RANGE	30MHz ~ 1GHz
------------------------	--------------	--	--------------

Indicated			Test Antenna		Substituted						
Freq (MHz)	Raw (dBm)	Deg	Hgt (cm)	Pol (V/H)	Freq (MHz)	Level (dBm)	Ant Gain (dBi)	Cable Loss (dB)	Absolute Level (dBm)	Limit (dBm)	Margin (dB)
39.98	-72.98	155	124	V	39.98	-67.53	0	0.23	-67.76	-36	-31.76
39.98	-75.2	34	155	H	39.98	-68.22	0	0.23	-68.45	-36	-32.45
550.64	-70.34	257	165	V	550.64	-65.33	0	0.72	-66.05	-54	-12.05
550.64	-73.04	341	168	H	550.64	-67.59	0	0.72	-68.31	-54	-14.31

Above 1GHz

Frequency Range	1GHz ~ 12.75GHz	Operating Channel	572 MHz
------------------------	-----------------	--------------------------	---------

Indicated			Test Antenna		Substituted						
Freq (MHz)	Raw (dBm)	Deg	Hgt (cm)	Pol (V/H)	Freq (MHz)	Level (dBm)	Ant Gain (dBi)	Cable Loss (dB)	Absolute Level (dBm)	Limit (dBm)	Margin (dB)
1144	-47.18	232	145	V	1144	-42.58	8.14	1.12	-35.56	-30	-5.56
1144	-46.18	25	167	H	1144	-41.68	8.14	1.12	-34.66	-30	-4.66
1716	-48.13	66	156	V	1716	-43.59	9.24	1.3	-35.65	-30	-5.65
1716	-47.07	351	169	H	1716	-42.46	9.24	1.3	-34.52	-30	-4.52

Frequency Range	1GHz ~ 12.75GHz	Operating Channel	581 MHz
------------------------	-----------------	--------------------------	---------

Indicated			Test Antenna		Substituted						
Freq (MHz)	Raw (dBm)	Deg	Hgt (cm)	Pol (V/H)	Freq (MHz)	Level (dBm)	Ant Gain (dBi)	Cable Loss (dB)	Absolute Level (dBm)	Limit (dBm)	Margin (dB)
1162	-45.42	231	135	V	1162	-40.66	8.14	1.12	-33.64	-30	-3.64
1162	-46.42	24	198	H	1162	-41.63	8.14	1.12	-34.61	-30	-4.61
1743	-48.03	124	200	V	1743	-43.17	9.24	1.3	-35.23	-30	-5.23
1743	-48.49	267	178	H	1743	-43.52	9.24	1.3	-35.58	-30	-5.58

Frequency Range	1GHz ~ 12.75GHz	Operating Channel	590 MHz
------------------------	-----------------	--------------------------	---------

Indicated			Test Antenna		Substituted						
Freq (MHz)	Raw (dBm)	Deg	Hgt (cm)	Pol (V/H)	Freq (MHz)	Level (dBm)	Ant Gain (dBi)	Cable Loss (dB)	Absolute Level (dBm)	Limit (dBm)	Margin (dB)
1180	-47.51	59	198	V	1180	-42.59	8.36	1.14	-35.37	-30	-5.37
1180	-46.5	123	189	H	1180	-41.58	8.36	1.14	-34.36	-30	-4.36
1770	-46.14	244	177	V	1770	-45.1	9.16	1.32	-37.26	-30	-7.26
1770	-46.63	246	198	H	1770	-43.63	9.16	1.32	-35.79	-30	-5.79

REMARKS:

1. Absolute level (dBm) = Level (dBm) + Ant Gain (dBi) – Cable Loss (dB)
2. Margin value = Absolute level – Limit value.

TR-82N HE:

Below 1GHz Worst-case Data

OPERATING STATE	Transmitting	SPURIOUS EMISSION FREQUENCY RANGE	30MHz ~ 1GHz
------------------------	--------------	--	--------------

Indicated			Test Antenna		Substituted						
Freq (MHz)	Raw (dBm)	Deg	Hgt (cm)	Pol (V/H)	Freq (MHz)	Level (dBm)	Ant Gain (dBi)	Cable Loss (dB)	Absolute Level (dBm)	Limit (dBm)	Margin (dB)
40.27	-69.29	229	187	V	40.27	-65.31	0	0.23	-65.54	-36	-29.54
40.27	-71.21	128	198	H	40.27	-66.17	0	0.23	-66.4	-36	-30.4
425.03	-66.48	27	189	V	425.03	-61.81	0	0.61	-62.42	-36	-26.42
425.03	-68.94	66	199	H	425.03	-65.24	0	0.61	-65.85	-36	-29.85

Above 1GHz

Frequency Range	1GHz ~ 12.75GHz	Operating Channel	590 MHz
------------------------	-----------------	--------------------------	---------

Indicated			Test Antenna		Substituted						
Freq (MHz)	Raw (dBm)	Deg	Hgt (cm)	Pol (V/H)	Freq (MHz)	Level (dBm)	Ant Gain (dBi)	Cable Loss (dB)	Absolute Level (dBm)	Limit (dBm)	Margin (dB)
1180	-48.98	266	200	V	1180	-43.88	8.36	1.14	-36.66	-30	-6.66
1180	-47.86	271	189	H	1180	-42.83	8.36	1.14	-35.61	-30	-5.61
1770	-50.01	217	126	V	1770	-44.38	9.16	1.32	-36.54	-30	-6.54
1770	-50.21	265	255	H	1770	-43.48	9.16	1.32	-35.64	-30	-5.64

Frequency Range	1GHz ~ 12.75GHz	Operating Channel	599 MHz
------------------------	-----------------	--------------------------	---------

Indicated			Test Antenna		Substituted						
Freq (MHz)	Raw (dBm)	Deg	Hgt (cm)	Pol (V/H)	Freq (MHz)	Level (dBm)	Ant Gain (dBi)	Cable Loss (dB)	Absolute Level (dBm)	Limit (dBm)	Margin (dB)
1198	-46.86	98	166	V	1198	-41.76	8.36	1.14	-34.54	-30	-4.54
1198	-49.21	198	165	H	1198	-42.87	8.36	1.14	-35.65	-30	-5.65
1797	-48.79	276	190	V	1797	-43.69	9.16	1.32	-35.85	-30	-5.85
1797	-50.96	165	125	H	1797	-44.77	9.16	1.32	-36.93	-30	-6.93

Frequency Range	1GHz ~ 12.75GHz	Operating Channel	607.975 MHz
------------------------	-----------------	--------------------------	-------------

Indicated			Test Antenna		Substituted						
Freq (MHz)	Raw (dBm)	Deg	Hgt (cm)	Pol (V/H)	Freq (MHz)	Level (dBm)	Ant Gain (dBi)	Cable Loss (dB)	Absolute Level (dBm)	Limit (dBm)	Margin (dB)
1215.95	-49.02	90	166	V	1215.95	-43.42	8.36	1.14	-36.2	-30	-6.2
1215.95	-48.24	355	178	H	1215.95	-42.4	8.36	1.14	-35.18	-30	-5.18
1823.93	-51.55	180	180	V	1823.93	-46.17	9.16	1.32	-38.33	-30	-8.33
1823.93	-50.28	275	200	H	1823.93	-44.13	9.16	1.32	-36.29	-30	-6.29

REMARKS:

1. Absolute level (dBm) = Level (dBm) + Ant Gain (dBi) – Cable Loss (dB)
2. Margin value = Absolute level – Limit value.

5 Photographs of the test configuration

Please refer to the attached file (test setup photo).

6 Information Of The Testing Laboratories

Bureau Veritas is a global leader in testing, inspection and certification (TIC) services. We help businesses improve safety, sustainability and productivity; and our clients include the majority of leading brands in retail, manufacturing and other industries. With a presence in every major country around the world, our quality assurance and compliance solutions are vital in helping our customers enhance product quality and concept-to-consumer journeys. We also assist with increasing speed to market, profitability and brand equity throughout the supply chain. Bureau Veritas is a leading wireless/IoT testing, inspection, audit and certification provider, with a global network of test laboratories to support the IoT industry in areas of connectivity, security, interoperability as well as quality, health & safety, and environmental/chemical requirements.

If you have any comments, please feel free to contact us at the following:

Milpitas EMC/RF/Safety/Telecom Lab

775 Montague Expressway, Milpitas, CA 95035
Tel: +1 408 526 1188

Sunnyvale OTA/Bluetooth Lab

1293 Anvilwood Avenue, Sunnyvale, CA
94089
Tel: +1 669 600 5293

Littleton EMC/RF/Safety/Environmental Lab

1 Distribution Center Cir #1, Littleton, MA 01460
Tel: +1 978 486 8880

Email: sales.eaw@us.bureauveritas.com

Web Site: www.cps.bureauveritas.com

The address and road map of all our labs can be found in our web site also.

--- END ---