

Beltpack Operation

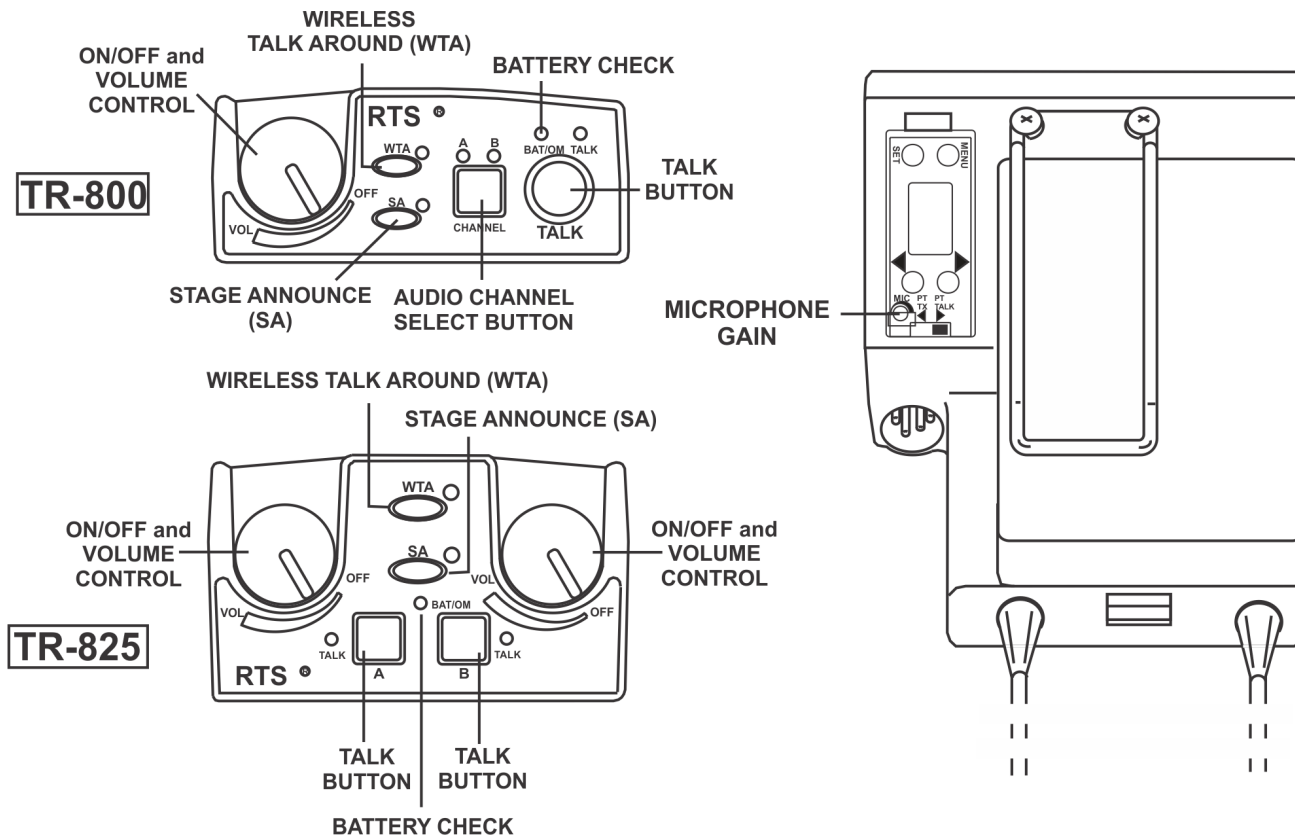

FIGURE 37.
TR-800 and TR-825 Top and Rear Panel

On/Off and Volume Control

Turn the beltpack power on by rotating the knob CW. Adjust the volume to the headset by rotating the volume control as required for a comfortable listening volume.

Battery Check

When the beltpack power is turned on by rotating the knob, the BAT/OM LED will flash once if the battery is good. If the LED stays on, the battery is low. If the LED does not flash, the battery is dead.

Talk Button

Press the talk button to enable the audio path from the headset microphone. The TALK/OM LED will turn red when audio is enabled. A quick press and release latches the talk function unless latching has been disabled. Holding the button for over 1/2 a second will cause the audio path to be enabled only for as long as the button is held. If the talk function is latched on, pressing the talk button again will turn it off. See “Talk Button Latch on/Latch off” on page 57 to learn how to enable/disable latching of the talk button.

Microphone Gain

Adjusts the headset’s microphone gain. Adjust so the TALK/OM LED flashes red at the beginning of most words at normal speech levels. If the input is too large, the LED will be red during the complete word at normal speech level. The peak-responding audio limiter in the beltpack is very tolerant of high input audio levels. Even when the microphone gain is

maximized, and headset volume reduced to make up for the louder audio, the audio will still sound good and not clipped.

Audio Channel Select Button

Selects the intercom system to which the headset is connected. The LED near the channel button indicates the current selection. See the “Audio Channel A or B Disable/Enable” on page 57 to learn how to enable only channel A, channel B, or both.

Stage Announce (SA)

When pressed the audio from the beltpack is routed directly to the stage announce connector on the back of the base station. The base station’s SA relay is also closed. The beltpack sidetone is lost as an indication that stage announce is activated. The other beltpacks and wired users do not hear this beltpacks audio when SA is pressed. The button is non-latching and activates the nearby red LED when pressed. See “Stage Announce Enable/Disable” on page 56 to learn how to enable/disable the SA button.

Wireless Talk Around (WTA)

When pressed, the audio from the beltpack is disconnected from the wired intercom, auxiliary input/output and the base station’s local headset. Other beltpack users, on that audio channel, can hear the user as normal. The button activates the nearby red LED as well as the appropriate talk LED when pressed. See the “Wireless Talk Around Enable/Disable” on page 56 to learn how to enable/disable the WTA button as well as other features.

TR-800 Menu Structure

Beltpack Menu Structure

The following contains the main beltpack menu structure and references the pages in which further detail of that menu may be found.

All beltpack features and special key sequences can only be done from the group/channel screen.

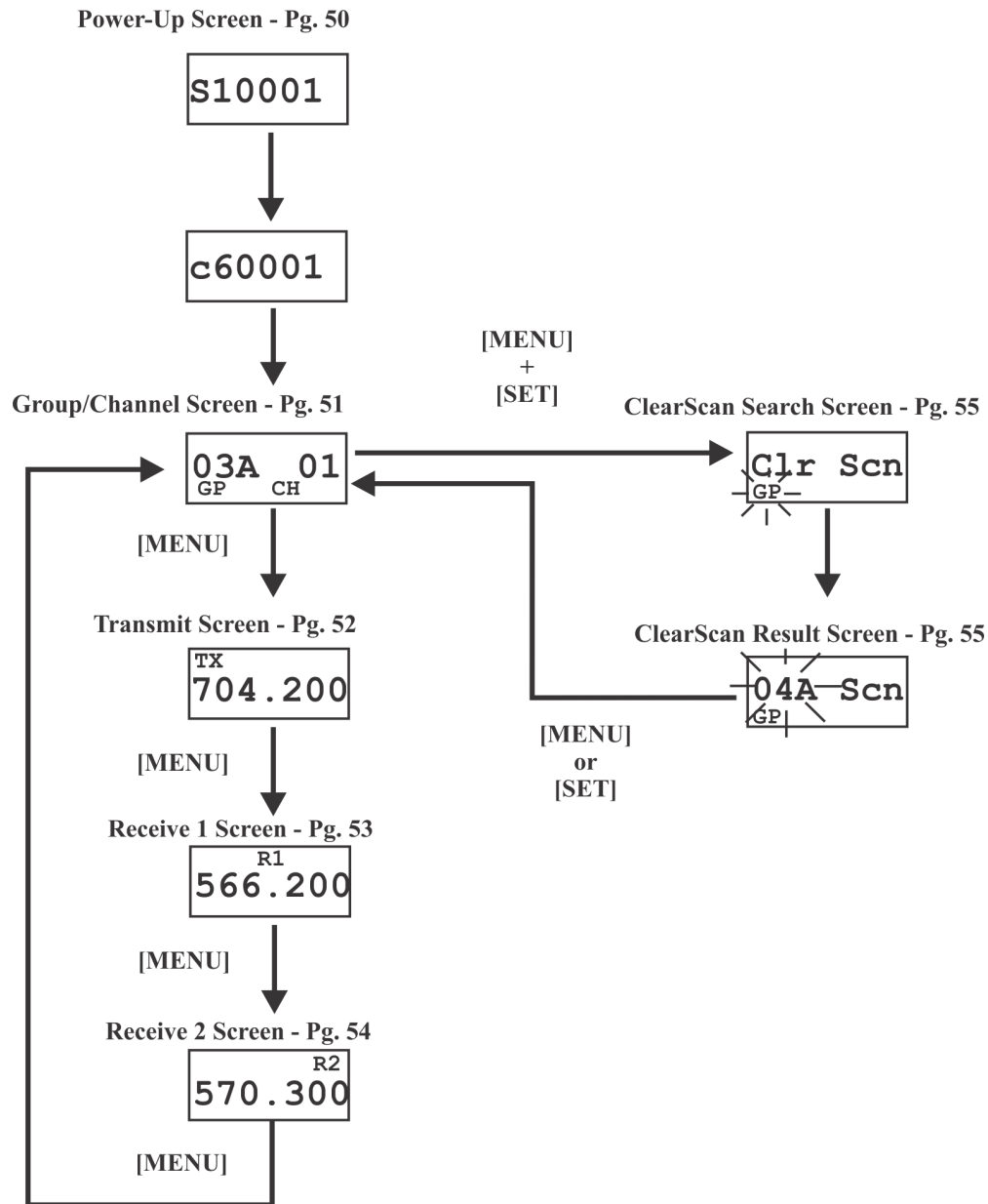

FIGURE 38. Power-Up Screen

Beltpack Feature Enable/Disable Menus

- Stage Announce (SA) Enable/Disable..... page 56*
- Wireless Talk Around (WTA) Enable/Disable page 56*
- Audio Channel A/B Enable/Disable..... page 57*
- Talk Button Latching/Non-Latching..... page 57*

Other Special Key Sequences

- Lockout..... page 58*
- 1st Use Default..... page 58*
- Factory Default..... page 58*

NOTE: Pressing [MENU] within a screen after action has occurred escapes from that action and places the user at the current screen. Any editing that had been done since [SET] had been pressed is aborted.

Power-Up Screens

- The first screens displayed when the beltpack is powered up are the software and channel map version screens.
- The 1st screen displayed indicates the beltpack's software version number. It is displayed for about one second.
- The 2nd screen displayed indicates the beltpack's channel map (frequency plan) version number. It is displayed for about one second.
- The final screen displayed is the group/channel screen.

S10001



c60001



03A 01
GP CH

END

Group/Channel Screen

The Group/Channel screen allows the user to change the group and select from a pre-determined number of transmit channels.

- The screen displayed after the beltpack power-up screens.
- Press [SET] to edit the channel number. The channel number will start flashing.
- Use the [UP]/[DOWN] arrow buttons to change the channel number
- Press [SET] to place the beltpack on the channel selected. Once set is pressed, the beltpack transmitter will move to that frequency and nothing will be flashing. Now press [SET] twice to enter group edit.
- Use the [UP]/[DOWN] arrow buttons to change the group number.
- Press [SET] to place the beltpack on the group selected. Once set is pressed, the unit returns to the group/channel display with nothing flashing.
- Pressing [SET] once more will start the editing sequence over again. Pressing [MENU] during the group edit will end editing and send the user back at the group/channel screen without any changes. This applies to channel editing too.

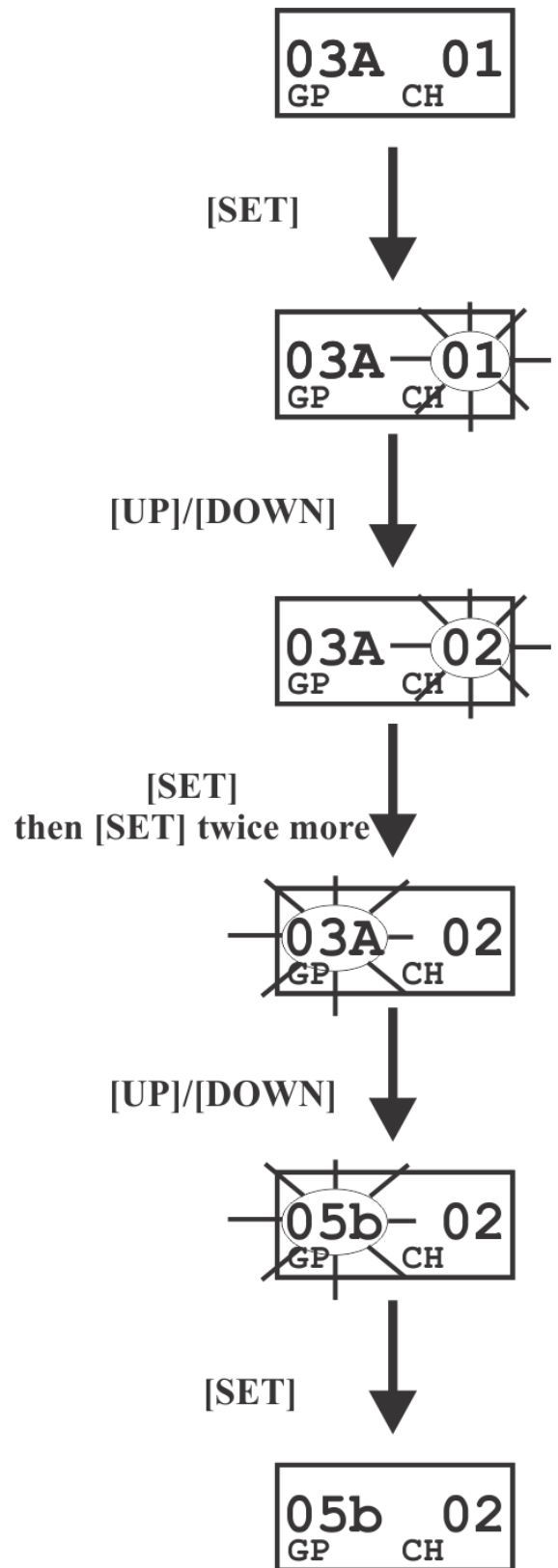

END

Transmit Screen

The Transmit screen allows the user to set the beltpack transmit frequency. Factory-defined groups will allow only a set number of pre-defined frequencies to be selected. User-programmable groups will allow the user to change the frequency in 25kHz steps.

- Press [MENU] once from the group/channel screen to arrive at the transmit frequency screen.
- Press [SET] to edit the frequency. The number will start flashing.
- Use the [UP]/[DOWN] arrow buttons to change the frequency.
- Press [SET] to place the beltpack on the frequency selected. If set is held down, during that time the group/channel is displayed so the user is aware of what transmit channel the unit has been placed. Once set is released, the unit returns to the transmit frequency screen with nothing flashing.
- Pressing [SET] once more will start the editing sequence over again. Pressing [MENU] during transmit frequency edit will end editing and send the user back to the transmit screen without any changes.

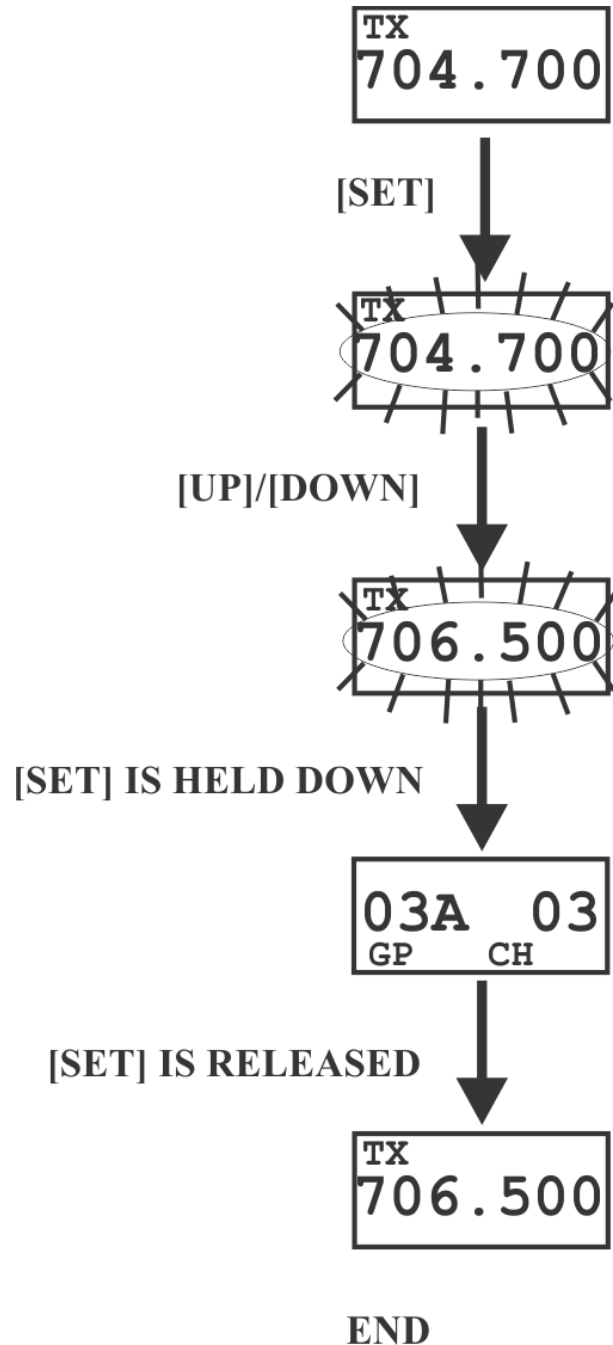

Receive 1 Screen

The Receive 1 screen allows the user to set the beltpack receive 1 frequency. This corresponds to the base station's transmit 1 frequency. In factory-defined groups, receive 1 is not changeable. User-programmable groups will allow the user to change the frequency in 25 kHz steps.

- Press [MENU] twice from the group/channel screen to arrive at the receive 1 frequency screen.
- (User-Programmable Groups Only) Press [SET] to edit the frequency. The number will start flashing. Factory-defined groups can't be changed; so pressing set will do nothing at this screen. User-programmed groups will start flashing and allow the user to change the frequency in 25 kHz steps.
- (User-Programmable Groups Only) Use the [UP]/[DOWN] arrow buttons to change the frequency.
- (User-Programmable Groups Only) Press [SET] to place the beltpack on the frequency selected. If set is held down, during that time the group is displayed so the user is aware of what group the unit has been placed. Once set is released, the unit returns to the receive 1 frequency screen with nothing flashing.
- (User-Programmable Groups Only) Pressing [SET] once more will start the editing sequence over again. Pressing [MENU] during receive 1 frequency edit will end editing and send the user back to the receive 1 screen without any changes.

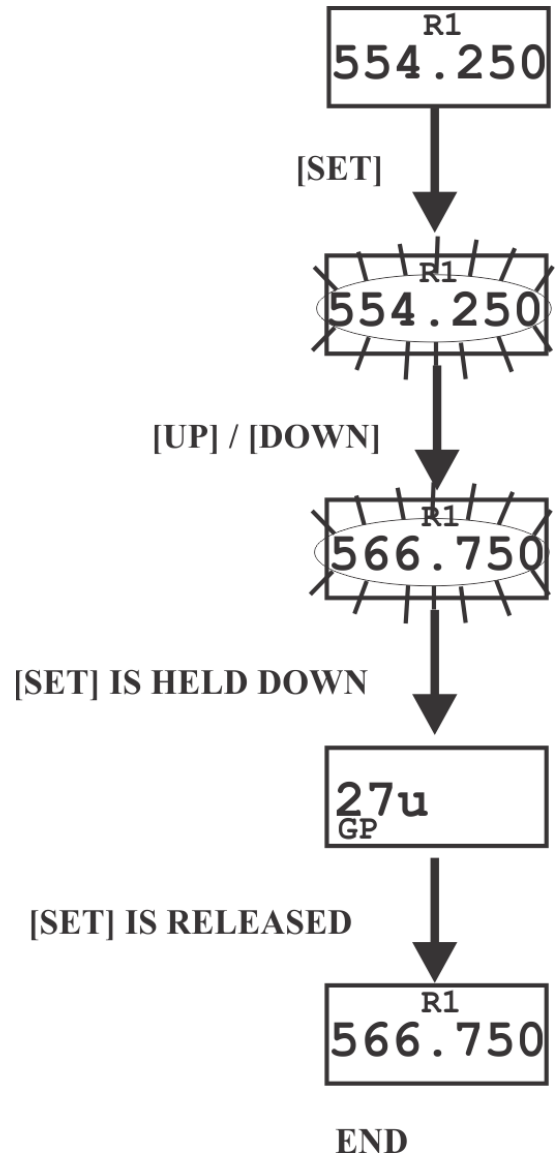

Receive 2 Screen

The Receive 2 screen allows the user to set the beltpack receive 2 frequency. This corresponds to the base station's transmit 2 frequency. In factory-defined groups receive 2 is not changeable. User-programmable groups will allow the user to change the frequency in 25 kHz steps.

- Press [MENU] three times from the group/channel screen to arrive at the receive 2 frequency screen.
- (User-Programmable Groups Only) Press [SET] to edit the frequency. The number will start flashing. Factory-defined groups can't be changed, so pressing set will do nothing at this screen. User-programmed groups will start flashing and allow the user to change the frequency in 25 kHz steps.
- (User-Programmable Groups Only) Use the [UP]/[DOWN] arrow buttons to change the frequency.
- (User-Programmable Groups Only) Press [SET] to place the beltpack on the frequency selected. If set is held down, during that time the group is displayed so the user is aware of what group the unit has been placed. Once set is released, the unit returns to the receive 2 frequency screen with nothing flashing.
- (User-Programmable Groups Only) Pressing [SET] once more will start the editing sequence over again. Pressing [MENU] during receive 2 frequency edit will end editing and send the user back to the receive 2 screen without any changes.

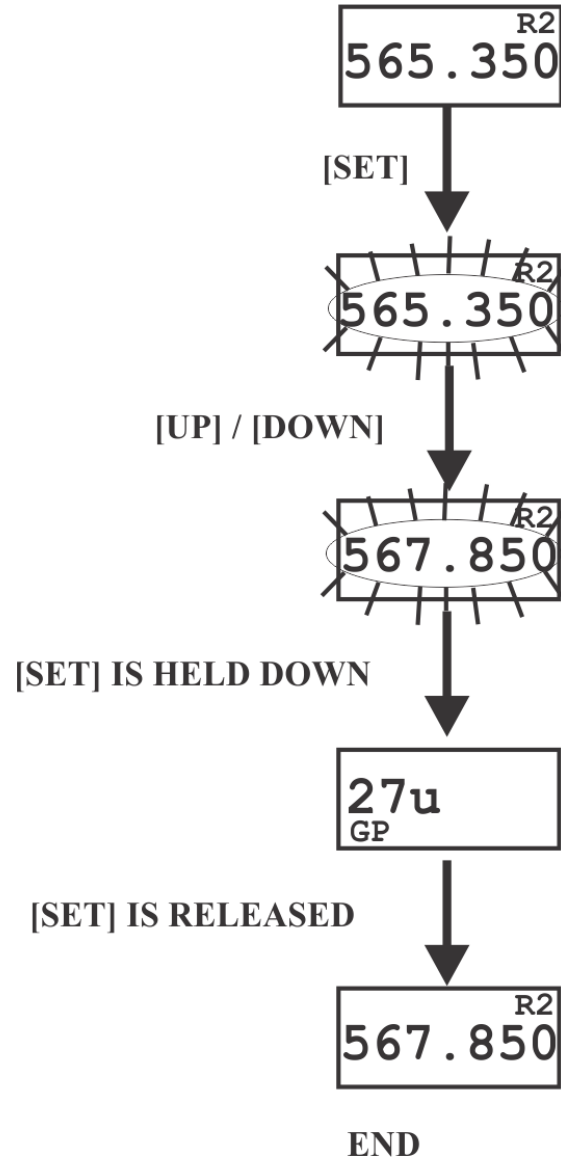

ClearScan™

ClearScan™ performs a frequency scan of the factory-defined and any setup user-programmable groups in order to find the clearest group. After about 30 seconds, the clearest group is displayed. A group is defined by receive 1 and 2 frequencies. The next best group and so forth may be accessed with the [DOWN] and [UP] arrow buttons.

- Press and hold [MENU]+[SET] for three seconds to enter ClearScan™. The beltpack will now start searching for the clearest groups. The group symbol will flash indicating the beltpack is scanning for clear groups.
- ClearScan™ will scan all groups. It will then display the 1st group it came to that had the clearest receive channels. The [UP]/[DOWN] buttons may be used to select the next best group and so forth. Press [SET] to place the beltpack on this group and return to the group/channel screen.

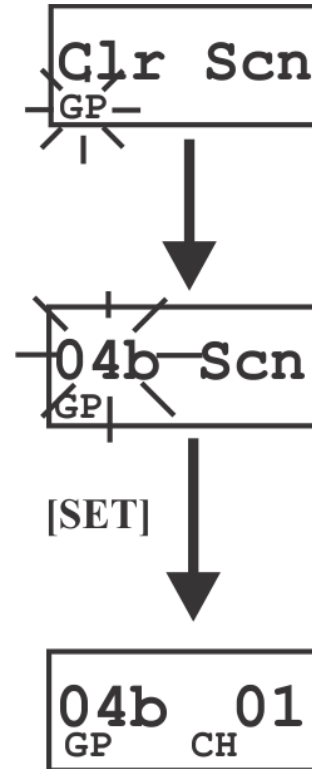

END

Stage Announce Enable/Disable

- Press and hold [SET] then press the [SA] button to show the SA enable/disable screen. The current setting of the feature is displayed on the LCD.
- While continuing to hold [SET] press [SA] again to toggle the display from ON to OFF or back. Release the [SET] button to accept the current displayed setting and return to the Group/Channel screen

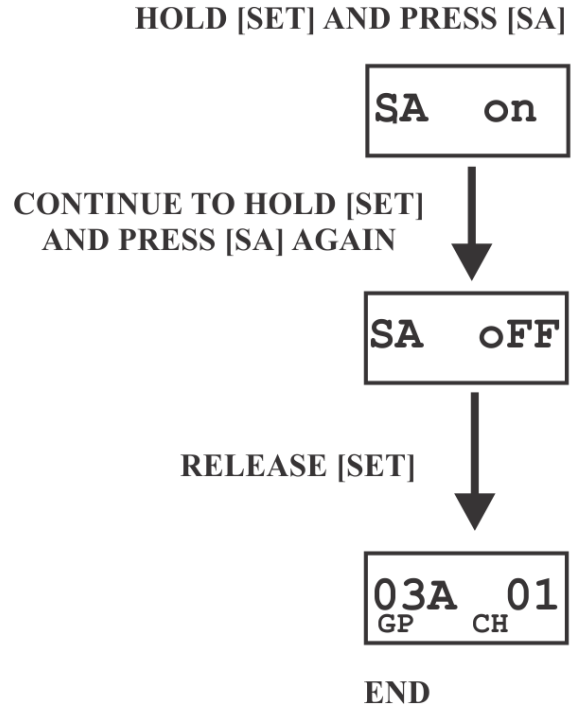

Wireless Talk Around Enable/Disable

- Press and hold [SET], then press the [WTA] button to show the WTA enable/disable screen. The current setting of the feature is displayed on the LCD.
- While continuing to hold [SET] press [WTA] again to cycle the display from on, off, then L on (latch on). Release the [SET] button to accept the current displayed setting and return to the Group/Channel screen.

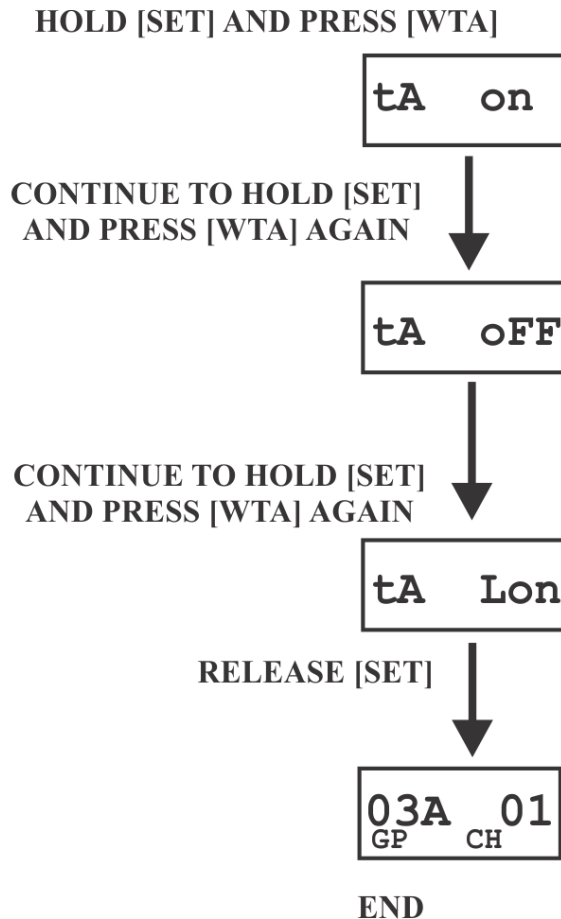

Audio Channel A or B Disable/Enable

- Press and hold [SET] then press the [CHAN] button to show the channel enable/disable screen. The current setting of the feature is displayed on the LCD.
- While continuing to hold [SET], press the [CHAN] button again to move to the next option, only channel B on.
- As you continue to hold [SET], press the [CHAN] button once more to move to the next option, only channel A on. If the [CHAN] button was pressed once more, the user would start over at the AB ON screen.
- Release the [SET] button to accept the current displayed setting and return to the Group/Channel screen.

Disabling Audio Channel A

HOLD [SET] AND PRESS [CHAN]



CONTINUE TO HOLD [SET] AND PRESS [CHAN] AGAIN



CONTINUE TO HOLD [SET] AND PRESS [CHAN] AGAIN



RELEASE [SET]



END

Talk Button Latch on/Latch off

- Press and hold [SET], then press the [TALK] button to show the Talk Button Latch/Non-Latching screen. The current setting of the feature is displayed on the LCD display.
- While continuing to hold [SET] press [TALK] again to toggle the display from on to off or back. Release the [SET] button to accept the current displayed setting and return to the Group/Channel screen.

HOLD [SET] AND PRESS [TALK]



CONTINUE TO HOLD [SET] AND PRESS [TALK] AGAIN



RELEASE [SET]



END

Special Key Sequences

Lockout

- Press [UP]+[DOWN] for three seconds to lock or unlock the beltpack. The words “Loc on” will be displayed when the feature is activated, “Loc oFF” will be displayed when the beltpack is unlocked. Pressing [MENU] will still function to view screens, but [SET] will no longer start any editing. ClearScan™, First use, Factory default and Feature enable/disable are no longer accessible.

1st Use Default

- Press [MENU] while turning on the beltpack to enter the 1st use default setup screen. This places the unit on group 01A with channel 01 flashing. **Any user-programmed frequencies that had been entered previously are retained.** The beltpacks must now be set to different transmit channels using the [UP]/[DOWN] buttons. Then [SET] is pressed to place the units on those channels. If lockout had been activated, the beltpack comes up where it was last left regardless of [MENU] being pressed on power-up.

Factory Default

- Pressing all four buttons [MENU]+[SET]+[UP]+[DOWN] at the same time for three seconds places the unit on group 01A with channel 01 flashing, just like beltpack 1st use default, except the **all user-programmed frequencies that had been entered previously are erased.** After the buttons are released, it still may take several seconds for the beltpack to reset. The beltpacks must now be set to different transmit channels using the [UP]/[DOWN] buttons. Then [SET] is pressed to place the units on those channels. If lockout had been activated, the beltpack comes up where it was last left regardless of these four keys being pressed.

TR-825 Menu Structure

Beltpack Menu Structure

The following contains the main beltpack menu structure and references the pages in which further detail of that menu may be found.

All beltpack features and special key sequences can only be done from the group/channel screen.

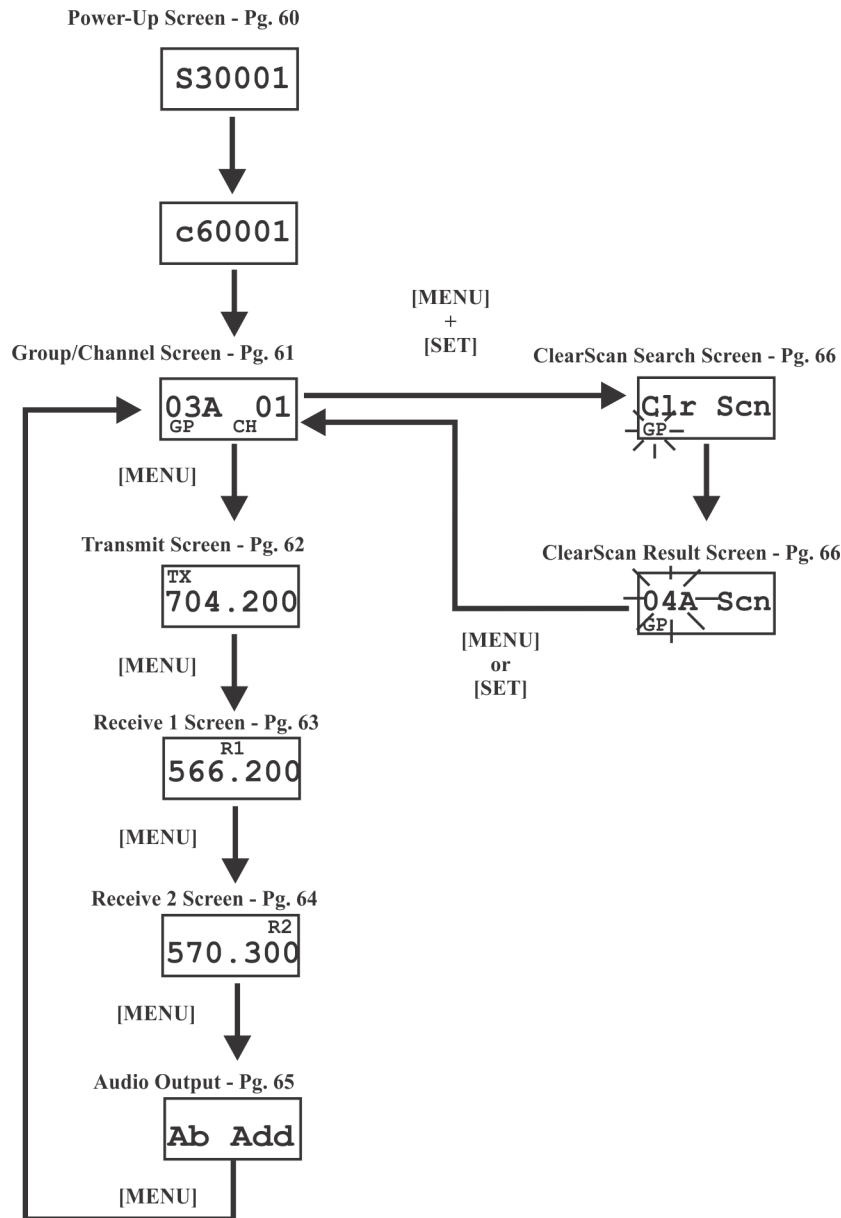

FIGURE 39. Power-Up Screen

Beltpack Feature Enable/Disable Menus

Audio Output..... page 65
Stage Announce (SA)..... page 67
Wireless Talk Around (WTA)..... page 68
Audio Channel A..... page 69
Audio Channel B..... page 70

Other Special Key Sequences

Lockout..... page 71
1st Use Default..... page 71
Factory Default..... page 71

NOTE: Pressing [MENU] within a screen after action has occurred escapes from that action and places the user at the current screen. Any editing that had been done since [SET] had been pressed is aborted.

Power-Up Screens

- The first screens displayed when the beltpack is powered up are the software and channel map version screens.
- The 1st screen displayed indicates the beltpack's software version number. It is displayed for about one second.
- The 2nd screen displayed indicates the beltpack's channel map (frequency plan) version number. It is displayed for about one second. The operating screen is then displayed.
- The final screen displayed is the group/channel screen.

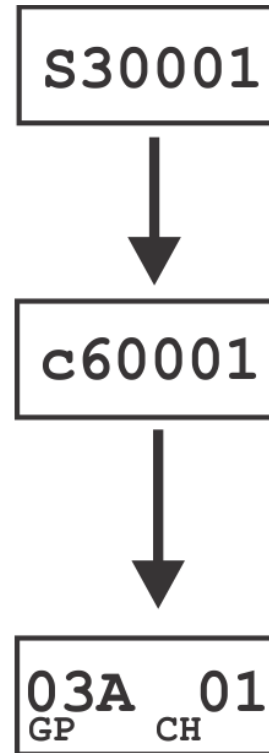

END

Group/Channel Screen

The Group/Channel screen allows the user to change the group and select from a pre-determined number of transmit channels.

- The screen displayed after the beltpack power-up screens.
- Press [SET] to edit the channel number. The channel number will start flashing.
- Use the [UP]/[DOWN] arrow buttons to change the channel number.
- Press [SET] to place the beltpack on the channel selected. Once set is pressed, the beltpack transmitter will move to that frequency and nothing will be flashing. Now press [SET] twice to enter group edit.
- Use the [UP]/[DOWN] arrow buttons to change the group number.
- Press [SET] to place the beltpack on the group selected. Once set is pressed, the unit returns to the group/channel display with nothing flashing.
- Pressing [SET] once more will start the editing sequence over again. Pressing [MENU] during the group edit will end editing and send the user back at the group/channel screen without any changes. This applies to channel editing also.

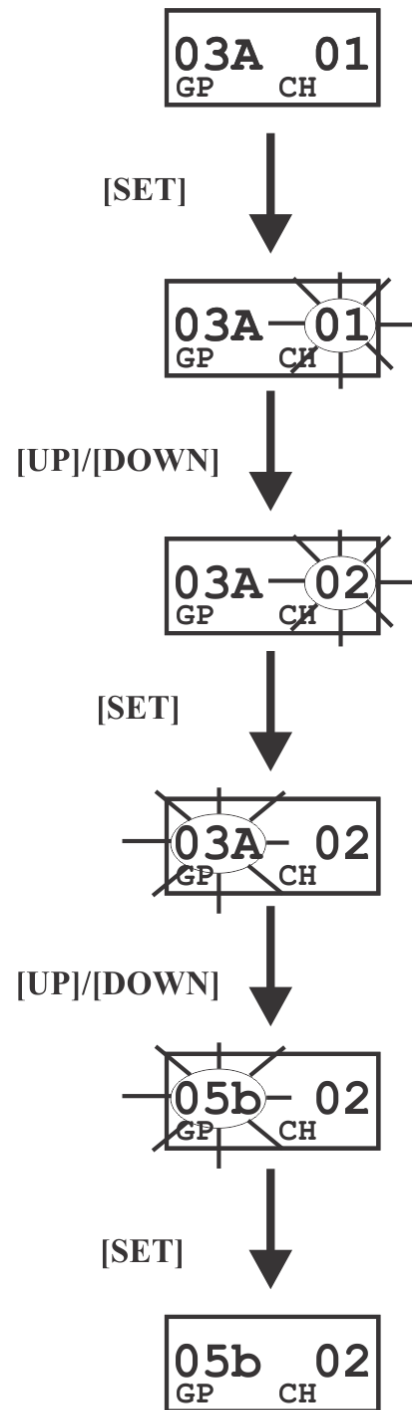

END

Transmit Screen

The Transmit screen allows the user to set the beltpack transmit frequency. Factory-defined groups will allow only a set number of pre-defined frequencies to be selected. User-programmable groups will allow the user to change the frequency in 25 kHz steps.

- Press [MENU] once from the group/channel screen to arrive at the transmit frequency screen.
- Press [SET] to edit the frequency. The number will start flashing. Factory-defined groups will allow only a set number of pre-defined frequencies to be selected. User-programmable groups will allow the user to change the frequency in 25 kHz steps.
- Use the [UP]/[DOWN] arrow buttons to change the frequency.
- Press [SET] to place the beltpack on the frequency selected. If [SET] is held down, during that time the group/channel is displayed so the user is aware of what transmit channel the unit has been placed. Once [SET] is released, the unit returns to the transmit frequency screen with nothing flashing.
- Pressing [SET] once more will start the editing sequence over again. Pressing [MENU] during transmit frequency edit will end editing and send the user back to the transmit screen without any changes.

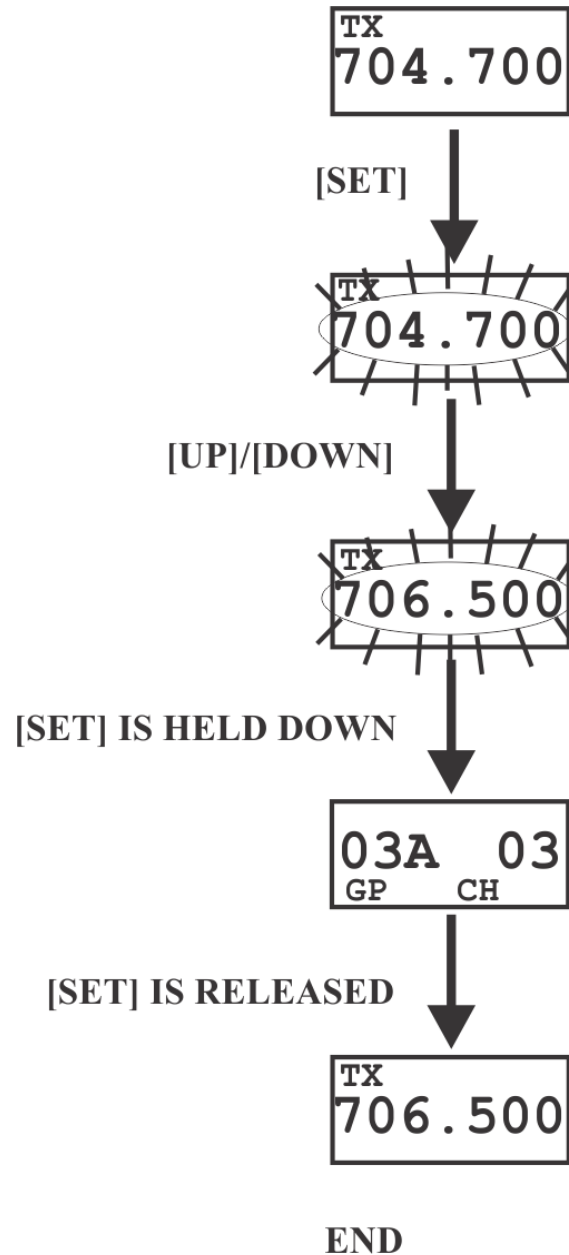

Receive 1 Screen

The Receive 1 screen allows the user to set the beltpack receiver 1 frequency. This corresponds to the base station's transmit 1 frequency. In factory-defined groups receiver 1 is not changeable. User-programmable groups will allow the user to change the frequency in 25 kHz steps.

- Press [MENU] twice from the group/channel screen to arrive at the receive 1 frequency screen.
- (User-Programmable Groups Only) Press [SET] to edit the frequency. The number will start flashing. Factory-defined groups can't be changed; so pressing set will do nothing at this screen. User-programmed groups will start flashing and allow the user to change the frequency in 25 kHz steps.
- (User-Programmable Groups Only) Use the [UP]/[DOWN] arrow buttons to change the frequency.
- (User-Programmable Groups Only) Press [SET] to place the beltpack on the frequency selected. If [SET] is held down, during that time the group is displayed so the user is aware of what group the unit has been placed. Once [SET] is released, the unit returns to the receive 1 frequency screen with nothing flashing.
- (User-Programmable Groups Only) Pressing [SET] once more will start the editing sequence over again. Pressing [MENU] during receive 1 frequency edit will end editing and send the user back to the receive 1 screen without any changes.

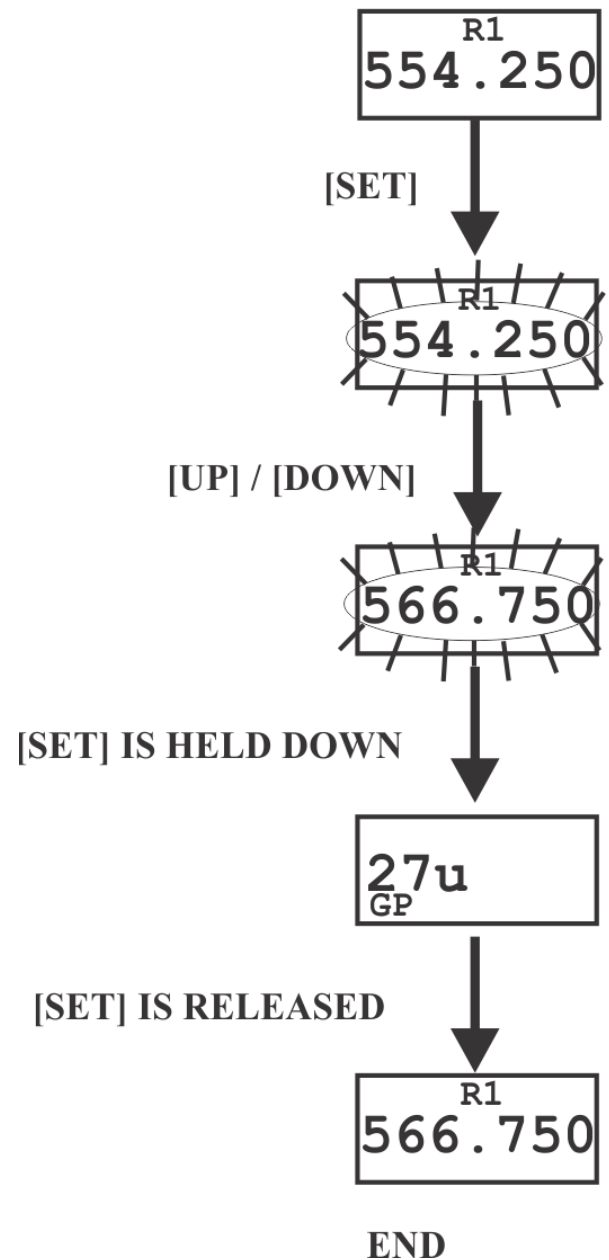

Receive 2 Screen

The Receive 2 screen allows the user to set the beltpack receive 2 frequency. This corresponds to the base station's transmit 2 frequency. In factory-defined groups receiver 2 is not changeable. User-programmable groups will allow the user to change the frequency in 25 kHz steps.

- Press [MENU] three times from the group/channel screen to arrive at the receive 2 frequency screen.
- (User-Programmable Groups Only) Press [SET] to edit the frequency. The number will start flashing. Factory-defined groups can't be changed, so pressing [SET] will do nothing at this screen. User-programmed groups will start flashing and allow the user to change the frequency in 25 kHz steps.
- (User-Programmable Groups Only) Use the [UP]/[DOWN] arrow buttons to change the frequency.
- (User-Programmable Groups Only) Press [SET] to place the beltpack on the frequency selected. If [SET] is held down, during that time the group is displayed so the user is aware of what group the unit has been placed. Once [SET] is released, the unit returns to the receive 2 frequency screen with nothing flashing.
- (User-Programmable Groups Only) Pressing [SET] once more will start the editing sequence over again. Pressing [MENU] during receive 2 frequency edit will end editing and send the user back to the receive 2 screen without any changes.

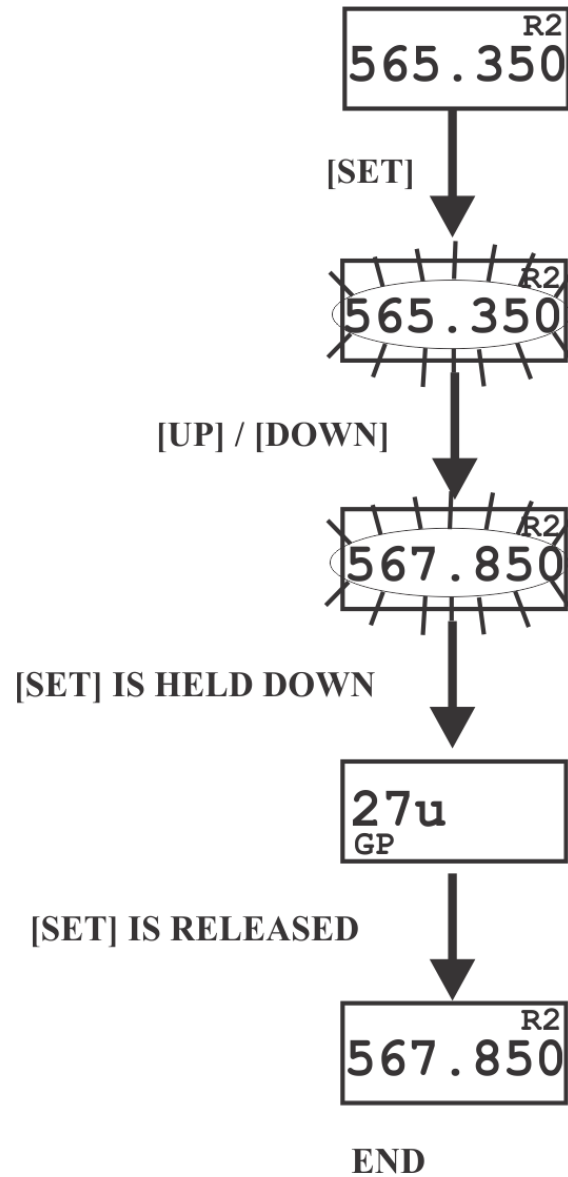

Audio Output

The Audio Output screen allows the user to set the audio output to Mono (Add) or Stereo (SEP). This option only applies to beltpack with 5-pin headset connectors. Single-sided 5-pin headsets will only receive A or B Audio depending on how the headset is wired. Single-sided 5-pin headsets must set the audio output to Ab SEP. The audio output option setting does nothing with a 4-pin headset connector.

- Press [MENU] four times from the group/channels screen to arrive at the audio output screen.
- Press [SET] to change the setting. The option will start to flash.
- Use the [UP]/[DOWN] arrow buttons to change the audio output option.
- Press [SET] to end editing and accept the setting.

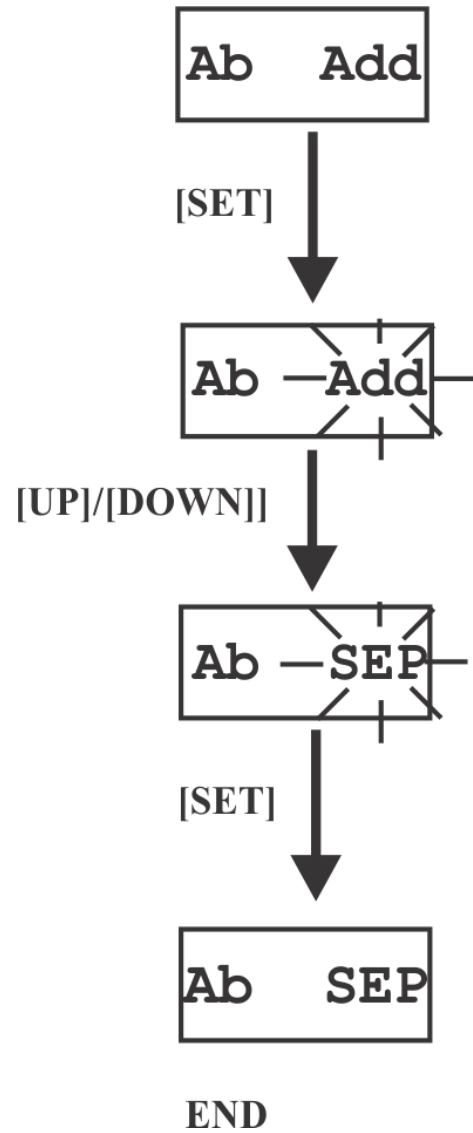

ClearScan™

ClearScan™ performs a frequency scan of the factory-defined and any set up user-programmable groups in order to find the clearest group. After about 30 seconds, the clearest group is displayed. A group is defined by receive 1 and 2 frequencies. The next best group and so forth may be accessed with the [DOWN] and [UP] arrow buttons.

- Press and hold [MENU]+[SET] for three seconds to enter ClearScan™. The beltpack will now start searching for the clearest groups. The group symbol will flash indicating the beltpack is scanning for clear groups.
- ClearScan™ will scan all groups. It will then display the 1st group it came to that had the clearest receive channels (lowest RSSI levels on the two frequencies). The [UP]/[DOWN] buttons may be used to select the next best group and so forth. Press [SET] to place the beltpack on this group and return to the group/channel screen.

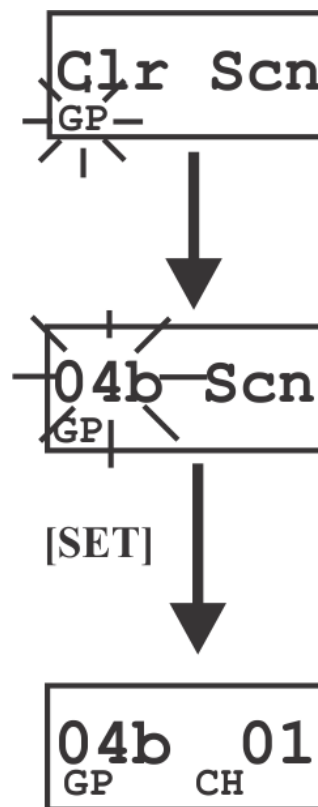

END

Stage Announce Enable/Disable

- Press and hold [SET] then press the [SA] button to show the SA enable/disable screen. The current setting of the feature is displayed on the LCD display.
- While continuing to hold [SET] press [SA] again to toggle the display from ON to OFF or back. Release the [SET] button to accept the current displayed setting and return to the Group /Channel screen.

NOTE: When SA is enabled and pressed, whatever is on; A talk, B talk, or both goes out. No audio channels show active when SA is pressed.

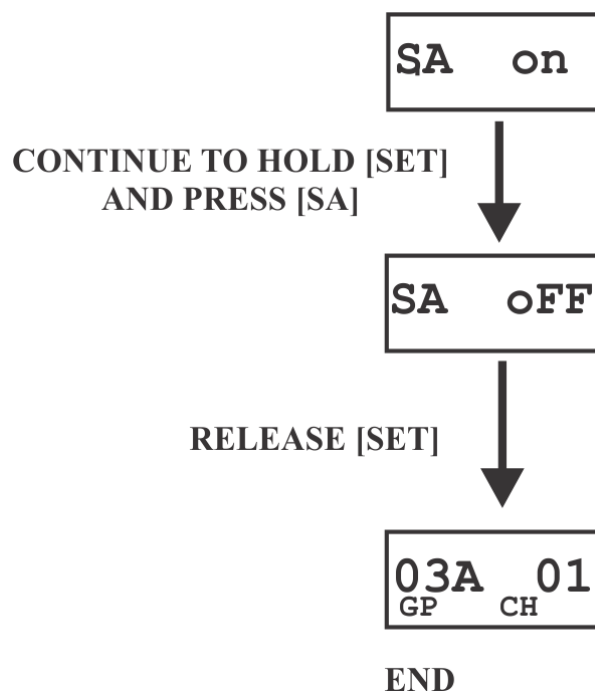

Wireless Talk Around

- Press and hold [SET] then press the [WTA] button to show the WTA menu screen. The current setting of the feature is displayed on the LCD display. The first screen to the right is currently set to a default of A channel, non-latching.
- While continuing to hold [SET] press [WTA] again to go to the next selection; Talk Around = B channel, non-latching.
- Talk Around = A+B channels, non-latching.
- Talk Around = Push-Button, non-latching. Whatever talk button is active becomes wireless talk around.
- Talk Around = A channel, latching.
- Talk Around = B channel, latching.
- A+B channels, latching.
- Talk Around = Push-Button, latching. Whatever talk button is active becomes wireless talk around.
- While continuing to hold [SET], press [SA] once again to display the final menu option Talk Around = Off. Release the [SET] button on any of the above screens to accept the current displayed setting and return to the Group/Channel screen.

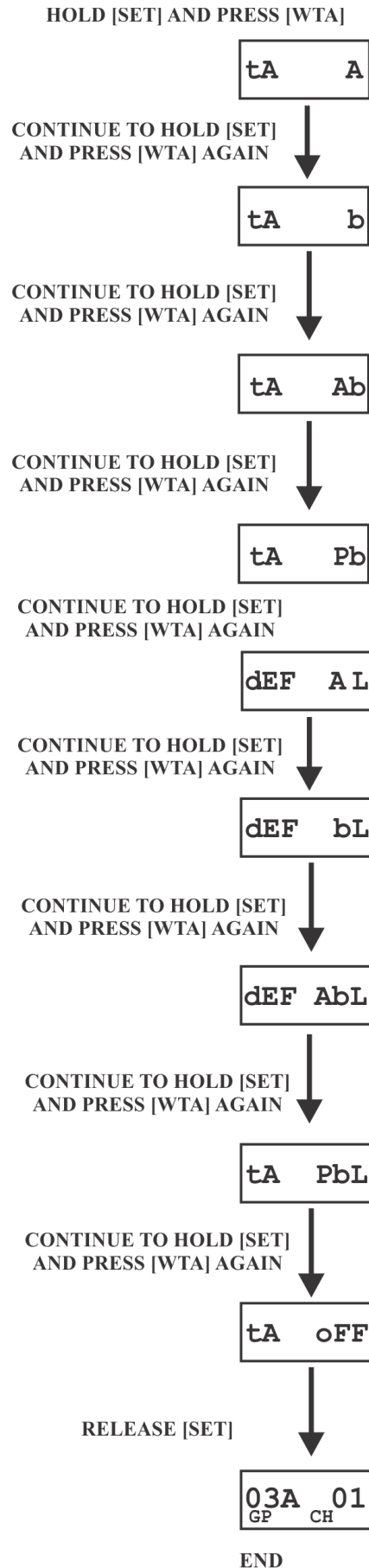

Audio Channel A Options

- Press and hold [SET] then press [A] button to show the channel A menu screen. The current setting of the button is displayed on the LCD display; Channel A Talk-Latching Off.
- While continuing to hold [SET], press the [A] button again to move to the next option; Channel A Talk-Latching On.
- As you continue to hold [SET], press the [A] button once more to move to the next option, Channel A Off.
- Release the [SET] button to accept the current displayed setting and return to the Group/Channel screen.

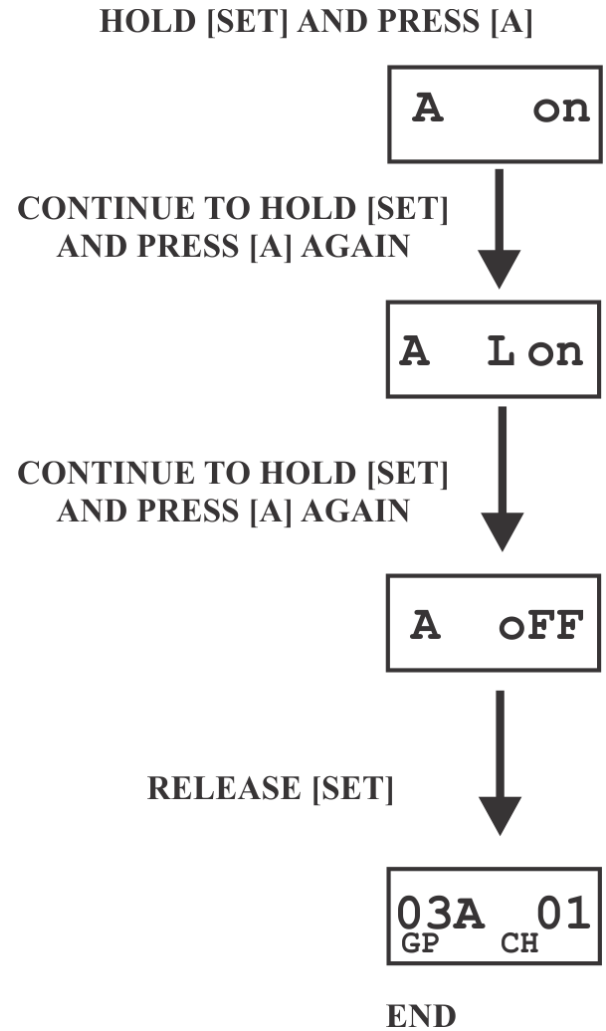

Audio Channel B Options

- Press and hold [SET] then press the [B] button to show the channel B menu screen. The current setting of the button is displayed on the LCD display; Channel B Talk-Latching Off.
- While continuing to hold [SET], press the [B] button again to move the next option; Channel B Talk-Latching On.
- As you continue to hold [SET], press the [B] button once more to move to the next option, Channel B Off.
- Release the [SET] button to accept the current displayed setting and return to the Group/Channel screen.

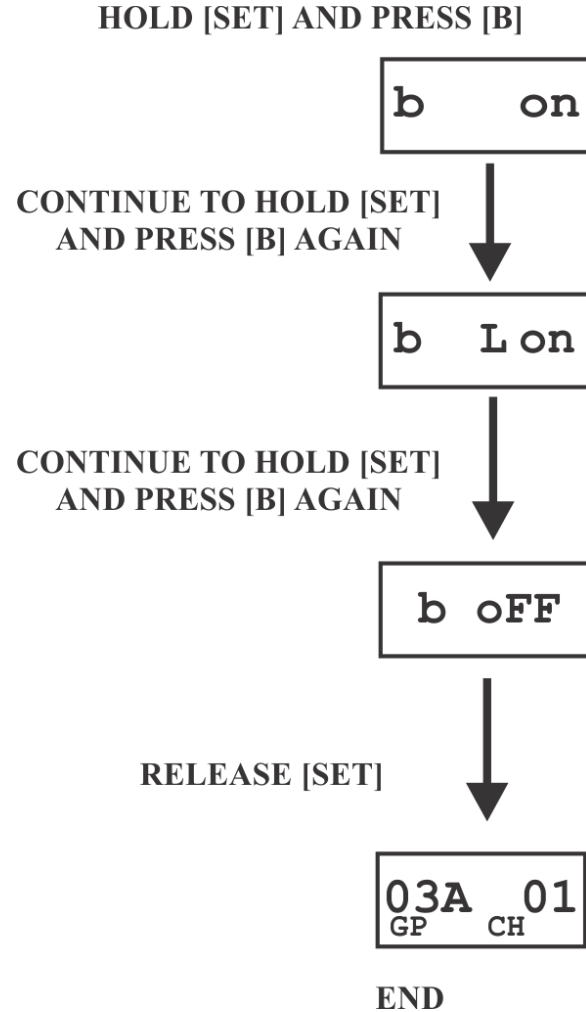

Special Key Sequences

Lockout

- Press [UP]/[DOWN] for three seconds to lock or unlock the beltack. The words “Loc on” will be displayed when the feature is activated, “Loc off” will be displayed when the beltack is unlocked. Pressing [MENU] will still function to view screens, but [SET] will no longer start any editing. ClearScan™, First use, Factory default, and Feature enable/disable are no longer accessible. The words “Loc out” will be flashed on the screen if any editing is attempted during lockout.

1st Use Default

- Press [MENU] while turning on the beltack to enter the 1st use default setup screen. This places the unit on group 01A with channel 01 flashing. **Any user-programmed frequencies that had been entered previously are retained.** The beltacks must now be set to different transmit channels using the [UP]/[DOWN] buttons. Then the [SET] button is pressed to place the units on those channels. If lockout had been activated, the beltack comes up where it was last left regardless of [MENU] being pressed on power-up.

Factory Default

- Pressing all four buttons [MENU]+[SET]+[UP]+[DOWN] at the same time places the unit on group 01A with channel 01 flashing, just like beltack 1st use default, except the **all user-programmed frequencies that had been entered previously are erased.** The beltacks must now be set to different transmit channels using the [UP]/[DOWN] buttons. Then [SET] is pressed to place the units on those channels. If lockout had been activated, the beltack comes up where it was last left regardless of these four keys being pressed.

System Walk-Thru

Now that you have successfully set up your RTS Wireless Intercom System and turned on any auxiliary equipment, you are ready to test the overall performance by walking the RTS system through the areas in which you will be using it.

Before you begin your walk-thru, check the following:



Beltpack Battery Check.



Set microphone gain in both the beltpack(s) and the base station.



The base station and beltpack(s) are on the same group and the beltpack(s) are on their own unique transport channels that match the base station receive channels.



Check that the talk button is engaged. The talk LED will be illuminated.



Intercom Level IN and OUT are set to an appropriate level.



Auxiliary Level IN and OUT are set to an appropriate level (if used).

The system walk-thru can detect the problem of weak signal strength caused by:

- Poor antenna location
- Wrong antenna for receiver and/or transmitter
- RF trouble spots
- Operating distance beyond system capability
- Old or used batteries in the TR-8XX

Under normal conditions, the base station's display will indicate a beltpack status. Weak Signal condition will result in "no tx" being displayed on the base station's receiver for that beltpack.

In 99% of all instances you will set up your RTS Wireless Intercom System, walk it through the area of interest and achieve error-free performance. If in the rare instance, your RTS system does not pass during your walk-thru evaluation, refer to the section of this manual which deals with System Troubleshooting.

Troubleshooting

Reread the sections of this manual to make sure you have completed system set up properly

If you are unable to solve the problem, contact the dealer from whom you purchased the system for assistance.

PROBLEM	SOLUTION
DISTORTION - System's audio quality seems distorted at medium to high input levels.	Reduce microphone gain by adjusting microphone gain control.
HISS - System seems to produce a "hiss" which is undesirable.	Check the gain setting on all beltacks and the base. They may be too low or too high. Check to make sure you are still well within range of the base station.
LOW OUTPUT - System produces a low output level.	Check the gain setting on both the beltacks and the base. They may be too low.
FEEDBACK - Moving around area of use produces "squeal" or "howl" in various locations using ext. speakers.	Reduce the gain settings on both the beltacks and the base. They may be too high.
DROPOUTS - When moving around the area of use there seems to be locations where the signal swooshes or completely disappears	Make sure both antennas on the base and beltack are connected and follow the location suggestions. Change the location of the base unit and antennas or avoid the bad areas with the remote beltacks.
INTERFERENCE - System picks up signals other than wireless intercoms.	Make sure that all the RTS beltack(s) are on. If there are any unused receivers at the base, turn the audio off from those receivers by deselecting the appropriate Portable Station Connect button. If problems persist with the beltack on, you will probably need to change the group. Make sure the base and beltack match after any Group/Channel change.
NO AUDIO from BASE or BELTPACK headsets.	Check Transmitter switch on base and beltack. Check talk LED to make sure it is on. Make sure beltack batteries are OK.
BASE and BELTPACK'S Frequencies Don't Match - In the display frequencies screen of the base and the menu of the beltack the frequencies don't match.	Ensure the units are on the correct Group and Channels. If three band base and beltack units and in the US make sure you have switched the base station to the US channel map, see "Troubleshooting" on page 75.

Frequency Interaction

Unfortunately, radio frequency (RF) channels cannot be randomly selected for use in radio devices. They must be selected to avoid known frequencies in use, FCC restrictions on the location of devices, and even interference between your own RF devices. The factory defined frequencies (Groups 01A-24) selected by RTS for this wireless system are chosen to minimize possible interference.

Microphone Gain Adjustment

The microphone gain controls on the base station and beltpack are set to mid-levels by the factory. In most cases this setting will work fine and only on loud speech will the over-modulation (OM) indicator light. However, in environments where the background noise is loud or the user has a strong/quiet voice, the gain control will need to be adjusted. In Figure 40 the gain is set correctly. The user's root-mean-square (RMS) sound level is well below the OM threshold and only on peaks does his or her voice flash the OM indicator light.

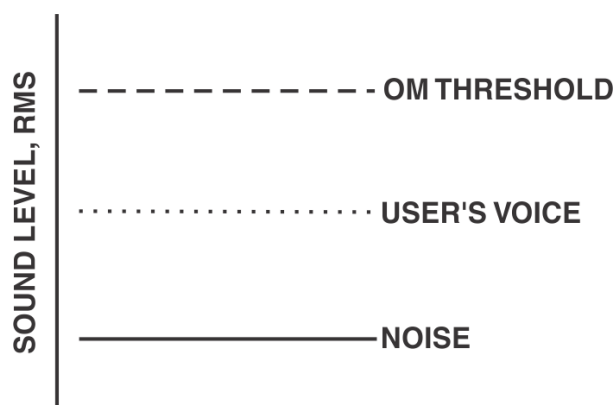

FIGURE 40. Low Noise Environment Microphone Gain Set Correctly

system is distortion on louder speech. The microphone gain must be reduced. The same applies to a user with a powerful voice. If someone sets the system mic gain to their voice and user has a much stronger voice, then the gain will need to be reduced, even if the background noise is the same.

Always remember to set the microphone gain based on the situation and location in which the equipment will be used. If the equipment is used on the field during a football game, set the gain based upon a loud stadium, NOT a quiet stadium 2 hours before a game. If a production studio user has a quiet voice, set the gain to their voice and NOT the stage hand's loud voice who helped set up the system.

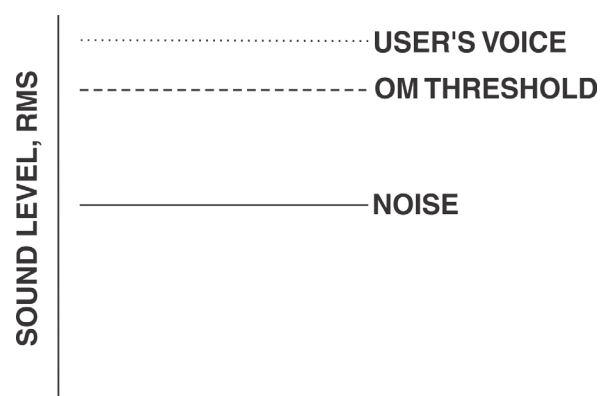

FIGURE 41. High Noise Environment Microphone Gain Set Too High

Figure 41 displays the same gain setting as in Figure 40 but brought into a high noise environment. The user's voice now lights the OM indicator all the time he or she speaks due to the higher noise plus the user speaking louder. The result on the

Battery Information

Improper battery selection, use, installation and care are the cause of numerous wireless system failures.

Alkaline Batteries: Alkaline batteries such as Eveready's ENERGIZER®¹ and ENERGIZER INDUSTRIAL provide the most reliable operation in wireless transceivers.

The use of low cost carbon-zinc batteries is NOT recommended.

Nickel-Metal Hydride Batteries - These batteries can save you money in the long run, as they can be recharged. Typical battery life is a little less than the length of time alkaline batteries last.

Cold Temperatures and Batteries

The battery life times listed in this section are at room temperature. Alkaline and Nickel-Metal Hydride battery service hours fall off significantly at low temperature due to battery chemistry. Alkaline batteries typically have less than half their room temperature service life if used at freezing 32° F (0° C). If you use Alkaline and Nickel-Metal Hybrid batteries at low temperatures, you need to change them more often.

Another solution is using Lithium AA cells if belt packs are to be used in very cold temperatures. Lithium batteries, like the Energizer Ultimate Lithium AA cells, are excellent batteries for cold temperatures. At 15° F (-9° C), Lithium AA cells will last about seven times longer than Alkaline batteries. This equates to two hours for Alkaline vs. 14 hours for Lithium. However, the trade off is Lithium batteries cost more and are less environmentally-friendly than Alkaline batteries.

Battery Life:

TR-800
Alkaline, 11-13 hours, typical
Nickel Metal Hydride, 10-12 hours, typical

TR-825
Alkaline, 8-10 hours, typical
Nickel Metal Hydride, 7-9hours, typical

Battery Warnings

- Do not place alkaline battery packs in any battery charger. Severe charger and battery pack damage may occur.
- Batteries that have been dropped, or otherwise damaged, should not be used and should be discarded properly.
- Dropping batteries can crack the internal casing causing leakage or rupture resulting in personal injury or property damage!
- Insert batteries properly, with the plus (+) and minus (-) terminals aligned correctly!
- Do not mix old and new batteries, batteries of different types, or batteries of different brands. This can cause leakage or rupture, resulting in personal injury or property damage!
- Immediately remove exhausted batteries from the battery pack and dispose of properly.
- Replace all used batteries in your device at the same time.
- Do not put batteries or battery-powered devices in very warm places. Extreme temperatures reduce battery performance and may also lead to leakage.
- Use only high quality AA-sized batteries in the battery packs.
- When not in use, disconnect battery pack, remove and store batteries in a cool, dry place at normal room temperature until ready to use.
- Keep battery contact surfaces clean by gently rubbing with a clean pencil eraser or cloth.

1. Energizer® is a registered trade mark of Union Carbide Corporation.

Intercom Systems Specifications

RTS

Input Impedance:	200 Ω
Output Level:	0.775 Vrms nominal
Bridging Impedance:	>10kW
Call Signaling:	
Send:	20 kHz \pm 100 Hz, 240 mVrms
Receive:	20 kHz \pm 800 Hz, 100 mVrms
Power Voltage:	28.0 VDC nominal

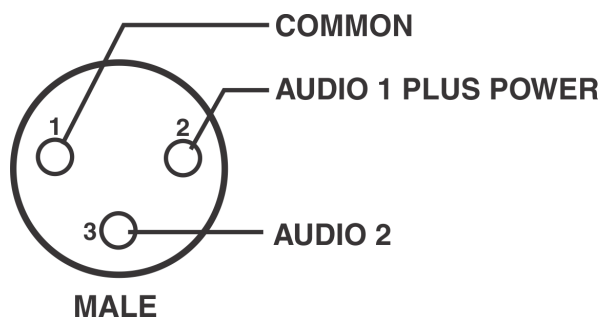

Audiocom/Telex

Input Impedance:	300 Ω
Output Level:	1.0 Vrms nominal
Bridging Impedance:	>10kW
Call Signaling:	
Send:	20 kHz \pm 100 Hz, 05 mVrms
Receive:	20 kHz \pm 800 Hz, 100 mVrms
Power Voltage:	24.0 VDC nominal

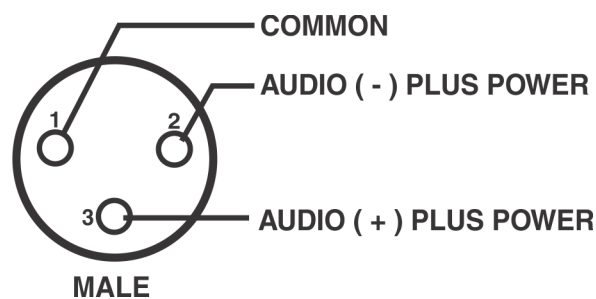

Clear-Com

Input Impedance:	200 Ω
Output Level:	1.0 Vrms nominal
Bridging Impedance:	>10kW
Call Signaling:	
Send:	12 \pm 3VDC
Receive:	4 VDC minimum
Power Voltage:	30.0 VDC nominal

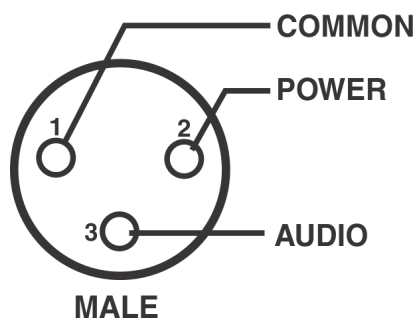

Accessories and Replacement Parts

ALP-600

520-760 mHz Bi-Directional Log Periodic Antenna
Includes mounting hardware and 10 feet (3 meters) of
coaxial cable with TNC Connectors.

PN 878896

ALP-450

450-900 mHz Log Periodic Antenna
Includes mounting hardware and 10 feet (3 meters) coaxial
cable with TNC connectors.

Order No. 71147000

Antenna Cables

Special low loss antenna cables with TNC Connectors

Model No.	Length	Order No.
CXU-10	10 Ft (3 meters)	690419
CXU-25	25 Ft (7.6 meter)	71151-025
CXU-50	50 Ft (15 meter)	71151-050
CXU-75	75 Ft (23 meter)	71151-075
CXU-100	100 Ft (30 meter)	71151-100

AB-2

Bracket for 1/2-wave Antenna with 10ft. of coax

PN 71138000

BTR Power Cords

North America	550024013
U.K.	550024002
European	550024000
Australian	550024018

BTR Intercom Dummy Load

Audiocom (TELEX) type	PN 878935
RTS type	PN 878990

**SA Relay screw plug
adapter** PN 2862046

TR LCD/switch cover PN 450364

BP-700 TR Battery pack, alkaline
(batteries not included) PN 71315-000

BP-800NM TR Nickel-Metal Hydride 2200mAh
Battery pack PN 71315-002

BC-800NM4

Four Slot "Smart"
Charger with Nickel Metal
Hydride Battery Packs

US/Canada PRD00007008
EURO PRD00007009

BC-800NM

Single Slot "Smart"
Charger with Nickel Metal
Hydride Battery Packs

US/Canada PRD00007006
EURO PRD00007007

Certification Information

FCC

The RTS BTR-800, TR-800, and the TR-825 Transmitter/Receiver are Type Accepted under United States Federal Communications Commission Part 74. Part 74 licensing of the equipment is the User's responsibility and licensibility depends on the user's classification, users application, and frequency selected. Bosch strongly urges the user to contact the appropriate telecommunications authority for any desired clarification.

The device complies with Part 15 of the FCC Rules. this device complies with part 15 of the FCC Rules. Operation is subject to the following tow conditions: (1) This device may not cause harmful interference, and (2) this device must accept any interference that may cause undesired operation.

CAUTION: Changes or modifications made by the user could void the user's authority to operate the equipment.

NOTE: This wireless microphone system can be configured for both FCC Part 15 (unlicensed) and FCC Part 74 (licensed) operation. When shipped from the factory, this wireless microphone system is configured for unlicensed operation, and will operate at a power level not to exceed 50 milliwatts, which meets FCC Part 15 requirements. If unlicensed users operate this device in excess of 50 milliwatts, harmful interference may result and the unlicensed user will be subject to substantial monetary forfeitures and other FCC sanctions. The wireless microphone system may be operated by holders of a valid FCC license in the Low Power Auxiliary Radio Service under Part 74 of FCC Rules, at power levels between 50 milliwatts and 250 milliwatts.

Mandatory Safety Instructions to Base Station Installers and Users

1. Use only manufacturer or dealer supplied antenna. Antenna minimum safe distance, as calculated from FCC requirements, is 4.8 cm. However, the FCC default for the minimum safe distance is 20 cm. Antenna gain: zero dBd referenced to a dipole.
2. The FEDERAL COMMUNICATIONS COMMISSION has adopted a safety standard for human exposure to RF (Radio Frequency) energy, which is below the OSHA (Occupational Safety and Health Act) limits.
3. To comply with current FCC RF Exposure limits, the antenna must be installed at or exceeding the minimum safe distance shown here, and in accordance with the requirements of the antenna manufacturer or supplier.
4. Antenna substitution: Do Not substitute any antenna for the one supplied by or recommended by the manufacturer or radio dealer. You may be exposing person or persons to harmful radio frequency radiation. You may contact your radio dealer or the manufacturer for further instructions.
5. **WARNING:** Maintain a separation distance from the antenna to person(s) of at least 20 cm.

You, as the qualified end-user of this radio device must control the exposure conditions of bystanders to ensure that the minimum separation distance (above) is maintained between the antenna and nearby persons for satisfying RF Exposure compliance.

The operation of this transmitter must satisfy the requirements of the Occupational/Controlled Exposure Environment for work-related use. Transmit only when person(s) are at least the minimum distance from the properly installed, externally mounted antenna.

Europe

Versions of the BTR-800, TR-800, and TR-825 which display the “CE” symbol on the unit are compliant to the 2014/53/EU RED directive. These units conform to European Union directives, eligible to bear CE marking.

The full EC Declaration of Conformity for the BTR-800, TR-800, and TR-825 products may be found at the following website:

www.rtsintercoms.com

The equipment is in compliance with the following directives;

2015/863	RoHS Directive
2012/19/EU	WEEE Directive
2014/53/EU	RED Directive



Please dispose of the base station and belt packs at the end of its operation life by taking it to your closest collection point or recycling center.

This equipment is intended for use in professional audio intercom applications.

Some countries in the EEA (European Economic Area) have restrictions placed on this equipment. Listed below are these restrictions:

The equipment requires a license in the following countries (ISO 3166-1 two letter country code):

AT, BE, BG, HR, EE, FI, DE, GR, IS, IE, IT, LV, LI, LT, LU, MT, PL, PT, SK, SE, CH, GB.

The BTR-800 must be set to meet the 50 mW ERP maximum output power in the following countries (ISO 3166-1 two letter country code): AT, BE, BG, HR, EE, CY, DK, DE, FR, GR, HU, IS, IE, IT, LV, LI, LT, LU, MT, NL, NO, PL, RO, SK, SE, SI, ES, CH, GB.

France (FR): The use of equipment requires a license if not a professional user.

Austria (AT), Belgium (BE), and Germany (DE): Equipment may only be used in the 470-703 MHz band.

Finland (FI) and Iceland (IS): Equipment may only be used in the 470-694 MHz band.

Netherlands (NL): Equipment may NOT be used in the 556-558 MHz band.

Norway (NO): Equipment may only be used in the 510-790-MHz band.

Always consult your national authority before placing equipment into operation as requirements and spectrum usage can change.

Industry Canada

The RTS BTR-800, TR-800, TR-825 transmitter/receiver are certified to Industry Canada RSS-123 rules.

Licensing of Bosch equipment is the users responsibility and depends upon the user’s classification, user’s application and frequency selected. Bosch strongly urges the user to contact the appropriate telecommunications authority for any desired clarification.

Pour se conformer aux exigences FCC et Industrie Canada l'exposition aux RF sur une distance de separation d'au moins 20 cm (7,9 pouces) doit etre maintenue entre les antennes de la station de base BTR-800 et toutes les personnes.

CAUTION: Any changes or modifications made to the above equipment could void the user's authority to operate the equipment.

ATTENTION: Tout changement ou modification non expressement approuvee par la partie responsable de la conformite pourraient annuler l'autorite de l'utilisateur a utiliser cet equipement.

Three Band Base Stations

Identifying a Three Band Unit

Three band base stations normally have a 18 MHz wide receive range of 650-668 MHz. These three band base stations are designated by having a 3 in the second digit of the two digit band code that is on a label on the rear panel of the unit.

Regulatory Changes and the Three Band

There are two channel map configurations in a three band base station. One for the US/Canada and one for the rest of the world. At one time (before October, 2018) there was only one channel map for a three band unit, but due to regulatory changes in the US/Canada an additional map was produced and installed in three band base stations. The result of the FCC incentive auction in regard to wireless intercom was the following:

- Only 10 MHz (653-663 MHz) may be used for wireless intercom in the range 616 MHz to 698 MHz.
- Three band beltpack transmit power must be reduced to 20 mW EIRP for US/Canadian units.

Since the three band units are made for worldwide customers the 18 MHz range is the default shipped, therefore a US/Canadian user must set a base station to the new US channel map in order for the base's channel map to match the US three band beltpack's channel map. The US three band beltpacks only have the new US channel map in them.

NOTE: Only US/Canadian users of a three band base station need to change the channel map of the base station to the US channel map!

Changing Channel Maps

A three band base station may be changed from a normal channel map to a US channel map and back again with the press of a couple buttons. The current channel map setting is remembered by the unit even if power is removed.

1. At the base station's main operating screen, press and hold the [SET]+[UP] buttons until the switching band text is displayed.
The three band map the unit is switch to is displayed.
2. Release the buttons when the switching three band text is displayed.

The unit reboots and displays one of the following channel map versions.

x30001 = Normal three band channel map

x3U001 = US three band channel map

(where x is the current transmit band of the base station.)

Bosch Security Systems, Inc.

12000 Portland Avenue South

Burnsville, MN 55337 U.S.A.

www.rtsintercoms.com