

RF TEST REPORT

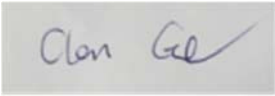

Report No.: RF_FCC_IC_SL16110101-BSS-004-FP
 Supersede Report No.: None

Applicant	Bosch Security Systems, Inc	
Product Name	Roameo Access Point	
Model No.	AP-1800	
Test Standard	FCC Part 15 Subpart D: 2014 RSS-213 Issue 3, March 2015 RSS-Gen Issue 4, November 2014	
Test Method	ANSI C63.4: 2014; ANSI C63.17: 2013	
FCC ID	B5DM534	
IC ID	1321A-AP1800	
Date of test	03/11/2017-03/17/2017	
Issue Date	03/24/2017	
Test Result	<input checked="" type="checkbox"/> Pass <input type="checkbox"/> Fail	
Equipment complied with the specification		[x]
Equipment did not comply with the specification		[]
<i>Gary Chou</i>		
Gary Chou	Chen Ge	
Test Engineer	Engineer Reviewer	
This test report may be reproduced in full only Test result presented in this test report is applicable to the tested sample only		

Issued By:
SIEMIC Laboratories
 775 Montague Expressway, Milpitas, 95035 CA



775 Montague Expressway, Milpitas, CA 95035, USA • Phone: (+1) 408 526 1188 • Facsimile (+1) 408 526 1088

Visit us at: www.siemic.com; Follow us at: 

Laboratory Introduction

SIEMIC, headquartered in the heart of Silicon Valley, with superior facilities in US and Asia, is one of the leading independent testing and certification facilities providing customers with one-stop shop services for Compliance Testing and Global Certifications.



In addition to testing and certification, SIEMIC provides initial design reviews and compliance management throughout a project. Our extensive experience with China, Asia Pacific, North America, European, and International compliance requirements, assures the fastest, most cost effective way to attain regulatory compliance for the global markets.

Accreditations for Conformity Assessment

Country/Region	Accreditation Body	Scope
USA	FCC, A2LA	EMC, RF/Wireless, Telecom
Canada	IC, A2LA, NIST	EMC, RF/Wireless, Telecom
Taiwan	BSMI, NCC, NIST	EMC, RF, Telecom, Safety
Hong Kong	OFTA, NIST	RF/Wireless, Telecom
Australia	NATA, NIST	EMC, RF, Telecom, Safety
Korea	KCC/RRA, NIST	EMI, EMS, RF, Telecom, Safety
Japan	VCCI, JATE, TELEC, RFT	EMI, RF/Wireless, Telecom
Mexico	NOM, COFETEL, Caniety	Safety, EMC, RF/Wireless, Telecom
Europe	A2LA, NIST	EMC, RF, Telecom, Safety
Israel	MOC, NIST	EMC, RF, Telecom, Safety

Accreditations for Product Certifications

Country	Accreditation Body	Scope
USA	FCC TCB, NIST	EMC, RF, Telecom
Canada	IC FCB, NIST	EMC, RF, Telecom
Singapore	iDA, NIST	EMC, RF, Telecom
EU	NB	EMC & R&TTE Directive
Japan	MIC (RCB 208)	RF, Telecom
Hong Kong	OFTA (US002)	RF, Telecom

CONTENTS

1	REPORT REVISION HISTORY.....	4
2	EXECUTIVE SUMMARY	5
3	CUSTOMER INFORMATION	5
4	TEST SITE INFORMATION.....	5
5	MODIFICATION.....	5
6	EUT INFORMATION.....	6
6.1	EUT Description	6
6.2	Radio Description	6
6.3	EUT Photos - External.....	8
6.4	EUT Photos - Internal.....	10
6.5	EUT Test Setup Photos.....	11
7	SUPPORTING EQUIPMENT/SOFTWARE AND CABLING DESCRIPTION	12
7.1	Supporting Equipment.....	12
7.2	Test Software Description.....	12
8	TEST SUMMARY FOR *FP	13
9	MEASUREMENT UNCERTAINTY	14
9.1	Conducted Emissions	14
9.2	Radiated Emissions (30MHz to 1GHz)	14
9.3	Radiated Emissions (1GHz to 40GHz).....	15
9.4	RF conducted measurement.....	15
10	MEASUREMENTS, EXAMINATION AND DERIVED RESULTS.....	16
10.1	Conducted Emissions	16
10.2	Antenna Requirement.....	19
10.3	Emission Bandwidth	20
10.4	Peak Transmit Power	22
10.5	Power spectral density.....	25
10.6	In-band and Out-of-band emissions.....	28
10.7	Radiated Spurious Emissions Out-of-band emissions	32
10.8	Carrier Frequency Stability.....	34
10.9	Frame repetition Stability, period and jitter.....	35
10.10	Automatically discontinue transmission	36
10.11	Specific requirements for devices operating in the 1920-1930MHz sub-band.....	37
	ANNEX A. TEST INSTRUMENT	48
	ANNEX B. SIEMIC ACCREDITATION	49

1 Report Revision History

Report No.	Report Version	Description	Issue Date
RF_FCC_IC_SL16110101-BSS-004_FP	None	Original	03/24/2017

2 Executive Summary

The purpose of this test program was to demonstrate compliance of following product

Company: Bosch Security Systems, Inc.
Product: Roameo Access Point
Model: AP-1800

against the current Stipulated Standards. The specified model product stated above has demonstrated compliance with the Stipulated Standard listed on 1st page.

3 Customer information

Applicant Name	:	Bosch Security Systems, Inc.
Applicant Address	:	8601 East Cornhusker Hwy, Lincoln, Nebraska 68507
Manufacturer Name	:	Bosch Security Systems S.A.
Manufacturer Address	:	EN 109 Lugar da Pardala, Zona Industrial de Ovar 3880-728 Ovar Portugal

4 Test site information

Lab performing tests	SIEMIC Laboratories
Lab Address	775 Montague Expressway, Milpitas, CA 95035
FCC Test Site No.	881796
IC Test Site No.	4842D-2
VCCI Test Site No.	A0133

5 Modification

Index	Item	Description	Note
-	-	-	-

6 EUT Information

6.1 EUT Description

Product Name	Roameo Access Point
Model No.	AP-1800
Trade Name	RTS
Serial No.	04525036591505105
Host Model No.	-
Input Power	12VDC VDC @ 1.5A
Power Adapter Manu/Model	GlobTek, Inc., GT-41080-1817.9-5.9
Power Adapter SN	WR9QE15000LL2PFERNR/B
Hardware version	B2
Software version	0.0.300
Date of EUT received	03/01/2017
Equipment Class/ Category	DECT
Clock Frequencies	24.0 MHz, 25.0 MHz, 13.824 MHz, 48 kHz, 100 Hz, 32.768 kHz, 0.25 Hz
Port/Connectors	2 x RJ-45 Ethernet ports, 1 x Optical SFP port, 1 x 2.5mm x 5.5mm power port, 2 x reverse polarity-SMA-F connectors.

6.2 Radio Description

Spec for DECT

Radio Type	DECT
Operating Frequency	1921.536 MHz-1928.448 MHz
Modulation	GFSK
Channel Spacing	1.728 MHz
Number of Channels	5
Antenna Type	DIPOLE
Antenna Gain	3
Antenna Connector Type	REVERSE SMA
Note	N/A

EUT Power level setting

Mode	Frequency (MHz)	Power setting
CH00	1928.448	Default
CH01	1926.720	Default
CH02	1924.992	Default
CH03	1923.264	Default
CH04	1921.536	Default

6.3 EUT Photos - External

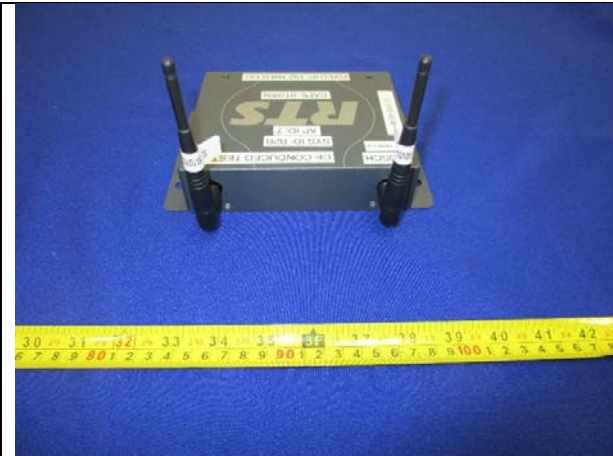

EUT – Front View



EUT – Rear View



EUT – Left View

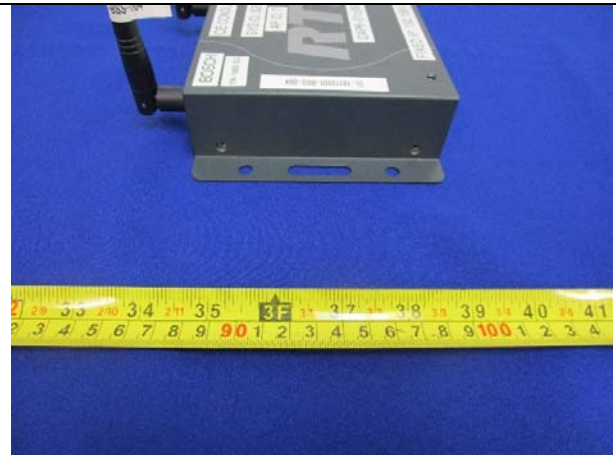

EUT – Right View

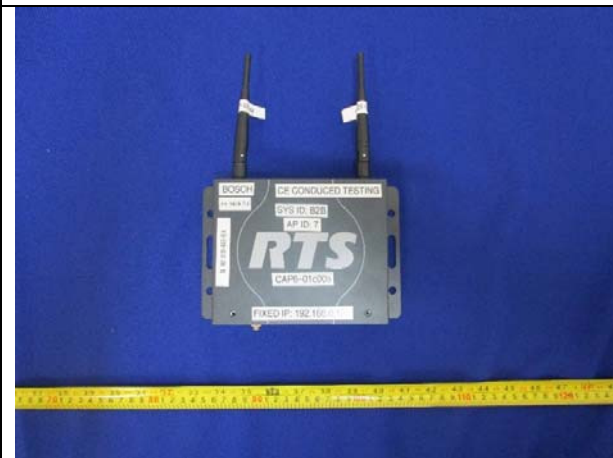

EUT – Top View



EUT – Bottom View



Adaptor View 1



Adaptor View 2



Adaptor Label View

6.4 EUT Photos - Internal



Eut Cover Off View



Main PCB- Top View

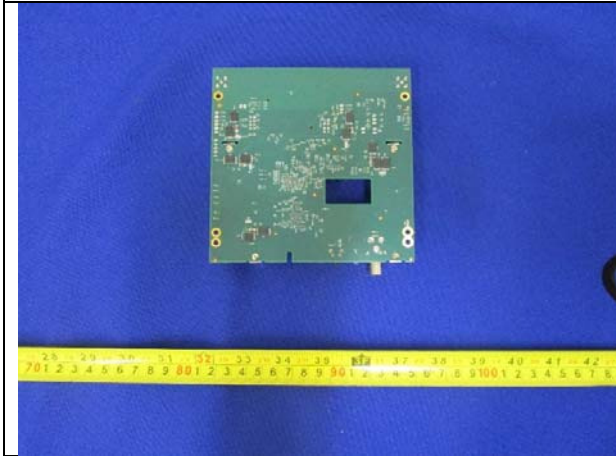

Main PCB - Bottom View

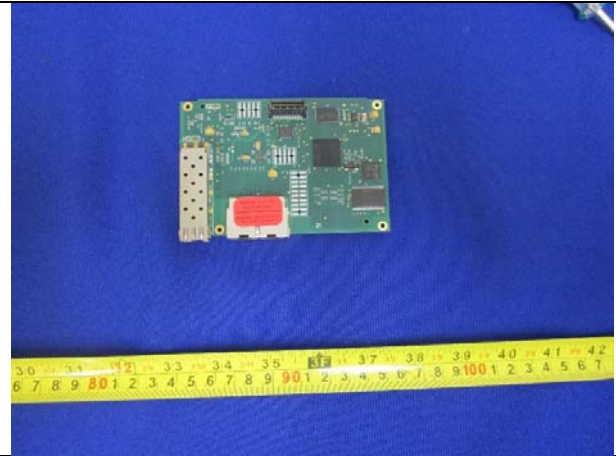

PCB A - Top View

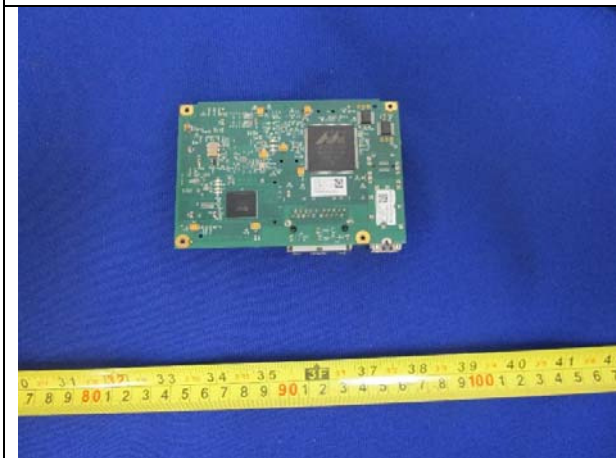

PCB A - Bottom View

6.5 EUT Test Setup Photos

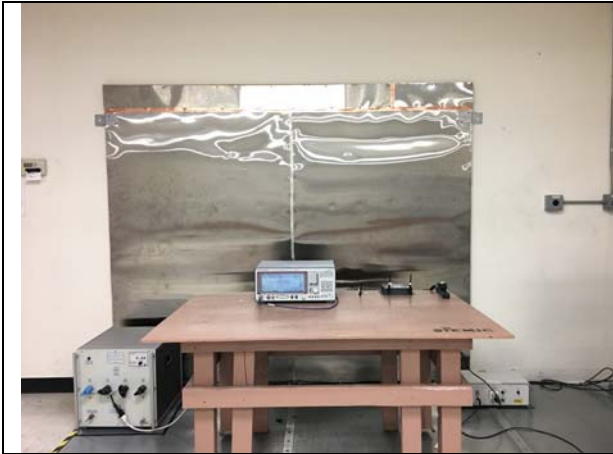

AC Line Conducted Emissions – Front View



AC Line Conducted Emissions – Rear View



Radiated Emissions (<1GHz) – Front View



Radiated Emissions (<1GHz) – Rear View

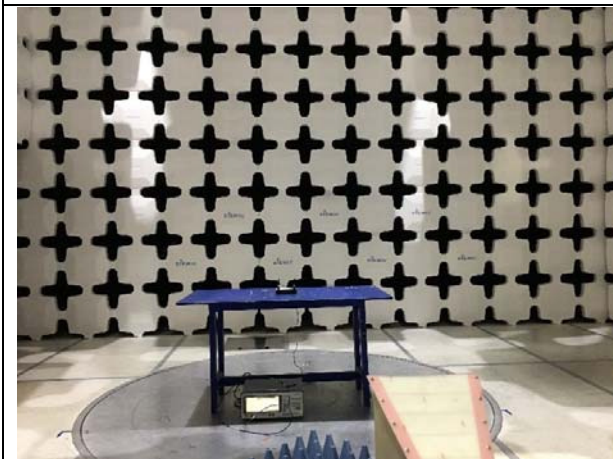

Radiated Emissions (>1GHz) – Front View

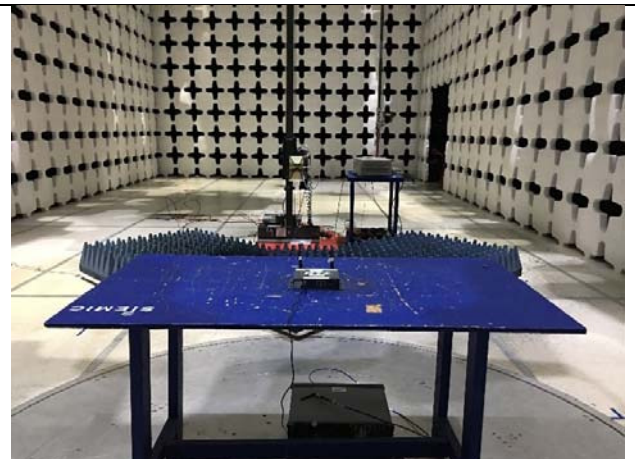

Radiated Emissions (>1GHz) – Rear View

7 Supporting Equipment/Software and cabling Description

7.1 Supporting Equipment

Item	Supporting Equipment Description	Model	Serial Number	Manufacturer	Note
1	Digital Radio communication Tester	CMD60	CCIS0149	R&S	N/A

7.2 Test Software Description

Test Item	Software	Description
N/A	N/A	N/A

8 Test Summary for *FP

Test Item	Test standard	Test Method/Procedure	Pass / Fail
Antenna Requirement	FCC part 15.203	-	<input checked="" type="checkbox"/> Pass <input type="checkbox"/> N/A
AC Conducted Emissions Voltage	15.207(a)	ANSI C63.10 – 2013	<input checked="" type="checkbox"/> Pass <input type="checkbox"/> N/A

Test Item	Test standard		Test Method/Procedure	Pass / Fail
	FCC Part 15 Section	RSS-213/RSS-Gen Clause		
Emission Bandwidth	FCC part 15.323(a)	5.5	ANSI 63.17: 2013 clause 6.1.3	<input checked="" type="checkbox"/> Pass <input type="checkbox"/> N/A
Peak transmit power	FCC part 15.319(c)(e)	5.6	ANSI 63.17: 2013 clause 6.1.2	<input checked="" type="checkbox"/> Pass <input type="checkbox"/> N/A
Power spectral density	FCC part 15.319(d)	5.7	ANSI 63.17: 2013 clause 6.1.5	<input checked="" type="checkbox"/> Pass <input type="checkbox"/> N/A
In-band and Out-of-band emissions	FCC part 15.323(d)	5.8	ANSI 63.17: 2013 clause 6.1.6	<input checked="" type="checkbox"/> Pass <input type="checkbox"/> N/A
Carrier Frequency Stability	FCC part 15.323(f)	5.3	ANSI 63.17: 2013 clause 6.2.1	<input checked="" type="checkbox"/> Pass <input type="checkbox"/> N/A
Frame repetition Stability, period and jitter	FCC part 15.323(e)	5.2(1)(13)	ANSI 63.17: 2013 clause 6.2.2	<input checked="" type="checkbox"/> Pass <input type="checkbox"/> N/A
Monitoring time	FCC part 15.323(c)(1)	5.2(1)	ANSI 63.17: 2013 clause 7.3.4	<input checked="" type="checkbox"/> Pass <input type="checkbox"/> N/A
Monitoring Threshold, Lease Interfered Channel	FCC part 15.323(c)(2)(5)	5.2(2)(3)	ANSI 63.17: 2013 clause 7.3.1, 7.3.2, 7.3.3 and 7.3.4	<input checked="" type="checkbox"/> Pass <input type="checkbox"/> N/A
Monitoring Threshold Bandwidth	FCC part 15.323(c)(7)	5.2(7)	ANSI 63.17: 2013 clause 7.4	<input checked="" type="checkbox"/> Pass <input type="checkbox"/> N/A
Reaction Time and Monitoring Interval	FCC part 15.323(c)(1)(5)(7)	5.2(11)	ANSI 63.17: 2013 clause 7.4	<input checked="" type="checkbox"/> Pass <input type="checkbox"/> N/A
Time and Spectrum Window Access Procedure	FCC part 15.323(c)(4)(6)	5.2(4)(6)	ANSI 63.17: 2013 clause 8.1	<input checked="" type="checkbox"/> Pass <input type="checkbox"/> N/A
Acknowledgements and Transmission Duration	FCC part 15.323(c)(3)(4)	5.2(3)(4)	ANSI 63.17: 2013 clause 8.2	<input checked="" type="checkbox"/> Pass <input type="checkbox"/> N/A
Dual Access Criteria Check	FCC part 15.323(c)(10)	5.2(10)	-	<input type="checkbox"/> Pass <input checked="" type="checkbox"/> N/A**
Alternative Monitoring Interval	FCC part 15.323(c)(11)	5.2(11)	-	<input type="checkbox"/> Pass <input checked="" type="checkbox"/> N/A**
Fair Access	FCC part 15.323(c)(12)	5.2(12)	-	<input type="checkbox"/> Pass <input checked="" type="checkbox"/> N/A**
Remark	<ol style="list-style-type: none"> All measurement uncertainties do not take into consideration for all presented test results. The applicant shall ensure frequency stability by showing that an emission is maintained within the band of operation under all normal operating conditions as specified in the user's manual. 			
Note	<p>*FP: This measurement is necessary only for Fixed Part. *PP: This measurement is necessary only for Portable Part. N/A**: The manufacturer declares that this device does not use any mechanisms as provided by Part15.323 (c) (10) or (c) (11) to extend the range of spectrum occupied over space or time for the purpose of denying fail access to spectrum to other device.</p>			

9 Measurement Uncertainty

9.1 Conducted Emissions

The test is to measure the conducted emissions to the mains port of the EUT.

Some error sources that can contribute to the total uncertainty:

- Uncertainty of the receiver
- Uncertainty of the LISN
- Uncertainty of cables
- Uncertainty due to the mismatches
- Etc, see the below table for details

Source of Uncertainty	Value (dB)	Probability Distribution	Division	Sensitivity Coefficient	Expanded Uncertainty
Receiver Reading	0.12	Rectangular	1.732	1	0.069284
Cable Insertion Loss	0.21	Normal	2	1	0.105
Filter Insertion Loss	0.25	Normal	2	1	0.125
LISN Insertion Loss	0.40	Normal	2	1	0.20
Receiver CW accuracy	0.5	Rectangular	1.732	1	0.2886836
Pulse Amplitude Response	1.5	Rectangular	1.732	1	0.86605081
PRF Response	1.5	Rectangular	1.732	1	0.86605081
Mismatch LISN - Receiver	0.25	U-Shape	1.414	1	0.1768033
LISN Impedance	2.5	Triangular	2.449	1	1.0208248
Combined Standard Uncertainty					1.928133
Expanded Uncertainty (K=2)					3.856266

The total derived measurement uncertainty is +/- 3.86 dB.

9.2 Radiated Emissions (30MHz to 1GHz)

The test is to measure the radiated emissions of the EUT.

Some error sources that can contribute to the total uncertainty:

- Uncertainty of the receiver
- Uncertainty of the antenna
- Uncertainty of cables
- Uncertainty due to the mismatches
- NSA Calibration
- Etc., details see the below table

Source of Uncertainty	Value (dB)	Probability Distribution	Division	Sensitivity Coefficient	Expanded Uncertainty
Receiver Reading	0.12	Rectangular	1.732	1	0.069284
Cable Insertion Loss	0.21	Normal	2	1	0.105
Filter Insertion Loss	0.25	Normal	2	1	0.125
Antenna Factor	0.65	Normal	2	1	0.325
Receiver CW accuracy	0.5	Rectangular	1.732	1	0.2886836
Pulse Amplitude Response	1.5	Rectangular	1.732	1	0.86605081
PRF Response	1.5	Rectangular	1.732	1	0.86605081
Mismatch Filter - Receiver	0.25	U-Shape	1.414	1	0.1768033
NSA Calibration	4.0	U-Shape	1.414	1	2.8288543
Combined Standard Uncertainty					3.0059131
Expanded Uncertainty (K=2)					6.0118262

The total derived measurement uncertainty is +/- 6.00 dB.

9.3 Radiated Emissions (1GHz to 40GHz)

The test is to measure the radiated emissions of the EUT.

Some error sources that can contribute to the total uncertainty:

- Uncertainty of the receiver
- Uncertainty of the antenna
- Uncertainty of cables
- Uncertainty due to the mismatches
- VSWR Calibration
- Etc., details see the below table

Source of Uncertainty	Value (dB)	Probability Distribution	Division	Sensitivity Coefficient	Expanded Uncertainty
Receiver Reading	0.12	Rectangular	1.732	1	0.0692840
Cable Insertion Loss	0.21	Normal	2	1	0.1050000
Filter Insertion Loss	0.25	Normal	2	1	0.1250000
Antenna Factor	0.65	Normal	2	1	0.3250000
Receiver CW accuracy	0.5	Rectangular	1.732	1	0.2886836
Pulse Amplitude Response	1.5	Rectangular	1.732	1	0.8660508
PRF Response	1.5	Rectangular	1.732	1	0.8660508
Mismatch Filter - Receiver	0.25	U-Shape	1.414	1	0.1768033
VSWR Calibration	2.0	U-Shape	1.414	1	1.4144272
Combined Standard Uncertainty					4.2363
Expanded Uncertainty (K=2)					8.4726

The total derived measurement uncertainty is +/- 8.47 dB.

9.4 RF conducted measurement

The test is to measure the RF output power from the EUT.

Some error sources that can contribute to the total uncertainty:

- Uncertainty of the Reference Level Uncertainty
- Uncertainty of variable attenuators
- Uncertainty of cables
- Uncertainty due to the mismatches

Source of Uncertainty	Value (dB)	Probability Distribution	Division	Sensitivity Coefficient	Expanded Uncertainty
Reference Level	0.12	Rectangular	1.732	1	0.069284
Cable Insertion Loss	0.21	Normal	2	1	0.105
Attenuator	0.25	Normal	2	1	0.125
Mismatch	0.25	U-Shape	1.414	1	0.1768033
Combined Standard Uncertainty					0.476087
Expanded Uncertainty (K=2)					0.952174

The total derived measurement uncertainty is +/- 0.95 dB.

10 Measurements, Examination and Derived Results

10.1 Conducted Emissions

Conducted Emission Limit

Frequency ranges (MHz)	Limit (dBuV)	
	QP	Average
0.15 ~ 0.5	66 – 56	56 – 46
0.5 ~ 5	56	46
5 ~ 30	60	50

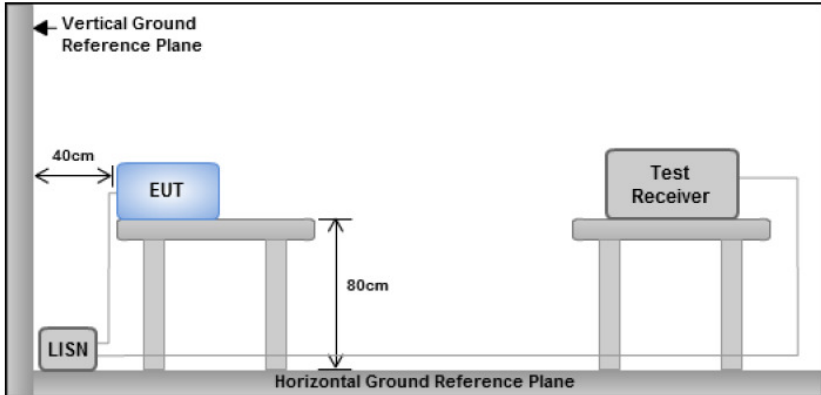
Spec	Item	Requirement	Applicable
47CFR§15.207	a)	For Low-power radio-frequency devices that is designed to be connected to the public utility (AC) power line, the radio frequency voltage that is conducted back onto the AC power line on any frequency or frequencies, within the band 150 kHz to 30 MHz, shall not exceed the limits in the following table, as measured using a 50 μ H/50 ohms line impedance stabilization network (LISN). The lower limit applies at the boundary between the frequency ranges.	<input checked="" type="checkbox"/>
Test Setup	 <p style="text-align: center;">Note: 1. Support units were connected to second LISN. 2. Both of LISNs (AMN) are 80 cm from EUT and at least 80 cm from other units and other metal planes</p>		
Procedure	<ul style="list-style-type: none"> - The EUT and supporting equipment were set up in accordance with the requirements of the standard on top of a 1.5m x 1m x 0.8m high, non-metallic table, as shown in Annex B. - The power supply for the EUT was fed through a 50Ω/50μH EUT LISN, connected to filtered mains. - The RF OUT of the EUT LISN was connected to the EMI test receiver via a low-loss coaxial cable. - All other supporting equipment was powered separately from another main supply. 		
Remark			
Result	<input checked="" type="checkbox"/> Pass <input type="checkbox"/> Fail		

Test Data Yes N/A

Test Plot Yes (See below) N/A

Test was done by Gary Chou at Conducted emission test site.

Conducted Emission Test Results

Test specification:	Conducted Emissions			
Environmental Conditions:	Temp(°C):	25	Result:	<input checked="" type="checkbox"/> Pass <input type="checkbox"/> Fail
	Humidity (%):	40		
	Atmospheric(mbar):	1019		
Mains Power:	120Vac, 60Hz			
Tested by:	Gary Chou			
Test Date:	03/13/2017			
Remarks:	Neutral Line			

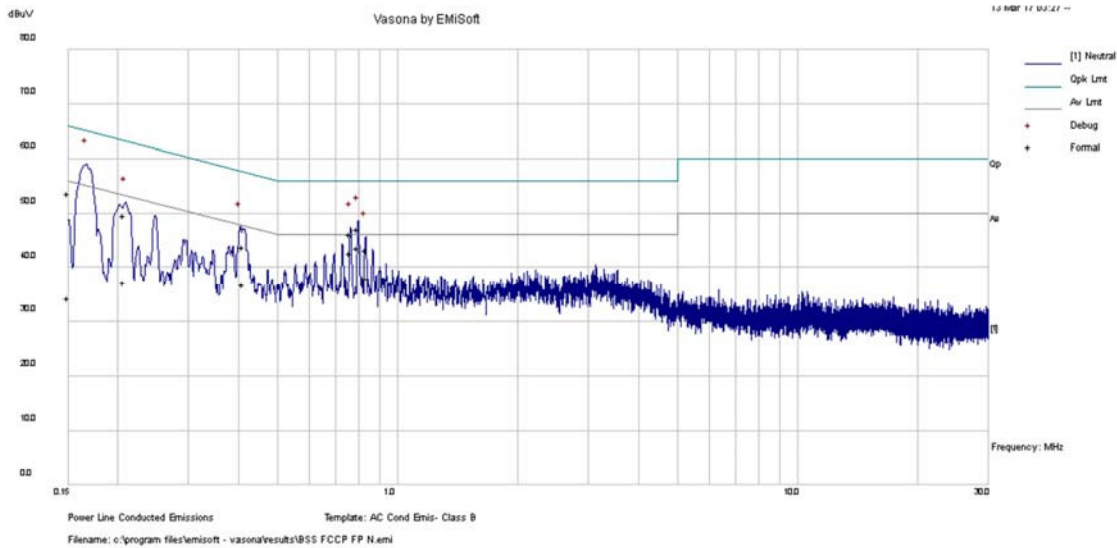

Frequency (MHz)	Raw (dBuV)	Cable Loss (dB)	Factors (dB)	Level (dBuV)	Measurement Type	Line/Neutral	Limit (dBuV)	Margin (dB)	Pass /Fail
0.15	42.01	10.00	1.74	53.75	Quasi Peak	Neutral	66.00	-12.25	Pass
0.80	36.61	10.01	0.55	47.18	Quasi Peak	Neutral	56.00	-8.82	Pass
0.76	35.60	10.01	0.55	46.17	Quasi Peak	Neutral	56.00	-9.83	Pass
0.41	33.05	10.01	0.69	43.75	Quasi Peak	Neutral	57.65	-13.91	Pass
0.83	32.65	10.01	0.54	43.2	Quasi Peak	Neutral	56.00	-12.80	Pass
0.21	38.43	10.00	1.21	49.64	Quasi Peak	Neutral	63.32	-13.68	Pass
0.15	22.70	10.00	1.74	34.44	Average	Neutral	56.00	-21.56	Pass
0.80	32.98	10.01	0.55	43.54	Average	Neutral	46.00	-2.46	Pass
0.76	32.01	10.01	0.55	42.57	Average	Neutral	46.00	-3.43	Pass
0.41	26.11	10.01	0.69	36.81	Average	Neutral	47.65	-10.84	Pass
0.83	27.52	10.01	0.54	38.08	Average	Neutral	46.00	-7.92	Pass
0.21	25.98	10.00	1.21	37.2	Average	Neutral	53.32	-16.12	Pass

Test specification:	Conducted Emissions			Result:	<input type="checkbox"/> Pass <input type="checkbox"/> Fail
Environmental Conditions:	Temp(°C):	25			
	Humidity (%):	40			
	Atmospheric(mbar):	1019			
Mains Power:	120Vac, 60Hz				
Tested by:	Gary Chou				
Test Date:	03/13/2017				
Remarks:	Phase Line				

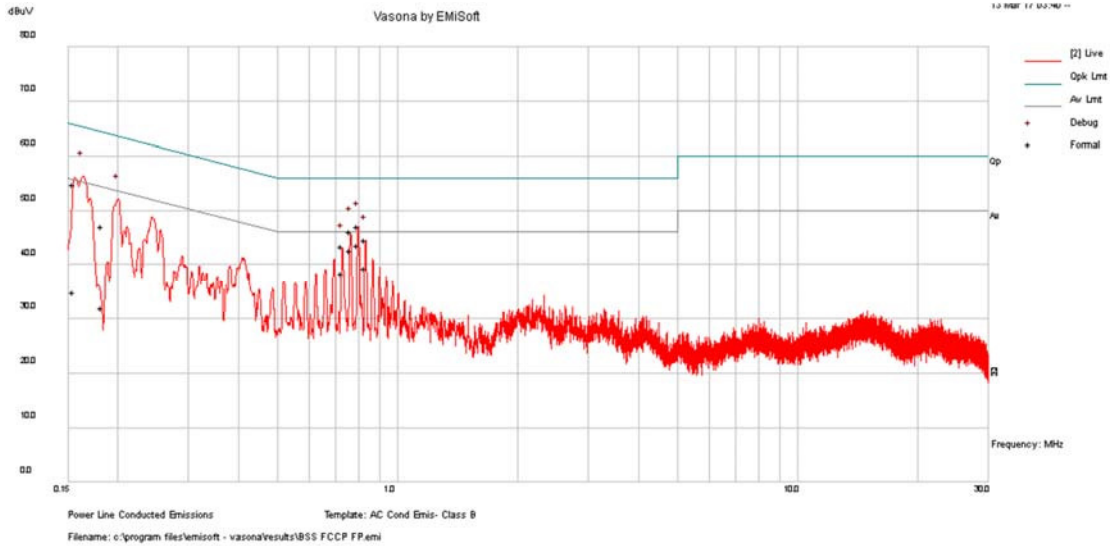

Frequency (MHz)	Raw (dBuV)	Cable Loss (dB)	Factors (dB)	Level (dBuV)	Measurement Type	Line/Neutral	Limit (dBuV)	Margin (dB)	Pass/Fail
0.16	43.17	10.00	1.67	54.85	Quasi Peak	Live	65.71	-10.87	Pass
0.80	36.62	10.01	0.55	47.18	Quasi Peak	Live	56.00	-8.82	Pass
0.76	35.66	10.01	0.55	46.23	Quasi Peak	Live	56.00	-9.77	Pass
0.83	33.97	10.01	0.54	44.53	Quasi Peak	Live	56.00	-11.47	Pass
0.18	35.75	10.00	1.39	47.14	Quasi Peak	Live	64.35	-17.21	Pass
0.73	32.83	10.01	0.56	43.40	Quasi Peak	Live	56.00	-12.60	Pass
0.16	23.20	10.00	1.67	34.87	Average	Live	55.71	-20.84	Pass
0.80	32.97	10.01	0.55	43.53	Average	Live	46.00	-2.47	Pass
0.76	32.06	10.01	0.55	42.63	Average	Live	46.00	-3.37	Pass
0.83	28.91	10.01	0.54	39.47	Average	Live	46.00	-6.53	Pass
0.18	20.61	10.00	1.39	32.00	Average	Live	54.35	-22.34	Pass
0.73	27.92	10.01	0.56	38.49	Average	Live	46.00	-7.51	Pass

10.2 Antenna Requirement

Applicable Standard

According to FCC § 15.203, an intentional radiator shall be designed to ensure that no antenna other than that furnished by the responsible party shall be used with the device. The use of a permanently attached antenna or of an antenna that uses a unique coupling to the intentional radiator shall be considered sufficient to comply with the provisions of this Section. The manufacturer may design the unit so that a broken antenna can be replaced by the user, but the use of a standard antenna jack or electrical connector is prohibited.

Antenna Connector Construction

The antenna of EUT is an Dipole antenna which using unique type of connector, and the best case gain of the antenna is 3 dBi.

The antenna meets up with the ANTENNA REQUIREMENT.

10.3 Emission Bandwidth

Requirement(s):

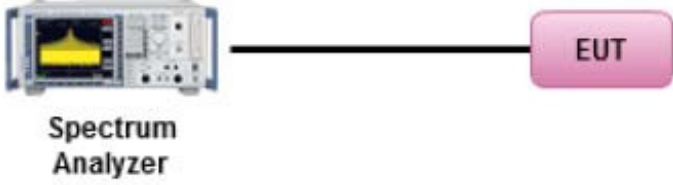
Spec	Requirement	Applicable									
FCC part 15.323(a)	The 26 dB and 99% Bandwidth B shall be larger than 50 kHz and less than 2.5 MHz	<input checked="" type="checkbox"/>									
Test Setup											
Test Procedure	According to ANSI 63.17: 2013 clause 6.1.3										
Test Date	03/11/2017	<table border="1"> <tr> <td>Environmental condition</td> <td>Temperature</td> <td>23 oC</td> </tr> <tr> <td></td> <td>Relative Humidity</td> <td>38 %</td> </tr> <tr> <td></td> <td>Atmospheric Pressure</td> <td>1019 mbr</td> </tr> </table>	Environmental condition	Temperature	23 oC		Relative Humidity	38 %		Atmospheric Pressure	1019 mbr
Environmental condition	Temperature	23 oC									
	Relative Humidity	38 %									
	Atmospheric Pressure	1019 mbr									
Remark	N/A										
Result	<input checked="" type="checkbox"/> Pass <input type="checkbox"/> Fail										

Test Data Yes N/A

Test Plot Yes N/A

Test was done by Gary Chou at RF test site.

Bandwidth measurement result

Channel	Frequency (MHz)	99% Occupied Bandwidth (MHz)	26 dB Bandwidth (MHz)
4	1921.536	1.2366	1.495
2	1924.992	1.2324	1.493
0	1928.448	1.2323	1.495

Bandwidth Test Plots

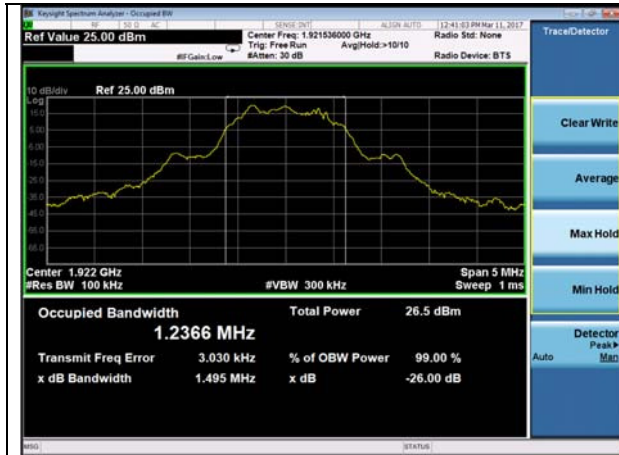

99%OBW -26dB bandwidth-Channel 4



99%OBW -26dB bandwidth-Channel 2



99%OBW -26dB bandwidth-Channel 0

10.4 Peak Transmit Power

Requirement(s):

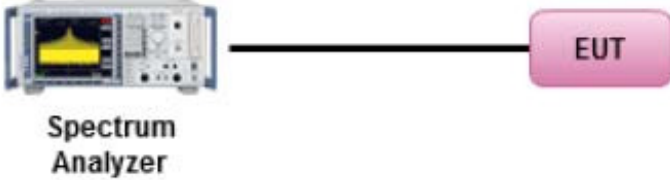
Spec	Requirement	Applicable									
FCC part 15.319(c) (e)	Conducted: $100\mu W \times \text{SQRT}(B)$ where B is the measured Emission Bandwidth in Hz FCC 15.319(c)(e): 20.87dBm (122.23mW) The antenna gain is below 3dBi, no reduction in transmit power is necessary	<input checked="" type="checkbox"/>									
Test Setup	 <p style="text-align: center;">Spectrum Analyzer ——— EUT</p>										
Test Procedure	According to ANSI 63.17: 2013 clause 6.1.2										
Test Date	03/11/2017	<table border="1"> <tr> <td>Environmental condition</td> <td>Temperature</td> <td>23 oC</td> </tr> <tr> <td></td> <td>Relative Humidity</td> <td>38 %</td> </tr> <tr> <td></td> <td>Atmospheric Pressure</td> <td>1019 mbr</td> </tr> </table>	Environmental condition	Temperature	23 oC		Relative Humidity	38 %		Atmospheric Pressure	1019 mbr
Environmental condition	Temperature	23 oC									
	Relative Humidity	38 %									
	Atmospheric Pressure	1019 mbr									
Remark	N/A										
Result	<input checked="" type="checkbox"/> Pass <input type="checkbox"/> Fail										

Test Data Yes N/A

Test Plot Yes (See below) N/A

Test was done by Gary Chou at RF test site.

Output Power measurement result

Chain 0:

Type	CH	Freq (MHz)	Power (dBm)	Limit (dBm)	Result
Power	4	1921.536	19.54	20.87	Pass
	2	1924.992	19.68	20.87	Pass
	0	1928.448	19.75	20.87	Pass

Chain 1:

Type	CH	Freq (MHz)	Power (dBm)	Limit (dBm)	Result
Power	4	1921.536	18.94	20.87	Pass
	2	1924.992	18.73	20.87	Pass
	0	1928.448	18.57	20.87	Pass

Test Plots

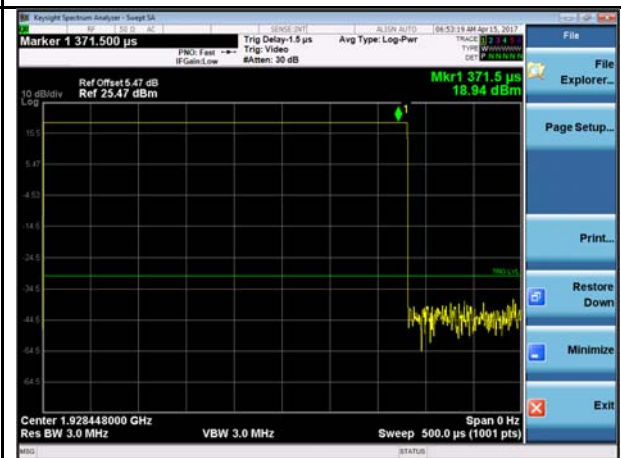
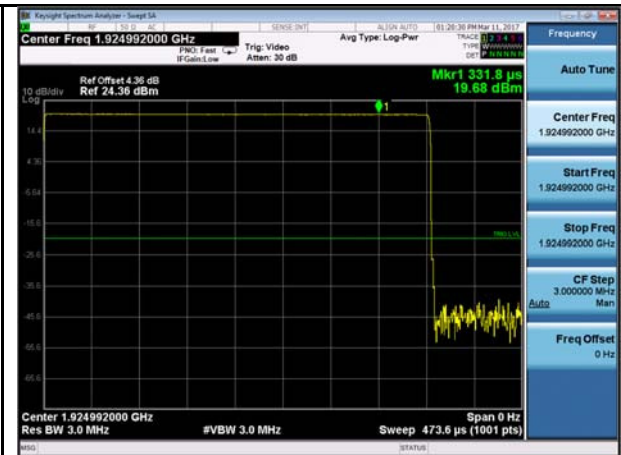
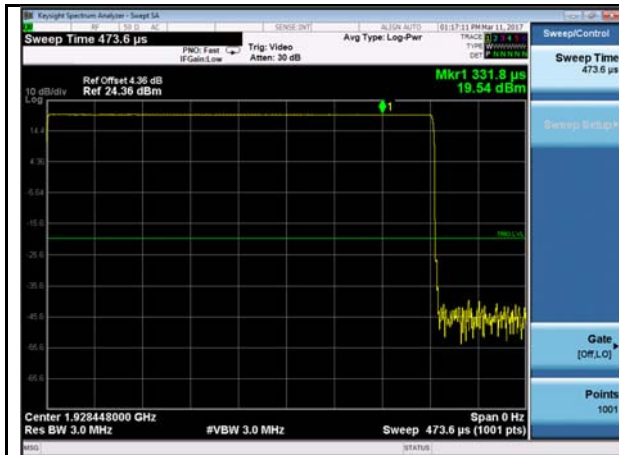

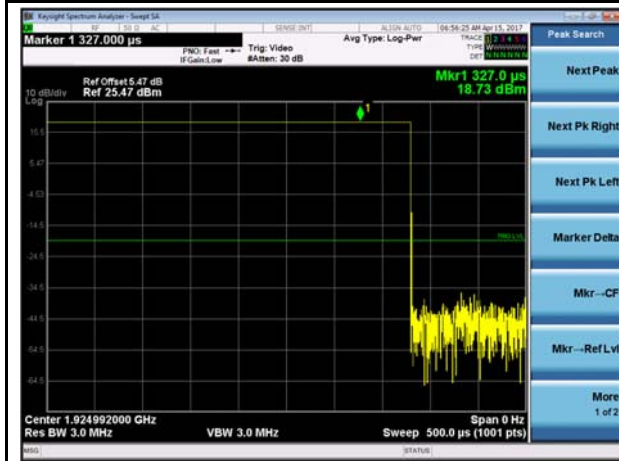

Peak Transmit Power Chain1 - Channel 2

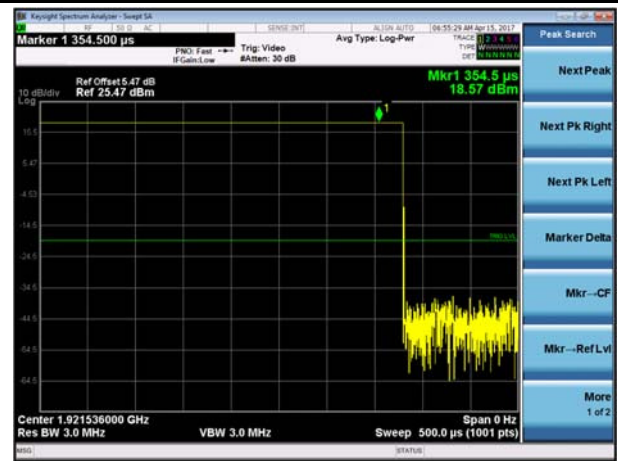

Peak Transmit Power Chain1 - Channel 4

10.5 Power spectral density

Requirement(s):

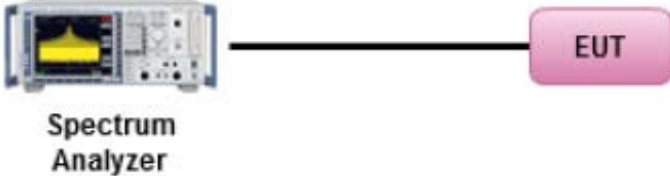
Spec	Requirement	Applicable									
§ FCC part 15.319(d)	The Power Spectral Density shall be less than 3mW (4.77dBm) when averaged over at least 100 sweeps.	<input checked="" type="checkbox"/>									
Test Setup	 <p style="text-align: center;">Spectrum Analyzer EUT</p>										
Test Procedure	According to ANSI 63.17: 2013 clause 6.1.5										
Test Date	03/11/2017	<table border="1" style="width: 100%;"> <tr> <td>Environmental condition</td> <td>Temperature</td> <td>23 oC</td> </tr> <tr> <td></td> <td>Relative Humidity</td> <td>38 %</td> </tr> <tr> <td></td> <td>Atmospheric Pressure</td> <td>1019 mbr</td> </tr> </table>	Environmental condition	Temperature	23 oC		Relative Humidity	38 %		Atmospheric Pressure	1019 mbr
Environmental condition	Temperature	23 oC									
	Relative Humidity	38 %									
	Atmospheric Pressure	1019 mbr									
Remark	-										
Result	<input checked="" type="checkbox"/> Pass <input type="checkbox"/> Fail										

Test Data Yes N/A

Test Plot Yes (See below) N/A

Test was done by Gary Chou at RF test site.

Test Result

Chain 0:

Type	CH	Freq (MHz)	PSD (dBm)	Limit (dBm)	Result
PSD	4	1921.536	2.02	4.77	Pass
	2	1924.992	2.18	4.77	Pass
	0	1928.448	1.70	4.77	Pass

Chain 1:

Type	CH	Freq (MHz)	PSD (dBm)	Limit (dBm)	Result
PSD	4	1921.536	0.84	4.77	Pass
	2	1924.992	1.23	4.77	Pass
	0	1928.448	1.10	4.77	Pass

Test Plots

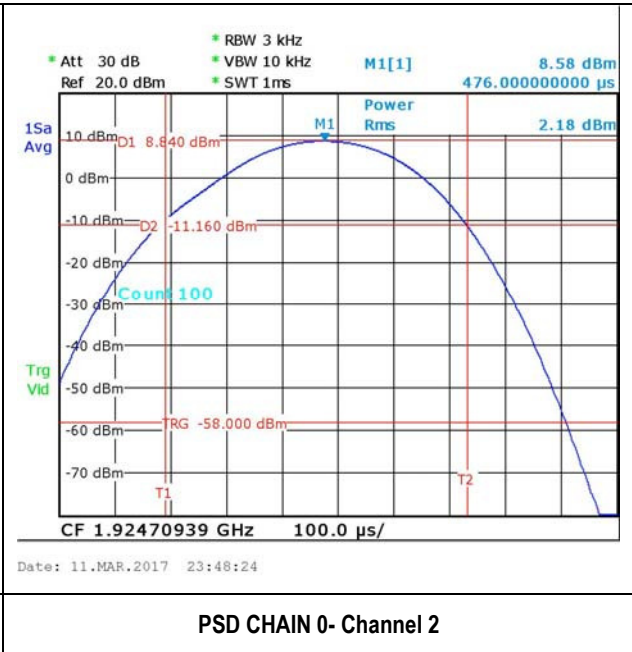
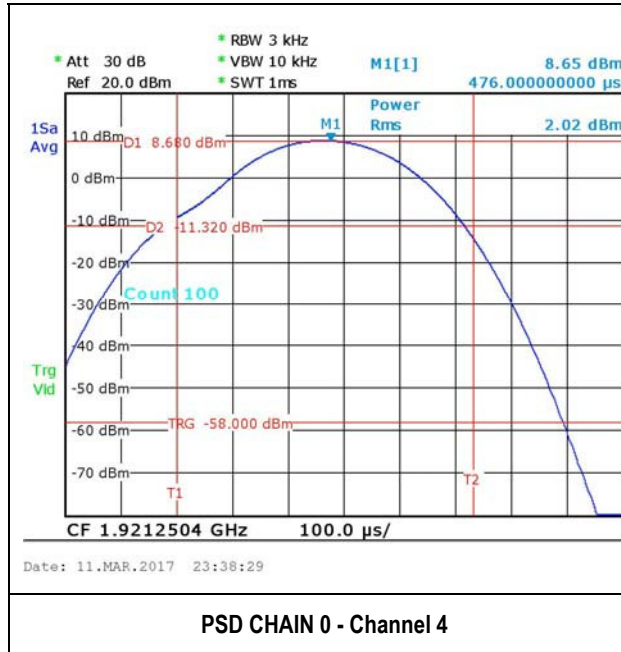

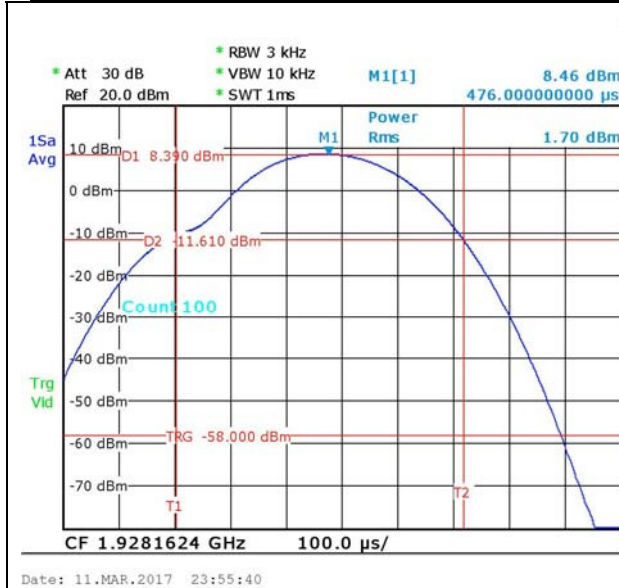

PSD CHAIN 0- Channel 0

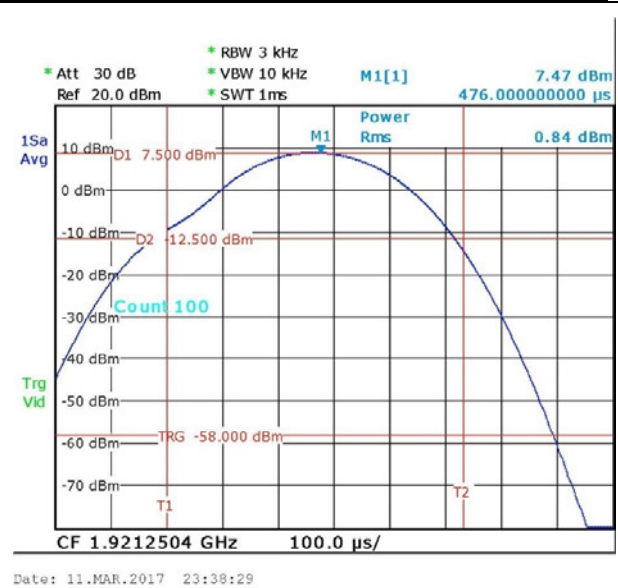

PSD CHAIN 1- Channel 4

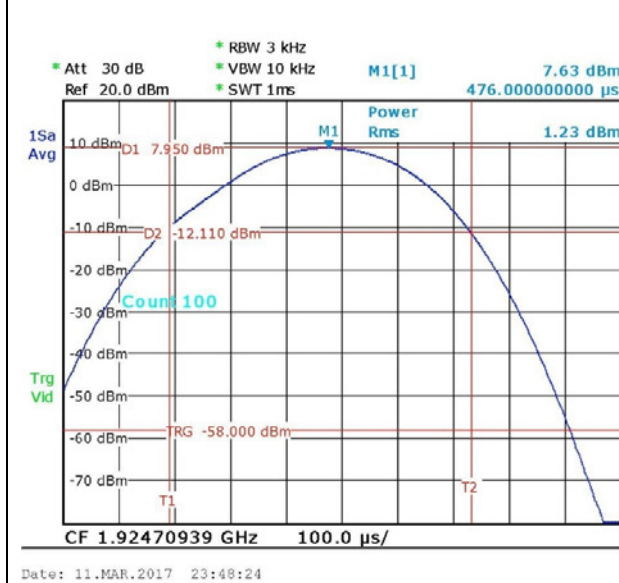

PSD CHAIN 1- Channel 2

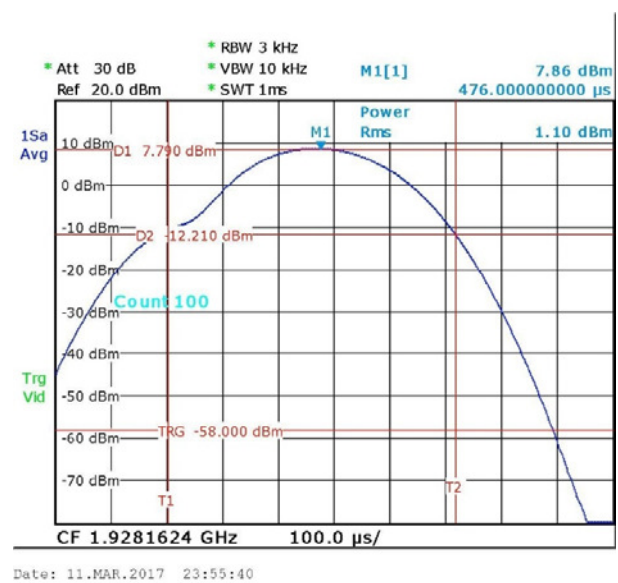

PSD CHAIN 1- Channel 0

10.6 In-band and Out-of-band emissions

Requirement(s):

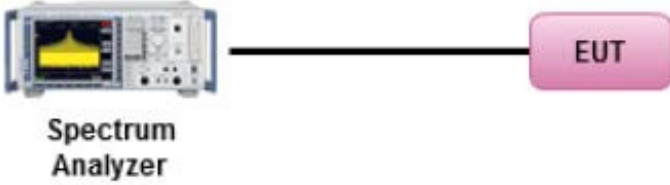
Spec	Requirement	Applicable									
§ FCC part 15.323(d)	In-Band Emissions: $B < f \leq 2B$: at least 30 dB below max. permitted peak power $2B < f \leq 3B$: at least 50 dB below max. permitted peak power $3B < f \leq$ UPCS Band Edge: at least 60 dB below max. permitted peak power Out-of-Band Emissions: $f \leq 1.25\text{MHz}$ outside UPCS band: $\leq -9.5\text{dBm}$ $1.25\text{MHz} \leq f \leq 2.5\text{MHz}$ outside UPCS band: $\leq -29.5\text{ dBm}$ $f \geq 2.5\text{MHz}$ outside UPCS band: $\leq -39.5\text{ dBm}$	<input checked="" type="checkbox"/>									
Test Setup	 <p>Spectrum Analyzer</p>										
Test Procedure	According to ANSI 63.17: 2013 clause 6.1.6										
Test Date	03/11/2017	<table border="1"> <tr> <td>Environmental condition</td> <td>Temperature</td> <td>23 oC</td> </tr> <tr> <td></td> <td>Relative Humidity</td> <td>38 %</td> </tr> <tr> <td></td> <td>Atmospheric Pressure</td> <td>1019 mbr</td> </tr> </table>	Environmental condition	Temperature	23 oC		Relative Humidity	38 %		Atmospheric Pressure	1019 mbr
Environmental condition	Temperature	23 oC									
	Relative Humidity	38 %									
	Atmospheric Pressure	1019 mbr									
Remark	-										
Result	<input checked="" type="checkbox"/> Pass <input type="checkbox"/> Fail										

Test Data Yes N/A

Test Plot Yes (See below) N/A

Test was done by Gary Chou at RF test site.

Test Plots
In-band emissions

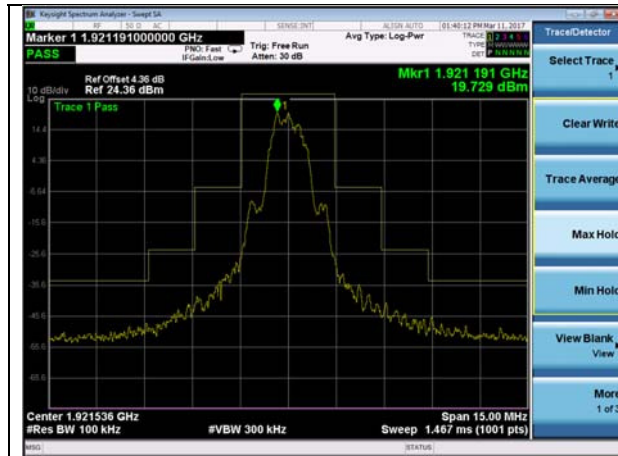

In-band emissions – Channel 4

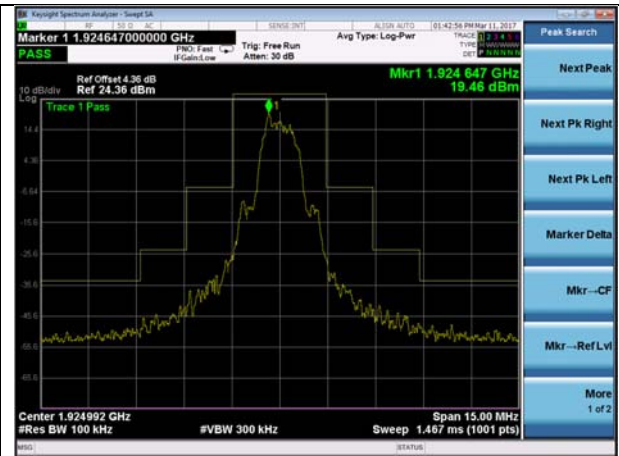

In-band emissions - Channel 2

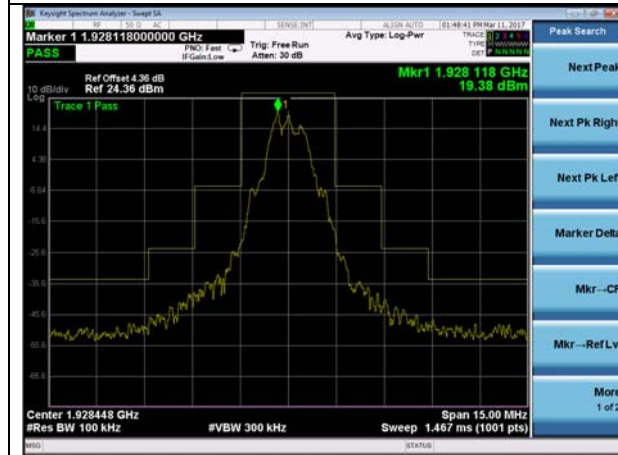

In-band emissions - Channel 0

Out of band emissions

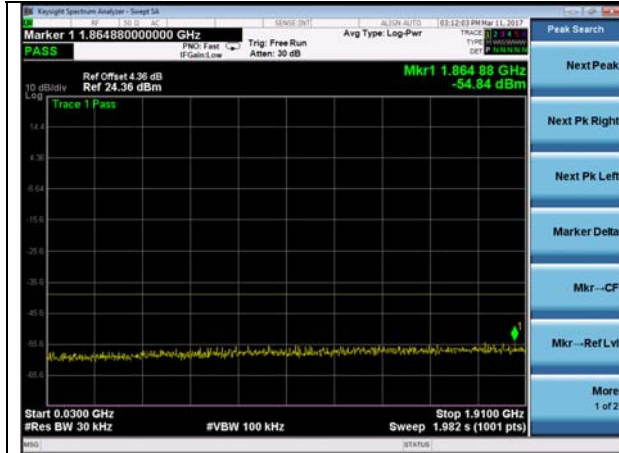

Out of band emission - 30-1915 MHz Channel 4

Out of band emission - 1915-1920 MHz Channel 4

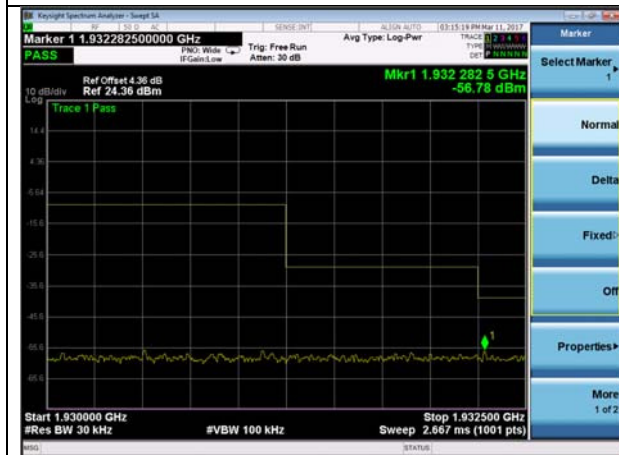

Out of band emission - 1930-1935 MHz Channel 4

Out of band emission - 1935-20000 MHz Channel 4

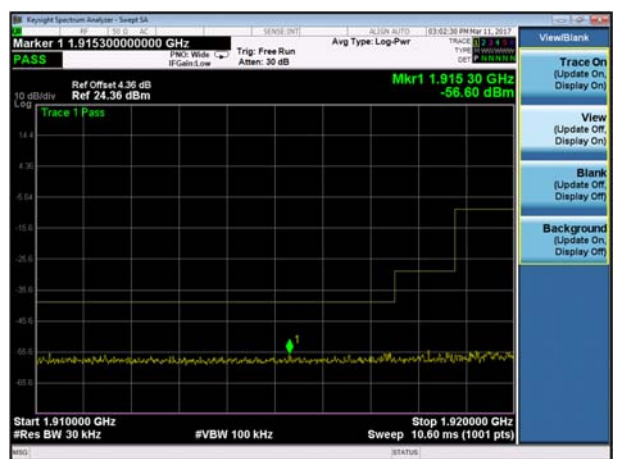
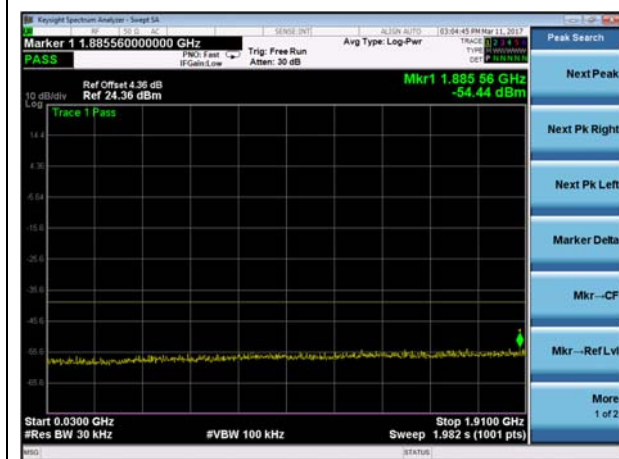

Out of band emission - 30-1915 MHz Channel 2

Out of band emission - 1915-1920 MHz Channel 2

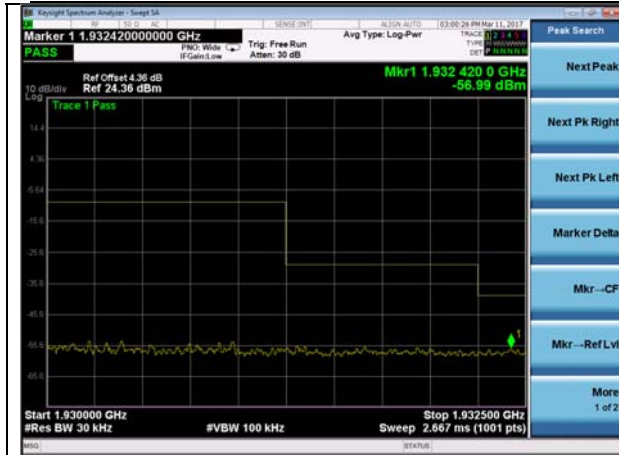

Out of band emission - 1930-1935 MHz Channel 2



Out of band emission - 1935-2000 MHz Channel 2

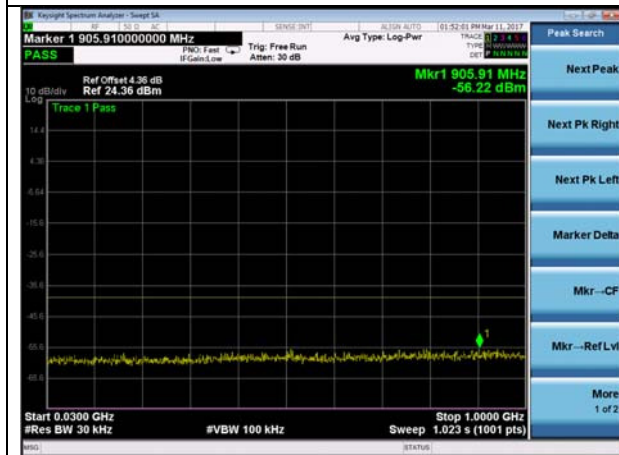

Out of band emission - 30-1915 MHz Channel 0

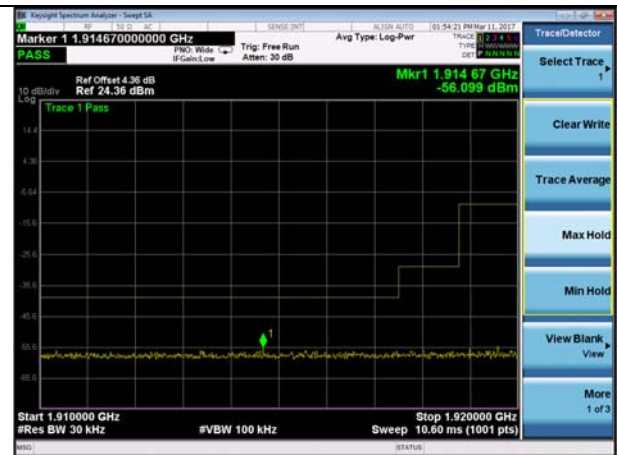

Out of band emission - 1915-1920 MHz Channel 0

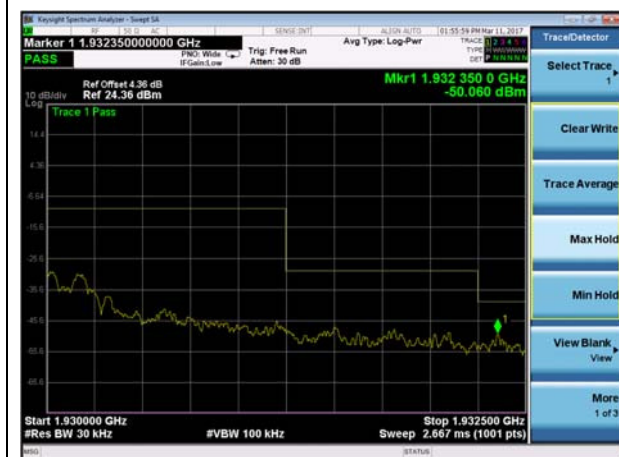

Out of band emission - 1930-1935 MHz Channel 0



Out of band emission - 1935-2000 MHz Channel 0

10.7 Radiated Spurious Emissions Out-of-band emissions

Requirement(s):

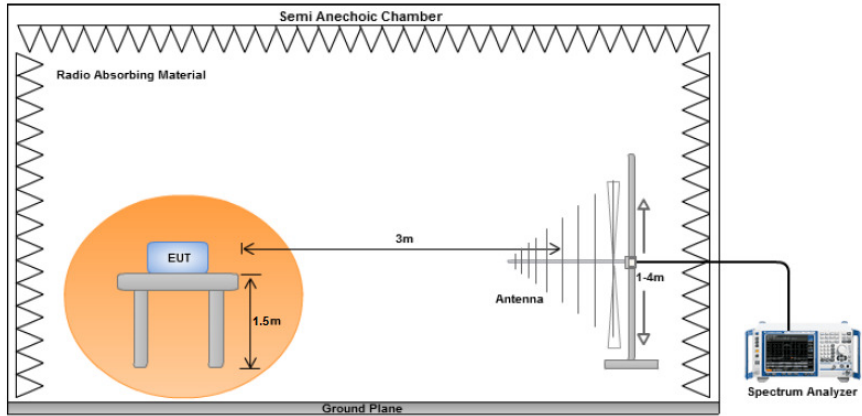
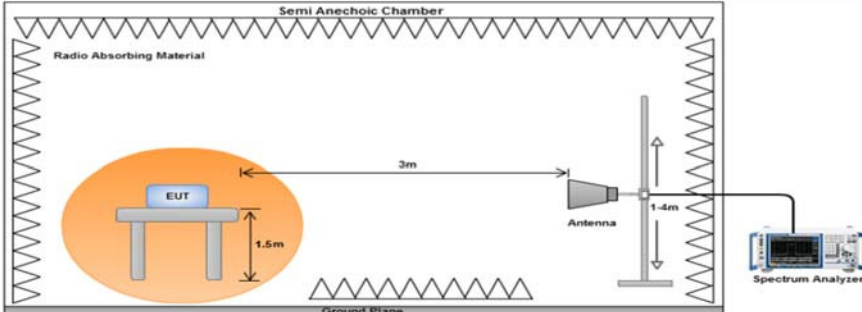
Spec	Requirement	Applicable
§ FCC part 15.323(d)	Out-of-Band Emissions: $f \leq 1.25\text{MHz}$ outside UPCS band: $\leq -9.5\text{dBm}$ $1.25\text{MHz} \leq f \leq 2.5\text{MHz}$ outside UPCS band: $\leq -29.5\text{ dBm}$ $f \geq 2.5\text{MHz}$ outside UPCS band: $\leq -39.5\text{ dBm}$	<input checked="" type="checkbox"/>
Test Setup Below 1GHz		
Test Setup Above 1GHz		
Remark	-	
Result	<input checked="" type="checkbox"/> Pass <input type="checkbox"/> Fail	

Test Data Yes (See below) N/A

Test Plot Yes (See below) N/A

Test was done by Gary Chou at 10m chamber.

Channel 4 (1921.536 MHz)

Indicated			Test Antenna		Substituted						
Frequency (MHz)	Raw (dBuV)	Degree	Height (cm)	Polarity	Frequency (MHz)	Level (dBm)	Ant Gain (dBi)	Cable Loss (dB)	Absolute Level (dBm)	Limit (dBm)	Margin (dB)
3848.36	-58.95	30	150	V	3848.36	-41.58	9.82	0.31	-51.09	-39.5	-11.59
3848.36	-56.35	30	150	H	3848.36	-39.40	9.82	0.31	-48.91	-39.5	-9.41
34.89	-63.60	236	165	V	34.89	-62.29	0	0.29	-62.00	-39.5	-22.50
34.89	-64.38	167	176	H	34.89	-63.22	0	0.29	-62.93	-39.5	-23.43
797.00	-65.33	264	168	V	797.00	-60.09	0	0.31	-59.78	-39.5	-20.28
797.0	-67.42	153	156	H	797.00	-62.11	0	0.31	-61.80	-39.5	-22.30
840.25	-66.40	269	169	V	840.25	-62.01	0	0.33	-61.68	-39.5	-22.18
840.25	-67.52	147	161	H	840.25	-65.07	0	0.33	-64.74	-39.5	-25.24

Channel 0 (1928.448 MHz)

Indicated			Test Antenna		Substituted						
Frequency (MHz)	Raw (dBuV)	Degree	Height (cm)	Polarity	Frequency (MHz)	Level (dBm)	Ant Gain (dBi)	Cable Loss (dB)	Absolute Level (dBm)	Limit (dBm)	Margin (dB)
3848.36	-56.80	30	150	V	3848.36	-39.43	9.82	0.31	-48.94	-39.5	-9.44
3848.36	-54.20	30	150	H	3848.36	-37.25	9.82	0.31	-46.76	-39.5	-7.26
34.89	-61.45	236	165	V	34.89	-60.14	0	0.29	-59.85	-39.5	-20.35
34.89	-62.23	167	176	H	34.89	-61.07	0	0.29	-60.78	-39.5	-21.28
797.00	-63.18	264	168	V	797.00	-57.94	0	0.31	-57.63	-39.5	-18.13
797.00	-65.27	153	156	H	797.00	-59.96	0	0.31	-59.65	-39.5	-20.15
840.25	-64.25	269	169	V	840.25	-59.86	0	0.33	-59.53	-39.5	-20.03
840.25	-65.37	147	161	H	840.25	-62.92	0	0.33	-62.59	-39.5	-23.09

10.8 Carrier Frequency Stability

Requirement(s):

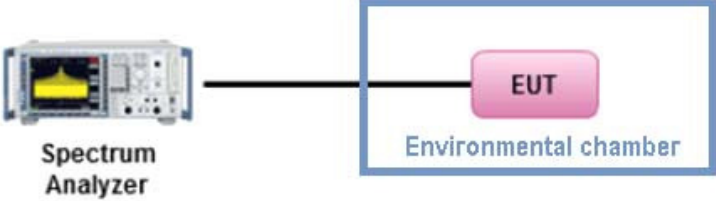
Spec	Requirement	Applicable
§ FCC part 15.323(f)	The Carrier frequency stability of EUT shall be maintained within +/- 10ppm	<input checked="" type="checkbox"/>
Test Setup		
Procedure	According to ANSI 63.17: 2013 clause 6.2.1	
Test Date	03/11/2017	Environmental condition Temperature 23 oC Relative Humidity 38 % Atmospheric Pressure 1019 mbr
Remark	N/A	
Result	<input checked="" type="checkbox"/> Pass <input type="checkbox"/> Fail	

Test Data Yes (See below) N/A

Test Plot Yes (See below) N/A

Test was done by Gary Chou at RF test site.

Test Data:

Frequency Stability over Power Supply Voltage at Nominal Temperature

Voltage	Channel Frequency	Difference	Deviation	Limits
Vnom	1924.992 MHz	3 kHz	1.38 ppm	±10 ppm
85% of Vnom	1924.992 MHz	-3 kHz	1.6 ppm	
115% of Vnom	1924.992 MHz	4 kHz	1.6 ppm	

Note: Deviation ppm = ((Mean - Measured Frequency) / Mean) x 10⁶

Frequency Stability over Temperature

Temp.	Channel Frequency	Difference	Deviation	Limits
+20°C	1924.992 MHz	3 kHz	1.38 ppm	±10 ppm
-20°C	1924.992 MHz	-2 kHz	1.48ppm	
+50°C	1924.992 MHz	5 kHz	1.53ppm	

10.9 Frame repetition Stability, period and jitter

Requirement(s):

Spec	Requirement			Applicable
§ FCC part 15.323(e)	±10 ppm for Frame Repetition Stability, 20 or 10 ms for frame period, 25 µs for max jitter.			<input checked="" type="checkbox"/>
Test Setup				
Procedure	According to ANSI 63.17: 2013 clause 6.2.2			
Test Date	03/11/2017	Environmental condition	Temperature	23 oC
			Relative Humidity	38 %
			Atmospheric Pressure	1019 mbr
Remark	The EUT was scanned up to 40GHz. Both horizontal and vertical polarities were investigated. The results show only the worst case. There isn't outstanding emission found at the edge of restricted frequency.			
Result	<input checked="" type="checkbox"/> Pass <input type="checkbox"/> Fail			

Test Data Yes (See below) N/A

Test Plot Yes (See below) N/A

Test was done by Gary Chou at RF test site.

Test Data:

Carrier Frequency (MHz)	Frame repetition (ppm)	Frame period (ms)	Max. pos. jitter (µs)	Max. neg.jitter (µs)
1924.992	1.98	10	0.01	-0.05

10.10 Automatically discontinue transmission

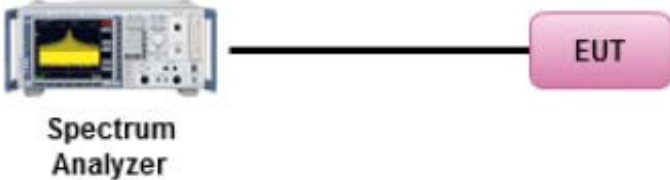
Spec	Requirement	Applicable									
§ FCC part 15.319(f)	The device shall automatically discontinue transmission in case of either absence of information to transmit or operational failure. The provisions in this section are not intended to preclude transmission of control and signaling information or use of repetitive codes used by certain digital technologies to complete frame or burst intervals.	<input checked="" type="checkbox"/>									
Test Setup											
Test Procedure	The EUT is a responding device, and can transmit control and signaling information. The following tests simulate the reaction of the EUT in case of either absence of information to transmit or operational failure after a connection with the companion device is established.										
Test Date	03/11/2017	<table border="1"> <tr> <td>Environmental condition</td> <td>Temperature</td> <td>23 oC</td> </tr> <tr> <td></td> <td>Relative Humidity</td> <td>38 %</td> </tr> <tr> <td></td> <td>Atmospheric Pressure</td> <td>1019 mbr</td> </tr> </table>	Environmental condition	Temperature	23 oC		Relative Humidity	38 %		Atmospheric Pressure	1019 mbr
Environmental condition	Temperature	23 oC									
	Relative Humidity	38 %									
	Atmospheric Pressure	1019 mbr									
Remark	-										
Result	<input checked="" type="checkbox"/> Pass <input type="checkbox"/> Fail										

Test Data Yes (See below) N/A

Test Plot Yes (See below) N/A

Test was done by Gary Chou at RF test site.

Test Data:

Number	Test Items	EUT Reaction	Verdict
1	Power removed from EUT	A	Pass
2	Switch off EUT	B	Pass
3	Hook-on by EUT	B	Pass
4	Power removed from companion device	B	Pass
5	Switch off companion device	B	Pass
6	Hook-on by companion device	B	Pass

A - Connection breakdown, cease of all transmissions

B - Connection breakdown, EUT transmits control and signaling information

C - Connection breakdown, companion device transmits control and signaling information

N/A - Not Applicable (EUT does not have On/ Off switch and cannot perform Hook-on)

10.11 Specific requirements for devices operating in the 1920-1930MHz sub-band

10.11.1 Monitoring time

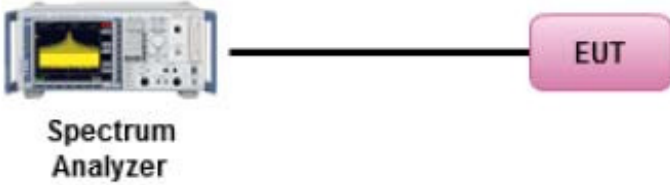
Spec	Requirement	Applicable									
§ FCC part 15.323(c) (1)	Immediately prior to initiating transmission, devices must monitor the combined time and spectrum windows in which they intend to transmit for a period of at least 10 milliseconds for systems designed to use a 10 milliseconds or shorter frame period or at least 20 milliseconds for systems designed to use a 20 milliseconds frame period.	<input checked="" type="checkbox"/>									
Test Setup											
Test Procedure	According to ANSI 63.17: 2013 clause 7.3.4										
Test Date	03/11/2017	<table border="1"> <tr> <td>Environmental condition</td> <td>Temperature</td> <td>23 oC</td> </tr> <tr> <td></td> <td>Relative Humidity</td> <td>38 %</td> </tr> <tr> <td></td> <td>Atmospheric Pressure</td> <td>1019 mbr</td> </tr> </table>	Environmental condition	Temperature	23 oC		Relative Humidity	38 %		Atmospheric Pressure	1019 mbr
Environmental condition	Temperature	23 oC									
	Relative Humidity	38 %									
	Atmospheric Pressure	1019 mbr									
Remark	N/A										
Result	<input checked="" type="checkbox"/> Pass <input type="checkbox"/> Fail										

Test Data Yes (See below) N/A

Test Plot Yes (See below) N/A

Test was done by Gary Chou at RF test site.

Test Result

EUT monitors the combined time and spectrum window prior to initiation of transmission. The observation results as below

Channel Selection	Observation result	Verdict
1. Apply the interference on f1 at level TU +UM, and no interference on f2. Initiate transmission and verify the transmission on f2.	EUT transmission on f2	Pass
2. Apply interference on f2 at a level of TU + UM, in-band, and immediately remove all interference from f1 and immediately (but not sooner than 20 ms after the interference on f2 is applied) cause the EUT to attempt transmission.	EUT transmission on f1	Pass

10.11.2 Monitoring Threshold, Lease Interfered Channel

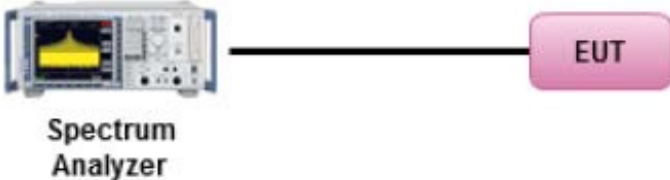
Spec	Requirement	Applicable									
§ FCC part 15.323(c) (2) (5)	The monitoring threshold must not be more than 30 dB above the thermal noise power for a bandwidth equivalent to the emission bandwidth used by the device. If access to spectrum is not available as determined by the above, and a minimum of 40 duplex system access channels are defined for the system, the time and spectrum windows with the lowest power level below a monitoring threshold of 50 dB above the thermal noise power determined for the emission bandwidth may be accessed.	<input checked="" type="checkbox"/>									
Test Setup											
Test Procedure	According to ANSI 63.17: 2013 clause 7.3.1, 7.3.2, 7.3.3 and 7.3.4										
Test Date	03/11/2017	<table border="1"> <tr> <td>Environmental condition</td> <td>Temperature</td> <td>23 oC</td> </tr> <tr> <td></td> <td>Relative Humidity</td> <td>38 %</td> </tr> <tr> <td></td> <td>Atmospheric Pressure</td> <td>1019 mbr</td> </tr> </table>	Environmental condition	Temperature	23 oC		Relative Humidity	38 %		Atmospheric Pressure	1019 mbr
Environmental condition	Temperature	23 oC									
	Relative Humidity	38 %									
	Atmospheric Pressure	1019 mbr									
Remark	N/A										
Result	<input checked="" type="checkbox"/> Pass <input type="checkbox"/> Fail										

Test Data Yes (See below) N/A

Test Plot Yes (See below) N/A

Test was done by Gary Chou at RF test site.

Test Result :

Measurement Data:

Lower threshold: TL = $-174 + 10\log_{10}B + MU + P_{MAX-PEUT}$ (dBm)

Upper threshold: TU = $-174 + 10\log_{10}B + \mu + P_{MAX-PEUT}$ (dBm)

Where: B=Emission bandwidth (Hz)

MU=dB the threshold may exceed thermal noise (30 for TL & 50 for TU)

Calculated values

Threshold	FCC part 15D	RSS-213
Lower threshold	-81.8	-83.1
Upper threshold	N/A	-63.1

The Lower Threshold is applicable for systems which have defined less than 40 duplex system access channels. The Upper Threshold is applicable for systems with more than 40 duplex system access channels and that implements the Least Interfered Channel Procedure (LIC).

Upper Threshold has been removed from FCC 15D but still exists in the current Industry Canada RSS-213.

Limit

Threshold	FCC part 15D	RSS-213
Lower threshold + 6 dB	-75.8	-77.1
Upper threshold + 6 dB	N/A	-57.1

The Upper or Lower Threshold is found by the procedure defined in ANSI C63.17: 2013 clause 7.3.1 or 7.3.2.

Monitor Threshold	Measured level	FCC part 15D	RSS-213
Lower threshold	N/A	-75.8	-77.1
Upper threshold	-61.3	N/A	-57.1

For the EUT which support LIC there is no need to measure lower threshold because it is automatically met by LIC procedure

Least Interfered Channel (LIC) Procedure Test, FCC 15.323(c)(2) and (c)(5)

ANSI C63.17: 2013 clause 7.3.3 ref. Observation Verdict	ANSI C63.17: 2013 clause 7.3.3 ref. Observation Verdict	ANSI C63.17: 2013 clause 7.3.3 ref. Observation Verdict
b) f1 TL + 13 dB, f2 at TL + 6 dB	Transmission always on f2	Pass
c) f1 TL + 6 dB, f2 at TL + 13 dB	Transmission always on f1	Pass
d) f1 TL + 7 dB, f2 at TL	Transmission always on f1	Pass
e) f1 TL, f2 at TL + 7 dB	Transmission always on f1	Pass

10.11.3 Monitoring Threshold Bandwidth

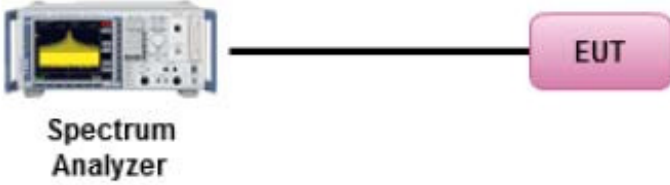
Spec	Requirement	Applicable									
§ FCC part 15.323(c) (7)	The monitoring system bandwidth must be equal to or greater than the emission bandwidth of the intended transmission.	<input checked="" type="checkbox"/>									
Test Setup											
Test Procedure	According to ANSI 63.17: 2013 clause 7. 4										
Test Date	03/11/2017	<table border="1"> <tr> <td>Environmental condition</td> <td>Temperature</td> <td>23 oC</td> </tr> <tr> <td></td> <td>Relative Humidity</td> <td>38 %</td> </tr> <tr> <td></td> <td>Atmospheric Pressure</td> <td>1019 mbr</td> </tr> </table>	Environmental condition	Temperature	23 oC		Relative Humidity	38 %		Atmospheric Pressure	1019 mbr
Environmental condition	Temperature	23 oC									
	Relative Humidity	38 %									
	Atmospheric Pressure	1019 mbr									
Remark	N/A										
Result	<input checked="" type="checkbox"/> Pass <input type="checkbox"/> Fail										

Test Data Yes (See below) N/A

Test Plot Yes (See below) N/A

Test was done by Gary Chou at RF test site.

Measurement Data:

The monitoring system bandwidth must be equal to or greater than the emission bandwidth of the intended transmission.

Test performed	Observation result	Verdict
Simple Compliance test, at $\pm 30\%$ of B	No transmissions	Pass
More Detailed Test, at -6 dB points	N/A	N/A
More Detailed Test, at -12 dB points	N/A	N/A

Notes:

1. The more detailed test must be pass at both the -6 and -12 dB points if the Simple Compliance test fails.
2. The Simple Compliance Test was performed with the level at $T_u + U_m + 10$ dB to check that the EUT did not transmit at all.
3. The tested EUT uses the same receiver for monitoring and communication, this test is therefore not required. However the test has been performed nonetheless and the test is passed.

10.11.4 Reaction Time and Monitoring Interval

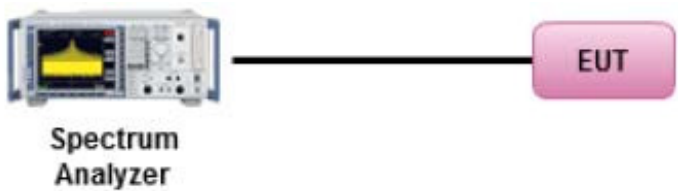
Spec	Requirement	Applicable									
§ FCC part 15.323(c) (7)	The monitoring system bandwidth must be equal to or greater than the emission bandwidth of the intended transmission.	<input checked="" type="checkbox"/>									
Test Setup											
Test Procedure	According to ANSI 63.17: 2013 clause 7. 4										
Test Date	03/11/2017	<table border="1"> <tr> <td>Environmental condition</td> <td>Temperature</td> <td>23 oC</td> </tr> <tr> <td></td> <td>Relative Humidity</td> <td>38 %</td> </tr> <tr> <td></td> <td>Atmospheric Pressure</td> <td>1019 mbr</td> </tr> </table>	Environmental condition	Temperature	23 oC		Relative Humidity	38 %		Atmospheric Pressure	1019 mbr
Environmental condition	Temperature	23 oC									
	Relative Humidity	38 %									
	Atmospheric Pressure	1019 mbr									
Remark	N/a										
Result	<input checked="" type="checkbox"/> Pass <input type="checkbox"/> Fail										

Test Data Yes (See below) N/A

Test Plot Yes (See below) N/A

Test was done by Gary Chou at RF test site.

Measurement Data:

By administrative commands and out-of-operating region interference, the EUT is restricted to operate on a single carrier frequency. Time-synchronized pulsed interference was then applied on the carrier at pulsed levels $T_U + U_M$ to check that the EUT does not transmit at all. The level was raised 6 dB for part d) with 35 μ s pulses.

The pulses are synchronized with the EUT timeslots and applied centered within all timeslots.

Pulse Width, ref. to ANSI C63.17: 2013 clause 7.5	Observation result	Verdict
c) > largest of 50 μ s and $50 \cdot \text{SQRT}(1.25/B)$	No transmissions	Pass
d) > largest of 35 μ s and $35 \cdot \text{SQRT}(1.25/B)$, and with interference level raised 6 dB	No transmissions	Pass

Notes:

Since B is larger than 1.25 MHz the test was performed with pulse lengths of 50 μ s and 35 μ s.

10.11.5 Time and Spectrum Window Access Procedure

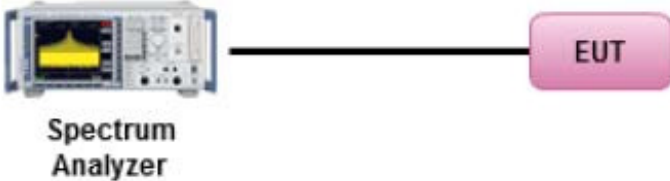
Spec	Requirement	Applicable									
§ FCC part 15.323(c) (4) (6)	FCC 15.323(c)(4): Once access to specific combined time and spectrum windows is obtained an acknowledgement from a system participant must be received by the initiating transmitter within one second or transmission must cease. Periodic acknowledgements must be received at least every 30 seconds or transmission must cease. Channels used exclusively for control and signaling information may transmit continuously for 30 seconds without receiving an acknowledgement, at which time the access criteria must be repeated. FCC 15.323(c)(6): If the selected combined time and spectrum windows are unavailable, the device may either monitor and select different windows or seek to use the same windows after waiting an amount of time, randomly chosen from a uniform random distribution between 10 and 150 milliseconds, commencing when the channel becomes available	<input checked="" type="checkbox"/>									
Test Setup	 <p style="text-align: center;">Spectrum Analyzer ————— EUT</p>										
Test Procedure	According to ANSI 63.17: 2013 clause 8.1										
Test Date	03/11/2017	<table border="1"> <tr> <td>Environmental condition</td> <td>Temperature</td> <td>23 oC</td> </tr> <tr> <td></td> <td>Relative Humidity</td> <td>38 %</td> </tr> <tr> <td></td> <td>Atmospheric Pressure</td> <td>1019 mbr</td> </tr> </table>	Environmental condition	Temperature	23 oC		Relative Humidity	38 %		Atmospheric Pressure	1019 mbr
Environmental condition	Temperature	23 oC									
	Relative Humidity	38 %									
	Atmospheric Pressure	1019 mbr									
Remark	N/A										
Result	<input checked="" type="checkbox"/> Pass <input type="checkbox"/> Fail										

Test Data Yes (See below) N/A

Test Plot Yes (See below) N/A

Test was done by Gary Chou at RF test site.

Measurement Data:

This requirement is only for EUTs which transmit unacknowledged control and signaling information.

Access Criteria, ref. to ANSI C63.17: 2013 clause 8.1.1	Observation result	Verdict
b) Check that the EUT transmits on the interference free time-slot	N/A	N/A
b) The EUT must terminate or pause in its repetitive transmission of the control and signaling channel on the open channel to repeat the access criteria not less frequently than every 30 s	N/A	N/A

If FCC 15.323(c)(6) option, **If Random Waiting Interval is NOT implemented**

Access Criteria, ref. to ANSI C63.17: 2013 clause 8.1.1	Observation result	Verdict
b) Check that the EUT transmits on the interference free time-slot	N/A	N/A
b) The EUT must terminate or pause in its repetitive transmission of the control and signaling channel on the open channel to repeat the access criteria not less frequently than every 30 s	N/A	N/A

If FCC 15.323(c)(6) option, **Only if Random Waiting Interval is implemented**

Access Criteria, ref. to ANSI C63.17: 2013 clause 8.1.1	Observation result	Verdict
b) Check that the EUT transmits on the interference free time-slot	N/A	N/A
b) The EUT must terminate or pause in its repetitive transmission of the control and signaling channel on the open channel to repeat the access criteria not less frequently than every 30 s	N/A	N/A

Notes:

The tested EUT does not transmit unacknowledged control and signaling information.

10.11.6 Acknowledgements and Transmission Duration

Requirement(s):

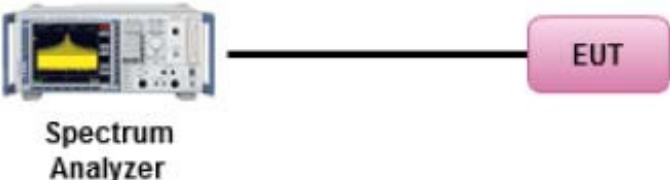
Spec	Requirement	Applicable
§ FCC part 15.323(c) (3) (4)	Occupation of the same combined time and spectrum windows by a device or group of cooperating devices continuously over a period of time longer than 8 hours is not permitted without repeating the access criteria. Once access to specific combined time and spectrum windows is obtained an acknowledgement from a system participant must be received by the initiating transmitter within one second or transmission must cease. Periodic acknowledgements must be received at least every 30 seconds or transmission must cease. Channels used exclusively for control and signaling information may transmit continuously for 30 seconds without receiving an acknowledgement, at which time the access criteria must be repeated.	☒
Test Setup	 <p>Spectrum Analyzer</p>	
Procedure	According to ANSI 63.17: 2013 clause 8.2	
Test Date	03/11/2017	Environmental condition Temperature 23 oC Relative Humidity 38 % Atmospheric Pressure 1019 mbr
Remark	N/A	
Result	☒ Pass ☐ Fail	

Test Data ☒ Yes (See below) ☐ N/A
Test Plot ☐ Yes (See below) ☒ N/A

Test was done by Gary Chou at RF test site.

Measurement Data:

During the test **Initial transmission without acknowledgements** the signal from the EUT to the companion device is blocked by circulators in addition to the tunable attenuator.

The test **Transmission time after loss of acknowledgements** is performed by cutting-off the signal from the companion device by a RF switch and measuring the time until the EUT stops transmitting.

The **Transmission Duration** test is performed by monitoring the slot in use and measuring the time until the EUT changes to a different slot.

Acknowledgements

Test ref. to ANSI C63.17: 2013 clause 8.2.1	Observation result	Verdict
a) Initial transmission without acknowledgements	0.68s	Pass
c) Transmission time after loss of acknowledgements	10s	Pass

Transmission Duration

Test ref. to ANSI C63.17: 2013 clause 8.2.2	Observation	Verdict
b) Transmission duration on same time and frequency window	1 hour	Pass

10.11.7 Dual Access Criteria Check

Requirement(s):

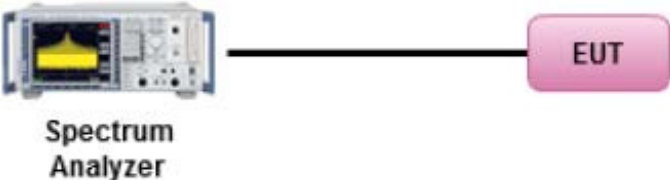
Spec	Requirement	Applicable
§ FCC part 15.323(c) (10)	An initiating device may attempt to establish a duplex connection by monitoring both its intended transmits and receive time and spectrum windows. If both the intended transmit and receive time and spectrum windows meet the access criteria, then the initiating device can initiate a transmission in the intended transmit time and spectrum window. If the power detected by the responding device can be decoded as a duplex connection signal from the initiating device, then the responding device may immediately begin transmitting on the receive time and spectrum window monitored by the initiating device.	<input type="checkbox"/>
Test Setup	 <p>Spectrum Analyzer</p>	
Procedure	According to ANSI 63.17: 2013 clause 8.3	
Remark	Not tested. The manufacturer declares that this provision is not utilized by the EUT.	
Result	<input type="checkbox"/> Pass <input type="checkbox"/> Fail	

Test Data Yes (See below) N/A

Test Plot Yes (See below) N/A

Test was done by Gary Chou at RF test site.

10.11.8 Alternative Monitoring Interval

Requirement(s):

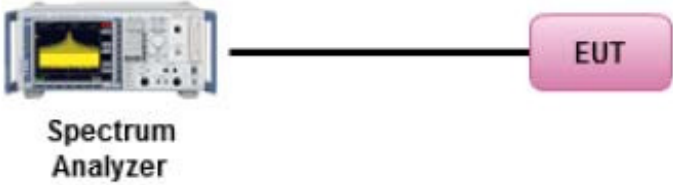
Spec	Requirement	Applicable
§ FCC part 15.323(c) (11)	An initiating device that is prevented from monitoring during its intended transmit window due to monitoring system blocking from the transmissions of a co-located (within one meter) transmitter of the same system, may monitor the portions of the time and spectrum windows in which they intend to receive over a period of at least 10 milliseconds. The monitored time and spectrum window must total at least 50 percent of the 10 millisecond frame interval and the monitored spectrum must be within 1.25 MHz of the center frequency of channel(s) already occupied by that device or co-located co-operating devices. If the access criteria is met for the intended receive time and spectrum window under the above conditions, then transmission in the intended transmit window by the initiating device may commence.	<input type="checkbox"/>
Test Setup	 <p style="text-align: center;">Spectrum Analyzer</p>	
Procedure	According to ANSI 63.17: 2013 clause 8.4	
Remark	Not tested. The manufacturer declares that this provision is not utilized by the EUT.	
Result	<input type="checkbox"/> Pass <input type="checkbox"/> Fail	

Test Data Yes (See below) N/A

Test Plot Yes (See below) N/A

Test was done by Gary Chou at RF test site.

10.11.9 Fair Access

Requirement(s):

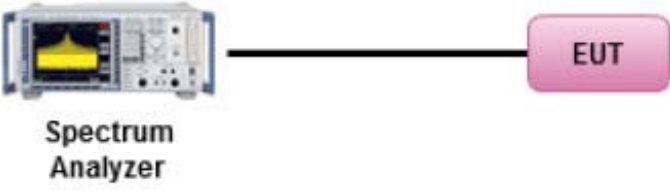
Spec	Requirement	Applicable
§ FCC part 15.323(c) (12)	The provisions of (c)(10) or (c)(11) shall not be used to extend the range of spectrum occupied over space or time for the purpose of denying fair access to spectrum to other devices.	<input type="checkbox"/>
Test Setup	 <p style="text-align: center;">Spectrum Analyzer</p>	
Procedure	According to ANSI 63.17: 2013 clause 8.4	
Remark	Not tested. The manufacturer declares that this device does not use any mechanisms as provided by Part15.323 (c) (10) or (c) (11) to extend the range of spectrum occupied over space or time for the purpose of denying fail access to spectrum to other device.	
Result	<input type="checkbox"/> Pass <input type="checkbox"/> Fail	

Test Data Yes (See below) N/A

















Test Plot Yes (See below) N/A





Test was done by Gary Chou at RF test site.

Annex A. TEST INSTRUMENT

Instrument	Model	Serial #	Cal Cycle	Cal Due	In use
Conducted Emissions					
EMI Test Receiver	ESL6	100178	1 Year	08/17/2017	<input checked="" type="checkbox"/>
Transient Limiter (9kHz – 100MHz)	EM-7600	287	1 Year	04/06/2017	<input checked="" type="checkbox"/>
V-LISN (150 kHz – 30 MHz)	NNLK 8129	8129-190	1 Year	08/04/2017	<input checked="" type="checkbox"/>
LISN (9 kHz – 30 MHz)	MN2050B	1018	1 Year	08/06/2018	<input checked="" type="checkbox"/>
TLISN	ISN T800	30814	1 Year	08/08/2015	<input type="checkbox"/>
Hygro Hermograph	ST-50	HE01-000092	1 Year	05/25/2015	<input type="checkbox"/>
Radiated Emissions					
EMI Test Receiver	ESIB40	100179	1 Year	06/03/2017	<input checked="" type="checkbox"/>
Antenna - Biconlog (30 MHz – 2 GHz)	JB1	A030702	1 Year	1/13/2018	<input checked="" type="checkbox"/>
DoubleRidged Waveguide Horn Antenna (1-18 GHz)	3115	10SL0059	1 Year	8/11/2017	<input checked="" type="checkbox"/>
Horn Antenna (18-40 GHz)	AH-840	101013	1 Year	08/11/2015	<input type="checkbox"/>
RF Pre-Amplifier	LPA-6-30	11170602	1 Year	02/09/2018	<input checked="" type="checkbox"/>
1-40 GHz Pre-Amp	J532-00104000-58-5P	1960351	1 Year	05/10/2017	<input checked="" type="checkbox"/>
10 Meters SAC	10M	N/A	1 Year	07/06/2017	<input checked="" type="checkbox"/>
Hygro Hermograph	ST-50	HE01-000092	1 Year	05/25/2015	<input type="checkbox"/>
RF Conducted Measurement					
Agilent Spectrum Analyzer	N9010A	10SL0219	1 Year	08/20/2017	<input checked="" type="checkbox"/>
R & S Digital Radio communication Tester	CMD60	CCIS0149	1 Year	08/20/2017	<input checked="" type="checkbox"/>
R & S Receiver	ESIB 40	100179	1 Year	05/24/2015	<input type="checkbox"/>
DFS Measurement					
Agilent Signal Analyzer	N9010A	MY50210206	1 Year	8/13/2015	<input type="checkbox"/>
Dual Channels Arbitrary Waveform Generator (Tabor Electronics Ltd)	WWW-1072	207593	1 Year	8/7/2015	<input type="checkbox"/>
Synthesized Signal Generator (Agilent/HP)	HP8665B	3744A01304	1 Year	8/11/2015	<input type="checkbox"/>
Splitter/Combiner (Mini-Circuit)	ZFSC-2-9G+	N/A	1 Year	N/A	<input type="checkbox"/>
Splitter/Combiner (Mini-Circuit)	ZFSC-2-9G+	N/A	1 Year	N/A	<input type="checkbox"/>
Agilent Signal Generator	MXG N5182A	MY47071065	1 Year	05/13/2015	<input type="checkbox"/>

Annex B. SIEMIC Accreditation

Accreditations	Document	Scope / Remark
ISO 17025 (A2LA)		Please see the documents for the detailed scope
ISO Guide 65 (A2LA)		Please see the documents for the detailed scope
TCB Designation		A1, A2, A3, A4, B1, B2, B3, B4, C
FCC DoC Accreditation		FCC Declaration of Conformity Accreditation
FCC Site Registration		3 meter site
FCC Site Registration		10 meter site
IC Site Registration		3 meter site
IC Site Registration		10 meter site
EU NB		Radio & Telecommunications Terminal Equipment: EN45001 – EN ISO/IEC 17025
		Electromagnetic Compatibility: EN45001 – EN ISO/IEC 17025
Singapore iDA CB(Certification Body)	 	Phase I, Phase II
Vietnam MIC CAB Accreditation		Please see the document for the detailed scope
Hong Kong OFCA		(Phase II) OFCA Foreign Certification Body for Radio and Telecom
		(Phase I) Conformity Assessment Body for Radio and Telecom
Industry Canada CAB		Radio: Scope A – All Radio Standard Specification in Category I
		Telecom: CS-03 Part I, II, V, VI, VII, VIII

Japan Recognized Certification Body Designation		<p>Radio: A1. Terminal equipment for purpose of calling</p> <p>Telecom: B1. Specified radio equipment specified in Article 38-2, Paragraph 1, Item 1 of the Radio Law</p>
Korea CAB Accreditation		<p>EMI: KCC Notice 2008-39, RRL Notice 2008-3: CA Procedures for EMI KN22: Test Method for EMI</p> <p>EMS: KCC Notice 2008-38, RRL Notice 2008-4: CA Procedures for EMS KN24, KN61000-4-2, -4-3, -4-4, -4-5, -4-6, -4-8, -4-11: Test Method for EMS</p>
		<p>Radio: RRL Notice 2008-26, RRL Notice 2008-2, RRL Notice 2008-10, RRL Notice 2007-49, RRL Notice 2007-20, RRL Notice 2007-21, RRL Notice 2007-80, RRL Notice 2004-68</p> <p>Telecom: President Notice 20664, RRL Notice 2007-30, RRL Notice 2008-7 with attachments 1, 3, 5, 6; President Notice 20664, RRL Notice 2008-7 with attachment 4</p>
Taiwan NCC CAB Recognition		LP0002, PSTN01, ADSL01, ID0002, IS6100, CNS14336, PLMN07, PLMN01, PLMN08
Taiwan BSMI CAB Recognition		CNS 13438
Japan VCCI		<p>R-3083: Radiation 3 meter site</p> <p>C-3421: Main Ports Conducted Interference Measurement</p> <p>T-1597: Telecommunication Ports Conducted Interference Measurement</p>
Australia CAB Recognition		<p>EMC: AS/NZS CISPR 11, AS/NZS CISPR 14.1, AS/NZS CISPR22, AS/NZS 61000.6.3, AS/NZS 61000.6.4</p>
		<p>Radio communications: AS/NZS 4281, AS/NZS 4268, AS/NZS 4280.1, AS/NZS 4280.2, AS/NZS 4295, AS/NZS 4582, AS/NZS 4583, AS/NZS 4769.1, AS/NZS 4769.2, AS/NZS 4770, AS/NZS 4771</p> <p>Telecommunications: AS/ACIF S002:05, AS/ACIF S003:06, AS/ACIF S004:06, AS/ACIF S006:01, AS/ACIF S016:01, AS/ACIF S031:01, AS/ACIF S038:01, AS/ACIF S040:01, AS/ACIF S041:05, AS/ACIF S043.2:06, AS/ACIF S60950.1</p>
Australia NATA Recognition		AS/ACIF S002, AS/ACIF S003, AS/ACIF S004, AS/ACIF S006, AS/ACIF S016, AS/ACIF S031, AS/ACIF S038, AS/ACIF S040, AS/ACIF S041, AS/ACIF S043.2