

MFA **M. Flom Associates, Inc. - Global Compliance Center**
3356 North San Marcos Place, Suite 107, Chandler, Arizona 85225-7176
www.mflom.com general@mflom.com (480) 926-3100, FAX: 926-3598

Date: October 1, 1999

Federal Communications Commission
EQUIPMENT APPROVAL SERVICES
P.O. Box 358315
Pittsburgh, PA 15251-5315

Attention: Authorization & Evaluation Division

Applicant: Telex Communications, Inc.
Equipment: TR-300
FCC ID: B5DM512
FCC Rules: 90.217

Gentlemen:

On behalf of the Applicant, enclosed please find Application Form 731, Engineering Test Report and all pertinent documentation, the whole for approval of the referenced equipment as shown.

Filing fees are attached.

We trust the same is in order. Should you need any further information, kindly contact the writer who is authorized to act as agent.

Sincerely yours,



William H. Graff, Director
of Engineering

enclosure(s)

ELECTRONICALLY FILED BY APPLICANT

cc: Applicant
WHG/cvr

FEDERAL COMMUNICATIONS COMMISSION

Approved by OMB
3060-0057

FCC FORM 731

For
FCC
use
only

APPLICATION FOR EQUIPMENT AUTHORIZATION

SECTION I - ALL ITEMS IN THIS SECTION MUST BE COMPLETED

1. Applicant's complete, legal business name		<input type="checkbox"/> Check here if this is a change in name and/or address not previously reported (See 47 CFR §2.934)	
TELEX COMMUNICATIONS, INC.			
2. Applicant's mailing address (Line 1)		Bureau Use Only	
8601 E. Cornhusker Highway		Equipment Code:	
Applicant's mailing address (Line 2) (if required)		Engineer:	
P.O. Box 5579		Examiner:	
City			
Lincoln,			
State or Country (if foreign address)	ZIP/Postal Code	3. FCC ID:	(b) Equipment Product Code
Nebraska	68505 5579	(a) Grantee Code	(14 characters maximum, show zeros as Ø)
		B 5 D	M512
4. Name, Title and Mail Stop, if any, of person at the applicant's address to receive grant, or for contact: (See instructions)			
Charlie Conner, Project Engineer			
5.(a) Telephone No. (Area/Country/City code, No. and Ext.)		5.(b) FAX No. (Area/Country/City code and No.)	
402 467 5321		402 467 3279	
(c) Internet e-mail address: <u>Charlie.conner@telex.com</u>			

SECTION II - See 47 CFR §1.1103 for Fee Type Codes and Fees. Fee Type Codes are listed in Paragraph C of the attached instructions.

Enter in Column (A) the correct Fee Type Code for the service for which you are applying. Enter in Column (C) the result obtained from multiplying the Fee amount for the Fee Type Code in Column (A) by the number entered in Column (B). If requesting more than ONE service, enter additional Fee Type Code(s) in Section III below.

	(A) FEE TYPE CODE	(B) FEE MULTIPLE	(C) FEE DUE FOR FEE TYPE CODE IN COLUMN (A)	FOR FCC USE ONLY
(1)	E F T	0 0 0 1	\$ 475.00	

SECTION III - Use when requesting more than one service. If only one service is requested, complete only Section II and Section III, Item (5).

	(A) FEE TYPE CODE	(B) FEE MULTIPLE	(C) FEE DUE FOR FEE TYPE CODE IN COLUMN (A)	FOR FCC USE ONLY
(2)		0 0 0 1	\$	
(3)		0 0 0 1	\$	
(4)		0 0 0 1	\$	
(5)	Add all amounts shown in column C, lines (1) through (4), and enter the total here. This amount should equal your enclosed remittance.		TOTAL AMOUNT REMITTED WITH THIS APPLICATION OR FILING \$ 475.00	FOR FCC USE ONLY

SECTION IV - Enter FCC ID from Page 1, Section I ▶ B5DM512

1.(a) Instead of Applicant, FCC is authorized to mail original Grant to: (See instructions)
 Firm name, **M. FLOM ASSOCIATES, INC.**
 number, street, **3356 N. San Marcos Place, Suite 107**
 City, State/Country, **CHANDLER, ARIZONA, U.S.A.**
 ZIP/Postal Code **85225-1571**

(b) Name, Title and Mail Stop, if any, of person at above address to receive Grant: (If 1.(a) is completed, this item must be completed)

MORTON FLOM, P. Eng., President

2.(a) Technical contact: Firm name, contact person, number, street, City, State/Country, ZIP/Postal Code	M. FLOM ASSOCIATES, INC. MORTON FLOM, President 3356 No. San Marcos Place, #107 CHANDLER, ARIZONA, U.S.A. 85225 1571	(b) Telephone No. (Area/Country/City code, No. and Ext.) 1 480 926 3100
		(c) FAX No. (Area/Country/City code and No.) 1 480 926 3598

(d) Internet e-mail address: **www.mflom.com** e-mail: **general@mflom.com**

2.(e) Non-Technical contact: Firm name, contact person, number, street, City, State/Country, ZIP/Postal Code	M. FLOM ASSOCIATES, INC. MORTON FLOM, President 3356 No. San Marcos Place, #107 CHANDLER, ARIZONA, U.S.A. 85225 1571	(f) Telephone No. (Area/Country/City code, No. and Ext.) 1 480: 926 3100
		(g) FAX No. (Area/Country/City code and No.) 1 480: 926 3598

(h) Internet e-mail address: **www.mflom.com** e-mail: **general@mflom.com**

3. Does this application include a request for confidentiality for any portion(s) of the data contained in this application pursuant to 47 CFR §0.459 of the Commission's Rules? If "Yes" see instructions. Yes No

4. Does the applicant request that the Commission defer grant of this application pursuant to 47 CFR §0.457(d)(1)(ii)? (See instructions) Yes No

5. Type of equipment authorization requested: (check one box only) Certification Type Acceptance Notification

6.(a) Equipment Code and description: (See instructions, page 4) T N T Non-Broadcast Transmitter-won on (BELT-PACK TRANSCEIVER)	6.(b) Equipment will be operated under FCC Rule Part(s): body 90.217
--	--

7. Application is for: (Check one box only)

<input checked="" type="checkbox"/> 1. Original equipment (See instructions)	<input type="checkbox"/> 2. Change in identification of presently authorized equipment	<input type="checkbox"/> 3. Class II permissive change or modification of presently authorized equipment (See instructions)
	ORIGINAL FCC ID Grant date	

8. EQUIPMENT SPECIFICATIONS: (See instructions)				
(a) Frequency range in MHz	(b) Rated RF power output in watts	(c) Frequency tolerance %, Hz, ppm	(d) Emission designator (See 47 CFR §2.201 and §2.202)	(e) Microprocessor model number
150 - 174	.050 Watts	±50 ppm	36K0F3E	n.A

9. Is the equipment in this application:
 (a) a composite device subject to more than one type of equipment authorization? Yes No

(b) part of a system that operates with, or is marketed with, another device that requires an equipment authorization? Yes No

If either of the above questions is answered "Yes" complete items 10.(a) and (b). (See instructions)

SECTION IV (continued) - Enter FCC ID from Page 1, Section I

B5DM512

10.(a) Additional type of equipment authorization required:

- Certification, Type Acceptance, Notification

(b) The related application checked in item 10.(a) (Check one box only)

- has been filed at the same time as this application under the FCC ID listed below
has been granted under the FCC ID listed below
is in the process of being filed under the FCC ID listed below
is pending with the FCC under the FCC ID listed below

FCC ID

11.(a) Name of test firm on file with the FCC, if different from applicant or contact person:

M. FLOM ASSOCIATES, INC. (FCC FILE: 31040/SIT)

(b) Mailing address, number, street, City, State/Country, ZIP/Postal Code
3356 N. San Marcos Place #107
CHANDLER, ARIZONA, U.S.A.
85225-1571

(c) Telephone No. (Area/Country/City code, No. and Ext.)

1 480: 926 3100

(d) FAX No. (Area/Country/City code and No.)

1 480: 926 3598

(e) Internet e-mail address: www.mflom.com e-mail: general@mflom.com

12. Number of exhibits submitted with this application:

SECTION V - Read each certification carefully before answering and signing this application.

WILLFUL FALSE STATEMENTS MADE ON THIS FORM ARE PUNISHABLE BY FINE AND/OR IMPRISONMENT (U.S. CODE, TITLE 18, SECTION 1001), AND/OR REVOCATION OF ANY STATION LICENSE OR CONSTRUCTION PERMIT (U.S. CODE, TITLE 47, SECTION 312(a)(1)), AND/OR FORFEITURE (U.S. CODE, TITLE 47, SECTION 503).

1. SECTION 5301 (ANTI-DRUG ABUSE) CERTIFICATION:

The applicant must certify that neither the applicant nor any party to the application is subject to a denial of Federal benefits, that include FCC benefits, pursuant to Section 5301 of the Anti-Drug Abuse Act of 1988, 21 U.S.C. §862 because of a conviction for possession or distribution of a controlled substance. See 47 CFR 1.2002(b) for the definition of a "party" for these purposes.

Does the applicant or authorized agent so certify? [X] Yes [] No

2.(a) APPLICANT/AGENT CERTIFICATION:

I certify that I am authorized to sign this application. All of the statements herein and the exhibits attached hereto, are true and correct to the best of my knowledge and belief. In accepting a Grant of Equipment Authorization issued by the FCC as a result of the representations made in this application, the applicant is responsible for (1) labeling the equipment with the exact FCC ID specified in this application, (2) compliance statement labeling pursuant to the applicable rules, and (3) compliance of the equipment with the applicable technical rules. If the applicant is not the actual manufacturer of the equipment, appropriate arrangements have been made with the manufacturer to ensure that production units of this equipment will continue to comply with the FCC's technical requirements.

Authorizing an agent to sign this application, is done solely at the applicant's discretion; however, the applicant remains responsible for all statements in this application.

If an agent has signed this application on behalf of the applicant, a written letter of authorization which includes information to enable the agent to respond to the above Section 5301 (Anti-Drug Abuse) Certification statement has been provided by the applicant. It is understood that the letter of authorization must be submitted to the FCC upon request, and that the FCC reserves the right to contact the applicant directly at any time.

[Handwritten signature]
Original written signature of authorized signer

September 30th, 1999.

▲ Date (Month, Day, Year)

a. MORTON FLOM, P. Eng., President

PRESIDENT -or- Director-Operations

or b. Typed/printed name of authorized signer

▲ Title of authorized signer

▼ Complete items below if an agent signs the application.

(b) Agent's business name, number, street, City, State/Country, ZIP/Postal Code
M. FLOM ASSOCIATES, INC.
3356 N. San Marcos Place, #107
Chandler, Arizona, U.S.A.
85225-1571

(c) Telephone No. (Area/Country/City code, No. and Ext.)

1 480: 926-3100

(d) FAX No. (Area/Country/City code and No.)

1 480: 926-3598

(e) Internet e-mail address: www.mflom.com e-mail: general@mflom.com

June 11, 1998

Federal Communication Commission
Authorization & Evaluation Division
7435 Oakland Mills Road
Columbia, Maryland 21046

8601 E. Cornhusker Highway
PO. Box 5579
Lincoln, Nebraska 68505 USA
Telephone 402-467-5321
Telex 48-4324 Hygain Lon a
Fax 402-467-3279

Gentlemen:

This letter will authorize the appointment of MORTON FLOM, P. Eng., and/or M. Flom Associates, Inc. to act as our Agent in all FCC matters.

This appointment is effective until otherwise notified by us.

This is to advise that we are in full compliance with the Anti-Drug Abuse Act. The Applicant is not subject to a denial of federal benefits pursuant to Section 5301 of the Anti-Drug Abuse Act of 1988, 21 USC 862, and no party to the application is subject to a denial of federal benefits pursuant to that section.

Sincerely,
TELEX COMMUNICATIONS, INC.



Charles E. Conner
Project Engineer
e-mail: Charlie.conner@telex.com

REVISIONS	
CHG. NO. LTR.	DESCRIPTION
DATE	APPD.

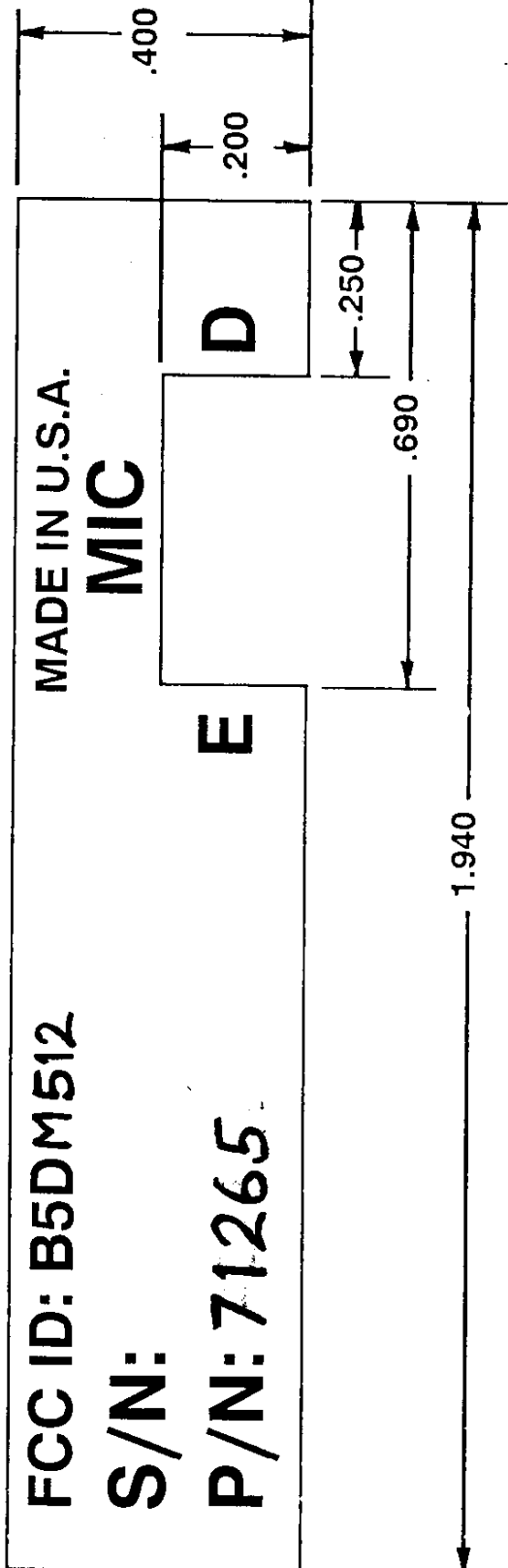

4. ARTWORK IS REVISION A
 3. TELEX LINCOLN TO SUPPLY ARTWORK.
 2. ADHESIVE: PRESSURE SENSITIVE WITH PAPER RELEASE LINER
 1. MATERIAL: .002 SILVER MYLAR WITH MATTE CLEAR COAT
6. S/N TO BE SCREENED IN BY SUPPLIER. NUMERALS TO START AT 1000 AND WILL BE IN SEQUENCE AS PER TELEX SUPPLIED INFORMATION. NUMERALS TO BE 3/32" TALL.
 5. COLOR: SILVER BACKGROUND WITH BLACK LETTERING

NOTES:

QTY.	DESCRIPTION	ITEM	PART NO.	SPECIFICATION
	DATE	7-13-99		
	DR BY	JTN		TELEX hygain <small>TELEX COMMUNICATIONS INC LINCOLN, NEBRASKA U.S.A.</small>
	CHK BY			TITLE
	APPD.	JRC 7-13-99		LABEL, CASE TR-300
	PROD.			SIZE
	TOLERANCES UNLESS OTHERWISE SPECIFIED			CODE IDENT
	FRACTION			A
	DECIMAL ± .010			57010
	ANGLE			DWG. NO.
	MATL.			
	TR-300			
	USED ON			
	APPLICATION			

This drawing, written description or specification represents a proprietary product of TELEX, Lincoln, Nebr., and shall not be released, disclosed, used nor duplicated without the written permission of TELEX.

MFA **M. Flom Associates, Inc. - Global Compliance Center**
3356 North San Marcos Place, Suite 107, Chandler, Arizona 85225-7176
www.mflom.com general@mflom.com (480) 926-3100, FAX: 926-3598

Sub-part
2.1033(c) :

EQUIPMENT IDENTIFICATION

FCC ID: B5DM512

NAMEPLATE DRAWING

ATTACHED, EXHIBIT 1.

LOCATION

AS PER LABEL DRAWING(S)

DATE OF REPORT

October 1, 1999

SUPERVISED BY:



William H. Graff, Director
of Engineering

THE APPLICANT HAS BEEN CAUTIONED AS TO THE FOLLOWING:

15.21 INFORMATION TO USER.

The users manual or instruction manual for an intentional radiator shall caution the user that changes or modifications not expressly approved by the party responsible for compliance could void the user's authority to operate the equipment.

15.27(a) SPECIAL ACCESSORIES.

Equipment marketed to a consumer must be capable of complying with the necessary regulations in the configuration in which the equipment is marketed. Where special accessories, such as shielded cables and/or special connectors are required to enable an unintentional or intentional radiator to comply with the emission limits in this part, the equipment must be marketed with, i.e. shipped and sold with, those special accessories. However, in lieu of shipping or packaging the special accessories with the unintentional or intentional radiator, the responsible party may employ other methods of ensuring that the special accessories are provided to the consumer, without additional charge.

Information detailing any alternative method used to supply the special accessories for a grant of equipment authorization or retained in the verification records, as appropriate. The party responsible for the equipment, as detailed in § 2.909 of this chapter, shall ensure that these special accessories are provided with the equipment. The instruction manual for such devices shall include appropriate instructions on the first page of text concerned with the installation of the device that these special accessories must be used with the device. It is the responsibility of the user to use the needed special accessories supplied with the equipment.

TABLE OF CONTENTS

<u>RULE</u>	<u>DESCRIPTION</u>	<u>PAGE</u>
	Test Report	1
2.1033(c)	General Information Required	2
2.1033(c)(14)	Rule Summary	5
	Standard Test Conditions and Engineering Practices	6
2.1046(a)	Carrier Output Power (Radiated)	7
2.1053(a)	Field Strength of Spurious Radiation	9
2.1049(c)(1)	Emission Masks (Occupied Bandwidth)	12
2.1047(a)	Audio Frequency Response	17
2.1047(b)	Modulation Limiting	19
2.1055(a)(1)	Frequency Stability (Temperature Variation)	21
2.1055(b)(1)	Frequency Stability (Voltage Variation)	24
2.202(g)	Necessary Bandwidth and Emission Bandwidth	25

PAGE NO. 1 of 25.

Required information per ISO/IEC Guide 25-1990, paragraph 13.2:

- a) TEST REPORT
- b) Laboratory: M. Flom Associates, Inc.
 (FCC: 31040/SIT) 3356 N. San Marcos Place, Suite 107
 (Canada: IC 2044) Chandler, AZ 85224
- c) Report Number: d99a0002
- d) Client: Telex Communications, Inc.
 8601 E. Cornhusker Highway
 P.O. Box 5579
 Lincoln, NE 68505-5579
- e) Identification: TR-300
 FCC ID: B5DM512
 Description: Hand Held Wireless Microphone
- f) EUT Condition: Not required unless specified in individual tests.
- g) Report Date: October 1, 1999
 EUT Received: September 3, 1999
- h, j, k): As indicated in individual tests.
- i) Sampling method: No sampling procedure used.
- l) Uncertainty: In accordance with MFA internal quality manual.
- m) Supervised by: 
 William H. Graff, Director
 of Engineering
- n) Results: The results presented in this report relate only to the item tested.
- o) Reproduction: This report must not be reproduced, except in full, without written permission from this laboratory.

PAGE NO. 2 of 25.

LIST OF GENERAL INFORMATION REQUIRED FOR CERTIFICATION

IN ACCORDANCE WITH FCC RULES AND REGULATIONS,
VOLUME II, PART 2 AND TO

90.217

Sub-part 2.1033

(c) (1): NAME AND ADDRESS OF APPLICANT:

Telex Communications, Inc.
8601 E. Cornhusker Highway
P.O. Box 5579
Lincoln, NE 68505-5579

MANUFACTURER:

Applicant

(c) (2): FCC ID: B5DM512

MODEL NO: TR-300

(c) (3): INSTRUCTION MANUAL(S):

PLEASE SEE ATTACHED EXHIBITS

(c) (4): TYPE OF EMISSION: 36K0F3E

(c) (5): FREQUENCY RANGE, MHz: 150 to 174

(c) (6): POWER RATING, Watts: 0.050
 Switchable Variable N/A

(c) (7): MAXIMUM POWER RATING, Watts: 0.120

M. Flom Associates, Inc. is accredited by the American Association for Laboratory Association (A2LA) as shown in the scope below.



THE AMERICAN ASSOCIATION FOR LABORATORY ACCREDITATION

ACCREDITED LABORATORY

A2LA has accredited

M. FLOM ASSOCIATES, INC.
Chandler, AZ

for technical competence in the field of

Electrical (EMC) Testing

The accreditation covers the specific tests and types of tests listed on the agreed scope of accreditation. This laboratory meets the requirements of ISO/IEC Guide 25:1990 "General Requirements for the Competence of Calibration and Testing Laboratories" (equivalent to relevant requirements of the ISO 9000 series of standards) and any additional program requirements in the identified field of testing.

Presented this 24th day of November, 1998.



Peter Almy
President
For the Accreditation Council
Certificate Number 1008.01
Valid to December 31, 2000

For tests or types of tests to which this accreditation applies, please refer to the laboratory's Electrical (EMC) Scope of Accreditation



American Association for Laboratory Accreditation

SCOPE OF ACCREDITATION TO ISO/IEC GUIDE 25:1990 AND EN 45001

M. FLOM ASSOCIATES, INC.
Electromagnetic Testing Laboratory
2156 North Sun Marlowe Place, Suite 107
Chandler, AZ 85226-1573
Morton Flom Phone 602 936 3100

ELECTRICAL (EMC)

Valid to: December 31, 2000 Certificate Number: 1008-01

In recognition of the successful completion of the A2LA evaluation process, accreditation is granted to this laboratory to perform the following ~~services~~ **standards**:

Test	Standard(s)
RF Emissions	FCC Part 15 (Subparts B and C) using ANSI C63.4-1993; CISPR 11; CISPR 13; CISPR 14; CISPR 22; EN 55018; EN 55013; EN 55014; EN 55022; EN 55081-1; EN 55081-2; FCC Part 15; FCC 47 CFR 15.107; AS/NZS 1616; AS/NZS 1610; AS/NZS 3544; AS/NZS 4511.1
RF Immunity	EN 50082-1; EN 55082-2; AS/NZS 4511.1
Radiated Susceptibility	EN 61000-4-3; EN 55140; EN 55140; EN 55140; IEC 1000-4-3; IEC 801-3
ESD	EN 61000-4-2; IEC 1000-4-2; IEC 801-2
EFT	EN 61000-4-4; IEC 1000-4-4; IEC 801-4
Surge	EN 61000-4-5; EN 55142; IEC 1000-4-5; IEC 801-5
47 CFR (FCC)	2, 21, 22, 23, 24, 74, 80, 87, 90, 95, 97

Peter Almy

5301 Sudleytown Pike, Suite 358 • Frederick, MD 21784-8397 • Phone: 301 664 3208 • Fax: 301 662 2974

"This laboratory is accredited by the American Association for Laboratory Accreditation (A2LA) and the results shown in this report have been determined in accordance with the laboratory's terms of accreditation unless stated otherwise in the report."

Should this report contain any data for tests for which we are not accredited, or which have been undertaken by a subcontractor that is not A2LA accredited, such data would not covered by this laboratory's A2LA accreditation.

PAGE NO. 4 of 25.

Subpart 2.1033 (continued)

(c) (8): VOLTAGES & CURRENTS IN ALL ELEMENTS IN FINAL R. F. STAGE, INCLUDING FINAL TRANSISTOR OR SOLID STATE DEVICE:

COLLECTOR CURRENT, A = per manual
 COLLECTOR VOLTAGE, Vdc = per manual
 SUPPLY VOLTAGE, Vdc = 9

(c) (9): TUNE-UP PROCEDURE:

PLEASE SEE ATTACHED EXHIBITS

(c) (10): CIRCUIT DIAGRAM/CIRCUIT DESCRIPTION:

Including description of circuitry & devices provided for determining and stabilizing frequency, for suppression of spurious radiation, for limiting modulation and limiting power.

PLEASE SEE ATTACHED EXHIBITS

(c) (11): LABEL INFORMATION:

PLEASE SEE ATTACHED EXHIBITS

(c) (12): PHOTOGRAPHS:

PLEASE SEE ATTACHED EXHIBITS

(c) (13): DIGITAL MODULATION DESCRIPTION:

ATTACHED EXHIBITS
 N/A

(c) (14): TEST AND MEASUREMENT DATA:

FOLLOWS

PAGE NO.

5 of 25.

Sub-part
2.1033(c) (14):TEST AND MEASUREMENT DATA

All tests and measurement data shown were performed in accordance with FCC Rules and Regulations, Volume II; Part 2, Sub-part J, Sections 2.947, 2.1033(c), 2.1041, 2.1046, 2.1047, 2.1079, 2.1051, 2.1053, 2.1055, 2.1057 and the following individual Parts:

- _____ 21 - Domestic Public Fixed Radio Services
- _____ 22 - Public Mobile Services
- _____ 22 Subpart H - Cellular Radiotelephone Service
- _____ 22.901(d) - Alternative technologies and auxiliary services
- _____ 23 - International Fixed Public Radiocommunication services
- _____ 24 - Personal Communications Services
- _____ 74 Subpart H - Low Power Auxiliary Stations
- _____ 80 - Stations in the Maritime Services
- _____ 80 Subpart E - General Technical Standards
- _____ 80 Subpart F - Equipment Authorization for Compulsory Ships
- _____ 80 Subpart K - Private Coast Stations and Marine Utility Stations
- _____ 80 Subpart S - Compulsory Radiotelephone Installations for Small Passenger Boats
- _____ 80 Subpart T - Radiotelephone Installation Required for Vessels on the Great Lakes
- _____ 80 Subpart U - Radiotelephone Installations Required by the Bridge-to-Bridge Act
- _____ 80 Subpart V - Emergency Position Indicating Radiobeacons (EPIRB'S)
- _____ 80 Subpart W - Global Maritime Distress and Safety System (GMDSS)
- _____ 80 Subpart X - Voluntary Radio Installations
- _____ 87 - Aviation Services
- _____ x 90 - Private Land Mobile Radio Services
- _____ 94 - Private Operational-Fixed Microwave Service
- _____ 95 Subpart A - General Mobile Radio Service (GMRS)
- _____ 95 Subpart C - Radio Control (R/C) Radio Service
- _____ 95 Subpart D - Citizens Band (CB) Radio Service
- _____ 95 Subpart E - Family Radio Service
- _____ 95 Subpart F - Interactive Video and Data Service (IVDS)
- _____ 97 - Amateur Radio Service
- _____ 101 - Fixed Microwave Services

PAGE NO.

6 of 25.

STANDARD TEST CONDITIONS
and
ENGINEERING PRACTICES

Except as noted herein, the following conditions and procedures were observed during the testing:

In accordance with ANSI C63.4-1992, section 6.1.9, and unless otherwise indicated in the specific measurement results, the ambient temperature of the actual EUT was maintained within the range of 10° to 40°C (50° to 104 °F) unless the particular equipment requirements specify testing over a different temperature range. Also, unless otherwise indicated, the humidity levels were in the range of 10% to 90% relative humidity.

Prior to testing, the EUT was tuned up in accordance with the manufacturer's alignment procedures. All external gain controls were maintained at the position of maximum and/or optimum gain throughout the testing.

Measurement results, unless otherwise noted, are worst case measurements.

PAGE NO. 7 of 25.
NAME OF TEST: Carrier Output Power (Conducted)
SPECIFICATION: 47 CFR 2.1046(a)
GUIDE: ANSI/TIA/EIA-603-1992, Paragraph 2.2.1
TEST EQUIPMENT: As per attached page

MEASUREMENT PROCEDURE

1. The EUT was connected to a resistive coaxial attenuator of normal load impedance, and the unmodulated output power was measured by means of an R. F. Power Meter.
2. Measurement accuracy is $\pm 3\%$.

MEASUREMENT RESULTS
(Worst case)

FREQUENCY OF CARRIER, MHz = 171.9

<u>POWER SETTING</u>	<u>R. F. POWER, WATTS</u>
High	0.050

SUPERVISED BY:

William H. Graff, Director
of Engineering

TRANSMITTER RADIATED MEASUREMENTS

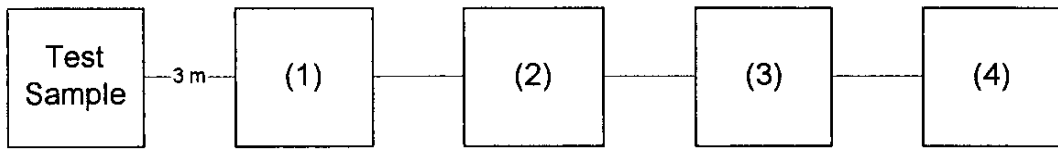

Transmitter Radiated Measurements

Asset	Description	s/n
<u>(1) TRANSDUCER</u>		
_____	i00091 Emco 3115	001469
<u>x</u>	i00089 Aprel Log Periodic	001500
<u>x</u>	i00088 Emco 3109-B	2336
<u>(2) HIGH PASS FILTER</u>		
_____	i00 Narda µPAD (In-Band Only)	
_____	i00 Trilithic	
_____	(Out-Of-Band Only)	
<u>(3) PREAMP</u>		
_____	i00028 HP 8449 (+30 dB)	2749A00121
<u>(4) SPECTRUM ANALYZER</u>		
<u>x</u>	i00048 HP 8566B	2511A01467
_____	i00043 HP 8558B	2004A02076
_____	i00057 HP 8557A	1531A00191
_____	i00029 HP 8563E	3213A00104

PAGE NO. 9 of 25.
NAME OF TEST: Field Strength of Spurious Radiation
SPECIFICATION: 47 CFR 2.1053(a)
GUIDE: ANSI/TIA/EIA-603-1992, Paragraph 2.2.12
TEST EQUIPMENT: As per attached page

MEASUREMENT PROCEDURE

1. A description of the measurement facilities was filed with the FCC and was found to be in compliance with the requirements of Section 2.948, by letter from the FCC dated March 3, 1997, FILE 31040/SIT. All pertinent changes will be reported to the Commission by up-date prior to March 2000.
2. At first, in order to locate all spurious frequencies and approximate amplitudes, and to determine proper equipment functioning, the test sample was set up at a distance of three meters from the test instrument. Valid spurious signals were determined by switching the power on and off.
3. In the field, the test sample was placed on a wooden turntable above ground at three (or thirty) meters away from the search antenna. Excess power leads were coiled near the power supply.

The cables were oriented in order to obtain the maximum response. At each emission frequency, the turntable was rotated and the search antennas were raised and lowered vertically.
4. The emission was observed with both a vertically polarized and a horizontally polarized search antenna and the worst case was used.
6. The field strength of each emission within 20 dB of the limit was recorded and corrected with the appropriate cable and transducer factors.
7. The worst case for all channels is shown.
8. Measurement results: ATTACHED FOR WORST CASE

RADIATED TEST SETUP

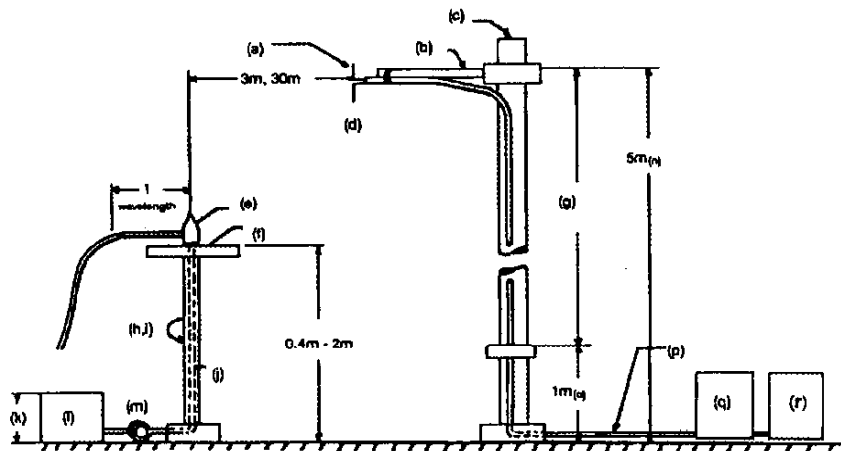

NOTES:

- (a) Search Antenna - Rotatable on boom
- (b) Non-metallic boom
- (c) Non-metallic mast
- (d) Adjustable horizontally
- (e) Equipment Under Test
- (f) Turntable
- (g) Boom adjustable in height.
- (h) External control cables routed horizontally at least one wavelength.
- (i) Rotatable
- (j) Cables routed through hollow turntable center
- (k) 30 cm or less
- (l) External power source
- (m) 10 cm diameter coil of excess cable
- (n) 25 cm (V), 1 m-7 m (V, H)
- (o) 25 cm from bottom end of 'V', 1m normally
- (p) Calibrated Cable at least 10m in length
- (q) Amplifier (optional)
- (r) Spectrum Analyzer

Asset	Description	s/n	Cycle	Last Cal
<u>TRANSDUCER</u>				
i00065	EMCO 3301B Active Monopole	2635	12 mo.	
i00033	Singer 94593-1 10kHz-32MHz	0219	12 mo.	
x i00088	EMCO 3109-B 25MHz-300MHz	2336	12 mo.	Oct-98
x i00089	Apral 2001 200MHz-1GHz	001500	12 mo.	Oct-98
x i00103	EMCO 3115 1GHz-18GHz	9208-3925	12 mo.	Oct-98
i00085	EMCO 3116 10GHz-40GHz	2076	12 mo.	
<u>AMPLIFIER</u>				
i00028	HP 8449A	2749A00121	12 mo.	Mar-99
<u>SPECTRUM ANALYZER</u>				
i00029	HP 8563E	3213A00104	12 mo.	Aug-99
x i00033	HP 85462A	3625A00357	12 mo.	May-99
i00048	HP 8566B	2511AD1467	6 mo.	May-99

PAGE NO. 11 of 25.

NAME OF TEST: Field Strength of Spurious Radiation
 g9990120: 1999-Sep-10 Fri 11:05:00
 STATE: 2:High Power

FREQUENCY TUNED, MHz	FREQUENCY EMISSION, MHz	METER, dBuV	CF, dB	ERP, dBm	MARGIN, dB
171.900000	343.805000	32.41	20.87	-44.05	-31.1
171.900000	515.705000	28.26	24.32	-44.75	-31.8
171.900000	687.608000	30.61	28.27	-38.45	-25.5
171.900000	859.512250	10.28	30.08	-57.05	-44
171.900000	1031.414800	4.3	32.23	-60.85	-47.9
171.900000	1203.317480	-8.36	34.35	-71.35	-58.4
171.900000	1375.219800	9.6	36.25	-51.55	-38.6
171.900000	1547.123450	-1.14	37.95	-60.55	-47.6
171.900000	1719.026200	-10.7	39.52	-68.55	-55.6

PAGE NO. 12 of 25.
NAME OF TEST: Emission Masks (Occupied Bandwidth)
SPECIFICATION: 47 CFR 2.1049(c) (1)
GUIDE: ANSI/TIA/EIA-603-1992, Paragraph 2.2.11
TEST EQUIPMENT: As per previous page

MEASUREMENT PROCEDURE

1. The EUT and test equipment were set up as shown on the following page, with the Spectrum Analyzer connected.
2. For EUTs supporting audio modulation, the audio signal generator was adjusted to the frequency of maximum response and with output level set for ± 2.5 kHz deviation (or 50% modulation). With level constant, the signal level was increased 16 dB.
3. For EUTs supporting digital modulation, the digital modulation mode was operated to its maximum extent.
4. The Occupied Bandwidth was measured with the Spectrum Analyzer controls set as shown on the test results.
5. MEASUREMENT RESULTS: ATTACHED

PAGE NO.

13 of 25.

NAME OF TEST: Emission Masks (Occupied Bandwidth)
g9990123: 1999-Sep-17 Fri 09:25:00
STATE: 2:High Power

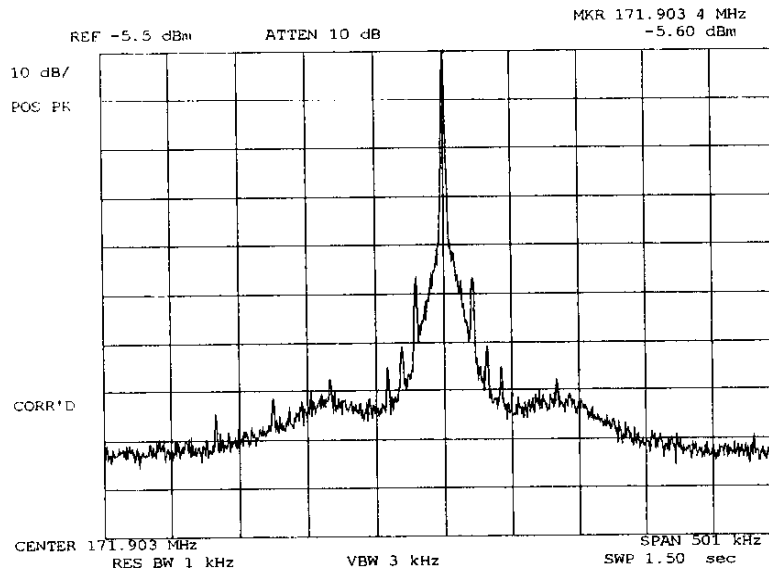

POWER:
MODULATION:

HIGH
NONE

SUPERVISED BY:

William H. Graff, Director
of Engineering

PAGE NO.

14 of 25.

NAME OF TEST: Emission Masks (Occupied Bandwidth)
g9990124: 1999-Sep-17 Fri 09:27:00
STATE: 2:High Power

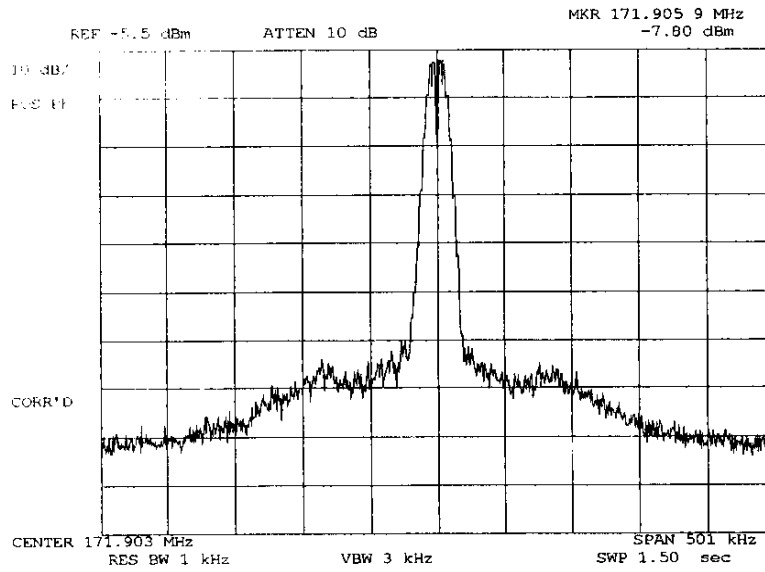

POWER:
MODULATION:

HIGH
2500 HZ @ 20 DB ABOVE
REFERENCE LEVEL

SUPERVISED BY:

William H. Graff, Director
of Engineering

PAGE NO.

15 of 25.

NAME OF TEST: Emission Masks (Occupied Bandwidth)
g9990125: 1999-Sep-17 Fri 09:29:00
STATE: 2:High Power

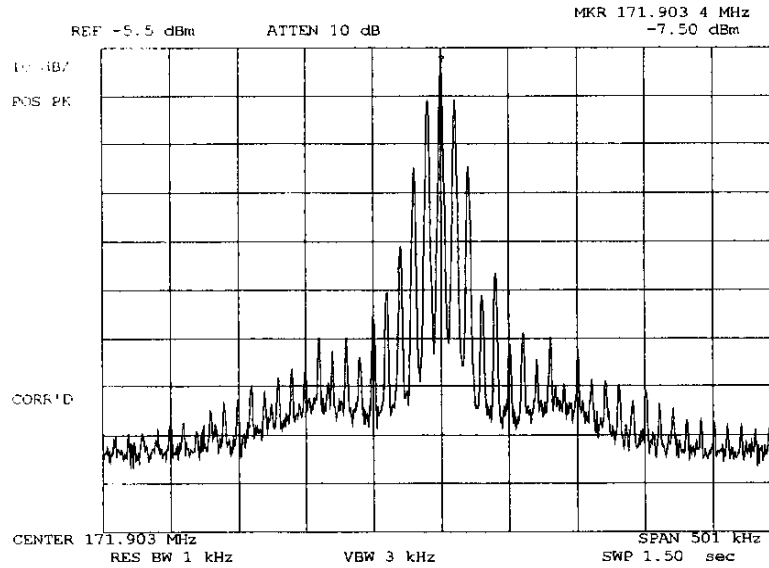

POWER:
MODULATION:

HIGH
10000 HZ @ 20 DB ABOVE
REFERENCE LEVEL

SUPERVISED BY:

William H. Graff, Director
of Engineering

PAGE NO.

16 of 25.

NAME OF TEST: Emission Masks (Occupied Bandwidth)
g9990126: 1999-Sep-17 Fri 09:32:00
STATE: 2:High Power

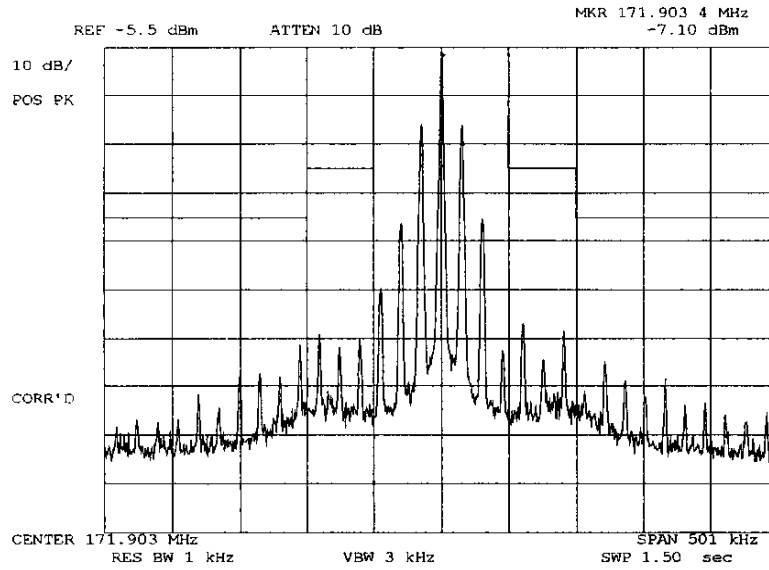

POWER:
MODULATION:

HIGH
15000 HZ @ 20 DB ABOVE
REFERENCE LEVEL

SUPERVISED BY:

William H. Graff, Director
of Engineering

PAGE NO. 17 of 25.
NAME OF TEST: Audio Frequency Response
SPECIFICATION: 47 CFR 2.1047(a)
GUIDE: ANSI/TIA/EIA-603-1992, Paragraph 2.2.6
TEST EQUIPMENT: As per previous page

MEASUREMENT PROCEDURE

1. The EUT and test equipment were set up as shown on the following page.
2. The audio signal generator was connected to the audio input circuit/microphone of the EUT.
3. The audio signal input was adjusted to obtain 20% modulation at 1 kHz, and this point was taken as the 0 dB reference level.
4. With input levels held constant and below limiting at all frequencies, the audio signal generator was varied from 100 Hz to 50 kHz.
5. The response in dB relative to 1 kHz was then measured, using the HP 8901A Modulation Analyzer.
6. MEASUREMENT RESULTS: ATTACHED

PAGE NO. 18 of 25.

NAME OF TEST: Audio Frequency Response
 g9990115: 1999-Sep-17 Fri 08:39:00
 STATE: 0:General

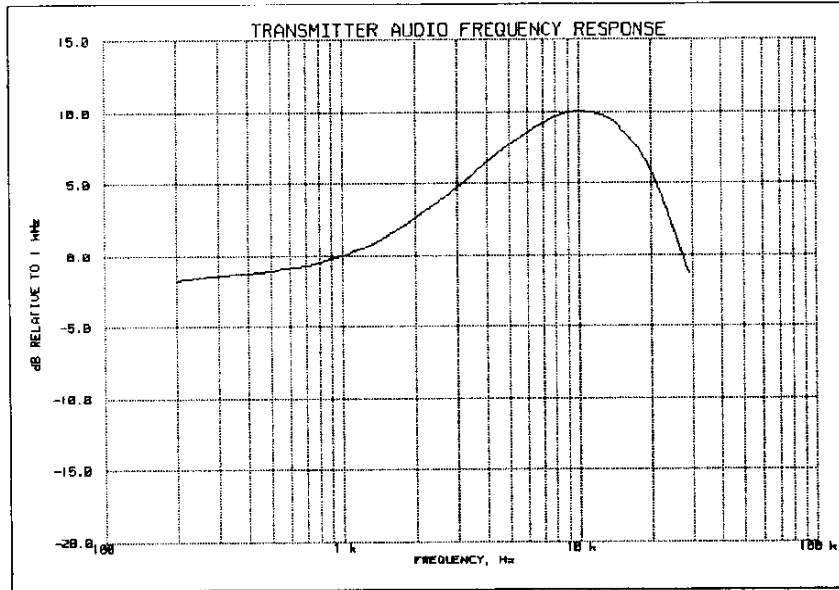

Frequency of Maximum Response: 10,000 Hz

Additional points:

FREQUENCY, Hz	LEVEL, dB
300	-1.38
20000	5.89
30000	-1.72
50000	-3.94

SUPERVISED BY:

William H. Graff, Director
 of Engineering

PAGE NO. 19 of 25.
NAME OF TEST: Modulation Limiting
SPECIFICATION: 47 CFR 2.1047(b)
GUIDE: ANSI/TIA/EIA-603-1992, Paragraph 2.2.3
TEST EQUIPMENT: As per previous page

MEASUREMENT PROCEDURE

1. The signal generator was connected to the input of the EUT as for "Frequency Response of the Modulating Circuit."
2. The modulation response was measured for each of three frequencies (one of which was the frequency of maximum response), and the input voltage was varied and was observed on an HP 8901A Modulation Analyzer.
3. The input level was varied from 30% modulation (± 1.5 kHz deviation) to at least 20 dB higher than the saturation point.
4. Measurements were performed for both negative and positive modulation and the respective results were recorded.
5. MEASUREMENT RESULTS: ATTACHED

PAGE NO.

20 of 25.

NAME OF TEST: Modulation Limiting
g9990116: 1999-Sep-17 Fri 08:47:00
STATE: 0:General

Positive
Peaks:

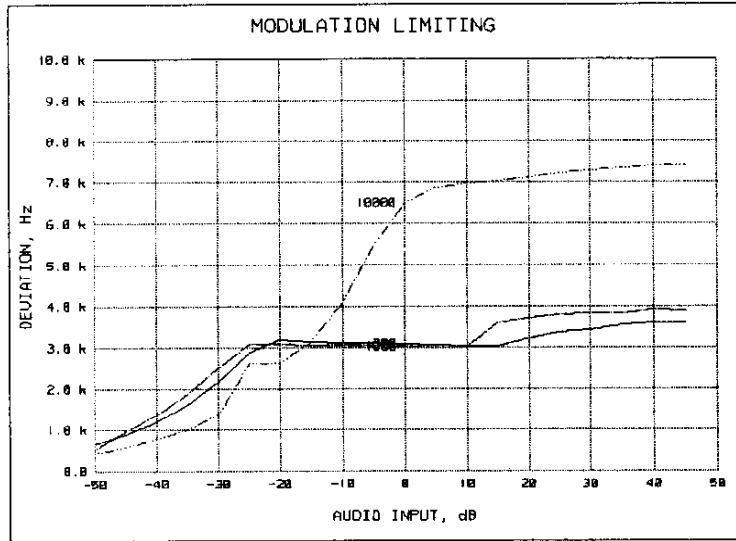

Negative
Peaks:

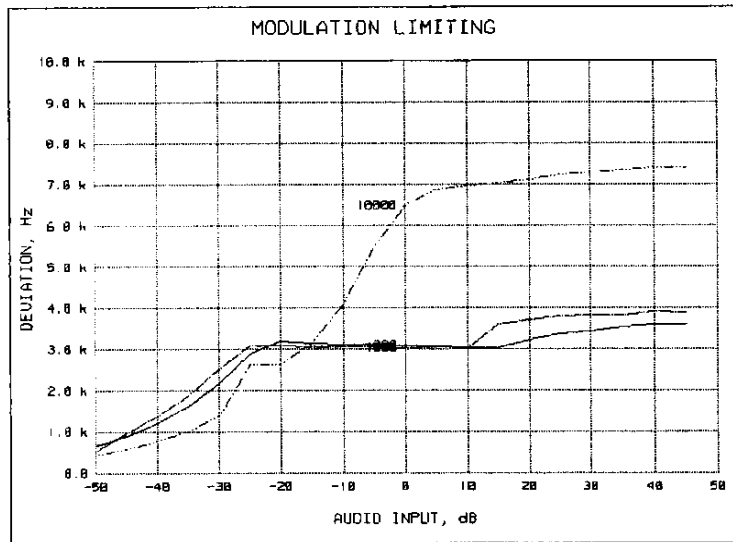

SUPERVISED BY:

William H. Graff, Director
of Engineering

PAGE NO. 21 of 25.
NAME OF TEST: Frequency Stability (Temperature Variation)
SPECIFICATION: 47 CFR 2.1055(a) (1)
GUIDE: ANSI/TIA/EIA-603-1992, Paragraph 2.2.2
TEST CONDITIONS: As Indicated
TEST EQUIPMENT: As per previous page

MEASUREMENT PROCEDURE

1. The EUT and test equipment were set up as shown on the following page.
2. With all power removed, the temperature was decreased to -30°C and permitted to stabilize for three hours. Power was applied and the maximum change in frequency was noted within one minute.
3. With power OFF, the temperature was raised in 10°C steps. The sample was permitted to stabilize at each step for at least one-half hour. Power was applied and the maximum frequency change was noted within one minute.
4. The temperature tests were performed for the worst case.
5. MEASUREMENT RESULTS: ATTACHED

TRANSMITTER TEST SET-UP

- TEST A. OPERATIONAL STABILITY
- TEST B. CARRIER FREQUENCY STABILITY
- TEST C. OPERATIONAL PERFORMANCE STABILITY
- TEST D. HUMIDITY
- TEST E. VIBRATION
- TEST F. ENVIRONMENTAL TEMPERATURE
- TEST G. FREQUENCY STABILITY: TEMPERATURE VARIATION
- TEST H. FREQUENCY STABILITY: VOLTAGE VARIATION

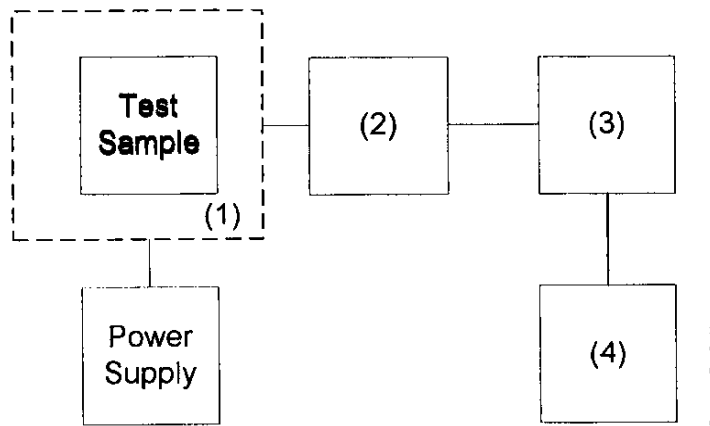

Asset	Description	s/n
<u>(1) TEMPERATURE, HUMIDITY, VIBRATION</u>		
x	i00027 Tenny Temp. Chamber	9083-765-234
	i00 Weber Humidity Chamber	
	i00 L.A.B. RVH 18-100	
<u>(2) COAXIAL ATTENUATOR</u>		
	i00122 NARDA 766-10	7802
	i00123 NARDA 766-10	7802A
	i00113 SIERRA 661A-3D	1059
	i00069 BIRD 8329 (30 dB)	10066
<u>(3) R.F. POWER</u>		
	i00014 HP 435A POWER METER	1733A05839
x	i00039 HP 436A POWER METER	2709A26776
x	i00020 HP 8901A POWER MODE	2105A01087
<u>(4) FREQUENCY COUNTER</u>		
	i00042 HP 5383A	1628A00959
x	i00019 HP 5334B	2704A00347
x	i00020 HP 8901A	2105A01087

PAGE NO.

23 of 25.

NAME OF TEST: Frequency Stability (Temperature Variation)
g9990118: 1999-Sep-17 Fri 09:48:00
STATE: 0:General

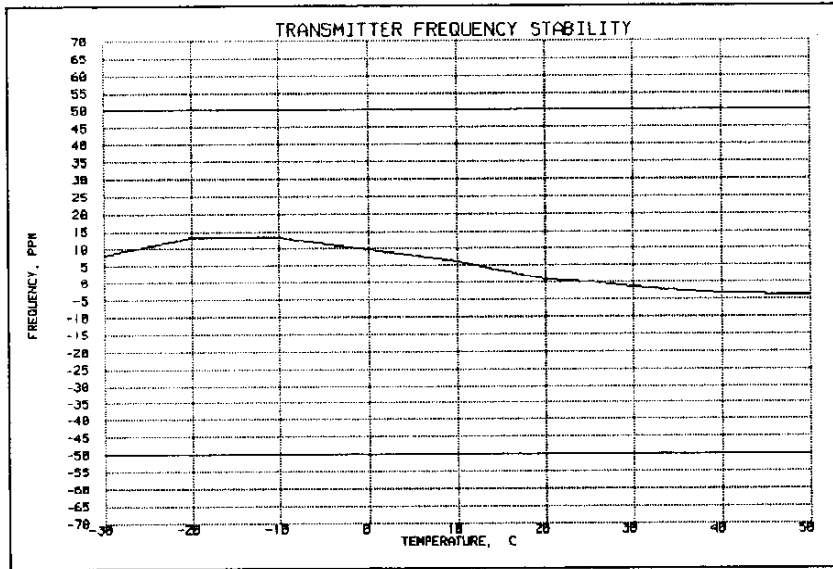

SUPERVISED BY:

William H. Graff, Director
of Engineering

PAGE NO. 24 of 25.
NAME OF TEST: Frequency Stability (Voltage Variation)
SPECIFICATION: 47 CFR 2.1055(b)(1)
GUIDE: ANSI/TIA/EIA-603-1992, Paragraph 2.2.2
TEST EQUIPMENT: As per previous page

MEASUREMENT PROCEDURE

1. The EUT was placed in a temperature chamber at 25±5°C and connected as for "Frequency Stability - Temperature Variation" test.
2. The power supply voltage to the EUT was varied from 85% to 115% of the nominal value measured at the input to the EUT.
3. The variation in frequency was measured for the worst case.

RESULTS: Frequency Stability (Voltage Variation)
g9990122: 1999-Sep-17 Fri 09:02:50
STATE: 0:General

LIMIT, ppm = 50
LIMIT, Hz = 8595
BATTERY END POINT (Voltage) = 6.5

% of STV	Voltage	Frequency, MHz	Change, Hz	Change, ppm
85	7.65	171.899870	-130	-0.76
100	9	171.900000	0	0.00
115	10.35	171.900120	120	0.70
72	6.5	171.899260	-740	-4.30

SUPERVISED BY:



William H. Graff, Director
of Engineering

PAGE NO. 25 of 25.
NAME OF TEST: Necessary Bandwidth and Emission Bandwidth
SPECIFICATION: 47 CFR 2.202(g)

MODULATION = 36K0F3E

NECESSARY BANDWIDTH CALCULATION:

MAXIMUM MODULATION (M), kHz = 10
MAXIMUM DEVIATION (D), kHz = 8
CONSTANT FACTOR (K) = 1
NECESSARY BANDWIDTH (B_N), kHz = (2 x M) + (2 x D x K)
= 36

SUPERVISED BY:



William H. Graff, Director
of Engineering

TESTIMONIAL
AND
STATEMENT OF CERTIFICATION

THIS IS TO CERTIFY THAT:

1. THAT the application was prepared either by, or under the direct supervision of, the undersigned.
2. THAT the technical data supplied with the application was taken under my direction and supervision.
3. THAT the data was obtained on representative units, randomly selected.
4. THAT, to the best of my knowledge and belief, the facts set forth in the application and accompanying technical data are true and correct.

CERTIFYING ENGINEER:

William H. Graff, Director
of Engineering

LIST OF EXHIBITS
(FCC CERTIFICATION (TRANSMITTERS) - REVISED 9/28/98)

APPLICANT: Telex Communications, Inc.

FCC ID: B5DM512

BY APPLICANT:

1. LETTER OF AUTHORIZATION
2. IDENTIFICATION DRAWINGS, 2.1033(c)(11)
 - LABEL
 - LOCATION OF LABEL
 - COMPLIANCE STATEMENT
 - LOCATION OF COMPLIANCE STATEMENT
3. PHOTOGRAPHS, 2.1033(c)(12)
4. DOCUMENTATION: 2.1033(c)
 - (3) USER MANUAL Operating
 - (9) TUNE UP INFO General Alignment
 - (10) SCHEMATIC DIAGRAM 2
 - (10) CIRCUIT DESCRIPTION Theory of Operation
5. PART 90.203(e) & (g) ATTESTATION
6. BLOCK DIAGRAM X
7. ACTIVE DEVICES X

BY M.F.A. INC.

- A. TESTIMONIAL & STATEMENT OF CERTIFICATION
- B. STATEMENT OF QUALIFICATIONS