



Compliance Testing, LLC
Previously Flom Test Lab
EMI, EMC, RF Testing Experts Since 1963

toll-free: (866) 311-3268

fax: (480) 926-3598

<http://www.ComplianceTesting.com>
info@ComplianceTesting.com

Test Report

Prepared for: **Bosch Security Systems, Inc**

Model: **REV-PH B4**

Description: **Wireless Microphone Handheld**

To

FCC Part 74H
FCC ID: B5DH226

And

IC RSS-123 Issue 2
IC ID: 1321A-REVPHB

Date of Issue: **November 3, 2011**

On the behalf of the applicant:

Bosch Security Systems, Inc.
8601 E. Cornhusker Highway
Lincoln, NE 68507

Attention of:

Jim Andersen, Principal Electrical Engineer
Ph: (402) 467-5321
Fax: (402) 467-3279
E-Mail: jim.andersen@us.bosch.com

Prepared by
Compliance Testing, LLC
3356 N San Marcos Pl, Suite 107
Chandler, AZ 85225-7176
(866) 311-3268 phone / (480) 926-3598 fax
www.compliancetesting.com
Project No: p1180010

John Erhard
Project Test Engineer

This report may not be reproduced, except in full, without written permission from Compliance Testing
All results contained herein relate only to the sample tested



Test Report Revision History

Revision	Date	Revised By	Reason for Revision
1.0	November 3, 2011	John Erhard	Original Document
2.0	January 9, 2012	Amanda Reed	Revised Model and Description per Customer Request



Table of Contents

<u>Description</u>	<u>Page</u>
Standard Test Conditions and Engineering Practices	6
Test Result Summary	7
Carrier Output Power (Conducted)	8
Conducted Spurious Emissions	9
Field Strength of Spurious Radiation	13
Emission Masks (Occupied Bandwidth)	16
Audio Low Pass Filter (Voice Input)	20
Audio Frequency Response	21
Modulation Limiting	22
Frequency Stability (Temperature Variation)	24
Frequency Stability (Voltage Variation)	25
Necessary Bandwidth Calculations	26
Test Equipment Utilized	27



ILAC / A2LA

Compliance Testing, LLC, has been accredited in accordance with the recognized International Standard ISO/IEC 17025:2005. This accreditation demonstrates technical competence for a defined scope and the operation of a laboratory quality management system (refer joint ISO-ILAC-IAF Communiqué dated January 2009)

The tests results contained within this test report all fall within our scope of accreditation, unless noted below.

Please refer to <http://www.compliancetesting.com/labscope.html> for current scope of accreditation.

Testing Certificate Number: **2152.01**



FCC OATS Reg, #933597

IC Reg. #2044A-1

Non-accredited tests contained in this report:

N/A



The Applicant has been cautioned as to the following

15.21: Information to the User

The user's manual or instruction manual for an intentional radiator shall caution the user that changes or modifications not expressly approved by the party responsible for compliance could void the user's authority to operate the equipment.

15.27(a): Special Accessories

Equipment marketed to a consumer must be capable of complying with the necessary regulations in the configuration in which the equipment is marketed. Where special accessories, such as shielded cables and/or special connectors are required to enable an unintentional or intentional radiator to comply with the emission limits in this part, the equipment must be marketed with, i.e. shipped and sold with, those special accessories. However, in lieu of shipping or packaging the special accessories with the unintentional or intentional radiator, the responsible party may employ other methods of ensuring that the special accessories are provided to the consumer, without an additional charge.

Information detailing any alternative method used to supply the special accessories for a grant of equipment authorization or retained in the verification records, as appropriate. The party responsible for the equipment, as detailed in § 2.909 of this chapter, shall ensure that these special accessories are provided with the equipment. The instruction manual for such devices shall include appropriate instructions on the first page of text concerned with the installation of the device that these special accessories must be used with the device. It is the responsibility of the user to use the needed special accessories supplied with the equipment.



Standard Test Conditions and Engineering Practices

Except as noted herein, the following conditions and procedures were observed during the testing.

In accordance with ANSI/C63.4-2009, and unless otherwise indicated in the specific measurement results, the ambient temperature of the actual EUT was maintained within the range of 10° to 40°C (50° to 104°F) unless the particular equipment requirements specify testing over a different temperature range. Also, unless otherwise indicated, the humidity levels were in the range of 10% to 90% relative humidity.

Environmental Conditions		
Temperature (° C)	Humidity (%)	Pressure (mbar)
25.40	22.00	975.70

Accessories: None
Cables: None
Modifications: None

Sub-part 2.1033(c)(14):
Test and Measurement Data

All tests and measurement data shown were performed in accordance with FCC Rules and Regulations, Volume II, Part 2, Sub-part J, Sections 2.947, 2.1033(c), 2.1041, 2.1046, 2.1047, 2.1079, 2.1051, 2.1053, 2.1055, 2.1057, and the following individual Parts: 74.

Measurement results, unless otherwise noted, are worst-case measurements.



Test Result Summary

Specification	Test Name	Pass, Fail, N/A	Comments
2.1046(a) 74.861(e)(1)(i) RSS-123 (4.2.1.1)	Carrier Output Power (Conducted)	Pass	
2.1051 74.861(e)(6) RSS-123 (5.5.1)	Unwanted Emissions (Transmitter Conducted)	Pass	
2.1053 74.861(e)(6) RSS-123 (5.5.1)	Field Strength of Spurious Radiation	Pass	
74.861(e)(6) RSS-123 (5.5.1)	Emission Masks (Occupied Bandwidth)	Pass	
2.1047(a)	Audio Low Pass Filter (Voice Input)	Pass	
2.1047(a)	Audio Frequency Response	Pass	
2.1047(b)	Modulation Limiting	Pass	
2.1055 74.861(e)(4) RSS-123 (5.4)	Frequency Stability (Temperature Variation)	Pass	
2.1055 RSS-123 (5.4)	Frequency Stability (Voltage Variation)	Pass	
2.202	Necessary Bandwidth Calculation	Pass	
RSS-Gen	Receiver Spurious Emissions	N/A	The EUT is a TX only



Carrier Output Power (Conducted)

Name of Test: Carrier Output Power (Conducted)
Test Equipment Utilized: i00008, i00319, i00331

Engineer: John Erhard
Test Date: 11/1/2011

Measurement Procedure

The EUT was connected directly to a spectrum analyzer. The test cable and attenuator were entered into the spectrum analyzer as a reference level offset before recording the peak conducted output power to ensure accurate measurement.

RBW = 1 MHz
Video BW = 3 MHz

Test Setup

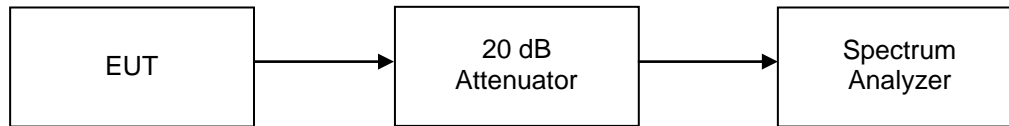

Peak Output Power

Tuned Frequency (MHz)	Recorded Measurement (mW)	Limit (mW)	Result
512	31.7	250	Pass
524	31.0	250	Pass
536	30.0	250	Pass

The peak power level is below the 50 mW Industry Canada average limit. No additional testing is required.



Conducted Spurious Emissions

Name of Test: Conducted Spurious Emissions
Test Equipment Utilized: i00008, i00319, i00331, i00364

Engineer: John Erhard
Test Date: 11/1/2011

Test Procedure

The EUT was connected directly to a spectrum analyzer to verify that the UUT met the requirements for spurious emissions. For the FCC the RBW was set to 100 KHz for measurements up to 1000 MHz and 1 MHz for measurements above 1000 MHz using a peak detector. The limit line was set for -25 dBm for comparison to RSS-123 which is the more stringent limit.

Test Setup

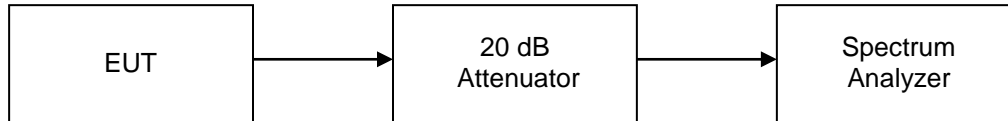

Conducted Spurious Emissions Summary Test Table

Tuned Frequency (MHz)	Spurious Frequency (MHz)	Measured Spurious Level (dBm)	Specification Limit (dBm)	Result
512	3588	-29.18	-25	Pass
524	3666	-30.03	-25	Pass
536	1608	-33.05	-25	Pass

Conducted spurious emissions were measured to the Industry Canada limit of -25 dBm which is more stringent than the FCC limit of -13 dBm.



512 MHz Conducted Spurious Test Plots 30 MHz to 1000 MHz

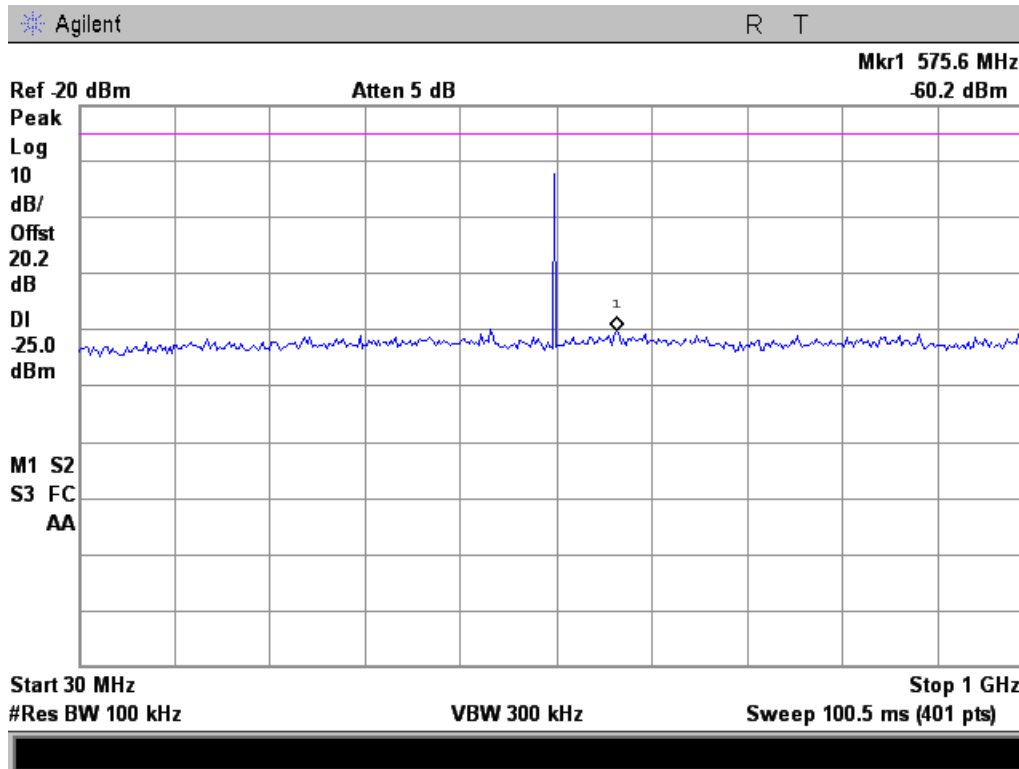

1000 MHz to 5500 MHz

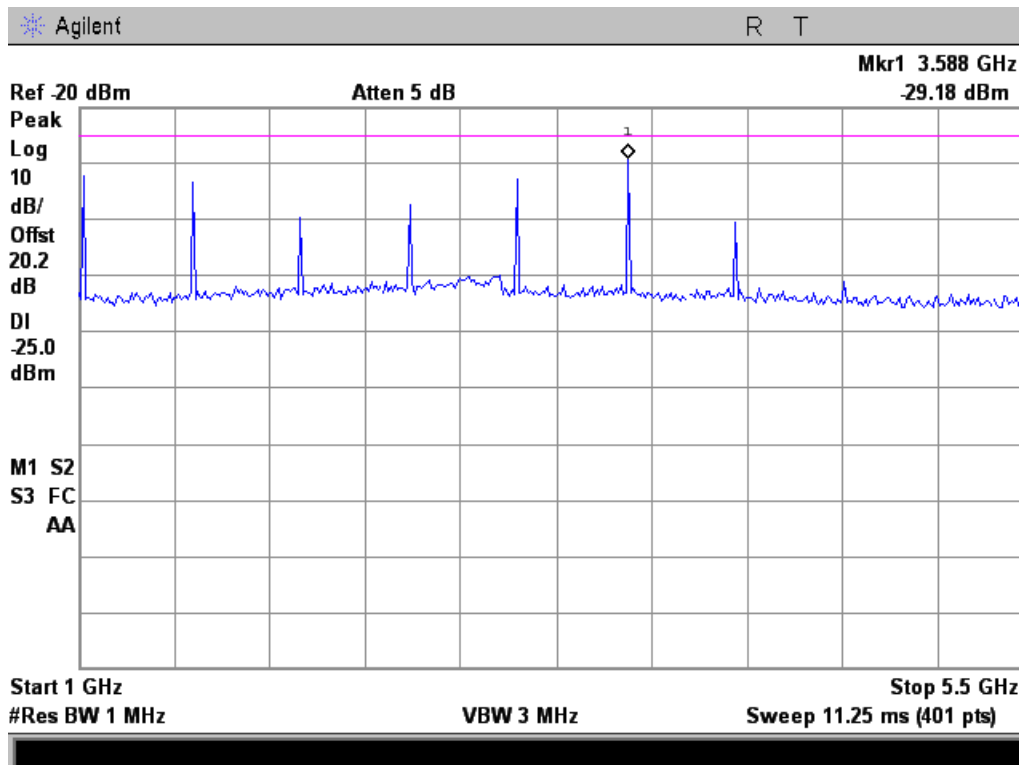



524 MHz Conducted Spurious Test Plots 30 MHz to 1000 MHz

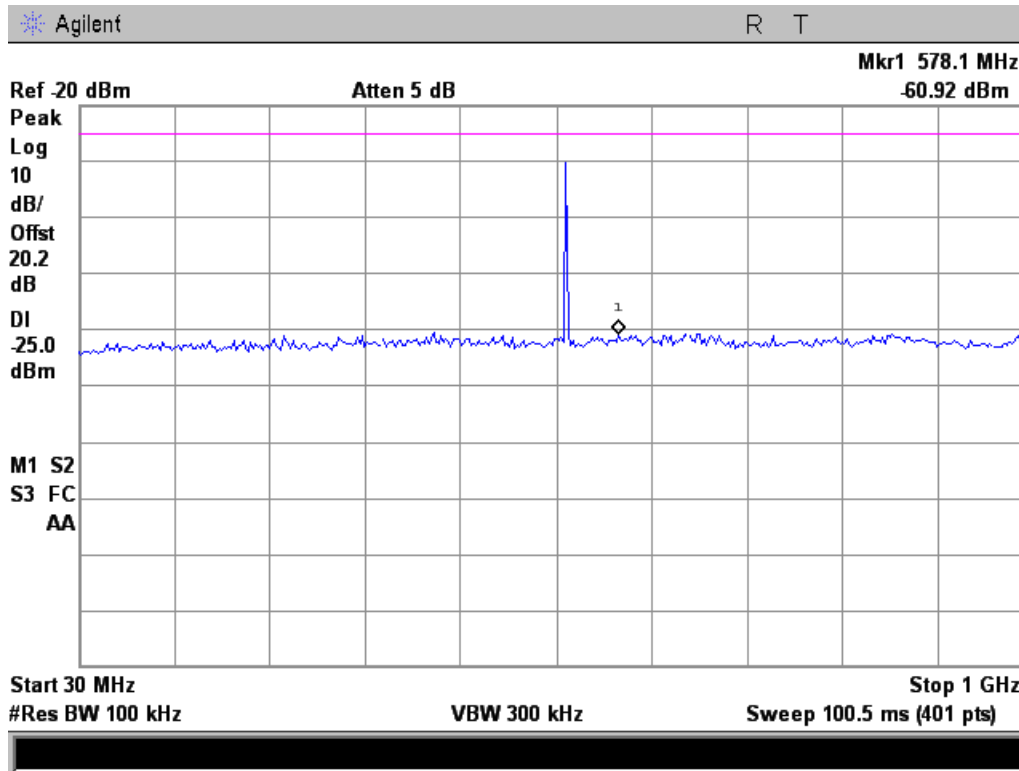

1000 MHz to 5500 MHz

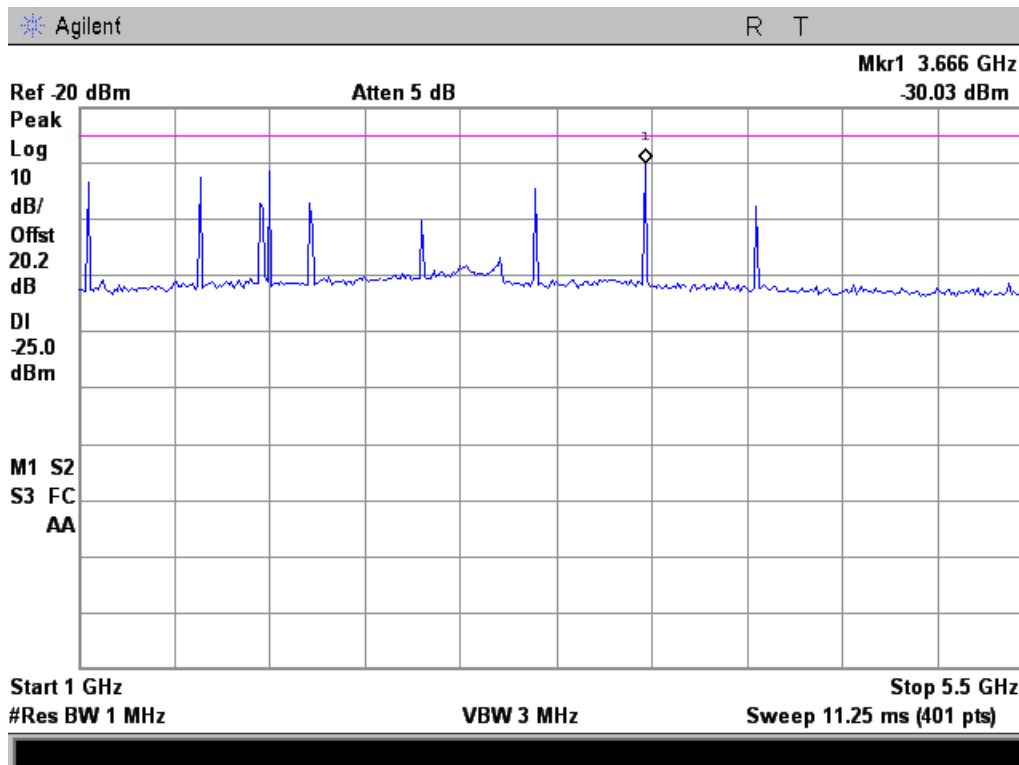



536 MHz Conducted Spurious Test Plots

30 MHz to 1000 MHz

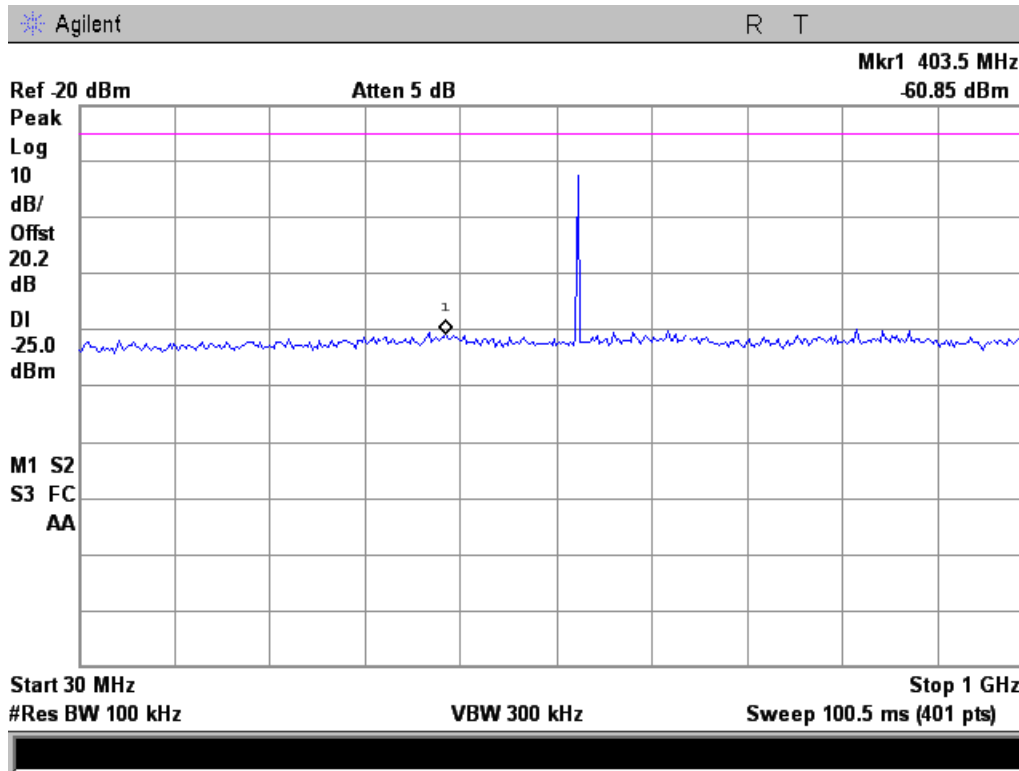

1000 MHz to 5500 MHz

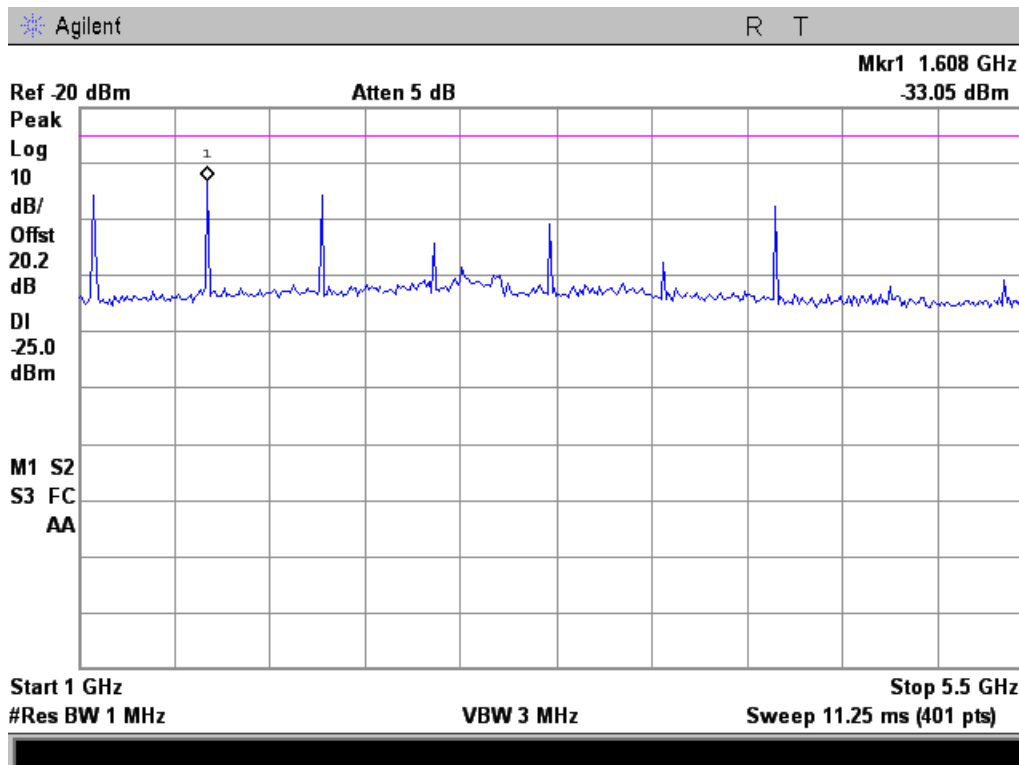



Field Strength of Spurious Radiation

Name of Test: Field Strength of Spurious Radiation
Test Equipment Utilized: i00103, i00379

Engineer: John Erhard
Test Date: 10/27/2011

Test Procedure

- A) Connect the equipment as illustrated
- B) Adjust the spectrum analyzer for the following settings:
 - 1) Resolution Bandwidth 100 kHz (< 1 GHz), 1 MHz (> 1GHz) unless otherwise specified.
 - 2) Video Bandwidth ≥ 3 times Resolution Bandwidth
 - 3) Sweep Speed ≤ 2000 Hz/second
 - 4) Detector Mode = Average
- C) Place the transmitter to be tested on the turntable in the standard test site. Transmitters without antennas were transmitting into a non-radiated load. The RF cable to this load should be of minimum length. Transmitters with antennas were transmitting into the manufacturer's supplied antenna.
- D) For each spurious measurement the test antenna should be adjusted to the correct length for the frequency involved. This length may be determined from a calibration ruler supplied with the equipment. Measurements shall be made from the lowest radio frequency generated in the equipment to the tenth harmonic of the carrier, except for the region close to the carrier equal to \pm the test bandwidth (see section 1.3.4.4).
- E) For each spurious frequency, raise and lower the test antenna from 1 m to 4 m to obtain a maximum reading on the spectrum analyzer with the test antenna at horizontal polarity. Repeat this procedure to obtain the highest possible reading. Record this maximum reading.
- F) Repeat step E) for each spurious frequency with the test antenna polarized vertically.
- G) Reconnect the equipment as illustrated.
- H) Keep the spectrum analyzer adjusted as in step B).
- I) Remove the transmitter and replace it with a substitution antenna (the antenna should be half wavelength for each frequency involved). The center of the substitution antenna should be approximately at the same location as the center of the transmitter. At lower frequencies, where the substitution antenna is very long, this will be impossible to achieve when the antenna is polarized vertically. In such case the lower end of the antenna should be 0.3 m above the ground.
- J) Feed the substitution antenna at the transmitter end with a signal generator connected to the antenna by means of a non-radiating cable. With the antennas at both ends horizontally polarized and with the signal generator tuned to a particular spurious frequency, raise and lower the test antenna to obtain a maximum reading at the spectrum analyzer. Adjust the level of the signal generator output until the previously recorded maximum reading for this set of conditions is obtained. This should be done carefully repeating the adjustment of the test antenna and generator output.
- K) Repeat step J) with both antennas vertically polarized for each spurious frequency.
- L) Calculate power in dBm into a reference ideal half-wave dipole antenna by reducing the readings obtained in steps J) and K) by the power loss in the cable between the generator and the antenna and further corrected for the gain of the substitution antenna used relative to an ideal half-wave dipole antenna.
- M) The levels recorded in step L) are absolute levels of radiated spurious emissions in dBm. The radiated spurious emissions in dB can be calculated by the following:

Radiated spurious emissions dB = $10\log_{10}$ (TX power in watts/0.001) – the levels in step I)

NOTE: It is permissible that the other antennas provided can be referenced to a dipole.



Test Setup

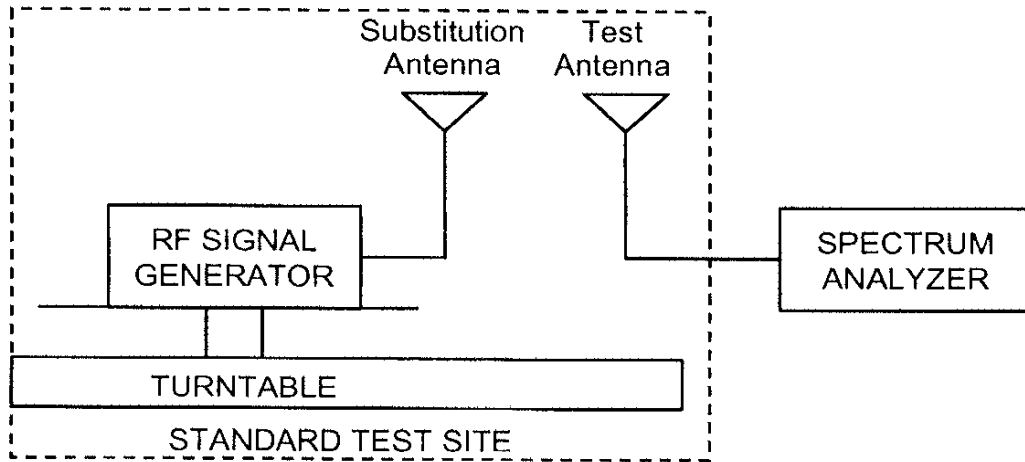
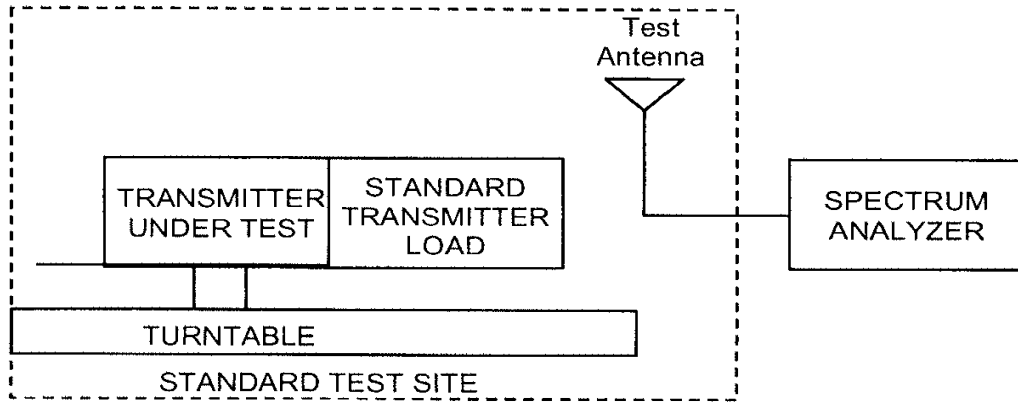



Radiated Spurious Emissions Test Results

Tuned Frequency MHz	Emission Frequency (MHz)	Measured Level (dBm)	Limit (dBm) EIRP	Result
512	1024	-47.58	-25	Pass
512	1536	-42.04	-25	Pass
512	2048	-42.02	-25	Pass
524	1048	-51.49	-25	Pass
524	1572	-41.80	-25	Pass
524	2096	-43.68	-25	Pass
536	1072	-49.82	-25	Pass
536	1608	-41.29	-25	Pass
536	2144	-45.08	-25	Pass

The antenna and cable correction factors were input into the spectrum analyzer to ensure accurate measurements. The limit was set for -25 dBm for comparison to RSS-123 which is the more stringent limit. No other emissions were detected. All emissions were greater than -25 dBm.



Emission Masks (Occupied Bandwidth)

Name of Test: Emission Masks (Occupied Bandwidth)
Test Equipment Utilized: i00008, i00319, i00331

Engineer: John Erhard
Test Date: 11/2/2011

Test Procedure

The EUT was connected directly to a spectrum analyzer to verify that the EUT meets the required emissions mask. A reference level plot is provided to verify that the peak power was established prior to testing the mask. The EUT Audio Output control circuit was set to -6 dB per the manufacturer's instructions with a modulating frequency of 2.5 KHz input to the EUT audio circuit

Test Setup

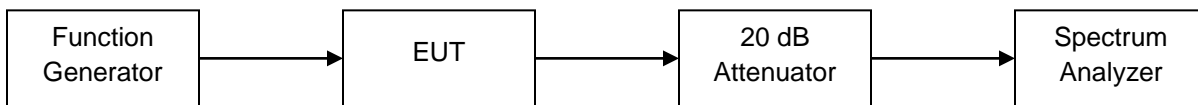



512 MHz reference

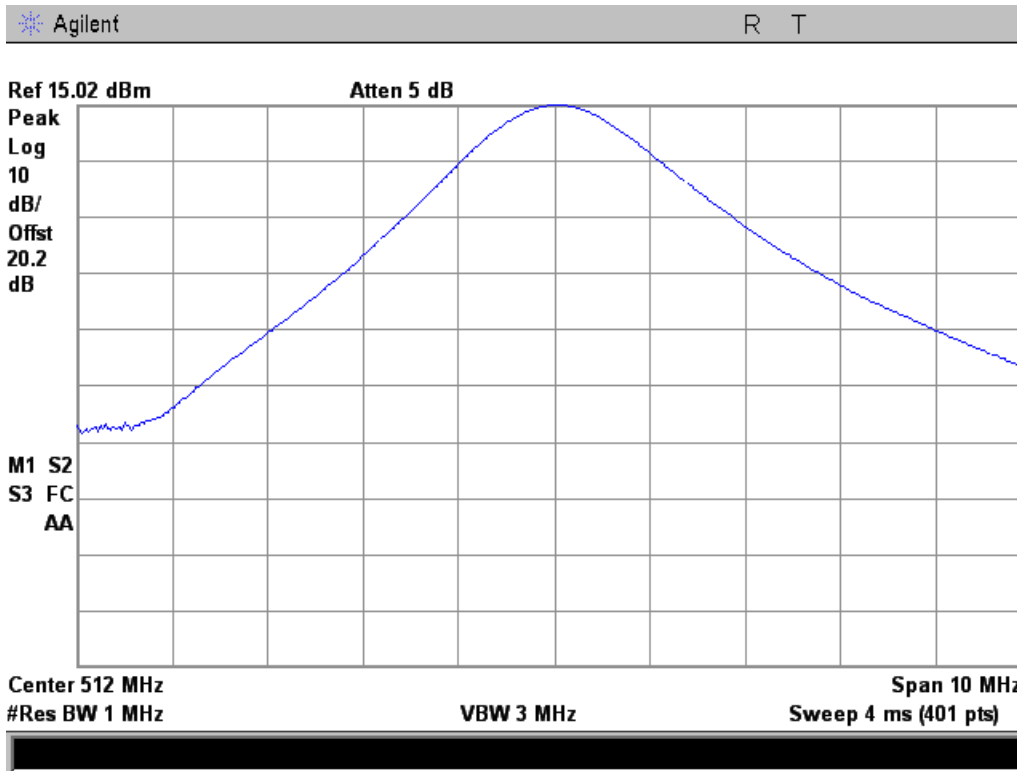

512 MHz Emissions Mask

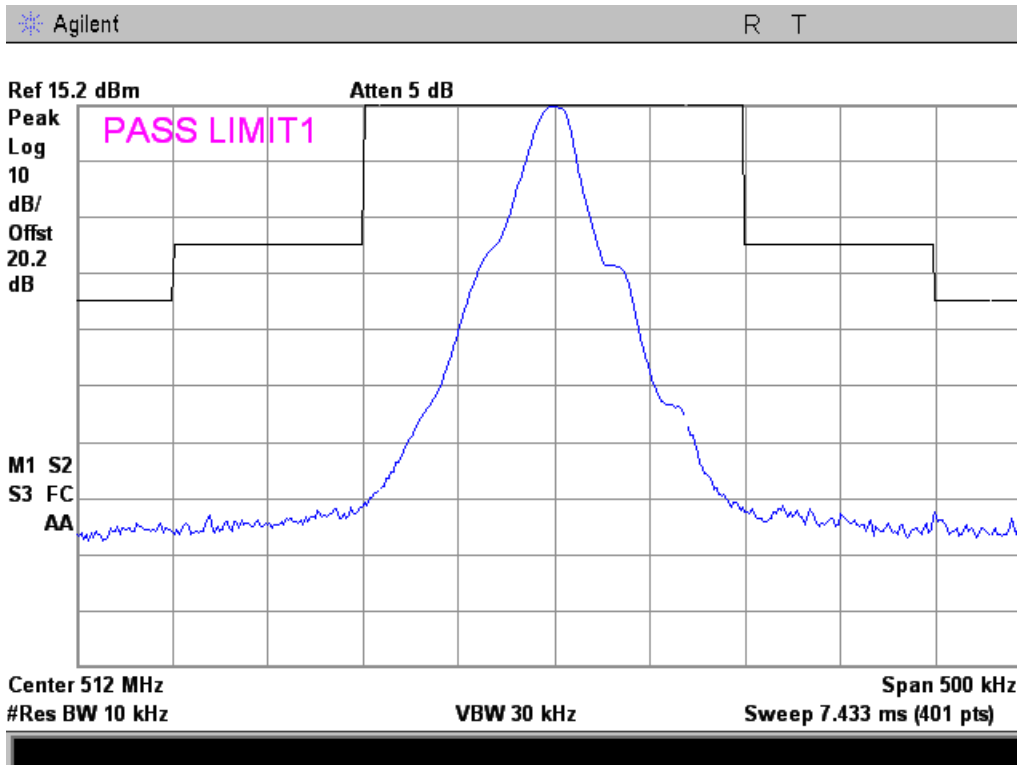



524 MHz reference

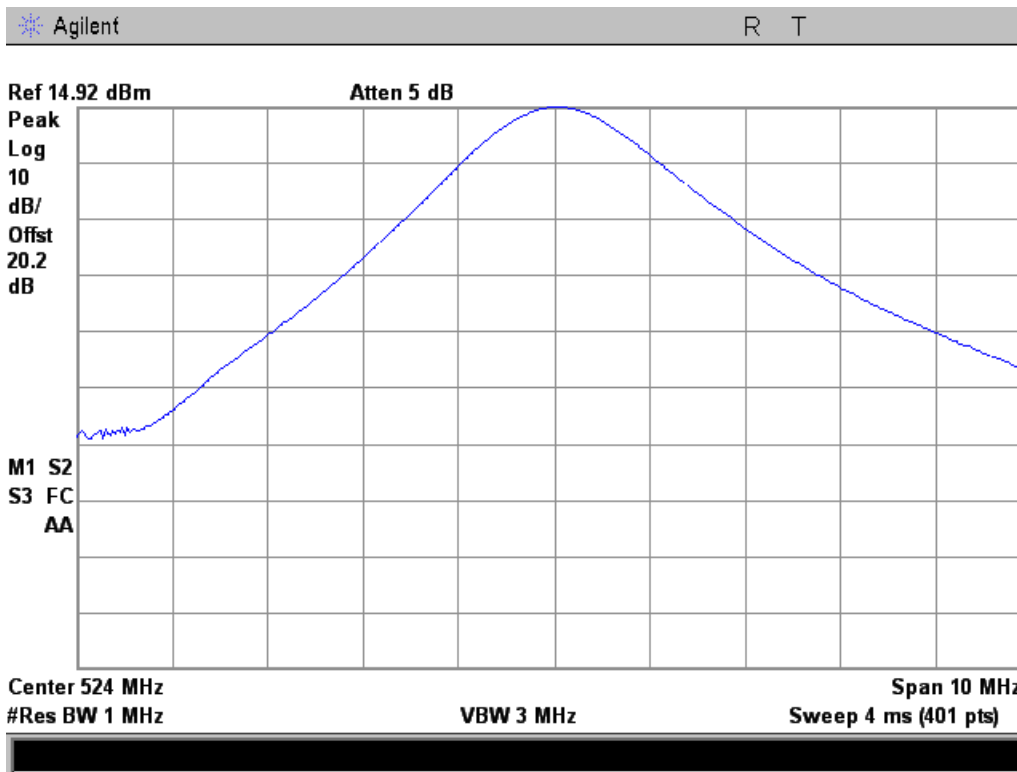

524 MHz Emissions Mask

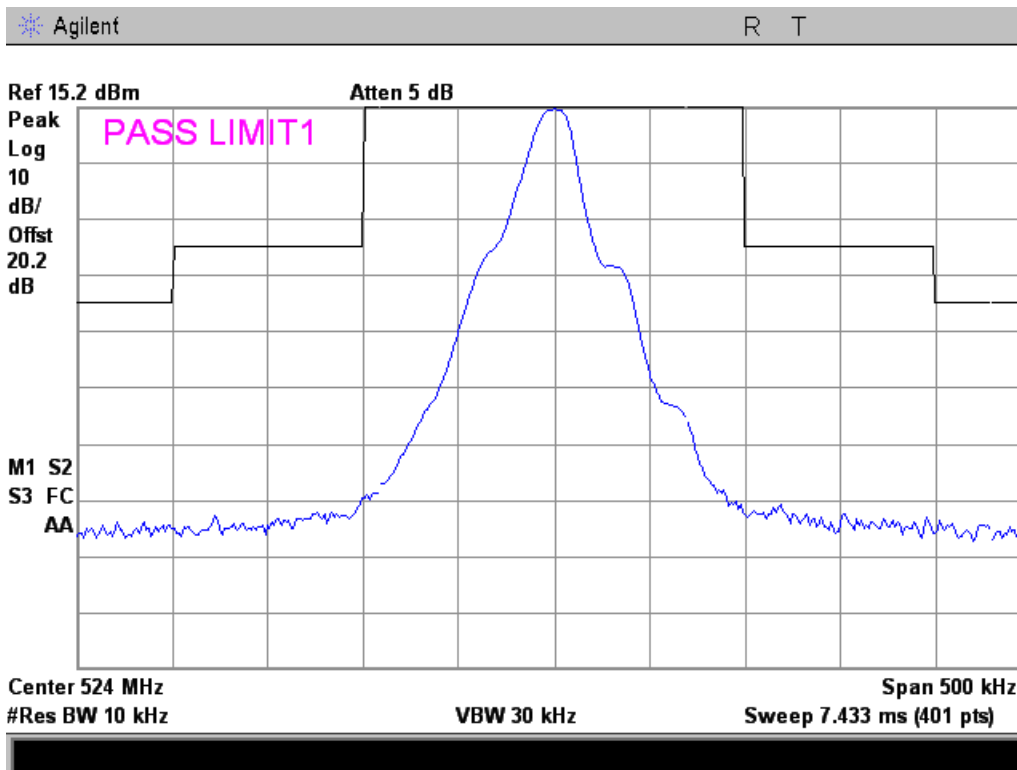



536 MHz reference

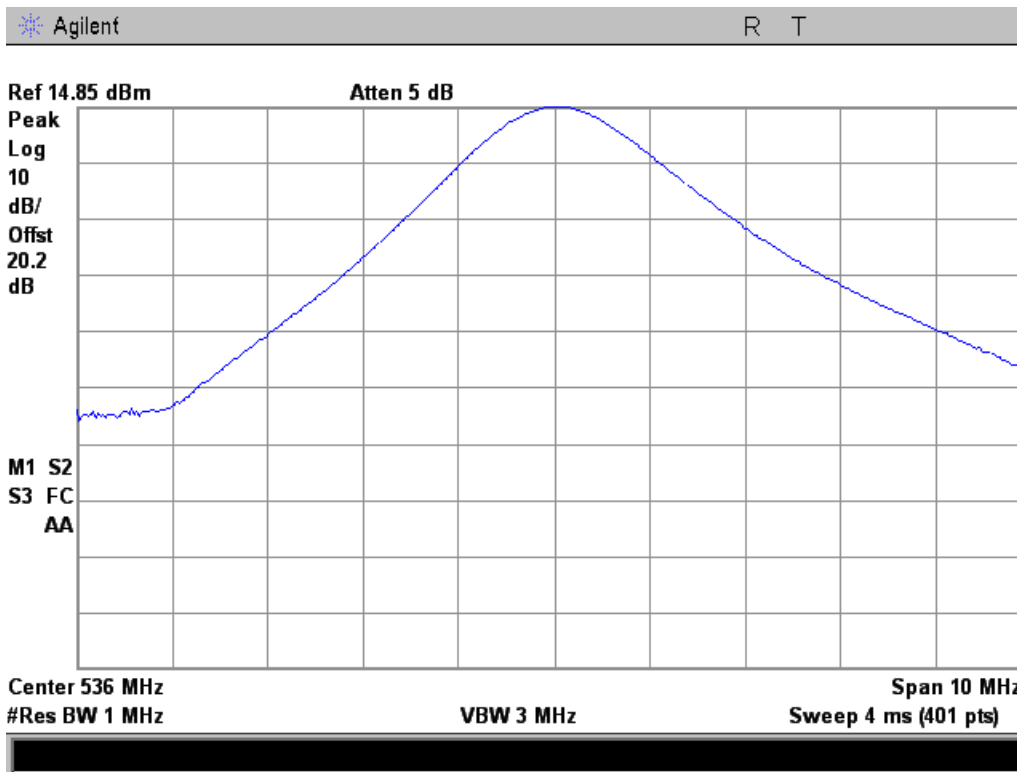

536 MHz Emissions Mask

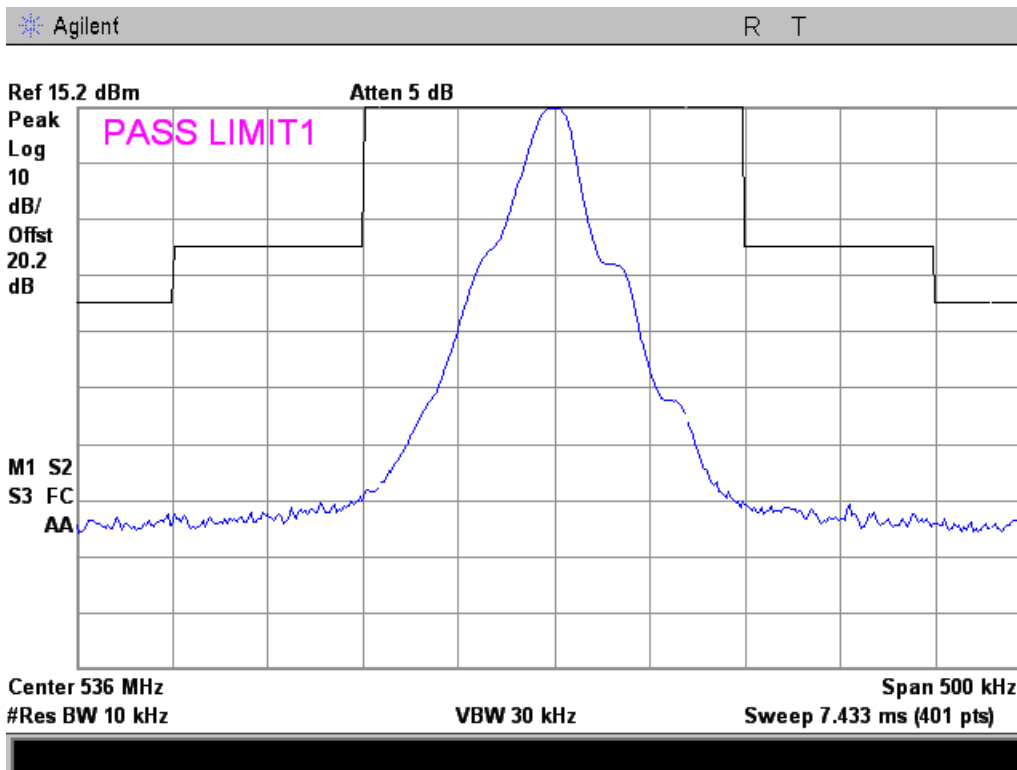



Audio Low Pass Filter (Voice Input)

Name of Test: Audio Low Pass Filter (Voice Input)
Test Equipment Utilized: i00008, i00319, i00345

Engineer: John Erhard
Test Date: 11/2/2011

Measurement Procedure

The EUT was connected directly to a Modulation Analyzer through an attenuator. The audio source was tuned across the required audio frequency range and the audio low pass filter response was measured and plotted. The modulation analyzer is a real time spectrum analyzer with integrated demodulation, audio measurement capabilities, and timing analysis.

Test Setup

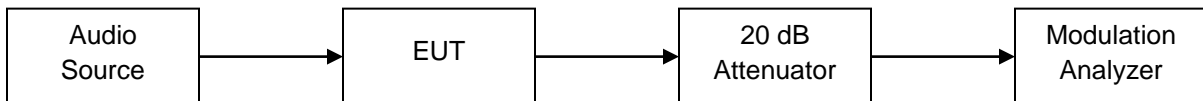

Measurement Results

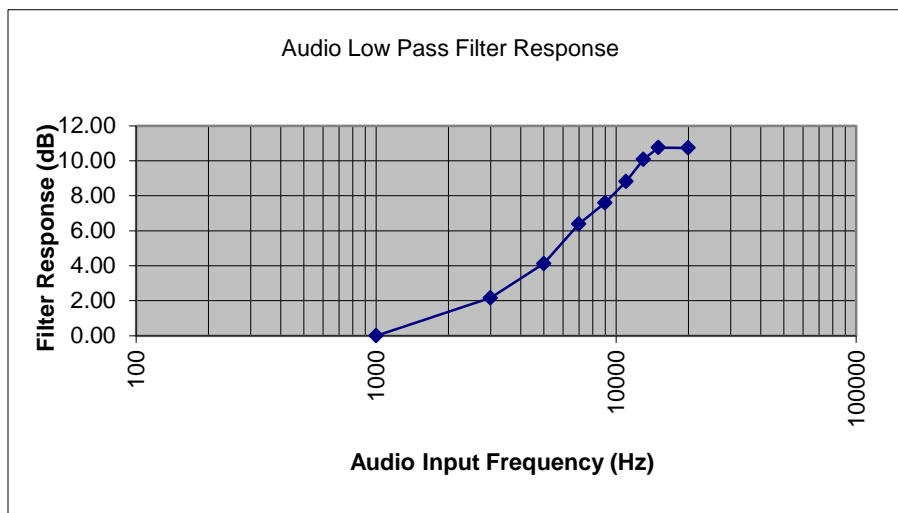



Audio Frequency Response

Name of Test: Audio Frequency Response
Test Equipment Utilized: i00008, i00319, i00345

Engineer: John Erhard
Test Date: 11/2/2011

Measurement Procedure

The EUT was connected directly to a Modulation Analyzer through an attenuator. The audio input level was set to 20% deviation per the manufacturer's instructions. The audio source was tuned across the required audio frequency range and the audio frequency response was measured and plotted. The modulation analyzer is a real time spectrum analyzer with integrated demodulation, audio measurement capabilities, and timing analysis.

Test Set-Up

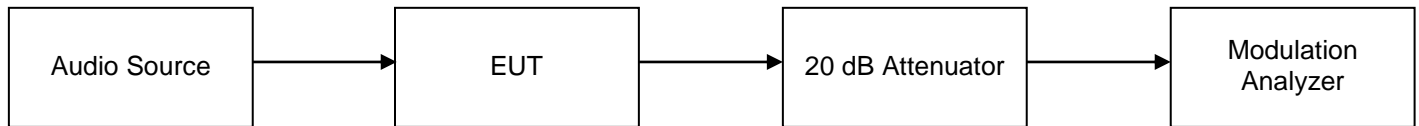

Test Results

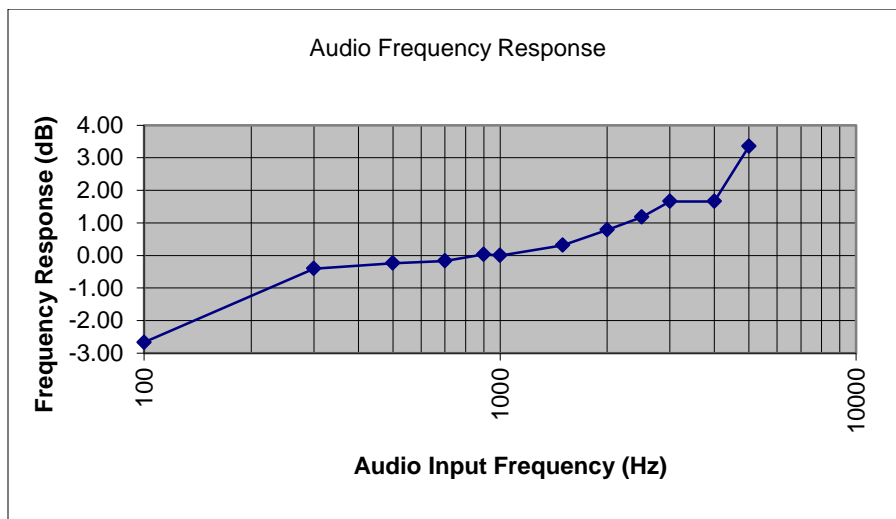



Modulation Limiting

Name of Test: Modulation Limiting
Test Equipment Utilized: i00008, i00319, i00345

Engineer: John Erhard
Test Date: 11/2/2011

Measurement Procedure

The EUT was connected directly to a Modulation Analyzer through an attenuator.

The audio input level was set to 60% deviation per the manufacturer's instructions, and then the level was increased by 20 dB.

The audio source was tuned across the required audio frequency range and the modulation limiting response was measured and plotted.

The modulation analyzer is a real time spectrum analyzer with integrated demodulation, audio measurement capabilities, and timing analysis.

Test Setup

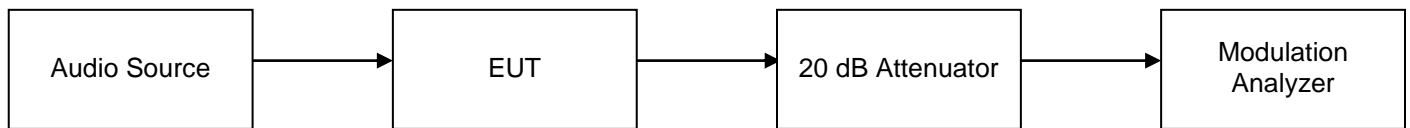



Positive Peaks

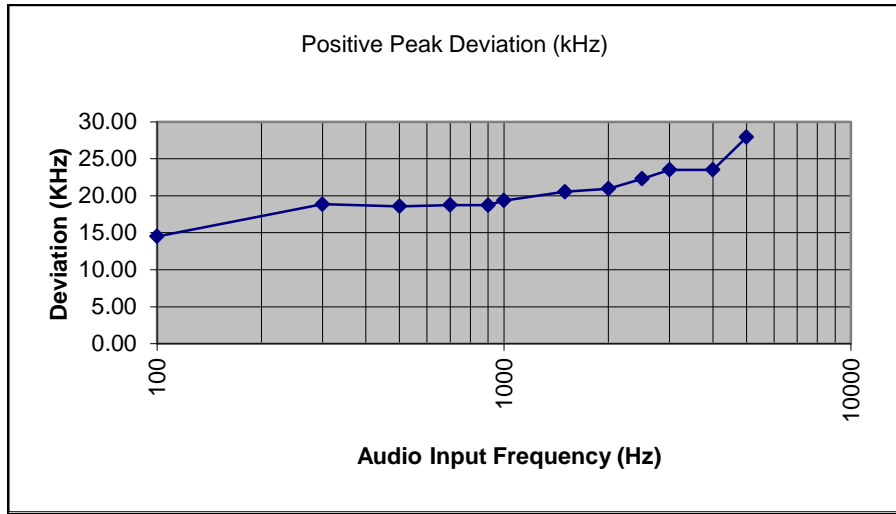

Negative Peaks

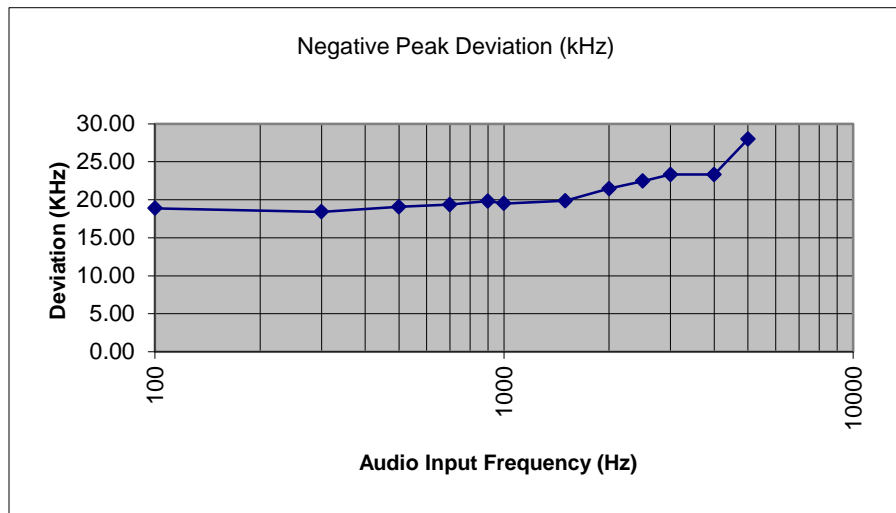



Frequency Stability (Temperature Variation)

Name of Test: Frequency Stability (Temperature Variation)

Engineer: John Erhard

Test Equipment Utilized: i00008, i00019, i00027, i00319, i00343

Test Date: 11/3/2011

Measurement Procedure

The EUT was placed in an environmental test chamber and the RF output was connected directly to a frequency counter. The temperature was varied from -30°C to 50°C in 10°C increments. After a sufficient time for temperature stabilization the RF output frequency was measured.

Measurement Setup

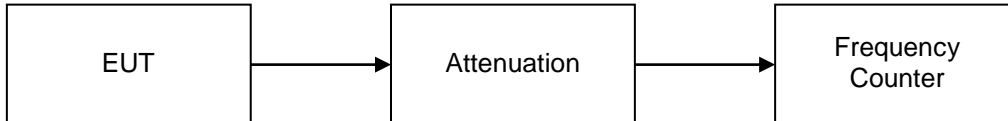

Measurement Results

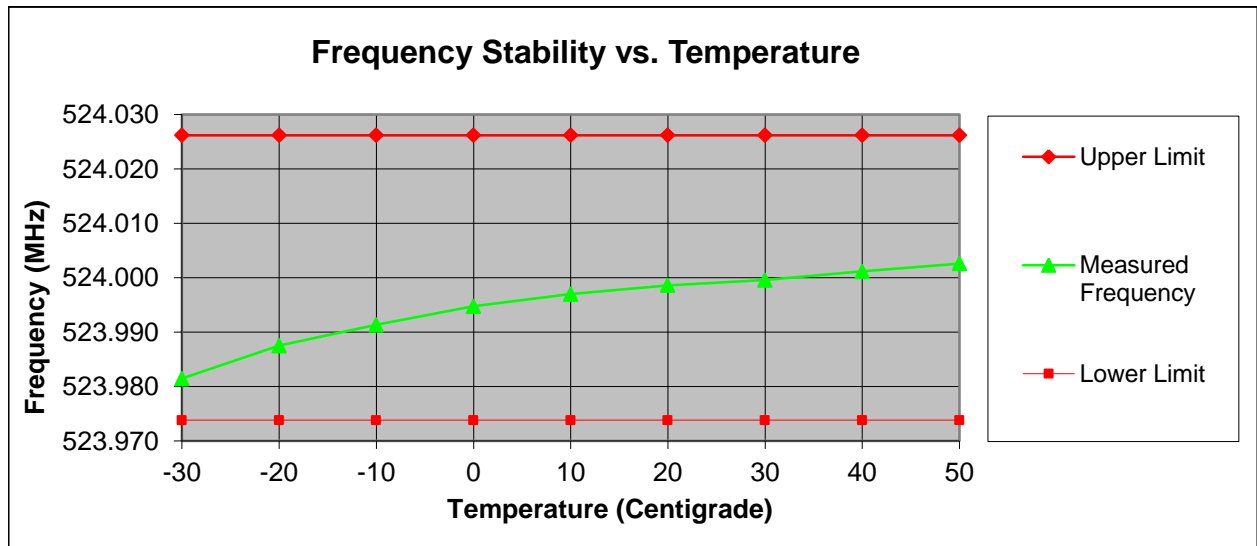



Frequency Stability (Voltage Variation)

Name of Test: Frequency Stability (Voltage Variation) **Engineer:** John Erhard
Test Equipment Utilized: i00008, i00019, i00027, i00319, i00343 **Test Date:** 11/3/2011

Measurement Procedure

The EUT was placed in a temperature chamber at $25\pm 5^{\circ}\text{C}$ and connected directly to a frequency counter and variable power supply. The power supply voltage to the EUT was varied from 85% to 115% of the nominal value and the RF output was measured.

The EUT is powered by a 9V battery. The manufacturer declared operating range is +7.65 to +9.0 vdc.

Measurement Setup

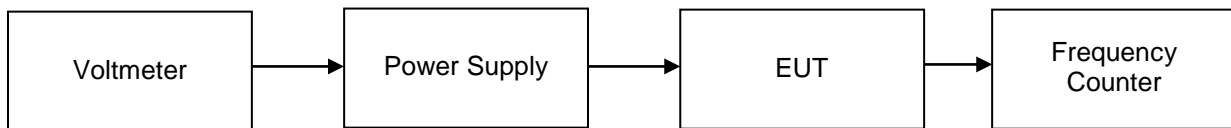

Measurement Results

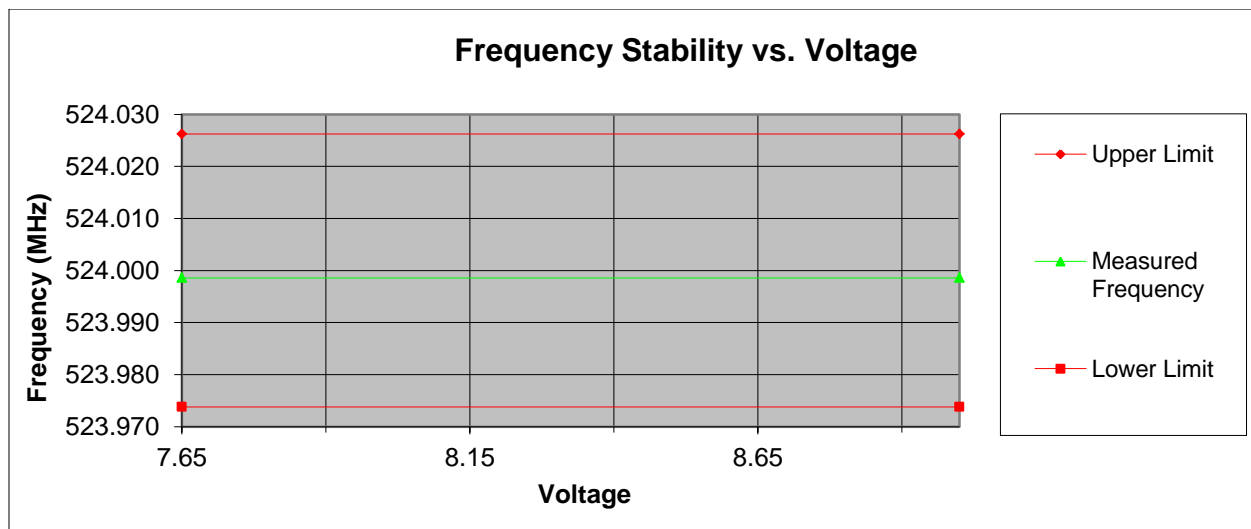



Necessary Bandwidth Calculations

Name of Test: Necessary Bandwidth Calculations
Test Equipment Utilized: N/A

Engineer: John Erhard
Test Date: 11/2/2011

Modulation = 53K6F3E	
Maximum Modulation (M), kHz	= 15
Maximum Deviation (D), kHz	= 11.8
Constant Factor (K)	= 1
Necessary Bandwidth (B _N), kHz	= (2xM)+(2xDxK)
	= 56.0



Test Equipment Utilized

Description	Manufacturer	Model Number	CT Asset #	Last Cal Date	Cal Due Date
Power Supply	Kenwood	PR18-3A	i00008	Verified on: 11/1/2011	
Frequency Counter	HP	5334B	i00019	2/15/10	2/15/11
Temperature Chamber	Tenney	Tenney Jr	i00027	Verified on: 11/3/2011	
Horn Antenna	EMCO	3115	i00103	11/5/10	11/5/12
Humidity / Temp Meter	Newport	IBTHX-W-5	i00282	11/11/10	11/11/11
Voltmeter	Fluke	87III	i00319	6/20/11	6/20/12
Spectrum Analyzer	Agilent	E4407B	i00331	5/24/11	5/24/12
Data Logger	Fluke	Hydra Data Bucket	i00343	11/18/10	11/18/11
Spectrum Analyzer	Tektronix	RSA3308A	i00345	9//11	9/16/12
Humidity / Temp Meter	Control Company	4189CC	i00355	1/26/11	1/26/12
Tunable Notch Filter	Eagle	TNF-240MFMF	i00364	Verified on:11/1/2011	
Spectrum Analyzer	Agilent	E7405A	i00379	11/22/10	11/22/11

In addition to the above listed equipment standard RF connectors and cables were utilized in the testing of the described equipment. Prior to testing these components were tested to verify proper operation.

END OF TEST REPORT