

APPLICANT: Telex Communication Inc.
FCC ID: B5DH219

TABLE OF CONTENTS LIST

TEST REPORT CONTAINING:

PAGE 1.....TECHNICAL DESCRIPTION
PAGE 2.....TECHNICAL DESCRIPTION CONTINUED & RF POWER OUTPUT
PAGE 3.....AUDIO FREQUENCY RESPONSE GRAPH AND MODULATION
 FREQUENCY 300 Hz
PAGE 4.....MODULATION FREQUENCY PLOTS - 12.5 kHz, 15 kHz
PAGE 5.....OCCUPIED BANDWIDTH
PAGE 6.....RADIATED EMISSIONS TEST DATA
PAGE 7.....METHOD OF MEASURING RADIATED EMISSIONS
PAGE 8.....FREQUENCY STABILITY TEST DATA
PAGE 9-12.....EQUIPMENT LIST

EXHIBITS CONTAINING:

EXHIBIT 1.....FCC ID LABEL SAMPLE & ID LABEL LOCATION
EXHIBIT 2.....BLOCK DIAGRAM
EXHIBIT 3.....SCHEMATICS
EXHIBIT 4.....TUNING PROCEDURE
EXHIBIT 5.....CIRCUIT DESCRIPTION
EXHIBIT 6.....USER'S MANUAL
EXHIBIT 7.....PARTS LIST
EXHIBIT 8.....TEST SET UP PHOTOGRAPH
EXHIBIT 9.....EXTERNAL PHOTOGRAPHS
EXHIBIT 10.....INTERNAL PHOTOGRAPHS
EXHIBIT 11.....CONFIDENTIALTY LETTER

APPLICANT: Telex Communication Inc.
FCCID: B5DH219
REPORT #: T\TELEX\662AUT3\662AUT3TestReport.doc
TABLE OF CONTENTS LIST

GENERAL INFORMATION REQUIRED
FOR TYPE ACCEPTANCE

- 2.1033(c)(1) Telex Communication Inc. will manufacture the B5DH219 in
2.1033(c)(2) quantity, for use under FCC RULES PART 74.801, LOW
POWER AUXILIARY STATIONS.

Telex Communication Inc.
8601 E. Cornhusker Highway
PO Box 5579
Lincoln, Nebraska 68505-5579

2.1033 TECHNICAL DESCRIPTION

- (c)(3) Instruction book. The instruction manual is included as Exhibit 6.

- (c)(4) Type of Emission: 120K0F3E

Bn = 2M + 2DK
M = 20000
D = 40kHz(Peak Deviation)
K = 1
Bn = 2(20k) + 2(40k)(1) = 120k

ALLOWED AUTHORIZED BANDWIDTH = 200kHz.
74.861(e)(5)

- (c)(5) Frequency Range: Part 74: 614-746 MHz
TEST FREQ = 698.10 MHz and 721.90 MHz

- (c)(6) Power Range and Controls:UNIT has no controls.

- (c)(8) DC Voltages and Current into Final Amplifier:

FINAL AMPLIFIER ONLY
9.0V BATTERY
Vce = 9.0 Volts
Ice = 28 mA.

- (c)(9) Tune-up procedure. The tune-up procedure is given in page 4.

- (c)(10) Complete Circuit Diagrams: The circuit diagram is included as EXHIBIT # 3. The block diagram is included as EXHIBIT # 2.

2.1033(c)11) Photo or Drawing of Label and sketch of location:
See EXHIBIT # 1.

2.1033(c)12) Photos of Equipment:
See EXHIBIT #'S 9-10.

(c)(13) Description of all circuitry and devices provided for determining and stabilizing frequency.

Description of any circuits or devices employed for suppression of spurious radiation, for limiting modulation, and for limiting power.

This circuitry is described on page 5.

Limiting Power:

There is no provision for limiting power.

(13) Digital modulation. This unit does not use digital modulation.

2.1033(c)(14) The data required by 2.1046 through 2.1057 is submitted below.

2.1046 RF power output.

RF power measured is:

OUTPUT POWER: .0033 WATTS ERP

OUTPUT POWER: 0.03 WATTS CONDUCTED

R.F. POWER OUTPUT TEST PROCEDURE

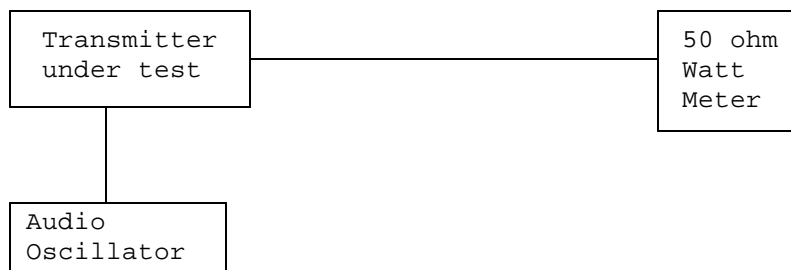

2.1047(a)(b) Modulation characteristics:

AUDIO LOW PASS FILTER

The audio low pass filter is not required in this unit.

AUDIO FREQUENCY RESPONSE

The audio frequency response was measured in accordance with TIA/EIA Specification 603. The audio frequency response curve is shown below.

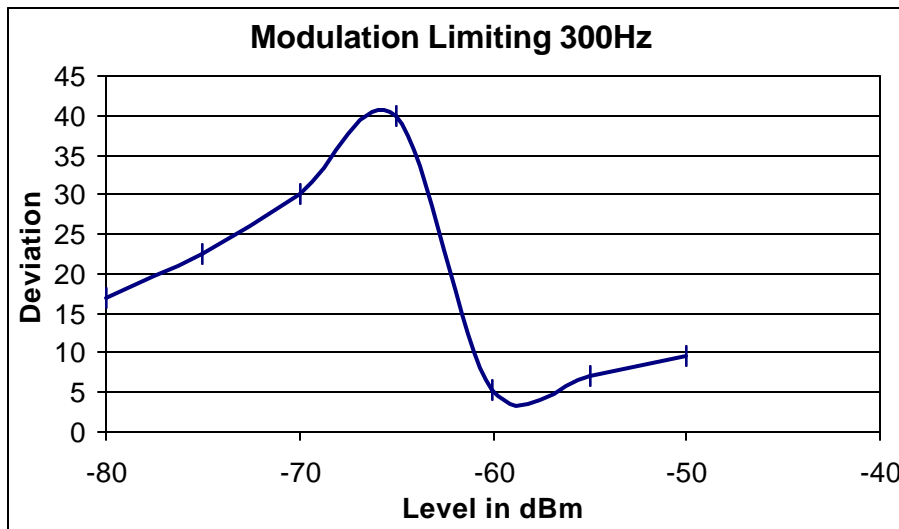
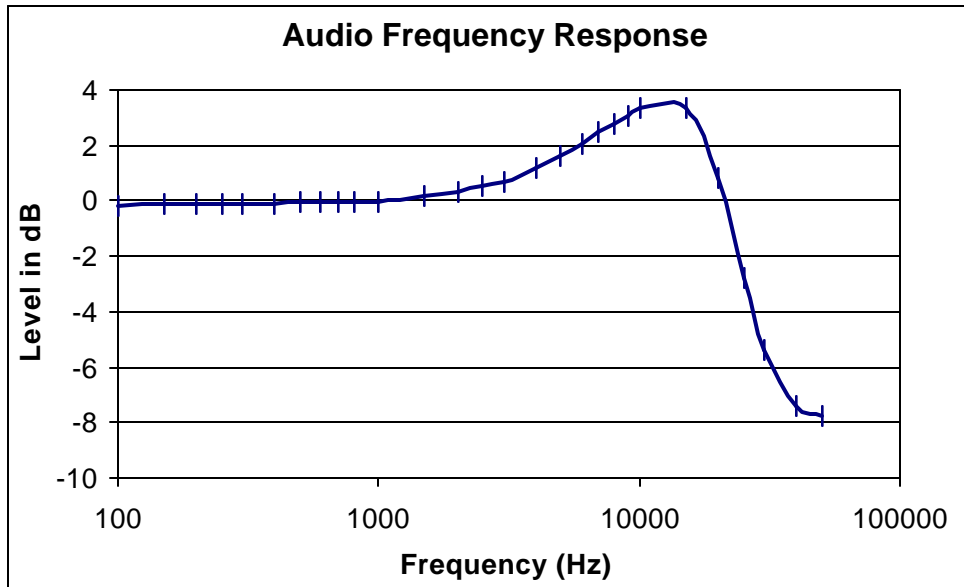

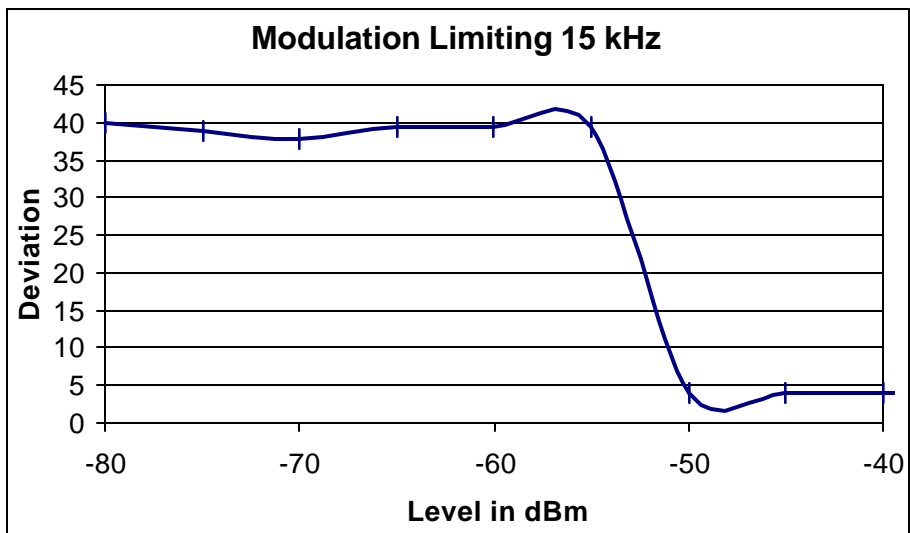
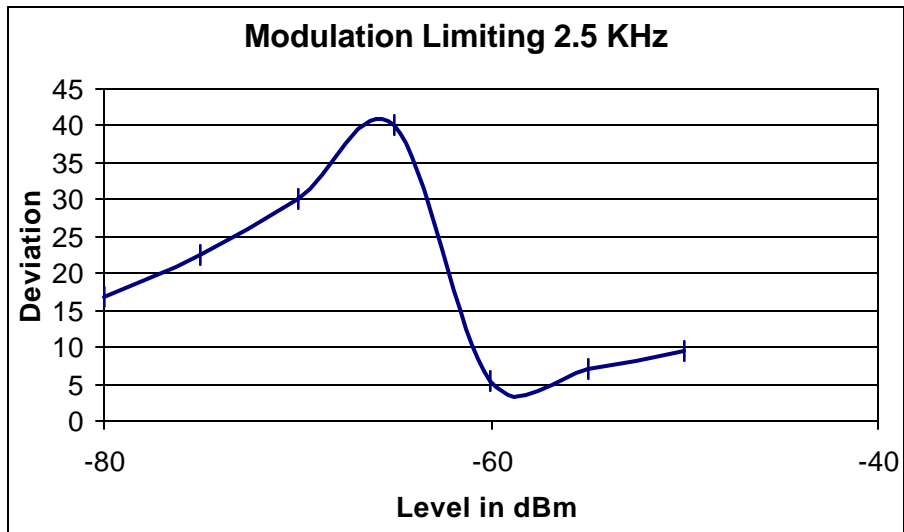

2.1049(c) Occupied Bandwidth:

Data in the plots show that all sidebands between 50 & 100% for the authorized bandwidth are attenuated by at least 25dB. From 100 to 250% of the authorized bandwidth they are attenuated by at least 35dB and beyond 250% $43 \log(P_o)$ dB. The plot shows the transmitter modulated with 15000 Hz (the highest modulation frequency), adjusted for 50% modulation plus 16 dB. The spectrum analyzer was set with the unmodulated carrier at the top of the screen. The test procedure diagram and occupied bandwidth plots follow.

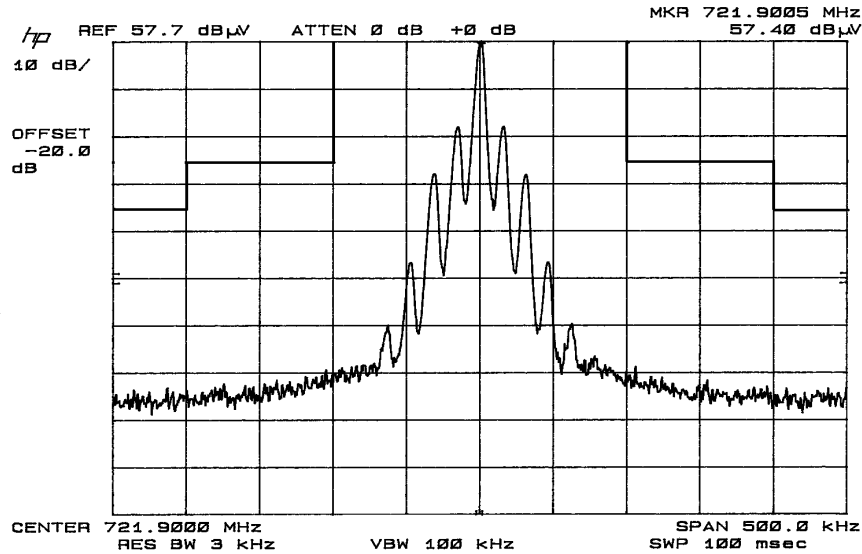

WIRELESS MICROPHONE TRANSMITTER

TEST PROCEDURE DIAGRAM

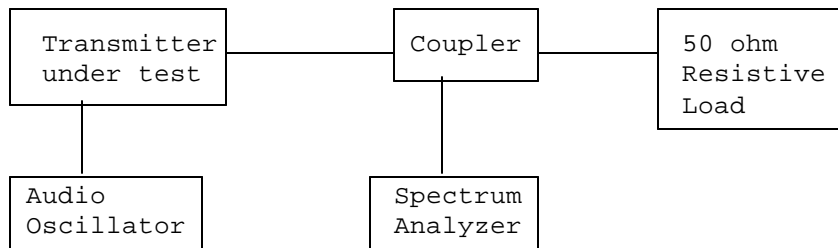

REQUIREMENT: PART 74: 200kHz EMISSION BANDWIDTH.

2.1051 Spurious emissions at antenna terminals(conducted):
Not Applicable no antenna connector.

2.1053(a)(b) Field strength of spurious emissions:

NAME OF TEST: RADIATED SPURIOUS EMISSIONS

REQUIREMENTS: Emissions must be 43 +10log(Po) dB below the mean power output of the transmitter.

$$43 + 10 \log(0.03) = 27.77 \text{ dB}$$

TEST DATA:

Emission Frequency (MHz)	Polarity Antenna	Corrected EUT Signal Reading (dBm)	Coax Loss	Sub. Ant.	dB Below Carrier (dBc)
698.10	V	5.20	0	0	0.00
1396.20	H	-34.00	1	3.17	37.03
2094.30	H	-36.20	1.2	5.24	37.36
2792.40	V	-48.60	1.3	6.74	48.36
3490.50	V	-46.30	1.35	7.2	45.65
4188.60	H	-44.80	1.45	7.45	44.00
4886.70	V	-44.00	1.5	8.29	42.41
5584.80	H	-46.50	1.7	8.61	44.79
6282.90	H	-47.70	1.9	9.12	45.68
6981.00	H	-48.50	2	8.9	46.80

Emission Frequency (MHz)	Polarity Antenna	Corrected EUT Signal Reading (dBm)	Coax Loss	Sub. Ant.	dB Below Carrier (dBc)
721.90	V	5.00	0	0	0.00
1443.80	H	-33.40	1.00	3.17	36.23
2165.70	H	-33.60	1.2	5.24	34.56
2887.60	V	-48.00	1.30	6.74	47.56
3609.50	H	-45.60	1.4	7.5	44.50
4331.40	V	-35.30	1.45	7.45	34.30
5053.30	H	-43.60	1.6	7.97	42.23
5775.20	H	-46.90	1.70	8.61	44.99
6497.10	H	-48.80	1.9	9.12	46.58
7219.00	V	-50.40	2	8.9	48.50

APPLICANT: Telex Communication Inc.

FCCID: B5DH219

REPORT #: T\TELEX\662AUT3\662AUT3TestReport.doc

NAME OF TEST: RADIATED SPURIOUS EMISSIONS CONTINUED

METHOD OF MEASUREMENTS: The tabulated data shows the results of the radiated field strength emissions test. The spectrum was scanned from 30 MHz to at least the tenth harmonic of the fundamental. This test was conducted per TIA/EIA STANDARD 603 using the substitution method. Measurements were made at the open field test site of TIMCO ENGINEERING, INC. located at 849 NW State Road 45, Newberry, FL 32669.

Method of Measuring Radiated Spurious Emissions

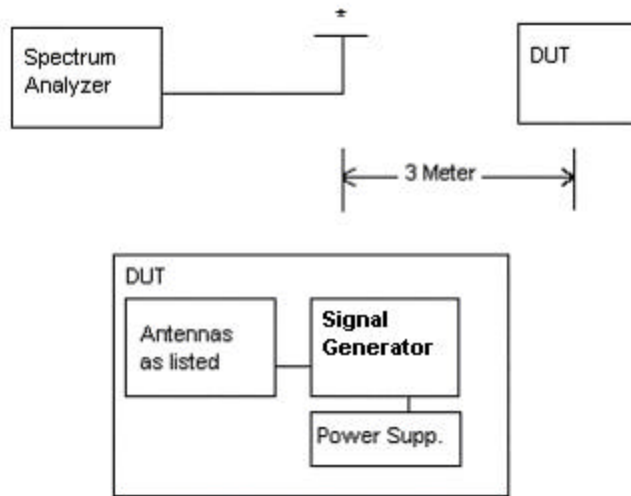

2.1055 Frequency stability:
S74.861(e)(4)

Temperature and voltage tests were performed to verify that the frequency remains within the .0050%, (50 ppm)(74.861 e.4) specification limit.

The test was conducted as follows: The transmitter was placed in the temperature chamber at 25 degrees C and allowed to stabilize for one hour. The transmitter was keyed ON for one minute during which four frequency readings were recorded at 15-second intervals. The worse case number was taken for temperature plotting. The assigned channel frequency was considered to be the reference frequency. The temperature was then reduced to -30 degrees C after which the transmitter was again allowed to stabilize for one hour. The transmitter was keyed ON for one minute, and again frequency readings were noted at 15-second intervals. The worst-case number was recorded for temperature plotting. This procedure was repeated in 10-degree increments up to + 50 degrees C.

MEASUREMENT DATA:

Assigned Frequency (Ref. Frequency): 698.100 099

TEMPERATURE °C	FREQUENCY MHz	PPM
-30C	698.084649	-22.13
-20C	698.090561	-13.66
-10C	698.095006	-7.30
0C	698.097372	-3.91
10C	698.099480	-0.89
20C	698.100099	0.00
30C	698.100458	0.51
40C	698.100750	0.93
50C	698.101937	2.63

25c END BATT. Volt(7.65)= 7.65VDC 698.100 115 + 0.02

RESULTS OF MEASUREMENTS: The maximum frequency variation over the temperature range was -22.13 to +2.63 ppm. The maximum frequency variation over the voltage range was +0.02 ppm.

EMC Equipment List

	DEVICE	MFGR	MODEL	SERNO	CAL/CHAR DATE	DUE DATE or STATUS
X	3-Meter OATS	TEI	N/A	N/A	Listed 1/13/03	1/13/06
	3/10-Meter OATS	TEI	N/A	N/A	Listed 3/26/01	3/26/04
	Receiver, Beige Tower Spectrum Analyzer	HP	8566B Opt 462	3138A07786 3144A20661	CAL 8/31/01	8/31/03
	RF Preselector	HP	85685A	3221A01400	CAL 8/31/01	8/31/03
	Quasi-Peak Adapter	HP	85650A	3303A01690	CAL 8/31/01	8/31/03
X	Receiver, Blue Tower Spectrum Analyzer	HP	8568B	2928A04729	CAL	4/15/05
X	RF Preselector	HP	85685A	2848A18049 2926A00983	CAL 4/15/03	4/15/05
X	Quasi-Peak Adapter	HP	85650A	2811A01279	CAL 4/15/03	4/15/05
	Receiver, Silver/Grey Tower Spectrum Analyzer	HP	8566B Opt 462	3552A22064 3638A08608	CAL 10/14/02	10/14/04
	RF Preselector	HP	85685A	2620A00294	CAL 10/14/02	10/14/04
	Quasi-Peak Adapter	HP	85650A	3303A01844	CAL 10/14/02	10/14/04
	Preamplifier	HP	8449B	3008A01075	CHAR 1/28/02	1/28/04
X	Biconnical Antenna	Electro-Metrics	BIA-25	1171	CAL 4/26/01	4/26/03
	Biconnical Antenna	Eaton	94455-1	1096	CAL 10/1/01	10/1/03
	Biconnical Antenna	Eaton	94455-1	1057	CAL 3/18/03	3/18/05
	BiconiLog Antenna	EMCO	3143	9409-1043		
X	Log-Periodic Antenna	Electro-Metrics	LPA-25	1122	CAL 10/2/01	10/2/03
	Log-Periodic Antenna	Electro-Metrics	EM-6950	632	CHAR 10/15/01	10/15/03

APPLICANT: Telex Communication Inc.

FCCID: B5DH219

REPORT #: T\TELEX\662AUT3\662AUT3TestReport.doc

Page 9 of 12

	DEVICE	MFGR	MODEL	SERNO	CAL/CHAR DATE	DUE DATE or STATUS
	Log-Periodic Antenna	Electro-Metrics	LPA-30	409	CAL 3/4/03	3/4/05
	Dipole Antenna Kit	Electro-Metrics	TDA-30/1-4	152	CAL 3/21/01	3/21/04
	Dipole Antenna Kit	Electro-Metrics	TDA-30/1-4	153	CAL 9/26/02	9/26/05
	Double-Ridged Horn Antenna	Electro-Metrics	RGA-180	2319	CAL 2/17/03	2/17/05
	Horn Antenna	Electro-Metrics	EM-6961	6246	CAL 3/31/03	3/31/05
	Horn Antenna	ATM	19-443-6R	None	No Cal Required	
	Passive Loop Antenna	EMC Test Systems	EMCO 6512	9706-1211	CHAR 7/10/01	7/10/03
	Line Impedance Stabilization . . .	Electro-Metrics	ANS-25/2	2604	CAL 10/9/01	10/9/03
	Line Impedance Stabilization . . .	Electro-Metrics	EM-7820	2682	CAL 3/12/03	3/12/05
	Termaline Wattmeter	Bird Electronic Corporation	611	16405	CAL 5/25/99	5/25/01
	Termaline Wattmeter	Bird Electronic Corporation	6104	1926	CHAR 12/12/01	12/12/03
	Oscilloscope	Tektronix	2230	300572	CHAR 2/1/01	2/1/03
	System One	Audio Precision	System One	SYS1-45868	CHAR 4/25/02	4/25/04
	Temperature Chamber	Tenney Engineering	TTRC	11717-7	CHAR 1/22/02	1/22/04
	AC Voltmeter	HP	400FL	2213A14499	CAL 10/9/01	10/9/03
	AC Voltmeter	HP	400FL	2213A14261	CHAR 10/15/01	10/15/03
	AC Voltmeter	HP	400FL	2213A14728	CHAR 10/15/01	10/15/03
X	Digital Multimeter	Fluke	77	35053830	CHAR 1/8/02	1/8/04
	Digital Multimeter	Fluke	77	43850817	CHAR 1/8/02	1/8/04
	Digital Multimeter	HP	E2377A	2927J05849	CHAR 1/8/02	1/8/04

	DEVICE	MFGR	MODEL	SERNO	CAL/CHAR DATE	DUE DATE or STATUS
	Multimeter	Fluke	FLUKE-77-3	79510405	CHAR 9/26/01	9/26/03
	Peak Power Meter	HP	8900C	2131A00545	CHAR 1/26/01	1/26/03
	Power Meter	HP	432A	1141A07655	CAL 4/15/03	4/15/05
	Power Meter And Sensor	Bird	4421-107 4022	0166 0218	CAL 4/16/03	4/16/05
	Power Sensor	HP	478A	72129	CAL 4/15/03	4/15/05
	Digital Thermometer	Fluke	2166A	42032	CAL 1/16/02	1/16/04
	Thermometer	Traulsen	SK-128		CHAR 1/22/02	1/22/04
	Thermometer	Extech	4028	14871-2	CAL 3/7/03	3/7/05
X	Hygro-Thermometer	Extech	445703	0602	CAL 10/4/02	10/4/04
	Frequency Counter	HP	5352B	2632A00165	CAL 11/28/01	11/28/03
	Frequency Counter	HP	5385A	2730A03025	CAL 3/7/03	3/7/05
	Power Sensor	Agilent Technologies	84811A	2551A02705	CHAR 1/26/01	1/26/03
	Service Monitor	IFR	FM/AM 500A	5182	CAL 11/22/00	11/22/02
	Comm. Serv. Monitor	IFR	FM/AM 1200S	6593	CAL 5/12/02	5/12/04
	Signal Generator	HP	8640B	2308A21464	CAL 2/15/02	2/15/04
	Sweep Generator	Wiltron	6648	101009	CAL 4/15/03	4/15/05
	Sweep Generator	Wiltron	6669M	007005	CAL 3/3/03	3/3/05
	Modulation Analyzer	HP	8901A	3435A06868	CAL 9/5/01	9/5/03
	Modulation Meter	Boonton	8220	10901AB	CAL 4/15/03	4/15/05
	Near Field Probe	HP	HP11940A	2650A02748	CHAR 2/1/01	2/1/03

DEVICE	MFGR	MODEL	SERNO	CAL/CHAR DATE	DUE DATE or STATUS
BandReject Filter	Lorch Microwave	5BR4-2400/60-N	Z1	CHAR 3/2/01	3/2/03
BandReject Filter	Lorch Microwave	6BR6-2442/300-N	Z1	CHAR 3/2/01	3/2/03
BandReject Filter	Lorch Microwave	5BR4-10525/900-S	Z1	CHAR 3/2/01	3/2/03
High Pass Filter	Microlab	HA-10N		CHAR 10/4/01	10/4/03
High Pass Filter	Microlab	HA-20N		CHAR 2/7/03	2/7/05
Audio Oscillator	HP	653A	832-00260	CHAR 3/1/01	3/1/03
Frequency Counter	HP	5382A	1620A03535	CHAR 3/2/01	3/2/03
Frequency Counter	HP	5385A	3242A07460	CAL 3/7/03	3/7/05
Preamplifier	HP	8449B-H02	3008A00372	CHAR 3/4/01	3/4/03
Amplifier	HP	11975A	2738A01969	CHAR 3/1/01	3/1/03
Egg Timer	Unk			CHAR 8/31/01	8/31/03
Measuring Tape, 20M	Kraftixx	0631-20		CHAR 2/1/02	2/1/04
Measuring Tape, 7.5M	Kraftixx	7.5M PROFI		2/1/02	2/1/04
Coaxial Cable #51	Insulated Wire Inc.	NPS 2251-2880	Timco #51	CHAR 1/23/02	1/23/04
Coaxial Cable #64	Semflex Inc.	60637	Timco #64	CHAR 1/24/02	1/24/04
Coaxial Cable #65	General Cable Co.	E9917 RG233/U	Timco #65	CHAR 1/23/02	1/23/04
Coaxial Cable #106	Unknown	Unknown	Timco #106	CHAR 1/23/02	1/23/04