

**MFA** **M. Flom Associates, Inc. - Global Compliance Center**  
3356 North San Marcos Place, Suite 107, Chandler, Arizona 85225-7176  
www.mflom.com general@mflom.com (480) 926-3100, FAX: 926-3598

---

Date of Report: September 11, 2002  
Date of Submission: September 18, 2002

Federal Communications Commission  
Via: Electronic Filing

Attention: Authorization & Evaluation Division  
  
Applicant: Telex Communications, Inc.  
Equipment: SAFE-HT  
FCC ID: B5DH218  
FCC Rules: 74H, 74.802, Confidentiality

Gentlemen:

On behalf of the Applicant, enclosed please find Application Form 731, Engineering Test Report and all pertinent documentation, the whole for approval of the referenced equipment as shown.

Filing fees are attached.

We trust the same is in order. Should you need any further information, kindly contact the writer who is authorized to act as agent.

Sincerely yours,

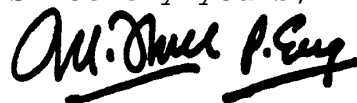

Morton Flom, P. Eng.

enclosure(s)  
cc: Applicant  
MF/cva

LIST OF EXHIBITS  
(FCC **CERTIFICATION** (TRANSMITTERS) - REVISED 9/28/98)

APPLICANT: Telex Communications, Inc.

FCC ID: B5DH218

BY APPLICANT:

- |   |                    |
|---|--------------------|
| 1. LETTER OF AUTHORIZATION                  | x                  |
| 2. IDENTIFICATION DRAWINGS, 2.1033(c)(11)   |                    |
| <u>x</u> LABEL                              |                    |
| <u>x</u> LOCATION OF LABEL                  |                    |
| <u>N/A</u> COMPLIANCE STATEMENT             |                    |
| <u>N/A</u> LOCATION OF COMPLIANCE STATEMENT |                    |
| 3. PHOTOGRAPHS, 2.1033(c)(12)               | x                  |
| 4. DOCUMENTATION: 2.1033(c)                 |                    |
| (3) USER MANUAL                             | x                  |
| (9) TUNE UP INFO                            | x                  |
| (10) SCHEMATIC DIAGRAM                      | x                  |
| (10) CIRCUIT DESCRIPTION                    | x                  |
| BLOCK DIAGRAM                               | x                  |
| PARTS LIST                                  | See Active Devices |
| ACTIVE DEVICES                              | x                  |

BY M.F.A. INC.

- A. TESTIMONIAL & STATEMENT OF CERTIFICATION
- B. STATEMENT OF QUALIFICATIONS

**MFA** **M. Flom Associates, Inc. - Global Compliance Center**  
3356 North San Marcos Place, Suite 107, Chandler, Arizona 85225-7176  
www.mflom.com general@mflom.com (480) 926-3100, FAX: 926-3598

---

T R A N S M I T T E R     C E R T I F I C A T I O N

of

FCC ID: B5DH218  
MODEL: SAFE-HT

to

FEDERAL COMMUNICATIONS COMMISSION

Rule Part(s) 74H, 74.802, Confidentiality

DATE OF REPORT: September 11, 2002

ON THE BEHALF OF THE APPLICANT:

Telex Communications, Inc.

AT THE REQUEST OF:

P.O. 264122

Telex Communications, Inc.  
8601 E. Cornhusker Highway  
P.O. Box 5579  
Lincoln, NE 68505-5579

Attention of:

Charles E. Conner, Project Engineer  
(402) 467-5321; FAX: -3279  
E-mail: charlie.conner@telex.com

SUPERVISED BY:



Morton Flom, P. Eng.

THE APPLICANT HAS BEEN CAUTIONED AS TO THE FOLLOWING:

15.21 INFORMATION TO USER.

The users manual or instruction manual for an intentional radiator shall caution the user that changes or modifications not expressly approved by the party responsible for compliance could void the user's authority to operate the equipment.

15.27(a) SPECIAL ACCESSORIES.

Equipment marketed to a consumer must be capable of complying with the necessary regulations in the configuration in which the equipment is marketed. Where special accessories, such as shielded cables and/or special connectors are required to enable an unintentional or intentional radiator to comply with the emission limits in this part, the equipment must be marketed with, i.e. shipped and sold with, those special accessories. However, in lieu of shipping or packaging the special accessories with the unintentional or intentional radiator, the responsible party may employ other methods of ensuring that the special accessories are provided to the consumer, without additional charge.

Information detailing any alternative method used to supply the special accessories for a grant of equipment authorization or retained in the verification records, as appropriate. The party responsible for the equipment, as detailed in § 2.909 of this chapter, shall ensure that these special accessories are provided with the equipment. The instruction manual for such devices shall include appropriate instructions on the first page of text concerned with the installation of the device that these special accessories must be used with the device. It is the responsibility of the user to use the needed special accessories supplied with the equipment.

TABLE OF CONTENTS

<u>RULE</u>	<u>DESCRIPTION</u>	<u>PAGE</u>
	Test Report	1
2.1033(c)	General Information Required	2
2.1033(c)(14)	Rule Summary	5
	Standard Test Conditions and Engineering Practices	6
2.1046(a)	Carrier Output Power (Conducted)	7
2.1046(a)	ERP Carrier Power (Radiated)	9
2.1051	Unwanted Emissions (Transmitter Conducted)	10
2.1053(a)	Field Strength of Spurious Radiation	13
2.1049(c)(1)	Emission Masks (Occupied Bandwidth)	17
2.1055(a)(1)	Frequency Stability (Temperature Variation)	23
2.1055(b)(1)	Frequency Stability (Voltage Variation)	26
2.202(g)	Necessary Bandwidth and Emission Bandwidth	27

PAGE NO. 1 of 27.

*Required information per ISO/IEC Guide 25-1990, paragraph 13.2:*

- a) TEST REPORT
- b) Laboratory: M. Flom Associates, Inc.  
(FCC: 31040/SIT) 3356 N. San Marcos Place, Suite 107  
(Canada: IC 2044) Chandler, AZ 85225
- c) Report Number: d0290016
- d) Client: Telex Communications, Inc.  
8601 E. Cornhusker Highway  
P.O. Box 5579  
Lincoln, NE 68505-5579
- e) Identification: SAFE-HT  
FCC ID: B5DH218  
EUT Description: Wireless Microphone
- f) EUT Condition: Not required unless specified in individual tests.
- g) Report Date: September 11, 2002  
EUT Received: September 3, 2002
- h, j, k): As indicated in individual tests.
- i) Sampling method: No sampling procedure used.
- l) Uncertainty: In accordance with MFA internal quality manual.
- m) Supervised by:   
Morton Flom, P. Eng.
- n) Results: The results presented in this report relate only to the item tested.
- o) Reproduction: This report must not be reproduced, except in full, without written permission from this laboratory.

PAGE NO. 2 of 27.

LIST OF GENERAL INFORMATION REQUIRED FOR CERTIFICATIONIN ACCORDANCE WITH FCC RULES AND REGULATIONS,  
VOLUME II, PART 2 AND TO

74H, 74.802, Confidentiality

Sub-part 2.1033(c)(1): NAME AND ADDRESS OF APPLICANT:Telex Communications, Inc.  
8601 E. Cornhusker Highway  
P.O. Box 5579  
Lincoln, NE 68505-5579MANUFACTURER:

Telex Communications, Inc.

(c)(2): FCC ID: B5DH218MODEL NO: SAFE-HT(c)(3): INSTRUCTION MANUAL(S):

PLEASE SEE ATTACHED EXHIBITS

(c)(4): TYPE OF EMISSION: 200K0F1E, Digital, NSFK(c)(5): FREQUENCY RANGE, MHz: 518 to 608  
614 to 746(c)(6): POWER RATING, Watts: 0.050  
Switchable Variable x N/AFCC GRANT NOTE: M4 - Operation of this unit  
is limited to use at  
stations licensed for use  
under Part 74 of FCC Rules.(c)(7): MAXIMUM POWER RATING, Watts: .250DUT RESULTS: Passes x Fails \_\_\_\_\_

M. Flom Associates, Inc. is accredited by the American Association for Laboratory Association (A2LA) as shown in the scope below.



**THE AMERICAN ASSOCIATION FOR LABORATORY ACCREDITATION**

**ACCREDITED LABORATORY**

A2LA has accredited

**M. FLOM ASSOCIATES, INC.**  
Chandler, AZ

for technical competence in the field of

**Electrical (EMC) Testing**

The accreditation covers the specific tests and types of tests listed on the agreed scope of accreditation. This laboratory meets the requirements of ISO/IEC 17025 - 1999 "General Requirements for the Competence of Testing and Calibration Laboratories" and any additional program requirements in the identified field of testing. Testing and calibration laboratories that comply with this International Standard also operate in accordance with ISO 9001 or ISO 9002.

Presented this 2<sup>nd</sup> day of March, 2001.



*Peter Abry*  
President  
For the Accreditation Council  
Certificate Number 1008.01  
Valid to December 31, 2002

For tests or types of tests to which this accreditation applies, please refer to the laboratory's Electrical (EMC) Scope of Accreditation



**American Association for Laboratory Accreditation**

SCOPE OF ACCREDITATION TO ISO/IEC 17025-1999

M. FLOM ASSOCIATES, INC.  
Electronic Testing Laboratory  
3356 North San Marcos Place, Suite 107  
Chandler, AZ 85225  
Morton Flom Phone: 480 926 3100

ELECTRICAL (EMC)

Valid to: December 31, 2002 Certificate Number: 1008-01

In recognition of the successful completion of the A2LA evaluation process, accreditation is granted to this laboratory to perform the following electromagnetic compatibility tests:

Tests	Standard(s)
RF Emissions	FCC Part 15 (Subparts B and C) using ANSI C63.4-2000, CISPR 11; CISPR 13; CISPR 14; CISPR 22; EN 55011; EN 55013; EN 55014; EN 55022; EN 50081-1; EN 50081-2; ICES-003; AS/NZS 1044; AS/NZS 1053; AS/NZS 3548; AS/NZS 4251.1; CNS 13438
Harmonic Currents	EN 61000-3-2
Fluctuation and Flicker	EN 61000-3-3
RF Immunity	EN: 50082-1, 50082-2, 55024; AS/NZS 4251.1
Electrostatic Discharge (ESD)	EN 61000-4-2
Radiated Susceptibility	EN 61000-4-3; ENV 50140; ENV 50204; IEC 1000-4-3; IEC 801-3
EFT	EN 61000-4-4; IEC 1000-4-4; IEC 801-4
Surge	EN 61000-4-5; ENV 50142; IEC 1000-4-5; IEC 801-5
Voltage Dips, Short Interruptions, and Line Voltage Variations	EN 61000-4-11
47 CFR (FCC)	Parts: 2, 18, 21, 22, 23, 24, 25, 26, 27, 74, 80, 87, 90, 95, 97, 101 (excluding SAR Testing)
Power Frequency Magnetic Field Immunity	EN 61000-4-8
Immunity to Conducted Disturbances	EN 61000-4-6

(A2LA Cert. No. 1008.01) 08/01/02

Page 1 of 1

5301 Buckeystown Pike, Suite 350 • Frederick, MD 21704-8373 • Phone: 301-644-3248 • Fax: 301-662-2974

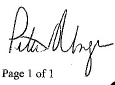

"This laboratory is accredited by the American Association for Laboratory Accreditation (A2LA) and the results shown in this report have been determined in accordance with the laboratory's terms of accreditation unless stated otherwise in the report."

Should this report contain any data for tests for which we are not accredited, or which have been undertaken by a subcontractor that is not A2LA accredited, such data would not covered by this laboratory's A2LA accreditation.



PAGE NO. 4 of 27.

Subpart 2.1033 (continued)

(c)(8): VOLTAGES & CURRENTS IN ALL ELEMENTS IN FINAL R. F. STAGE, INCLUDING FINAL TRANSISTOR OR SOLID STATE DEVICE:

COLLECTOR CURRENT, A = per manual  
 COLLECTOR VOLTAGE, Vdc = per manual  
 SUPPLY VOLTAGE, Vdc = 9

(c)(9): TUNE-UP PROCEDURE:

PLEASE SEE ATTACHED EXHIBITS

(c)(10): CIRCUIT DIAGRAM/CIRCUIT DESCRIPTION:

Including description of circuitry & devices provided for determining and stabilizing frequency, for suppression of spurious radiation, for limiting modulation and limiting power.

PLEASE SEE ATTACHED EXHIBITS

(c)(11): LABEL INFORMATION:

PLEASE SEE ATTACHED EXHIBITS

(c)(12): PHOTOGRAPHS:

PLEASE SEE ATTACHED EXHIBITS

(c)(13): DIGITAL MODULATION DESCRIPTION:

     ATTACHED EXHIBITS  
  x   N/A

(c)(14): TEST AND MEASUREMENT DATA:

FOLLOWS

PAGE NO.

5 of 27.

Sub-part  
2.1033(c)(14):TEST AND MEASUREMENT DATA

All tests and measurement data shown were performed in accordance with FCC Rules and Regulations, Volume II; Part 2, Sub-part J, Sections 2.947, 2.1033(c), 2.1041, 2.1046, 2.1047, 2.1079, 2.1051, 2.1053, 2.1055, 2.1057 and the following individual Parts:

- \_\_\_\_\_ 21 - Domestic Public Fixed Radio Services
- \_\_\_\_\_ 22 - Public Mobile Services
- \_\_\_\_\_ 22 Subpart H - Cellular Radiotelephone Service
- \_\_\_\_\_ 22.901(d) - Alternative technologies and auxiliary services
- \_\_\_\_\_ 23 - International Fixed Public Radiocommunication services
- \_\_\_\_\_ 24 - Personal Communications Services
- x 74 Subpart H - Low Power Auxiliary Stations
- \_\_\_\_\_ 80 - Stations in the Maritime Services
- \_\_\_\_\_ 80 Subpart E - General Technical Standards
- \_\_\_\_\_ 80 Subpart F - Equipment Authorization for Compulsory Ships
- \_\_\_\_\_ 80 Subpart K - Private Coast Stations and Marine Utility Stations
- \_\_\_\_\_ 80 Subpart S - Compulsory Radiotelephone Installations for Small Passenger Boats
- \_\_\_\_\_ 80 Subpart T - Radiotelephone Installation Required for Vessels on the Great Lakes
- \_\_\_\_\_ 80 Subpart U - Radiotelephone Installations Required by the Bridge-to-Bridge Act
- \_\_\_\_\_ 80 Subpart V - Emergency Position Indicating Radiobeacons (EPIRB'S)
- \_\_\_\_\_ 80 Subpart W - Global Maritime Distress and Safety System (GMDSS)
- \_\_\_\_\_ 80 Subpart X - Voluntary Radio Installations
- \_\_\_\_\_ 87 - Aviation Services
- \_\_\_\_\_ 90 - Private Land Mobile Radio Services
- \_\_\_\_\_ 94 - Private Operational-Fixed Microwave Service
- \_\_\_\_\_ 95 Subpart A - General Mobile Radio Service (GMRS)
- \_\_\_\_\_ 95 Subpart C - Radio Control (R/C) Radio Service
- \_\_\_\_\_ 95 Subpart D - Citizens Band (CB) Radio Service
- \_\_\_\_\_ 95 Subpart E - Family Radio Service
- \_\_\_\_\_ 95 Subpart F - Interactive Video and Data Service (IVDS)
- \_\_\_\_\_ 97 - Amateur Radio Service
- \_\_\_\_\_ 101 - Fixed Microwave Services

PAGE NO.

6 of 27.

STANDARD TEST CONDITIONS  
and  
ENGINEERING PRACTICES

Except as noted herein, the following conditions and procedures were observed during the testing:

In accordance with ANSI C63.4-1992/2000 Draft, section 6.1.9, and unless otherwise indicated in the specific measurement results, the ambient temperature of the actual EUT was maintained within the range of 10° to 40°C (50° to 104 °F) unless the particular equipment requirements specify testing over a different temperature range. Also, unless otherwise indicated, the humidity levels were in the range of 10% to 90% relative humidity.

Prior to testing, the EUT was tuned up in accordance with the manufacturer's alignment procedures. All external gain controls were maintained at the position of maximum and/or optimum gain throughout the testing.

Measurement results, unless otherwise noted, are worst case measurements.

PAGE NO. 7 of 27.  
NAME OF TEST: Carrier Output Power (Conducted)  
SPECIFICATION: 47 CFR 2.1046(a)  
GUIDE: ANSI/TIA/EIA-603-1992, Paragraph 2.2.1  
TEST EQUIPMENT: As per attached page

MEASUREMENT PROCEDURE

1. The EUT was connected to a resistive coaxial attenuator of normal load impedance, and the unmodulated output power was measured by means of an R. F. Power Meter.
2. Measurement accuracy is  $\pm 3\%$ .

MEASUREMENT RESULTS  
(Worst case)

FREQUENCY OF CARRIER, MHz = 731.202, 722.077, 745.902

<u>POWER SETTING</u>	<u>R. F. POWER, WATTS</u>
Conducted	.050

PERFORMED BY:

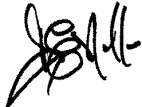
  
Doug Noble, B.A.S. E.E.T.

TRANSMITTER POWER CONDUCTED MEASUREMENTS

TEST 1: R. F. POWER OUTPUT  
 TEST 2: FREQUENCY STABILITY

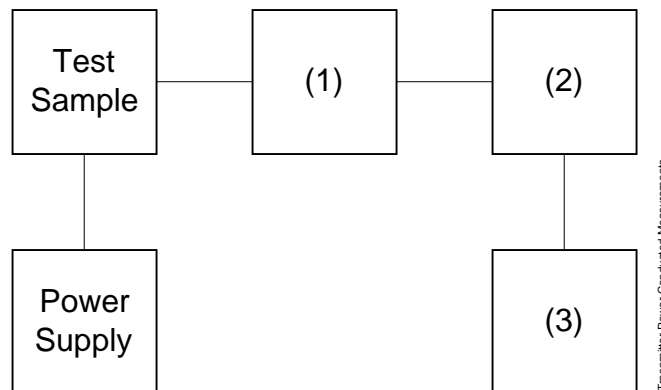

Asset	Description (as applicable)	s/n
(1)	<u>COAXIAL ATTENUATOR</u>	
i00122	Narda 766-10	7802
i00123	Narda 766-10	7802A
i00069	Bird 8329 (30 dB)	1006
i00113	Sierra 661A-3D	1059
(2)	<u>POWER METERS</u>	
i00014	HP 435A	1733A05836
i00039	HP 436A	2709A26776
i00020	HP 8901A POWER MODE	2105A01087
(3)	<u>FREQUENCY COUNTER</u>	
i00042	HP 5383A	1628A00959
i00019	HP 5334B	2704A00347
i00020	HP 8901A FREQUENCY MODE	2105A01087

PAGE NO. 9 of 27.

NAME OF TEST: ERP Carrier Power (Radiated)

SPECIFICATION: TIA/EIA 603A (Substitution Method)

2.2.17.1 Definition: The average radiated power of a licensed device is the equivalent power required, when delivered to a half-wave dipole or horn antenna, to produce at a distant point the same average received power as produced by the licensed device.

2.2.17.2 Method of Measurement:

a) Connect the equipment as illustrated. Place the transmitter to be tested on the turntable in the standard test site.

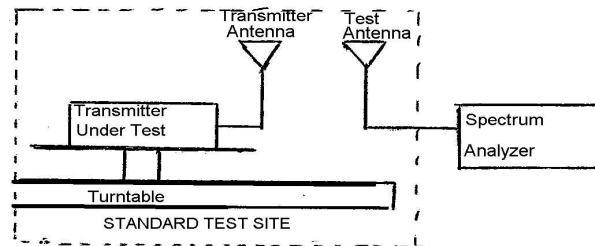

b) Raise and lower the test antenna from 1m to 6 m with the transmitter facing the antenna and record the highest received signal in dB as LVL.

c) Repeat step b) for seven additional readings at 45° interval positions of the turntable.

d) Replace the transmitter under test with a half-wave or horn vertically polarized antenna. The center of the antenna should be at the same location as the transmitter under test. Connect the antenna to a signal generator with a known output power and record the path loss in dB or LOSS.

e) Calculate the average radiated output power from the readings in step c) and d) by the following:

$$\text{average radiated power} = 10 \log_{10} \Sigma 10(\text{LVL} - \text{LOSS})/10 \text{ (dBm)}$$

	722.077 MHz		731.202 MHz		745.902 MHz	
	LVL, dbm	Path Loss, db	LVL, dbm	Path Loss, db	LVL, dbm	Path Loss, db
0°	16.1	2.3	14.6	4.3	16.1	0.8
45°	17.6	2.3	12.5	4.3	16.6	0.8
90°	15.9	2.3	12.1	4.3	16.9	0.8
135°	16.9	2.3	13.5	4.3	15.3	0.8
180°	16.3	2.3	13.5	4.3	15.8	0.8
225°	16.4	2.3	14.3	4.3	15.2	0.8
270°	15.4	2.3	13.6	4.3	15.6	0.8
315°	15.9	2.3	13.6	4.3	15.8	0.8

	722.077 MHz	731.202 MHz	745.902 MHz
Av. Radiated Power:	18.61 dbm	17.76 dbm	16.71 dbm

PAGE NO. 10 of 27.

NAME OF TEST: Unwanted Emissions (Transmitter Conducted)

SPECIFICATION: 47 CFR 2.1051

GUIDE: ANSI/TIA/EIA-603-1992, Paragraph 2.2.13

TEST EQUIPMENT: As per attached page

MEASUREMENT PROCEDURE

1. The emissions were measured for the worst case as follows:
  - (a): within a band of frequencies defined by the carrier frequency plus and minus one channel.
  - (b): from the lowest frequency generated in the EUT and to at least the 10th harmonic of the carrier frequency, or 40 GHz, whichever is lower.
2. The magnitude of spurious emissions that are attenuated more than 20 dB below the permissible value need not be specified.
3. MEASUREMENT RESULTS: ATTACHED FOR WORST CASE

FREQUENCY OF CARRIER, MHz	=	731.202, 722.077, 745.902
SPECTRUM SEARCHED, GHz	=	0 to 10 x F <sub>c</sub>
MAXIMUM RESPONSE, Hz	=	15K
ALL OTHER EMISSIONS	=	≥ 20 dB BELOW LIMIT

PERFORMED BY:

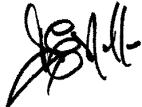
  
Doug Noble, B.A.S. E.E.T.

TRANSMITTER SPURIOUS EMISSION

TEST A. OCCUPIED BANDWIDTH (IN-BAND SPURIOUS)  
 TEST B. OUT-OF-BAND SPURIOUS

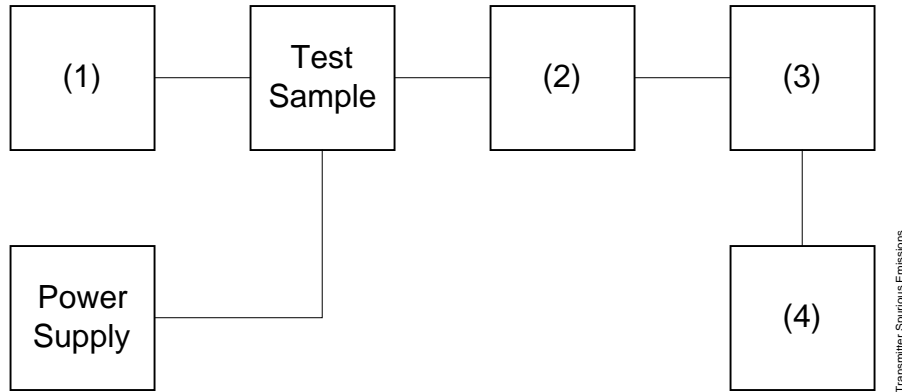

Asset Description (as applicable)	s/n
(1) <u>AUDIO OSCILLATOR/GENERATOR</u>	
i00010 HP 204D	1105A04683
i00017 HP 8903A	2216A01753
i00012 HP 3312A	1432A11250
(2) <u>COAXIAL ATTENUATOR</u>	
i00122 Narda 766-10	7802
i00123 Narda 766-10	7802A
i00069 Bird 8329 (30 dB)	1006
i00113 Sierra 661A-3D	1059
(3) <u>FILTERS; NOTCH, HP, LP, BP</u>	
i00126 Eagle TNF-1	100-250
i00125 Eagle TNF-1	50-60
i00124 Eagle TNF-1	250-850
(4) <u>SPECTRUM ANALYZER</u>	
i00048 HP 8566B	2511A01467
i00029 HP 8563E	3213A00104



PAGE NO. 12 of 27.

NAME OF TEST: Unwanted Emissions (Transmitter Conducted)

LIMIT(S), dBc:  $-(43+10 \times \text{LOG P}) = -30$  (0 Watts)

g0290019: 2002-Sep-03 Tue 14:14:00

STATE: 2:High Power

FREQUENCY TUNED, MHz	FREQUENCY EMISSION, MHz	LEVEL, dBm	LEVEL, dBc	MARGIN, dB
722.077000	1444.249500	-20.3	-37.2	-7.3
731.202000	1462.680000	-21.2	-38.1	-8.2
745.902000	1491.692500	-25.6	-42.5	-12.6
722.077000	2166.078000	-25	-41.9	-12
731.202000	2193.755000	-25.8	-42.7	-12.8
745.902000	2237.559000	-27.9	-44.8	-14.9
722.077000	2888.093500	-55.9	-72.8	-42.9
731.202000	2924.623500	-59.2	-76.1	-46.2
745.902000	2983.571500	-63.3	-80.2	-50.3
722.077000	3610.161000	-63.4	-80.3	-50.4
731.202000	3656.223000	-63	-79.9	-50
745.902000	3729.427500	-63.6	-80.5	-50.6
722.077000	4332.218500	-62.5	-79.4	-49.5
731.202000	4387.364000	-61.5	-78.4	-48.5
745.902000	4475.509000	-61.9	-78.8	-48.9
722.077000	5054.643000	-62.7	-79.6	-49.7
731.202000	5118.399500	-62.1	-79	-49.1
745.902000	5221.221500	-62.8	-79.7	-49.8
722.077000	5776.580000	-62.3	-79.2	-49.3
731.202000	5849.600500	-57.2	-74.1	-44.2
745.902000	5967.056000	-57.6	-74.5	-44.6
722.077000	6498.713400	-56.8	-73.7	-43.8
731.202000	6580.866000	-57.3	-74.2	-44.3
745.902000	6712.938500	-56.7	-73.6	-43.7
722.077000	7220.931200	-56.7	-73.6	-43.7
731.202000	7311.885000	-56.4	-73.3	-43.4
745.902000	7459.185000	-56.7	-73.6	-43.7
722.077000	7942.967000	-56.3	-73.2	-43.3
731.202000	8043.289500	-57.1	-74	-44.1
745.902000	8204.706500	-57.4	-74.3	-44.4
722.077000	8665.048500	-57.2	-74.1	-44.2
731.202000	8774.378500	-57.5	-74.4	-44.5
745.902000	8950.658000	-57.6	-74.5	-44.6
722.077000	9386.814800	-57	-73.9	-44
731.202000	9505.624500	-57	-73.9	-44
745.902000	9696.491000	-57	-73.9	-44
722.077000	10108.861300	-57.2	-74.1	-44.2
731.202000	10236.827500	-56	-72.9	-43
745.902000	10442.625000	-57.4	-74.3	-44.4
722.077000	10831.294000	-56.3	-73.2	-43.3
731.202000	10967.878500	-57	-73.9	-44
745.902000	11188.611500	-56.1	-73	-43.1



PERFORMED BY:

Doug Noble, B.A.S. E.E.T.

PAGE NO. 13 of 27.

NAME OF TEST: Field Strength of Spurious Radiation

SPECIFICATION: 47 CFR 2.1053(a)

GUIDE: ANSI/TIA/EIA-603-1992/2001, Paragraph 1.2.12 and Table 16, 47 CFR 22.917

MEASUREMENT PROCEDURE

1.2.12.1 Definition: Radiated spurious emissions are emissions from the equipment when transmitting into a non-radiating load on a frequency or frequencies which are outside an occupied band sufficient to ensure transmission of information of required quality for the class of communications desired.

1.2.12.2 Method of Measurement

- A) Connect the equipment as illustrated
- B) Adjust the spectrum analyzer for the following settings:
- 1) Resolution Bandwidth 100 kHz (<1 GHz), 1 MHz (> 1GHz).
  - 2) Video Bandwidth  $\geq 3$  times Resolution Bandwidth, or 30 kHz (22.917)
  - 3) Sweep Speed  $\leq 2000$  Hz/second
  - 4) Detector Mode = Mean or Average Power
- C) Place the transmitter to be tested on the turntable in the standard test site. The transmitter is transmitting into a non-radiating load which is placed on the turntable. The RF cable to this load should be of minimum length.

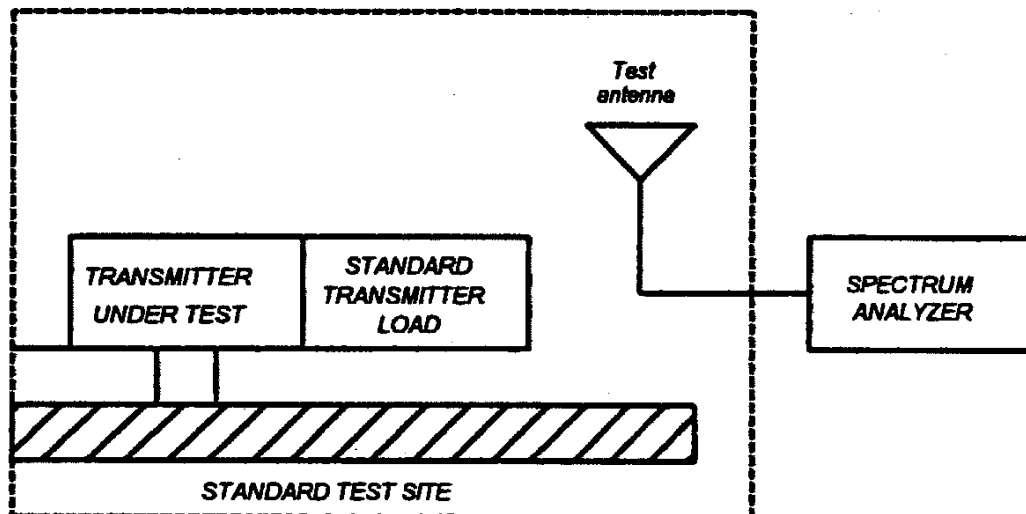

PAGE NO. 14 of 27.

NAME OF TEST: Field Strength of Spurious Radiation (Cont.)

- D) For each spurious measurement the test antenna should be adjusted to the correct length for the frequency involved. This length may be determined from a calibration ruler supplied with the equipment. Measurements shall be made from the lowest radio frequency generated in the equipment to the tenth harmonic of the carrier, except for the region close to the carrier equal to  $\pm$  the test bandwidth (see section 1.3.4.4).
- E) For each spurious frequency, raise and lower the test antenna from 1 m to 4 m to obtain a maximum reading on the spectrum analyzer with the test antenna at horizontal polarity. Repeat this procedure to obtain the highest possible reading. Record this maximum reading.
- F) Repeat step E) for each spurious frequency with the test antenna polarized vertically.

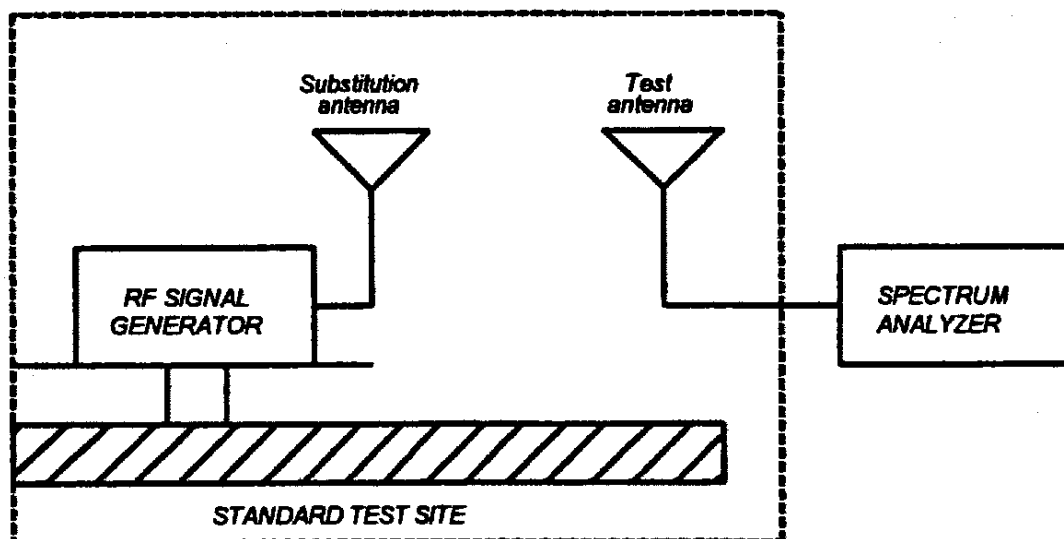

- G) Reconnect the equipment as illustrated.
- H) Keep the spectrum analyzer adjusted as in step B).
- I) Remove the transmitter and replace it with a substitution antenna (the antenna should be half-wavelength for each frequency involved). The center of the substitution antenna should be approximately at the same location as the center of the transmitter. At lower frequencies, where the substitution antenna is very long, this will be impossible to achieve when the antenna is polarized vertically. In such case the lower end of the antenna should be 0.3 m above the ground.

PAGE NO. 15 of 27.

NAME OF TEST: Field Strength of Spurious Radiation (Cont.)

- J) Feed the substitution antenna at the transmitter end with a signal generator connected to the antenna by means of a non-radiating cable. With the antennas at both ends horizontally polarized and with the signal generator tuned to a particular spurious frequency, raise and lower the test antenna to obtain a maximum reading at the spectrum analyzer. Adjust the level of the signal generator output until the previously recorded maximum reading for this set of conditions is obtained. This should be done carefully repeating the adjustment of the test antenna and generator output.
- K) Repeat step J) with both antennas vertically polarized for each spurious frequency.
- L) Calculate power in dBm into a reference ideal half-wave dipole antenna by reducing the readings obtained in steps J) and K) by the power loss in the cable between the generator and the antenna and further corrected for the gain of the substitution antenna used relative to an ideal half-wave dipole antenna.
- M) The levels recorded in step L) are absolute levels of radiated spurious emissions in dBm. The radiated spurious emissions in dB can be calculated by the following:

Radiated spurious emissions dB =  
 $10\log_{10}(\text{TX power in watts}/0.001) - \text{the levels in step l)}$

NOTE: It is permissible that other antennas provided can be referenced to a dipole.

Test Equipment:

Asset Description (as applicable)	s/n	Cycle	Last Cal
<u>TRANSDUCER</u>			
i00088 EMCO 3109-B 25MHz-300MHz	2336	12 mo.	Sep-02
i00065 EMCO 3301-B Active Monopole	2635	12 mo.	Sep-02
i00089 Aprel 2001 200MHz-1GHz	001500	12 mo.	Sep-02
i00103 EMCO 3115 1GHz-18GHz	9208-3925	12 mo.	Sep-02
<u>AMPLIFIER</u>			
i00028 HP 8449A	2749A00121	12 mo.	Mar-02
<u>SPECTRUM ANALYZER</u>			
i00029 HP 8563E	3213A00104	12 mo.	Jan-02
i00033 HP 85462A	3625A00357	12 mo.	Jan-02
i00048 HP 8566B	2511AD1467	6 mo.	Jan-02
<u>MICROPHONE, ANTENNA PORT, AND CABELING</u>			
Microphone	Yes/No	<u>N</u>	Cable Length <u>N/A</u> Meters
Antenna Port Terminated	Yes/No	<u>Y</u>	Load <u>Y</u> Antenna Gain <u>0dBd</u>
All Ports Terminated by	Load	<u>Y</u>	Peripheral <u>N</u>

PAGE NO. 16 of 27.

NAME OF TEST: Field Strength of Spurious Radiation  
g0290028: 2002-Sep-04 Wed 10:47:00  
STATE: 2:High Power

FREQUENCY TUNED, MHz	FREQUENCY EMISSION, MHz	ERP, dBm	ERP, dbc
731.202000	1462.404000	-22.4	≤-38.9
731.202000	2193.606000	-24.2	≤-38.9
731.202000	2924.808000	-30	≤-38.9
731.202000	3656.010000	-34	≤-38.9
731.202000	4387.212000	-34.8	≤-38.9
731.202000	5118.414000	-29.9	≤-38.9
731.202000	5849.616000	-39.8	≤-38.9
731.202000	6580.818000	-35.6	≤-38.9
731.202000	7312.020000	-41.3	≤-38.9

SUPERVISED BY:

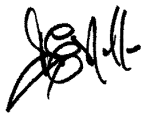
  
Doug Noble, B.A.S. E.E.T.

PAGE NO. 17 of 27.  
NAME OF TEST: Emission Masks (Occupied Bandwidth)  
SPECIFICATION: 47 CFR 2.1049(c)(1)  
GUIDE: ANSI/TIA/EIA-603-1992, Paragraph 2.2.11  
TEST EQUIPMENT: As per previous page

MEASUREMENT PROCEDURE

1. The EUT and test equipment were set up as shown on the following page, with the Spectrum Analyzer connected.
2. For EUTs supporting audio modulation, the audio signal generator was adjusted to the frequency of maximum response and with output level set for  $\pm 2.5/\pm 1.25$  kHz deviation (or 50% modulation). With level constant, the signal level was increased 16 dB.
3. For EUTs supporting digital modulation, the digital modulation mode was operated to its maximum extent.
4. The Occupied Bandwidth was measured with the Spectrum Analyzer controls set as shown on the test results.
5. MEASUREMENT RESULTS: ATTACHED

PAGE NO. 18 of 27.

NAME OF TEST: Emission Masks (Occupied Bandwidth)  
g0290013: 2002-Sep-03 Tue 13:46:00  
STATE: 2:High Power

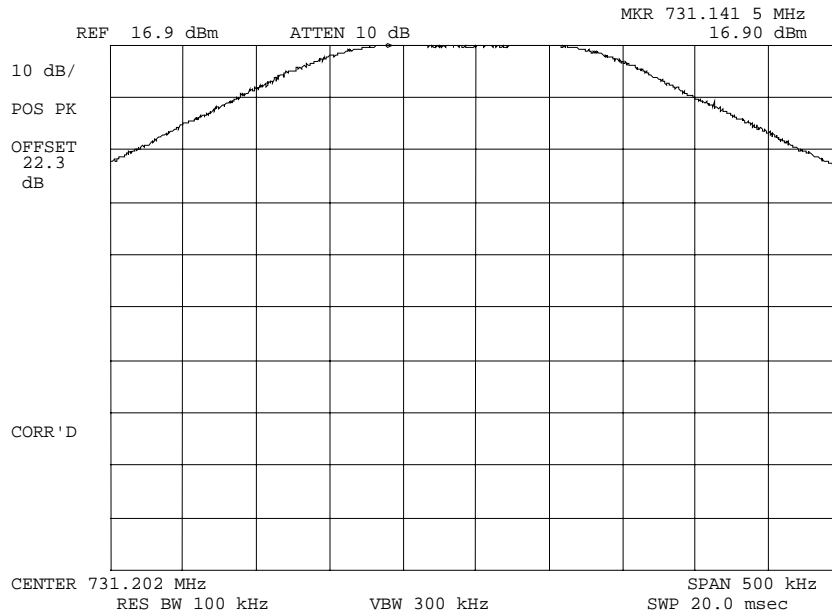

POWER:  
MODULATION:

HIGH  
DIGITAL  
REFERENCE LEVEL

PERFORMED BY:

Doug Noble, B.A.S. E.E.T.

PAGE NO. 19 of 27.

NAME OF TEST: Emission Masks (Occupied Bandwidth)  
g0290014: 2002-Sep-03 Tue 13:47:00  
STATE: 2:High Power

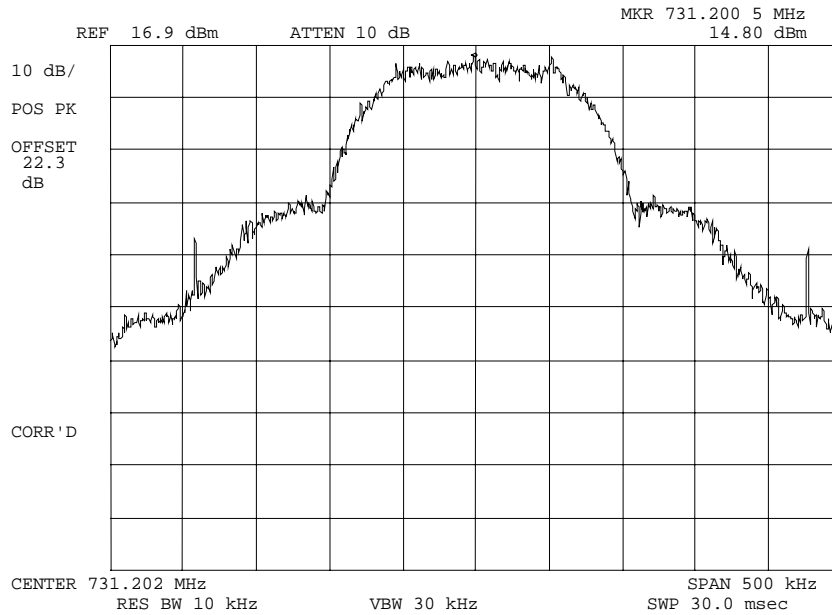

POWER: HIGH  
MODULATION: DIGITAL

PERFORMED BY:

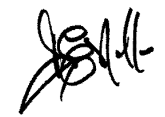
  
Doug Noble, B.A.S. E.E.T.



PAGE NO. 20 of 27.

NAME OF TEST: Emission Masks (Occupied Bandwidth)  
g0290015: 2002-Sep-03 Tue 13:48:00  
STATE: 2:High Power

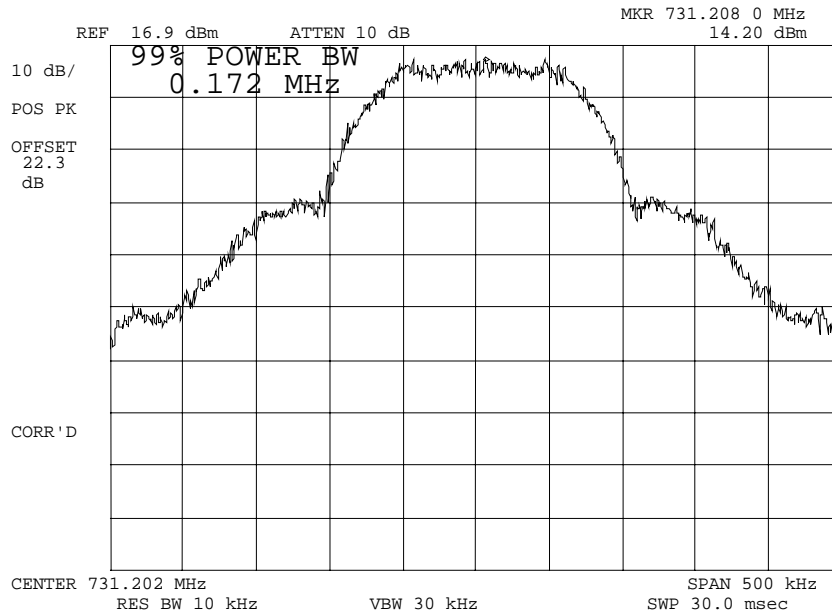

POWER: HIGH  
MODULATION: DIGITAL  
99 % POWER BANDWIDTH

PERFORMED BY:

Doug Noble, B.A.S. E.E.T.

PAGE NO. 21 of 27.

NAME OF TEST: Emission Masks (Occupied Bandwidth)  
g0290017: 2002-Sep-03 Tue 13:51:00  
STATE: 2:High Power

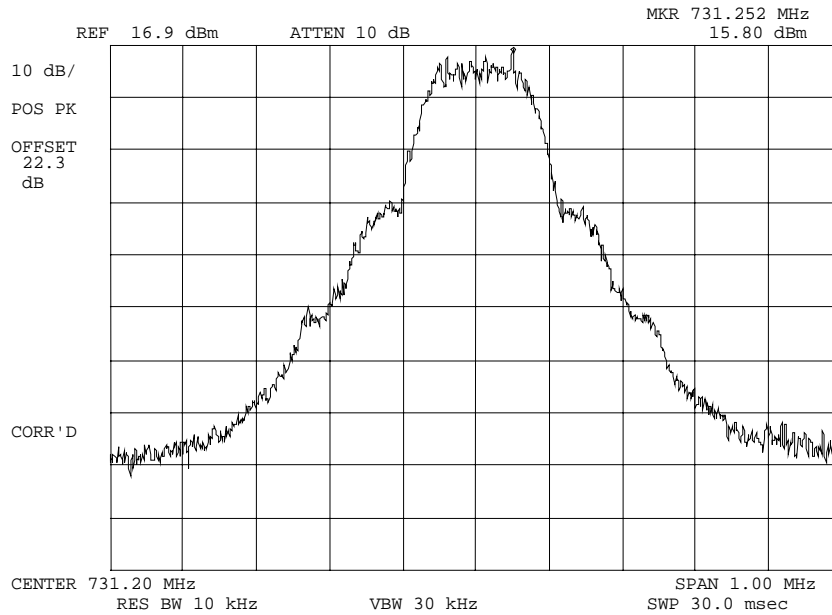

POWER: HIGH  
MODULATION: DIGITAL

PERFORMED BY:

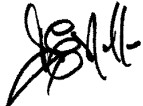
  
Doug Noble, B.A.S. E.E.T.

PAGE NO. 22 of 27.

NAME OF TEST: Emission Masks (Occupied Bandwidth)  
g0290018: 2002-Sep-03 Tue 14:01:00  
STATE: 2:High Power

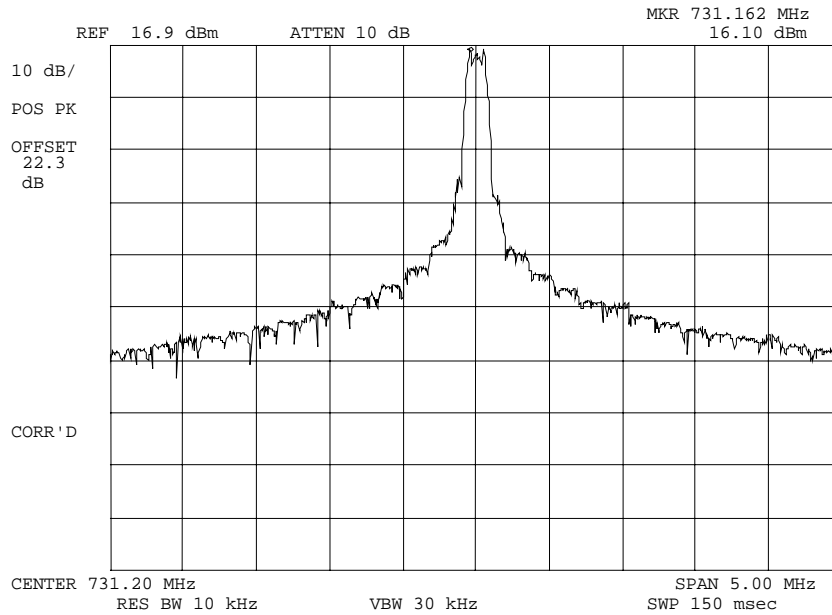

POWER: HIGH  
MODULATION: DIGITAL

PERFORMED BY:

Doug Noble, B.A.S. E.E.T.

PAGE NO. 23 of 27.  
NAME OF TEST: Frequency Stability (Temperature Variation)  
SPECIFICATION: 47 CFR 2.1055(a)(1)  
GUIDE: ANSI/TIA/EIA-603-1992, Paragraph 2.2.2  
TEST CONDITIONS: As Indicated  
TEST EQUIPMENT: As per previous page

MEASUREMENT PROCEDURE

1. The EUT and test equipment were set up as shown on the following page.
2. With all power removed, the temperature was decreased to -30°C and permitted to stabilize for three hours. Power was applied and the maximum change in frequency was noted within one minute.
3. With power OFF, the temperature was raised in 10°C steps. The sample was permitted to stabilize at each step for at least one-half hour. Power was applied and the maximum frequency change was noted within one minute.
4. The temperature tests were performed for the worst case.
5. MEASUREMENT RESULTS: ATTACHED

TRANSMITTER TEST SET-UP

- TEST A. OPERATIONAL STABILITY
- TEST B. CARRIER FREQUENCY STABILITY
- TEST C. OPERATIONAL PERFORMANCE STABILITY
- TEST D. HUMIDITY
- TEST E. VIBRATION
- TEST F. ENVIRONMENTAL TEMPERATURE
- TEST G. FREQUENCY STABILITY: TEMPERATURE VARIATION
- TEST H. FREQUENCY STABILITY: VOLTAGE VARIATION

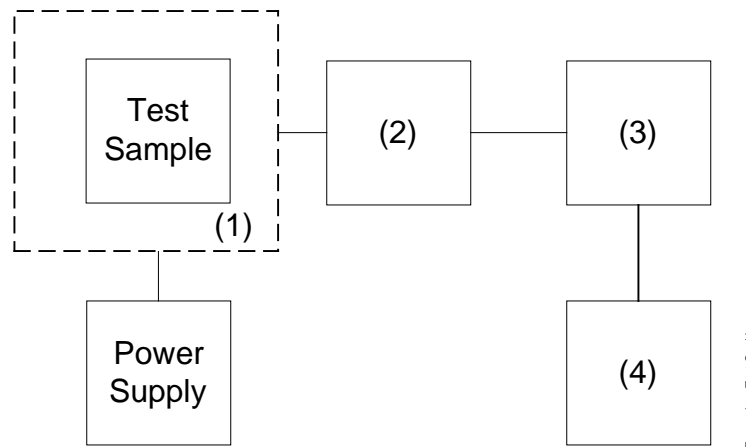

Transmitter Test Set-Up

Asset Description (as applicable)	s/n
<u>(1) TEMPERATURE, HUMIDITY, VIBRATION</u>	
i00027 Tenney Temp. Chamber	9083-765-234
i00 Weber Humidity Chamber	
i00 L.A.B. RVH 18-100	
<u>(2) COAXIAL ATTENUATOR</u>	
i00122 NARDA 766-10	7802
i00123 NARDA 766-10	7802A
i00113 SIERRA 661A-3D	1059
i00069 BIRD 8329 (30 dB)	10066
<u>(3) R.F. POWER</u>	
i00014 HP 435A POWER METER	1733A05839
i00039 HP 436A POWER METER	2709A26776
i00020 HP 8901A POWER MODE	2105A01087
<u>(4) FREQUENCY COUNTER</u>	
i00042 HP 5383A	1628A00959
i00019 HP 5334B	2704A00347
i00020 HP 8901A	2105A01087

PAGE NO. 25 of 27.

NAME OF TEST: Frequency Stability (Temperature Variation)  
g0290002: 2002-Sep-03 Tue 14:29:47  
STATE: 0:General

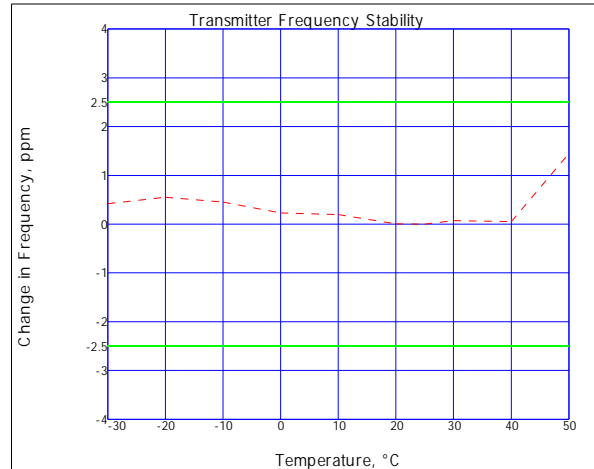

PERFORMED BY:

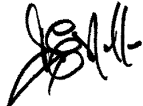
  
Doug Noble, B.A.S. E.E.T.

PAGE NO. 26 of 27.  
NAME OF TEST: Frequency Stability (Voltage Variation)  
SPECIFICATION: 47 CFR 2.1055(d)(1)  
GUIDE: ANSI/TIA/EIA-603-1992, Paragraph 2.2.2  
TEST EQUIPMENT: As per previous page

MEASUREMENT PROCEDURE

1. The EUT was placed in a temperature chamber at 25±5°C and connected as for "Frequency Stability - Temperature Variation" test.
2. The power supply voltage to the EUT was varied from 85% to 115% of the nominal value measured at the input to the EUT.
3. The variation in frequency was measured for the worst case.

RESULTS: Frequency Stability (Voltage Variation)  
g0290020: 2002-Sep-03 Tue 15:13:41  
STATE: 0:General

LIMIT, ppm = 50  
LIMIT, Hz = 3500  
BATTERY END POINT (Voltage) = 7.2

% of STV	Voltage	Frequency, MHz	Change, Hz	Change, ppm
85	7.65	731.199930	-70	-0.10
100	9	731.200000	0	0.00
115	10.35	731.199990	-10	-0.01
80	7.2	731.200080	80	0.11

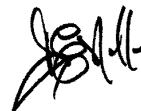

PERFORMED BY:

Doug Noble, B.A.S. E.E.T.

PAGE NO. 27 of 27.

NAME OF TEST: Necessary Bandwidth and Emission Bandwidth

SPECIFICATION: 47 CFR 2.202(g)

MODULATION = 200K0F1E

NECESSARY BANDWIDTH CALCULATION:

MAXIMUM MODULATION (M), kHz	=	15
MAXIMUM DEVIATION (D), kHz	=	85
CONSTANT FACTOR (K)	=	1
NECESSARY BANDWIDTH (B <sub>N</sub> ), kHz	=	200
	=	200

MODULATION = Digital, NSFK

NECESSARY BANDWIDTH CALCULATION:

MAXIMUM MODULATION (M), kHz	=	15
MAXIMUM DEVIATION (D), kHz	=	71
CONSTANT FACTOR (K)	=	1
NECESSARY BANDWIDTH (B <sub>N</sub> ), kHz	=	172
	=	

PERFORMED BY:

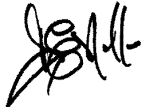
  
Doug Noble, B.A.S. E.E.T.

END OF TEST REPORT



TESTIMONIAL  
AND  
STATEMENT OF CERTIFICATION

THIS IS TO CERTIFY THAT:

1. THAT the application was prepared either by, or under the direct supervision of, the undersigned.
2. THAT the technical data supplied with the application was taken under my direction and supervision.
3. THAT the data was obtained on representative units, randomly selected.
4. THAT, to the best of my knowledge and belief, the facts set forth in the application and accompanying technical data are true and correct.

CERTIFYING ENGINEER:



Morton Flom, P. Eng.