

FCC TEST REPORT

FCC ID : B5DB123

Applicant : Bosch Security Systems, Inc.

Address : 8601 East Cornhusker Highway Lincoln, Nebraska 68507 United States

Equipment Under Test (EUT) :

Product description : UHF Wireless Microphone

Model No. : BP300

Standards : FCC Part 74:2004

Date of Test : Sep.05 to Nov.04, 2010

Test Engineer : (Olic huang) 

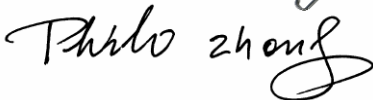
Reviewed By : (Philo zhong) 

PERPARED BY:

Waltek Services (Shenzhen) Co., Ltd.

1/F, Fukangtai Building, West Baima Rd., Songgang Street, Baoan District, Shenzhen
518105, China

Tel :+86-755-27553488

Fax:+86-755-27553868

2 Contents

	Page
1 COVER PAGE.....	1
2 CONTENTS	2
3 TEST SUMMARY	4
4 GENERAL INFORMATION	5
4.1 CLIENT INFORMATION	5
4.2 GENERAL DESCRIPTION OF E.U.T.	5
4.3 DETAILS OF E.U.T.	5
4.4 DESCRIPTION OF SUPPORT UNITS	5
4.5 STANDARDS APPLICABLE FOR TESTING	5
4.6 WORKING FREQUENCY OF E.U.T.	5
4.7 TEST FACILITY	6
4.8 TEST LOCATION	6
5 EQUIPMENT USED DURING TEST	7
6 CONDUCTED EMISSION TEST.....	10
6.1 CONDUCTED EMISSION LIMIT	10
6.2 CONDUCTED EMISSION DATA RECORD.....	10
7 MAXIMUM POWER OUTPUT	11
7.1 RULES AND LIMITS	11
7.2 TEST EQUIPMENT	11
7.3 TEST PROCEDURE.....	11
7.4 TEST SETUP BLOCKDIAGRAM	11
7.5 MEASUREMENT RESULT	11
8 MODULATION CHARACTERISTICS	12
8.1 RULES AND LIMITS	12
8.2 TEST EQUIPMENT	12
8.3 FREQUENCY RESPONSE OF AUDIO MODULATION CIRCUIT AND LOW PASS FILTER MEASUREMENT	12
8.4 CONDITION & SETUP	12
8.5 MEASUREMENT RESULT.....	13
8.6 MODULATION LIMITING MEASUREMENT CONDITION & SETUP	15
8.7 MEASUREMENT RESULT	15
9 OCCUPIED BANDWIDTH.....	17
9.1 RULES AND LIMITS	17
9.2 TEST EQUIPMENT	17
9.3 TEST PROCEDURE.....	17
9.4 MEASUREMENT RESULT	18
10 ANTENNA CONDUCTED EMISSIONS.....	29
10.1 MEASUREMENT LIMIT	29
10.2 MEASUREMENT PROCEDURE.....	29
10.3 MEASUREMENT SETUP BLOCKDIAGRAM	29
10.4 MEASUREMENT RESULT RECORD	29
11 EMISSIONS MASK	31
11.1 MEASUREMENT PROCEDURE.....	31

11.2 MEASUREMENT RESULT.....31

12 AUDIO FREQUENCY RESPONSE.....32

12.1 MEASUREMENT PROCEDURE.....32

12.2 MEASUREMENT SETUP BLOCKDIAGRAM32

12.3 MEASUREMENT RESULT.....32

13 AUDIO INPUT VERSUS MODULATION.....33

13.1 MEASUREMENT PROCEDURE.....33

13.2 MEASUREMENT SETUP BLOCKDIAGRAM33

13.3 MEASUREMENT RESULT.....33

14 FIELD STRENGTH OF SPURIOUS RADIATION34

14.1 RULES AND LIMITS.....34

14.2 TEST EQUIPMENT34

14.3 TEST PROCEDURE.....34

14.4 MEASUREMENT RESULT.....36

15 FREQUENCY STABILITY TOLERANCE39

15.1 RULES AND LIMITS.....39

15.2 TEST EQUIPMENT39

15.3 TEMPERATURE VARIATION TEST PROCEDURE39

15.4 MEASUREMENT RESULT.....40

15.5 VOLTAGE VARIATION TEST PROCEDURE42

15.6 MEASUREMENT RESULT.....42

16 PHOTOGRAPHS OF TESTING44

16.1 RADIATION EMISSION TEST VIEW FOR 30MHZ-1000MHZ.....44

16.2 RADIATION EMISSION TEST VIEW FOR 1GHZ-10GHZ.....44

17 PHOTOGRAPHS - CONSTRUCTIONAL DETAILS.....45

17.1 EUT - FRONT VIEW.....45

17.2 EUT - BACK VIEW45

17.3 EUT-OPEN VIEW.....46

17.4 PCB 1- FRONT VIEW46

17.5 PCB2 - BACK VIEW47

17.6 PCB 2- FRONT VIEW47

17.7 PCB 2- FRONT VIEW48

18 FCC ID LABEL49

3 Test Summary

Test Item	Test Standard	Test Method	Test Result
Radiated Emission	FCC PART 74: 2004	Section 74.861 (e)(6)	PASS
Occupied Bandwidth	FCC PART 74: 2004	Section 74.861 (e)(5)	PASS
Maximum Output Power	FCC PART 74: 2004	Section 74.861 (e)(1)(i)	PASS
Frequency Stability Tolerance	FCC PART 74: 2004	Section 74.861 (e)(4)	PASS
Audio Low Pass Filter	FCC Part 2: 2004	FCC Part 2.1047(a).	PASS
Audio Frequency Response	FCC Part 2: 2004	FCC Part 2.1047(a).	PASS
Modulation Limiting	FCC Part 2: 2004 FCC PART 74: 2004	FCC Part 2.1047(b). Section 74.861 (e)(3)	PASS

4 General Information

4.1 Client Information

Applicant: Bosch Security Systems, Inc.
 Address of Applicant: 8601 East Cornhusker Highway Lincoln, Nebraska 68507 United States

Manufacturer: Relacart Electronics CO., LTD.
 Address of Manufacture: 1408, Building B, Poly Fengxing Plaza, No. 242 Tian He Road, Tian He District, Guangzhou, Guangdong, China

4.2 General Description of E.U.T.

Product description: UHF Wireless Microphone
 Model No.: BP300

4.3 Details of E.U.T.

Power Supply: DC 3.0V Battery

4.4 Description of Support Units

The EUT has been tested as an independent unit.

4.5 Standards Applicable for Testing

The customer requested FCC tests for a UHF Wireless Microphone. The radiated emission test was performed according to the procedures of ANSI TIA/ELA 603 and FCC CFR47 Part 74.861, 2.1046, 2.1047.

4.6 Working Frequency of E.U.T.

Group 1		Group 2		Group 3		Group 4	
Channel	Freq	Channel	Freq	Channel	Freq	Channel	Freq
1	618.500	9	618.900	17	619.300	25	619.700
2	622.700	10	620.100	18	620.500	26	620.900
3	624.400	11	621.500	19	621.900	27	622.300
4	628.300	12	623.100	20	623.500	28	623.900
5	628.800	13	624.900	21	625.300	29	625.700
6	630.700	14	626.925	22	627.325	30	627.725
7	631.400	15	629.325	23	629.725	31	630.125
8	633.500	16	632.075	24	632.475	32	632.875

4.7 Test Facility

The test facility is recognized, certified, or accredited by the following organizations:

- **FCC – Registration No.: 880581**

Waltek Services(Shenzhen) Co., Ltd. EMC Laboratory has been registered and fully described in a report filed with the (FCC) Federal Communications Commission. The acceptance letter from the FCC is maintained in our files. Registration 880581, June 24, 2008.

- **IC – Registration No.: IC 7760A**

Waltek Services(Shenzhen) Co., Ltd. EMC Laboratory has been registered and fully described in a report filed with the Industry Canada. The acceptance letter from the Industry Canada is maintained in our files. Registration IC7760A, Aug. 03, 2010.

4.8 Test Location

All Emissions tests were performed at:-

1/F, Fukangtai Building, West Baima Rd., Songgang Street, Baoan District, Shenzhen 518105, Guangdong, China.

5 Equipment Used during Test

Equipment Name	Manufacturer Model	Equipment No	Internal No	Specification	Cal. Date	Due Date	Cert. No	Uncertainty
EMC Analyzer	Agilent/ E7405A	MY451149 43	W2008001	9k-26.5GHz	Aug-03 -10	Aug-02 -11	Wws200 81596	±1dB
Trilog Broadband Antenne 30-3000 MHz	SCHWARZB ECK MESS-ELEK TROM/ VULB9163	336	W2008002	30-3000 MHz	Aug-03 -10	Aug-02 -11		±1dB
Broad-band Horn Antenna	SCHWARZB ECK MESS-ELEK TROM/ BBHA 9120D(1201)	667	W2008003	1-18GHz	Aug-03 -10	Aug-02 -11		f<10 GHz: ±1dB 10GHz<f< 18 GHz: ±1.5dB
Broadband Preamplifier	SCHWARZB ECK MESS-ELEK TROM/ BBV 9718	9718-148	W2008004	0.5-18GHz	Aug-03 -10	Aug-02 -11		±1.2dB
10m Coaxial Cable with N-male Connectors usable up to 25GHz,	SCHWARZB ECK MESS-ELEK TROM/ AK 9515 H	-	-	-	Aug-03 -10	Aug-02 -11		-
10m 50 Ohm Coaxial Cable with N-plug, individual length, usable up to 3(5)GHz, Connector	SCHWARZB ECK MESS-ELEK TROM/ AK 9513				Aug-03 -10	Aug-02 -11		
Positioning Controller	C&C LAB/ CC-C-IF				N/A	N/A		
Color Monitor	SUNSP0/ SP-14C				N/A	N/A		
Test Receiver	ROHDE&SC HWARZ/ ESPI	101155	W2005001	9k-3GHz	Aug-03 -10	Aug-02 -11	Wws200 80942	±1dB
EMI Receiver	Beijingkehua n	KH3931		9k-1GHz	Aug-03 -10	Aug-02 -11		
Two-Line V-Network	ROHDE&SC HWARZ/ ENV216	100115	W2005002	50Ω/50μH	Aug-03 -10	Aug-02 -11	Wws200 80941	±10%
Absorbing Clamp	ROHDE&SC HWARZ/ MDS-21	100205	W2005003	impedance50 Ω loss : 17 dB	Aug-03 -10	Aug-02 -11	Wws200 80943	±1dB

Equipment Name	Manufacturer Model	Equipment No	Internal No	Specification	Cal. Date	Due Date	Cert. No	Uncertainty
10m 50 Ohm Coaxial Cable with N-plug, individual length, usable up to 3(5)GHz, Connectors	SCHWARZBECK MESS-ELEKTROM/ AK 9514				Aug-03-10	Aug-02-11		
Digital Power Analyzer	Em Test AG/Switzerland/ DPA 500	V0745103095	W2008012	Power: 2000VA Vol-range: 0-300V Freq_range: 10-80Hz	Aug-03-10	Aug-02-11	Wwd20081185	Voltage distinguish: 0.025% Power_freq distinguish: 0.02Hz
Power Source	Em Test AG/Switzerland/ ACS 500	V0745103096	W2008013	Vol-range: 0-300V Power_freq: 10-80Hz				
Electrostatic Discharge Simulator	Em Test AG/Switzerland/DITO	V0745103094	W2008005	Contact discharge: 500V-10KV Air discharge: 500V-16.5KV	Aug-03-10	Aug-02-11	Wwc20082400	7.5A current will be changed in $V_m=1.5V$
RF Generator	TESEQ GmbH/ NSG4070	25781	W2008008	Fraq-range: 9K-1GHz RF voltage: -60dBm-+10dBm	Aug-03-10	Aug-02-11	Wws20081890	Power_freq distinguish: 0.1Hz RFelectricity distinguish: 0.1B
CDN M-Type	TESEQ GmbH/ CDN M016	25112	W2008009	Voltage correct factor 9.5 dB	Aug-03-10	Aug-02-11	Wwc20082396	150K-80MHz: $\pm 1dB$ 80-230MHz: -2-+3dB
EM-Clamp	TESEQ GmbH/ KEMZ 801	25453	W2008010	Freq_range: 0.15-1000 MHz	Aug-03-10	Aug-02-11	Wwc20082397	0.3-400 MHz: $\pm 4dB$ Other freq: $\pm 5dB$
Attenuator 6dB	TESEQ GmbH/ ATN6050	25365			Aug-03-10	Aug-02-11	Wws20081597	
All Modules Generator	SCHAFFNER/ R/6150	34579	W2008006	voltage: 200V-4.4KV Pulse current: 100A-2.2KA	Aug-03-10	Aug-02-11	Wwc20082401	voltage: $\pm 10%$ Pulse current: $\pm 10%$
Capacitive Coupling Clamp	SCHAFFNER/ CDN 8014	25311			Aug-03-10	Aug-02-11	Wwc20082398	-
Signal and Data Line Coupling Network	SCHAFFNER/ CDN 117	25627	W2008011	1.2/50 μ S	Aug-03-10	Aug-02-11	Wwc20082399	-
AC Power Supply	TONGYUN/ DTDGC-4				Aug-03-10	Aug-02-11	Wws20080944	-

Equipment Name	Manufacturer Model	Equipment No	Internal No	Specification	Cal. Date	Due Date	Cert. No	Uncertainty
Exposure Level Tester ELT-400	Narda Safety TEST Solutions/2304/03	M-0155	w2008022	Test freq range: 1—400kHz	Aug-03-10	Aug-02-11	Wwd20081191	Test uncertainty: 1—120kHz:±1.83%, 120 kHz-400 kHz: ±4.06%
Magnetic Field Probe 100cm ²	Narda Safety TEST Solutions/2300/90.10	M-1070	w2008021	Test freq range: 1—400kHz				Test uncertainty: 1Hz-10Hz: ±16.2%, 10Hz-120kHz:±2.2%, 120 kHz-400 kHz: ±4.7%
Active Loop Antenna Charger 10kHz-30 MHz	Beijing Dazhi / ZN30900A	-	-	10kHz-30MHz	Aug-03-10	Aug-02-11		±1dB

6 Conducted Emission Test

6.1 Conducted Emission Limit

Test Requirement:	FCC Part15.207 &Part 74
Test Method:	ANSI C63.4:2003
Test Result:	N/A
Frequency Range:	150kHz to 30MHz
Class:	Class B
Limit:	66-56 dB μ V between 0.15MHz & 0.5MHz 56 dB μ V between 0.5MHz & 5MHz 60 dB μ V between 5MHz & 30MHz
Detector:	Peak for pre-scan (9kHz Resolution Bandwidth) Quasi-Peak & Average if maximised peak within 6dB of Average Limit

6.2 Conducted Emission Data record

According to the rule of section 15.207(c), owing to the DC operation of EUT, this test is not performed.

7 Maximum Power Output

7.1 Rules and Limits

2.1046(a), ANSI/TIA/EIA-603-2003, Paragraph 2.2.1

74.861(e)(1): the power of the measured un-modulated carrier power at output of the transmitter power amplifier (antenna input power) may not exceed the following:

1. 54-72, 76-88 and 174-216 MHz bands--50mW
2. 470-608 and 614-806MHz bands--250mW

7.2 Test Equipment

Please refer to Section 5 this report.

7.3 Test Procedure

The maximum peak output power was measured with a spectrum analyzer connected to the antenna terminal (conducted measurement) while EUT was operating in normal situation. Set RBW of spectrum analyzer to 1MHz and VBW to 1MHz.

7.4 Test Setup BlockDiagram

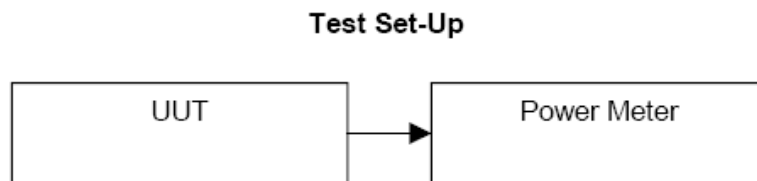

7.5 Measurement Result

Test Frequency (MHz)	Spectrum Reading (dBm)	E.R.P. (mW)	Limit (W)
618.5MHz	11.86	15.34617	0.25
625.3 MHz	12.12	16.29296	
633.5 MHz	12.53	17.90606	

8 Modulation Characteristics

8.1 Rules and Limits

2.1047(a), ANSI/TIA/EIA-603-1992, Paragraph 2.2.6.

Voice modulated communication equipment, the frequency response of the audio modulating circuit over a range of 100Hz to 5000Hz shall be measured. For equipment required to have an audio low-pass filter, the frequency response of the filter or of all circuitry installed between the modulation limiter and the modulated stage shall be measured.

2.1047(b), ANSI/TIA/EIA-603-1992, Paragraph 2.2.3

Equipment which employs modulation limiting

74.861(e)(3), ANSI/TIA/EIA-603-1992

Any form of modulation may be used. A maximum deviation of $\pm 75\text{KHz}$ is permitted when frequency modulation is employed.

8.2 Test Equipment

Please refer to Section 5 this report.

8.3 Frequency Response of Audio Modulation Circuit and Low Pass Filter Measurement

8.4 Condition & Setup

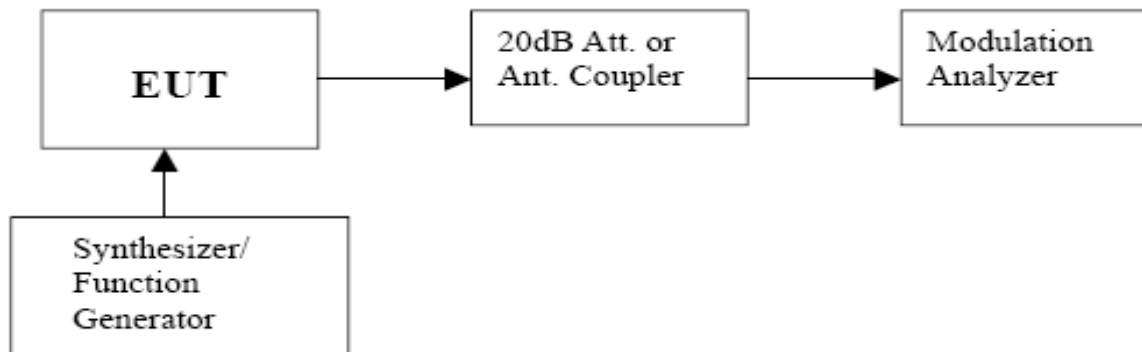

2.1047(a)

1. The EUT and test equipment were set up as shown on the above graph.
2. Adjust the audio input for 20% of rated system deviation at 1KHz using this level as a reference (0dB).
3. Vary the audio frequency from 100Hz to 15000Hz

8.5 Measurement Result

Test Frequency: 618.5MHz

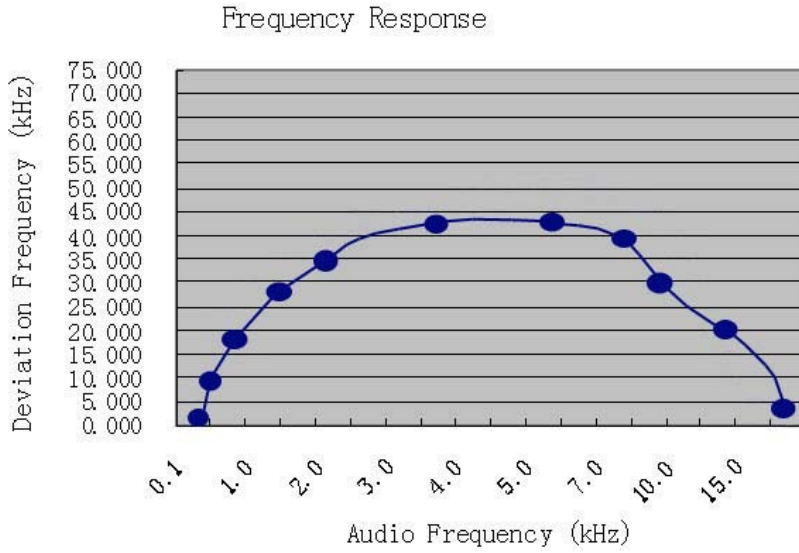

Test Frequency: 625.3MHz

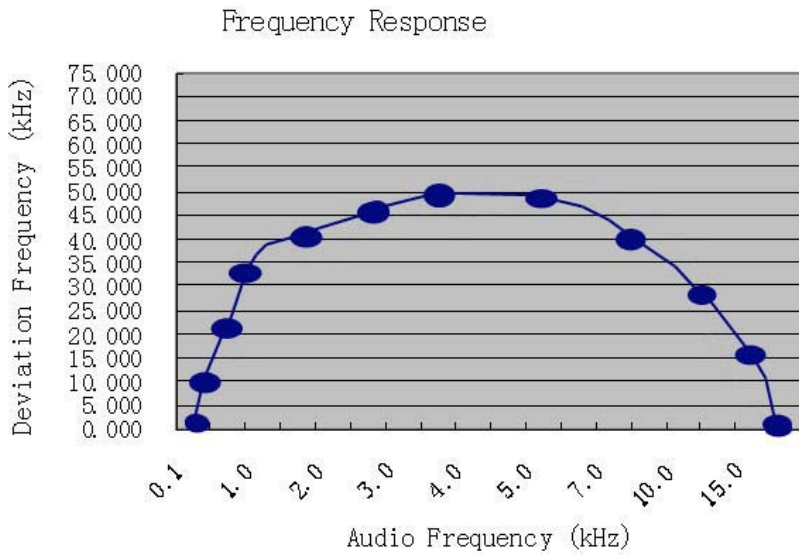

Test Frequency: 633.5MHz

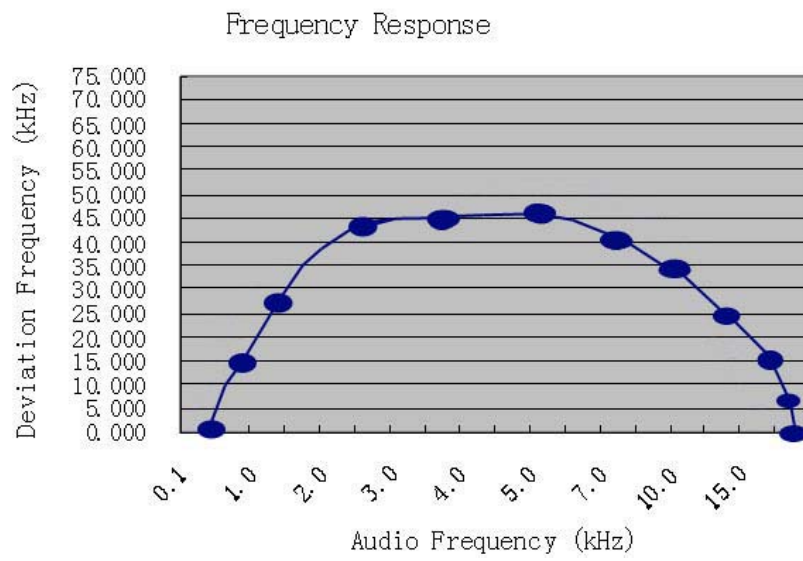

8.6 Modulation Limiting Measurement Condition & Setup

2.1047(b)

1. The Plus/Function generator was connected to the microphone of EUT, via an artificial mouth simulator.
2. Adjust the audio input frequency from 100Hz to 15000 Hz and the input level from 0V to maximum permitted input voltage with recording each carrier frequency deviation responding to respective input level.
3. Repeat step 2 with changing the input frequency for 100, 300, 1000, 10000 and 15000 Hz in sequence.

8.7 Measurement Result

Test Frequency: 618.5MHz

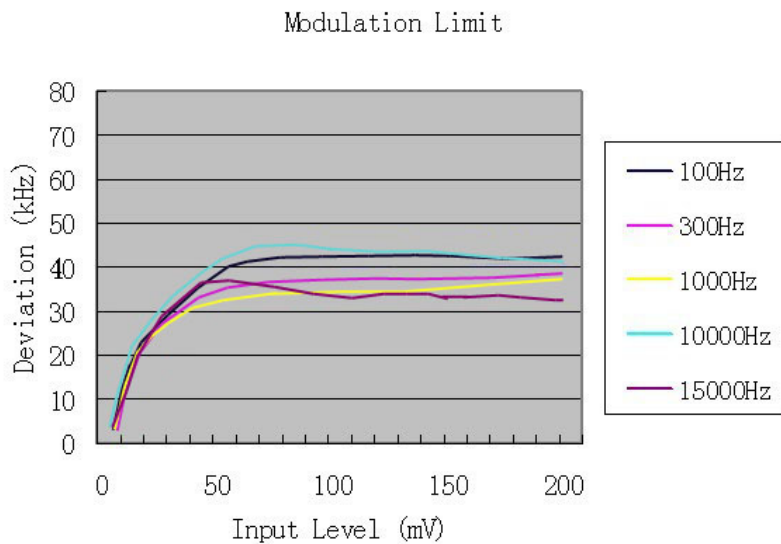

Test Frequency: 625.3MHz

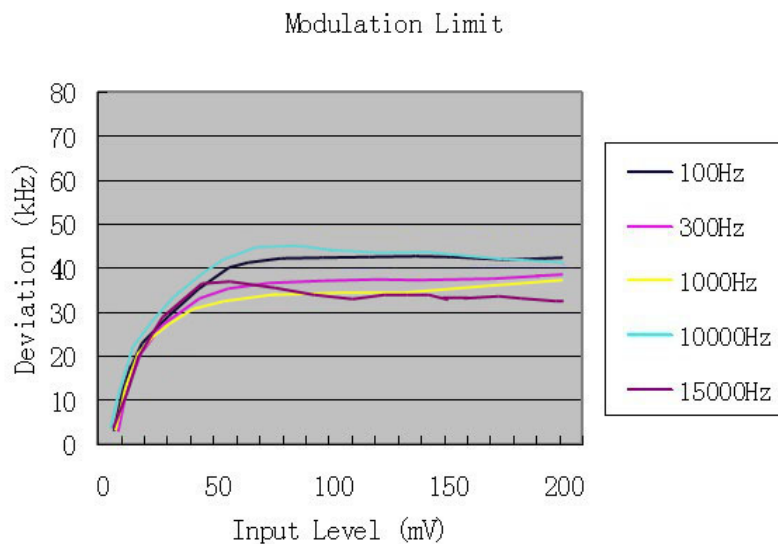

Test Frequency: 633.5MHz

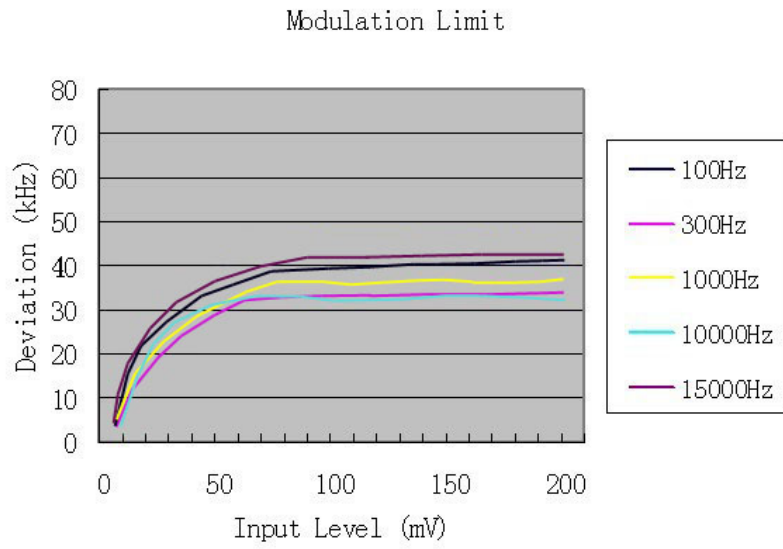

9 Occupied Bandwidth

9.1 Rules and Limits

2.1049(c)(1): ANSI/TIA/EIA-603-1992, Paragraph 2.2.11

74.861(e)(3): Any form of modulation may be used. A maximum deviation of $\pm 75\text{kHz}$ is permitted when frequency modulation is employed.

74.861(e)(5): The operation bandwidth shall not exceed 200kHz.

9.2 Test Equipment

Please refer to Section 5 this report.

9.3 Test Procedure

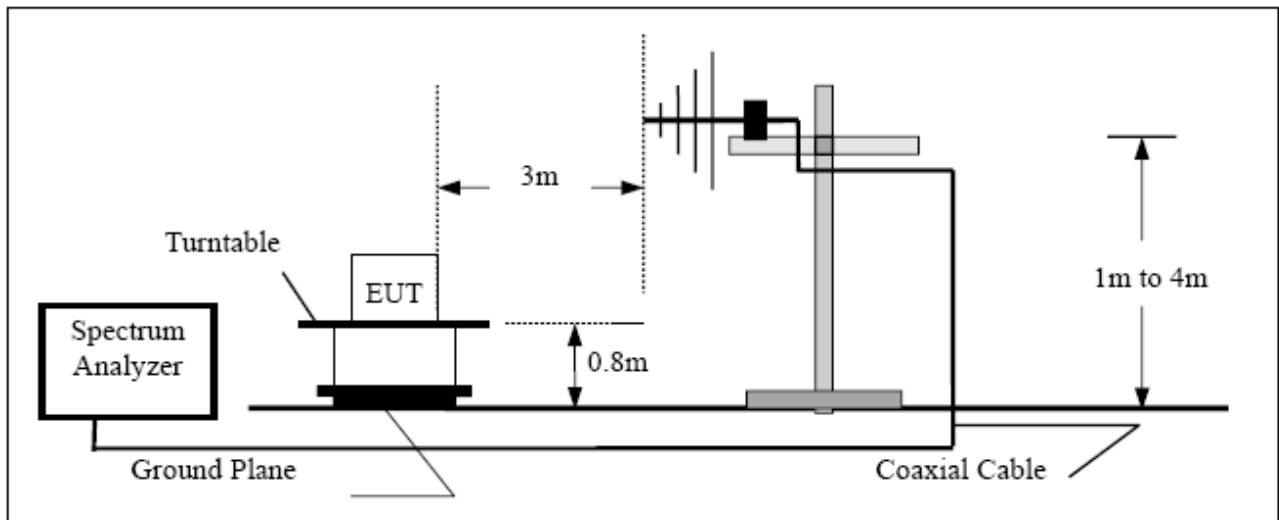

1. Connect the EUT as above graph.
2. Plot the unmodulated chart shows on spectrum.
3. Set the output of the signal generator to 300Hz,1kHz,1.5kHz,2.5kHz,15kHz. Increase the amplitude of the signal, while monitoring the modulation meter. Until modulation is maximum measure the bandwidth under 26dB compared to the unmodulated fundamental carrier peak level of the modulated signal displayed on the spectrum analyzer.

9.4 Emission Designator

$$B_n = 2M + 2DK = (2 \times 2.5\text{kHz}) + (2 \times 35.2\text{kHz}) = 75\text{K}4\text{F}3\text{E}$$

Please refer to the plots hereinafter.

9.5 Measurement Result

Unmodulation

Test Frequency: 618.5MHz

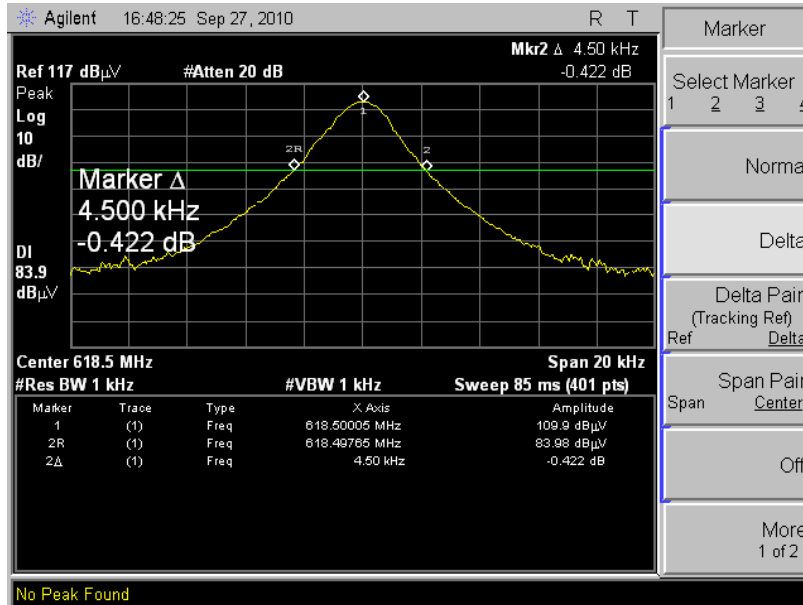

Test Frequency: 625.3MHz

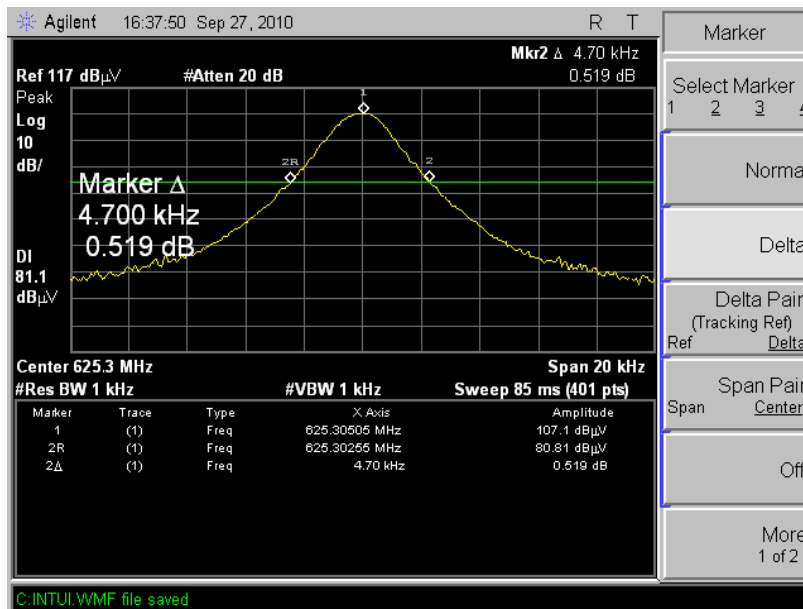

Test Frequency: 633.5MHz

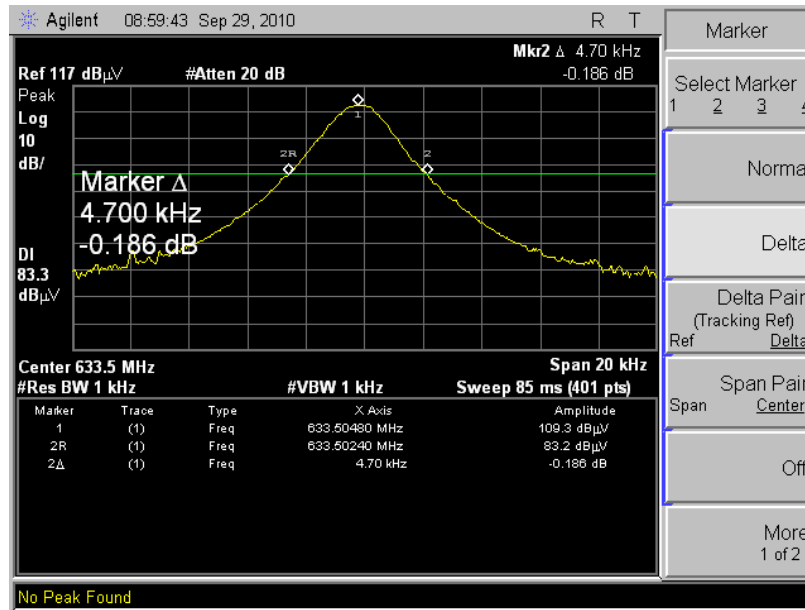

Test Frequency: 618.5MHz

Test signal:300Hz

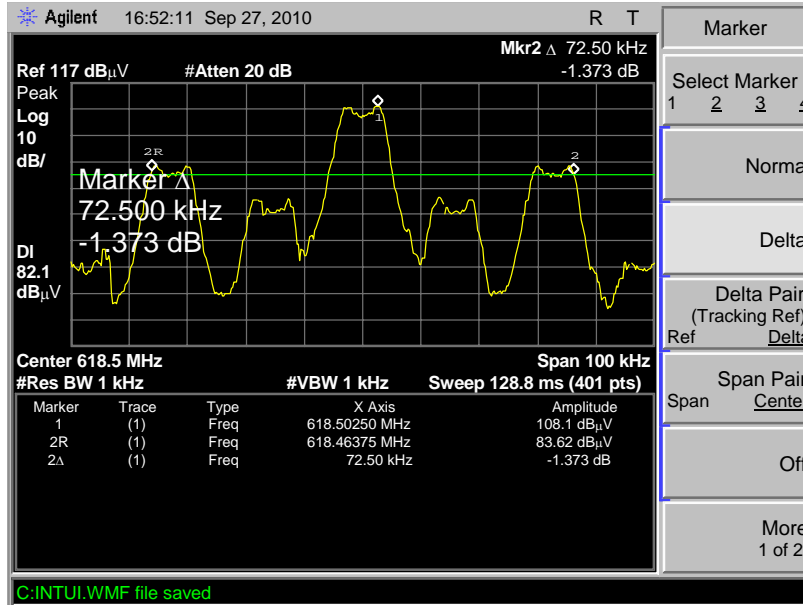

1kHz modulation

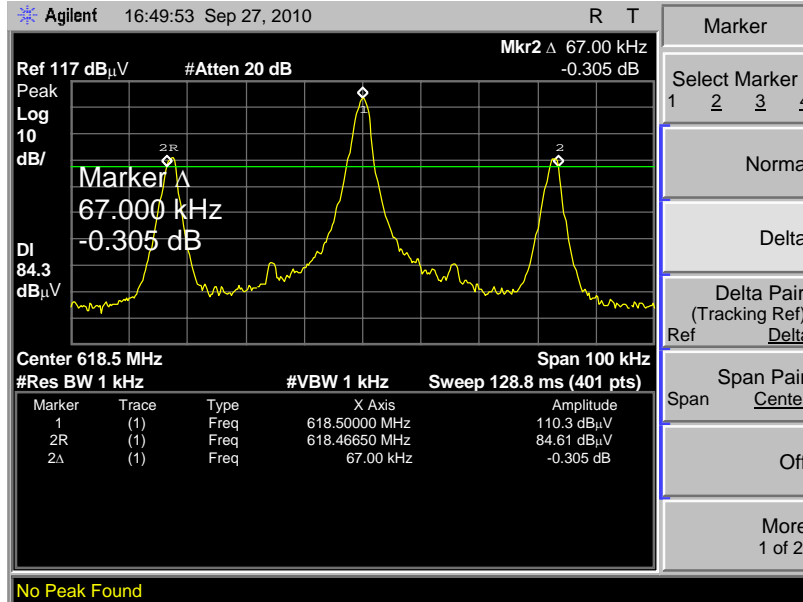

1.5kHz modulation

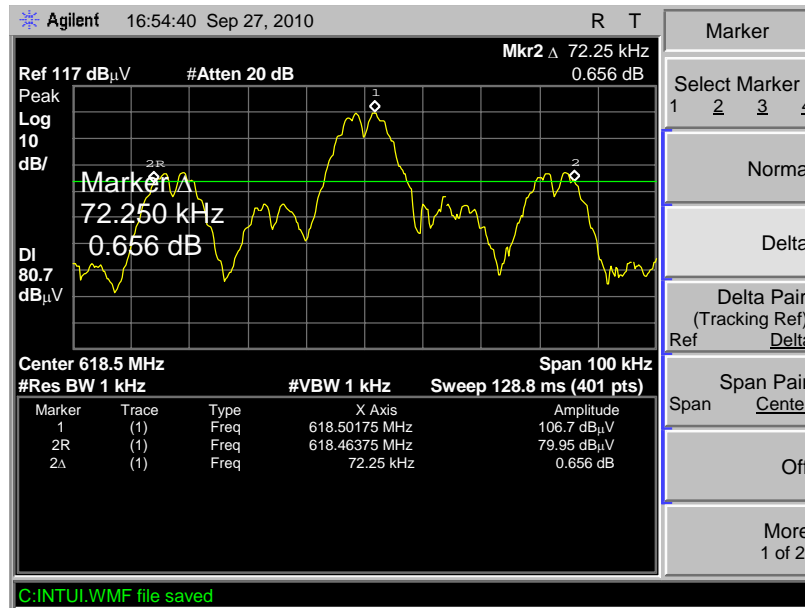

2.5kHz modulation

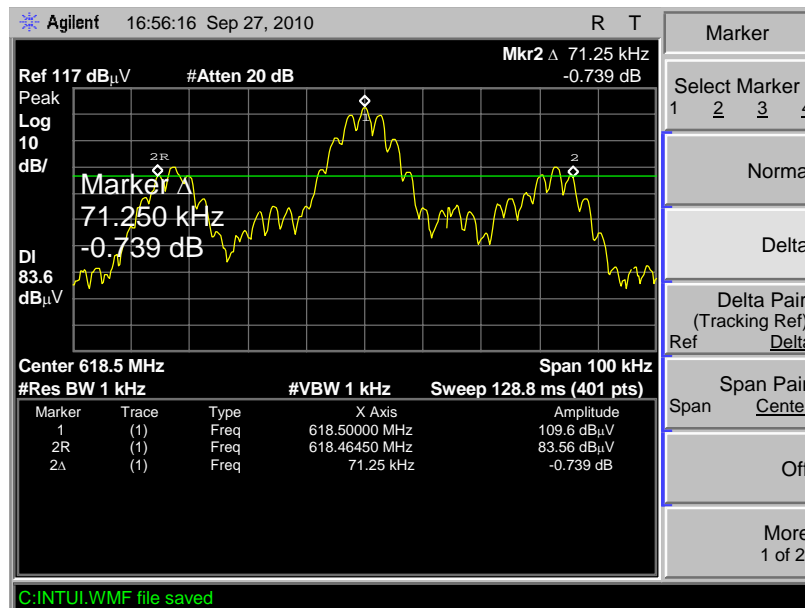

15kHz modulation

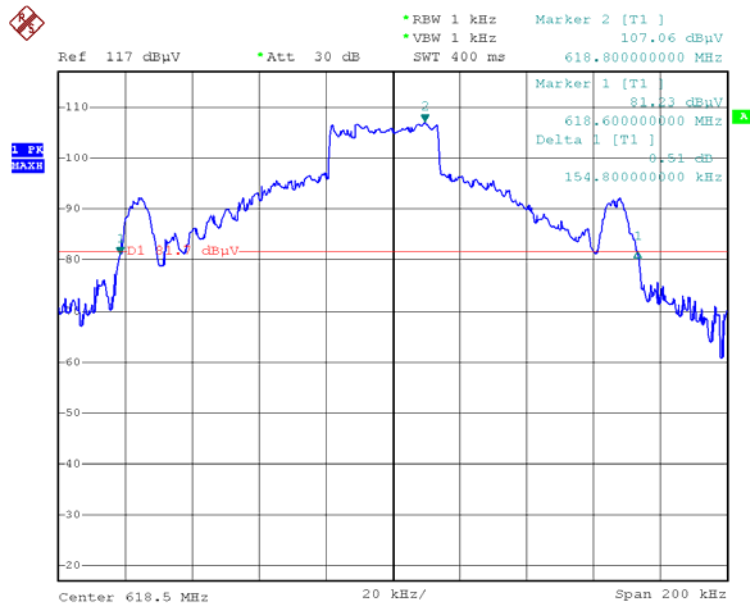

99% Occupied Bandwidth

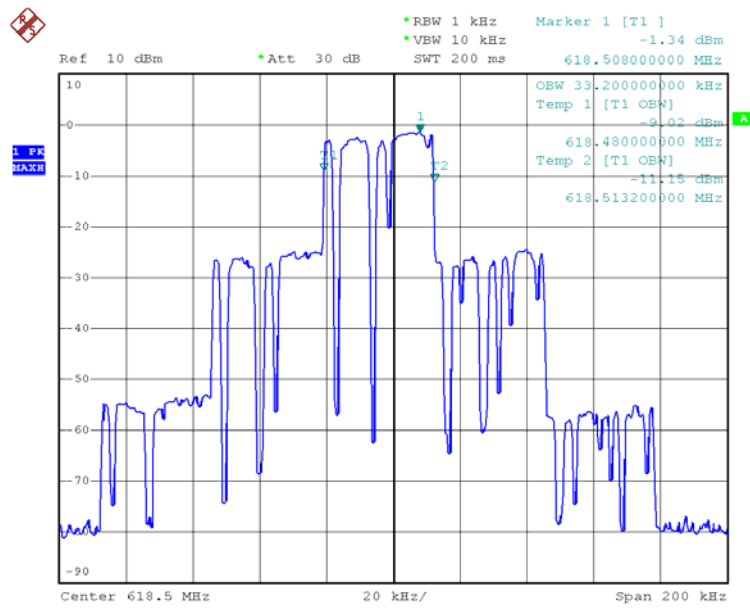

Test Frequency: 625.3MHz

300Hz

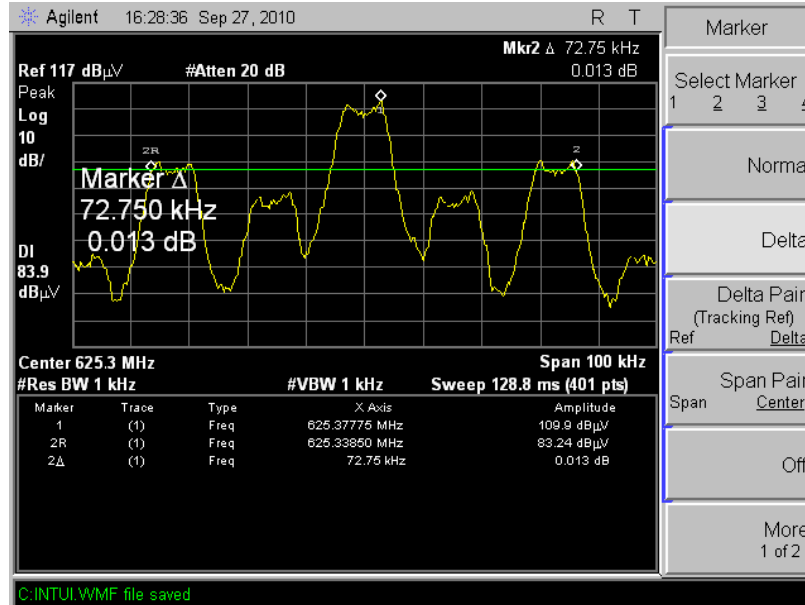

1kHz modulation

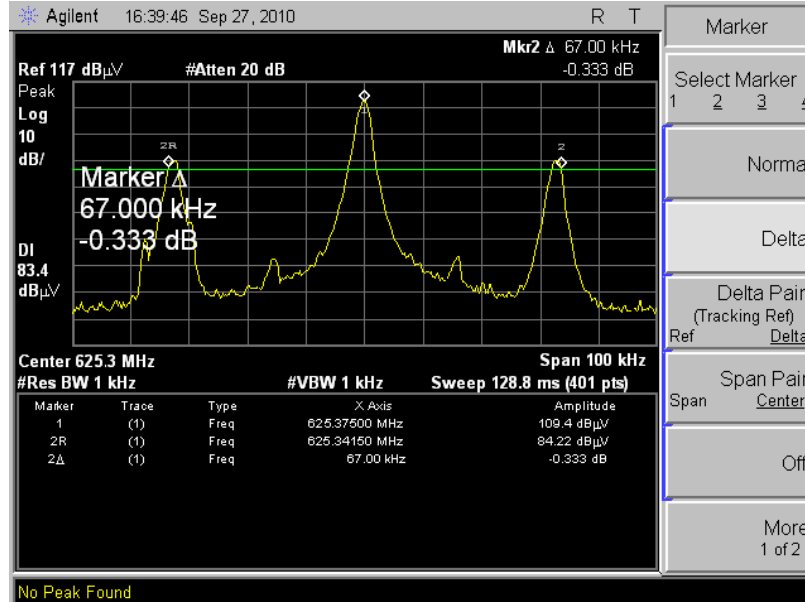

1.5kHz modulation

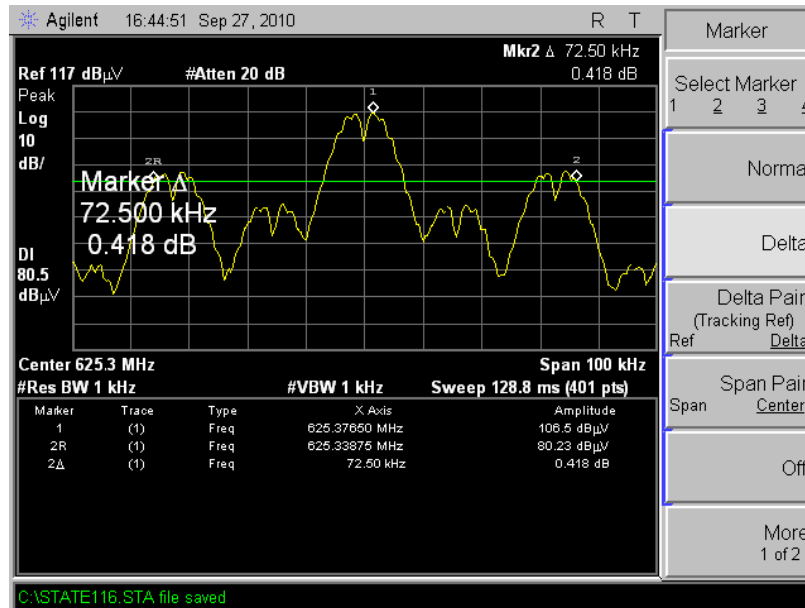

2.5kHz modulation



15kHz modulation



99% Occupied Bandwidth

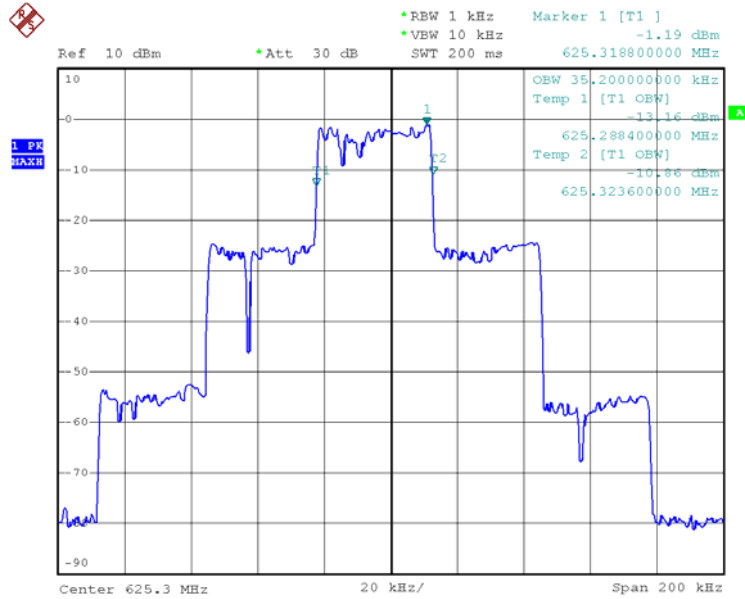

Test Frequency: 633.5MHz

300Hz

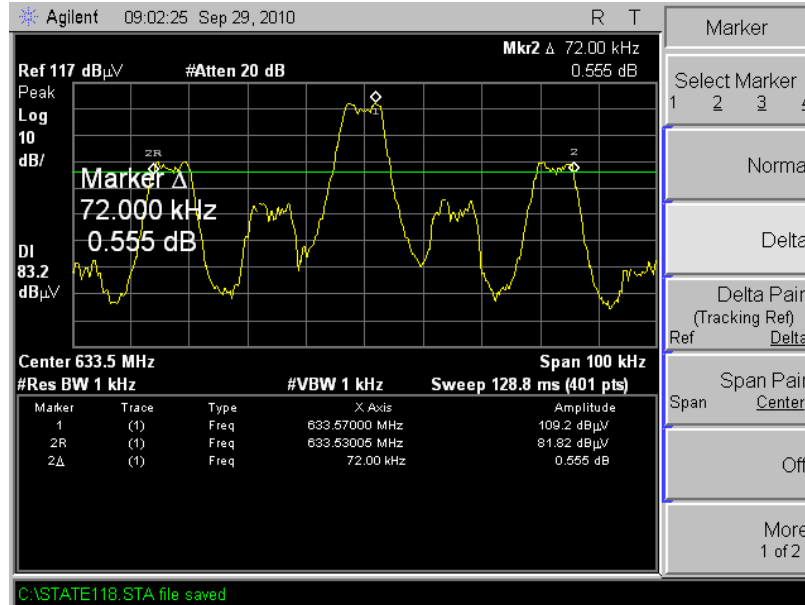

1kHz modulation

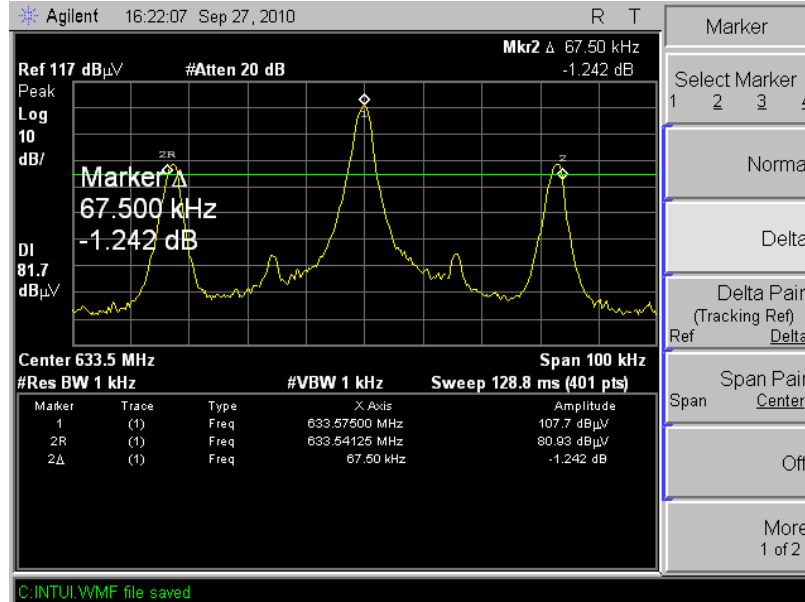

1.5kHz modulation

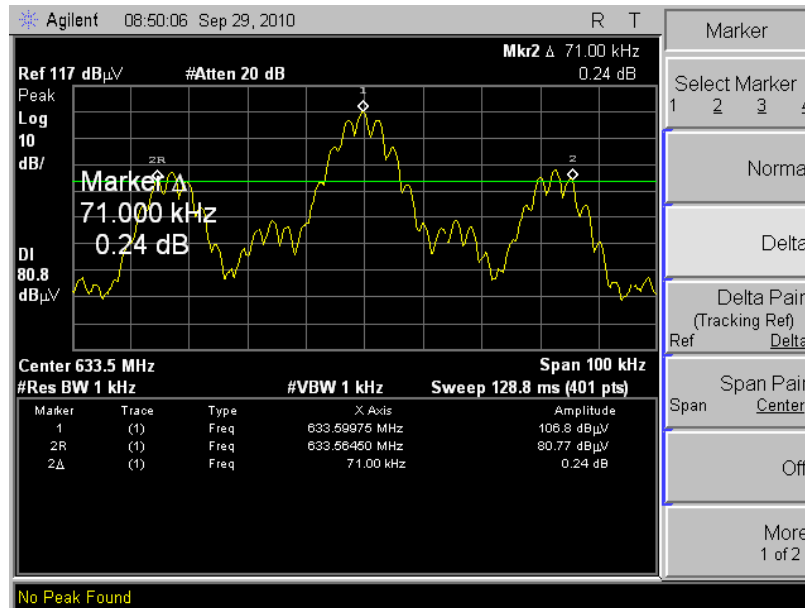

2.5kHz modulation

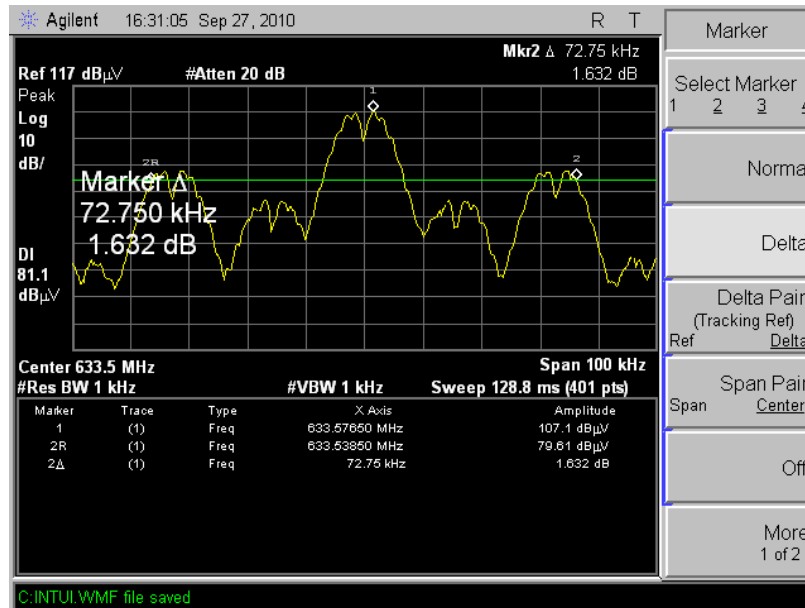

15kHz modulation

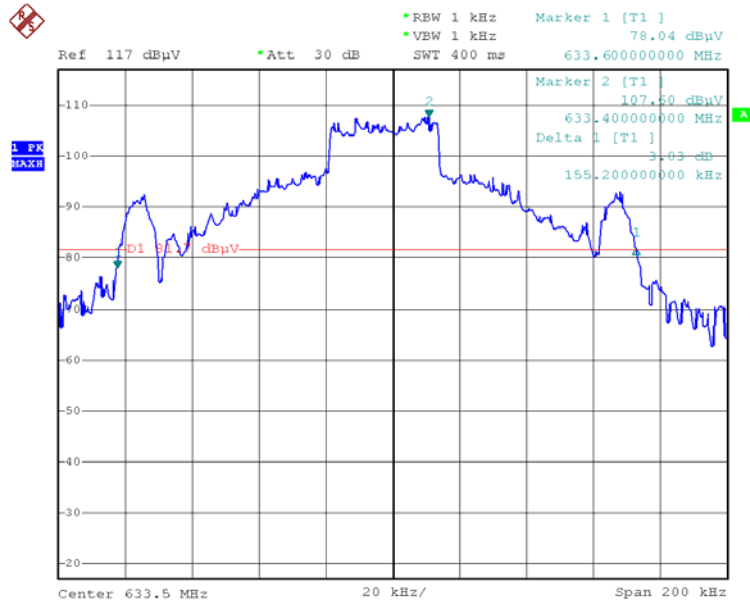

99% Occupied Bandwidth

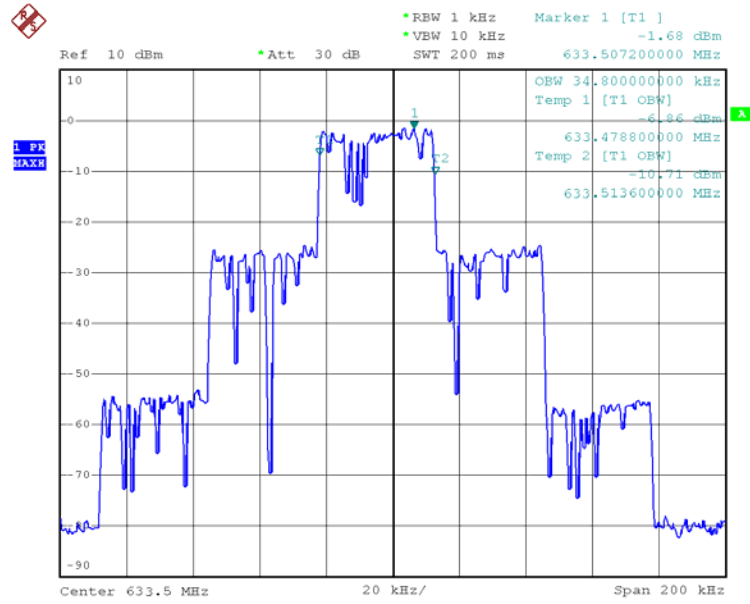

10 Antenna Conducted Emissions

10.1 Measurement Limit

Test Frequency(MHz)	Limit (dBm)
Above 1GHz	Less than -13dBm
Below 1GHz	Less than -13dBm

10.2 Measurement Procedure

The UUT was connected directly to a spectrum analyzer. The transmitter conducted spurious emissions were plotted and compared to the limits for both FCC 74.861.

10.3 Measurement Setup BlockDiagram

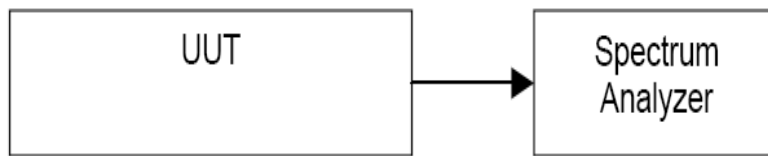

10.4 Measurement Result Record

Remark: the UUT was test from 30MHz to 10GHz,and above 3GHz,the signal of the UUT was lower than the equipment’s noise level, so the data show the 30MHz to 3GHz only.

Test Frequency 618.5MHz

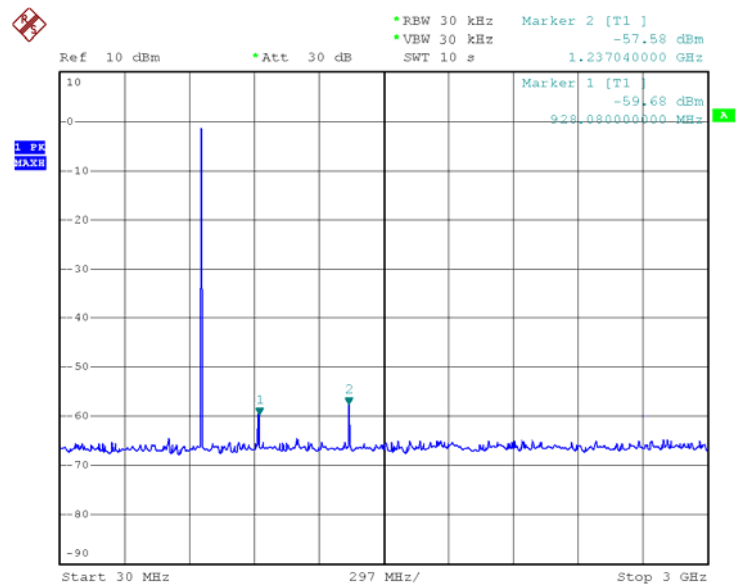

Test Frequency 625.3MHz

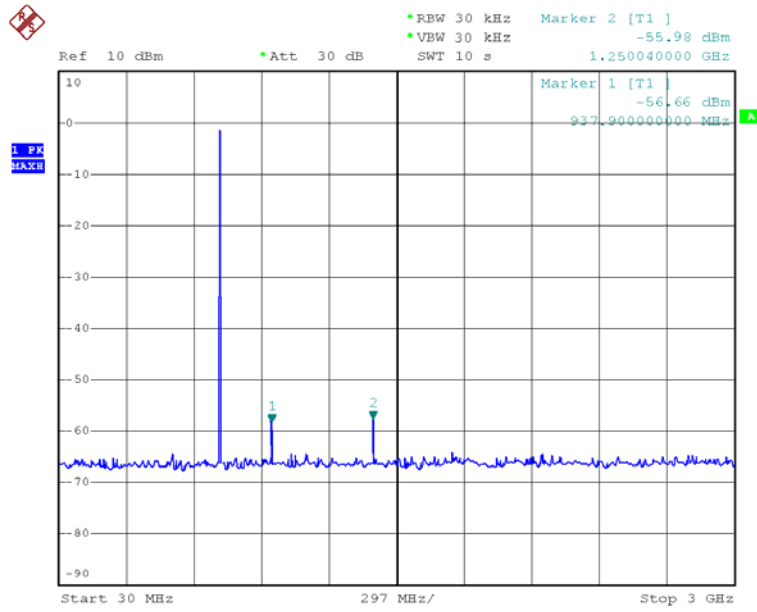

Test Frequency 633.5MHz

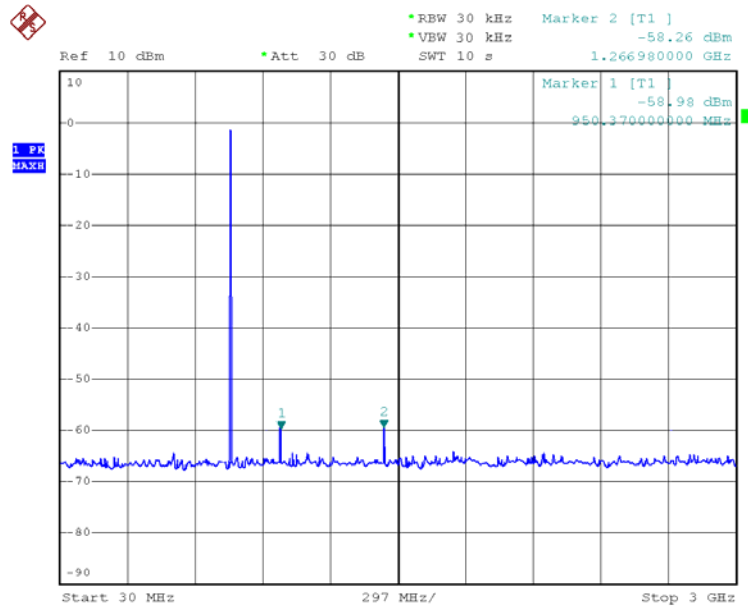

11 Emissions Mask

11.1 Measurement Procedure

- A) The EUT and test equipment were set up as shown below
- B) For EUTs supporting audio modulation, the audio signal generator was adjusted to the frequency of maximum response and with output level set for $\pm 2.5/\pm 1.25$ kHz deviation (or 50% modulation). With level constant, the signal level was increased 16 dB.
- C) For EUTs supporting digital modulation, the digital modulation mode was operated to its maximum extent.
- D) The Occupied Bandwidth was measured with the Spectrum Analyzer controls set as shown on the test results.
- E) The RB/VB=300Hz/300Hz,span to 100kHz,sweep time is 15s.

11.2 Measurement Result

Remark: The UUT was test the high/middle/low channel, and the worse case was the low channel of 618.5MHz,so the data show the 618.5MHz only.

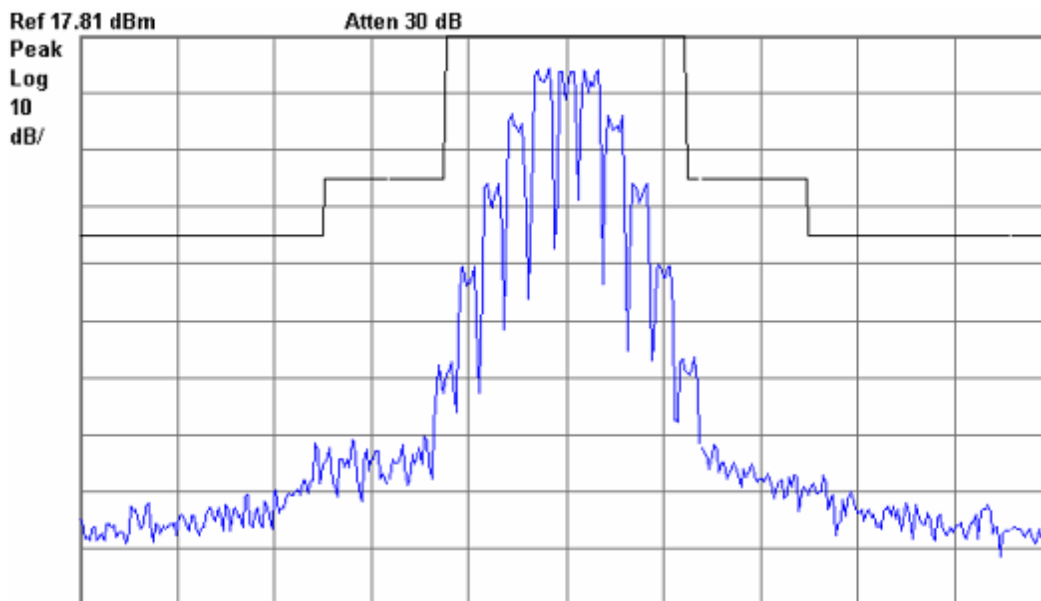

12 Audio Frequency Response

12.1 Measurement Procedure

- A) The EUT and test equipment were set up such that the audio input was connected at the input to the modulation limiter, and the modulated stage.
- B) The audio output was connected at the output to the modulated stage.

12.2 Measurement Setup BlockDiagram

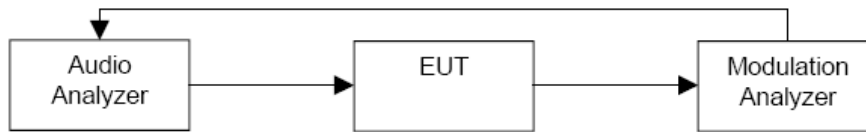

12.3 Measurement Result

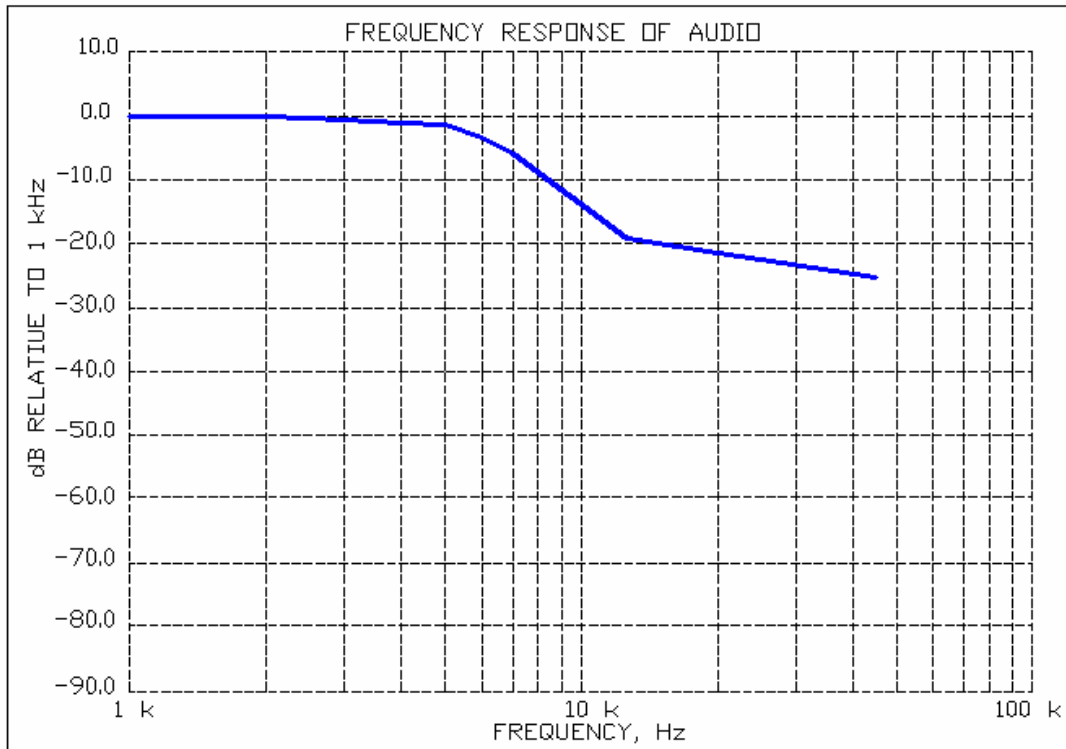

13 Audio Input versus Modulation

13.1 Measurement Procedure

- A) The signal generator was connected to the input of the EUT as shown below.
- B) The modulation response was measured for each of three frequencies (one of which was the frequency of maximum response), and the input voltage was varied and was observed on an HP 8901A Modulation Analyzer.
- C) The input level was varied from 30% modulation (± 1.5 kHz deviation) to at least 20 dB higher than the saturation point.
- D) Measurements were performed for both negative and positive modulation and the respective results were recorded.

13.2 Measurement Setup BlockDiagram

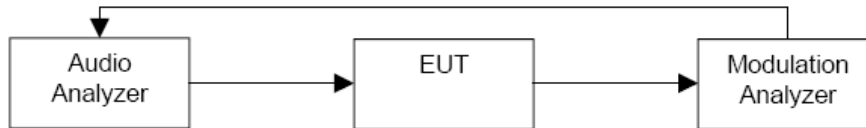

13.3 Measurement Result

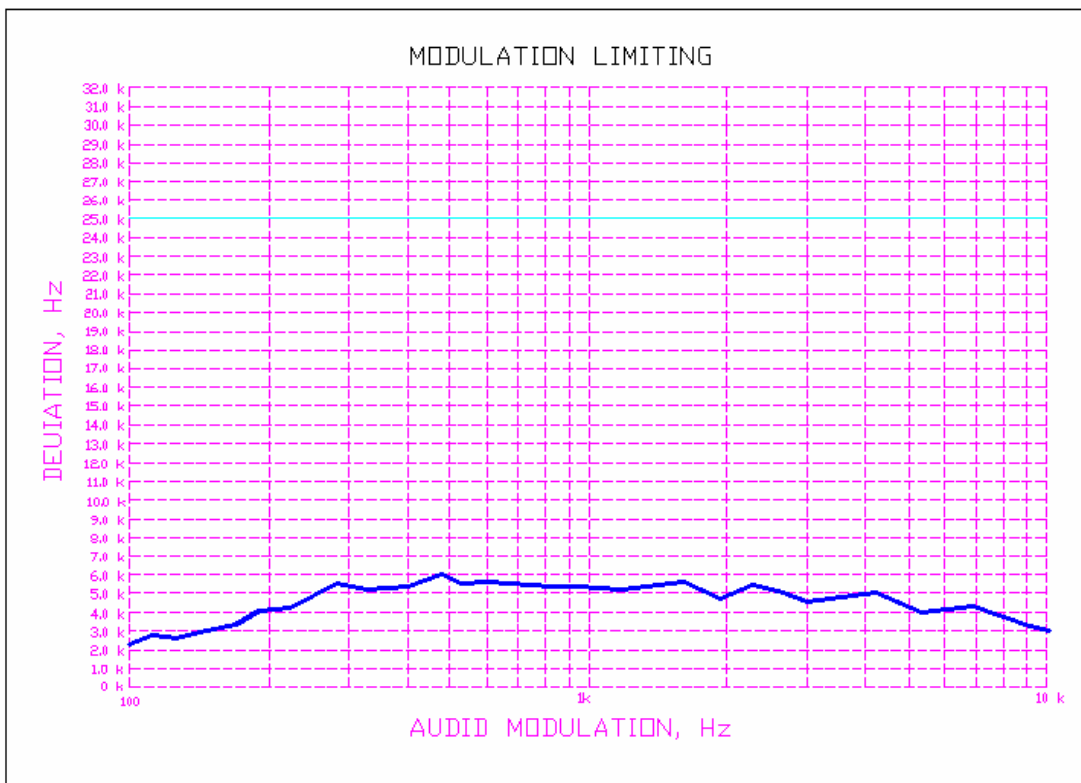

14 Field Strength of Spurious Radiation

14.1 Rules and Limits

2.1053(a): ANSI-603-1992, Paragraph 2.2.12

Measurement shall be made to detect spurious emissions that may be radiated directly from the cabinet, control circuit, power leads, or intermediate circuit elements under normal conditions of installation and operation.

74.861(e)(6)(iii): Spurious and harmonics must be at least $43 + 10\log(\text{output power})$ below the carrier peak

2.1057: in all measurements set forth, the spectrum should be investigated from the lowest radio frequency generated in the equipment up to at least the 10th harmonic of the carrier frequency

14.2 Test Equipment

Please refer to Section 5 this report.

14.3 Test Procedure

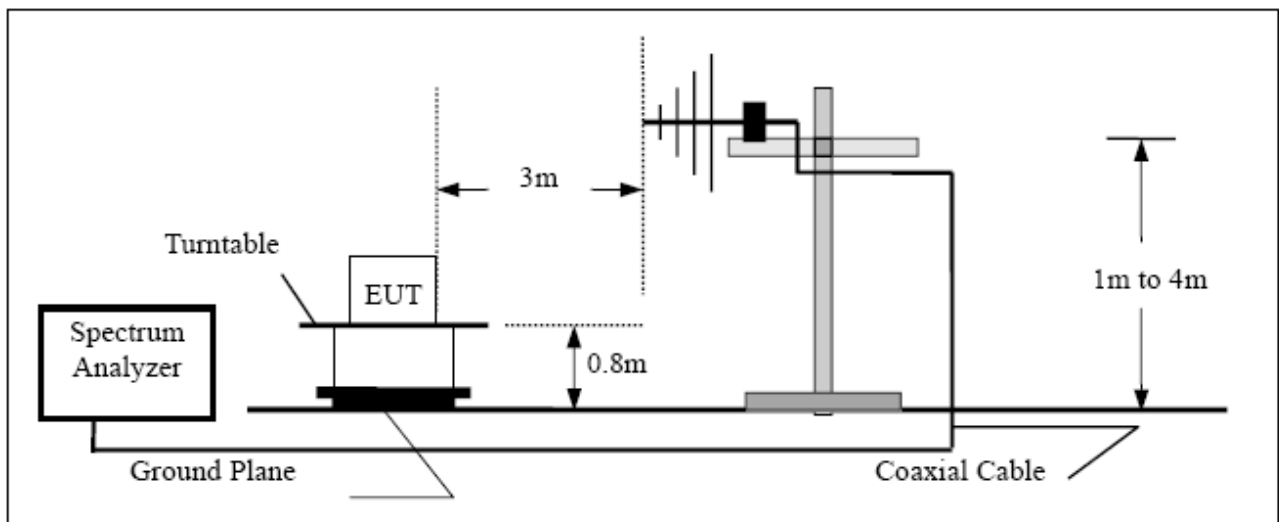

1. Connected the equipment as above graph.
2. Place the transmitter to be tested on the turntable in the standard test site. The transmitter is Transmitting into a non-radiating load, which is placed on the turntable. The RF cable to this load should be of minimum length.
4. The output of the antenna shall be connected to the measuring receiver and either a peak or quasi-peak detector was used for the measurement as indicated on the report. The detector selection is based on how close the emission level was approaching the limit.
5. The transmitter shall be switched on; if possible, without the modulation and the measurement receiver shall be tuned to the frequency of the transmitter under test.

6. The test antenna shall be raised and lowered through the specified range of height until the measuring receiver detects a maximum signal level.
7. New battery were installed in the equipment under test for radiated emissions test, the transmitter shall then be rotated through 360° in the horizontal plane, until the maximum signal level is detected by the measuring receiver.
8. The test antenna shall be raised and lowered again through the specified range of height until the measuring receiver detects a maximum signal level.
9. The maximum signal level detected by the measuring receiver shall be noted.
10. The measurement shall be repeated with the test antenna set to horizontal polarization.
11. Replace the antenna with a proper antenna (substitution antenna).
12. The substitution antenna shall be oriented for vertical polarization and, if necessary, the length of the substitution antenna shall be adjusted to correspond to the frequency of transmitting.
13. The substitution antenna shall be connected to a calibrated signal generator.
14. If necessary, the input attenuator setting of the measuring receiver shall be adjusted in order to increase the sensitivity of the measuring receiver.
15. The test antenna shall be raised and lowered through the specified range of the height to ensure that the maximum signal is received.
16. The input signal to substitution antenna shall be adjusted to the level that produces a level detected by the measuring receiver, that is equal to the level noted while the transmitter radiated power was measured, corrected for the change of input attenuation setting of the measuring receiver.
17. The input level to the substitution antenna shall be recorded as power level in dBm, corrected for any change of input attenuator setting of the measuring receiver.
18. The measurement shall be repeated with the test antenna and the substitution antenna oriented for horizontal polarization.
19. This is a handheld device, The radiation emission should be tested under 3-axes(X,Y,Z) position(X denotes lying on the table, Y denotes side stand and Z denotes vertical stand), After pre-test, It was found that the worse radiation emission was get at the X position. So the data shown was the X position only
20. The EUT was under working mode during the final qualification test and the configuration was used to represent the worst case results.

14.4 Measurement Result

Unmodulated carrier output power is 12.23dBm, or 167.1091mW(ERP). The limit of spurious or harmonics is calculated as following:

$$12.23-[43+10\log(\text{carrier output power in W})], \text{ or } -13\text{dBm}$$

Test Frequency: 618.5MHz

Horizontal

Frquency (MHz)	Reading Amplitude (dBm)	Limit (dBm)	Margin (dBm)
125.22	-37.25	-13	-23.75
609.48	-38.69	-13	-25.31
1236.98	-37.56	-13	-23.44
1855.54	-38.36	-13	-24.64
2474.15	-38.12	-13	-24.88

Vertical

Frquency (MHz)	Reading Amplitude (dBm)	Limit (dBm)	Margin (dBm)
165.23	-44.54	-13	-30.46
356.98	-45.68	-13	-31.32
1236.98	-46.74	-13	-32.26
1855.54	-46.12	-13	-32.88
2474.15	-45.87	-13	-32.13

Test Frequency: 625.3MHz

Horizontal

Frquency (MHz)	Reading Amplitude (dBm)	Limit (dBm)	Margin (dBm)
203.12	-48.62	-13	-34.38
365.25	-46.84	-13	-32.16
1250.65	-45.65	-13	-31.35
1875.96	-44.98	-13	-30.02
2501.26	-47.52	-13	-34.48

Vertical

Frquency (MHz)	Reading Amplitude (dBm)	Limit (dBm)	Margin (dBm)
165.54	-44.25	-13	-30.75
256.35	-44.25	-13	-30.75
1250.65	-45.47	-13	-31.53
1875.96	-44.78	-13	-31.22
2501.26	-46.98	-13	-32.02

Test Frequency: 633.5MHz

Horizontal

Frquency (MHz)	Reading Amplitude (dBm)	Limit (dBm)	Margin (dBm)
231.25	-44.25	-13	-30.75
562.36	-44.63	-13	-31.37
1267.21	-45.25	-13	-31.75
1900.36	-45.68	-13	-31.32
2534.15	-44.27	-13	-31.73

Vertical

Frquency (MHz)	Reading Amplitude (dBm)	Limit (dBm)	Margin (dBm)
165.36	-44.58	-13	-30.42
563.21	-44.80	-13	-30.20
1267.21	-45.25	-13	-31.72
1900.36	-45.87	-13	-31.13
2534.15	-48.52	-13	-34.48

15 Frequency Stability Tolerance

15.1 Rules and Limits

2.1055, ANSI/TIA/EIA-603-1992, Paragraph 2.2.2.

74.861(e)(4): the frequency tolerance of the transmitter shall be 0.005 percent

15.2 Test Equipment

Please refer to Section 5 this report.

15.3 Temperature Variation Test Procedure

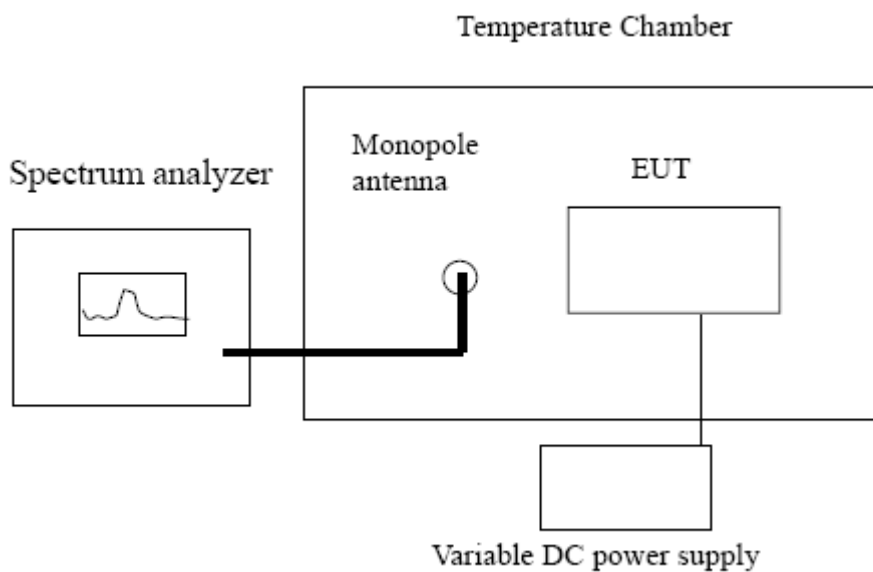

1. Place the EUT in the chamber, powered in its normal operation.
2. Set the temperature of the chamber -30 degree centigrade. Allow the equipment to stabilize at that temperature.
3. Measured the carrier frequency using preamplifier and frequency counter.
4. Repeated procedures 1 to 3 from -30 to 50 degree centigrade at internals of 10 degree.

15.4 Measurement Result

A plot and table is presented which illustrate compliance with the rule where the center frequency is 618.5MHz, 625.3MHz, 633.5MHz.

Test Frequency: 618.5MHz

Temperature Variation Table

Temperature(Centigrade)	Frequency (MHz)	Tolerance (MHz)
-30	618.48985	618.469075 to 618.530925
-20	618.49921	
-10	618.50974	
0	618.50823	
10	618.49821	
20	618.51823	
30	618.48841	
40	618.49258	
50	618.48991	

Test Frequency: 625.3MHz

Temperature Variation Table

Temperature(Centigrade)	Frequency(MHz)	Tolerance(MHz)
-30	625.31144	625.268735 to 625.331265
-20	625.19228	
-10	625.30232	
0	625.30216	
10	625.30224	
20	625.31023	
30	625.31184	
40	625.29224	
50	625.29251	

Test Frequency: 633.5MHz

Temperature Variation Table

Temperature(Centigrade)	Frequency(MHz)	Tolerance(MHz)
-30	633.51521	633.468325 to 633.531675
-20	633.48122	
-10	633.50147	
0	633.50123	
10	633.50120	
20	633.49115	
30	633.50125	
40	633.50147	
50	633.48559	

15.5 Voltage Variation Test Procedure

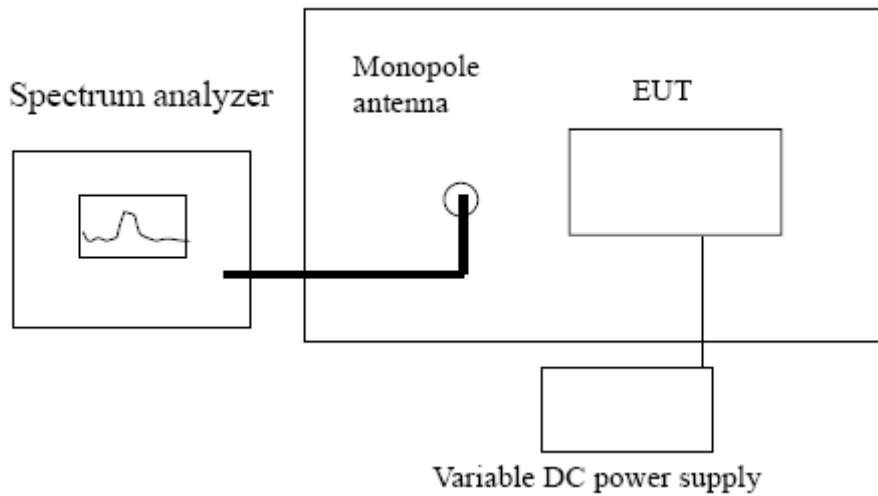

1. Attached the power line of the power supply to the battery position of the EUT.
2. Tuned the output power level to battery end point, 85%, 100%, 115% of the normal operation power of EUT.
3. Recorded the frequency with a frequency counter.

15.6 Measurement Result

Frequency Stability of Voltage Variation Measurement Table

Test Frequency: 618.5MHz

Supply Voltage (Volt)	Frequency (MHz)	Tolerance (MHz)
2.55(85%)	618.50121	618.469075 to 618.530925
3.0(100%)	618.50185	
3.45(115%)	618.49181	

Test Frequency: 625.3MHz

Supply Voltage (Volt)	Frequency (MHz)	Tolerance (MHz)
2.55(85%)	625.29858	625.268735 to 625.331265
3.0(100%)	625.30521	
3.45(115%)	625.30171	

Test Frequency: 633.5MHz

Supply Voltage (Volt)	Frequency (MHz)	Tolerance (MHz)
2.55(85%)	633.50145	633.468325
3.0(100%)	633.49194	to
3.45(115%)	633.50116	633.531675

16 Photographs of Testing

16.1 Radiation Emission Test View For 30MHz-1000MHz

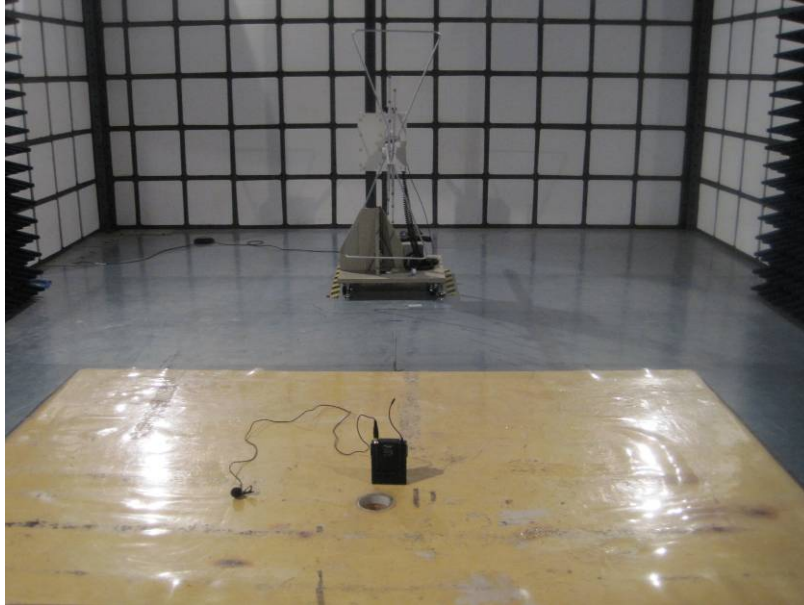

16.2 Radiation Emission Test View For 1GHz-10GHz

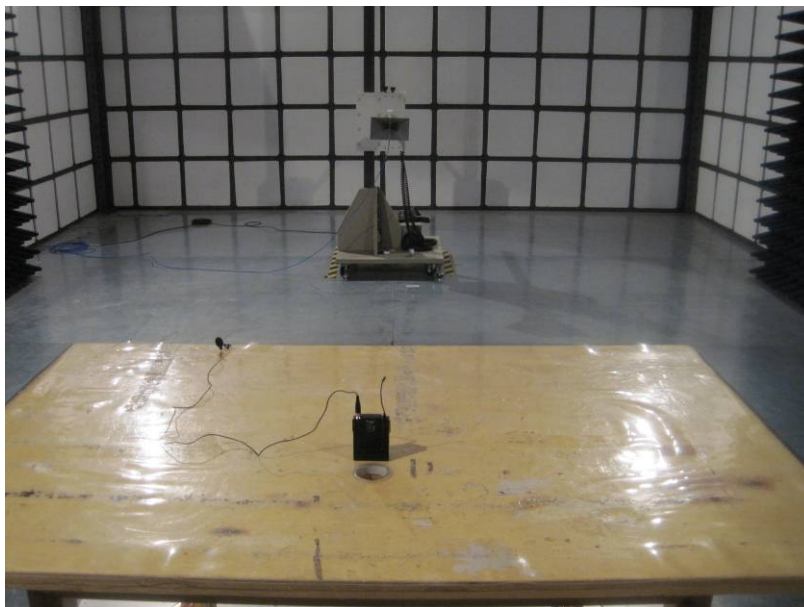

17 Photographs - Constructional Details

17.1 EUT - Front View



17.2 EUT - Back View



17.3 EUT-Open View



17.4 PCB 1- Front View

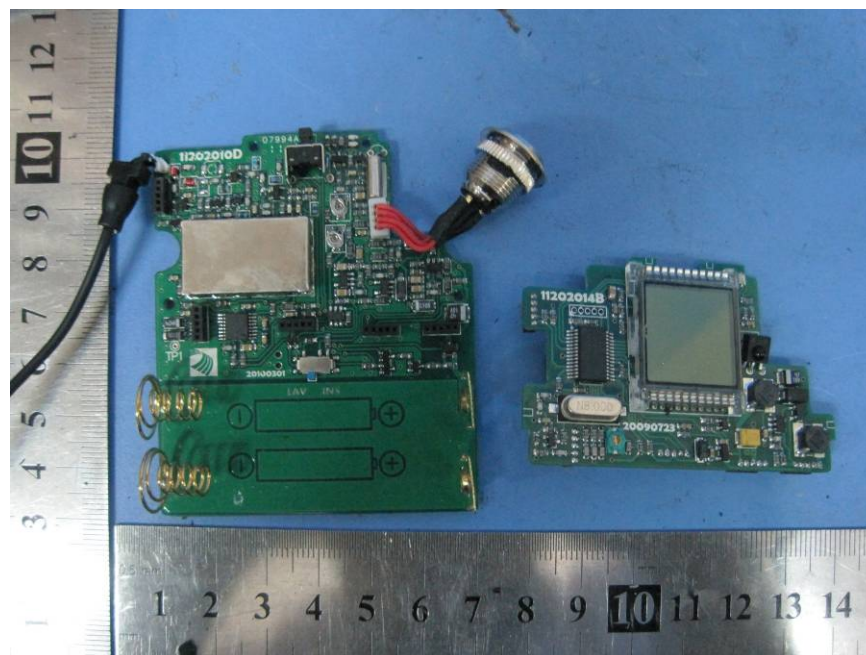

17.5 PCB2 - Back View

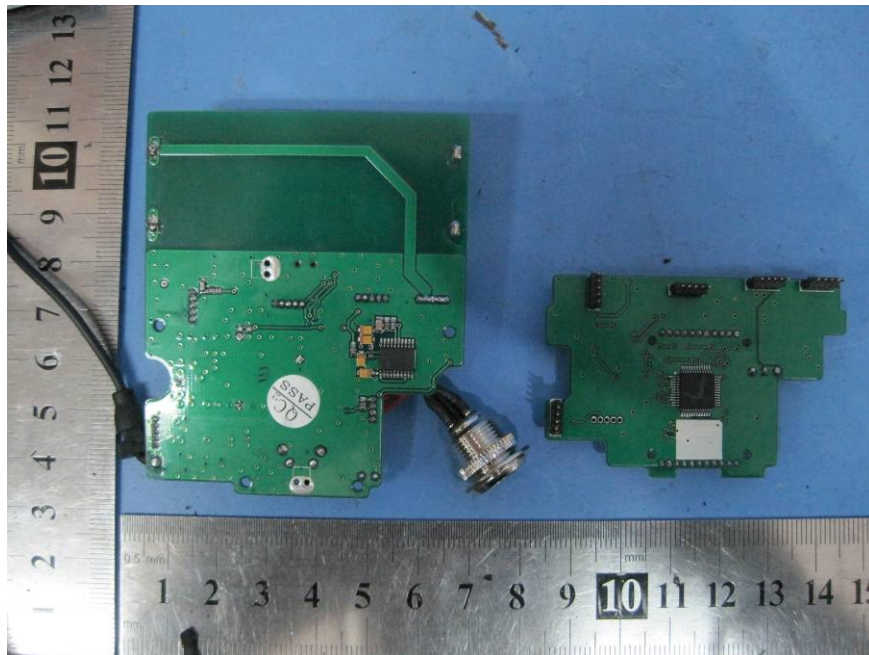

17.6 PCB 2- Front View

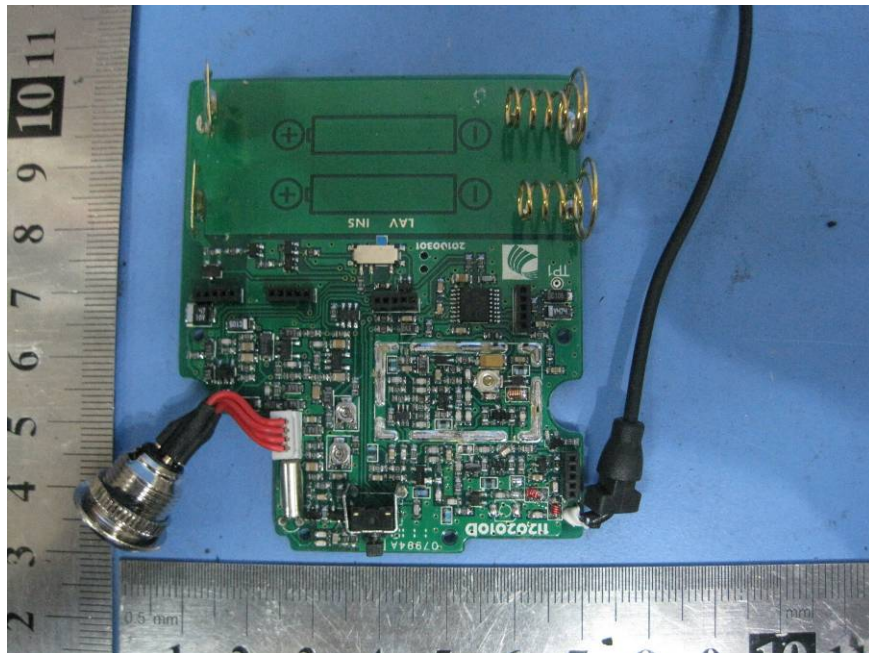

17.7 PCB 2- Front View

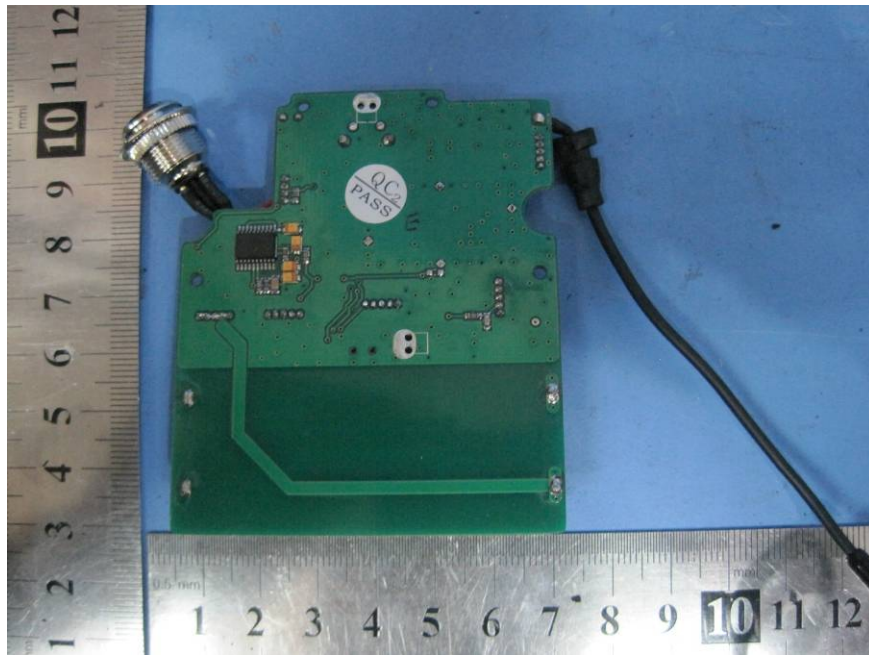

18 FCC ID Label

The Label must not be a stick-on paper. The Label on these products must be permanently affixed to the product and readily visible at the time of purchase and must last the expected lifetime of the equipment not be readily detachable.

Proposed Label Location on EUT
EUT Bottom View/proposed FCC Mark Location

