



M. Flom Associates, Inc.
International Compliance Testing Laboratory
3356 N. San Marcos Place, Suite 107
Chandler, AZ 85225
toll-free: (866) 311-3268
fax: (480) 926-3598
<http://www.mflom.com>
info@mflom.com

Date: March 4, 2005

Federal Communications Commission
Via: Electronic Filing

Attention: Authorization & Evaluation Division
Applicant: Telex Communications, Inc.
Equipment: Telex WT-10000 / Electro Voice CSB-1000
FCC ID: B5DB117
FCC Rules: 74H

Gentlemen:

On behalf of the Applicant, enclosed please find Application Form 731, Engineering Test Report and all pertinent documentation, the whole for approval of the referenced equipment as shown.

Filing fees are attached.

We trust the same is in order. Should you need any further information, kindly contact the writer who is authorized to act as agent.

Sincerely yours,

David E. Lee, Compliance Test Manager

enclosure(s)
cc: Applicant
DEL/del

M. Flom Associates, Inc.
3356 North San Marcos Place, Suite 107
Chandler, Arizona 85225-7176
(480) 926-3100 phone, (480) 926-3598 fax

FCC ID: B5DB117
MFA p0520006, d0530004



M. Flom Associates, Inc.
International Compliance Testing Laboratory
3356 N. San Marcos Place, Suite 107
Chandler, AZ 85225
toll-free: (866) 311-3268
fax: (480) 926-3598
<http://www.mflom.com>
info@mflom.com

Transmitter Certification

of

FCC ID: B5DB117
Model: Telex WT-1000
Electro Voice CSB-1000

to

Federal Communications Commission

Rule Part(s) 74H

Date of report: March 4, 2005

On the Behalf of the Applicant:

Telex Communications, Inc.

At the Request of:

P.O. 315993

Telex Communications, Inc.
8601 E. Cornhusker Highway
P.O. Box 5579
Lincoln, NE 68505-5579

Attention of:

Charles E. Conner, Project Engineer
(402) 467-5321; FAX: -3279
E-mail: charlie.conner@telex.com
Jim Andersen
Email: jim.andersen@telex.com

Supervised by:

David E. Lee, Compliance Test Manager



List of Exhibits

(FCC **Certification** (Transmitters) - Revised 9/28/98)

Applicant: Telex Communications, Inc.

FCC ID: B5DB117

By Applicant:

1. Letter of Authorization
2. Confidentiality Request: 0.457 And 0.459
3. Identification Drawings, 2.1033(c)(11)
 - Label
 - Location of Label
 - Compliance Statement
 - Location of Compliance Statement
4. Photographs, 2.1033(c)(12)
5. Documentation: 2.1033(c)
 - (3) User Manual
 - (9) Tune Up Info
 - (10) Schematic Diagram
 - (10) Circuit Description
 - Block Diagram
 - Parts List
 - Active Devices
6. MPE Report

By M.F.A. Inc.:

- A. Testimonial & Statement of Certification

The Applicant has been cautioned as to the following:

15.21 **Information to the User .**

The users manual or instruction manual for an intentional radiator shall caution the user that changes or modifications not expressly approved by the party responsible for compliance could void the user's authority to operate the equipment.

15.27(a) **Special Accessories .**

Equipment marketed to a consumer must be capable of complying with the necessary regulations in the configuration in which the equipment is marketed. Where special accessories, such as shielded cables and/or special connectors are required to enable an unintentional or intentional radiator to comply with the emission limits in this part, the equipment must be marketed with, i.e. shipped and sold with, those special accessories. However, in lieu of shipping or packaging the special accessories with the unintentional or intentional radiator, the responsible party may employ other methods of ensuring that the special accessories are provided to the consumer, without additional charge.

Information detailing any alternative method used to supply the special accessories for a grant of equipment authorization or retained in the verification records, as appropriate. The party responsible for the equipment, as detailed in § 2.909 of this chapter, shall ensure that these special accessories are provided with the equipment. The instruction manual for such devices shall include appropriate instructions on the first page of text concerned with the installation of the device that these special accessories must be used with the device. It is the responsibility of the user to use the needed special accessories supplied with the equipment.

Table of Contents

<u>Rule</u>	<u>Description</u>	<u>Page</u>
2.1033(c)(14)	Rule Summary	2
	Standard Test Conditions and Engineering Practices	3
2.1033(c)	General Information Required	5
2.1046(a)	Carrier Output Power (Conducted)	7
2.1046(a)	RF Power Output (Radiated)	9
2.1053(a)	Field Strength of Spurious Radiation	10
2.1049(c)(1)	Emission Masks (Occupied Bandwidth)	14
2.1047(a)	Audio Frequency Response	25
2.1047(b)	Modulation Limiting	27
2.1055(a)(1)	Frequency Stability (Temperature Variation)	29
2.1055(b)(1)	Frequency Stability (Voltage Variation)	31
2.202(g)	Necessary Bandwidth and Emission Bandwidth	33

Required information per ISO/IEC Guide 25-1990, paragraph 13.2:

a) **Test Report**

b) Laboratory: M. Flom Associates, Inc.
(FCC: 31040/SIT) 3356 N. San Marcos Place, Suite 107
(Canada: IC 2044) Chandler, AZ 85225

c) Report Number: d0530004

d) Client: Telex Communications, Inc.
8601 E. Cornhusker Highway
P.O. Box 5579
Lincoln, NE 68505-5579

e) Identification: Telex WT-1000
Electro Voice CSB-1000
FCC ID: B5DB117
EUT Description: UHF Auxiliary Transmitter

f) EUT Condition: Not required unless specified in individual tests.

g) Report Date: March 4, 2005
EUT Received: February 14, 2005

h, j, k): As indicated in individual tests.

i) Sampling method: No sampling procedure used.

l) Uncertainty: In accordance with MFA internal quality manual.

m) Supervised by:



David E. Lee, Compliance Test Manager

n) Results: The results presented in this report relate only to the item tested.

o) Reproduction: This report must not be reproduced, except in full, without written permission from this laboratory.

Sub-part

2.1033(c)(14):

Test and Measurement Data

All tests and measurement data shown were performed in accordance with FCC Rules and Regulations, Volume II; Part 2, Sub-part J, Sections 2.947, 2.1033(c), 2.1041, 2.1046, 2.1047, 2.1079, 2.1051, 2.1053, 2.1055, 2.1057 and the following individual Parts:

- 21 - Domestic Public Fixed Radio Services
- 22 - Public Mobile Services
- 22 Subpart H - Cellular Radiotelephone Service
- 22.901(d) - Alternative technologies and auxiliary services
- 23 - International Fixed Public Radiocommunication services
- 24 - Personal Communications Services
- 74 Subpart H - Low Power Auxiliary Stations
- 80 - Stations in the Maritime Services
- 80 Subpart E - General Technical Standards
- 80 Subpart F - Equipment Authorization for Compulsory Ships
- 80 Subpart K - Private Coast Stations and Marine Utility Stations
- 80 Subpart S - Compulsory Radiotelephone Installations for Small Passenger Boats
- 80 Subpart T - Radiotelephone Installation Required for Vessels on the Great Lakes
- 80 Subpart U - Radiotelephone Installations Required by the Bridge-to-Bridge Act
- 80 Subpart V - Emergency Position Indicating Radio Beacons (EPIRB'S)
- 80 Subpart W - Global Maritime Distress and Safety System (GMDSS)
- 80 Subpart X - Voluntary Radio Installations
- 87 - Aviation Services
- 90 - Private Land Mobile Radio Services
- 94 - Private Operational-Fixed Microwave Service
- 95 Subpart A - General Mobile Radio Service (GMRS)
- 95 Subpart C - Radio Control (R/C) Radio Service
- 95 Subpart D - Citizens Band (CB) Radio Service
- 95 Subpart E - Family Radio Service
- 95 Subpart F - Interactive Video and Data Service (IVDS)
- 97 - Amateur Radio Service
- 101 - Fixed Microwave Services

Standard Test Conditions and Engineering Practices

Except as noted herein, the following conditions and procedures were observed during the testing:

In accordance with ANSI C63.4-1992/2001, section 6.1.9, and unless otherwise indicated in the specific measurement results, the ambient temperature of the actual EUT was maintained within the range of 10° to 40°C (50° to 104 °F) unless the particular equipment requirements specify testing over a different temperature range. Also, unless otherwise indicated, the humidity levels were in the range of 10% to 90% relative humidity.

Prior to testing, the EUT was tuned up in accordance with the manufacturer's alignment procedures. All external gain controls were maintained at the position of maximum and/or optimum gain throughout the testing.

Measurement results, unless otherwise noted, are worst-case measurements.



A2LA

"A2LA has accredited M. Flom Associates, Inc. Chandler, AZ for technical competence in the field of Electrical Testing. The accreditation covers the specific tests and types of tests listed on the agreed scope of accreditation. This laboratory meets the requirements of ISO/IEC 17025 – 1999 'General Requirements for the Competence of Testing and Calibration Laboratories' and any additional program requirements in the identified field of testing."

Certificate Number: **2152-01**



UNITED STATES DEPARTMENT OF COMMERCE
National Institute of Standards and Technology
Gaithersburg, Maryland 20899

September 15, 1999

Mr. Morton Flom
M. Flom Associates Inc.
3356 N. San Marcos Place, Suite 107
Chandler, AZ 85224

Dear Mr. Flom:

I am pleased to inform you that your laboratory has been validated by the Chinese Taipei Bureau of Standards, Metrology, and Inspection (BSMI) under the Asia Pacific Economic Cooperation Mutual Recognition Arrangement (APEC MRA). Your laboratory is now formally designated to act as a Conformity Assessment Body (CAB) under Appendix B, Phase I Procedures, of the APEC MRA between the American Institute in Taiwan (AIT) and the Taipei Economic and Cultural Representative Office (TECRO) in the United States, covering equipment subject to Electro-Magnetic Compatibility (EMC) requirements. The names of all validated and nominated laboratories will be posted on the NIST website at <http://ts.nist.gov/mra> under the "Asia" category.

As of August 1, 1999, you may submit test data to BSMI to verify that the equipment to be imported into Chinese Taipei satisfies the applicable EMC requirements. Your assigned BSMI number is SL2-IN-E-041R; you must use this number when sending test reports to BSMI. Your designation will remain in force as long as your NVLAP and/or AZLA and/or BSMI accreditation remains valid for the CNS 13418.

Please note that BSMI requires that the entity making application for the approval of regulated equipment must make such application in person at their Taipei office. BSMI also requires the names of the authorized signatories who are authorized to sign the test reports. You can send this information via fax to C-Taipei CAB Response Manager at 301-975-5414. I am also enclosing a copy of the cover sheet that, according to BSMI requirements, must accompany every test report.

NIST

If you have any questions, please contact Robert Gladhill at 301-975-4273 or Joe Dhillon at 301-975-5521. We appreciate your continued interest in our international conformity assessment activities.

Sincerely,

Helinda L. Collins
Helinda L. Collins, Ph.D.
Director, Office of Standards Services

Enclosure

NIST

I am pleased to inform you that your laboratory has been validated by the Chinese Taipei Bureau of Standards, Metrology and Inspection (BSMI) under the Asia Pacific Economic Cooperation Mutual Recognition Agreement (APEC MRA). Your laboratory is now formally designated to act as a Conformity Assessment Body (CAB) under Appendix B, Phase I Procedures, of the APEC MRA between the American Institute in Taiwan (AIT) and the Taipei Economic and Cultural Representative Office (TECRO) in the United States, covering equipment subject to Electro-Magnetic Compatibility (EMC) requirements. The names of all validated and nominated laboratories will be posted on the NIST website at <http://ts.nist.gov/mra> under the 'Asia' category."

BSMI Number: **SL2-IN-E-041R**

List of General Information Required for Certification

In Accordance with FCC Rules and Regulations,
Volume II, Part 2 and to

74H

Sub-part 2.1033

(c)(1): **Name and Address of Applicant:**

Telex Communications, Inc.
8601 E. Cornhusker Highway
P.O. Box 5579
Lincoln, NE 68505-5579

Manufacturer:

Telex Communications, Inc.

(c)(2): **FCC ID:**

B5DB117

Model Number:

Telex WT-1000
Electro Voice CSB-1000

(c)(3): **Instruction Manual(s):**

Please see attached exhibits

(c)(4): **Type of Emission:**

91K0F3E

(c)(5): **Frequency Range, MHz:**

776 - 800

(c)(6): **Power Rating, Watts: (Conducted)**

 X Switchable Variable

0.050 and 0.005
 N/A

(c)(7): **Maximum Power Rating, Watts:**

0.250

DUT Results:

Passes X Fails

Subpart 2.1033 (continued)

(c)(8): Voltages & currents in all elements in final RF stage, including final transistor or solid-state device:

Collector Current, A	=	per manual
Collector Voltage, Vdc	=	per manual
Supply Voltage, Vdc	=	9.0

(c)(9): **Tune-Up Procedure:**

Please see attached exhibits

(c)(10): **Circuit Diagram/Circuit Description:**

Including description of circuitry & devices provided for determining and stabilizing frequency, for suppression of spurious radiation, for limiting modulation and limiting power.

Please see attached exhibits

(c)(11): **Label Information:**

Please see attached exhibits

(c)(12): **Photographs:**

Please see attached exhibits

(c)(13): **Digital Modulation Description:**

 Attached Exhibits
 x N/A

(c)(14): **Test and Measurement Data:**

Follows

Name of Test: Carrier Output Power (Conducted)
Specification: 47 CFR 2.1046(a)
Guide: ANSI/TIA/EIA-603-1992, Paragraph 2.2.1

Measurement Procedure

- A) The EUT was connected to a resistive coaxial attenuator of normal load impedance, and the unmodulated output power was measured by means of an RF Power Meter.
- B) Measurement accuracy is $\pm 3\%$.

Transmitter Test Set-Up: RF Power Output

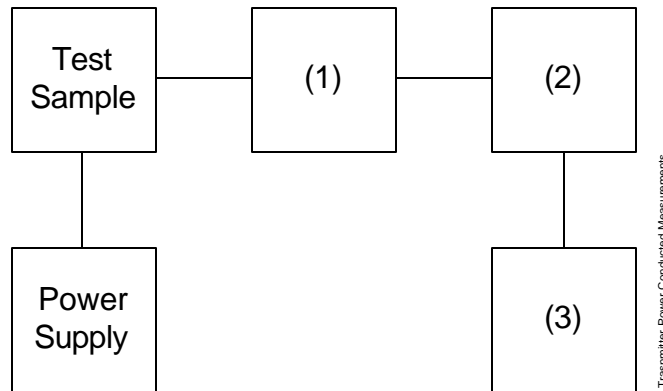

Asset	Description	s/n	Cycle	Last Cal
(1)	Coaxial Attenuator			
X	i00231/2 PASTERNAK PE7021-30 (30 dB)	231 or 232	NCR	
	i00122/3 NARDA 766 (10 dB)	7802 or 7802A	NCR	
(2)	Power Meters			
X	i00020 HP 8901A Power Mode	2105A01087	12 mo.	Apr-04
(3)	Frequency Counter			
X	i00020 HP 8901A Frequency Mode	2105A01087	12 mo.	Apr-04

Name of Test: Carrier Output Power (Conducted)

Measurement Results
(Worst case)

Frequency of Carrier, MHz = 776.100, 783.550, 799.500
Ambient Temperature = 23°C ± 3°C

Power Setting	RF Power, dB	RF Power, Watts
High	16.9	0.050
Low	7.0	0.005



Performed by:

Bobby Leanio

Name of Test: RF Power Output (Radiated)
Specification: 47 CFR 2.1046(a)
Test Equipment: As per attached page

Measurement Procedure (Radiated)

1. The EUT was placed on an open-field site and its radiated field strength at a known distance was measured by means of a spectrum analyzer. Equivalent loading was calculated from the equation $P_t = ((E \times R)^2 / 49.2)$ watts, where $R = 3m$.
2. Antenna supplied is quarter wave flexible monopole
3. Field strength is peak measured.
4. Measurement accuracy is ± 1.5 dB.

Measurement Results

g0520115: 2005-Feb-15 Tue 09:26:00
 State: 2:High Power
 Amps Mode:

Ambient Temperature: 23°C \pm 3°C

Frequency Tuned, MHz	Frequency Emission, MHz	Meter, dBuV/m	CF, dB	ERP, dBm	ERP, Watts
776.100000	776.103800	86.20	32.54	23.4	0.219
789.500000	789.500000	88.17	32.45	23.2	0.209
799.900000	799.901300	84.66	32.37	19.7	0.093

Name of Test: Field Strength of Spurious Radiation

Specification: 47 CFR 2.1053(a)

Guide: ANSI/TIA/EIA-603-1992/2001, Paragraph 1.2.12 and Table 16, 47 CFR 22.917

Measurement Procedure

Definition:

Radiated spurious emissions are emissions from the equipment when transmitting into a non-radiating load on a frequency or frequencies which are outside an occupied band sufficient to ensure transmission of information of required quality for the class of communications desired.

Method of Measurement:

- A) Connect the equipment as illustrated
- B) Adjust the spectrum analyzer for the following settings:
 - 1) Resolution Bandwidth 100 kHz (<1 GHz), 1 MHz (> 1GHz).
 - 2) Video Bandwidth = 3 times Resolution Bandwidth, or 30 kHz (22.917)
 - 3) Sweep Speed ≤ 2000 Hz/second
 - 4) Detector Mode = Mean or Average Power
- C) Place the transmitter to be tested on the turntable in the standard test site. The transmitter is transmitting into a non-radiating load that is placed on the turntable. The RF cable to this load should be of minimum length.

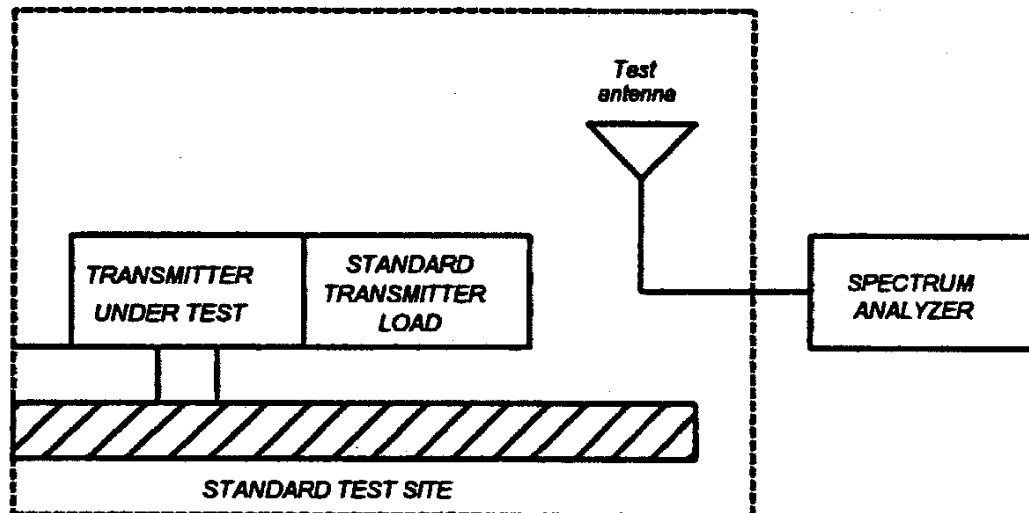

Name of Test: Field Strength of Spurious Radiation (Cont.)

- D) For each spurious measurement the test antenna should be adjusted to the correct length for the frequency involved. This length may be determined from a calibration ruler supplied with the equipment. Measurements shall be made from the lowest radio frequency generated in the equipment to the tenth harmonic of the carrier, except for the region close to the carrier equal to \pm the test bandwidth (see section 1.3.4.4).
- E) For each spurious frequency, raise and lower the test antenna from 1 m to 4 m to obtain a maximum reading on the spectrum analyzer with the test antenna at horizontal polarity. Repeat this procedure to obtain the highest possible reading. Record this maximum reading.
- F) Repeat step E) for each spurious frequency with the test antenna polarized vertically.

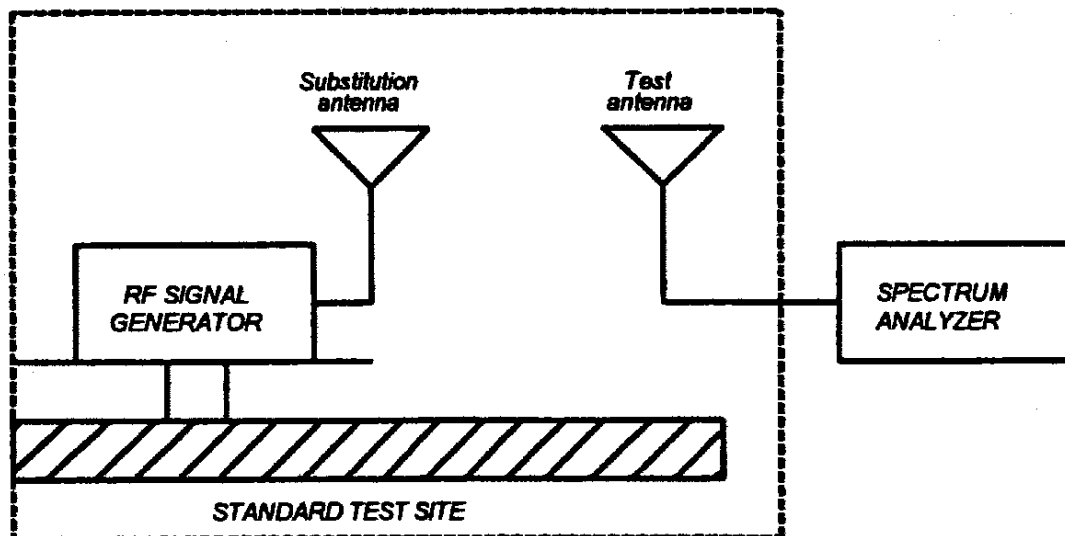

- G) Reconnect the equipment as illustrated.
- H) Keep the spectrum analyzer adjusted as in step B).
- I) Remove the transmitter and replace it with a substitution antenna (the antenna should be half-wavelength for each frequency involved). The center of the substitution antenna should be approximately at the same location as the center of the transmitter. At lower frequencies, where the substitution antenna is very long, this will be impossible to achieve when the antenna is polarized vertically. In such case the lower end of the antenna should be 0.3 m above the ground.

Name of Test: Field Strength of Spurious Radiation (Cont.)

- J) Feed the substitution antenna at the transmitter end with a signal generator connected to the antenna by means of a non-radiating cable. With the antennas at both ends horizontally polarized and with the signal generator tuned to a particular spurious frequency, raise and lower the test antenna to obtain a maximum reading at the spectrum analyzer. Adjust the level of the signal generator output until the previously recorded maximum reading for this set of conditions is obtained. This should be done carefully repeating the adjustment of the test antenna and generator output.
- K) Repeat step J) with both antennas vertically polarized for each spurious frequency.
- L) Calculate power in dBm into a reference ideal half-wave dipole antenna by reducing the readings obtained in steps J) and K) by the power loss in the cable between the generator and the antenna and further corrected for the gain of the substitution antenna used relative to an ideal half-wave dipole antenna.
- M) The levels recorded in step L) are absolute levels of radiated spurious emissions in dBm. The radiated spurious emissions in dB can be calculated by the following:

Radiated spurious emissions dB =

$$10\log_{10}(\text{TX power in watts}/0.001) - \text{the levels in step I)}$$

NOTE: It is permissible that other antennas provided can be referenced to a dipole.

Test Equipment

Asset	Description	s/n	Cycle	Last Cal
Transducer				
i00088	EMCO 3109-B 25MHz-300MHz	2336	12 mo.	Sep-03
X i00089	Apriel 2001 200MHz-1GHz	001500	12 mo.	Sep-03
X i00103	EMCO 3115 1GHz-18GHz	9208-3925	12 mo.	Jan-04
Amplifier				
X i00028	HP 8449A	2749A00121	12 mo.	May-04
Spectrum Analyzer				
X i00029	HP 8563E	3213A00104	12 mo.	May-04
X i00033	HP 85462A	3625A00357	12 mo.	Sep-04
Substitution Generator				
X i00067	HP 8920A Communication TS	3345U01242	12 mo.	Jun-04
i00207	HP 8753D Network Analyzer	3410A08514	12 mo.	Jul-04

Name of Test: Field Strength of Spurious Radiation

Measurement Results

g0520118: 2005-Feb-17 Thu 09:34:00
STATE: 2:High Power

Ambient Temperature: 23°C ± 3°C

Frequency Tuned, MHz	Frequency Emission, MHz	ERP, dBm	ERP, dBc
799.500000	1599.793500	-40.5	-60.20
799.500000	2399.689800	-44.5	-64.20
799.500000	3199.586800	-56.6	-76.30
799.500000	3999.483800	-56.1	-75.80
799.500000	4799.379800	-53.1	-72.80
799.500000	5599.278800	-58.8	-78.50
799.500000	6399.174300	-48.9	-68.60

g0520119: 2005-Feb-17 Thu 09:53:00
STATE: 2:High Power

Ambient Temperature: 23°C ± 3°C

Frequency Tuned, MHz	Frequency Emission, MHz	ERP, dBm	ERP, dBc
776.100000	1552.195500	-35.2	-35.2
776.100000	2328.292300	-47.7	-47.7
776.100000	3104.388800	-56.8	-56.8
776.100000	3880.486800	-60.7	-60.7
776.100000	4656.582500	-43.3	-43.3
776.100000	5432.680500	-54.5	-54.5
776.100000	6208.778500	-52.1	-52.1

g0520121: 2005-Feb-17 Thu 10:05:00
STATE: 2:High Power

Ambient Temperature: 23°C ± 3°C

Frequency Tuned, MHz	Frequency Emission, MHz	ERP, dBm	ERP, dBc
786.500000	1572.995800	-37.9	-57.60
786.500000	2359.492800	-44.4	-64.10
786.500000	3145.991300	-58.2	-77.90
786.500000	3932.489000	-57.3	-77.00
786.500000	4718.987300	-46.0	-65.70
786.500000	5505.481000	-54.2	-73.90



Performed by:

Bobby Leanio

Name of Test: Emission Masks (Occupied Bandwidth)
Specification: 47 CFR 2.1049(c)(1)
Guide: ANSI/TIA/EIA-603-1992, Paragraph 2.2.11

Measurement Procedure

- A) The EUT and test equipment were set up as shown below
- B) For EUTs supporting audio modulation, the audio signal generator was adjusted to the frequency of maximum response and with output level set for $\pm 2.5/\pm 1.25$ kHz deviation (or 50% modulation). With level constant, the signal level was increased 16 dB.
- C) For EUTs supporting digital modulation, the digital modulation mode was operated to its maximum extent.
- D) The Occupied Bandwidth was measured with the Spectrum Analyzer controls set as shown on the test results.

Transmitter Test Set-Up: Occupied Bandwidth

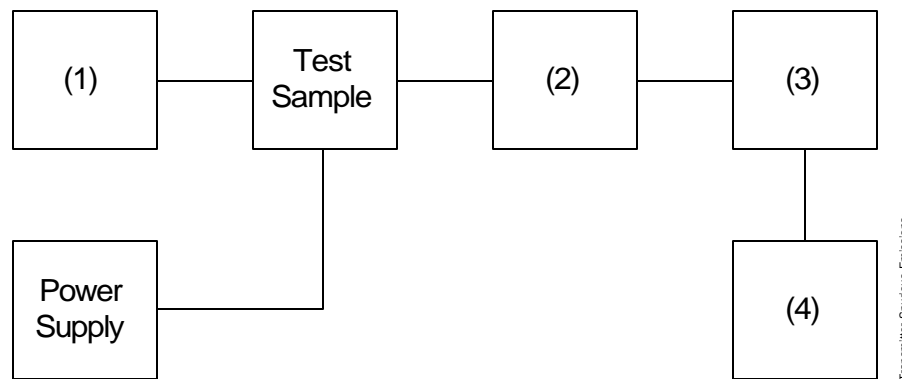

Asset	Description	s/n	Cycle	Last Cal
(1) Audio Oscillator/Generator				
X i00017	HP 8903A Modulation Meter	2216A01753	12 mo.	Apr-04
(2) Coaxial Attenuator				
X i00231/2	PASTERNAK PE7021-30 (30 dB)	231 or 232	NCR	
i00123	NARDA 766 (10 dB)	7802A	NCR	
(3) Interface				
X i00021	HP 8954A Transceiver Interface	2146A00159	NCR	
(4) Spectrum Analyzer				
X i00048	HP 8566B Spectrum Analyzer	2511A01467	12 mo.	Oct-04
i00029	HP 8563E Spectrum Analyzer	3213A00104	12 mo.	May-04

Name of Test: Emission Masks (Occupied Bandwidth)

Measurement Results

g0520116: 2005-Feb-24 Thu 11:20:00
State: 2:High Power

Ambient Temperature: 23°C ± 3°C

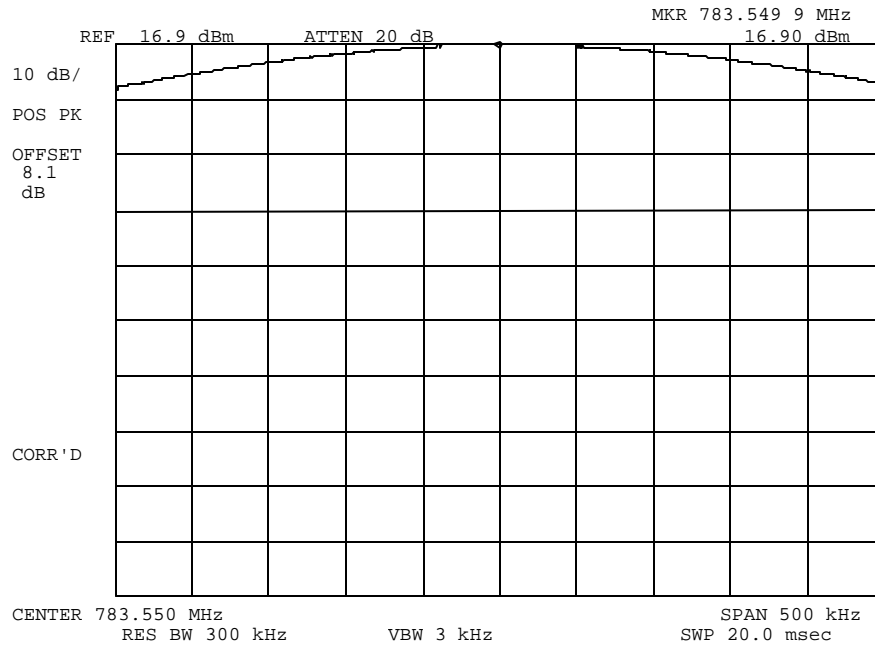

Power: High
Modulation: None
Mid Channel



Performed by:

Bobby Leanio

Name of Test: Emission Masks (Occupied Bandwidth)

Measurement Results

g0520117: 2005-Feb-24 Thu 09:10:00
State: 2:High Power

Ambient Temperature: 23°C ± 3°C

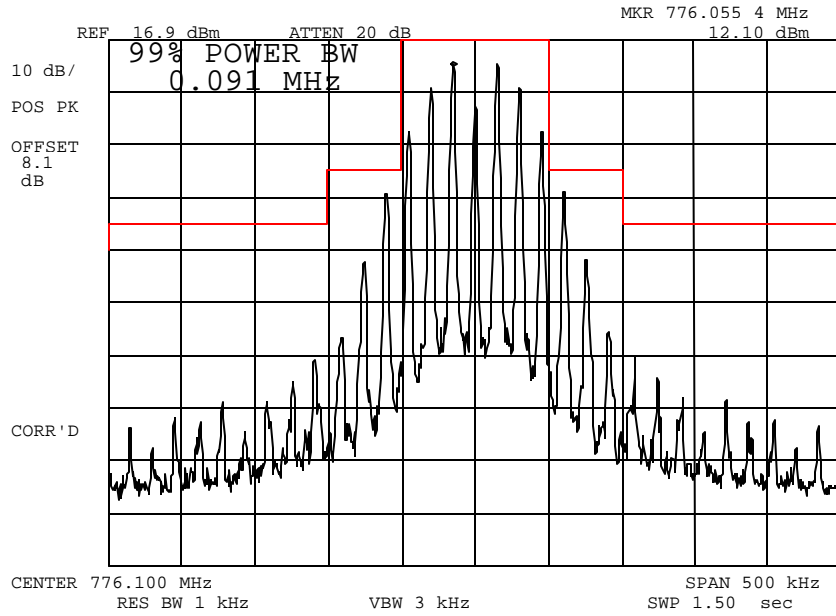

Power:
Modulation:

High
Voice, 15000 HZ @ 20 DB above reference level
Low Channel
MASK: Wireless Mic, 74.861

Performed by:



Bobby Leanio

Name of Test: Emission Masks (Occupied Bandwidth)

Measurement Results

g0520118: 2005-Feb-24 Thu 09:35:00
State: 2:High Power

Ambient Temperature: 23°C ± 3°C

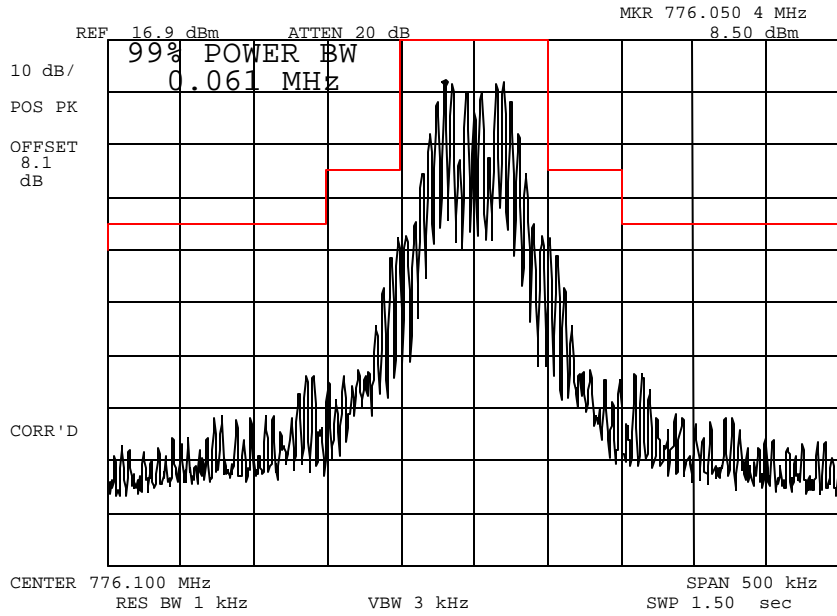

Power: High
Modulation: Voice, 5000 HZ @ 20 DB above reference level
Low Channel
MASK: Wireless Mic, 74.861



Performed by:

Bobby Leanio

Name of Test: Emission Masks (Occupied Bandwidth)

Measurement Results

g0520119: 2005-Feb-24 Thu 12:22:00
State: 2:High Power

Ambient Temperature: 23°C ± 3°C

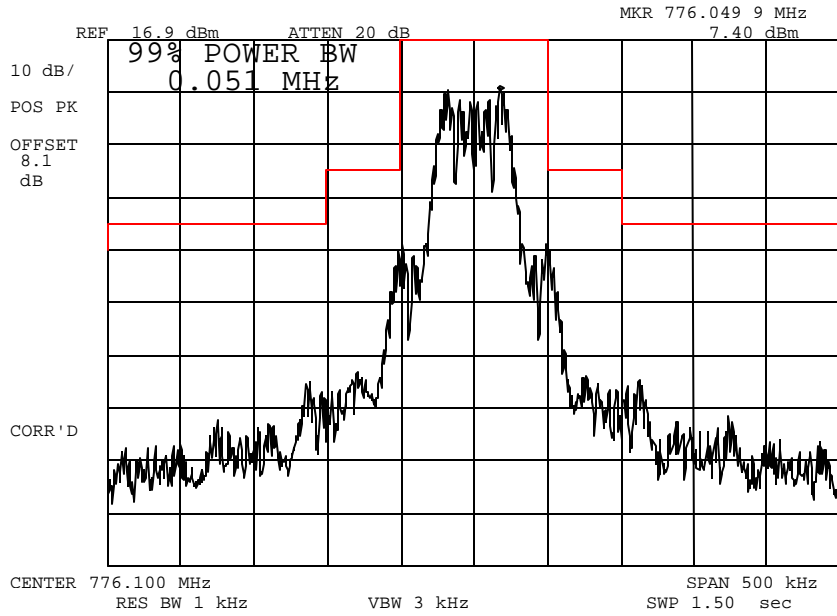

Power: High
Modulation: Voice, 2500 HZ @ 20 DB above reference level
Low Channel
MASK: Wireless Mic, 74.861



Performed by:

Bobby Leanio

Name of Test: Emission Masks (Occupied Bandwidth)

Measurement Results

g0520120: 2005-Feb-24 Thu 12:34:00
State: 2:High Power

Ambient Temperature: 23°C ± 3°C

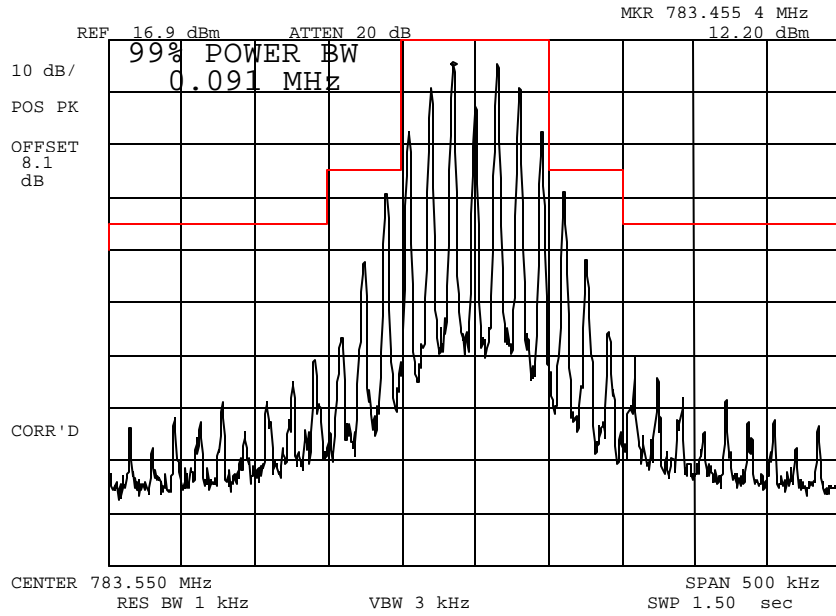

Power:
Modulation:

High
Voice, 15000 HZ @ 20 DB above reference level
Mid Channel
MASK: Wireless Mic, 74.861

Performed by:



Bobby Leanio

Name of Test: Emission Masks (Occupied Bandwidth)

Measurement Results

g0520122: 2005-Feb-24 Thu 13:35:00
State: 2:High Power

Ambient Temperature: 23°C ± 3°C

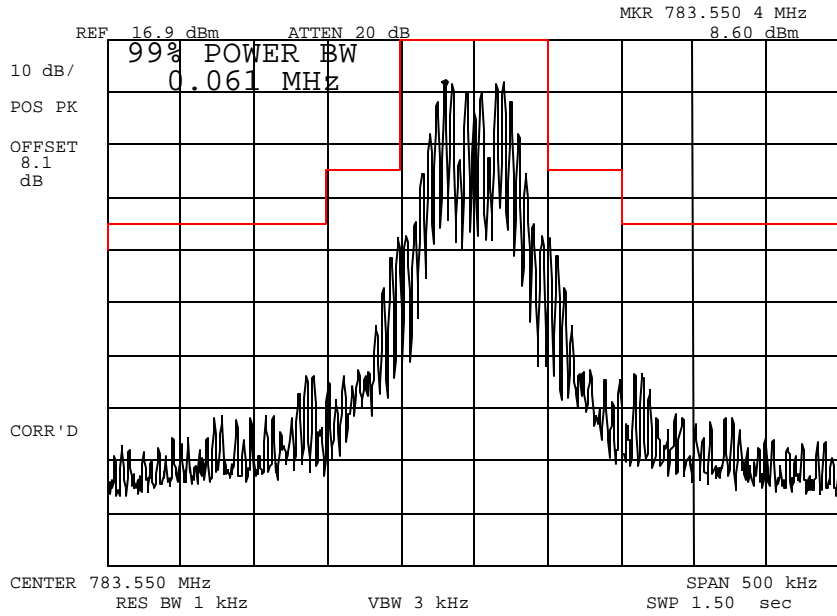

Power: High
Modulation: Voice, 5000 HZ @ 20 DB above reference level
Mid Channel
MASK: Wireless Mic, 74.861



Performed by:

Bobby Leanio

Name of Test: Emission Masks (Occupied Bandwidth)

Measurement Results

g0520124: 2005-Feb-24 Thu 14:10:00
State: 2:High Power

Ambient Temperature: 23°C ± 3°C

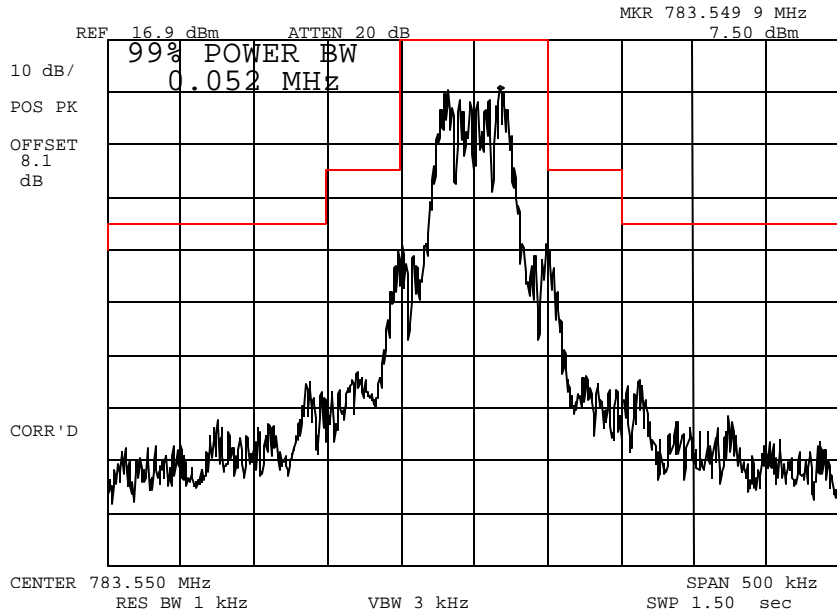

Power: High
Modulation: Voice, 2500 HZ @ 20 DB above reference level
Mid Channel
MASK: Wireless Mic, 74.861



Performed by:

Bobby Leanio

Name of Test: Emission Masks (Occupied Bandwidth)

Measurement Results

g0520125: 2005-Feb-24 Thu 14:38:00
State: 2:High Power

Ambient Temperature: 23°C ± 3°C

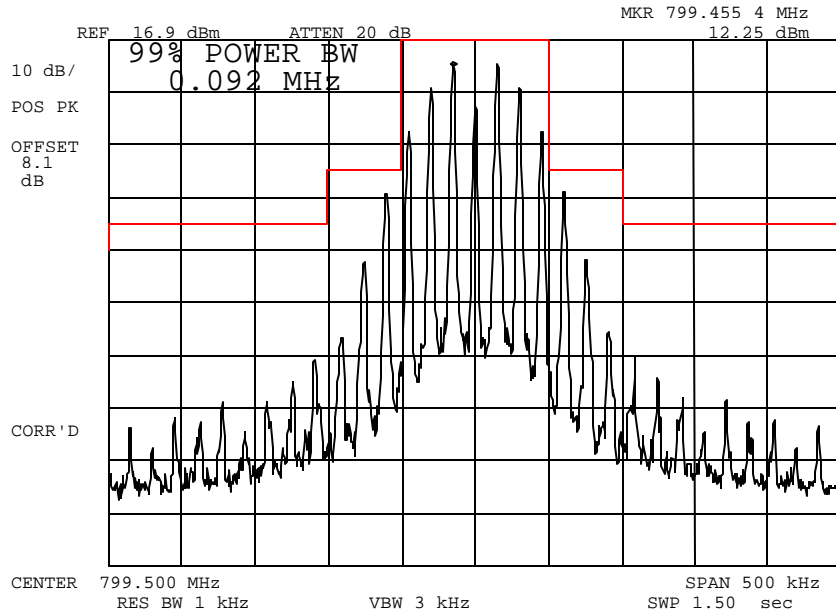

Power:
Modulation:

High
Voice, 15000 HZ @ 20 DB above reference level
High Channel
MASK: Wireless Mic, 74.861

Performed by:



Bobby Leanio

Name of Test: Emission Masks (Occupied Bandwidth)

Measurement Results

g0520126: 2005-Feb-24 Thu 14:53:00
State: 2:High Power

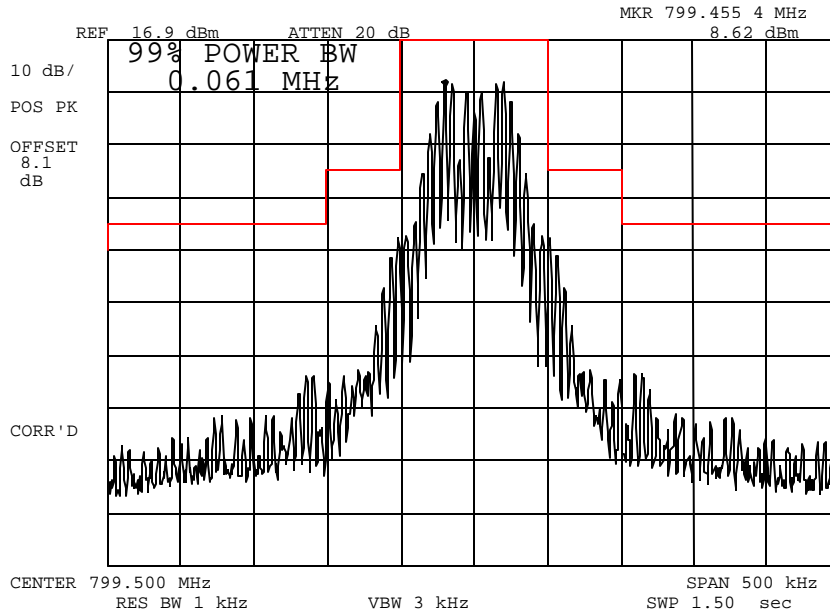
Ambient Temperature: 23°C ± 3°C



Power: High
Modulation: Voice, 5000 HZ @ 20 DB above reference level
High Channel
MASK: Wireless Mic, 74.861



Performed by:

Bobby Leanio

Name of Test: Emission Masks (Occupied Bandwidth)

Measurement Results

g0520128: 2005-Feb-24 Thu 15:03:00
State: 2:High Power

Ambient Temperature: 23°C ± 3°C

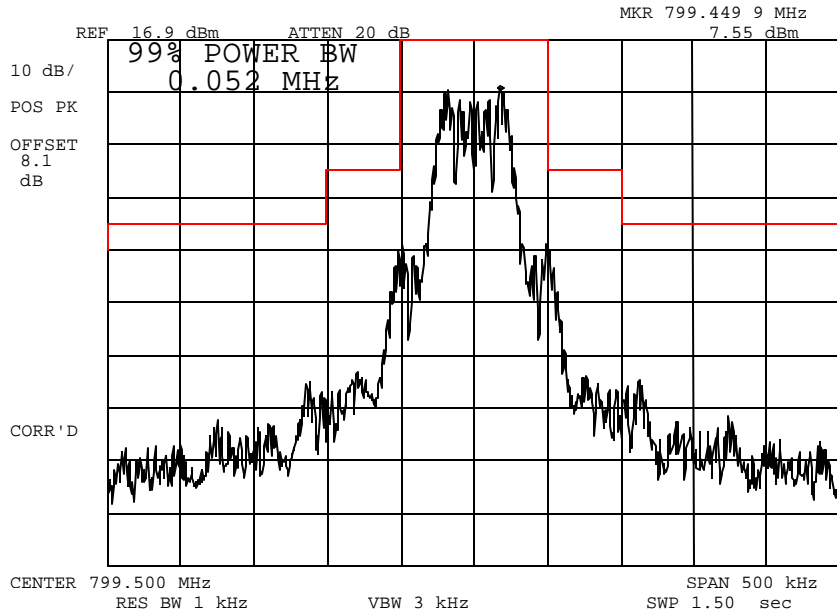

Power: High
Modulation: Voice, 2500 HZ @ 20 DB above reference level
Mid Channel
MASK: Wireless Mic, 74.861



Performed by:

Bobby Leanio

Name of Test: Audio Frequency Response
Specification: 47 CFR 2.1047(a)
Guide: ANSI/TIA/EIA-603-1992, Paragraph 2.2.6

Measurement Procedure

- A) The EUT and test equipment were set up as shown below.
- B) The audio signal generator was connected to the audio input circuit/microphone of the EUT.
- C) The audio signal input was adjusted to obtain 20% modulation at 1 kHz, and this point was taken as the 0 dB reference level.
- D) With input levels held constant and below limiting at all frequencies, the audio signal generator was varied from 100 Hz to 50 kHz.
- E) The response in dB relative to 1 kHz was measured, using the HP 8901A Modulation Meter.

Transmitter Test Set-Up: Audio Frequency Response

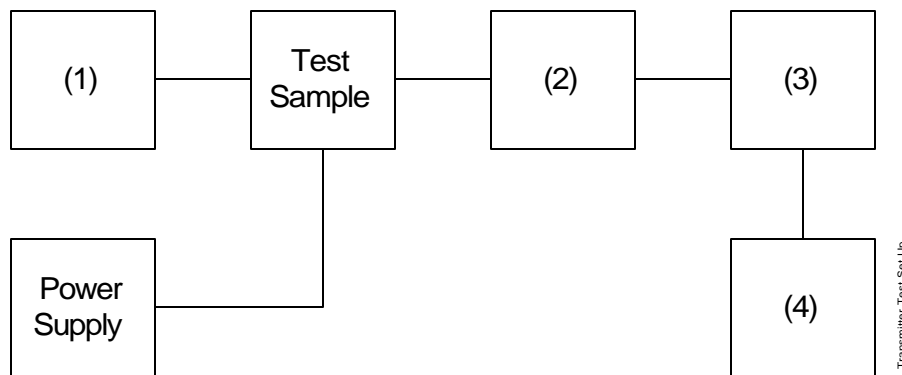

Asset	Description	s/n	Cycle	Last Cal
(1) Audio Oscillator				
X	i00017 HP 8903A Audio Analyzer	2216A01753	12 mo.	Apr-04
(2) Coaxial Attenuator				
	i00122/3 NARDA 766-(10 dB)	7802 or 7802A	NCR	
X	i00231/2 PASTERNAK PE7021-30 (30 dB)	231 or 232	NCR	
(3) Modulation Analyzer				
X	i00020 HP 8901A Modulation Meter	2105A01087	12 mo.	Apr-04
(4) Audio Analyzer				
X	i00017 HP 8903A Audio Analyzer	2216A01753	12 mo.	Apr-04

Name of Test: Audio Frequency Response

Measurement Results

State: Ambient Temperature: 23°C ± 3°C

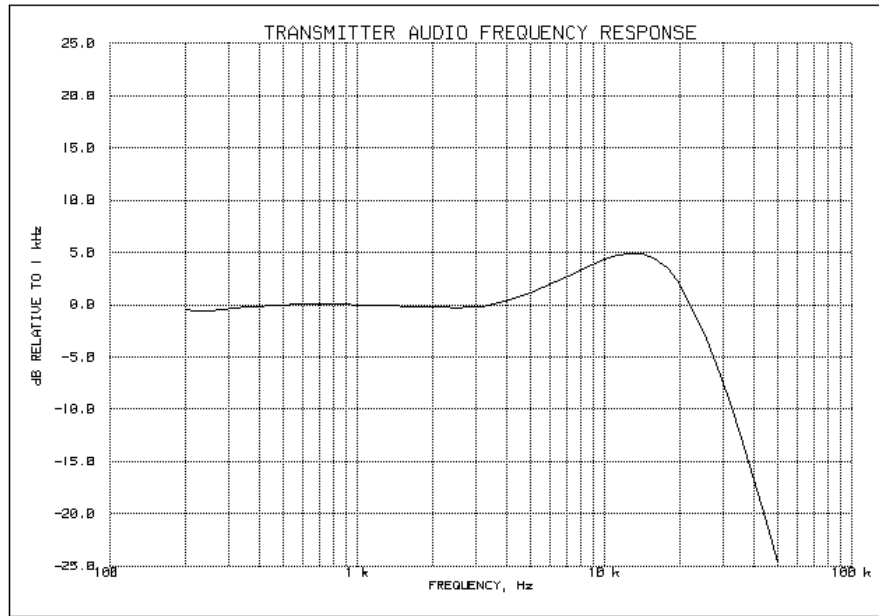

Frequency of Maximum Audio Response, Hz = 12600

Additional points:

FREQUENCY, Hz	LEVEL, dB
300	-0.44
20000	1.86



Performed by:

Bobby Leanio

Name of Test: Modulation Limiting
Specification: 47 CFR 2.1047(b)
Guide: ANSI/TIA/EIA-603-1992, Paragraph 2.2.3

Measurement Procedure

- A) The signal generator was connected to the input of the EUT as shown below.
- B) The modulation response was measured for each of three frequencies (one of which was the frequency of maximum response), and the input voltage was varied and was observed on an HP 8901A Modulation Analyzer.
- C) The input level was varied from 30% modulation (± 1.5 kHz deviation) to at least 20 dB higher than the saturation point.
- D) Measurements were performed for both negative and positive modulation and the respective results were recorded.

Transmitter Test Set-Up: Modulation Limiting

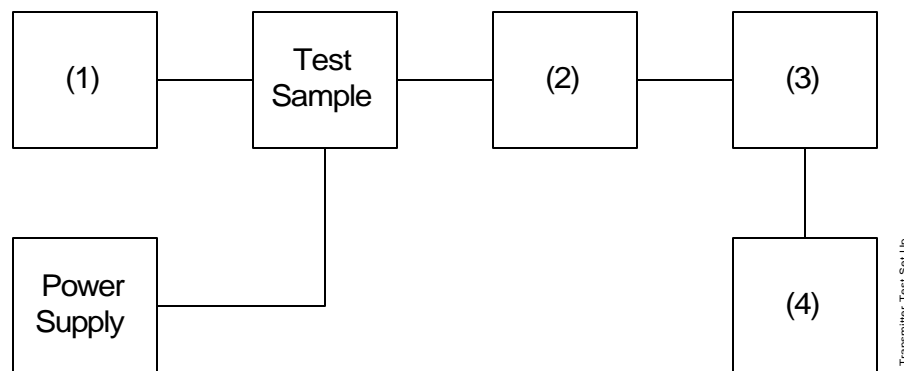

Asset	Description	s/n		
(1) Audio Oscillator				
X	i00017 HP 8903A Audio Analyzer	2216A01753	12 mo.	Apr-04
(2) Coaxial Attenuator				
	i0012/23 NARDA 766-(10 dB)	7802 or 7802A	NCR	
X	i00231/2 PASTERNAK PE7021-30 (30 dB)	231 or 232	NCR	
(3) Modulation Analyzer				
X	i00020 HP 8901A Modulation Meter	2105A01087	12 mo.	Apr-04
(4) Audio Analyzer				
X	i00017 HP 8903A Audio Analyzer	2216A01753	12 mo.	Apr-04

Name of Test: Modulation Limiting

Measurement Results

Ambient Temperature: 23°C ± 3°C

Positive Peaks:

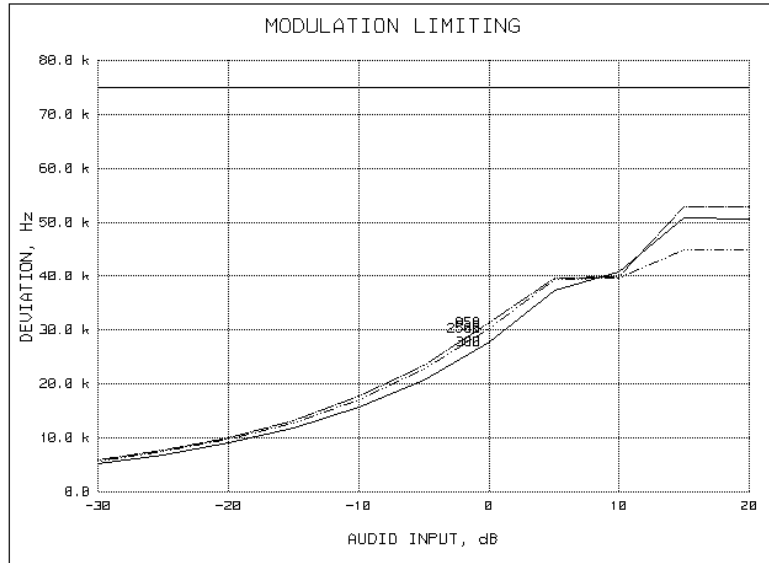

Negative Peaks:

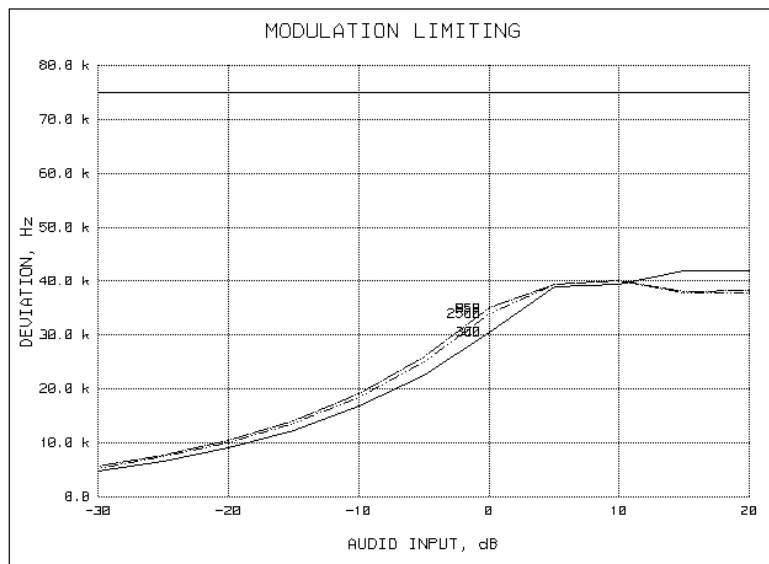

Performed by:



Bobby Leanio

Name of Test: Frequency Stability (Temperature Variation)
Specification: 47 CFR 2.1055(a)(1)
Guide: ANSI/TIA/EIA-603-1992, Paragraph 2.2.2

Measurement Procedure

- A) The EUT and test equipment were set up as shown on the following page.
- B) With all power removed, the temperature was decreased to -30°C and permitted to stabilize for three hours. Power was applied and the maximum change in frequency was noted within one minute.
- C) With power OFF, the temperature was raised in 10°C steps. The sample was permitted to stabilize at each step for at least one-half hour. Power was applied and the maximum frequency change was noted within one minute.
- D) The temperature tests were performed for the worst case.

Transmitter Test Set-Up: Temperature Variation

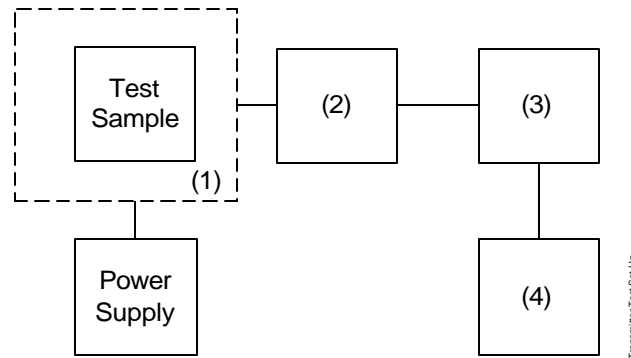

Asset	Description	s/n	Cycle	Last Cal
(1) Temperature, Humidity, Vibration				
X	i00027 Tenney Temp. Chamber	9083-765-234	NCR	
(2) Coaxial Attenuator				
X	i00231/2 PASTERNAK PE7021-30 (30 dB)	231 or 232	NCR	
	i00122/3 NARDA 766 (10 dB)	7802 or 7802A	NCR	
(3) RF Power				
X	i00067 HP 8920A Communications TS	3345U01242	12 mo.	Jun-04
(4) Frequency Counter				
X	i00067 HP 8920A Communications TS	3345U01242	12 mo.	Jun-04

Name of Test: Frequency Stability (Temperature Variation)

Measurement Results

State: Ambient Temperature: 23°C ± 3°C

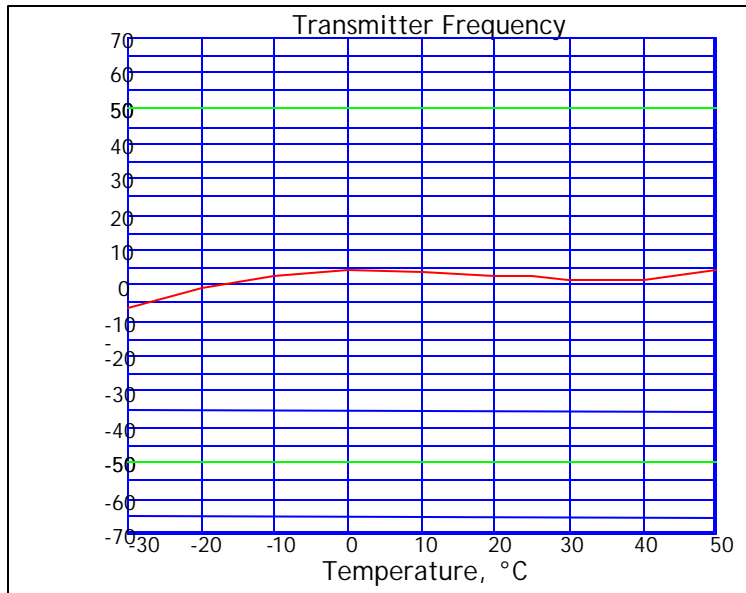

Performed by:



Bobby Leanio

Name of Test: Frequency Stability (Voltage Variation)
Specification: 47 CFR 2.1055(d)(1)
Guide: ANSI/TIA/EIA-603-1992, Paragraph 2.2.2

Measurement Procedure

- A) The EUT was placed in a temperature chamber (if required) at 25±5°C and connected as shown below.
- B) The power supply voltage to the EUT was varied from 85% to 115% of the nominal value measured at the input to the EUT.
- C) The variation in frequency was measured for the worst case.

Transmitter Test Set-Up: Voltage Variation

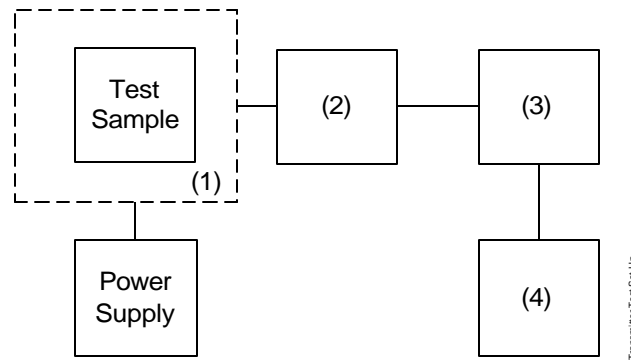

Asset	Description	s/n	Cycle	Last Cal
(1) Temperature, Humidity, Vibration				
i00027	Tenney Temp. Chamber	9083-765-234	NCR	
(2) Coaxial Attenuator				
X i00231/2	PASTERNAK PE7021-30 (30 dB)	231 or 232	NCR	
i00122/3	NARDA 766 (10 dB)	7802 or 7802A	NCR	
(3) RF Power				
X i00020	HP 8901A Power Mode	2105A01087	12 mo.	Apr-04
(4) Frequency Counter				
X i00020	HP 8901A Frequency Mode	2105A01087	12 mo.	Apr-04

Results: Frequency Stability (Voltage Variation)

State: Ambient Temperature: 23°C ± 3°C

RESULTS: Frequency Stability (Voltage Variation)

g0180019: 2001-Aug-02 Thu 10:54:52

STATE: 0:General

LIMIT, ppm = 50
 LIMIT, Hz = 39955
 BATTERY END POINT (Voltage) = 7.3

% of STV	Voltage	Frequency, MHz	Change, Hz	Change, ppm
85	7.65	791.199970	-30	-0.04
100	9.00	791.200000	0	0.00
115	10.35	791.200020	25	0.03
82	7.30	791.199980	-15	-0.02



Performed by:

Bobby Leanio

Name of Test: Necessary Bandwidth and Emission Bandwidth

Specification: 47 CFR 2.202(g)

MODULATION = 91K0F3E

NECESSARY BANDWIDTH CALCULATION:

MAXIMUM MODULATION (M), kHz	=	15
MAXIMUM DEVIATION (D), kHz	=	30.5
CONSTANT FACTOR (K)	=	1
NECESSARY BANDWIDTH (B_N), kHz	=	$(2 \times M) + (2 \times D \times K)$
	=	91.0



Performed by:
END OF TEST REPORT

David E. Lee, Compliance Test Manager

**Testimonial
and
Statement of Certification**

This is to Certify:

1. **That** the application was prepared either by, or under the direct supervision of, the undersigned.
2. **That** the technical data supplied with the application was taken under my direction and supervision.
3. **That** the data was obtained on representative units, randomly selected.
4. **That**, to the best of my knowledge and belief, the facts set forth in the application and accompanying technical data are true and correct.

Certifying Engineer:



David E. Lee, Compliance Test Manager