



FCC RF Test Report

APPLICANT : Verifone, Inc.
EQUIPMENT : Point of Sale Terminal
BRAND NAME : Verifone
MODEL NAME : X990
FCC ID : B32X990
STANDARD : 47 CFR Part 2, and 90(S)
CLASSIFICATION : PCS Licensed Transmitter (PCB)

The product was received on Dec. 14, 2019 and completely tested on Jan. 26, 2020. We, Sporton International (ShenZhen) Inc., would like to declare that the tested sample has been evaluated in accordance with the procedures given in ANSI C63.26-2015 and shown compliance with the applicable technical standards.

This report contains data that were produced under subcontract by Laboratory Sporton International (Kunshan) Inc.

The test results in this report apply exclusively to the tested model / sample. Without written approval of Sporton International (ShenZhen) Inc., the test report shall not be reproduced except in full.

Reviewed by: Derreck Chen / Supervisor

Approved by: Eric Shih / Manager



Sporton International (ShenZhen) Inc.

1/F, 2/F, Bldg 5, Shiling Industrial Zone, Xinwei Village, Xili, Nanshan, Shenzhen, 518055
 People's Republic of China



TABLE OF CONTENTS

REVISION HISTORY..... 3

SUMMARY OF TEST RESULT 4

1 GENERAL DESCRIPTION 5

1.1 Applicant..... 5

1.2 Manufacturer 5

1.3 Feature of Equipment Under Test..... 5

1.4 Product Specification of Equipment Under Test 5

1.5 Modification of EUT 6

1.6 Maximum Conducted Power, Frequency Tolerance and Emission Designator..... 6

1.7 Testing Site..... 7

1.8 Test Software 7

1.9 Applied Standards 8

2 TEST CONFIGURATION OF EQUIPMENT UNDER TEST 9

2.1 Test Mode..... 9

2.2 Connection Diagram of Test System 10

2.3 Support Unit used in test configuration and system 10

2.4 Measurement Results Explanation Example 10

2.5 Frequency List of Low/Middle/High Channels 11

3 TEST RESULT 12

3.1 Conducted Output Power Measurement 12

3.2 99% Occupied Bandwidth and 26dB Bandwidth Measurement..... 13

3.3 Emissions Mask Measurement 14

3.4 Emissions Mask – Out Of Band Emissions Measurement..... 16

3.5 Field Strength of Spurious Radiation Measurement 17

3.6 Frequency Stability Measurement..... 19

4 LIST OF MEASURING EQUIPMENT 21

5 UNCERTAINTY OF EVALUATION 22

APPENDIX A. TEST RESULTS OF CONDUCTED TEST

APPENDIX B. TEST RESULTS OF RADIATED TEST

APPENDIX C. TEST SETUP PHOTOGRAPHS



REVISION HISTORY

REPORT NO.	VERSION	DESCRIPTION	ISSUED DATE
FW9D1403	Rev. 01	Initial issue of report	Apr. 03, 2020



SUMMARY OF TEST RESULT

Report Section	FCC Rule	Description	Limit	Result	Remark
3.1	§2.1046	Conducted Output Power	Reporting only	PASS	-
3.2	§2.1049 §90.209	Occupied Bandwidth and 26dB Bandwidth	Reporting only	PASS	-
3.3	§2.1051 §90.691	Emission masks – In-band emissions	$< 50+10\log_{10}(P[\text{Watts}])$	PASS	-
3.4	§2.1051 §90.691	Emission masks – Out of band emissions	$< 43+10\log_{10}(P[\text{Watts}])$	PASS	-
3.5	§2.1053 §90.691	Field Strength of Spurious Radiation	$< 43+10\log_{10}(P[\text{Watts}])$	PASS	Under limit 29.23 dB at 2455.110 MHz
3.6	§2.1055 §90.213	Frequency Stability for Temperature & Voltage	$< 2.5 \text{ ppm}$	PASS	-

Declaration of Conformity:

The test results with all measurement uncertainty excluded are presented in accordance with the regulation limits or requirements declared by manufacturers.

Comments and Explanations:

The declared of product specification for EUT presented in the report are provided by the manufacturer, and the manufacturer takes all the responsibilities for the accuracy of product specification.



1 General Description

1.1 Applicant

Verifone, Inc.

Suite 200 1400 W Stanford Ranch Rd Rocklin CA 95765 USA

1.2 Manufacturer

Verifone Systems (China) Inc.

Rm 318, south of Bld C18, Startup Headquarters Base, North of Fuyuan Road, Wuqing Development Area, Tianjin, China, 301700.

1.3 Feature of Equipment Under Test

Product Feature	
Equipment	Point of Sale Terminal
Brand Name	Verifone
Model Name	X990
FCC ID	B32X990
EUT supports Radios application	GSM/WCDMA/LTE WLAN 2.4GHz 802.11b/g/n HT20/HT40 WLAN 5GHz 802.11a/n HT20/HT40 Bluetooth BR / EDR / LE GNSS/NFC
IMEI Code	Conducted : N/A Radiation : 869091030296874/869091030296882
EUT Stage	Identical Prototype

Remark:

1. The above EUT's information was declared by manufacturer. Please refer to the specifications or user's manual for more detailed description.
2. There are four types of EUT, the difference between them is different suppliers for the LCD Panel. We only choose the sample 1 to perform full tests

1.4 Product Specification of Equipment Under Test

Product Specification subjective to this standard	
Tx Frequency	814.7 ~ 823.3 MHz
Rx Frequency	859.7 ~ 868.3 MHz
Bandwidth	1.4MHz / 3MHz / 5MHz / 10MHz / 15MHz
Maximum Output Power to Antenna	23.40 dBm
Type of Modulation	QPSK / 16QAM / 64QAM (Downlink only)



1.5 Modification of EUT

No modifications are made to the EUT during all test items.

1.6 Maximum Conducted Power, Frequency Tolerance and Emission Designator

FCC Rule	System	Type of Modulation	BW	Frequency Tolerance (ppm)	Emission Designator	Maximum Conducted power(W)
Part 90S	LTE Band 26	QPSK	1.4 MHz	-	1M10G7D	0.2089
Part 90S	LTE Band 26	16QAM	1.4 MHz	-	1M10W7D	0.1710
Part 90S	LTE Band 26	QPSK	3 MHz	-	2M73G7D	0.2173
Part 90S	LTE Band 26	16QAM	3 MHz	-	2M72W7D	0.1770
Part 90S	LTE Band 26	QPSK	5 MHz	-	4M52G7D	0.2188
Part 90S	LTE Band 26	16QAM	5 MHz	-	4M50W7D	0.1770
Part 90S	LTE Band 26	QPSK	10 MHz	0.0079	9M07G7D	0.2118
Part 90S	LTE Band 26	16QAM	10 MHz	-	9M03W7D	0.1762
Part 90S	LTE Band 26	QPSK	15 MHz	-	13M5G7D	0.2046
Part 90S	LTE Band 26	16QAM	15 MHz	-	13M4W7D	0.1945



1.7 Testing Site

Sporton International (Kunshan) Inc. is accredited to ISO/IEC 17025:2017 by American Association for Laboratory Accreditation with Certificate Number 5145.02.

Test Firm	Sporton International (Kunshan) Inc.		
Test Site Location	No. 1098, Pengxi North Road, Kunshan Economic Development Zone Jiangsu Province 215300 People's Republic of China TEL : +86-512-57900158 FAX : +86-512-57900958		
Test Site No.	Sporton Site No.	FCC Designation No.	FCC Test Firm Registration No.
	TH01-KS	CN1257	314309

Note: Test data subcontracted: Conducted test items in section 3.1~3.4 of this report.

Sporton International (Shenzhen) Inc. is accredited to ISO/IEC 17025:2017 by American Association for Laboratory Accreditation with Certificate Number 5145.01.

Test Firm	Sporton International (Shenzhen) Inc.		
Test Site Location	No. 3 Bldg the third floor of south, Shahe River west, Fengzeyuan Warehouse, Nanshan Shenzhen, 518055 People's Republic of China TEL: +86-755-33202398		
Test Site No.	Sporton Site No.	FCC Designation No.	FCC Test Firm Registration No.
	03CH04-SZ	CN1256	421272

1.8 Test Software

Item	Site	Manufacture	Name	Version
1.	03CH04-SZ	AUDIX	E3	6.2009-8-24



1.9 Applied Standards

According to the specifications of the manufacturer, the EUT must comply with the requirements of the following standards:

- ♦ 47 CFR Part 2, 90(S)
- ♦ ANSI C63.26-2015
- ♦ FCC KDB 971168 D01 Power Meas. License Digital Systems v03r01
- ♦ FCC KDB 971168 D02 Misc Rev Approv License Devices v02r01

Remark:

1. All test items were verified and recorded according to the standards and without any deviation during the test.
2. This EUT has also been tested and complied with the requirements of FCC Part 15, Subpart B, recorded in a separate test report.



2 Test Configuration of Equipment Under Test

2.1 Test Mode

During all testing, EUT is in link mode with base station emulator at maximum power level. The spurious emission measurements were carried out in semi-anechoic chamber with 3-meter test range, and EUT is rotated on three test planes to find out the worst emission.

Frequency range investigated for radiated emission is 30 MHz to 10th harmonic.

Test Items	Band	Bandwidth (MHz)						Modulation		RB #			Test Channel		
		1.4	3	5	10	15	20	QPSK	16QAM	1	Half	Full	L	M	H
Max. Output Power	26	v	v	v	v	v	-	v	v	v	v	v	v	v	v
26dB and 99% Bandwidth	26	v	v	v	v	v	-	v	v			v	v	v	v
Emission masks In-band emissions	26	v	v	v	v	v	-	v	v	v		v	v		v
Emission masks – Out of band emissions	26	v	v	v	v	v	-	v	v	v			v	v	v
Frequency Stability	26				v		-	v				v		v	
Radiated Spurious Emission	26	v	v	v	v		-	v		v			v	v	v
Note	1. The mark “v” means that this configuration is chosen for testing 2. The mark “-“ means that this bandwidth is not supported. 3. LTE Band26 transmit frequency for part22 rule is 824MHz-849MHz, for part90 rule is 814MHz-824MHz. ERP over 15MHz bandwidth complies the ERP limit line of part22 rule, therefore ERP of the partial frequency spectrum which falls within part 22 also complies.														

2.2 Connection Diagram of Test System

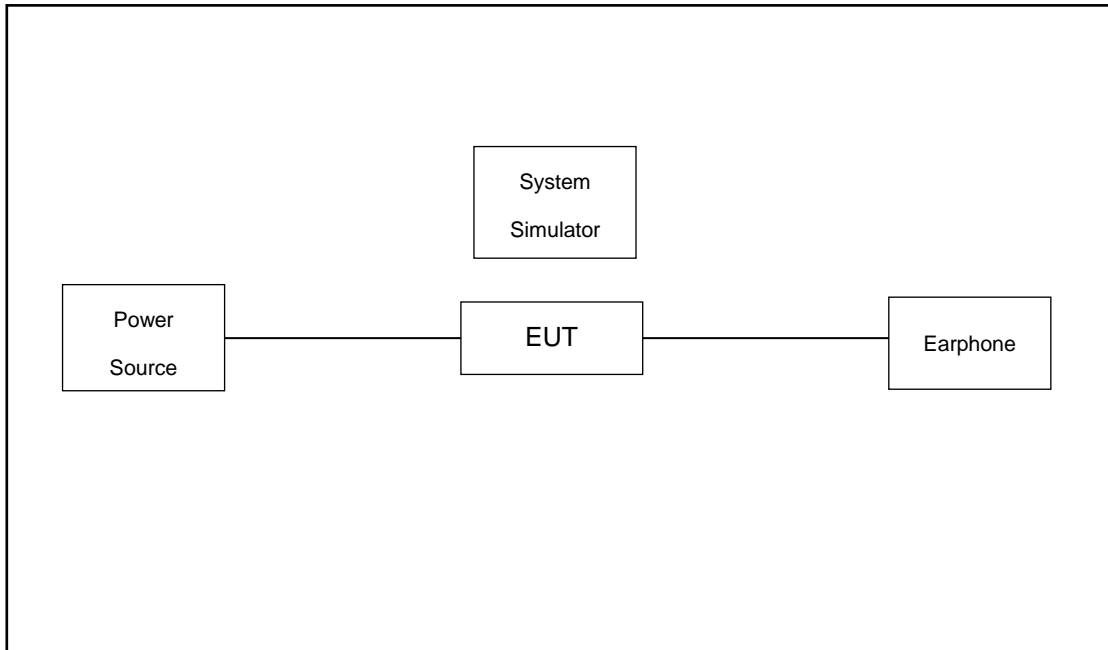

2.3 Support Unit used in test configuration and system

Item	Equipment	Trade Name	Model No.	FCC ID	Data Cable	Power Cord
1.	System Simulator	Anritsu	MT8820C	N/A	N/A	Unshielded, 1.8 m
2.	DC Power Supply	GW INSTEK	GPS-3030D	N/A	N/A	Unshielded, 1.8 m
3.	Earphone	apple	DCAY1V-A9007ZJW3-000	N/A	shielded,1.2m	N/A

2.4 Measurement Results Explanation Example

For all conducted test items:

The offset level is set in the spectrum analyzer to compensate the RF cable loss and attenuator factor between RF conducted output port and spectrum analyzer. With the offset compensation, the spectrum analyzer reading level will be exactly the RF output level.

The spectrum analyzer offset is derived from RF cable loss.

$Offset = RF\ cable\ loss.$

The following shows an offset computation example with RF cable loss 4.4 dB

Example :

$Offset(dB) = RF\ cable\ loss(dB).$
 $= 4.4\ (dB)$



2.5 Frequency List of Low/Middle/High Channels

LTE Band 26 Channel and Frequency List				
BW [MHz]	Channel/Frequency(MHz)	Lowest	Middle	Highest
15	Channel	26765	-	-
	Frequency	821.5	-	-
10	Channel	-	26740	-
	Frequency	-	819	-
5	Channel	26715	26740	26765
	Frequency	816.5	819	821.5
3	Channel	26705	26740	26775
	Frequency	815.5	819	822.5
1.4	Channel	26697	26740	26783
	Frequency	814.7	819	823.3

3 Test Result

3.1 Conducted Output Power Measurement

3.1.1 Description of the Conducted Output Power Measurement

A system simulator was used to establish communication with the EUT. Its parameters were set to enforce EUT transmitting at the maximum power. The measured power in the radio frequency on the transmitter output terminals shall be reported.

3.1.2 Measuring Instruments

The measuring equipment is listed in the section 4 of this test report.

3.1.3 Test Procedures

1. The transmitter output port was connected to the system simulator.
2. Set EUT at maximum power through the system simulator.
3. Select lowest, middle, and highest channels for each band and different modulation.
4. Measure and record the power level from the system simulator.

3.1.4 Test Setup

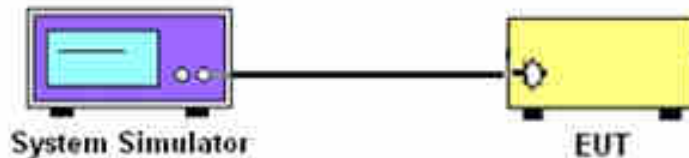

3.1.5 Test Result of Conducted Output Power

Please refer to Appendix A.

3.2 99% Occupied Bandwidth and 26dB Bandwidth Measurement

3.2.1 Description of (Occupied) Bandwidth Limitations Measurement

The 99% occupied bandwidth is the width of a frequency band such that, below the lower and above the upper frequency limits, the mean powers emitted are each equal to a specified percentage 0.5% of the total mean transmitted power.

The emission bandwidth is defined as the width of the signal between two points, located at the 2 sides of the carrier frequency, outside of which all emissions are attenuated at least 26 dB below the transmitter power.

3.2.2 Measuring Instruments

The measuring equipment is listed in the section 4 of this test report.

3.2.3 Test Procedures

1. The EUT was connected to spectrum analyzer and system simulator via a power divider.
2. The 26dB and 99% occupied bandwidth (BW) of the middle channel for the highest RF power with full RB sizes were measured.

3.2.4 Test Setup

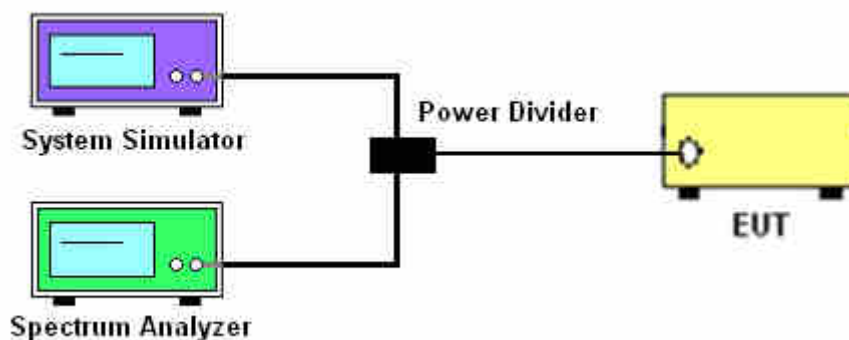

3.2.5 Test Result of 99% Occupied Bandwidth and 26dB Bandwidth

Please refer to Appendix A.



3.3 Emissions Mask Measurement

3.3.1 Description of Emissions Mask Measurement

Equipment used in this licensed to EA or non-EA systems shall comply with the emission mask provisions of FCC Part 90.691.(a):

(a) Out-of-band emission requirement shall apply only to the “outer” channels included in an EA license and to spectrum adjacent to interior channels used by incumbent licensees. The emission limits are as follows:

(1) For any frequency removed from the EA licensee's frequency block by up to and including 37.5 kHz, the power of any emission shall be attenuated below the transmitter power (P) in watts by at least $116 \text{ Log}_{10}(f/6.1)$ decibels or $50 + 10 \text{ Log}_{10}(P)$ decibels or 80 decibels, whichever is the lesser attenuation, where f is the frequency removed from the center of the outer channel in the block in kilohertz and where f is greater than 12.5 kHz.

(2) For any frequency removed from the EA licensee's frequency block greater than 37.5 kHz, the power of any emission shall be attenuated below the transmitter power (P) in watts by at least $43 + 10 \text{ Log}_{10}(P)$ decibels or 80 decibels, whichever is the lesser attenuation, where f is the frequency removed from the center of the outer channel in the block in kilohertz and where f is greater than 37.5 kHz.

3.3.2 Measuring Instruments

The measuring equipment is listed in the section 4 of this test report.

3.3.3 Test Procedures

1. The EUT was connected to spectrum analyzer and base station via power divider.
2. The emissions mask of low and high channels for the highest RF powers were measured.
3. The measured RBW and the VBW set 3 times of RBW are then set in spectrum analyzer, and the RBW correction factor $10 \text{ log} (1\% \text{ of OBW/measured RBW})(\text{dB})$ was compensated, if required.
4. The test results were shown below plots with a correction offset factor including cable loss, insertion loss of power divider.

3.3.4 Test Setup

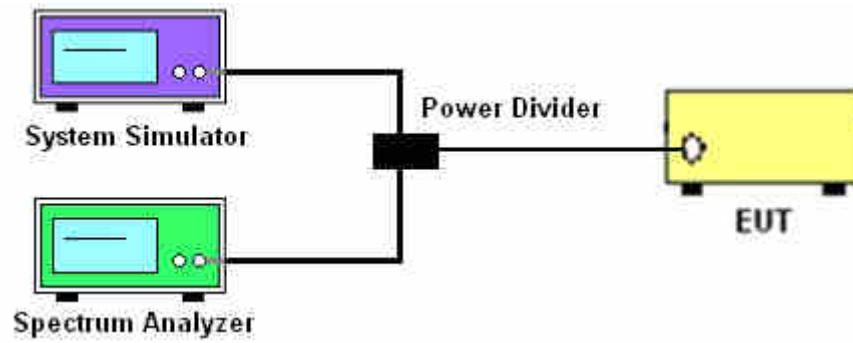

3.3.5 Test Result (Plots) of Conducted Emissions Mask

Please refer to Appendix A.

3.4 Emissions Mask – Out Of Band Emissions Measurement

3.4.1 Description of Conducted Emissions Out of band emissions measurement

The power of any emission FCC Part 90.691 (a)(2) on any frequency removed from the assigned frequency by out of the authorized bandwidth at least $43 + 10 \log (P)$ dB. It is measured by means of a calibrated spectrum analyzer and scanned from 30 MHz up to a frequency including its 10th harmonic.

3.4.2 Measuring Instruments

The measuring equipment is listed in the section 4 of this test report.

3.4.3 Test Procedures

1. The EUT was connected to spectrum analyzer and system simulator via a power divider.
2. The RF output of EUT was connected to the spectrum analyzer by RF cable and attenuator. The path loss was compensated to the results for each measurement.
3. The middle channel for the highest RF power within the transmitting frequency was measured.
4. The conducted spurious emission for the whole frequency range was taken.
5. Make the measurement with the spectrum analyzer's RBW = 1MHz, VBW = 3MHz, taking the record of maximum spurious emission.
6. The RF fundamental frequency should be excluded against the limit line in the operating frequency band.
7. The limit line is derived from $43 + 10\log(P)$ dB below the transmitter power P(Watts)

3.4.4 Test Setup

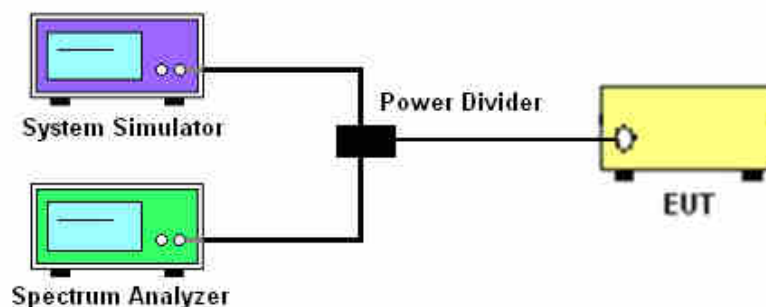

3.4.5 Test Result (Plots) of Conducted Emission

Please refer to Appendix A.



3.5 Field Strength of Spurious Radiation Measurement

3.5.1 Description of Field Strength of Spurious Radiated Measurement

The radiated spurious emission was measured by substitution method according to ANSI C63.26. The power of any emission FCC Part 90.691 on any frequency removed from the assigned frequency by more than 250 percent of the authorized bandwidth at least $43 + 10 \log(P)$ dB. The spectrum is scanned from 30 MHz up to a frequency including its 10th harmonic.

The power of any emission outside of the authorized operating frequency ranges must be attenuated below the transmitter power (P) by a factor of at least $43 + 10 \log_{10}(P[\text{Watts}])$ dB. The spectrum is scanned from 30 MHz up to a frequency including its 10th harmonic.

3.5.2 Measuring Instruments

The measuring equipment is listed in the section 4 of this test report.

3.5.3 Test Procedures

1. The EUT was placed on a turntable with 0.8 meter for frequency below 1GHz and 1.5 meter for frequency above 1GHz respectively above ground.
2. The EUT was set 3 meters from the receiving antenna, which was mounted on the antenna tower.
3. The table was rotated 360 degrees to determine the position of the highest spurious emission.
4. The height of the receiving antenna is varied between one meter and four meters to search the maximum spurious emission for both horizontal and vertical polarizations.
5. Make the measurement with the spectrum analyzer's RBW = 1MHz, VBW = 3MHz, Sweep = 500ms, Taking the record of maximum spurious emission.
6. A horn antenna was substituted in place of the EUT and was driven by a signal generator.
7. Tune the output power of signal generator to the same emission level with EUT maximum spurious emission.
8. Taking the record of output power at antenna port.
9. Repeat step 7 to step 8 for another polarization.
10. $\text{EIRP (dBm)} = \text{S.G. Power} - \text{Tx Cable Loss} + \text{Tx Antenna Gain}$
11. $\text{ERP (dBm)} = \text{EIRP} - 2.15$
12. The RF fundamental frequency should be excluded against the limit line in the operating frequency band.
13. The limit line is derived from $43 + 10 \log(P)$ dB below the transmitter power P(Watts)

3.5.4 Test Setup

For radiated test from 30MHz to 1GHz

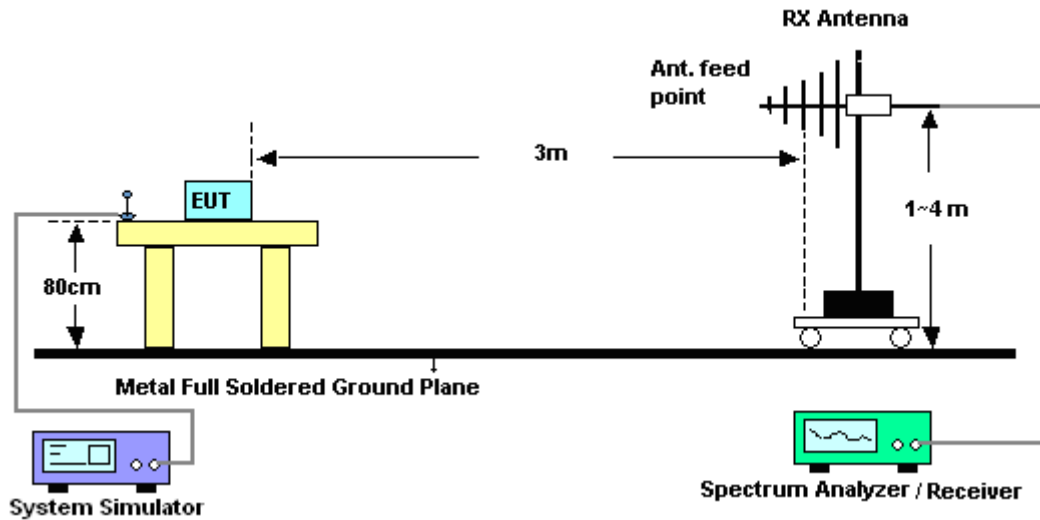

For radiated test above 1GHz

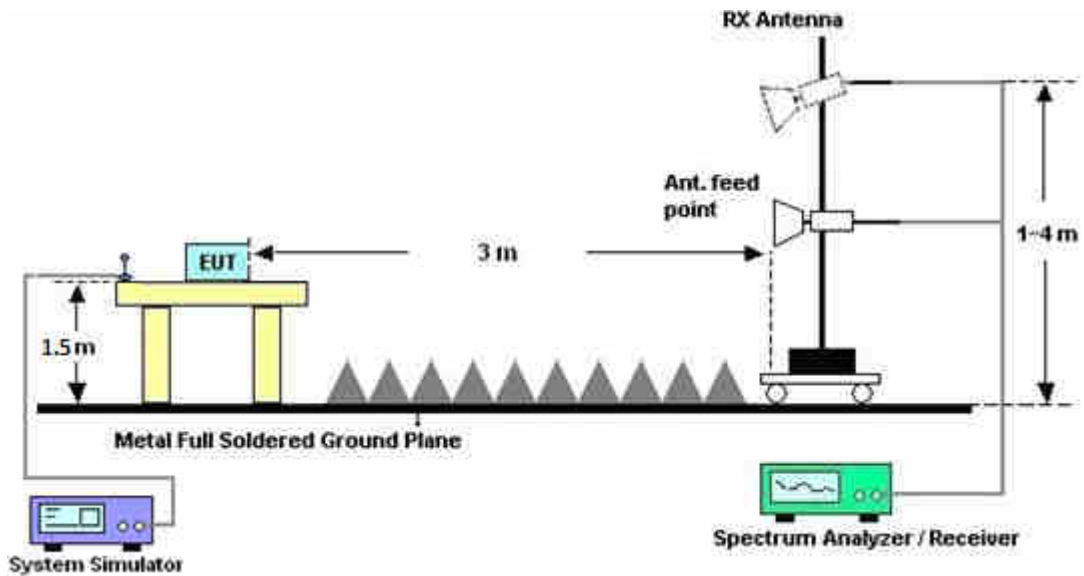

3.5.5 Test Result of Field Strength of Spurious Radiated

Please refer to Appendix B.



3.6 Frequency Stability Measurement

3.6.1 Description of Frequency Stability Measurement

The frequency stability shall be measured by variation of ambient temperature and variation of primary supply voltage to ensure that the fundamental emission stays within the authorized frequency block. The frequency stability of the transmitter shall be maintained within $\pm 0.00025\%$ ($\pm 2.5\text{ppm}$) of the center frequency according to FCC Part 90.213.

3.6.2 Measuring Instruments

The measuring equipment is listed in the section 4 of this test report.

3.6.3 Test Procedures for Temperature Variation

1. The EUT was set up in the thermal chamber and connected with the base station.
2. With power OFF, the temperature was decreased to -30°C and the EUT was stabilized for three hours. Power was applied and the maximum change in frequency was recorded within one minute.
3. With power OFF, the temperature was raised in 10°C step up to 50°C . The EUT was stabilized at each step for at least half an hour. Power was applied and the maximum frequency change was recorded within one minute.

3.6.4 Test Procedures for Voltage Variation

1. The EUT was placed in a temperature chamber at $20\pm 5^{\circ}\text{C}$ and connected with the system simulator.
2. The power supply voltage to the EUT was varied from 85% to 115% of the nominal value for other than hand carried battery equipment.
3. For hand carried, battery powered equipment, reduce the primary ac or dc supply voltage to the battery operating end point, which shall be specified by the manufacturer.
4. The variation in frequency was measured for the worst case.

3.6.5 Test Setup

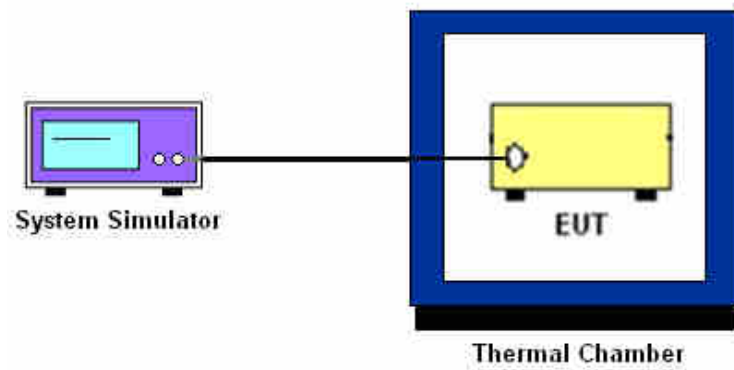

3.6.6 Test Result of Temperature Variation

Please refer to Appendix A.



4 List of Measuring Equipment

Instrument	Manufacturer	Model No.	Serial No.	Characteristics	Calibration Date	Test Date	Due Date	Remark
Spectrum Analyzer	R&S	FSV40	101040	10Hz~40GHz	Nov. 02, 2019	Jan. 26, 2020	Nov. 01, 2020	Conducted (TH01-KS)
Thermal Chamber	Ten Billion	TTC-B3S	TBN-960502	-40~+150°C	Nov. 19, 2019	Jan. 26, 2020	Nov. 18, 2020	Conducted (TH01-KS)
EXA Spectrum Analyzer	KEYSIGHT	N9010A	MY5515021 3	10Hz~44GHz	Apr. 18, 2019	Jan. 12, 2020	Apr. 17, 2020	Radiation (03CH04-SZ)
Bilog Antenna	TeseQ	CBL6111D	41909	30MHz~1GHz	Aug. 27, 2019	Jan. 12, 2020	Aug. 26, 2020	Radiation (03CH04-SZ)
Double Ridge Horn Antenna	SCHWARZBECK	BBHA9120D	9120D-1474	1GHz~18GHz	Apr. 01, 2019	Jan. 12, 2020	Mar. 31, 2020	Radiation (03CH04-SZ)
Horn Antenna	SCHWARZBECK	BBHA9170	9170#679	15GHz~40GHz	Apr. 19, 2019	Jan. 12, 2020	Apr. 18, 2020	Radiation (03CH04-SZ)
Amplifier	Burgeon	BPA-530	102211	0.01Hz~3000MHz	Oct. 18, 2019	Jan. 12, 2020	Oct. 17, 2020	Radiation (03CH04-SZ)
HF Amplifier	MITEQ	AMF-7D-00 101800-30- 10P-R	1943528	1GHz~18GHz	Oct. 18, 2019	Jan. 12, 2020	Oct. 17, 2020	Radiation (03CH04-SZ)
HF Amplifier	MITEQ	TTA1840-35 -HG	1871923	18GHz~40GHz	Jul. 22, 2019	Jan. 12, 2020	Jul. 21, 2020	Radiation (03CH04-SZ)
Amplifier	Agilent Technologies	83017A	MY5327015 6	500MHz~26.5G Hz	Aug. 26, 2019	Jan. 12, 2020	Aug. 25, 2020	Radiation (03CH04-SZ)
AC Power Source	Chroma	61601	N/A	N/A	NCR	Jan. 12, 2020	NCR	Radiation (03CH04-SZ)
Turn Table	EM	EM1000	N/A	0~360 degree	NCR	Jan. 12, 2020	NCR	Radiation (03CH04-SZ)
Antenna Mast	EM	EM1000	N/A	1 m~4 m	NCR	Jan. 12, 2020	NCR	Radiation (03CH04-SZ)

NCR: No Calibration Required



5 Uncertainty of Evaluation

The measurement uncertainties shown below were calculated in accordance with the requirements of ANSI 63.26-2015. All the measurement uncertainty value were shown with a coverage K=2 to indicate 95% level of confidence. The measurement data show herein meets or exceeds the CISPR measurement uncertainty values specified in CISPR 16-4-2 and can be compared directly to specified limit to determine compliance.

Uncertainty of Radiated Emission Measurement (30 MHz ~ 1000 MHz)

Measuring Uncertainty for a Level of Confidence of 95% (U = 2Uc(y))	2.8dB
---	-------

Uncertainty of Radiated Emission Measurement (1 GHz ~ 18 GHz)

Measuring Uncertainty for a Level of Confidence of 95% (U = 2Uc(y))	3.1dB
---	-------

Uncertainty of Radiated Emission Measurement (18 GHz ~ 40 GHz)

Measuring Uncertainty for a Level of Confidence of 95% (U = 2Uc(y))	3.9dB
---	-------



Appendix A. Test Results of Conducted Test

Conducted Output Power (Average power)

LTE Band 26 Maximum Average Power [dBm]						
BW [MHz]	RB Size	RB Offset	Mod	Lowest	Middle	Highest
15	1	0	QPSK	23.11		
15	1	37		23.08		
15	1	74		23.10		
15	36	0		22.05		
15	36	20		21.97		
15	36	39		22.01		
15	75	0		22.08		
15	1	0	16-QAM	22.89		
15	1	37		22.50		
15	1	74		22.48		
15	36	0		20.88		
15	36	20		20.92		
15	36	39		21.05		
15	75	0		21.16		



LTE Band 26 Maximum Average Power [dBm]						
BW [MHz]	RB Size	RB Offset	Mod	Lowest	Middle	Highest
10	1	0	QPSK		23.26	
10	1	25			23.10	
10	1	49			23.06	
10	25	0			22.06	
10	25	12			22.19	
10	25	25			22.05	
10	50	0			22.15	
10	1	0	16-QAM		22.46	
10	1	25			22.02	
10	1	49			22.23	
10	25	0			20.97	
10	25	12			21.20	
10	25	25			20.96	
10	50	0			21.02	
5	1	0	QPSK	23.10	23.36	23.38
5	1	12		23.07	23.27	23.40
5	1	24		22.97	23.36	23.02
5	12	0		21.99	22.02	22.27
5	12	7		21.86	22.07	22.07
5	12	13		21.83	22.05	22.02
5	25	0		21.93	22.06	22.24
5	1	0	16-QAM	22.48	22.45	22.23
5	1	12		22.13	22.19	22.26
5	1	24		22.40	22.19	22.47
5	12	0		20.98	21.06	21.11
5	12	7		20.91	20.99	21.00
5	12	13		20.82	21.17	20.99
5	25	0		21.07	21.26	21.23



LTE Band 26 Maximum Average Power [dBm]						
BW [MHz]	RB Size	RB Offset	Mod	Lowest	Middle	Highest
3	1	0	QPSK	23.12	23.33	23.37
3	1	8		22.93	23.19	23.03
3	1	14		22.98	23.31	23.02
3	8	0		22.10	22.19	22.33
3	8	4		21.95	22.02	22.18
3	8	7		21.97	22.07	22.12
3	15	0		21.93	22.23	22.21
3	1	0	16-QAM	22.30	22.22	22.33
3	1	8		22.03	22.11	22.09
3	1	14		22.48	22.45	22.07
3	8	0		21.06	21.28	21.27
3	8	4		20.93	21.35	21.24
3	8	7		20.94	21.21	20.98
3	15	0		20.66	20.94	20.88
1.4	1	0	QPSK	22.90	23.13	23.05
1.4	1	3		22.93	23.05	23.10
1.4	1	5		22.76	22.95	22.89
1.4	3	0		22.96	23.05	23.14
1.4	3	1		22.98	23.13	23.20
1.4	3	3		22.95	23.10	23.07
1.4	6	0		21.98	22.21	22.28
1.4	1	0	16-QAM	21.85	21.99	21.86
1.4	1	3		21.89	21.96	21.92
1.4	1	5		22.00	21.86	21.70
1.4	3	0		22.23	22.28	21.98
1.4	3	1		22.10	22.31	22.09
1.4	3	3		22.01	22.33	21.87
1.4	6	0		20.85	21.08	20.79



26dB Bandwidth

Mode	LTE Band 26 : 26dB BW(MHz)									
	1.4MHz		3MHz		5MHz		10MHz		15MHz	
BW										
Mod.	QPSK	16QAM	QPSK	16QAM	QPSK	16QAM	QPSK	16QAM	QPSK	16QAM
Lowest CH	1.301	1.250	3.003	3.033	4.995	4.935	-	-	14.236	14.356
Middle CH	1.298	1.273	2.997	3.045	4.905	4.925	9.79	10.07	-	-
Highest CH	1.284	1.301	3.081	3.075	4.985	4.905	-	-	-	-



LTE Band 26

Lowest Channel / 1.4MHz / QPSK

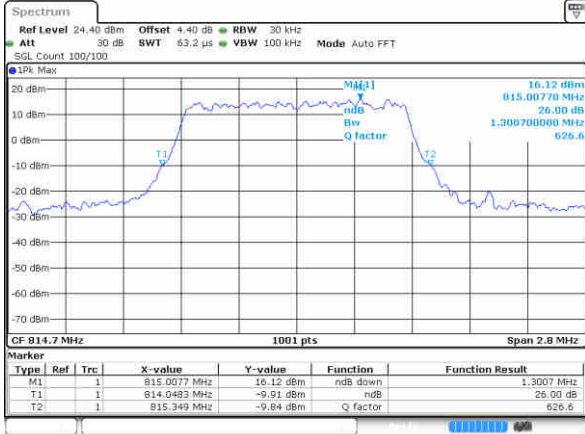

Lowest Channel / 1.4MHz / 16QAM

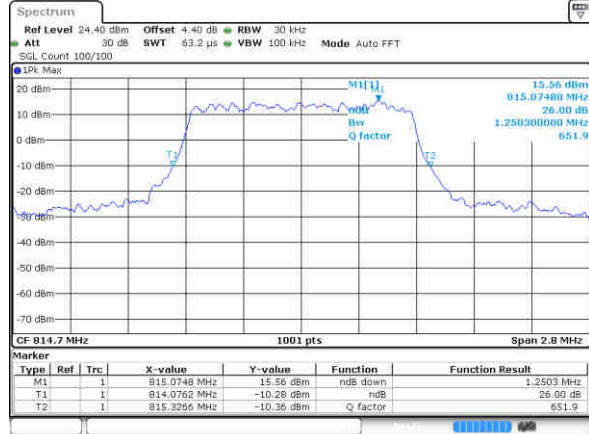

Middle Channel / 1.4MHz / QPSK

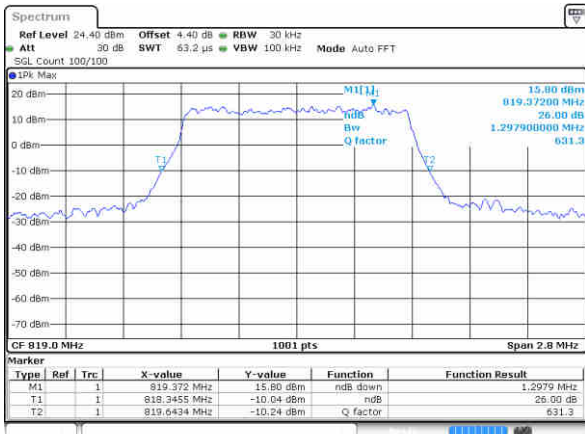

Middle Channel / 1.4MHz / 16QAM



Highest Channel / 1.4MHz / QPSK

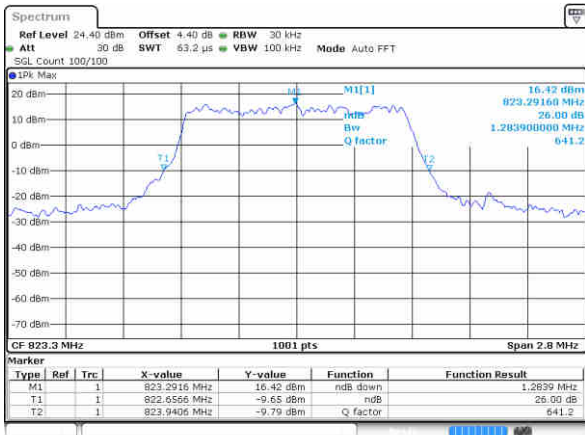

Highest Channel / 1.4MHz / 16QAM

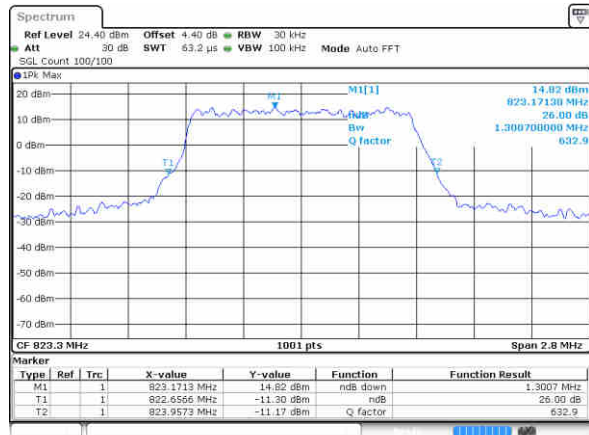



LTE Band 26

Lowest Channel / 3MHz / QPSK

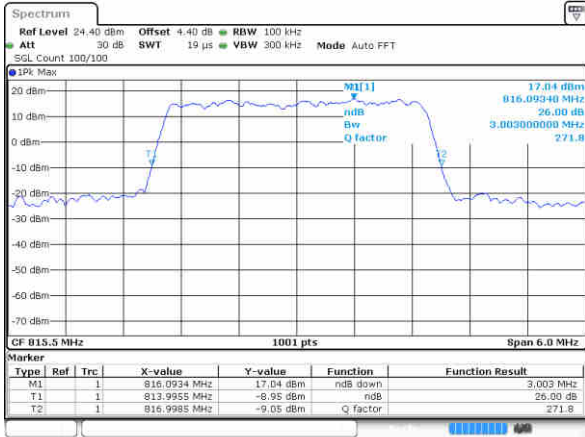

Lowest Channel / 3MHz / 16QAM

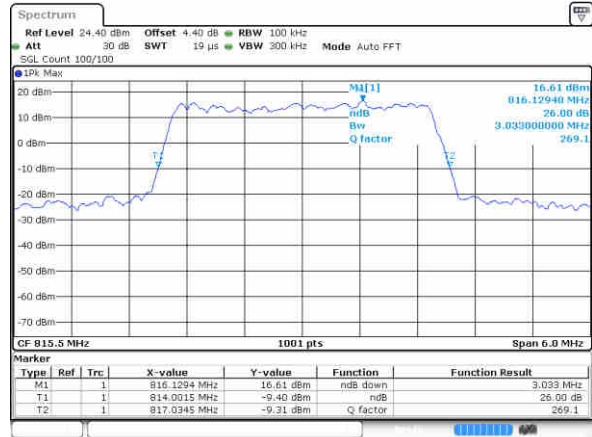

Middle Channel / 3MHz / QPSK

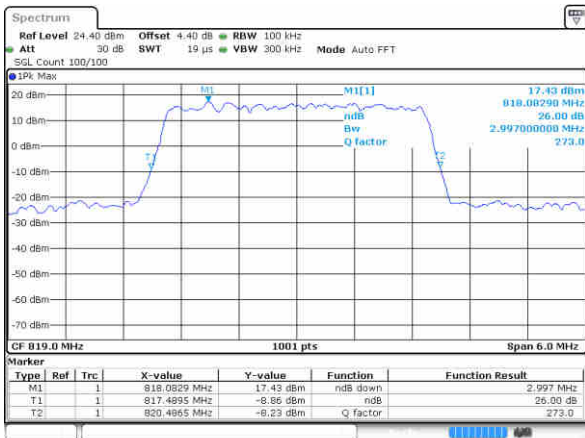

Middle Channel / 3MHz / 16QAM

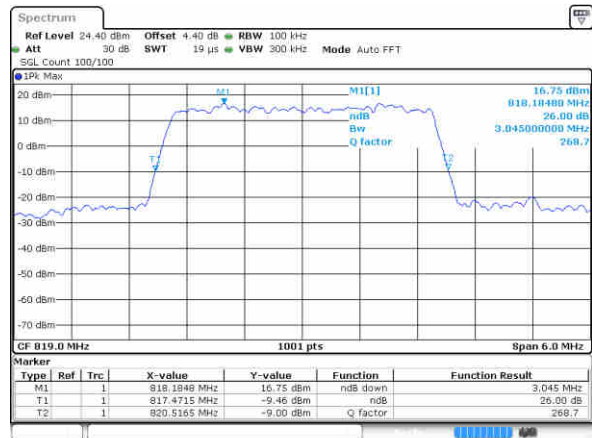

Highest Channel / 3MHz / QPSK

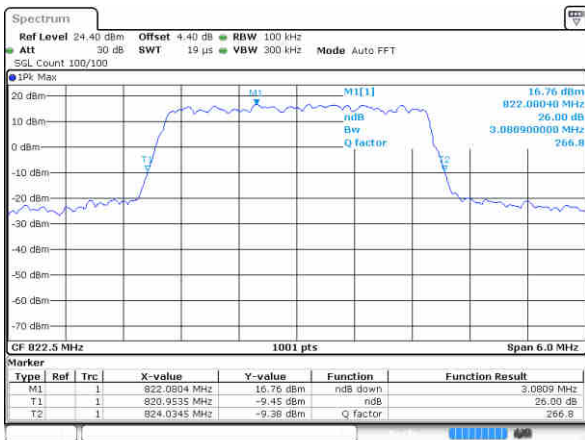

Highest Channel / 3MHz / 16QAM

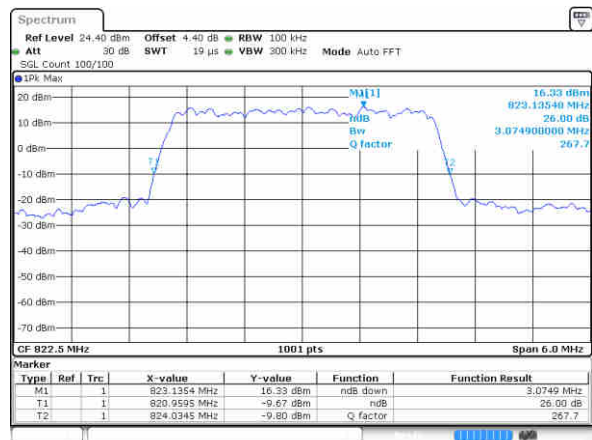



LTE Band 26

Lowest Channel / 5MHz / QPSK

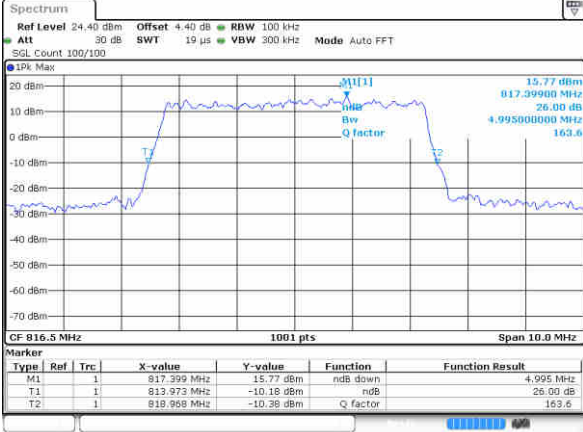

Lowest Channel / 5MHz / 16QAM

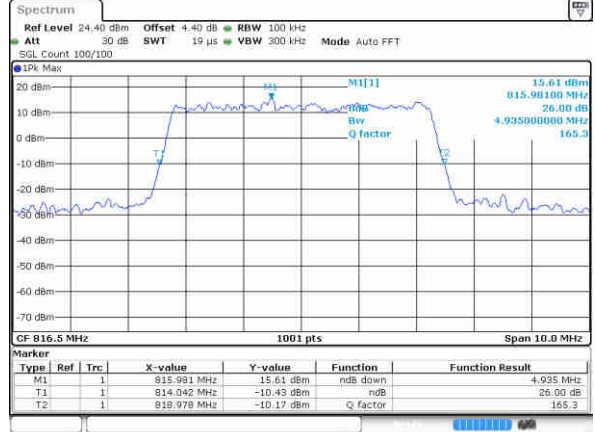

Middle Channel / 5MHz / QPSK

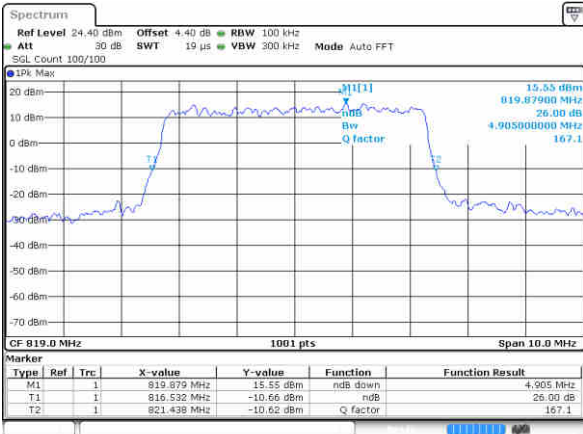

Middle Channel / 5MHz / 16QAM

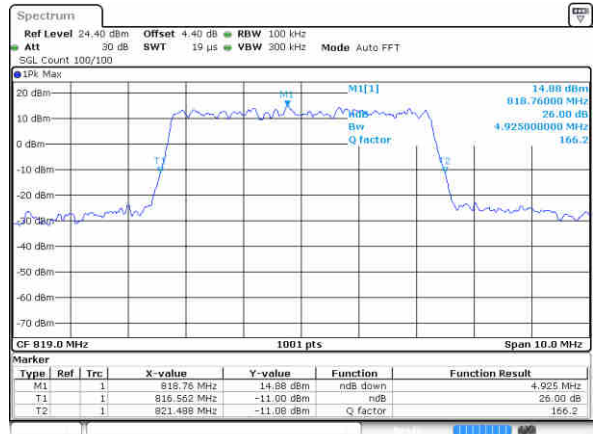

Highest Channel / 5MHz / QPSK

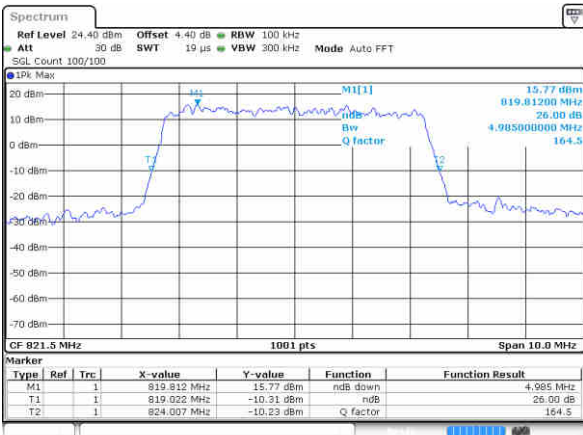

Highest Channel / 5MHz / 16QAM

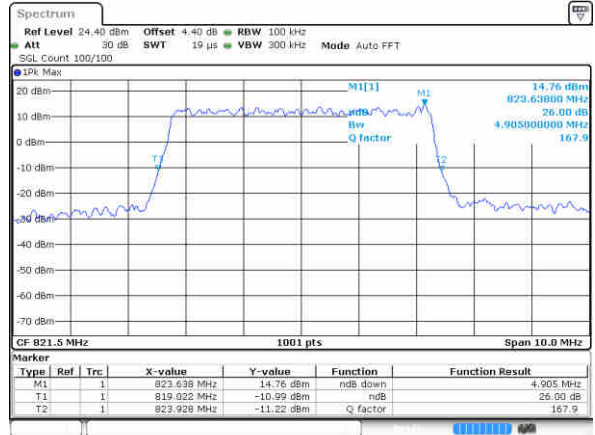



LTE Band 26

Middle Channel / 10MHz / QPSK

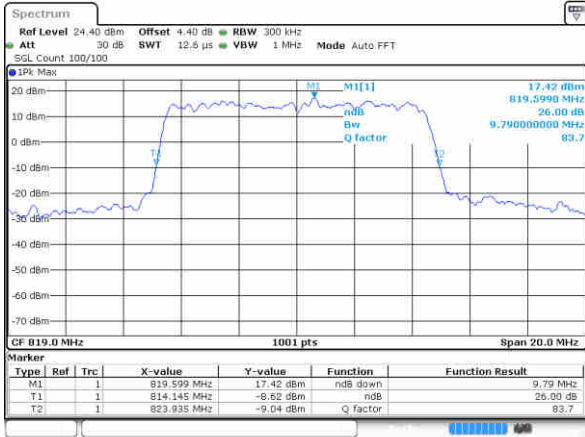

Middle Channel / 10MHz / 16QAM

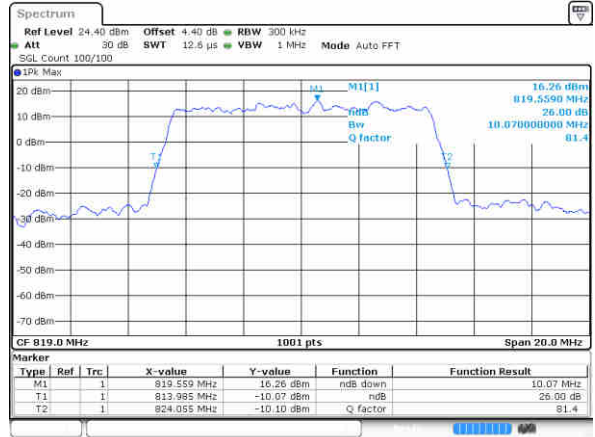

Lowest Channel / 15MHz / QPSK



Lowest Channel / 15MHz / 16QAM

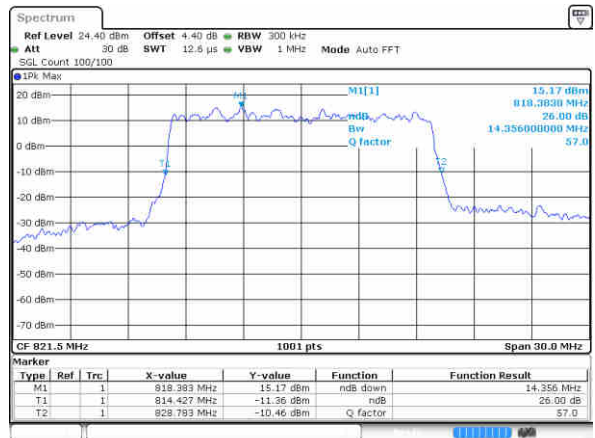



Occupied Bandwidth

Mode	LTE Band 26 : 99%OBW(MHz)									
	1.4MHz		3MHz		5MHz		10MHz		15MHz	
BW										
Mod.	QPSK	16QAM	QPSK	16QAM	QPSK	16QAM	QPSK	16QAM	QPSK	16QAM
Lowest CH	1.099	1.097	2.727	2.709	4.496	4.486	-	-	13.457	13.367
Middle CH	1.094	1.085	2.721	2.715	4.515	4.496	9.071	9.031	-	-
Highest CH	1.085	1.091	2.715	2.721	4.496	4.496	-	-	-	-



LTE Band 26

Lowest Channel / 1.4MHz / QPSK

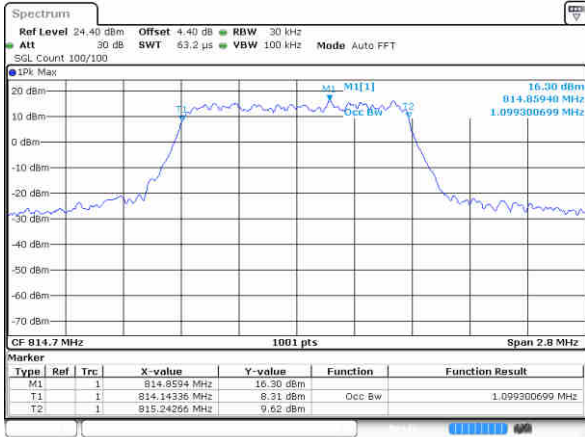

Lowest Channel / 1.4MHz / 16QAM

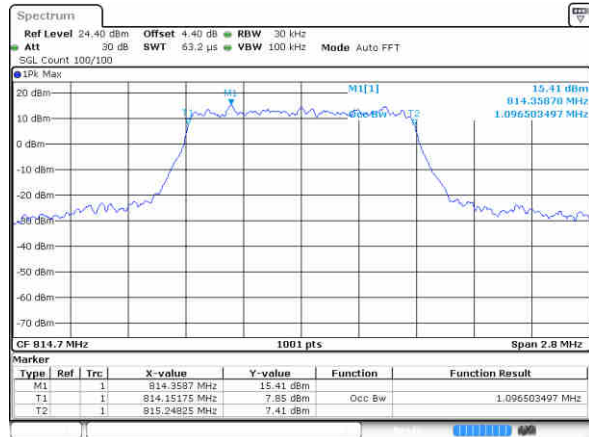

Middle Channel / 1.4MHz / QPSK

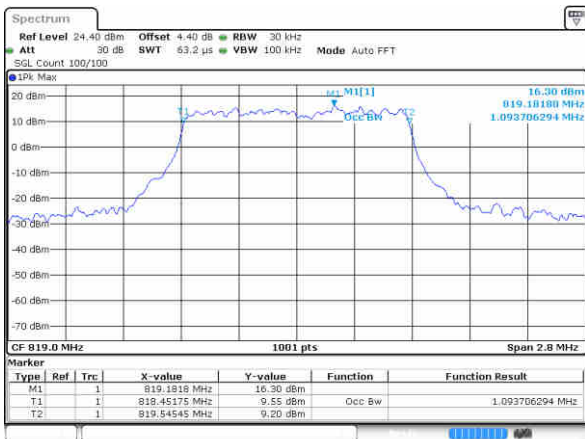

Middle Channel / 1.4MHz / 16QAM

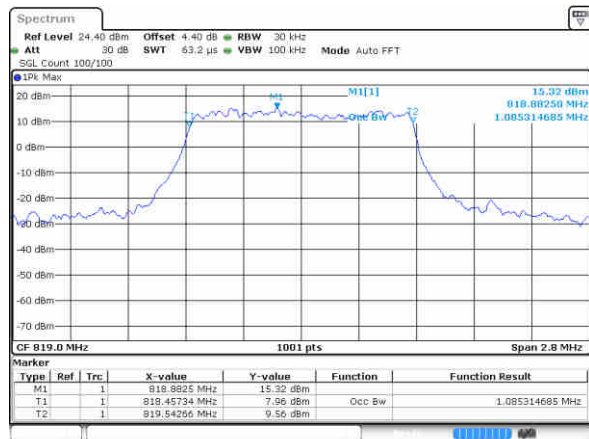

Highest Channel / 1.4MHz / QPSK

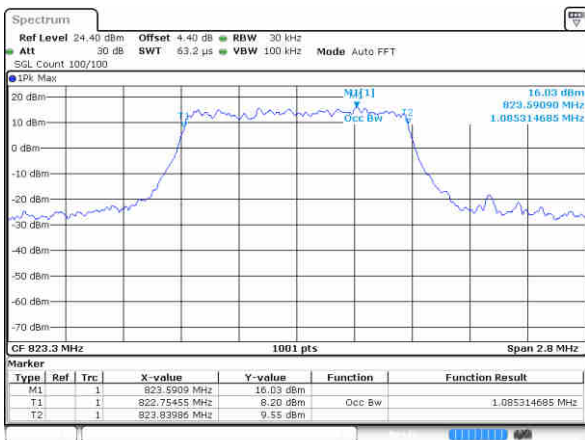

Highest Channel / 1.4MHz / 16QAM

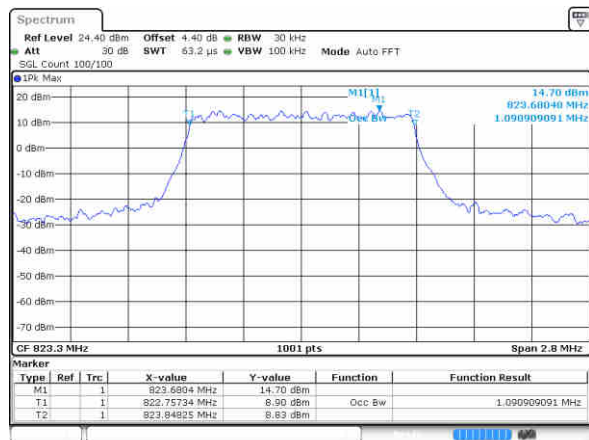



LTE Band 26

Lowest Channel / 3MHz / QPSK

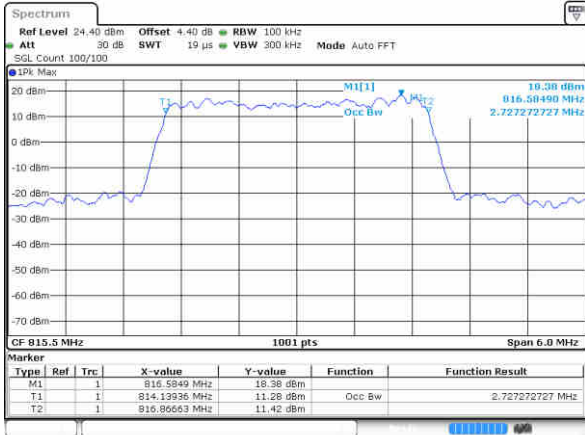

Lowest Channel / 3MHz / 16QAM

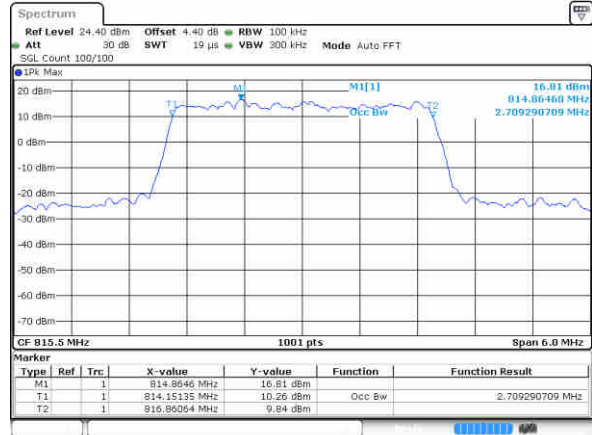

Middle Channel / 3MHz / QPSK

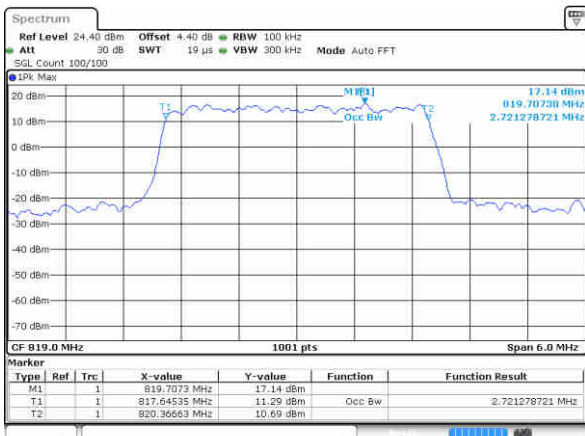

Middle Channel / 3MHz / 16QAM

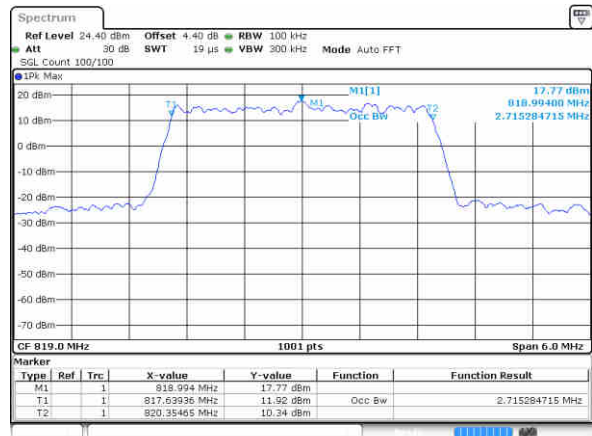

Highest Channel / 3MHz / QPSK

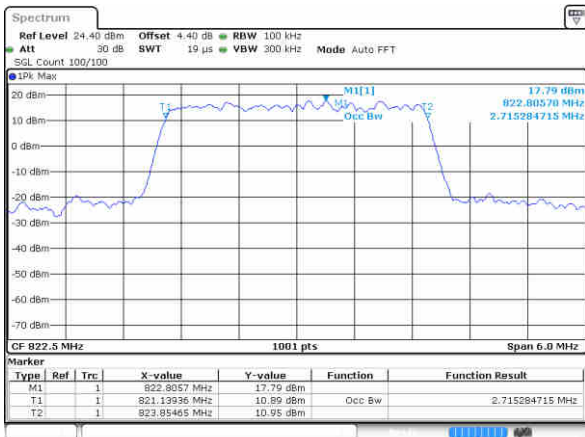

Highest Channel / 3MHz / 16QAM

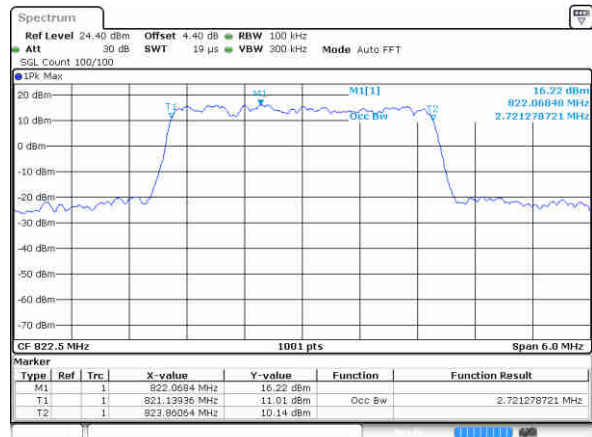



LTE Band 26

Lowest Channel / 5MHz / QPSK

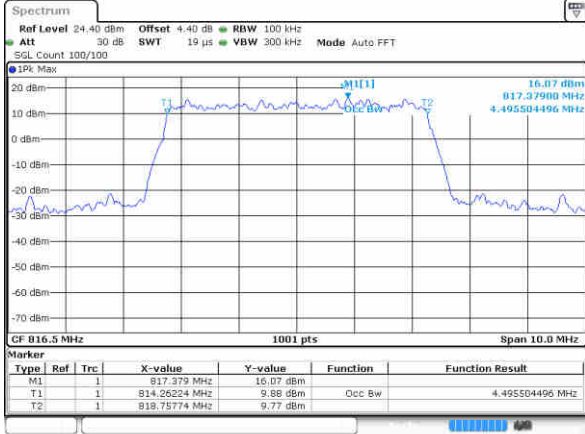

Lowest Channel / 5MHz / 16QAM

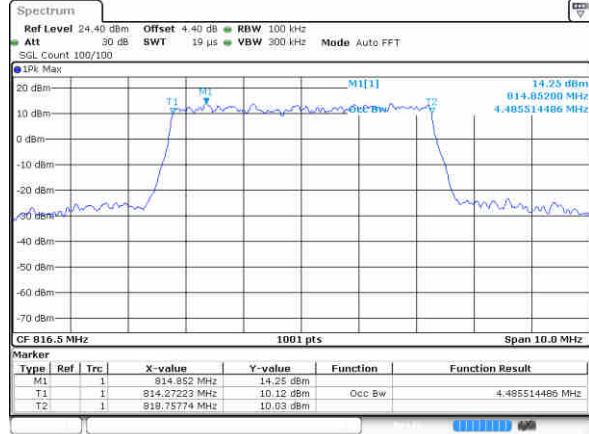

Middle Channel / 5MHz / QPSK

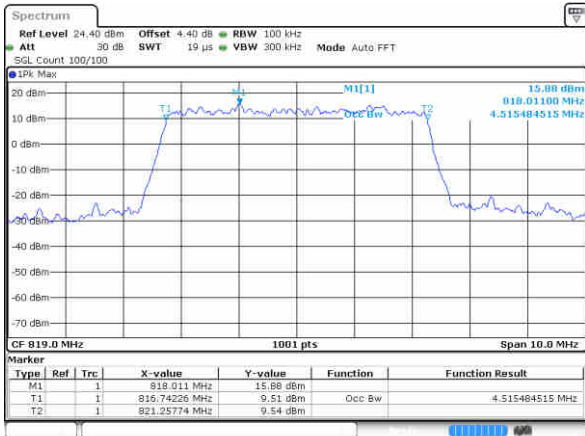

Middle Channel / 5MHz / 16QAM

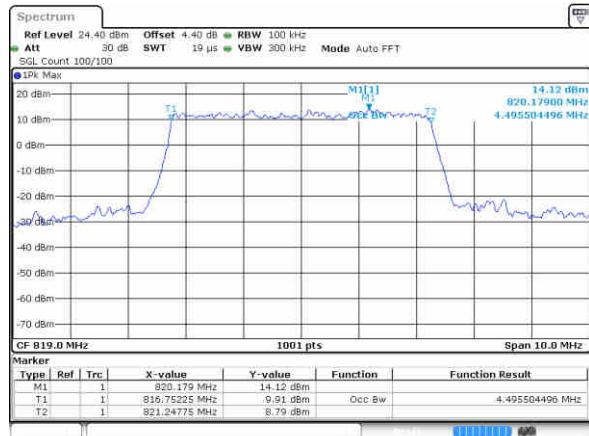

Highest Channel / 5MHz / QPSK

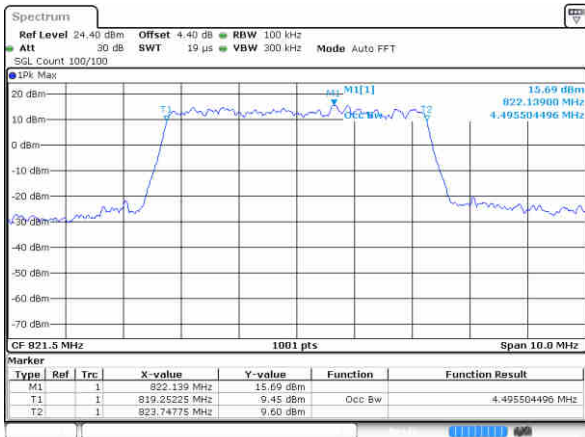

Highest Channel / 5MHz / 16QAM

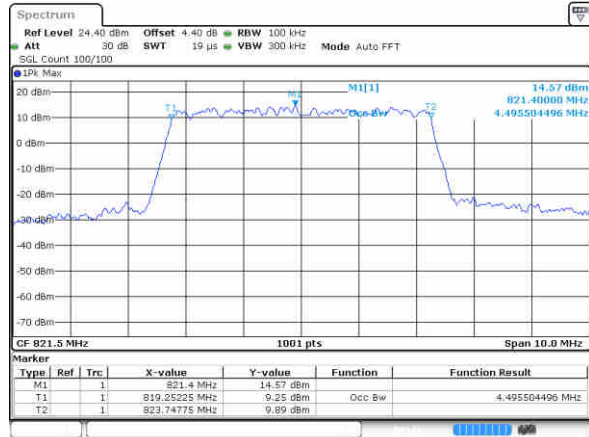



LTE Band 26

Middle Channel / 10MHz / QPSK

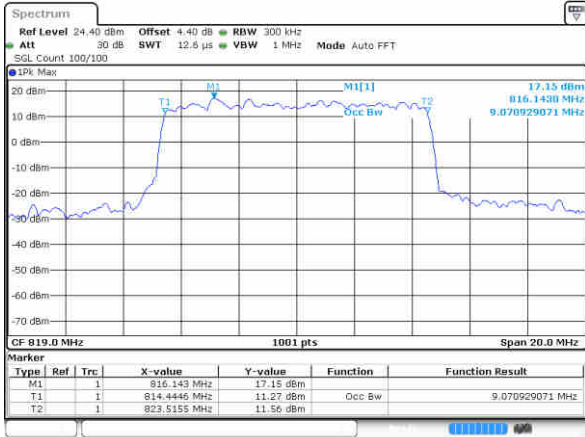

Middle Channel / 10MHz / 16QAM

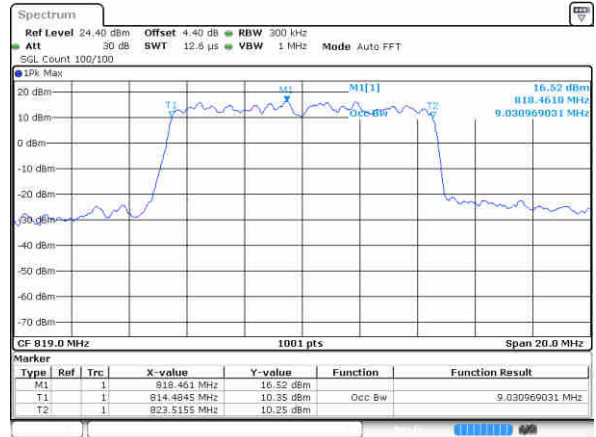

LTE Band 26

Lowest Channel / 15MHz / QPSK

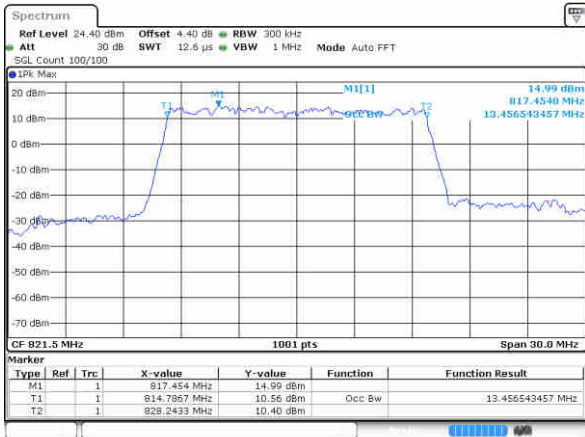

Lowest Channel / 15MHz / 16QAM

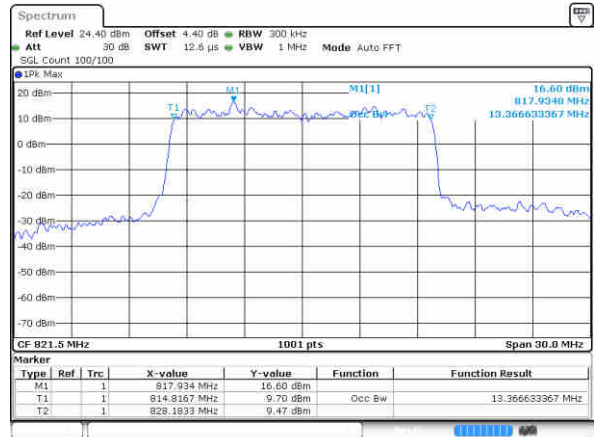



Conducted Band Edge

LTE Band 26 / 1.4MHz / QPSK

Lowest Band Edge / 1RB

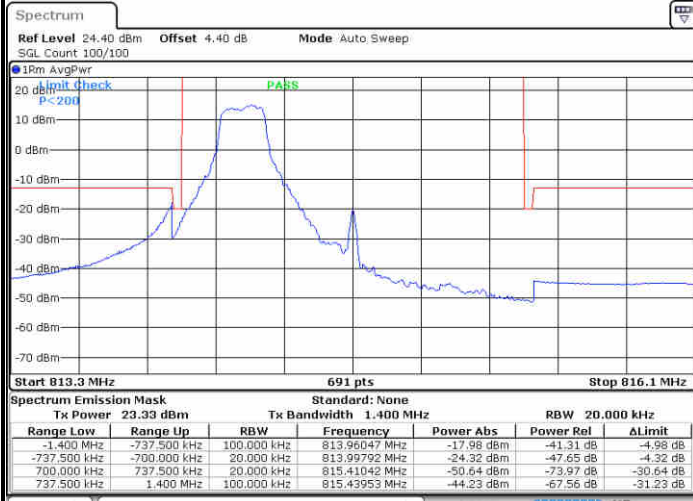

Highest Band Edge / 1RB

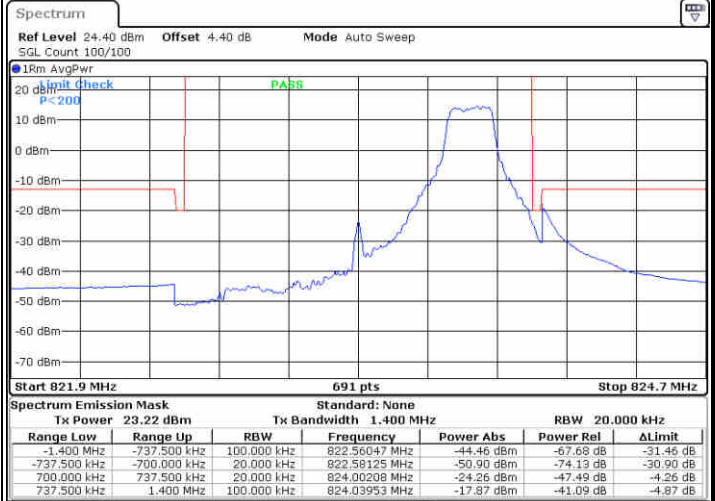

Lowest Band Edge / Full RB

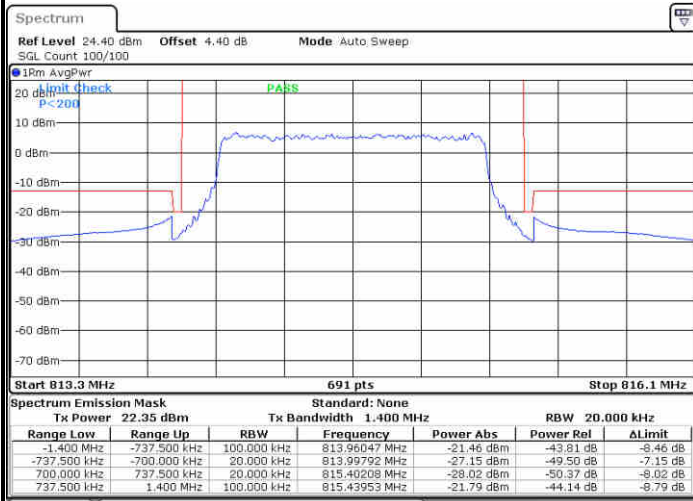

Highest Band Edge / Full RB

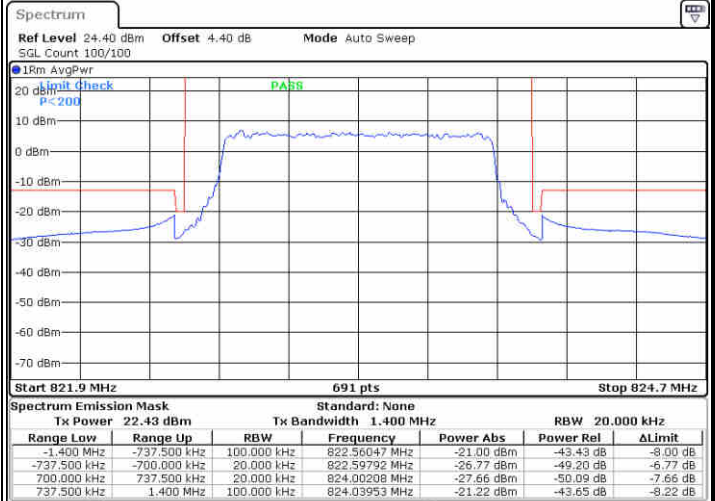



LTE Band 26 / 1.4MHz / 16QAM

Lowest Band Edge / 1 RB

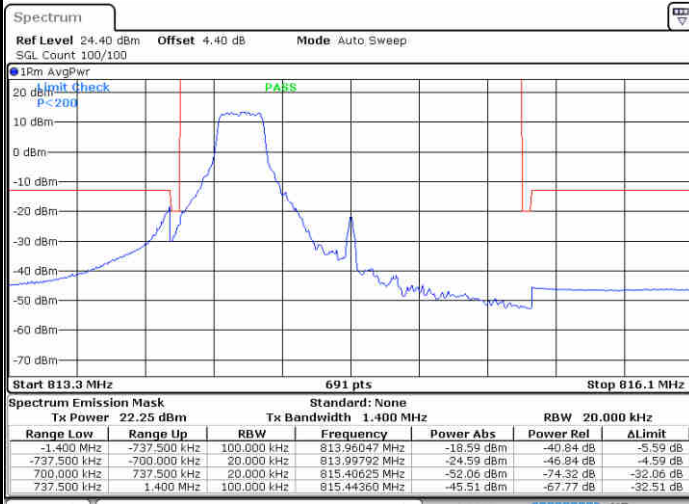

Highest Band Edge / 1 RB

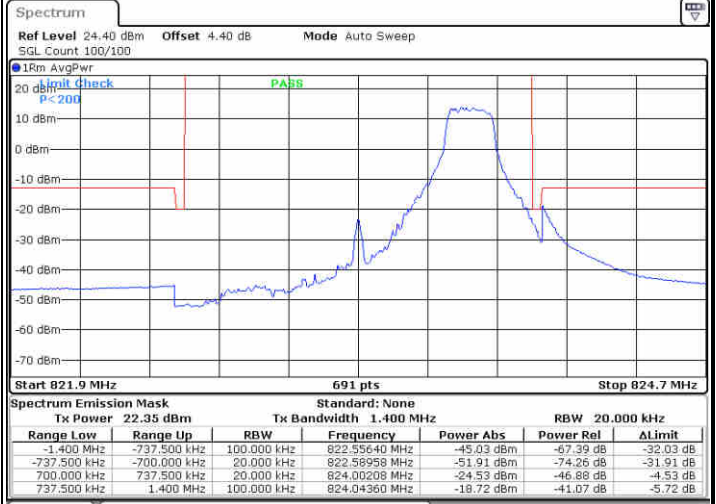

Lowest Band Edge / Full RB

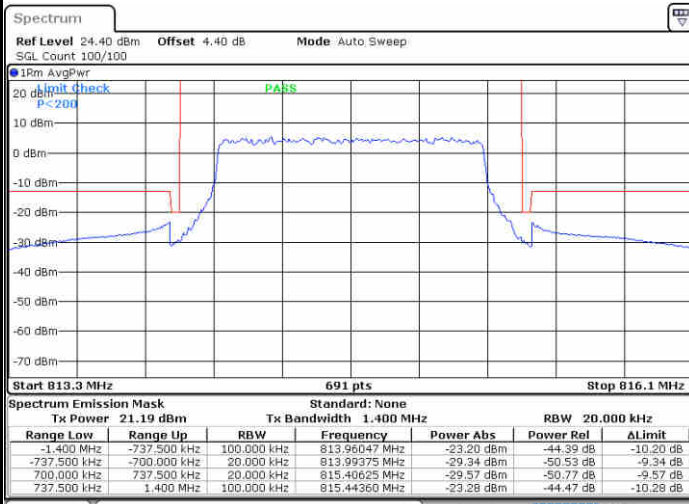

Highest Band Edge / Full RB

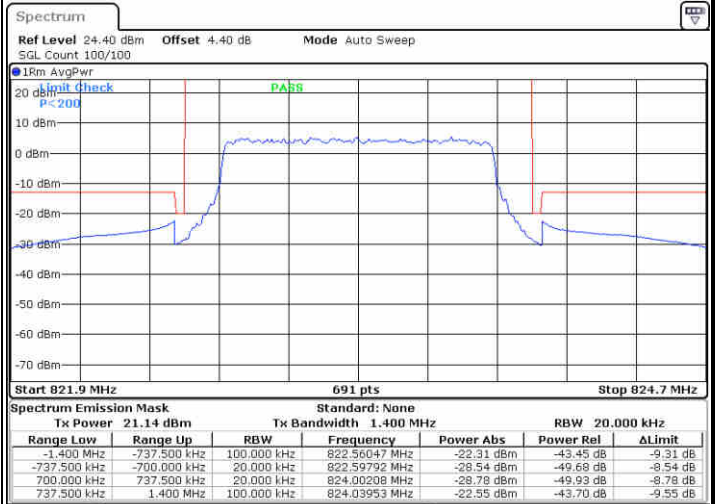



LTE Band 26 / 3MHz / QPSK

Lowest Band Edge / 1RB

Highest Band Edge / 1 RB

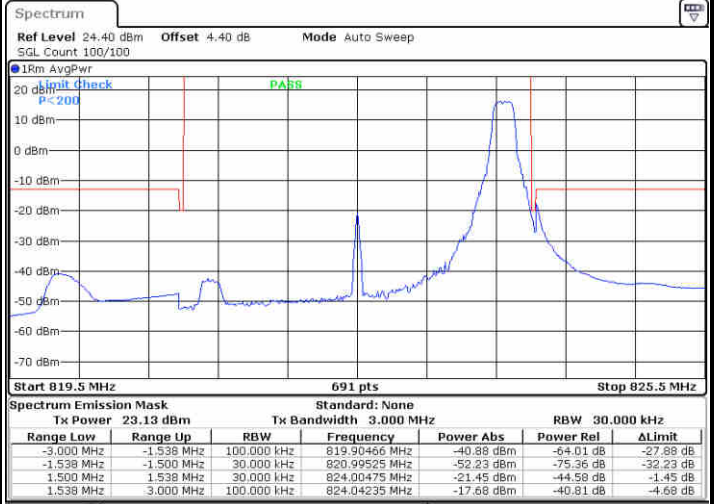
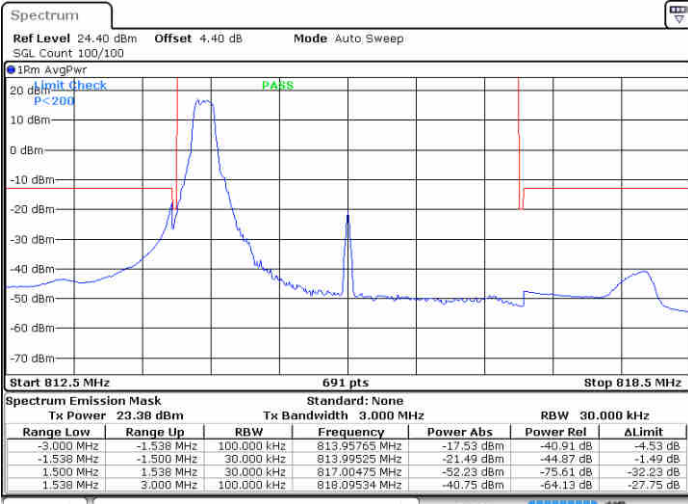

Lowest Band Edge / Full RB

Highest Band Edge / Full RB

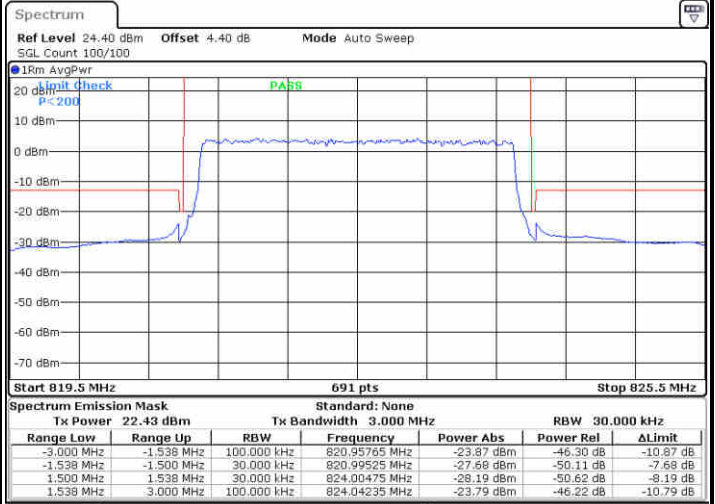
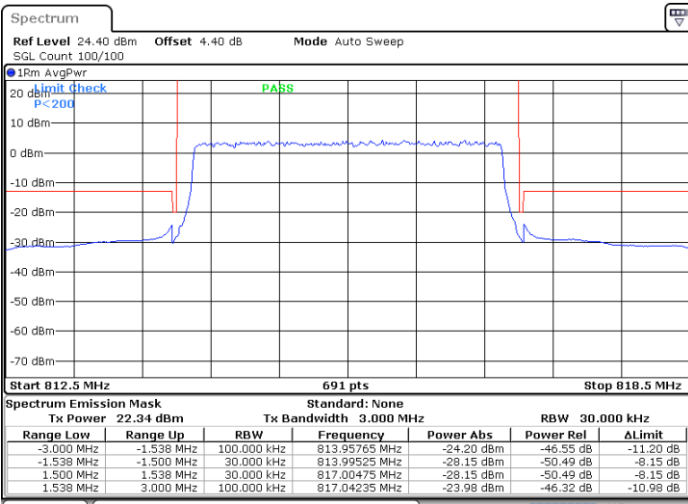



LTE Band 26 / 3MHz / 16QAM

Lowest Band Edge / 1 RB

Highest Band Edge / 1 RB

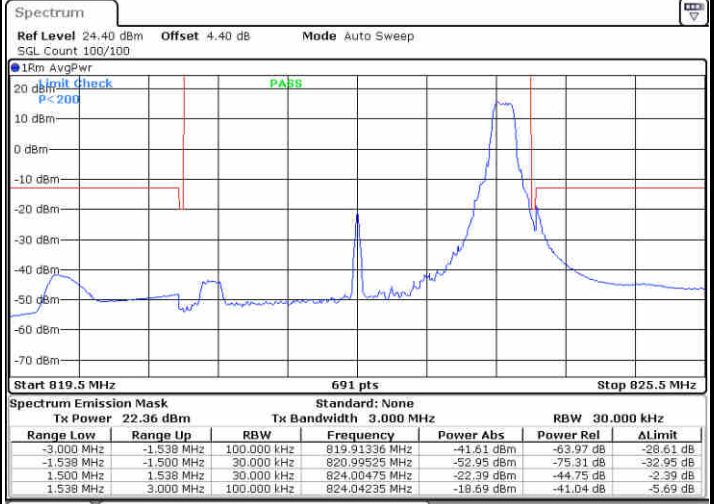
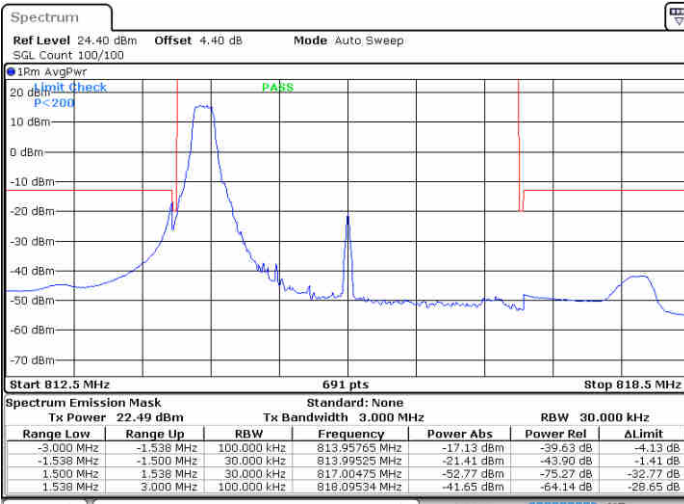

Lowest Band Edge / Full RB

Highest Band Edge / Full RB

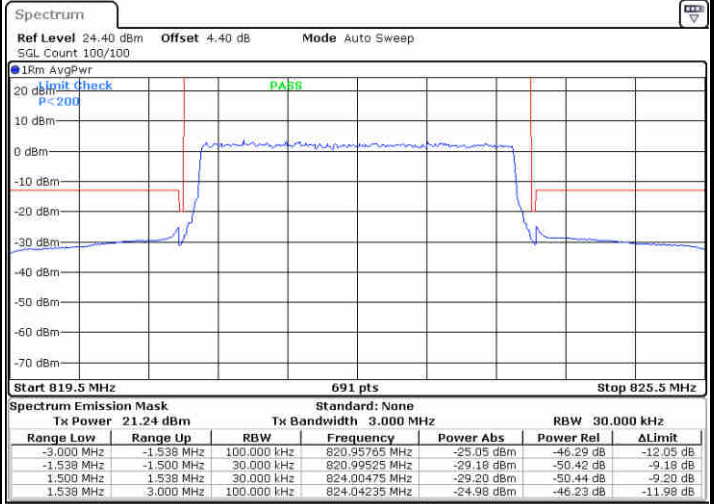
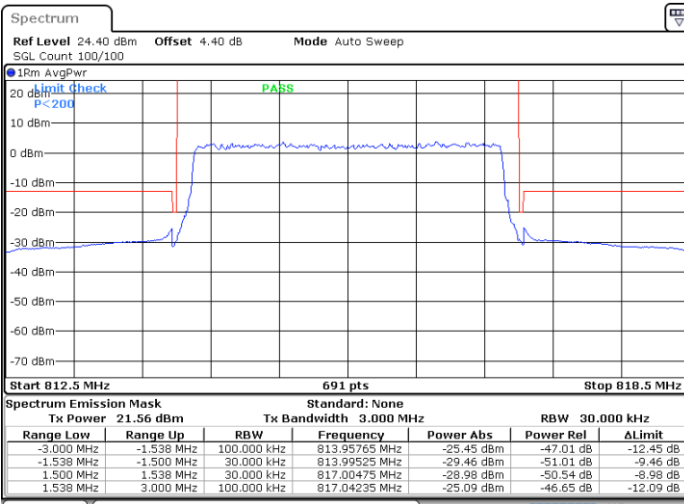



LTE Band 26 / 5MHz / QPSK

Lowest Band Edge / 1 RB

Highest Band Edge / 1 RB

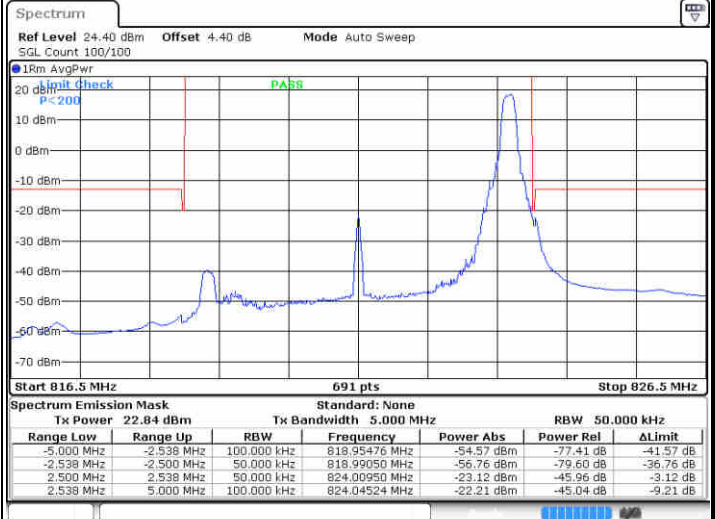
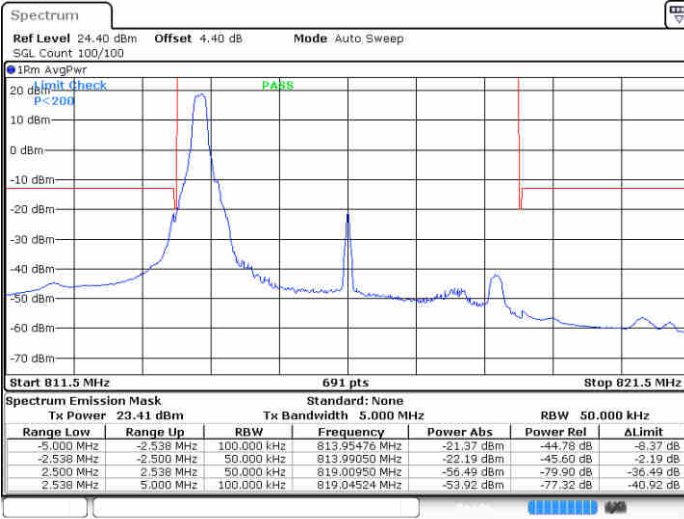

Lowest Band Edge / Full RB

Highest Band Edge / Full RB

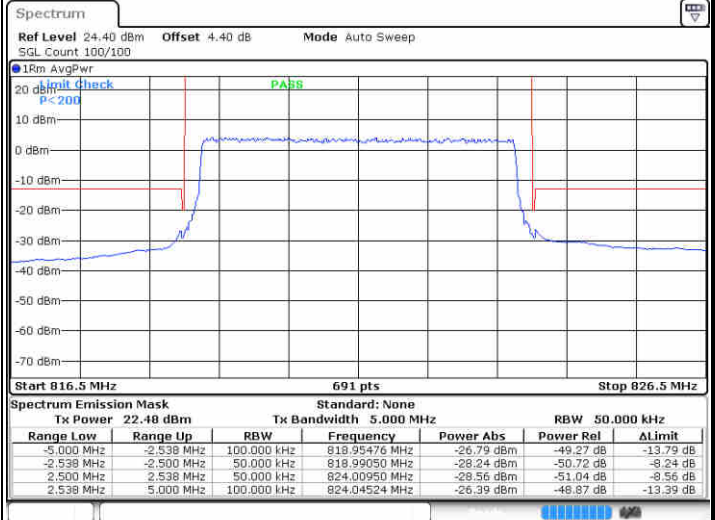
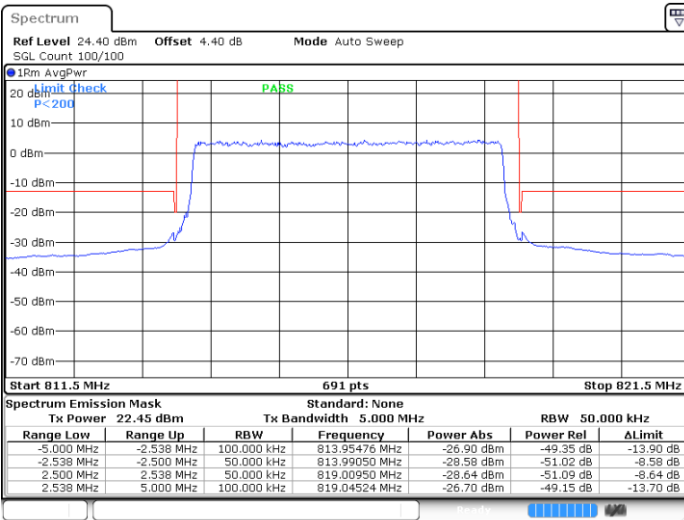



LTE Band 26 / 5MHz / 16QAM

Lowest Band Edge / 1RB

Highest Band Edge / 1 RB

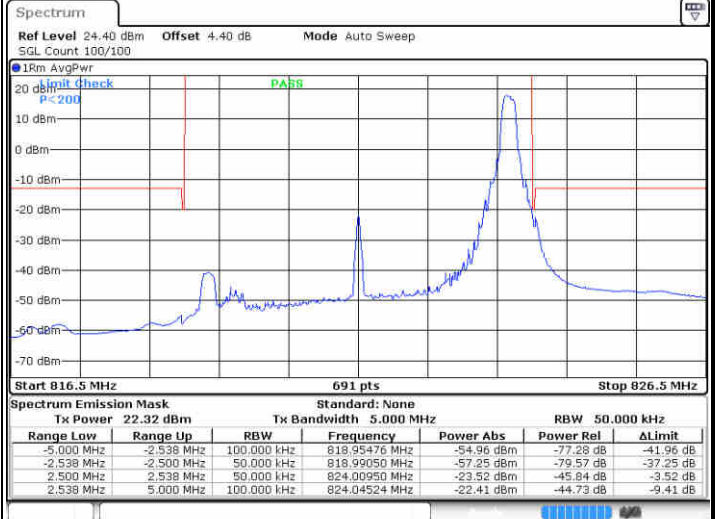
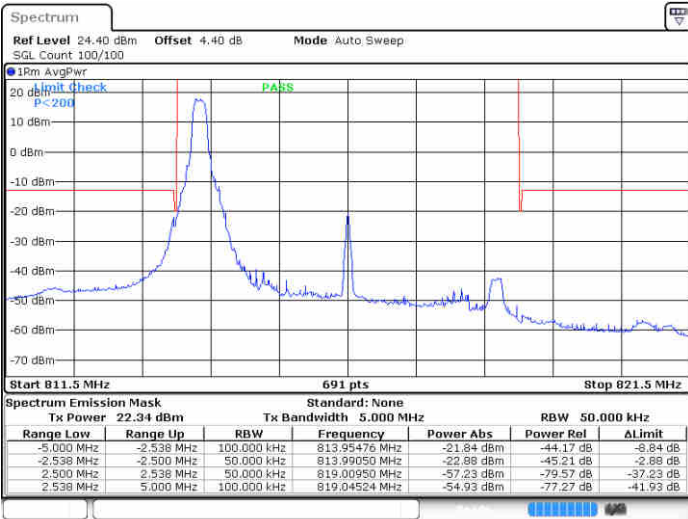

Lowest Band Edge / Full RB

Highest Band Edge / Full RB

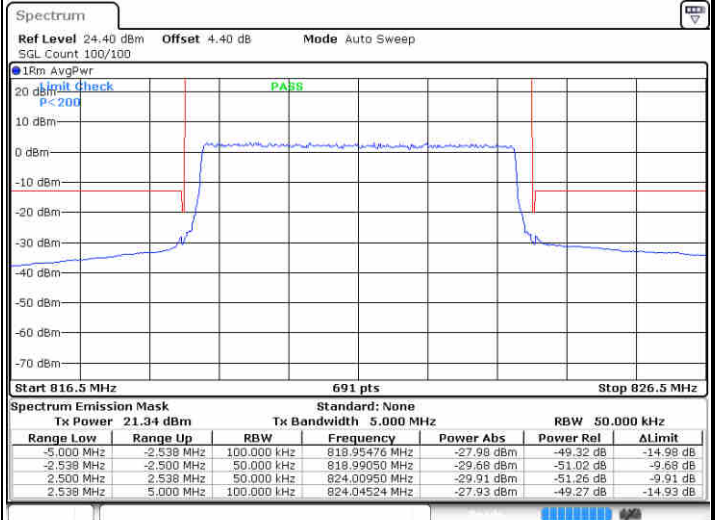
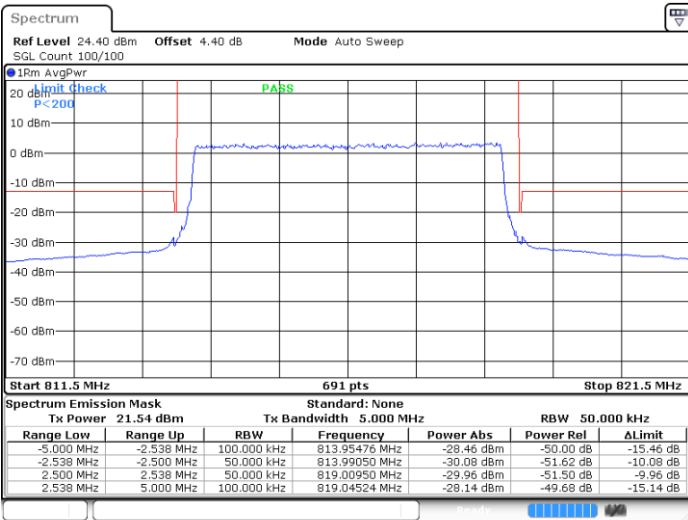



LTE Band 26 / 10MHz / QPSK

Lowest Band Edge / 1 RB

Highest Band Edge / 1 RB

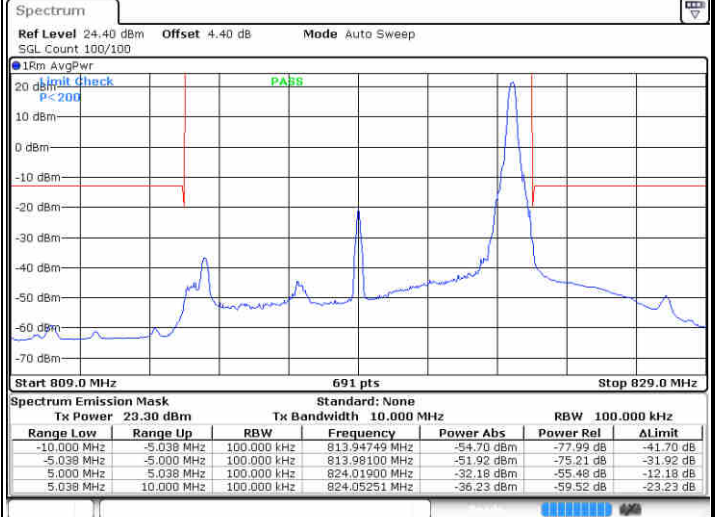
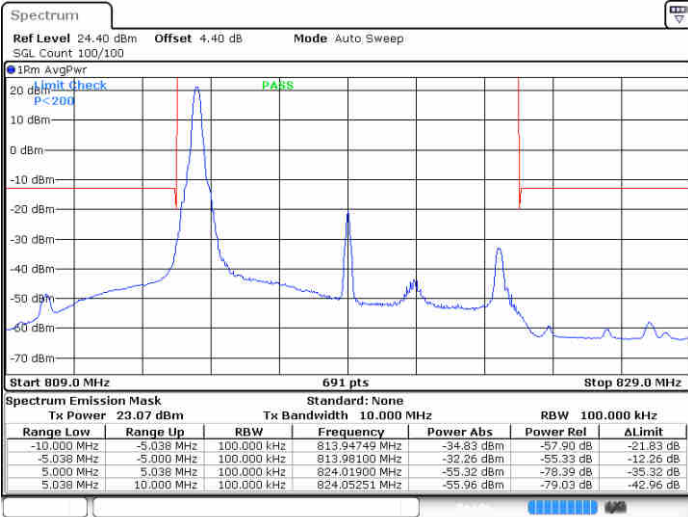

Band Edge / Full RB

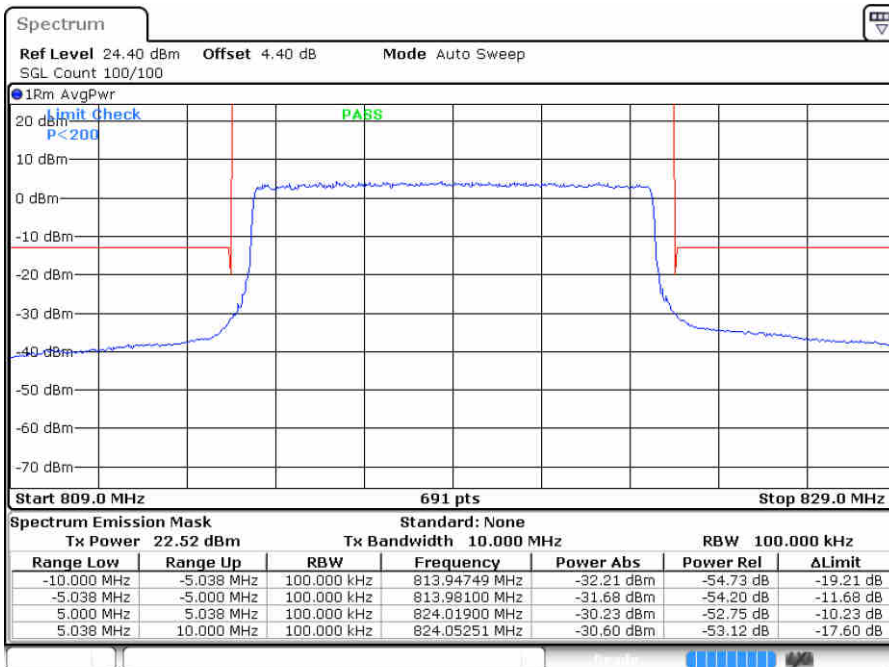



LTE Band 26 / 10MHz / 16QAM

Lowest Band Edge / 1 RB

Highest Band Edge / 1 RB

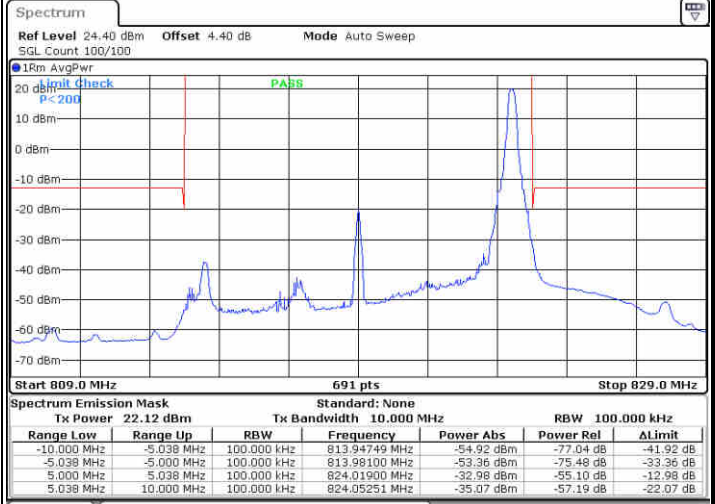
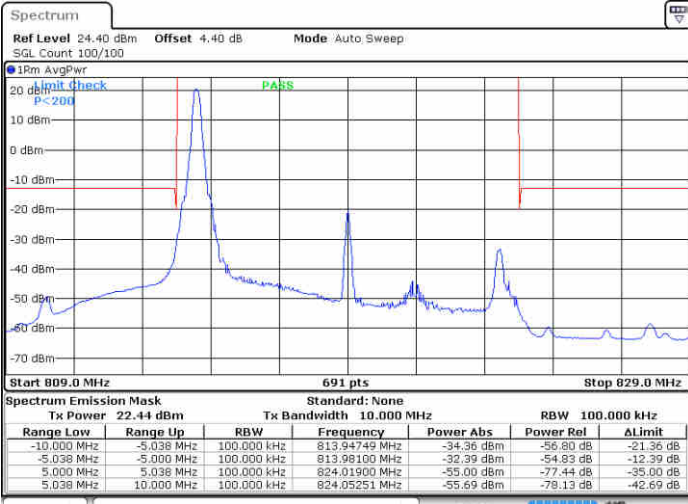

Band Edge / Full RB

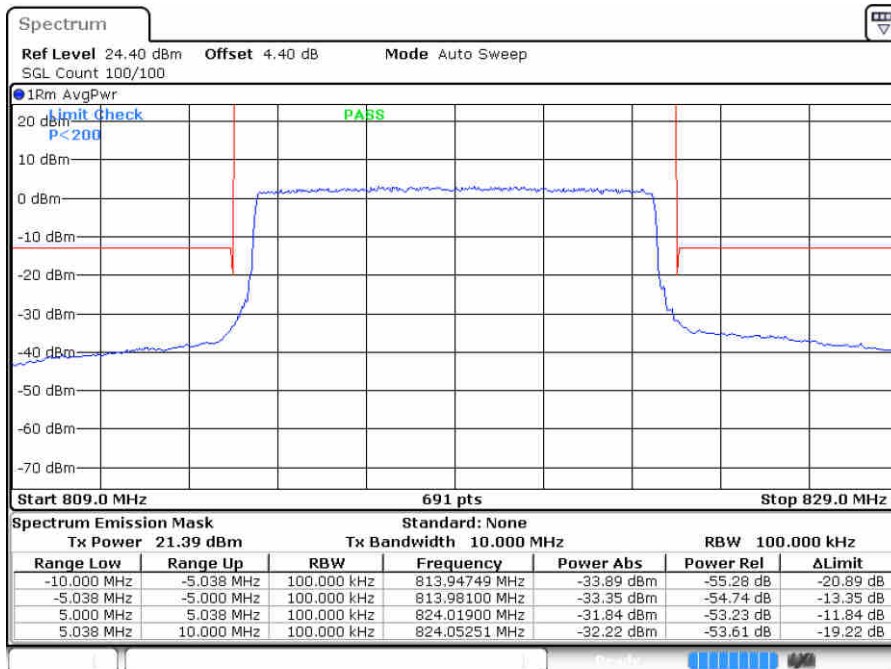



LTE Band 26 / 15MHz QPSK

Lowest Band Edge / 1 RB

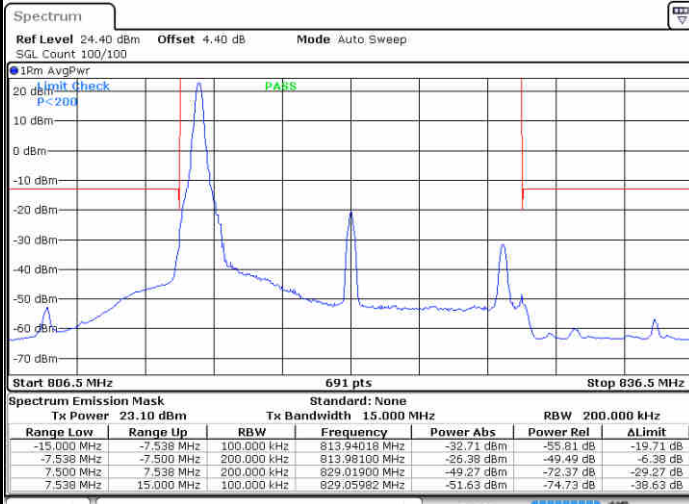

Lowest Band Edge / Full RB

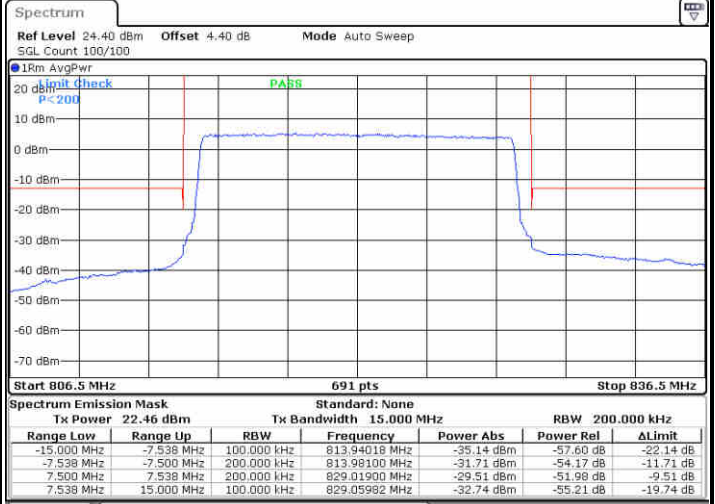

LTE Band 26 / 15MHz 16QAM

Lowest Band Edge / 1 RB

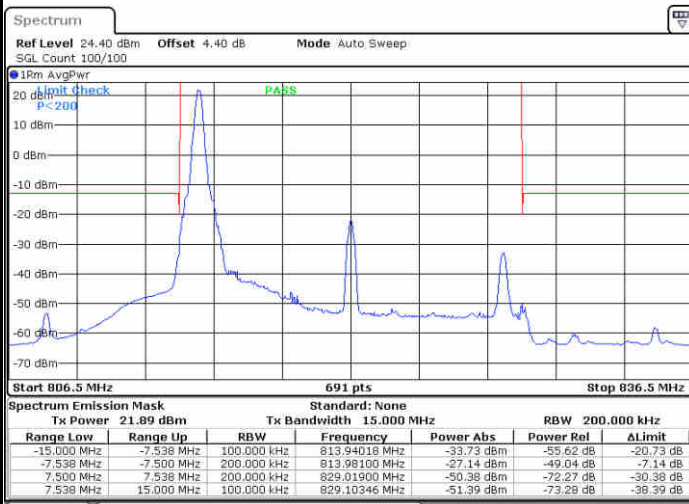

Lowest Band Edge / Full RB

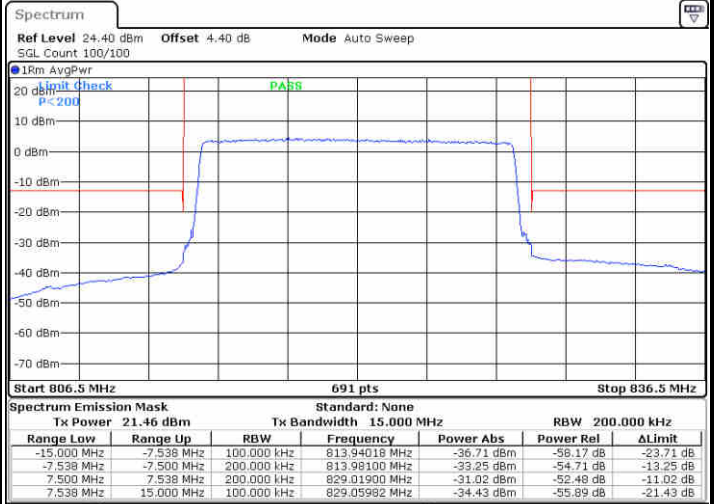



Conducted Spurious Emission

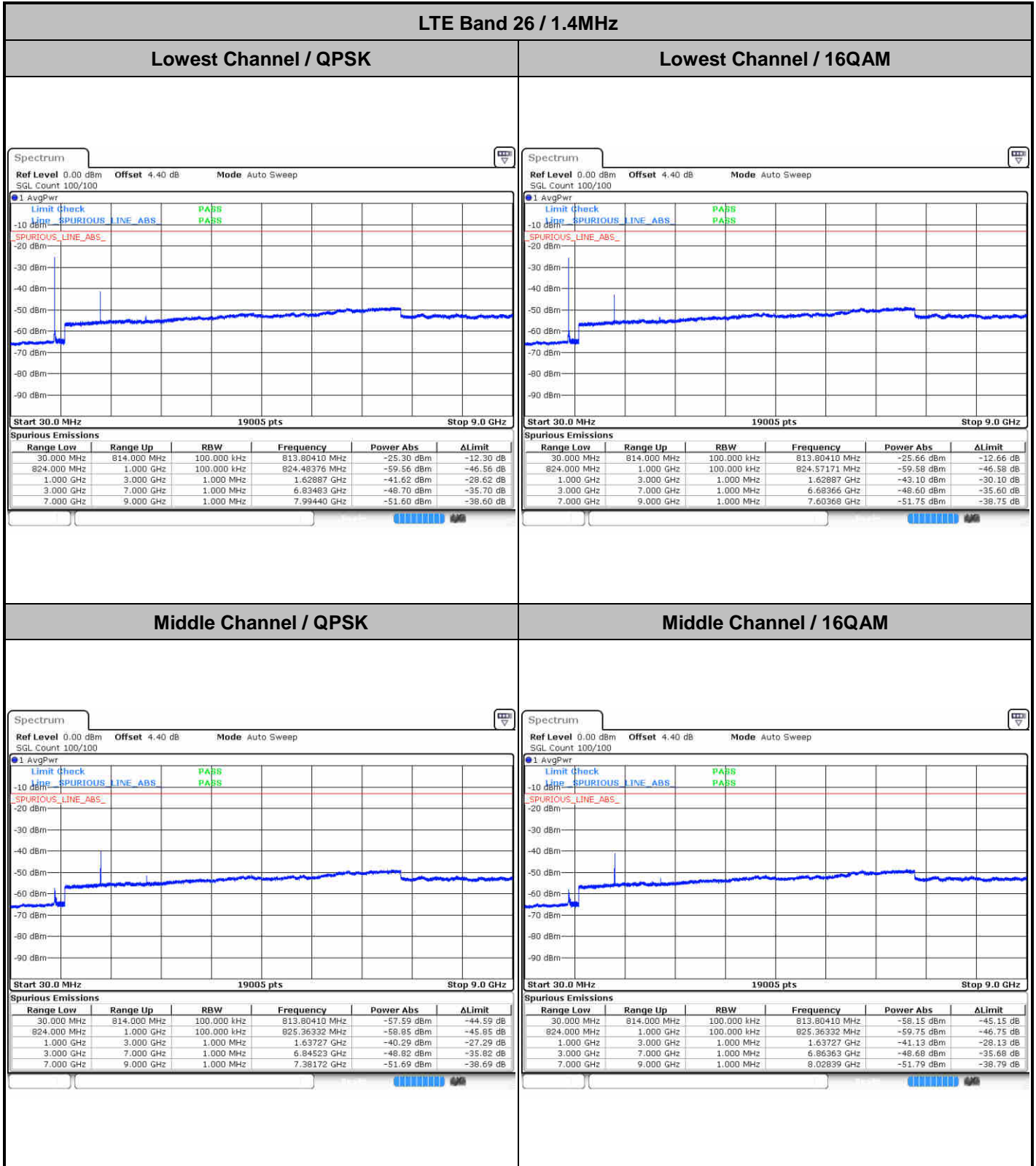



LTE Band 26 / 1.4MHz

Highest Channel / QPSK

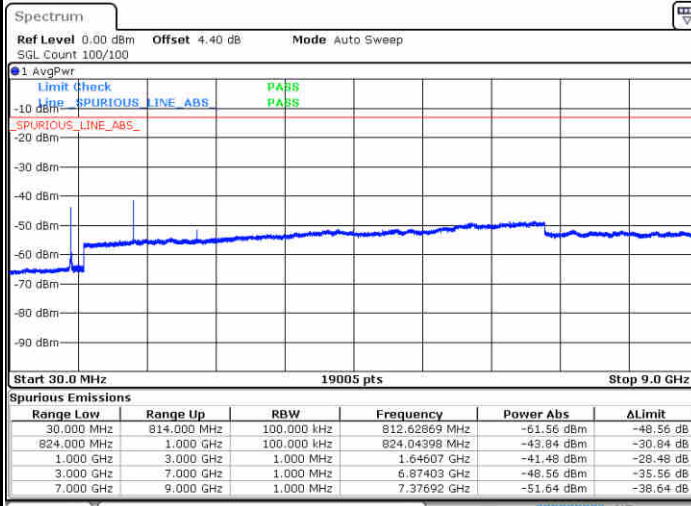

Highest Channel / 16QAM

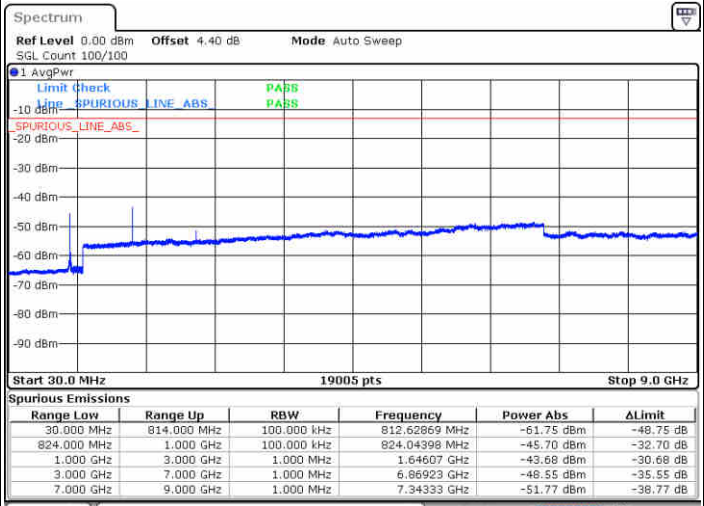

LTE Band 26 / 3MHz

Lowest Channel / QPSK

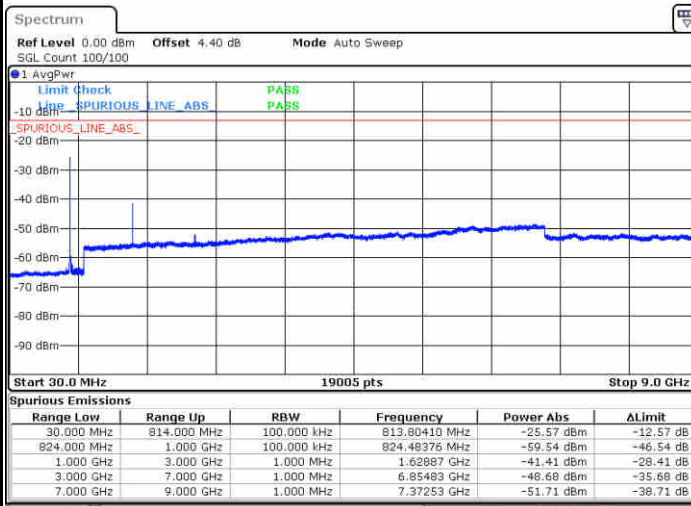

Lowest Channel / 16QAM

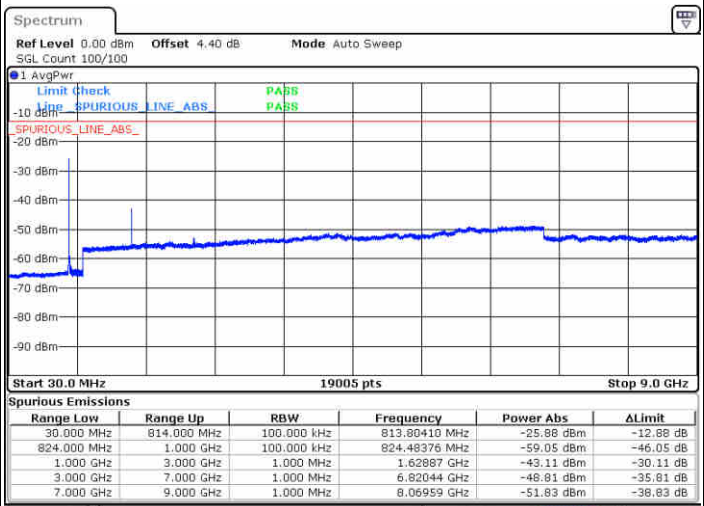



LTE Band 26 / 3MHz

Middle Channel / QPSK

Middle Channel / 16QAM

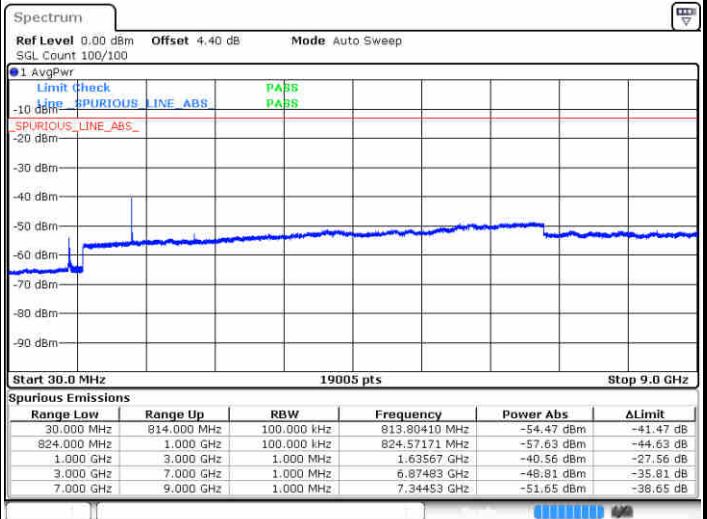
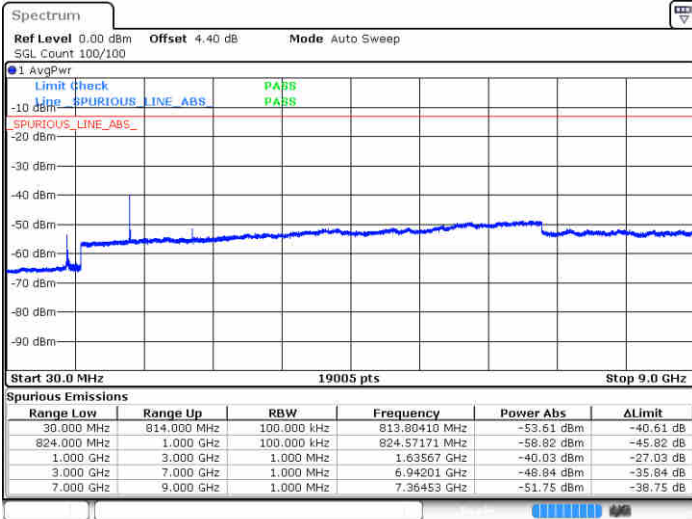

Highest Channel / QPSK

Highest Channel / 16QAM

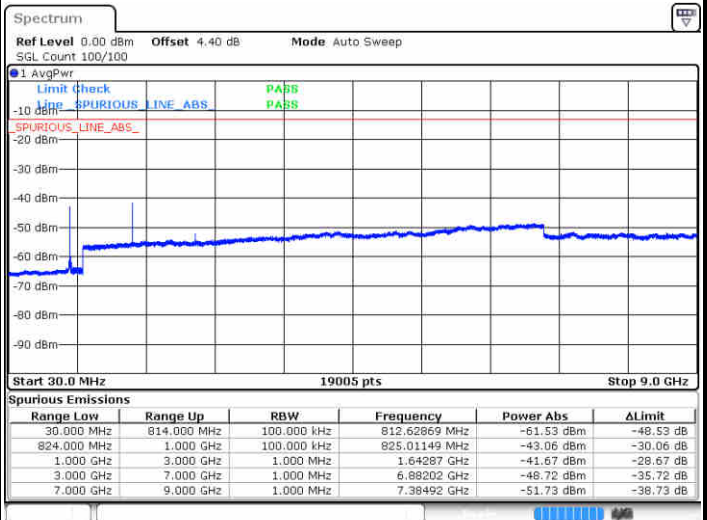
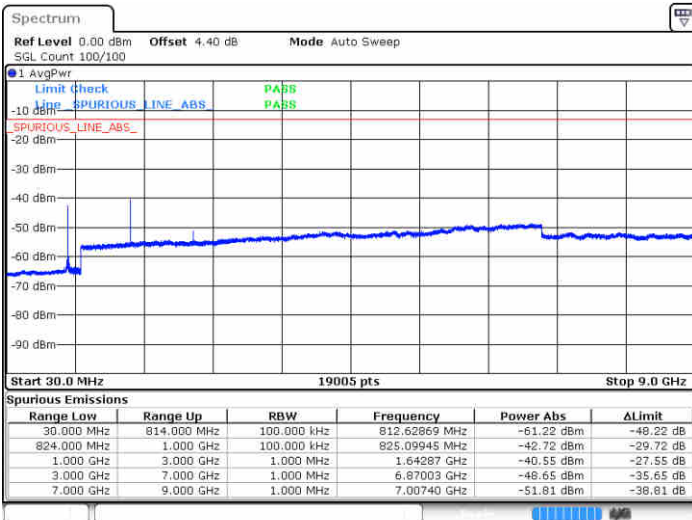



LTE Band 26 / 5MHz

Lowest Channel / QPSK

Lowest Channel / 16QAM

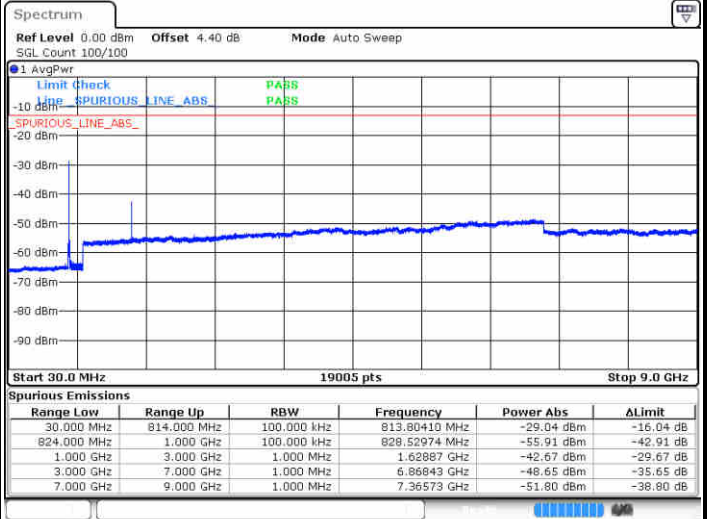
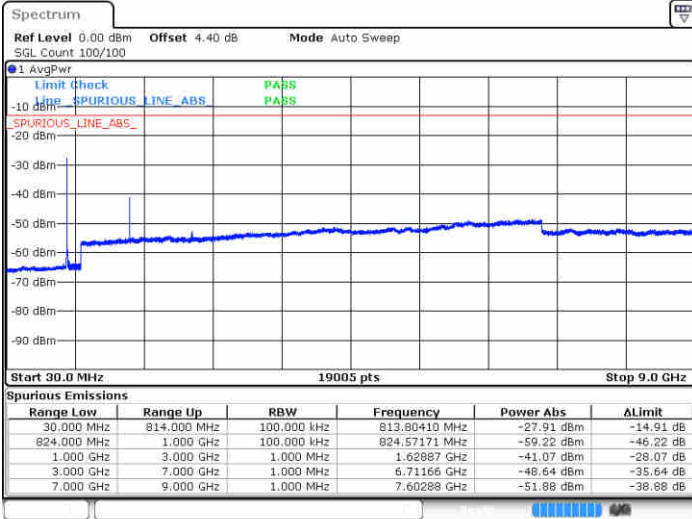

Middle Channel / QPSK

Middle Channel / 16QAM

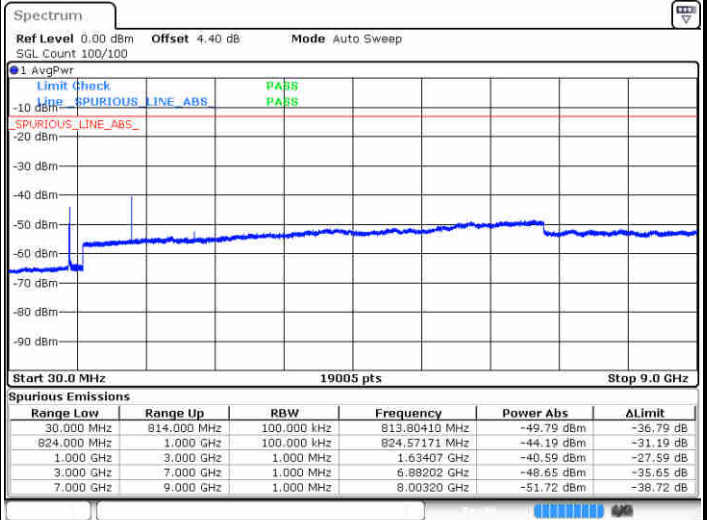
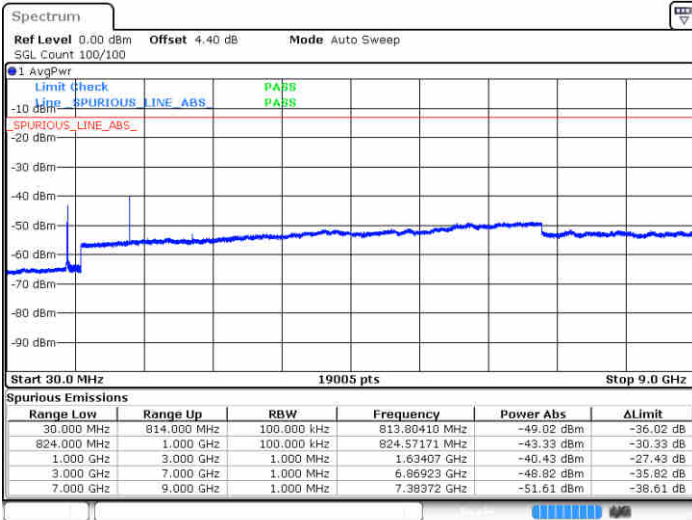



LTE Band 26 / 5MHz

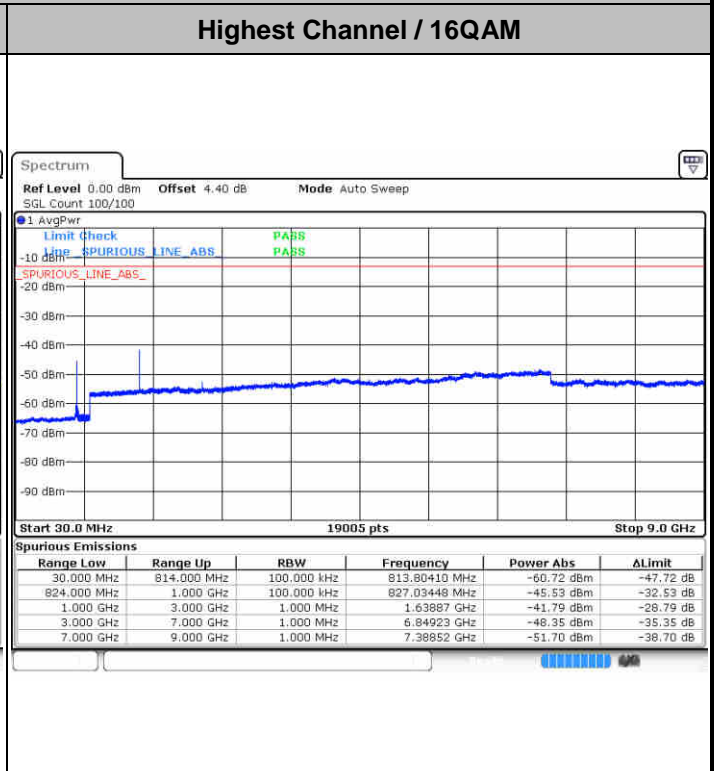
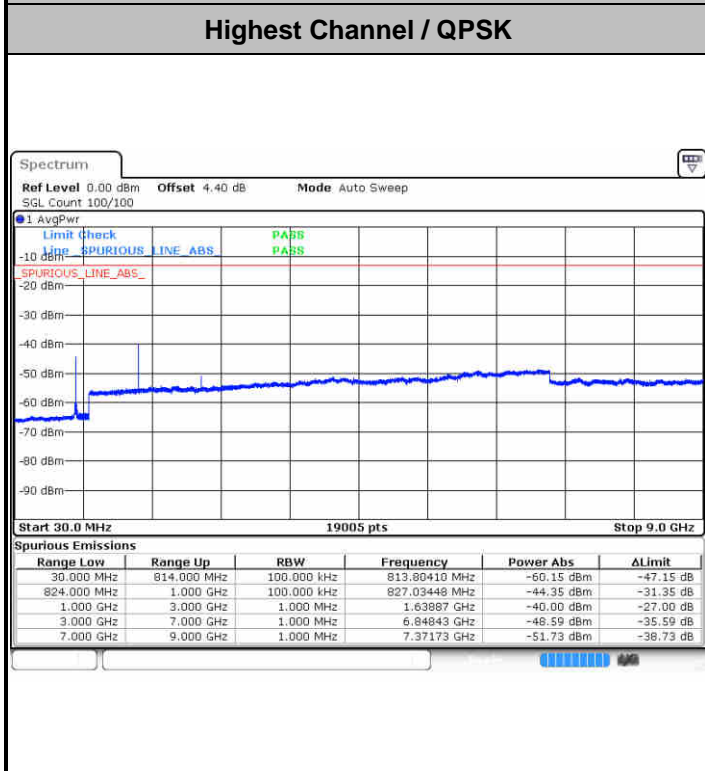

LTE Band 26 / 10MHz

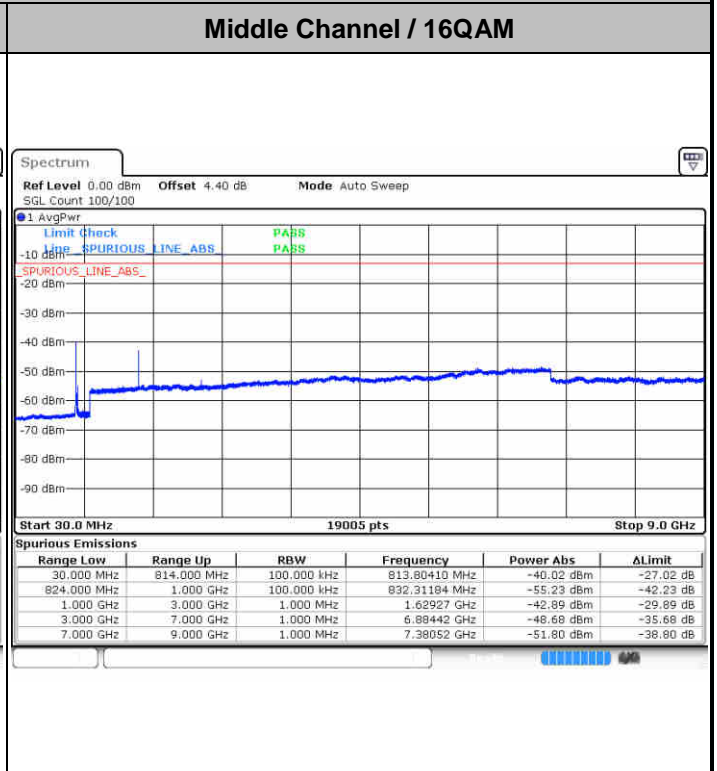
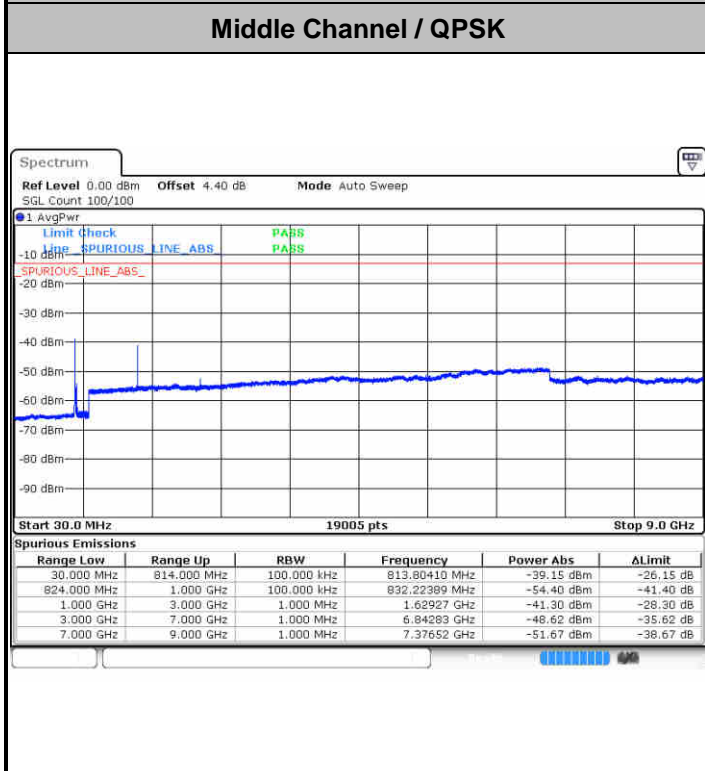



LTE Band 26 / 15MHz

Lowest Channel / QPSK

Lowest Channel / 16QAM

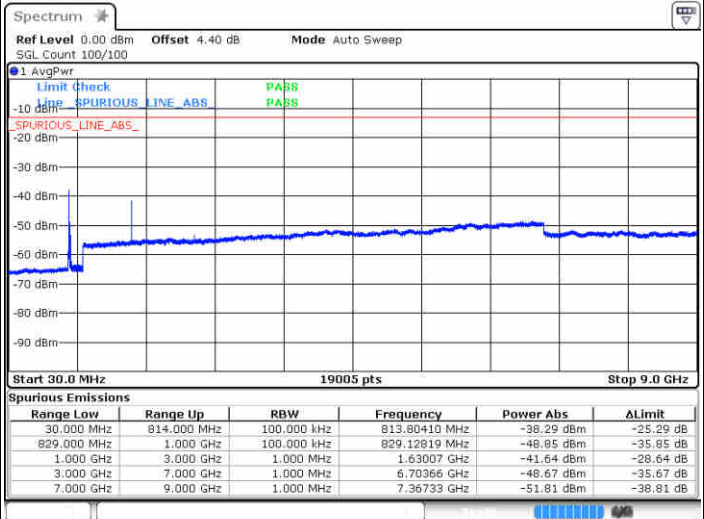
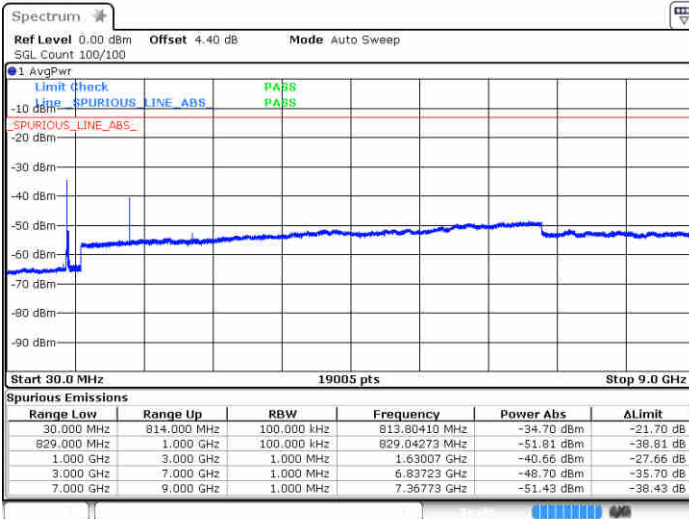



Frequency Stability

Test Conditions		LTE Band 26 (QPSK) / Middle Channel	Limit
Temperature (°C)	Voltage (Volt)	BW 10MHz	2.5ppm
		Deviation (ppm)	Result
50	Normal Voltage	0.0052	PASS
40	Normal Voltage	0.0078	
30	Normal Voltage	0.0065	
20(Ref.)	Normal Voltage	0.0000	
10	Normal Voltage	0.0079	
0	Normal Voltage	0.0004	
-10	Normal Voltage	0.0024	
-20	Normal Voltage	0.0048	
-30	Normal Voltage	0.0068	
20	Maximum Voltage	0.0017	
20	Normal Voltage	0.0000	
20	Battery End Point	0.0036	

Note: Normal Voltage =7.2 V. ; Battery End Point (BEP) =7 V. ; Maximum Voltage =8.4 V.



Appendix B. Test Results of Radiated Test

Radiated Spurious Emission

LTE Band 26 / 1.4MHz / QPSK									
Channel	Frequency (MHz)	ERP (dBm)	Limit (dBm)	Over Limit (dB)	SPA Reading (dBm)	S.G. Power (dBm)	TX Cable loss (dB)	TX Antenna Gain (dBi)	Polarization (H/V)
Lowest	1628.14	-55.03	-13	-42.03	-64.44	-58.26	3.98	9.36	H
	2442.21	-53.15	-13	-40.15	-66.68	-56.70	4.85	10.55	H
	3256.28	-60.77	-13	-47.77	-76.54	-65.70	5.50	12.58	H
	1628.14	-59.11	-13	-46.11	-68.00	-62.34	3.98	9.36	V
	2442.21	-55.65	-13	-42.65	-68.95	-59.20	4.85	10.55	V
	3256.28	-61.04	-13	-48.04	-76.46	-65.97	5.50	12.58	V
Middle	1636.74	-53.41	-13	-40.41	-62.82	-56.66	4.00	9.40	H
	2455.11	-53.10	-13	-40.10	-66.61	-56.67	4.88	10.60	H
	3273.48	-60.72	-13	-47.72	-76.47	-65.65	5.52	12.60	H
	1636.74	-58.43	-13	-45.43	-67.32	-61.68	4.00	9.40	V
	2455.11	-42.23	-13	-29.23	-55.53	-45.80	4.88	10.60	V
	3273.48	-61.04	-13	-48.04	-76.42	-65.97	5.52	12.60	V
Highest	1645.34	-58.17	-13	-45.17	-67.76	-61.34	4.10	9.42	H
	2468.01	-54.84	-13	-41.84	-68.36	-58.42	4.90	10.63	H
	3290.68	-60.70	-13	-47.70	-76.41	-65.62	5.55	12.62	H
	1645.34	-60.92	-13	-47.92	-69.99	-64.09	4.10	9.42	V
	2468.01	-43.65	-13	-30.65	-56.96	-47.23	4.90	10.63	V
	3290.68	-60.92	-13	-47.92	-76.24	-65.84	5.55	12.62	V

Remark: Spurious emissions within 30-1000MHz were found more than 20dB below limit line.



LTE Band 26 / 3MHz / QPSK									
Channel	Frequency (MHz)	ERP (dBm)	Limit (dBm)	Over Limit (dB)	SPA Reading (dBm)	S.G. Power (dBm)	TX Cable loss (dB)	TX Antenna Gain (dBi)	Polarization (H/V)
Lowest	1628.3	-57.12	-13	-44.12	-66.53	-60.35	3.98	9.36	H
	2442.45	-55.52	-13	-42.52	-69.05	-59.07	4.85	10.55	H
	3256.6	-60.80	-13	-47.80	-76.57	-65.73	5.50	12.58	H
	1632	-58.23	-13	-45.23	-67.12	-61.46	3.98	9.36	V
	2442.45	-56.11	-13	-43.11	-69.41	-59.66	4.85	10.55	V
	3256.6	-60.90	-13	-47.90	-76.32	-65.83	5.50	12.58	V
Middle	1635.3	-53.79	-13	-40.79	-63.20	-57.04	4.00	9.40	H
	2452.95	-55.41	-13	-42.41	-68.94	-58.98	4.88	10.60	H
	3270.6	-60.57	-13	-47.57	-76.32	-65.50	5.52	12.60	H
	1635.3	-58.14	-13	-45.14	-67.03	-61.39	4.00	9.40	V
	2452.95	-42.55	-13	-29.55	-55.85	-46.12	4.88	10.60	V
	3270.6	-60.97	-13	-47.97	-76.35	-65.90	5.52	12.60	V
Highest	1642.3	-56.66	-13	-43.66	-66.25	-59.83	4.10	9.42	H
	2463.45	-52.18	-13	-39.18	-65.69	-55.76	4.90	10.63	H
	3284.6	-60.37	-13	-47.37	-76.13	-65.29	5.55	12.62	H
	1642.3	-60.77	-13	-47.77	-69.84	-63.94	4.10	9.42	V
	2463.45	-43.50	-13	-30.50	-56.80	-47.08	4.90	10.63	V
	3284.6	-61.16	-13	-48.16	-76.55	-66.08	5.55	12.62	V

Remark: Spurious emissions within 30-1000MHz were found more than 20dB below limit line.



LTE Band 26 / 5MHz / QPSK									
Channel	Frequency (MHz)	ERP (dBm)	Limit (dBm)	Over Limit (dB)	SPA Reading (dBm)	S.G. Power (dBm)	TX Cable loss (dB)	TX Antenna Gain (dBi)	Polarization (H/V)
Lowest	1628.5	-55.75	-13	-42.75	-65.16	-58.98	3.98	9.36	H
	2442.75	-53.21	-13	-40.21	-66.74	-56.76	4.85	10.55	H
	3257	-60.99	-13	-47.99	-76.78	-65.92	5.50	12.58	H
	1628.5	-57.90	-13	-44.90	-66.79	-61.13	3.98	9.36	V
	2442.75	-54.19	-13	-41.19	-67.49	-57.74	4.85	10.55	V
	3257	-60.77	-13	-47.77	-76.21	-65.70	5.50	12.58	V
Middle	1633.5	-54.26	-13	-41.26	-63.67	-57.51	4.00	9.40	H
	2450.25	-56.79	-13	-43.79	-70.32	-60.36	4.88	10.60	H
	3267	-60.91	-13	-47.91	-76.70	-65.84	5.52	12.60	H
	1633.5	-58.36	-13	-45.36	-67.25	-61.61	4.00	9.40	V
	2450.25	-45.82	-13	-32.82	-59.12	-49.39	4.88	10.60	V
	3267	-61.17	-13	-48.17	-76.61	-66.10	5.52	12.60	V
Highest	1638.5	-55.12	-13	-42.12	-64.71	-58.29	4.10	9.42	H
	2457.75	-52.63	-13	-39.63	-66.14	-56.21	4.90	10.63	H
	3277	-60.68	-13	-47.68	-76.43	-65.60	5.55	12.62	H
	1638.5	-59.77	-13	-46.77	-68.84	-62.94	4.10	9.42	V
	2457.75	-50.40	-13	-37.40	-63.70	-53.98	4.90	10.63	V
	3277	-61.30	-13	-48.30	-76.68	-66.22	5.55	12.62	V

Remark: Spurious emissions within 30-1000MHz were found more than 20dB below limit line.

LTE Band 26 / 10MHz / QPSK									
Channel	Frequency (MHz)	ERP (dBm)	Limit (dBm)	Over Limit (dB)	SPA Reading (dBm)	S.G. Power (dBm)	TX Cable loss (dB)	TX Antenna Gain (dBi)	Polarization (H/V)
Middle	1629	-56.02	-13	-43.02	-65.43	-59.27	4.00	9.40	H
	2443.5	-54.86	-13	-41.86	-68.39	-58.43	4.88	10.60	H
	3258	-60.54	-13	-47.54	-76.33	-65.47	5.52	12.60	H
	1629	-59.12	-13	-46.12	-68.01	-62.37	4.00	9.40	V
	2443.5	-55.34	-13	-42.34	-68.64	-58.91	4.88	10.60	V
	3258	-61.22	-13	-48.22	-76.66	-66.15	5.52	12.60	V

Remark: Spurious emissions within 30-1000MHz were found more than 20dB below limit line.