



FCC RF Test Report

APPLICANT : VeriFone, Inc.
EQUIPMENT : Point of Sale Terminal
BRAND NAME : VeriFone
MODEL NAME : VX690 3G-BT-WiFi
FCC ID : B32VX6903GBTWIFI
STANDARD : FCC Part 15 Subpart C §15.247
CLASSIFICATION : (DTS) Digital Transmission System

The product was received on Apr. 11, 2014 and testing was completed on Apr. 28, 2014. We, SPORTON INTERNATIONAL INC., would like to declare that the tested sample has been evaluated in accordance with the test procedures and the testing has shown the tested sample to be in compliance with the applicable technical standards.

The test results in this report apply exclusively to the tested model / sample. Without written approval of SPORTON INTERNATIONAL INC., the test report shall not be reproduced except in full.

Reviewed by: Joseph Lin / Supervisor

Approved by: Jones Tsai / Manager



SPORTON INTERNATIONAL INC.

No. 52, Hwa Ya 1st Rd., Hwa Ya Technology Park, Kwei-Shan Hsiang, Tao Yuan Hsien, Taiwan, R.O.C.

SPORTON INTERNATIONAL INC.

TEL : 886-3-327-3456

FAX : 886-3-328-4978

FCC ID : B32VX6903GBTWIFI

Page Number : 1 of 56

Report Issued Date : May 13, 2014

Report Version : Rev. 01



TABLE OF CONTENTS

REVISION HISTORY 3

SUMMARY OF TEST RESULT 4

1 GENERAL DESCRIPTION..... 5

 1.1 Applicant 5

 1.2 Manufacturer..... 5

 1.3 Feature of Equipment Under Test 5

 1.4 Product Specification of Equipment Under Test..... 5

 1.5 Modification of EUT 6

 1.6 Testing Location 6

 1.7 Applicable Standards..... 6

2 TEST CONFIGURATION OF EQUIPMENT UNDER TEST..... 7

 2.1 Descriptions of Test Mode 7

 2.2 Test Mode..... 8

 2.3 Connection Diagram of Test System..... 9

 2.4 Support Unit used in test configuration and system 11

 2.5 EUT Operation Test Setup 11

 2.6 Measurement Results Explanation Example..... 12

3 TEST RESULT 13

 3.1 6dB and 99% Bandwidth Measurement 13

 3.2 Peak Output Power Measurement 18

 3.3 Power Spectral Density Measurement 20

 3.4 Conducted Band Edges and Spurious Emission Measurement 26

 3.5 Radiated Band Edges and Spurious Emission Measurement 35

 3.6 AC Conducted Emission Measurement..... 44

 3.7 Antenna Requirements..... 54

4 LIST OF MEASURING EQUIPMENT..... 55

5 UNCERTAINTY OF EVALUATION..... 56

APPENDIX A. SETUP PHOTOGRAPHS



REVISION HISTORY

REPORT NO.	VERSION	DESCRIPTION	ISSUED DATE
FR441115B	Rev. 01	Initial issue of report	May 13, 2014

**SUMMARY OF TEST RESULT**

Report Section	FCC Rule	IC Rule	Description	Limit	Result	Remark
3.1	15.247(a)(2)	RSS-210 A8.2(a)	6dB Bandwidth	$\geq 0.5\text{MHz}$	Pass	-
3.1	-	RSS-Gen 4.6.1	99% Bandwidth	-	Pass	-
3.2	15.247(b)(1)	RSS-210 A8.1(b)	Peak Output Power	$\leq 30\text{dBm}$	Pass	-
3.3	15.247(e)	RSS-210 A8.2(b)	Power Spectral Density	$\leq 8\text{dBm}$	Pass	-
3.4	15.247(d)	RSS-210 A8.5	Conducted Band Edges and Spurious Emission	$\leq 20\text{dBc}$	Pass	-
3.5	15.247(d)	RSS-210 A8.5	Radiated Band Edges and Spurious Emission	15.209(a) & 15.247(d)	Pass	Under limit 14.97 dB at 66.180 MHz
3.6	15.207	RSS-Gen 7.2.4	AC Conducted Emission	15.207(a)	Pass	Under limit 1.00 dB at 13.558 MHz
3.7	15.203 & 15.247(b)	RSS-210 A8.4	Antenna Requirement	N/A	Pass	-



1 General Description

1.1 Applicant

VeriFone, Inc.

1400 West Stanford Ranch Road Suite 200 Rocklin CA 95765 USA

1.2 Manufacturer

Inventec Appliances (Pudong) Co., Ltd.

No. 789 Pu Xing Road, Shanghai, PRC

1.3 Feature of Equipment Under Test

Product Feature	
Equipment	Point of Sale Terminal
Brand Name	VeriFone
Model Name	VX690 3G-BT-WiFi
FCC ID	B32VX6903GBTWIFI
EUT supports Radios application	GSM/EGPRS/WCDMA/HSPA/RFID WLAN 11a/b/g/n (HT20) Bluetooth v4.0 EDR/LE
EUT Stage	Identical Prototype

Remark: The above EUT's information was declared by manufacturer. Please refer to the specifications or user's manual for more detailed description.

1.4 Product Specification of Equipment Under Test

Product Specification subjective to this standard	
Tx/Rx Frequency Range	2402 MHz ~ 2480 MHz
Number of Channels	40
Carrier Frequency of Each Channel	40 Channel(37 hopping + 3 advertising channel)
Maximum Output Power to Antenna	7.75 dBm (0.0060 W)
99% Occupied Bandwidth	1.04MHz
Antenna Type	PIFA Antenna type with gain 1.18 dBi
Type of Modulation	Bluetooth LE : GFSK

1.5 Modification of EUT

No modifications are made to the EUT during all test items.

1.6 Testing Location

Sporton Lab is accredited to ISO 17025 by Taiwan Accreditation Foundation (TAF code : 1190) and the FCC designation No. TW1022 under the FCC 2.948(e) by Mutual Recognition Agreement (MRA) in FCC Test.

Test Site	SPORTON INTERNATIONAL INC.		
Test Site Location	No. 52, Hwa Ya 1 st Rd., Hwa Ya Technology Park, Kwei-Shan Hsiang, Tao Yuan Hsien, Taiwan, R.O.C. TEL: +886-3-3273456 / FAX: +886-3-3284978		
Test Site No.	Sporton Site No.		
	TH02-HY	CO05-HY	03CH07-HY

1.7 Applicable Standards

According to the specifications of the manufacturer, the EUT must comply with the requirements of the following standards:

- FCC Part 15 Subpart C §15.247
- FCC KDB Publication No. 558074 D01 DTS Meas. Guidance v03r01
- ANSI C63.4-2003

Remark:

1. All test items were verified and recorded according to the standards and without any deviation during the test.
2. This EUT has also been tested and complied with the requirements of FCC Part 15, Subpart B, recorded in a separate test report.

2 Test Configuration of Equipment Under Test

2.1 Descriptions of Test Mode

The RF output power was recorded in the following table:

Channel	Frequency	Bluetooth 4.0 – LE RF Output Power	
		Data Rate / Modulation	
		GFSK	
		1Mbps	
Ch00	2402MHz	7.18 dBm	
Ch19	2440MHz	7.66 dBm	
Ch39	2480MHz	7.75 dBm	

- a. The EUT has been associated with peripherals and configuration operated in a manner tended to maximize its emission characteristics in a typical application. Frequency range investigated: conduction (150 kHz to 30 MHz), radiation (9 kHz to the 10th harmonic of the highest fundamental frequency or to 40 GHz, whichever is lower). Pre-scanned tests, X, Y, Z in three orthogonal panels to determine the final configuration (Y plane as worst plane) from all possible combinations.
- b. AC power line Conducted Emission was tested under maximum output power.

2.2 Test Mode

The following summary table is showing all test modes to demonstrate in compliance with the standard.

Summary table of Test Cases	
Test Item	Data Rate / Modulation
	Bluetooth 4.0 – LE / GFSK
Conducted TCs	Mode 1: Bluetooth Tx CH00_2402 MHz_1Mbps Mode 2: Bluetooth Tx CH19_2440 MHz_1Mbps Mode 3: Bluetooth Tx CH39_2480 MHz_1Mbps
Radiated TCs	Mode 1: Bluetooth Tx CH00_2402 MHz_1Mbps Mode 2: Bluetooth Tx CH19_2440 MHz_1Mbps Mode 3: Bluetooth Tx CH39_2480 MHz_1Mbps
AC Conducted Emission	Mode 1: GSM850 (GPRS class 8) Idle + Bluetooth Link + TC+ TF + GPS Rx + Battery 2 + Bluetooth Base (Charging from Adapter 1) + USB flash drive + Micro USB Cable (Data Link with notebook) + RJ-45 (Load) + RJ-11 (Load) + RS232 (Load) Mode 2: GSM850 (GPRS class 8) Idle + WLAN (2.4GHz) Link + TC + TF + Battery 1 + Adapter 1 Mode 3: GSM850 (GPRS class 8) Idle + WLAN (5GHz) Link + TC + TF + Battery 1 + Adapter 1
Remark:	
<ol style="list-style-type: none"> 1. The worst case of conducted emission is mode 1; only the test data of it was reported. 2. TC stands for Test Configuration, and consists of Smart Card, SD Card, and Printer. 3. TF stands for Test Function, and consists of MSR On and RFID On. 4. “Linking with USB Flash Drive” means data application transferred mode between EUT and USB Flash Drive. 5. “Link with Notebook” means data application transferred mode between EUT and Notebook. 	

2.3 Connection Diagram of Test System

<Bluetooth 4.0 – LE Tx Mode>

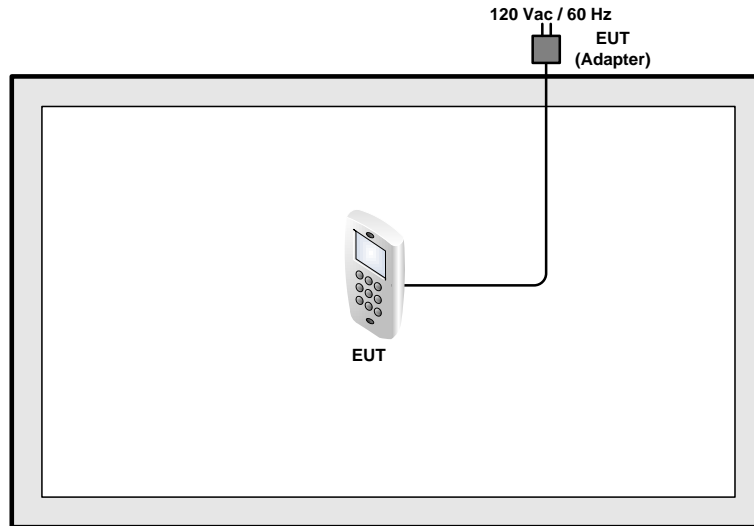

<EUT with USB Cable (Link with Notebook) Mode>

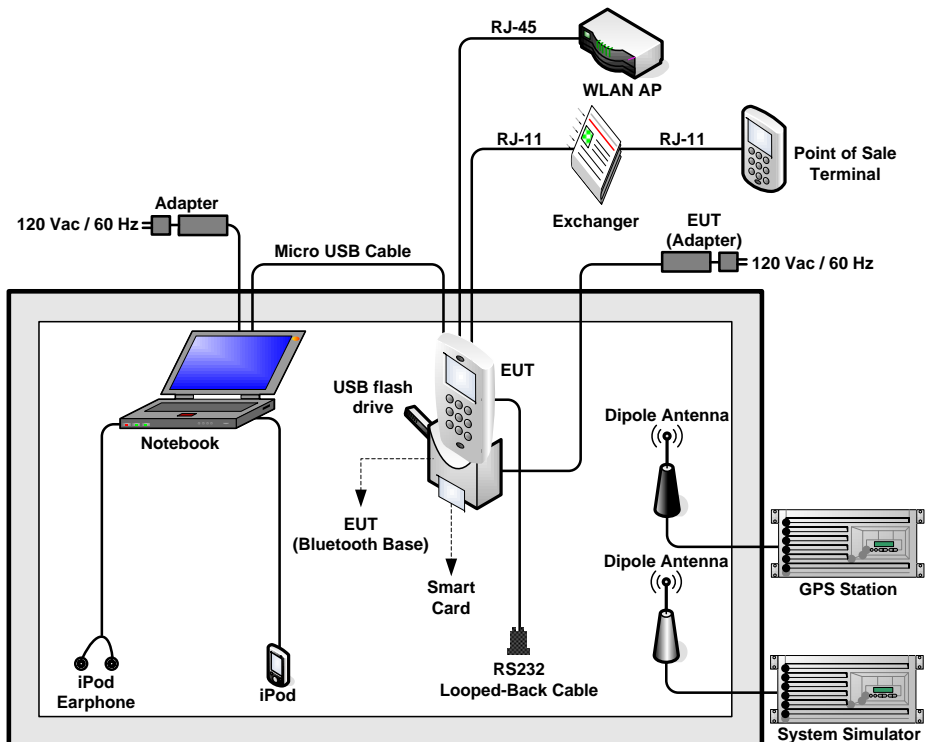

<EUT with Adapter Mode>

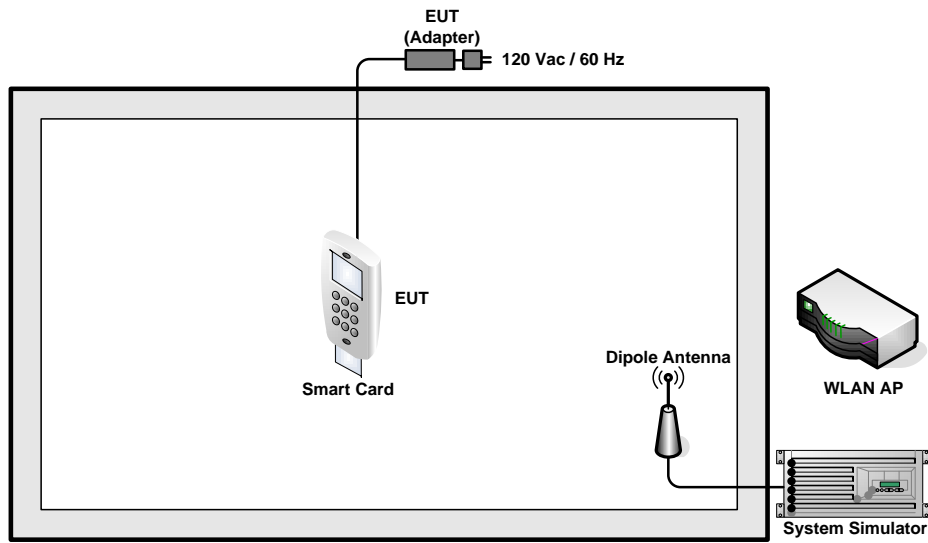

2.4 Support Unit used in test configuration and system

Item	Equipment	Trade Name	Model Name	FCC ID	Data Cable	Power Cord
1.	System Simulator	R&S	CMU 200	N/A	N/A	Unshielded, 1.8 m
2.	GPS Station	Pendulum	GSG-54	N/A	N/A	Unshielded, 1.8 m
3.	WLAN AP	D-Link	DIR-628	KA2DIR628A2	N/A	Unshielded, 1.8 m
4.	Notebook	DELL	Latitude E6320	FCC DoC/ Contains FCC ID: QDS-BRCM1054	Unshielded, 3.0 m	AC I/P: Unshielded, 1.2 m DC O/P: Shielded, 1.8 m
5.	Point of Sale Terminal	VeriFone	VX520	FCC DoC	Unshielded, 3.0 m	AC I/P: Unshielded, 1.2 m DC O/P: Shielded, 1.8 m
6.	Exchange	Sun Moon Star	SMS-4 PLUS	N/A	N/A	Unshielded, 1.6 m
7.	iPod	Apple	A1285	FCC DoC	Shielded, 1.0 m	N/A
8.	iPod Earphone	Apple	N/A	Verification	Unshielded, 1.0 m	N/A
9.	USB flash drive	SP	Touch T01	FCC DoC	N/A	N/A
10.	Smart Card	N/A	N/A	N/A	N/A	N/A
11.	MSR Card	N/A	N/A	N/A	N/A	N/A
12.	SD Card	SanDisk	MicroSD HC	FCC DoC	N/A	N/A

2.5 EUT Operation Test Setup

For Bluetooth function, use BT tool of EUT, "BT LE Tx Test", to make the EUT provide functions like channel selection and power level for continuous transmitting signals.



2.6 Measurement Results Explanation Example

For all conducted test items:

The offset level is set in the spectrum analyzer to compensate the RF cable loss and attenuator factor between EUT conducted output port and spectrum analyzer. With the offset compensation, the spectrum analyzer reading level is exactly the EUT RF output level.

Example :

The spectrum analyzer offset is derived from RF cable loss and attenuator factor.

Offset = RF cable loss + attenuator factor.

Following shows an offset computation example with cable loss 4.2 dB and 10dB attenuator.

$$\begin{aligned} \text{Offset(dB)} &= \text{RF cable loss(dB)} + \text{attenuator factor(dB)}. \\ &= 4.2 + 10 = 14.2 \text{ (dB)} \end{aligned}$$

3 Test Result

3.1 6dB and 99% Bandwidth Measurement

3.1.1 Limit of 6dB and 99% Bandwidth

The minimum 6 dB bandwidth shall be at least 500 kHz.

3.1.2 Measuring Instruments

The section 4.0 of List of Measuring Equipment of this test report is used for test.

3.1.3 Test Procedures

1. The testing follows FCC KDB Publication No. 558074 D01 DTS Meas. Guidance v03r01.
2. The RF output of EUT was connected to the spectrum analyzer by RF cable and attenuator. The path loss was compensated to the results for each measurement.
3. Set to the maximum power setting and enable the EUT transmit continuously.
4. Make the measurement with the spectrum analyzer's resolution bandwidth (RBW) = 100 kHz. Set the Video bandwidth (VBW) = 300 kHz. In order to make an accurate measurement. The 6 dB bandwidth must be greater than 500 kHz.
5. For 99% Bandwidth Measurement, the spectrum analyzer's resolution bandwidth (RBW) is set 30kHz and set the Video bandwidth (VBW) = 100kHz.
6. Measure and record the results in the test report.

3.1.4 Test Setup

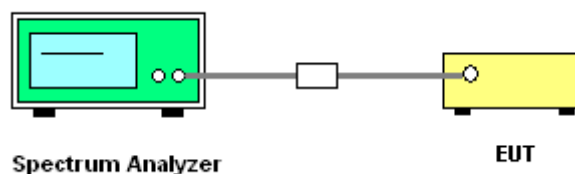



3.1.5 Test Result of 6dB Bandwidth

Test Mode :	Bluetooth 4.0 - LE	Temperature :	22~25°C
Test Engineer :	Alex Lee	Relative Humidity :	51~55%

Channel	Frequency (MHz)	6dB Bandwidth (MHz)	6dB Bandwidth Min. Limit (MHz)	Pass/Fail
00	2402	0.72	0.5	Pass
19	2440	0.72	0.5	Pass
39	2480	0.72	0.5	Pass

6 dB Bandwidth Plot on Channel 00

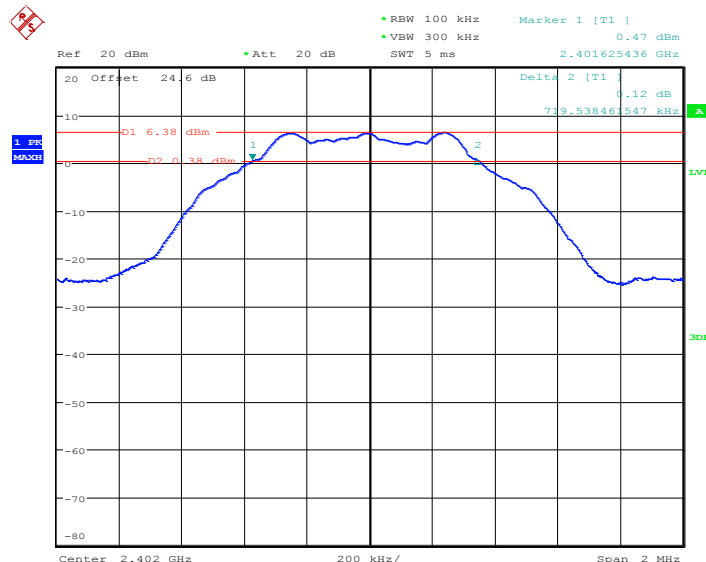

Date: 24.APR.2014 00:06:51



6 dB Bandwidth Plot on Channel 19

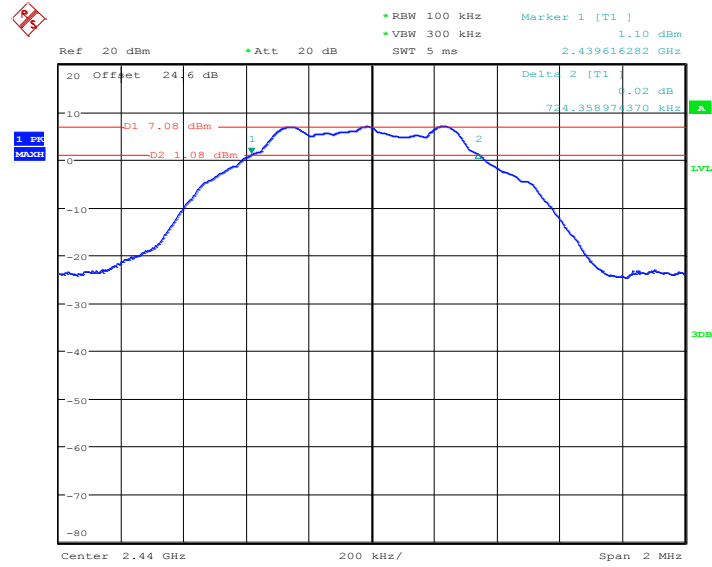

Date: 24.APR.2014 00:09:28

6 dB Bandwidth Plot on Channel 39

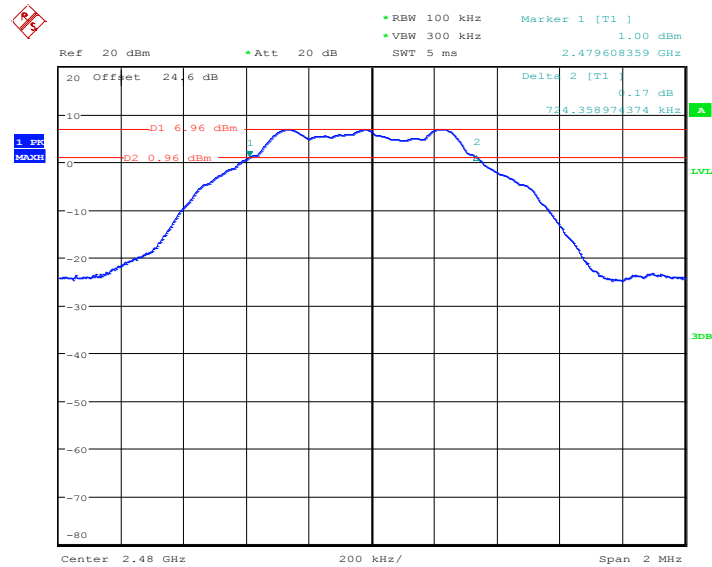

Date: 24.APR.2014 00:11:43



3.1.6 Test Result of 99% Occupied Bandwidth

Test Mode :	Bluetooth 4.0 - LE	Temperature :	22~25°C
Test Engineer :	Alex Lee	Relative Humidity :	51~55%

Channel	Frequency (MHz)	99% Occupied Bandwidth (MHz)
00	2402	1.04
19	2440	1.04
39	2480	1.04

99% Occupied Bandwidth Plot on Channel 00

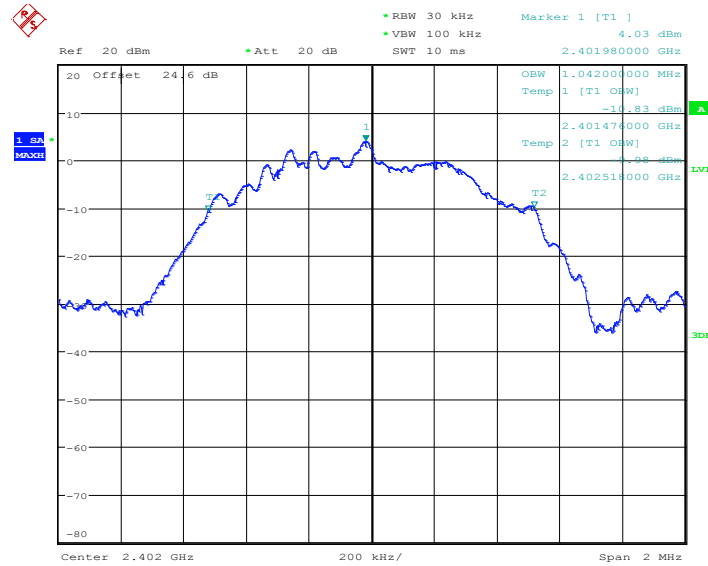

Date: 24.APR.2014 00:08:17



99% Occupied Bandwidth Plot on Channel 19

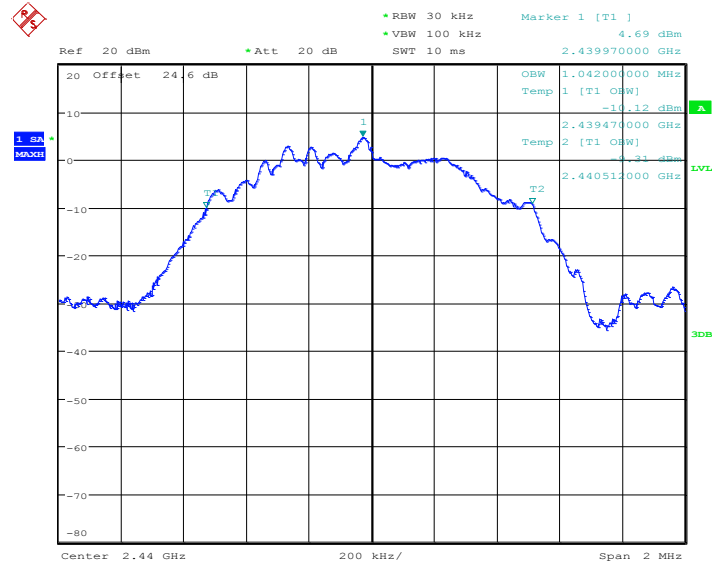

Date: 24.APR.2014 00:10:41

99% Occupied Bandwidth Plot on Channel 39

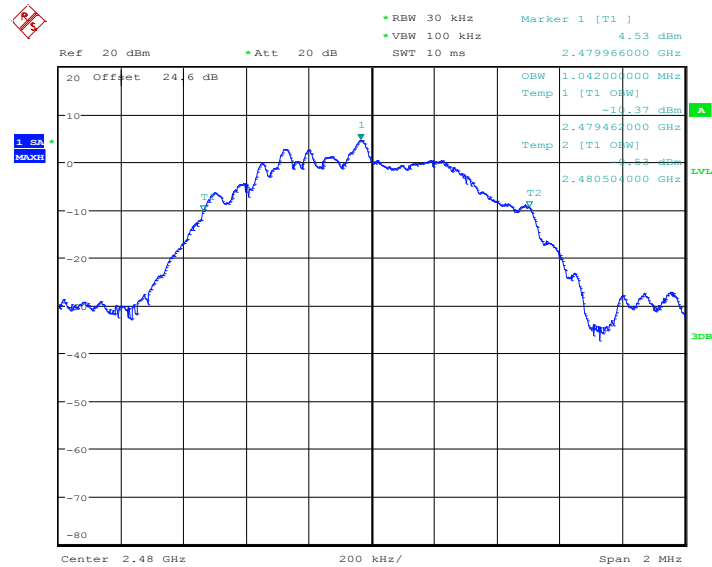

Date: 24.APR.2014 00:13:08

Note: The occupied channel bandwidth is maintained within the band of operation for all of the modulations.

3.2 Peak Output Power Measurement

3.2.1 Limit of Peak Output Power

For systems using digital modulation in the 2400-2483.5MHz, the limit for peak output power is 30dBm. If transmitting antenna of directional gain greater than 6dBi is used, the peak output power from the intentional radiator shall be reduced below the above stated value by the amount in dB that the directional gain of the antenna exceeds 6 dBi. In case of point-to-point operation, the limit has to be reduced by 1dB for every 3dB that the directional gain of the antenna exceeds 6dBi.

3.2.2 Measuring Instruments

The section 4.0 of List of Measuring Equipment of this test report is used for test.

3.2.3 Test Procedures

1. The testing follows the Measurement Procedure of FCC KDB No. 558074 DTS D01 Meas. Guidance v03r01.
2. The RF output of EUT was connected to the power meter by RF cable and attenuator. The path loss was compensated to the results for each measurement.
3. Set to the maximum power setting and enable the EUT transmit continuously.
4. Measure the conducted output power and record the results in the test report.

3.2.4 Test Setup

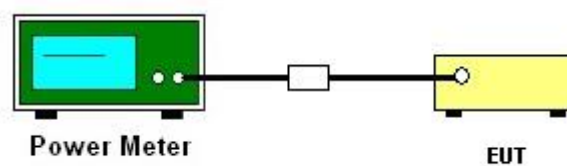



3.2.5 Test Result of Peak Output Power

Test Mode :	Bluetooth 4.0 - LE	Temperature :	22~25°C
Test Engineer :	Alex Lee	Relative Humidity :	51~55%

Channel	Frequency (MHz)	RF Power (dBm)		
		GFSK	Max. Limits (dBm)	Pass/Fail
		1 Mbps		
00	2402	7.18	30.00	Pass
19	2440	7.66	30.00	Pass
39	2480	7.75	30.00	Pass

3.3 Power Spectral Density Measurement

3.3.1 Limit of Power Spectral Density

The peak power spectral density shall not be greater than 8dBm in any 3kHz band at any time interval of continuous transmission.

3.3.2 Measuring Instruments

The section 4.0 of List of Measuring Equipment of this test report is used for test.

3.3.3 Test Procedures

1. The testing follows Measurement Procedure 10.2 Method PKPSD of FCC KDB Publication No. 558074 D01 DTS Meas. Guidance v03r01
2. The RF output of EUT was connected to the spectrum analyzer by RF cable and attenuator. The path loss was compensated to the results for each measurement.
3. Set to the maximum power setting and enable the EUT transmit continuously.
4. Make the measurement with the spectrum analyzer's resolution bandwidth (RBW) = 3 kHz. Video bandwidth VBW = 10 kHz In order to make an accurate measurement, set the span to 1.5 times DTS Channel Bandwidth. (6dB BW)
5. Detector = peak, Sweep time = auto couple, Trace mode = max hold, Allow trace to fully stabilize. Use the peak marker function to determine the maximum power level.
6. Measure and record the results in the test report.
7. The Measured power density (dBm)/ 100kHz is a reference level and used as 20dBc down limit line for Conducted Band Edges and Conducted Spurious Emission.

3.3.4 Test Setup

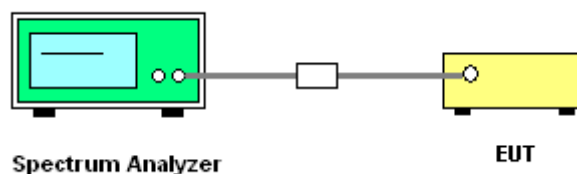



3.3.5 Test Result of Power Spectral Density

Test Mode :	Bluetooth 4.0 - LE	Temperature :	22~25°C
Test Engineer :	Alex Lee	Relative Humidity :	51~55%

Channel	Frequency (MHz)	Power Density		Max. Limits (dBm/3kHz)	Pass/Fail
		PSD/100kHz (dBm)	PSD/3kHz (dBm)		
00	2402	6.34	-7.57	8	Pass
19	2440	7.02	-6.91	8	Pass
39	2480	6.94	-7.00	8	Pass

Note:

1. Measured power density (dBm) has offset with cable loss.
2. The Measured power density (dBm)/ 100kHz is reference level and used as 20dBc down for Conducted Band Edges and Conducted Spurious Emission limit line.



3.3.6 Test Result of Power Spectral Density Plots (100kHz)

PSD 100kHz Plot on Channel 00

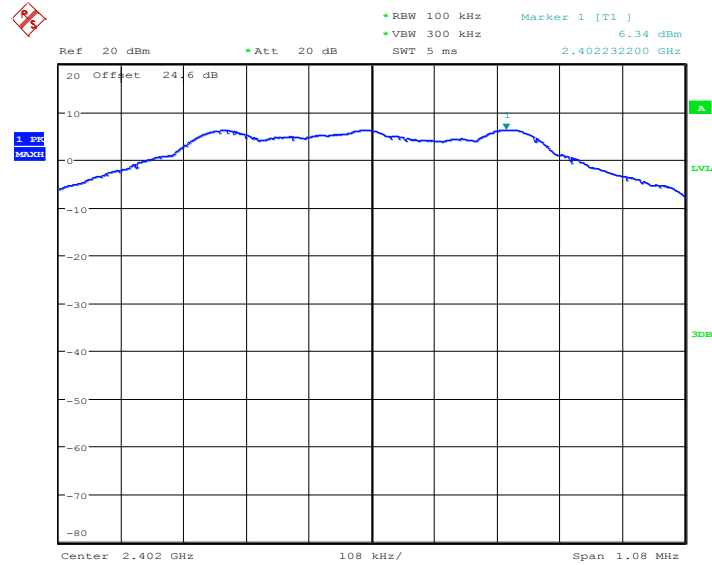

Date: 24.APR.2014 00:07:17



PSD 100kHz Plot on Channel 19

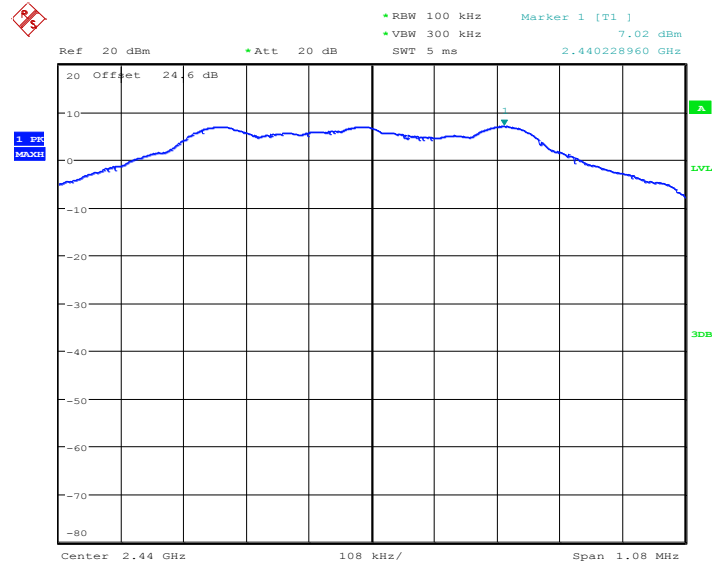

Date: 24.APR.2014 00:09:55

PSD 100kHz Plot on Channel 39

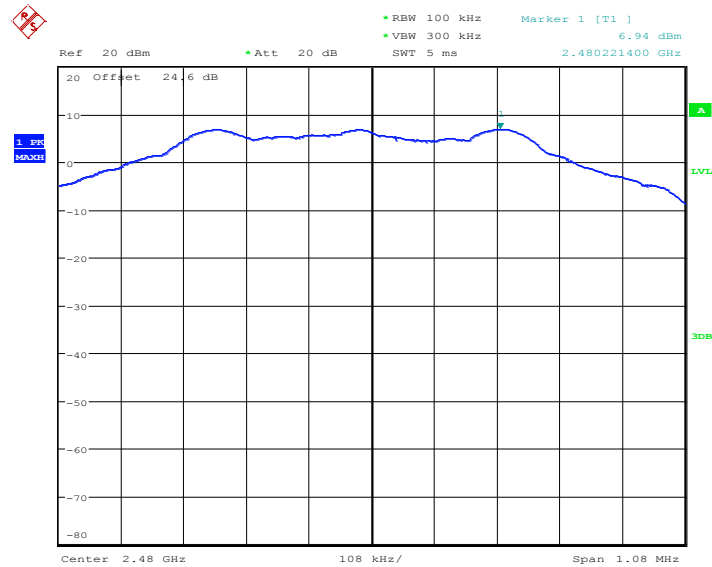

Date: 24.APR.2014 00:12:09



3.3.7 Test Result of Power Spectral Density Plots (3kHz)

PSD 3kHz Plot on Channel 00

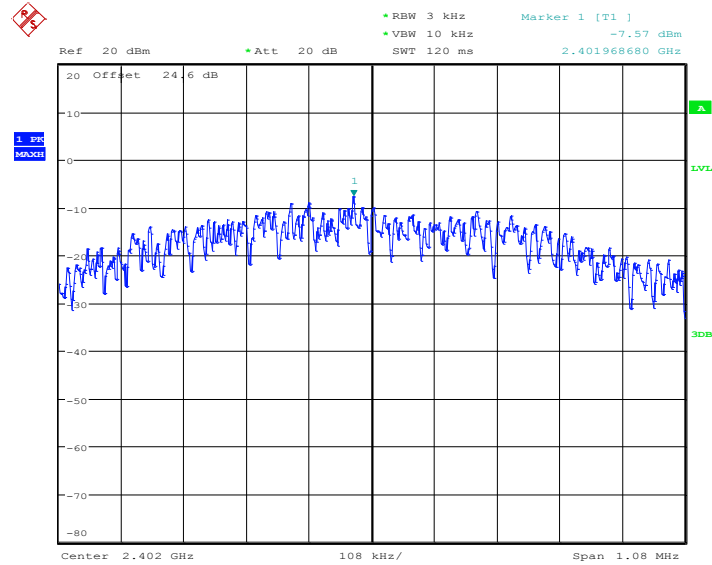

Date: 24.APR.2014 00:07:09



PSD 3kHz Plot on Channel 19

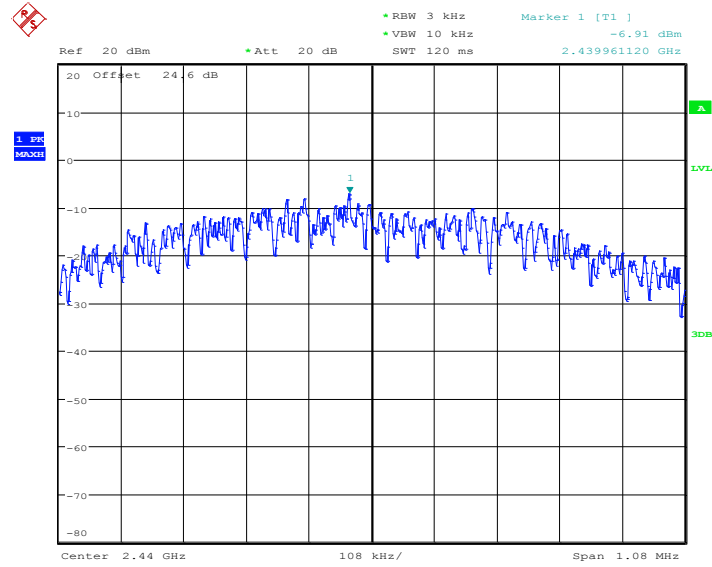

Date: 24.APR.2014 00:09:47

PSD 3kHz Plot on Channel 39

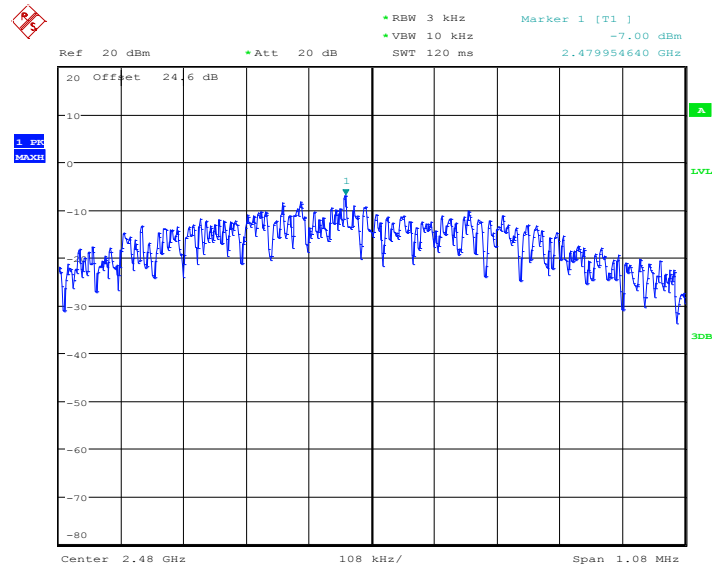

Date: 24.APR.2014 00:12:01

3.4 Conducted Band Edges and Spurious Emission Measurement

3.4.1 Limit of Conducted Band Edges and Spurious Emission

All harmonics/spurious must be at least 20 dB down from the highest emission level within the authorized band.

3.4.2 Measuring Instruments

The section 4.0 of List of Measuring Equipment of this test report is used for test.

3.4.3 Test Procedure

1. The testing follows FCC KDB Publication No. 558074 D01 DTS Meas. Guidance v03r01.
2. The RF output of EUT was connected to the spectrum analyzer by RF cable and attenuator. The path loss was compensated to the results for each measurement.
3. Set to the maximum power setting and enable the EUT transmit continuously.
4. Set RBW = 100 kHz, VBW=300 kHz, Peak Detector. Unwanted Emissions measured in any 100 kHz bandwidth outside of the authorized frequency band shall be attenuated by at least 20 dB relative to the maximum in-band peak PSD level in 100 kHz when maximum peak conducted output power procedure is used. If the transmitter complies with the conducted power limits based on the use of RMS averaging over a time interval, the attenuation required under this paragraph shall be 30 dB instead of 20 dB per 15.247(d).
5. Measure and record the results in the test report.
6. The RF fundamental frequency should be excluded against the limit line in the operating frequency band.

3.4.4 Test Setup

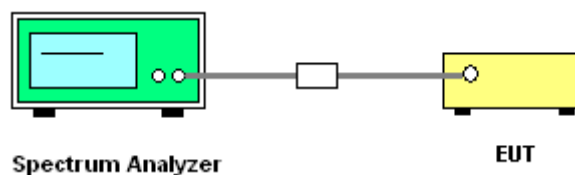



3.4.5 Test Result of Conducted Band Edges

Test Mode :	Bluetooth 4.0 - LE	Temperature :	22~25°C
Test Channel :	00 and 39	Relative Humidity :	51~55%
		Test Engineer :	Alex Lee

Low Band Edge Plot on Channel 00

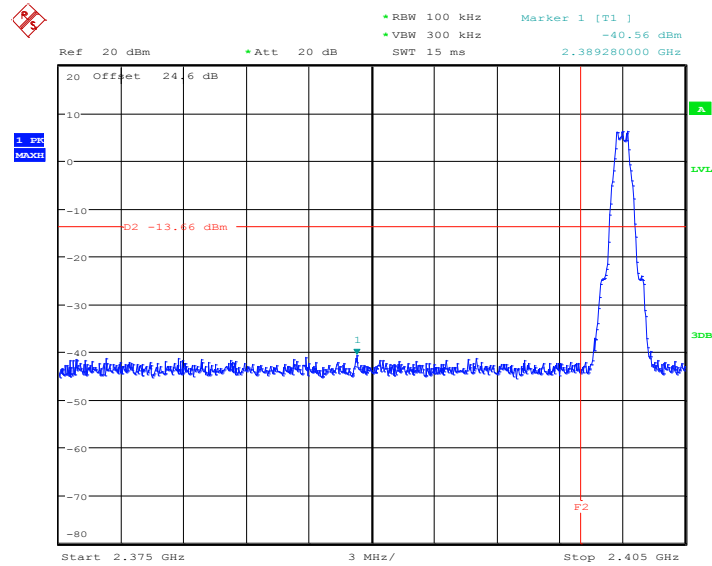

Date: 24.APR.2014 00:07:30



High Band Edge Plot on Channel 39

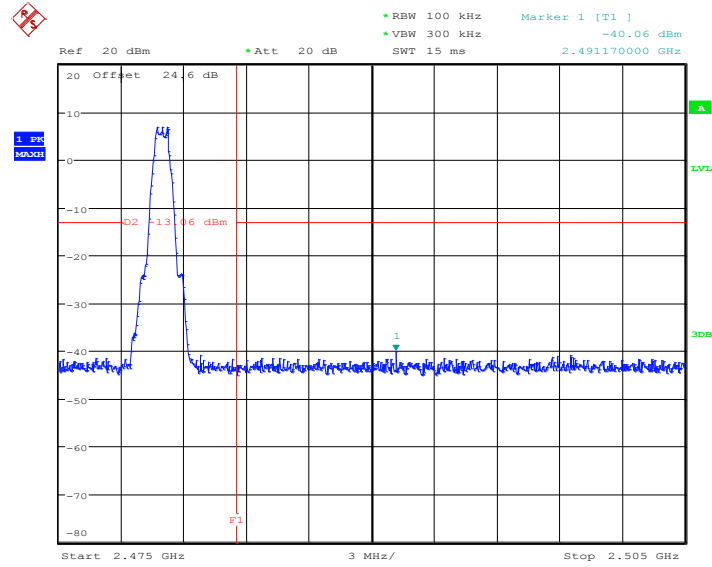

Date: 24.APR.2014 00:12:22



3.4.6 Test Result of Conducted Spurious Emission

Test Mode :	Bluetooth 4.0 - LE	Temperature :	22~25°C
Test Channel :	00	Relative Humidity :	51~55%
		Test Engineer :	Alex Lee

Conducted Spurious Emission Plot on Bluetooth LE 1Mbps GFSK Channel 00

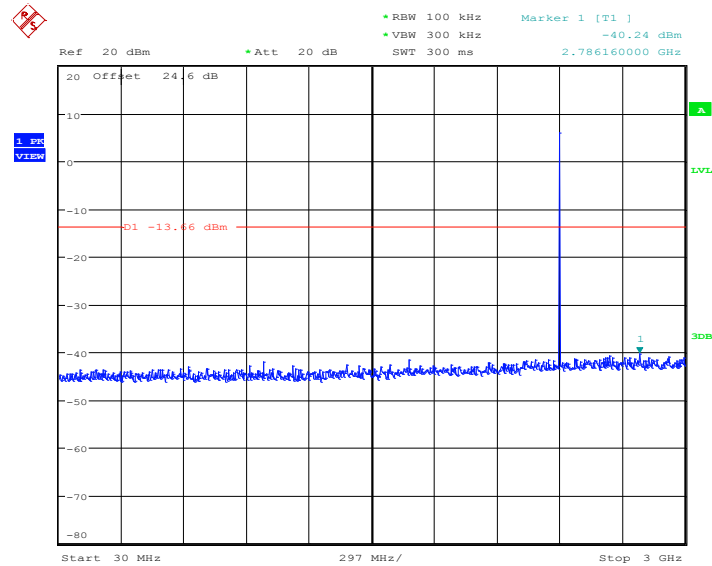

Date: 24.APR.2014 00:07:49



Conducted Spurious Emission Plot on Bluetooth LE 1Mbps
GFSK Channel 00

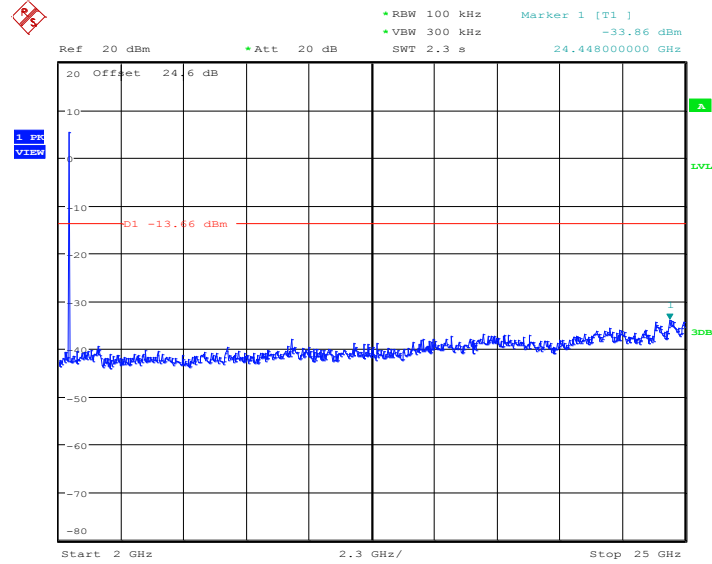

Date: 24.APR.2014 00:08:07



Test Mode :	Bluetooth 4.0 - LE	Temperature :	22~25°C
Test Channel :	19	Relative Humidity :	51~55%
		Test Engineer :	Alex Lee

Conducted Spurious Emission Plot on Bluetooth LE 1Mbps
GFSK Channel 19

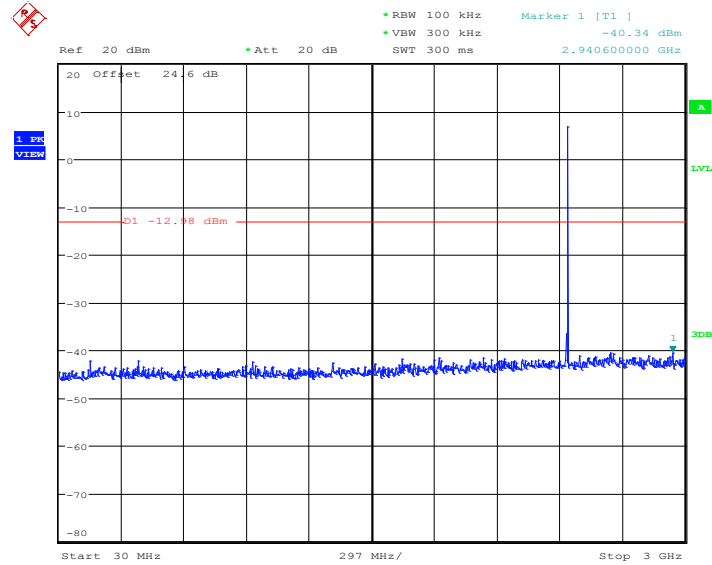

Date: 24.APR.2014 00:10:13



Conducted Spurious Emission Plot on Bluetooth LE 1Mbps
GFSK Channel 19

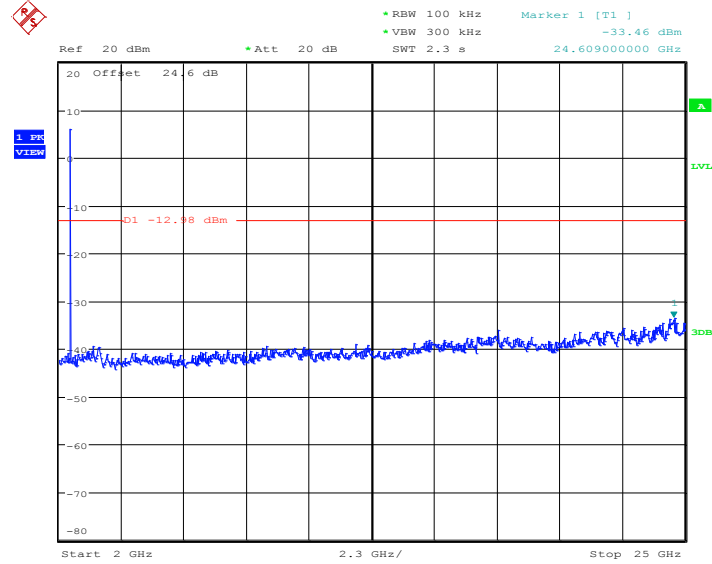

Date: 24.APR.2014 00:10:31



Test Mode :	Bluetooth 4.0 - LE	Temperature :	22~25°C
Test Channel :	39	Relative Humidity :	51~55%
		Test Engineer :	Alex Lee

Conducted Spurious Emission Plot on Bluetooth LE 1Mbps
GFSK Channel 39

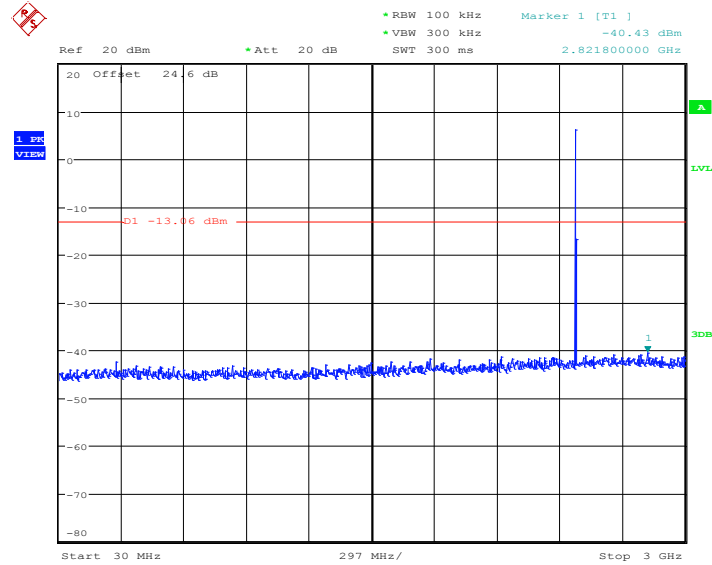

Date: 24.APR.2014 00:12:40



Conducted Spurious Emission Plot on Bluetooth LE 1Mbps
GFSK Channel 39

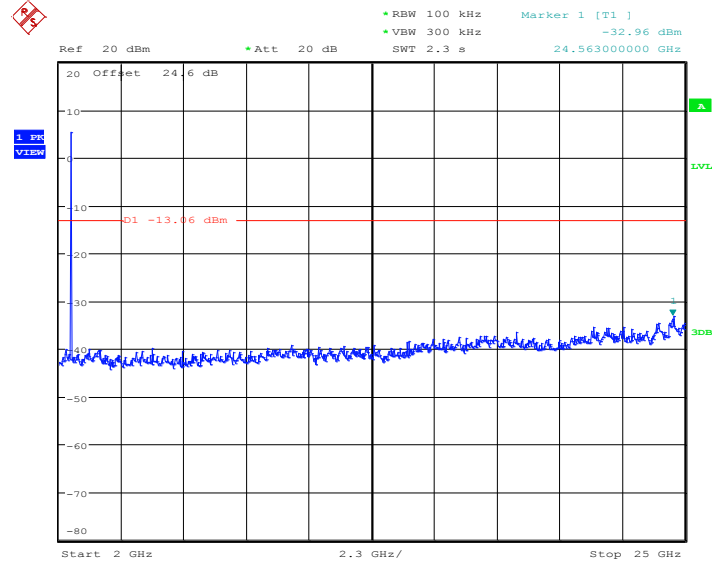

Date: 24.APR.2014 00:12:58



3.5 Radiated Band Edges and Spurious Emission Measurement

3.5.1 Limit of Radiated Band Edges and Spurious Emission

In any 100 kHz bandwidth outside the intentional radiator frequency band, all harmonics/spurious must be at least 20 dB below the highest emission level within the authorized band. If the output power of this device was measured by spectrum analyzer, the attenuation under this paragraph shall be 30 dB instead of 20 dB. In addition, radiated emissions which fall in the restricted bands must also comply with the FCC section 15.209 limits as below.

Frequency (MHz)	Field Strength (microvolts/meter)	Measurement Distance (meters)
0.009 – 0.490	2400/F(kHz)	300
0.490 – 1.705	24000/F(kHz)	30
1.705 – 30.0	30	30
30 – 88	100	3
88 – 216	150	3
216 - 960	200	3
Above 960	500	3

3.5.2 Measuring Instruments

The section 4.0 of List of Measuring Equipment of this test report is used for test.



3.5.3 Test Procedures

1. The testing follows FCC KDB Publication No. 558074 D01 DTS Meas. Guidance v03r01.
2. The EUT was arranged to its worst case and then tune the antenna tower (from 1 m to 4 m) and turntable (from 0 degree to 360 degrees) to find the maximum reading. A pre-amp and a high pass filter are used for the test in order to get better signal level.
3. The EUT was placed on a turntable with 0.8 meter above ground.
4. The EUT was set 3 meters from the interference receiving antenna, which was mounted on the top of a variable height antenna tower.
5. Corrected Reading: Antenna Factor + Cable Loss + Read Level - Preamp Factor = Level
6. For measurement below 1GHz, If the emission level of the EUT measured by the peak detector is 3 dB lower than the applicable limit, the peak emission level will be reported. Otherwise, the emission measurement will be repeated using the quasi-peak detector and reported.
7. Use the following spectrum analyzer settings:
 - (1) Span shall wide enough to fully capture the emission being measured;
 - (2) Set RBW=100 kHz for $f < 1$ GHz; $VBW \geq RBW$; Sweep = auto; Detector function = peak; Trace = max hold;
 - (3) Set RBW = 1 MHz, VBW= 3MHz for $f \geq 1$ GHz for peak measurement.

For average measurement:

 - $VBW = 10$ Hz, when duty cycle is no less than 98 percent.
 - $VBW \geq 1/T$, when duty cycle is less than 98 percent where T is the minimum transmission duration over which the transmitter is on and is transmitting at its maximum power control level for the tested mode of operation.

Band	Duty Cycle(%)	T(μs)	1/T(kHz)	VBW Setting
Bluetooth 4.0 - LE	61.90	390.00	2.56	3kHz

3.5.4 Test Setup

For radiated emissions below 30MHz

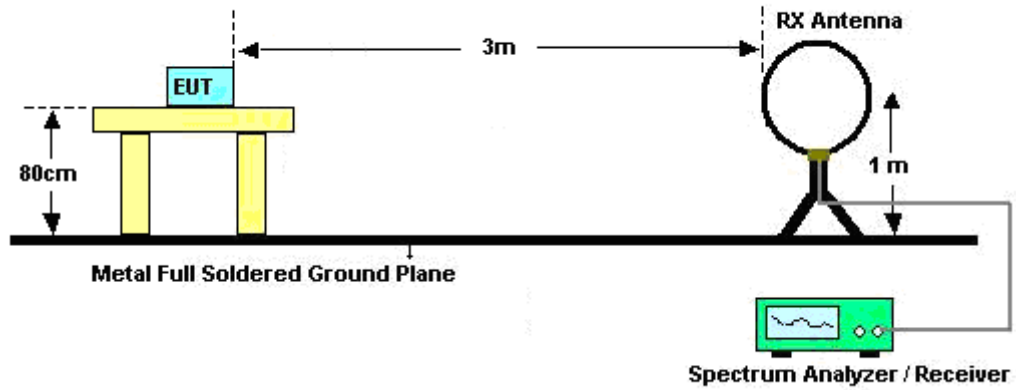

For radiated emissions from 30MHz to 1GHz

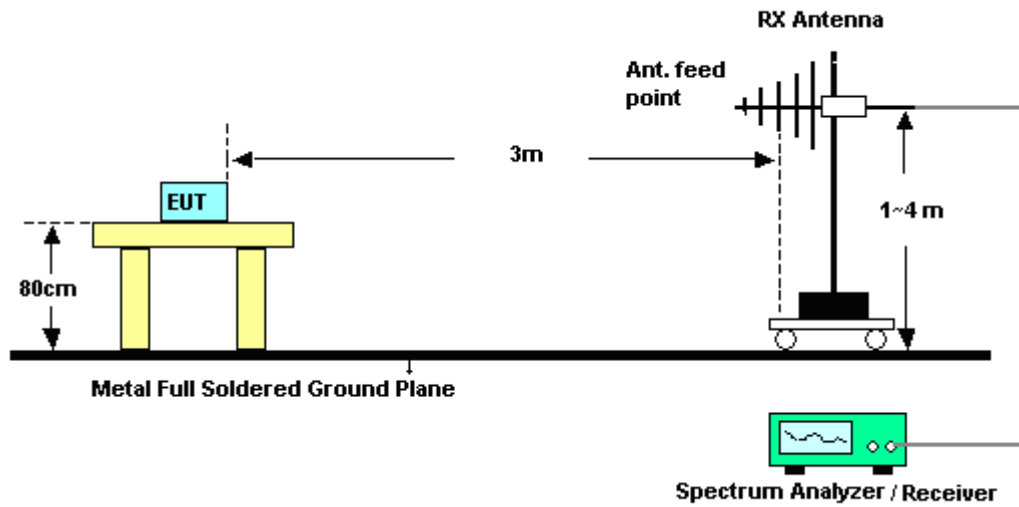

For radiated emissions above 1GHz

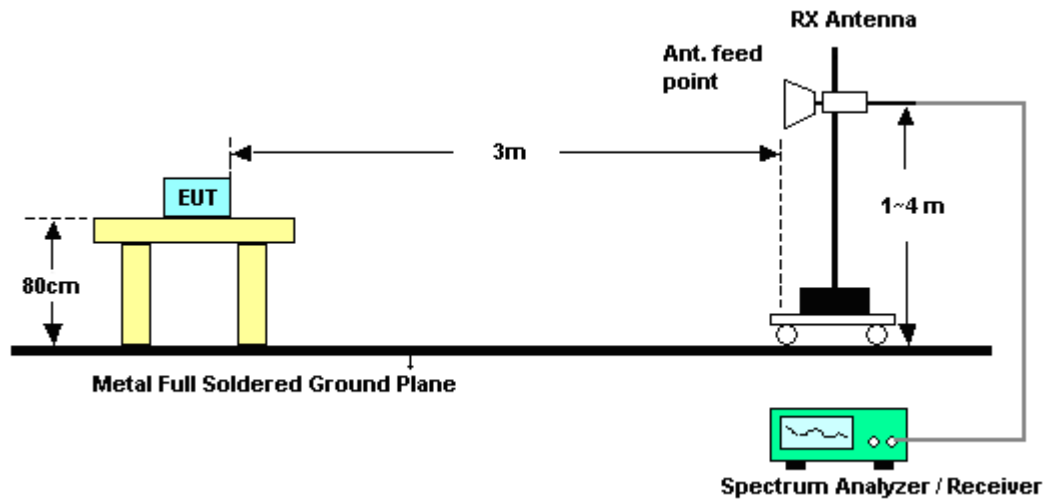

3.5.5 Test Results of Radiated Spurious Emissions (9 kHz ~ 30 MHz)

The low frequency, which started from 9 kHz to 30MHz, was pre-scanned and the result which was 20dB lower than the limit line per 15.31(o) was not reported.



3.5.6 Test Result of Radiated Spurious at Band Edges

Test Mode :	Mode 1	Temperature :	21~23°C
Test Channel :	00	Relative Humidity :	45~48%
		Test Engineer :	Stan Hsieh

ANTENNA POLARITY : HORIZONTAL										
Frequency (MHz)	Level (dBμV /m)	Over Limit (dB)	Limit Line (dBμV /m)	Read Level (dBμV)	Antenna Factor (dB)	Cable Loss (dB)	Preamp Factor (dB)	Ant Pos (cm)	Table Pos (deg)	Remark
2374.44	46.81	-27.19	74	41.92	32.28	6.88	34.27	113	356	Peak
2327.19	35.28	-18.72	54	30.47	32.23	6.8	34.22	113	356	Average

ANTENNA POLARITY : VERTICAL										
Frequency (MHz)	Level (dBμV /m)	Over Limit (dB)	Limit Line (dBμV /m)	Read Level (dBμV)	Antenna Factor (dB)	Cable Loss (dB)	Preamp Factor (dB)	Ant Pos (cm)	Table Pos (deg)	Remark
2385.69	46.03	-27.97	74	41.09	32.3	6.91	34.27	100	264	Peak
2319.45	33.66	-20.34	54	28.85	32.23	6.8	34.22	100	264	Average

Test Mode :	Mode 3	Temperature :	21~23°C
Test Channel :	39	Relative Humidity :	45~48%
		Test Engineer :	Stan Hsieh

ANTENNA POLARITY : HORIZONTAL										
Frequency (MHz)	Level (dBμV /m)	Over Limit (dB)	Limit Line (dBμV /m)	Read Level (dBμV)	Antenna Factor (dB)	Cable Loss (dB)	Preamp Factor (dB)	Ant Pos (cm)	Table Pos (deg)	Remark
2483.68	50.5	-23.5	74	45.49	32.38	7.06	34.43	104	352	Peak
2483.53	36.91	-17.09	54	31.9	32.38	7.06	34.43	104	352	Average

ANTENNA POLARITY : VERTICAL										
Frequency (MHz)	Level (dBμV /m)	Over Limit (dB)	Limit Line (dBμV /m)	Read Level (dBμV)	Antenna Factor (dB)	Cable Loss (dB)	Preamp Factor (dB)	Ant Pos (cm)	Table Pos (deg)	Remark
2484.22	47.41	-26.59	74	42.4	32.38	7.06	34.43	153	238	Peak
2484.04	34.78	-19.22	54	29.77	32.38	7.06	34.43	153	238	Average

3.5.7 Test Result of Radiated Spurious Emission (30MHz ~ 10th Harmonic)

Note: Pre-scanned all test modes and only choose the worst case mode recorded in the test report for radiated spurious emission below 1GHz.

Test Mode :	Mode 1	Temperature :	21~23°C
Test Channel :	00	Relative Humidity :	45~48%
Test Engineer :	Stan Hsieh	Polarization :	Horizontal
Remark :	<ol style="list-style-type: none"> 2402 MHz is fundamental signal which can be ignored. 3201 MHz is not within a restricted band, and its limit line is 20dB below the highest emission level. For example, 109.5 dBµV/m - 20dB = 89.5 dBµV/m. Average measurement was not performed if peak level went lower than the average limit. 		

Frequency (MHz)	Level (dBµV/m)	Over Limit (dB)	Limit Line (dBµV/m)	Read Level (dBµV)	Antenna Factor (dB)	Cable Loss (dB)	Preamp Factor (dB)	Ant Pos (cm)	Table Pos (deg)	Remark
2402	108.34	-	-	103.43	32.3	6.91	34.3	113	356	Average
2402	109.5	-	-	104.59	32.3	6.91	34.3	113	356	Peak
3201	53.73	-35.77	89.5	72.6	32.76	6.89	58.52	100	330	Peak
4803	39.87	-34.13	74	56.1	33.98	8.75	58.96	100	0	Peak

Note: Other harmonics are lower than background noise.

Test Mode :	Mode 1	Temperature :	21~23°C
Test Channel :	00	Relative Humidity :	45~48%
Test Engineer :	Stan Hsieh	Polarization :	Vertical
Remark :	<ol style="list-style-type: none"> 2402 MHz is fundamental signal which can be ignored. 3201 MHz is not within a restricted band, and its limit line is 20dB below the highest emission level. Average measurement was not performed if peak level went lower than the average limit. 		

Frequency (MHz)	Level (dBµV/m)	Over Limit (dB)	Limit Line (dBµV/m)	Read Level (dBµV)	Antenna Factor (dB)	Cable Loss (dB)	Preamp Factor (dB)	Ant Pos (cm)	Table Pos (deg)	Remark
2402	103.81	-	-	98.9	32.3	6.91	34.3	100	264	Average
2402	105.1	-	-	100.19	32.3	6.91	34.3	100	264	Peak
3201	47.74	-37.36	85.1	66.61	32.76	6.89	58.52	100	0	Peak
4803	40.92	-33.08	74	57.15	33.98	8.75	58.96	100	0	Peak

Note: Other harmonics are lower than background noise.



Test Mode :	Mode 2	Temperature :	21~23°C
Test Channel :	19	Relative Humidity :	45~48%
Test Engineer :	Stan Hsieh	Polarization :	Horizontal
Remark :	1. 2442 MHz is fundamental signal which can be ignored. 2. 3252 MHz is not within a restricted band, and its limit line is 20dB below the highest emission level. 3. Average measurement was not performed if peak level went lower than the average limit.		

Frequency (MHz)	Level (dBμV/m)	Over Limit (dB)	Limit Line (dBμV/m)	Read Level (dBμV)	Antenna Factor (dB)	Cable Loss (dB)	Preamp Factor (dB)	Ant Pos (cm)	Table Pos (deg)	Remark
2442	107.81	-	-	102.86	32.35	6.99	34.39	106	350	Average
2442	109.1	-	-	104.15	32.35	6.99	34.39	106	350	Peak
3252	50.64	-38.46	89.1	69.51	32.75	6.96	58.58	100	0	Peak
4881	39.41	-34.59	74	55.44	33.95	8.85	58.83	100	0	Peak
7320	41.87	-32.13	74	53.17	35.53	10.91	57.74	100	0	Peak

Note: Other harmonics are lower than background noise.

Test Mode :	Mode 2	Temperature :	21~23°C
Test Channel :	19	Relative Humidity :	45~48%
Test Engineer :	Stan Hsieh	Polarization :	Vertical
Remark :	1. 2442 MHz is fundamental signal which can be ignored. 2. 3252 MHz is not within a restricted band, and its limit line is 20dB below the highest emission level. 3. Average measurement was not performed if peak level went lower than the average limit.		

Frequency (MHz)	Level (dBμV/m)	Over Limit (dB)	Limit Line (dBμV/m)	Read Level (dBμV)	Antenna Factor (dB)	Cable Loss (dB)	Preamp Factor (dB)	Ant Pos (cm)	Table Pos (deg)	Remark
2442	103.16	-	-	98.21	32.35	6.99	34.39	194	263	Average
2442	104.45	-	-	99.5	32.35	6.99	34.39	194	263	Peak
3252	44.18	-40.27	84.45	63.05	32.75	6.96	58.58	100	0	Peak
4881	40.63	-33.37	74	56.66	33.95	8.85	58.83	100	0	Peak
7320	42.01	-31.99	74	53.31	35.53	10.91	57.74	100	0	Peak

Note: Other harmonics are lower than background noise.



Test Mode :	Mode 3	Temperature :	21~23°C
Test Channel :	39	Relative Humidity :	45~48%
Test Engineer :	Stan Hsieh	Polarization :	Horizontal
Remark :	1. 2480 MHz is fundamental signal which can be ignored. 2. 3306 MHz is not within a restricted band, and its limit line is 20dB below the highest emission level. 3. Average measurement was not performed if peak level went lower than the average limit.		

Frequency (MHz)	Level (dBμV/m)	Over Limit (dB)	Limit Line (dBμV/m)	Read Level (dBμV)	Antenna Factor (dB)	Cable Loss (dB)	Preamp Factor (dB)	Ant Pos (cm)	Table Pos (deg)	Remark
37.56	23.08	-16.92	40	38.84	14.88	0.6	31.24	110	221	Peak
61.86	15	-25	40	39.48	6	0.78	31.26	-	-	Peak
118.29	19.48	-24.02	43.5	38.21	11.29	1.09	31.11	-	-	Peak
311.9	16.89	-29.11	46	32.78	13.32	1.79	31	-	-	Peak
493.2	18.86	-27.14	46	29.16	17.94	2.43	30.67	-	-	Peak
740.3	24.08	-21.92	46	29.24	22.2	3.04	30.4	-	-	Peak
2480	107.38	-	-	102.37	32.38	7.06	34.43	104	352	Average
2480	108.72	-	-	103.71	32.38	7.06	34.43	104	352	Peak
3306	47.09	-41.63	88.72	65.97	32.74	7.03	58.65	100	0	Peak
4959	40.49	-33.51	74	56.32	33.91	8.92	58.66	100	0	Peak
7440	40.94	-33.06	74	52.24	35.51	11.04	57.85	100	0	Peak

Note: Other harmonics are lower than background noise.



Test Mode :	Mode 3	Temperature :	21~23°C
Test Channel :	39	Relative Humidity :	45~48%
Test Engineer :	Stan Hsieh	Polarization :	Vertical
Remark :	1. 2480 MHz is fundamental signal which can be ignored. 2. 3306 MHz is not within a restricted band, and its limit line is 20dB below the highest emission level. 3. Average measurement was not performed if peak level went lower than the average limit.		

Frequency (MHz)	Level (dBμV/m)	Over Limit (dB)	Limit Line (dBμV/m)	Read Level (dBμV)	Antenna Factor (dB)	Cable Loss (dB)	Preamp Factor (dB)	Ant Pos (cm)	Table Pos (deg)	Remark
41.34	24.83	-15.17	40	42.8	12.6	0.63	31.2	-	-	Peak
66.18	25.03	-14.97	40	49.36	6.08	0.81	31.22	125	169	Peak
106.95	26.28	-17.22	43.5	45.8	10.62	1.03	31.17	-	-	Peak
351.1	15.77	-30.23	46	30.41	14.43	1.98	31.05	-	-	Peak
484.1	21	-25	46	31.65	17.72	2.39	30.76	-	-	Peak
749.4	24.41	-21.59	46	29.65	22.1	3.06	30.4	-	-	Peak
2480	102.59	-	-	97.58	32.38	7.06	34.43	153	238	Average
2480	103.85	-	-	98.84	32.38	7.06	34.43	153	238	Peak
3306	42.27	-41.58	83.85	61.15	32.74	7.03	58.65	100	0	Peak
4959	39.69	-34.31	74	55.52	33.91	8.92	58.66	100	0	Peak
7440	39.77	-34.23	74	51.07	35.51	11.04	57.85	100	0	Peak

Note: Other harmonics are lower than background noise.

3.6 AC Conducted Emission Measurement

3.6.1 Limit of AC Conducted Emission

For equipment that is designed to be connected to the public utility (AC) power line, the radio frequency voltage that is conducted back onto the AC power line on any frequency or frequencies within the band 150 kHz to 30 MHz shall not exceed the limits in the following table.

Frequency of emission (MHz)	Conducted limit (dB μ V)	
	Quasi-peak	Average
0.15-0.5	66 to 56*	56 to 46*
0.5-5	56	46
5-30	60	50

*Decreases with the logarithm of the frequency.

3.6.2 Measuring Instruments

The section 4.0 of List of Measuring Equipment of this test report is used for test.

3.6.3 Test Procedures

1. The EUT was placed 0.4 meter from the conducting wall of the shielding room was kept at least 80 centimeters from any other grounded conducting surface.
2. Connect EUT to the power mains through a line impedance stabilization network (LISN).
3. All the support units are connecting to the other LISN.
4. The LISN provides 50 ohm coupling impedance for the measuring instrument.
5. The FCC states that a 50 ohm, 50 microhenry LISN should be used.
6. Both sides of AC line were checked for maximum conducted interference.
7. The frequency range from 150 kHz to 30 MHz was searched.
8. Set the test-receiver system to Peak Detect Function and specified bandwidth with Maximum Hold Mode.

3.6.4 Test Setup



3.6.5 Test Result of AC Conducted Emission

Test Mode :	Mode 1	Temperature :	20~22°C
Test Engineer :	Cosmo Xu	Relative Humidity :	45~47%
Test Voltage :	120Vac / 60Hz	Phase :	Line
Function Type :	GSM850 (GPRS class 8) Idle + Bluetooth Link + TC+ TF + GPS Rx + Battery 2 + Bluetooth Base (Charging from Adapter 1) + USB flash drive + Micro USB Cable (Data Link with notebook) + RJ-45 (Load) + RJ-11 (Load) + RS232 (Load)		

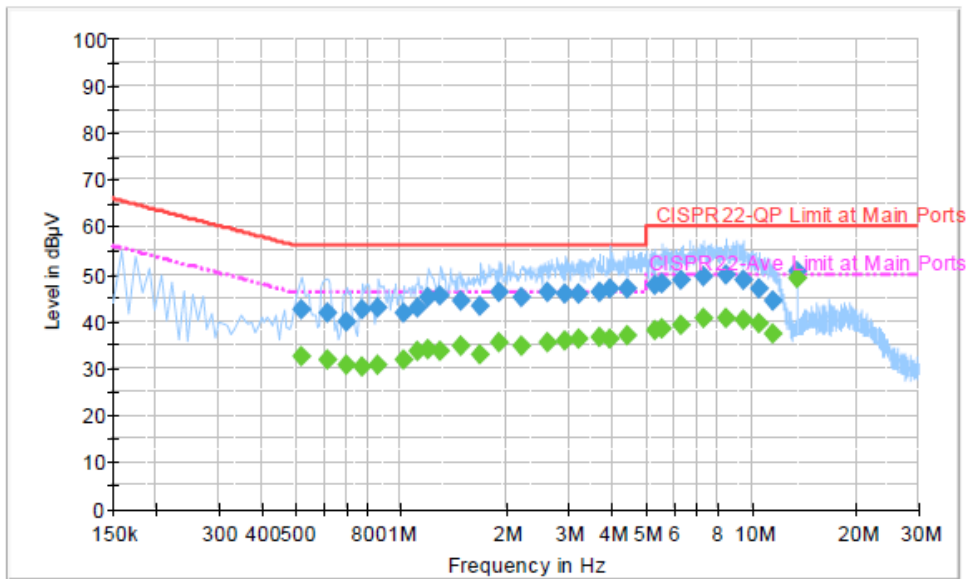

Final Result : Quasi-Peak

Frequency (MHz)	Quasi-Peak (dBµV)	Filter	Line	Corr. (dB)	Margin (dB)	Limit (dBµV)
0.518000	42.6	Off	L1	19.3	13.4	56.0
0.614000	41.7	Off	L1	19.4	14.3	56.0
0.702000	39.9	Off	L1	19.5	16.1	56.0
0.774000	42.5	Off	L1	19.4	13.5	56.0
0.862000	42.7	Off	L1	19.5	13.3	56.0
1.014000	41.6	Off	L1	19.5	14.4	56.0
1.118000	42.8	Off	L1	19.5	13.2	56.0
1.198000	45.0	Off	L1	19.6	11.0	56.0
1.294000	45.3	Off	L1	19.5	10.7	56.0
1.486000	44.2	Off	L1	19.5	11.8	56.0
1.686000	43.3	Off	L1	19.5	12.7	56.0
1.894000	46.3	Off	L1	19.6	9.7	56.0
2.214000	45.2	Off	L1	19.6	10.8	56.0
2.614000	46.0	Off	L1	19.6	10.0	56.0
2.950000	45.8	Off	L1	19.6	10.2	56.0



Test Mode :	Mode 1	Temperature :	20~22°C
Test Engineer :	Cosmo Xu	Relative Humidity :	45~47%
Test Voltage :	120Vac / 60Hz	Phase :	Line
Function Type :	GSM850 (GPRS class 8) Idle + Bluetooth Link + TC+ TF + GPS Rx + Battery 2 + Bluetooth Base (Charging from Adapter 1) + USB flash drive + Micro USB Cable (Data Link with notebook) + RJ-45 (Load) + RJ-11 (Load) + RS232 (Load)		

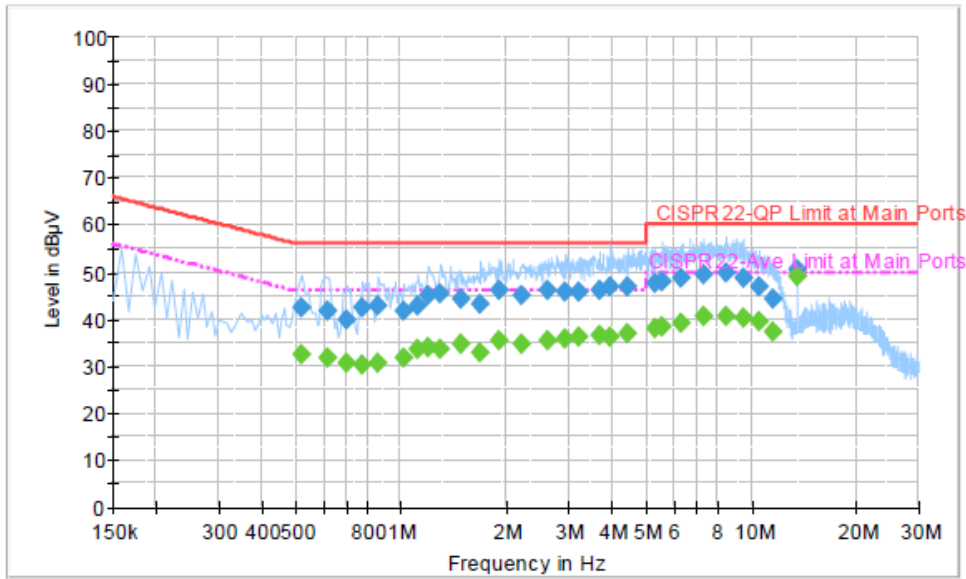

Final Result : Quasi-Peak

Frequency (MHz)	Quasi-Peak (dBµV)	Filter	Line	Corr. (dB)	Margin (dB)	Limit (dBµV)
3.222000	45.8	Off	L1	19.6	10.2	56.0
3.678000	46.0	Off	L1	19.6	10.0	56.0
3.942000	46.7	Off	L1	19.6	9.3	56.0
4.446000	47.0	Off	L1	19.6	9.0	56.0
5.294000	47.8	Off	L1	19.6	12.2	60.0
5.574000	48.1	Off	L1	19.6	11.9	60.0
6.278000	48.5	Off	L1	19.6	11.5	60.0
7.286000	49.4	Off	L1	19.6	10.6	60.0
8.430000	49.8	Off	L1	19.6	10.2	60.0
9.470000	48.8	Off	L1	19.7	11.2	60.0
10.502000	46.9	Off	L1	19.7	13.1	60.0
11.566000	44.3	Off	L1	19.7	15.7	60.0
13.558000	50.7	Off	L1	19.8	9.3	60.0



Test Mode :	Mode 1	Temperature :	20~22°C
Test Engineer :	Cosmo Xu	Relative Humidity :	45~47%
Test Voltage :	120Vac / 60Hz	Phase :	Line
Function Type :	GSM850 (GPRS class 8) Idle + Bluetooth Link + TC+ TF + GPS Rx + Battery 2 + Bluetooth Base (Charging from Adapter 1) + USB flash drive + Micro USB Cable (Data Link with notebook) + RJ-45 (Load) + RJ-11 (Load) + RS232 (Load)		

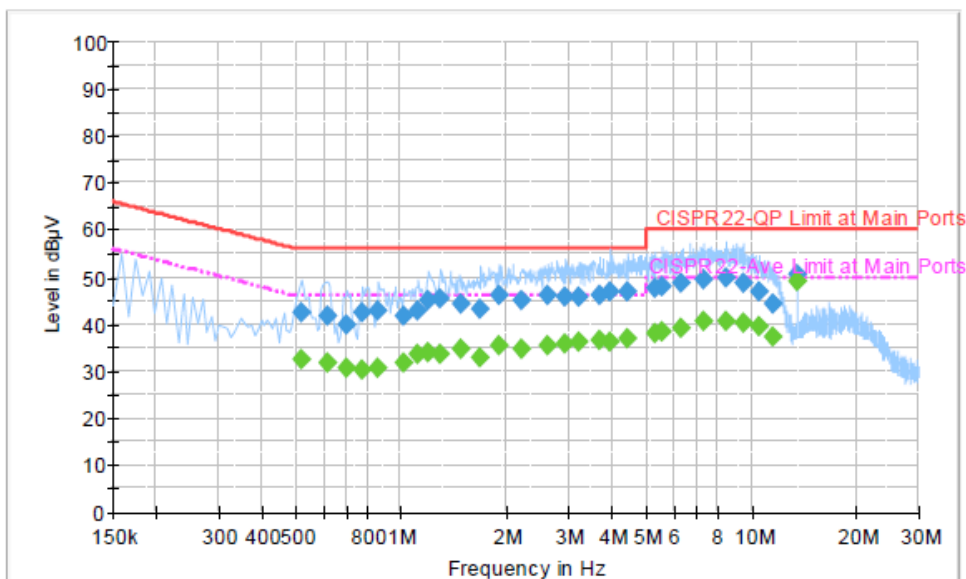

Final Result : Average

Frequency (MHz)	Average (dBµV)	Filter	Line	Corr. (dB)	Margin (dB)	Limit (dBµV)
0.518000	32.3	Off	L1	19.3	13.7	46.0
0.614000	31.7	Off	L1	19.4	14.3	46.0
0.702000	30.7	Off	L1	19.5	15.3	46.0
0.774000	30.1	Off	L1	19.4	15.9	46.0
0.862000	30.7	Off	L1	19.5	15.3	46.0
1.014000	31.7	Off	L1	19.5	14.3	46.0
1.118000	33.5	Off	L1	19.5	12.5	46.0
1.198000	33.8	Off	L1	19.6	12.2	46.0
1.294000	33.7	Off	L1	19.5	12.3	46.0
1.486000	34.9	Off	L1	19.5	11.1	46.0
1.686000	32.7	Off	L1	19.5	13.3	46.0
1.894000	35.6	Off	L1	19.6	10.4	46.0
2.214000	34.9	Off	L1	19.6	11.1	46.0
2.614000	35.3	Off	L1	19.6	10.7	46.0
2.950000	35.8	Off	L1	19.6	10.2	46.0



Test Mode :	Mode 1	Temperature :	20~22°C
Test Engineer :	Cosmo Xu	Relative Humidity :	45~47%
Test Voltage :	120Vac / 60Hz	Phase :	Line
Function Type :	GSM850 (GPRS class 8) Idle + Bluetooth Link + TC+ TF + GPS Rx + Battery 2 + Bluetooth Base (Charging from Adapter 1) + USB flash drive + Micro USB Cable (Data Link with notebook) + RJ-45 (Load) + RJ-11 (Load) + RS232 (Load)		

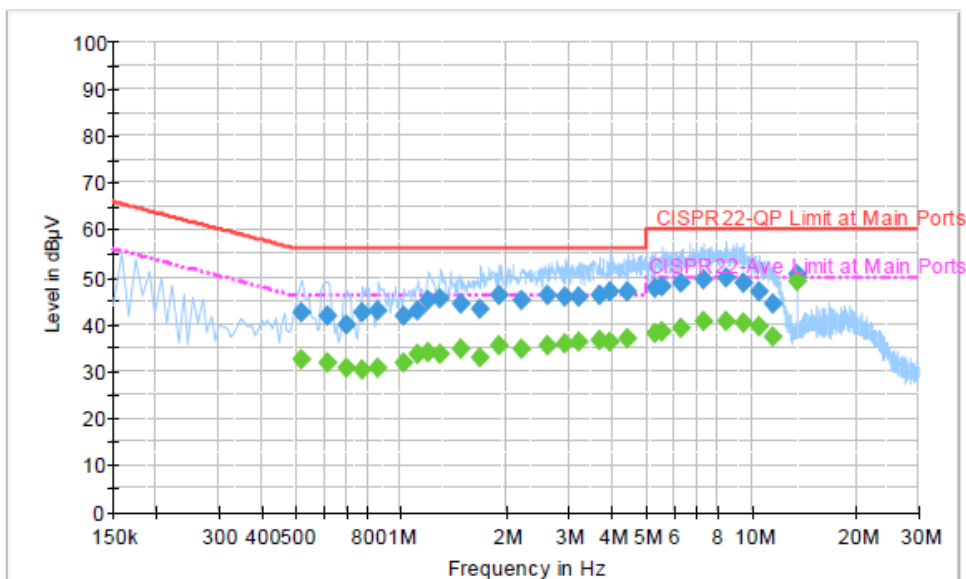

Final Result : Average

Frequency (MHz)	Average (dBµV)	Filter	Line	Corr. (dB)	Margin (dB)	Limit (dBµV)
3.222000	36.1	Off	L1	19.6	9.9	46.0
3.678000	36.6	Off	L1	19.6	9.4	46.0
3.942000	36.3	Off	L1	19.6	9.7	46.0
4.446000	36.9	Off	L1	19.6	9.1	46.0
5.294000	37.9	Off	L1	19.6	12.1	50.0
5.574000	38.4	Off	L1	19.6	11.6	50.0
6.278000	39.0	Off	L1	19.6	11.0	50.0
7.286000	40.4	Off	L1	19.6	9.6	50.0
8.430000	40.7	Off	L1	19.6	9.3	50.0
9.470000	40.1	Off	L1	19.7	9.9	50.0
10.502000	39.3	Off	L1	19.7	10.7	50.0
11.566000	37.2	Off	L1	19.7	12.8	50.0
13.558000	49.0	Off	L1	19.8	1.0	50.0



Test Mode :	Mode 1	Temperature :	20~22°C
Test Engineer :	Cosmo Xu	Relative Humidity :	45~47%
Test Voltage :	120Vac / 60Hz	Phase :	Neutral
Function Type :	GSM850 (GPRS class 8) Idle + Bluetooth Link + TC+ TF + GPS Rx + Battery 2 + Bluetooth Base (Charging from Adapter 1) + USB flash drive + Micro USB Cable (Data Link with notebook) + RJ-45 (Load) + RJ-11 (Load) + RS232 (Load)		

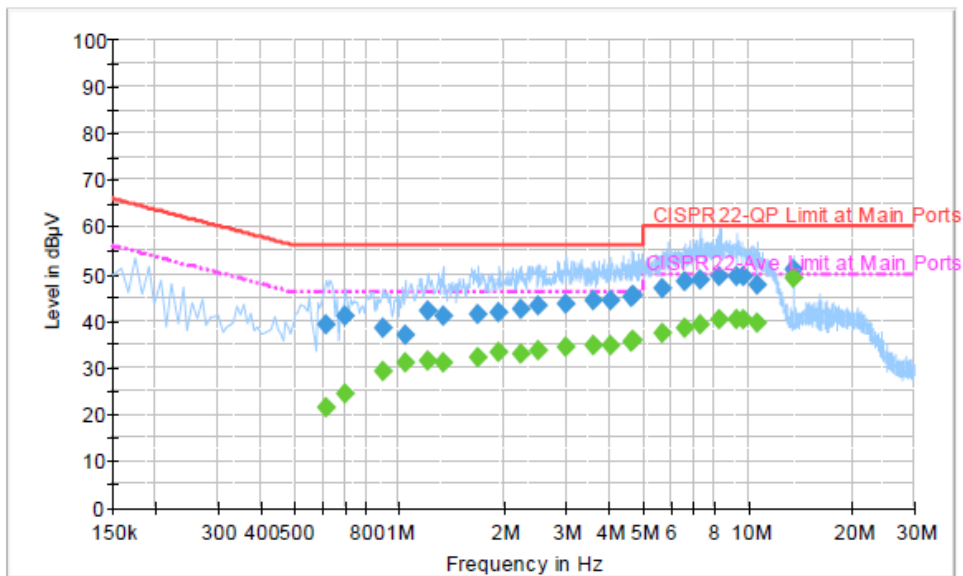

Final Result : Quasi-Peak

Frequency (MHz)	Quasi-Peak (dBµV)	Filter	Line	Corr. (dB)	Margin (dB)	Limit (dBµV)
0.614000	39.0	Off	N	19.4	17.0	56.0
0.702000	41.0	Off	N	19.5	15.0	56.0
0.902000	38.3	Off	N	19.5	17.7	56.0
1.038000	36.7	Off	N	19.5	19.3	56.0
1.206000	42.1	Off	N	19.6	13.9	56.0
1.334000	40.8	Off	N	19.5	15.2	56.0
1.678000	41.3	Off	N	19.5	14.7	56.0
1.934000	41.6	Off	N	19.5	14.4	56.0
2.222000	42.5	Off	N	19.6	13.5	56.0
2.510000	43.2	Off	N	19.6	12.8	56.0
3.014000	43.4	Off	N	19.6	12.6	56.0
3.622000	44.2	Off	N	19.6	11.8	56.0



Test Mode :	Mode 1	Temperature :	20~22°C
Test Engineer :	Cosmo Xu	Relative Humidity :	45~47%
Test Voltage :	120Vac / 60Hz	Phase :	Neutral
Function Type :	GSM850 (GPRS class 8) Idle + Bluetooth Link + TC+ TF + GPS Rx + Battery 2 + Bluetooth Base (Charging from Adapter 1) + USB flash drive + Micro USB Cable (Data Link with notebook) + RJ-45 (Load) + RJ-11 (Load) + RS232 (Load)		

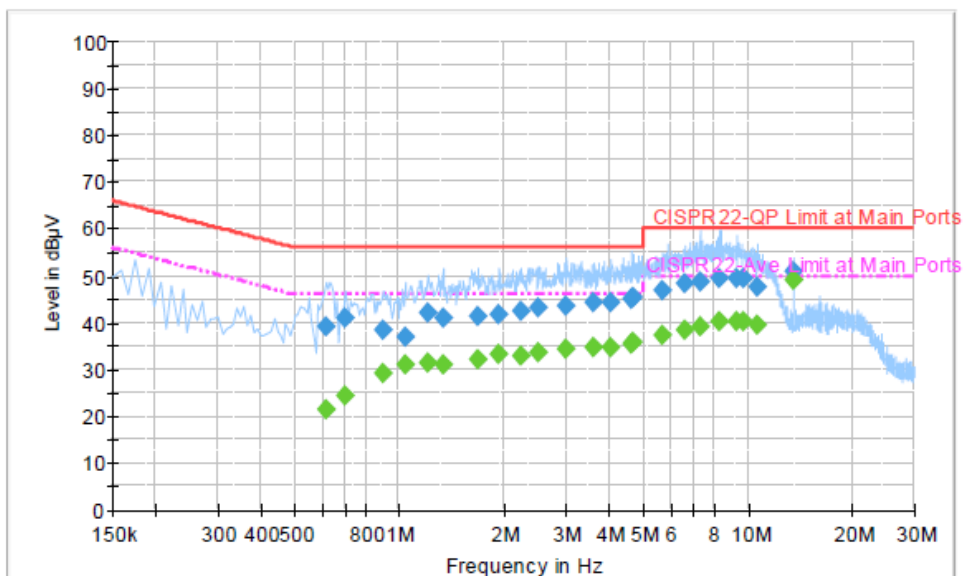

Final Result : Quasi-Peak

Frequency (MHz)	Quasi-Peak (dBµV)	Filter	Line	Corr. (dB)	Margin (dB)	Limit (dBµV)
4.046000	44.1	Off	N	19.6	11.9	56.0
4.630000	45.1	Off	N	19.7	10.9	56.0
4.686000	45.2	Off	N	19.6	10.8	56.0
5.670000	46.7	Off	N	19.7	13.3	60.0
6.614000	48.5	Off	N	19.7	11.5	60.0
7.262000	48.8	Off	N	19.7	11.2	60.0
8.294000	49.3	Off	N	19.7	10.7	60.0
9.254000	49.6	Off	N	19.7	10.4	60.0
9.670000	49.5	Off	N	19.8	10.5	60.0
10.670000	47.6	Off	N	19.7	12.4	60.0
13.558000	51.0	Off	N	19.9	9.0	60.0



Test Mode :	Mode 1	Temperature :	20~22°C
Test Engineer :	Cosmo Xu	Relative Humidity :	45~47%
Test Voltage :	120Vac / 60Hz	Phase :	Neutral
Function Type :	GSM850 (GPRS class 8) Idle + Bluetooth Link + TC+ TF + GPS Rx + Battery 2 + Bluetooth Base (Charging from Adapter 1) + USB flash drive + Micro USB Cable (Data Link with notebook) + RJ-45 (Load) + RJ-11 (Load) + RS232 (Load)		

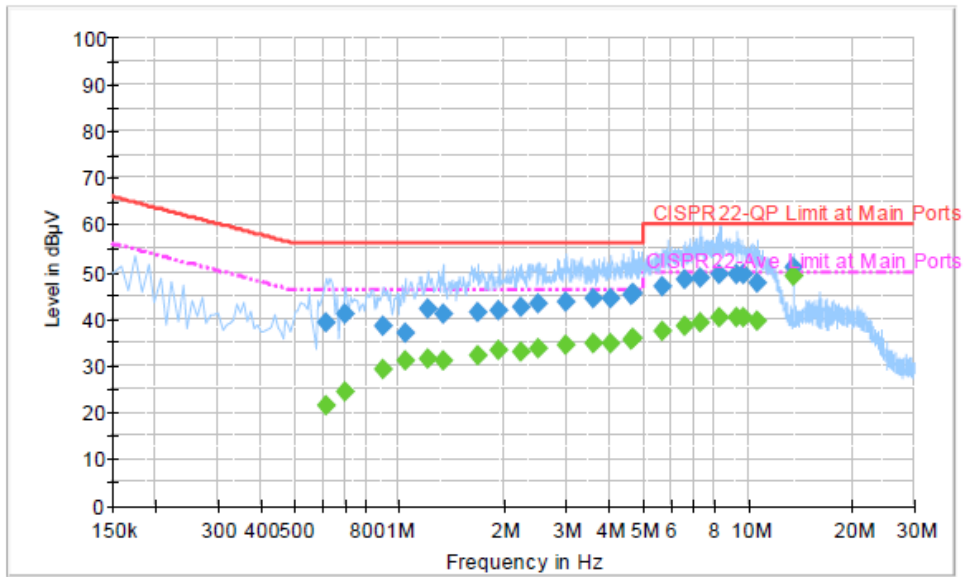

Final Result : Average

Frequency (MHz)	Average (dBµV)	Filter	Line	Corr. (dB)	Margin (dB)	Limit (dBµV)
0.614000	21.4	Off	N	19.4	24.6	46.0
0.702000	24.5	Off	N	19.5	21.5	46.0
0.902000	29.2	Off	N	19.5	16.8	46.0
1.038000	31.1	Off	N	19.5	14.9	46.0
1.206000	31.4	Off	N	19.6	14.6	46.0
1.334000	31.2	Off	N	19.5	14.8	46.0
1.678000	32.3	Off	N	19.5	13.7	46.0
1.934000	33.2	Off	N	19.5	12.8	46.0
2.222000	32.9	Off	N	19.6	13.1	46.0
2.510000	33.6	Off	N	19.6	12.4	46.0
3.014000	34.4	Off	N	19.6	11.6	46.0
3.622000	34.7	Off	N	19.6	11.3	46.0



Test Mode :	Mode 1	Temperature :	20~22°C
Test Engineer :	Cosmo Xu	Relative Humidity :	45~47%
Test Voltage :	120Vac / 60Hz	Phase :	Neutral
Function Type :	GSM850 (GPRS class 8) Idle + Bluetooth Link + TC+ TF + GPS Rx + Battery 2 + Bluetooth Base (Charging from Adapter 1) + USB flash drive + Micro USB Cable (Data Link with notebook) + RJ-45 (Load) + RJ-11 (Load) + RS232 (Load)		

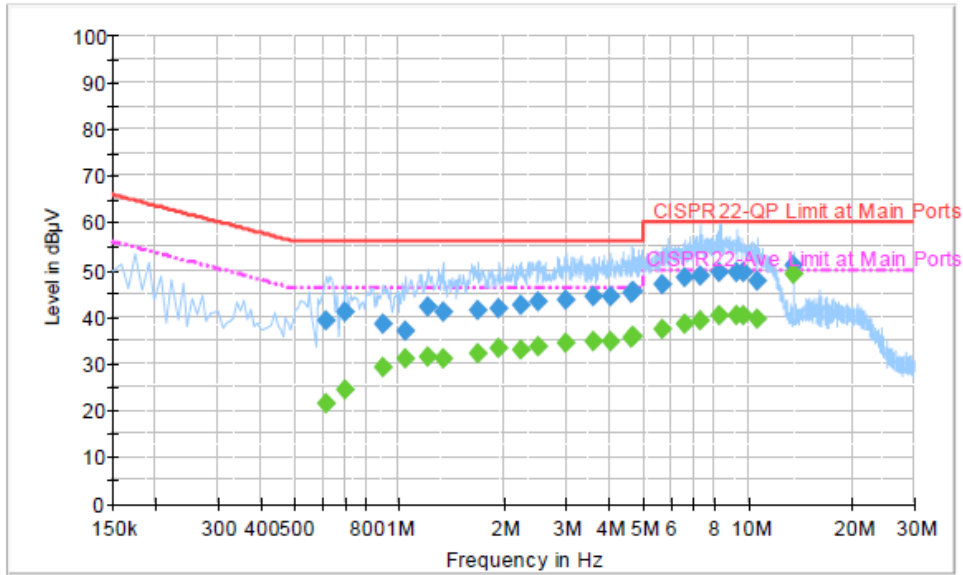

Final Result : Average

Frequency (MHz)	Average (dBµV)	Filter	Line	Corr. (dB)	Margin (dB)	Limit (dBµV)
4.046000	34.6	Off	N	19.6	11.4	46.0
4.630000	35.3	Off	N	19.7	10.7	46.0
4.686000	35.8	Off	N	19.6	10.2	46.0
5.670000	37.3	Off	N	19.7	12.7	50.0
6.614000	38.5	Off	N	19.7	11.5	50.0
7.262000	39.2	Off	N	19.7	10.8	50.0
8.294000	40.1	Off	N	19.7	9.9	50.0
9.254000	40.2	Off	N	19.7	9.8	50.0
9.670000	40.1	Off	N	19.8	9.9	50.0
10.670000	39.4	Off	N	19.7	10.6	50.0
13.558000	48.9	Off	N	19.9	1.1	50.0



3.7 Antenna Requirements

3.7.1 Standard Applicable

If directional gain of transmitting antennas is greater than 6dBi, the power shall be reduced by the same level in dB comparing to gain minus 6dBi. The use of a permanently attached antenna or of an antenna that uses a unique coupling to the intentional radiator shall be considered sufficient to comply with the FCC rule.

3.7.2 Antenna Anti-Replacement Construction

An embedded-in antenna design is used.

3.7.3 Antenna Gain

The antenna peak gain of EUT is less than 6 dBi. Therefore, it is not necessary to reduce maximum peak output power limit.



4 List of Measuring Equipment

Instrument	Manufacturer	Model No.	Serial No.	Characteristics	Calibration Date	Test Date	Due Date	Remark
Spectrum Analyzer	Rohde & Schwarz	FSP40	100055	9kHz~40GHz	Jun. 07, 2013	Apr. 23, 2014 ~ Apr. 24, 2014	Jun. 06, 2014	Conducted (TH02-HY)
Power Meter	Agilent	E4416A	GB41292344	300MHz~40GHz	Jan. 28, 2014	Apr. 23, 2014 ~ Apr. 24, 2014	Jan. 27, 2015	Conducted (TH02-HY)
Power Sensor	Agilent	E9327A	US40441548	300MHz~40GHz	Jan. 28, 2014	Apr. 23, 2014 ~ Apr. 24, 2014	Jan. 27, 2015	Conducted (TH02-HY)
EMI Test Receiver	Rohde & Schwarz	ESCI 7	100724	9 kHz~7 GHz	Sep. 06, 2013	Apr. 27, 2014	Sep. 05, 2014	Radiation (03CH07-HY)
Spectrum Analyzer	Rohde & Schwarz	FSV30	101749	10Hz ~ 30GHz	Feb. 10, 2014	Apr. 27, 2014	Feb. 09, 2015	Radiation (03CH07-HY)
Loop Antenna	Rohde & Schwarz	HFH2-Z2	860004/0001	9 kHz~30 MHz	Jul. 03, 2012	Apr. 27, 2014	Jul. 03, 2014	Radiation (03CH07-HY)
Bilog Antenna	Schaffner	CBL6111C	2726	30 MHz ~ 1 GHz	Oct. 10, 2013	Apr. 27, 2014	Oct. 09, 2014	Radiation (03CH07-HY)
Double Ridge Horn Antenna	ESCO	3117	75962	1 GHz~18 GHz	Aug. 22, 2013	Apr. 27, 2014	Aug. 21, 2014	Radiation (03CH07-HY)
SHF-EHF Horn Antenna	SCHWARZBECK	BBHA 9170	BBHA9170251	15 GHz- 40 GHz	Oct. 03, 2013	Apr. 27, 2014	Oct. 02, 2014	Radiation (03CH07-HY)
Preamplifier	COM-POWER	PA-103A	161241	10 MHz ~ 1000MHz 32dB GAIN	Mar. 17, 2014	Apr. 27, 2014	Mar. 16, 2015	Radiation (03CH07-HY)
Preamplifier	Agilent	8449B	3008A02362	1 GHz~26.5 GHz	Nov. 29, 2013	Apr. 27, 2014	Nov. 28, 2014	Radiation (03CH07-HY)
Preamplifier	MITEQ	AMF-7D-0010 1800-30-10P	1590074	DC~18 G High Gain	Jul. 09, 2013	Apr. 27, 2014	Jul. 08, 2014	Radiation (03CH07-HY)
Turn Table	ChainTek	ChainTek 3000	N/A	0 ~ 360 degree	N/A	Apr. 27, 2014	N/A	Radiation (03CH07-HY)
Antenna Mast	ChainTek	ChainTek 3000	N/A	N/A	N/A	Apr. 27, 2014	N/A	Radiation (03CH07-HY)
EMI Test Receiver	Rohde & Schwarz	ESCS 30	100356	9kHz ~ 2.75GHz	Nov. 15, 2013	Apr. 23, 2014 ~ Apr. 28, 2014	Nov. 14, 2014	Conduction (CO05-HY)
LISN (for auxiliary equipment)	Rohde & Schwarz	ENV216	100081	9kHz ~ 30MHz	Dec. 12, 2013	Apr. 23, 2014 ~ Apr. 28, 2014	Dec. 11, 2014	Conduction (CO05-HY)
LISN	Rohde & Schwarz	ENV216	100080	9kHz ~ 30MHz	Dec. 04, 2013	Apr. 23, 2014 ~ Apr. 28, 2014	Dec. 03, 2014	Conduction (CO05-HY)
AC Power Source	ChainTek	APC-1000W	N/A	N/A	N/A	Apr. 23, 2014 ~ Apr. 28, 2014	N/A	Conduction (CO05-HY)



5 Uncertainty of Evaluation

Uncertainty of Conducted Emission Measurement (150 kHz ~ 30 MHz)

Measuring Uncertainty for a Level of Confidence of 95% ($U = 2Uc(y)$)	2.26
---	------

Uncertainty of Radiated Emission Measurement (30 MHz ~ 1000 MHz)

Measuring Uncertainty for a Level of Confidence of 95% ($U = 2Uc(y)$)	4.50
---	------