

FCC RADIO TEST REPORT

according to

47 CFR FCC Part 15 Subpart C § 15.225

Equipment : Point of Sales Terminal
Brand Name : VeriFone
Model No. : VX685
Filing Type : New Application
Applicant : VeriFone, Inc.
1400 West Stanford Ranch Road Suite 200 Rocklin CA 95765 USA
FCC ID : B32VX685GC
Manufacturer :

1. **Sanmina-SCI Systems (Kunshan) Co., Ltd.**
312, Qingyang South Road, Economics & Technical
Development Zone, Kunshan, Jiangsu Province, 215300,
China
2. **Inventec Appliances (Pudong) Co., Ltd.**
No. 789, Pu Xing Road, Shanghai, P.R.C.
3. **Flextronics Computing (Suzhou) Co., Ltd.**
No. 1 Guanpu Road, Guoxiang Street, Wuzhong District,
Suzhou, Jiangsu, China

Received Date : Jan. 30, 2014
Final Test Date : Feb. 20, 2014

Statement

The test result in this report refers exclusively to the presented test model / sample.

Without written approval of SPORTON International Inc., the test report shall not be reproduced except in full.

The measurements and test results shown in this test report were made in accordance with the procedures and found in compliance with the limit given in **ANSI C63.4-2003** and **47 CFR FCC Part 15 Subpart C**.

The test equipment used to perform the test is calibrated and traceable to NML/ROC.



SPORTON INTERNATIONAL INC.

No. 52, Hwa Ya 1st Rd., Hwa Ya Technology Park, Kwei-Shan Hsiang, Tao Yuan Hsien, Taiwan, R.O.C.

Table of Contents

1. SUMMARY OF THE TEST RESULT1

2. GENERAL INFORMATION.....2

 2.1 Product Details 2

 2.2 Table for Test Modes 2

 2.3 Table for Testing Locations 3

 2.4 Table for Supporting Units 3

 2.5 Test Configurations 3

3. TEST RESULT5

 3.1 AC Power Line Conducted Emissions Measurement 5

 3.2 Field Strength of Fundamental Emissions and Mask Measurement 10

 3.3 20dB Spectrum Bandwidth Measurement 14

 3.4 Radiated Emissions Measurement 16

 3.5 Frequency Stability Measurement 23

 3.6 Antenna Requirements 26

4. LIST OF MEASURING EQUIPMENT27

5. TEST LOCATION.....28

6. TAF CERTIFICATE OF ACCREDITATION29

APPENDIX A. SETUP PHOTOGRAPHS

REVISION HISTORY

REPORT NO.	VERSION	DESCRIPTION	ISSUED DATE
FR413003	Rev. 01	Initial issue of report	Apr. 22, 2015

CERTIFICATE OF COMPLIANCE

according to

47 CFR FCC Part 15 Subpart C § 15.225

Equipment : Point of Sales Terminal
Brand Name : VeriFone
Model No. : VX685
VeriFone, Inc.
Applicant : 1400 West Stanford Ranch Road Suite 200 Rocklin CA
95765 USA

Sporton International as requested by the applicant to evaluate the EMC performance of the product sample received on Jan. 30, 2014 would like to declare that the tested sample has been evaluated and found to be in compliance with the tested rule parts. The data recorded as well as the test configuration specified is true and accurate for showing the sample's EMC nature.



Reviewed by: Joseph Lin / Supervisor

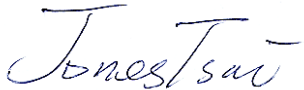

Approved by: Jones Tsai / Manager

SPORTON INTERNATIONAL INC.

No. 52, Hwa Ya 1st Rd., Hwa Ya Technology Park, Kwei-Shan Hsiang, Tao Yuan Hsien, Taiwan, R.O.C.

1. SUMMARY OF THE TEST RESULT

Applied Standard: 47 CFR FCC Part 15 Subpart C					
Part	FCC Rule	IC Rule	Description of Test	Result	Under Limit
3.1	15.207	Gen 7.2.4	AC Power Line Conducted Emissions	Complies	12.40dB at 0.518MHz
3.2	15.225(a)(b)(c)	A2.6	Field Strength of Fundamental Emissions	Complies	42.22dB at 13.560MHz
3.3	2.1049	-	20dB Spectrum Bandwidth	Complies	-
3.4	15.225(d) 15.209	A2.6	Radiated Emissions	Complies	3.79dB at 31.620MHz
3.5	15.225(e)	A2.6	Frequency Stability	Complies	-
3.6	15.203	-	Antenna Requirements	Complies	-

Test Items	Uncertainty	Remark
AC Power Line Conducted Emissions	±2.3dB	Confidence levels of 95%
Field Strength of Fundamental Emissions	±0.8dB	Confidence levels of 95%
20dB Spectrum Bandwidth / Frequency Stability	±8.5×10 ⁻⁸	Confidence levels of 95%
Radiated / Band Edge Emissions (9kHz~30MHz)	±0.8dB	Confidence levels of 95%
Radiated Emissions (30MHz~1000MHz)	±1.9dB	Confidence levels of 95%
Temperature	±0.7°C	Confidence levels of 95%
Humidity	±3.2%	Confidence levels of 95%
DC / AC Power Source	±1.4%	Confidence levels of 95%

2. GENERAL INFORMATION

2.1 Product Details

For more detailed features description, please refer to the manufacturer’s specifications or user’s manual.

Items	Description
Power Type	5Vdc from Adapter
Modulation	ASK
Channel Number	1
Channel Bandwidth (99%)	2.240kHz
Max. Field Strength	81.78dBµV/m
Test Freq. Range	13.553 ~ 13.567MHz
Carrier Frequencies	13.56 MHz (Ch. 1)
Antenna	Loop Antenna

2.2 Table for Test Modes

Investigation has been done on all the possible configurations for searching the worst cases. The following table is a list of the test modes shown in this test report.

Test Items	Mode	Channel
AC Power Line Conducted Emissions	CTX	-
Field Strength of Fundamental Emissions	CTX	1
20dB Spectrum Bandwidth	CTX	1
Radiated Emissions 9kHz~30MHz	CTX	1
Radiated Emissions 9kHz~10 th Harmonic Band Edge Emissions	CTX	1
Frequency Stability	Un-modulation	1

Note:

1. CTX=continuously transmitting.
2. The EUT choose “Run EMC Test”, “All Off”, and then choose “Carrier on”. Then, the EUT will get into the engineering modes to continuously transmit at 13.56MHz.

2.3 Table for Testing Locations

Test Site No.	Site Category	Location
CO05-HY	Conduction	Hwa Ya
TH02-HY	OVEN Room	Hwa Ya
03CH07-HY	SAC	Hwa Ya

Semi Anechoic Chamber (SAC).

2.4 Table for Supporting Units

Support Unit	Manufacturer	Model	FCC ID
System Simulator	R&S	CMU 200	N/A
Smart Card	N/A	N/A	N/A

2.5 Test Configurations

<AC Conducted Emissions>

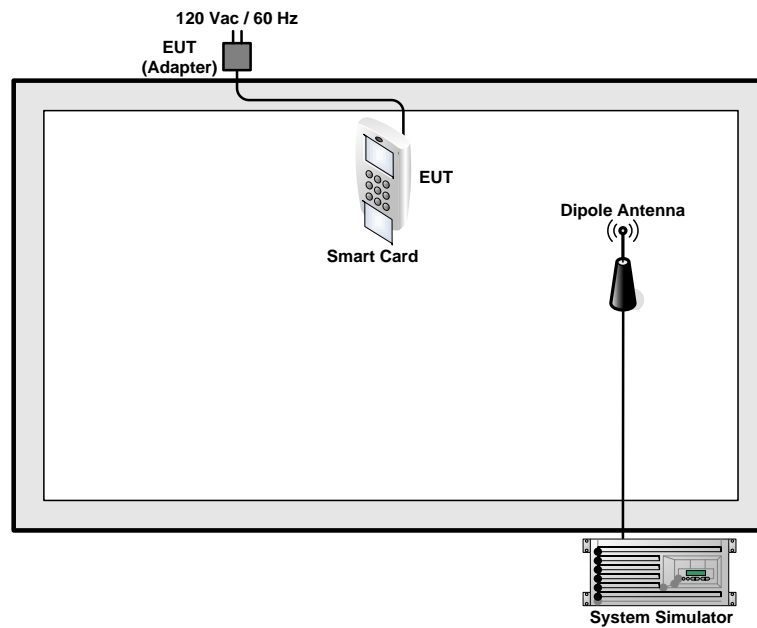

Fundamental Emissions and Mask Measurement

For radiated emissions 9kHz~30MHz

For radiated emissions 30MHz~1GHz

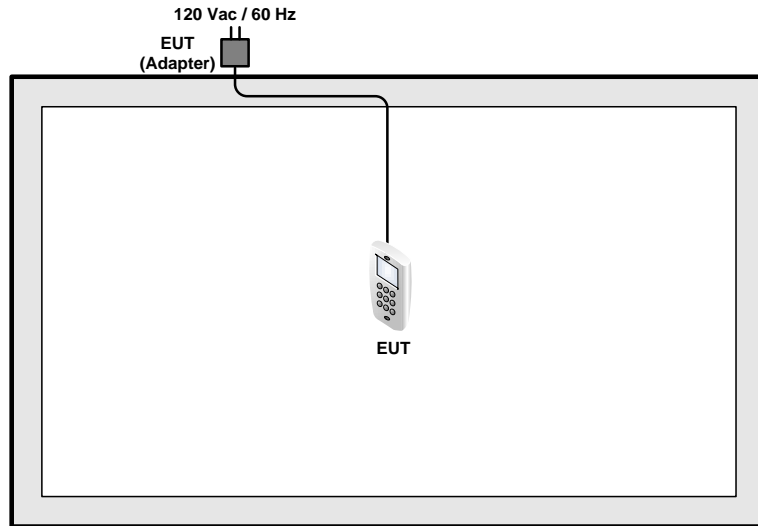

3. TEST RESULT

3.1 AC Power Line Conducted Emissions Measurement

3.1.1 Limit

For a Low-power Radio-frequency device which is designed to be connected to the AC power line, the radio frequency voltage that is conducted back onto the AC power line on any frequency or frequencies within the band 150 kHz to 30 MHz shall not exceed below limits table.

Frequency (MHz)	QP Limit (dBµV)	AV Limit (dBµV)
0.15~0.5	66~56	56~46
0.5~5	56	46
5~30	60	50

3.1.2 Measuring Instruments and Setting

Please refer to section 4 of equipments list in this report. The following table is the setting of the receiver.

Receiver Parameters	Setting
Attenuation	10 dB
Start Frequency	0.15 MHz
Stop Frequency	30 MHz
IF Bandwidth	9 kHz

3.1.3 Test Procedures

1. Configure the EUT according to ANSI C63.4. The EUT or host of EUT has to be placed 0.4 meter far from the conducting wall of the shielding room and at least 80 centimeters from any other grounded conducting surface.
2. Connect EUT or host of EUT to the power mains through a line impedance stabilization network (LISN).
3. All the support units are connected to the other LISNs. The LISN should provide 50uH/50ohms coupling impedance.
4. The frequency range from 150 kHz to 30 MHz was searched.
5. Set the test-receiver system to Peak Detect Function and Specified Bandwidth with Maximum Hold Mode.
6. The measurement has to be done between each power line and ground at the power terminal.

3.1.4 Test Setup Layout

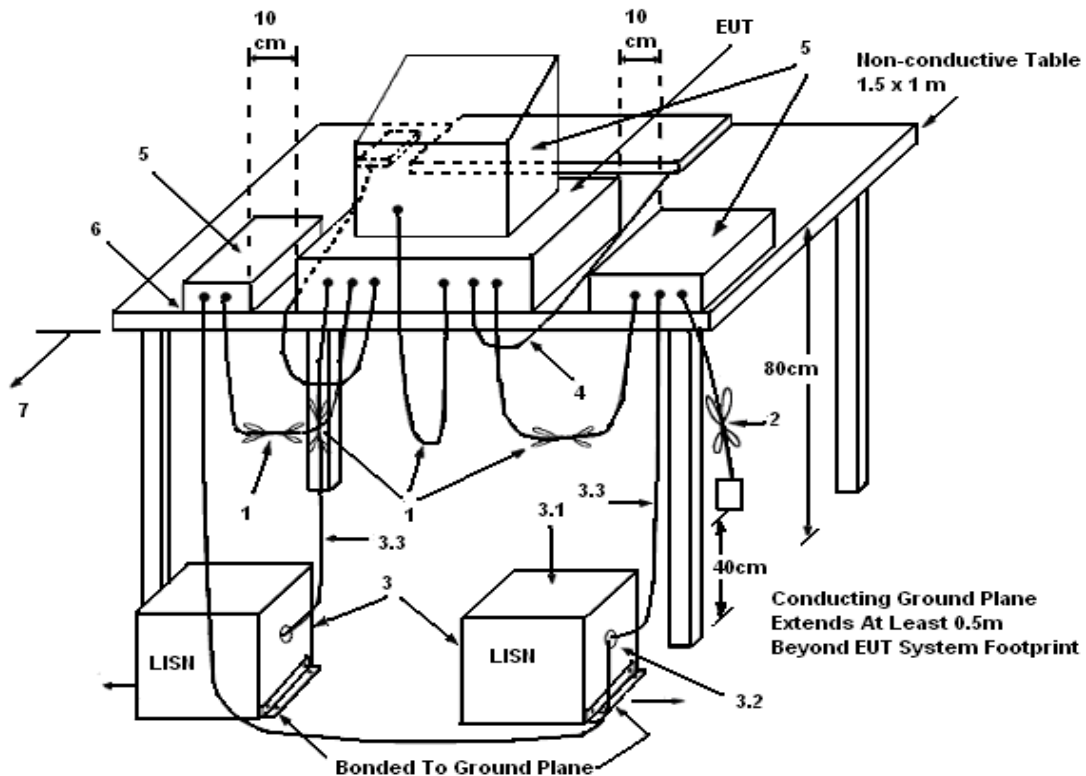

LEGEND:

- (1) Interconnecting cables that hang closer than 40 cm to the ground plane shall be folded back and forth in the center forming a bundle 30 to 40 cm long.
- (2) I/O cables that are not connected to a peripheral shall be bundled in the center. The end of the cable may be terminated, if required, using the correct terminating impedance. The overall length shall not exceed 1 m.
- (3) EUT connected to one LISN. Unused LISN measuring port connectors shall be terminated in 50 Ω. LISN can be placed on top of, or immediately beneath, reference ground plane.
 - (3.1) All other equipment powered from additional LISN(s).
 - (3.2) Multiple outlet strip can be used for multiple power cords of non-EUT equipment.
 - (3.3) LISN at least 80 cm from nearest part of EUT chassis.
- (4) Cables of hand-operated devices, such as keyboards, mice, etc., shall be placed as for normal use.
- (5) Non-EUT components of EUT system being tested.
- (6) Rear of EUT, including peripherals, shall all be aligned and flush with rear of tabletop.
- (7) Rear of tabletop shall be 40 cm removed from a vertical conducting plane that is bonded to the ground plane.

3.1.5 Test Deviation

There is no deviation with the original standard.

3.1.6 EUT Operation during Test

The EUT was placed on the test table and programmed in transmitting function.

3.1.7 Results of AC Power Line Conducted Emissions Measurement

Final Test Date	Feb. 20, 2014	Test Site No.	CO05-HY
Temperature	20~22°C	Humidity	46~48%
Test Engineer	Kai-Chun Chu	Configuration	Transmitting Mode (13.56MHz)
Mode	NFC Tx + Smart Card + Battery + Adapter 1		

Line

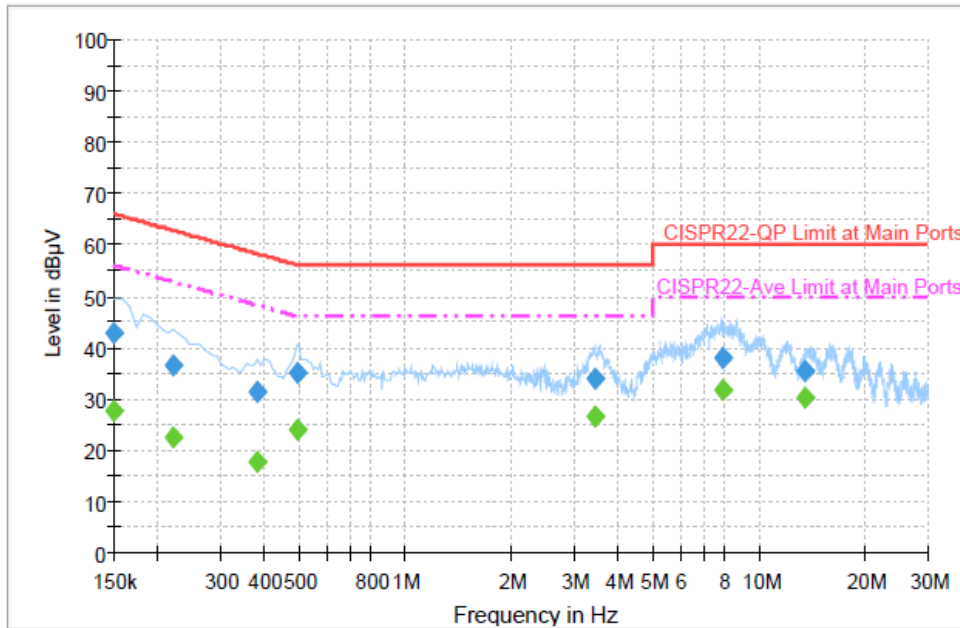

Final Result: Quasi-Peak

Frequency (MHz)	Quasi-Peak (dBµV)	Filter	Line	Corr. (dB)	Margin (dB)	Limit (dBµV)
0.150000	42.9	Off	L1	19.4	23.1	66.0
0.222000	36.6	Off	L1	19.3	26.1	62.7
0.382000	31.4	Off	L1	19.6	26.8	58.2
0.494000	35.0	Off	L1	19.5	21.1	56.1
3.438000	34.1	Off	L1	19.5	21.9	56.0
7.918000	38.1	Off	L1	19.6	21.9	60.0
13.558000	35.4	Off	L1	19.8	24.6	60.0

Final Result: Average

Frequency (MHz)	Average (dBµV)	Filter	Line	Corr. (dB)	Margin (dB)	Limit (dBµV)
0.150000	27.5	Off	L1	19.4	28.5	56.0
0.222000	22.5	Off	L1	19.3	30.2	52.7
0.382000	17.8	Off	L1	19.6	30.4	48.2
0.494000	24.0	Off	L1	19.5	22.1	46.1
3.438000	26.7	Off	L1	19.5	19.3	46.0
7.918000	31.7	Off	L1	19.6	18.3	50.0
13.558000	30.2	Off	L1	19.8	19.8	50.0

Neutral

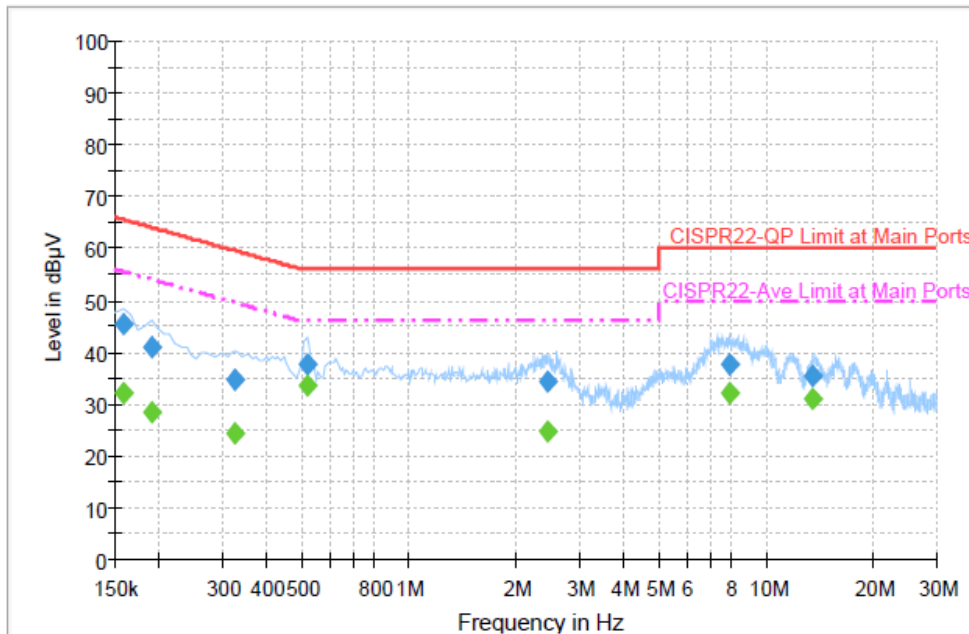

Final Result: Quasi-Peak

Frequency (MHz)	Quasi-Peak (dBµV)	Filter	Line	Corr. (dB)	Margin (dB)	Limit (dBµV)
0.158000	45.4	Off	N	19.3	20.2	65.6
0.190000	40.9	Off	N	19.4	23.1	64.0
0.326000	34.6	Off	N	19.5	25.0	59.6
0.518000	37.8	Off	N	19.6	18.2	56.0
2.446000	34.2	Off	N	19.6	21.8	56.0
7.878000	37.5	Off	N	19.6	22.5	60.0
13.558000	35.5	Off	N	19.8	24.5	60.0

Final Result: Average

Frequency (MHz)	Average (dBµV)	Filter	Line	Corr. (dB)	Margin (dB)	Limit (dBµV)
0.158000	32.3	Off	N	19.3	23.3	55.6
0.190000	28.4	Off	N	19.4	25.6	54.0
0.326000	24.3	Off	N	19.5	25.3	49.6
0.518000	33.6	Off	N	19.6	12.4	46.0
2.446000	24.8	Off	N	19.6	21.2	46.0
7.878000	31.9	Off	N	19.6	18.1	50.0
13.558000	30.8	Off	N	19.8	19.2	50.0

3.2 Field Strength of Fundamental Emissions and Mask Measurement

3.2.1 Limit

Field strength of fundamental emissions limit:

The field strength of fundamental emissions shall not exceed 15848 microvolts/meter at 30 meters. The emissions limit in this paragraph is based on measurement instrumentation employing a QP detector.

Frequencies (MHz)	Field Strength (microvolts/meter)	Field Strength (dBµV/m) at 10m	Field Strength (dBµV/m) at 3m
13.553 ~ 13.567MHz	15848 at 30m	103.08 (QP)	124 (QP)

Mask limit:

Rules and specifications	CFR 47 Part 15 section 15.225(a)-(d)				
Description	Compliance with the spectrum mask is tested using a spectrum analyzer with RBW set to a 9kHz for the band 13.553~13.567MHz				
Limit	Freq. of Emission (MHz)	Field Strength (µV/m) at 30m	Field Strength (dBµV/m) at 30m	Field Strength (dBµV/m) at 10m	Field Strength (dBµV/m) at 3m
	1.705~13.110	30	29.5	48.58	69.5
	13.110~13.410	106	40.5	59.58	80.5
	13.410~13.553	334	50.5	69.58	90.5
	13.553~13.567	15848	84.0	103.08	124.0
	13.567~13.710	334	50.5	69.58	90.5
	13.710~14.010	106	40.5	59.58	80.5
	14.010~30.000	30	29.5	48.58	69.5

3.2.2 Measuring Instruments and Setting

Please refer to section 4 of equipments list in this report. The following table is the setting of the receiver.

Receiver Parameter	Setting
Attenuation	Auto
Center Frequency	Fundamental Frequency
RBW	9 kHz
Detector	QP

3.2.3 Test Procedures

1. Configure the EUT according to ANSI C63.4. The EUT was placed on the top of the turntable 0.8 meter above ground. The phase center of the loop receiving antenna mounted antenna tower was placed 3 meters far away from the turntable.
2. Power on the EUT and all the supporting units. The turntable was rotated by 360 degrees to determine the position of the highest radiation.
3. The height of the receiving antenna was fixed at one meter above ground to find the maximum emissions field strength.
4. For Fundamental emissions, use the receiver to measure QP reading.
5. When the radiated emissions limits are expressed in terms of the average value of the emissions, and pulsed operation is employed, the measurement field strength shall be determined by averaging over one complete pulse train, including blanking intervals, as long as the pulse train does not exceed 0.1 seconds. As an alternative (provided the transmitter operates for longer than 0.1 seconds) or in cases where the pulse train exceeds 0.1 seconds, the measured field strength shall be determined from the average absolute voltage during a 0.1 second interval during which the field strength is at its maximum value.
6. Compliance with the spectrum mask is tested using a spectrum analyzer with RBW set to a 9kHz for the band 13.553~13.567MHz.

3.2.4 Test Setup Layout

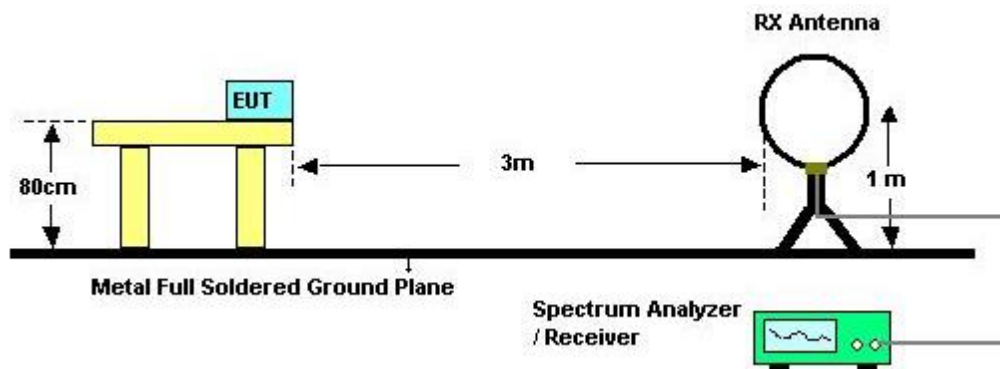

3.2.5 Test Deviation

There is no deviation with the original standard.

3.2.6 EUT Operation during Test

The EUT was programmed to be in continuously transmitting mode.

3.2.7 Test Result of Field Strength of Fundamental Emissions

Final Test Date	Feb. 04, 2014	Test Site No.	03CH07-HY
Temperature	20~22°C	Humidity	49~51%
Test Engineer	Eric Shih	Configurations	Ch. 1

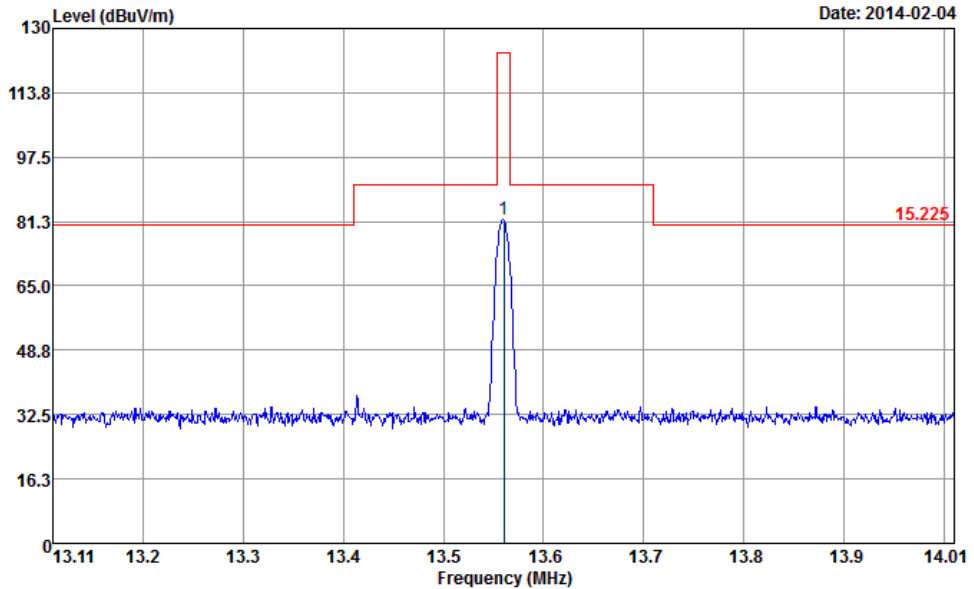

Site : 03CH07-HY
 Condition : 15.225 3m NFC FACTOR(120912)-H HORIZONTAL
 Project : FR 413003
 Mode : 1

1	Freq	Level	Over Limit	Limit Line	ReadAntenna Level	Antenna Factor	Cable Loss	A/Pos	T/Pos	Remark
	MHz	dBuV/m	dB	dBuV/m	dBuV	dB/m	dB	cm	deg	
1	13.56	81.78	-42.22	124.00	61.63	19.75	0.40	100	185	QP

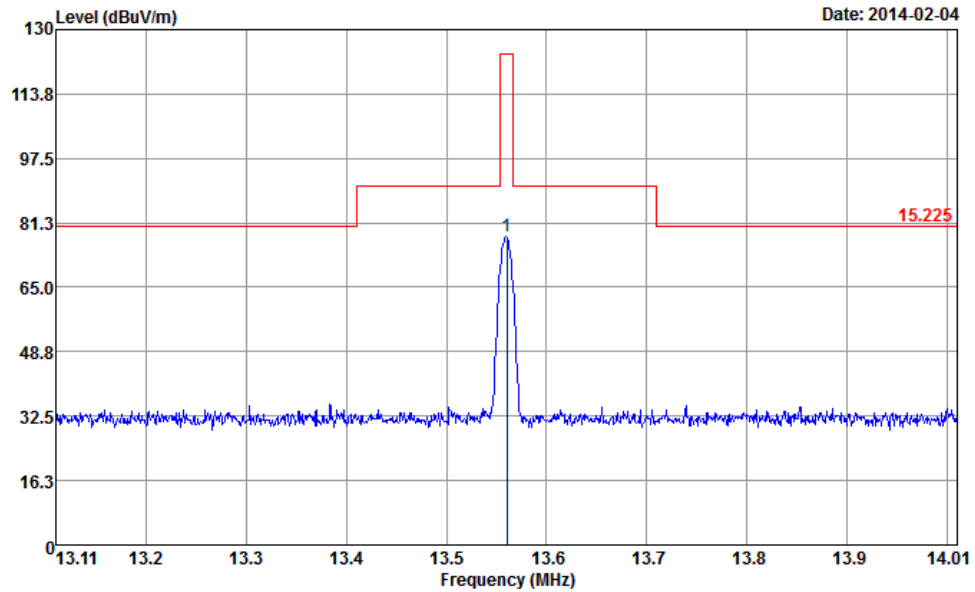

Site : 03CH07-HY
 Condition : 15.225 3m NFC FACTOR(120912)-V VERTICAL
 Project : FR 413003
 Mode : 1

Freq	Level	Over Limit	Limit Line	ReadAntenna Level	Cable Factor	A/Pos	T/Pos	Remark	
MHz	dBuV/m	dB	dBuV/m	dBuV	dB/m	dB	cm	deg	
1	13.56	77.70	-46.30	124.00	57.55	19.75	0.40	100	276 QP

Note:

Emission level (dBμV/m) = 20 log Emission level (μV/m).

Measured distance is 3m.

All emissions emit form non-NFC function of digital unintentional emissions. All NFC's spurious emissions are below 20dB of limits.

3.3 20dB Spectrum Bandwidth Measurement

3.3.1 Limit

Intentional radiators must be designed to ensure that the 20 dB bandwidth of the emissions in the specific band (13.553 ~ 13.567MHz).

3.3.2 Measuring Instruments and Setting

Please refer to section 4 of equipments list in this report. The following table is the setting of the spectrum analyzer.

Spectrum Parameters	Setting
Attenuation	Auto
Span Frequency	> 20dB Bandwidth
RBW	1 kHz
VBW	3 kHz
Detector	Peak
Trace	Max Hold
Sweep Time	Auto

3.3.3 Test Procedures

1. The transmitter output (antenna port) was connected to the spectrum analyzer in peak hold mode.
2. The resolution bandwidth of 1kHz and the video bandwidth of 3kHz were used.
3. Measured the spectrum width with power higher than 20dB below carrier.

3.3.4 Test Setup Layout

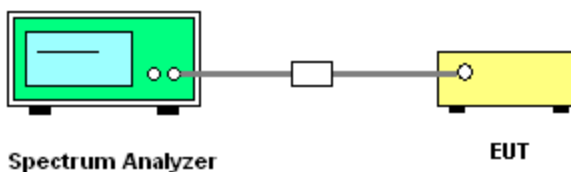

3.3.5 Test Deviation

There is no deviation with the original standard.

3.3.6 EUT Operation during Test

The EUT was programmed to be in continuously transmitting mode.

3.3.7 Test Result of 20dB Spectrum Bandwidth

Final Test Date	Feb. 06, 2014	Test Site No.	TH02-HY
Temperature	22~24°C	Humidity	53~55%
Test Engineer	Tommy Lee	Configurations	Ch. 1

Frequency	20dB BW (kHz)	99% OBW (kHz)	Frequency range (MHz) $f_L > 13.553\text{MHz}$	Frequency range (MHz) $f_H < 13.567\text{MHz}$	Test Result
13.56 MHz	2.640	2.240	13.55858	13.56122	Complies

20 dB / 99% Bandwidth Plot on 13.56 MHz

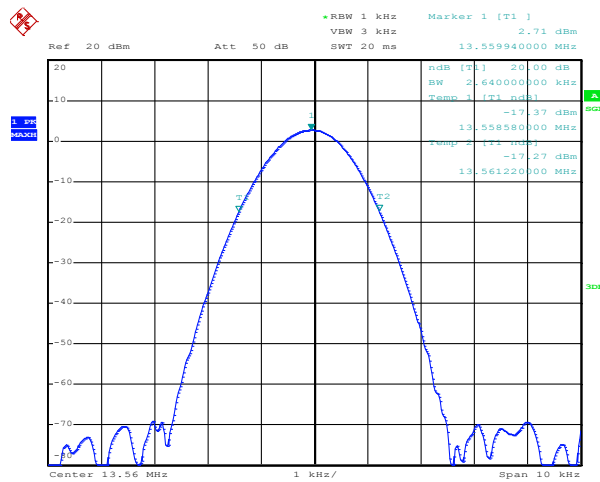

Date: 6.FEB.2014 09:40:28

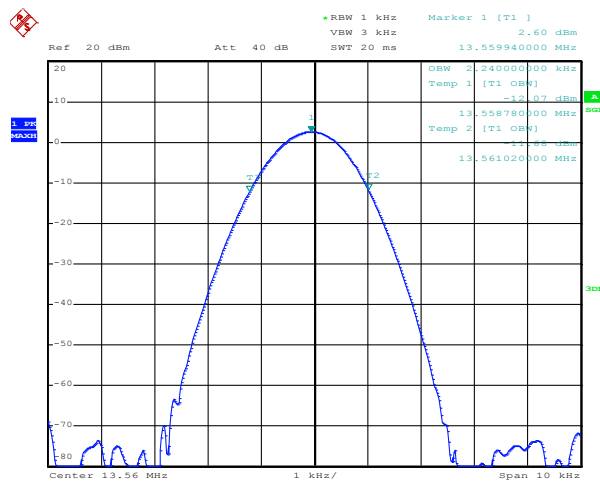

Date: 6.FEB.2014 10:49:06

3.4 Radiated Emissions Measurement

3.4.1 Limit

The field strength of any emissions which appear outside of 13.553 ~ 13.567MHz band shall not exceed the general radiated emissions limits.

Frequencies (MHz)	Field Strength (µV/m)	Measurement Distance (meters)
0.009~0.490	2400/F(kHz)	300
0.490~1.705	24000/F(kHz)	30
1.705~30.0	30	30
30~88	100	3
88~216	150	3
216~960	200	3
Above 960	500	3

3.4.2 Measuring Instruments and Setting

Please refer to section 4 of equipment list in this report. The following table is the setting of receiver.

Receiver Parameter	Setting
Attenuation	Auto
Start ~ Stop Frequency	9kHz~150kHz / RBW 200Hz for QP
Start ~ Stop Frequency	150kHz~30MHz / RBW 9kHz for QP
Start ~ Stop Frequency	30MHz~1000MHz / RBW 120kHz for Peak

Note: The emission limits shown in the above table are based on measurements employing a CISPR quasi-peak detector except for the frequency bands 9-90 kHz, 110-490 kHz. Radiated emission limits in these two bands are based on measurements employing an average detector.

3.4.3 Test Procedures

1. Configure the EUT according to ANSI C63.4. The EUT was placed on the top of the turntable 0.8 meter above ground. The phase center of the receiving antenna mounted on the top of a height-variable antenna tower was placed 3 meters far away from the turntable.
2. Power on the EUT and all the supporting units. The turntable was rotated by 360 degrees to determine the position of the highest radiation.
3. The height of the broadband receiving antenna was varied between one meter and four meters above ground to find the maximum emissions field strength of both horizontal and vertical polarization.
4. For each suspected emissions, the antenna tower was scan (from 1 M to 4 M) and then the turntable was rotated (from 0 degree to 360 degrees) to find the maximum reading.
5. Set the test-receiver system to Peak or CISPR quasi-peak Detect Function with specified bandwidth under Maximum Hold Mode.
6. When the radiated emissions limits are expressed in terms of the average value of the emissions, and pulsed operation is employed, the measurement field strength shall be determined by averaging over one complete pulse train, including blanking intervals, as long as the pulse train does not exceed 0.1 seconds. As an alternative (provided the transmitter operates for longer than 0.1 seconds) or in cases where the pulse train exceeds 0.1 seconds, the measured field strength shall be determined from the average absolute voltage during a 0.1 second interval during which the field strength is at its maximum value.
7. In case the emission is lower than 30MHz, loop antenna has to be used for measurement and the recorded data should be QP measured by receiver. High – Low scan is not required in this case.

3.4.4 Test Setup Layout

For radiated emissions below 30MHz

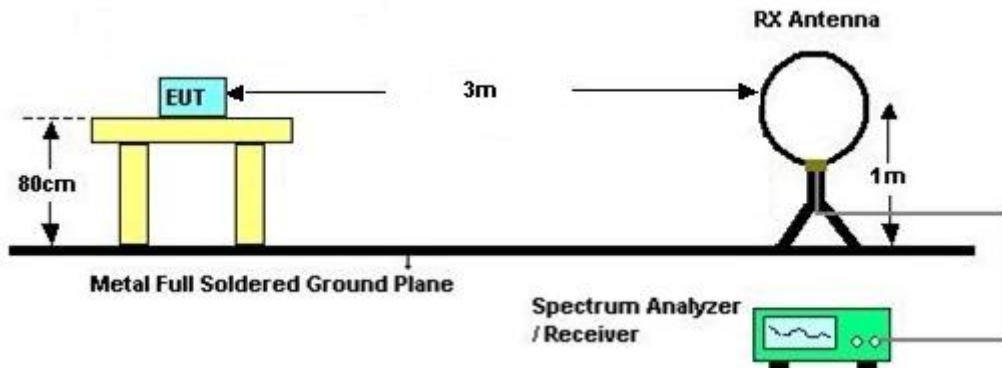

For radiated emissions above 30MHz

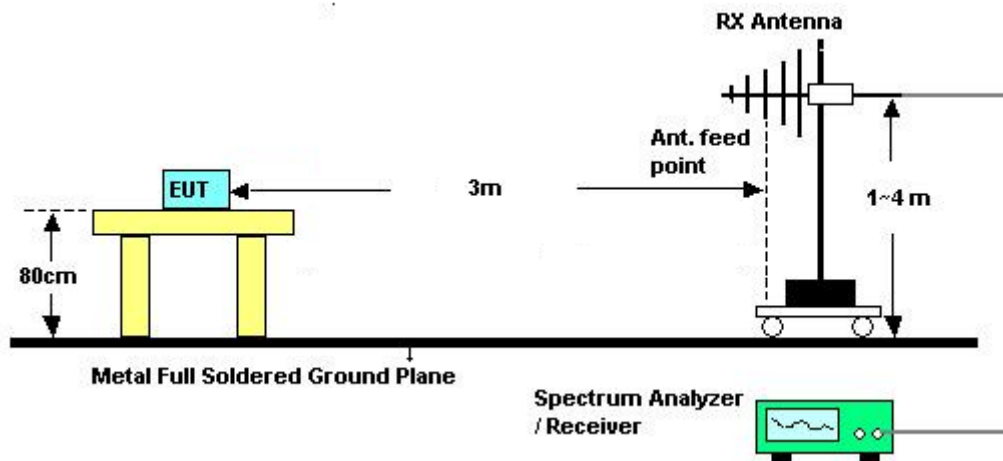

3.4.5 Test Deviation

There is no deviation with the original standard.

3.4.6 EUT Operation during Test

The EUT was programmed to be in continuously transmitting mode.

3.4.7 Results of Radiated Emissions (9kHz~30MHz)

Final Test Date	Feb. 04, 2014	Test Site No.	03CH07-HY
Temperature	20~22°C	Humidity	49~51%
Test Engineer	Eric Shih	Configurations	Ch. 1

Horizontal

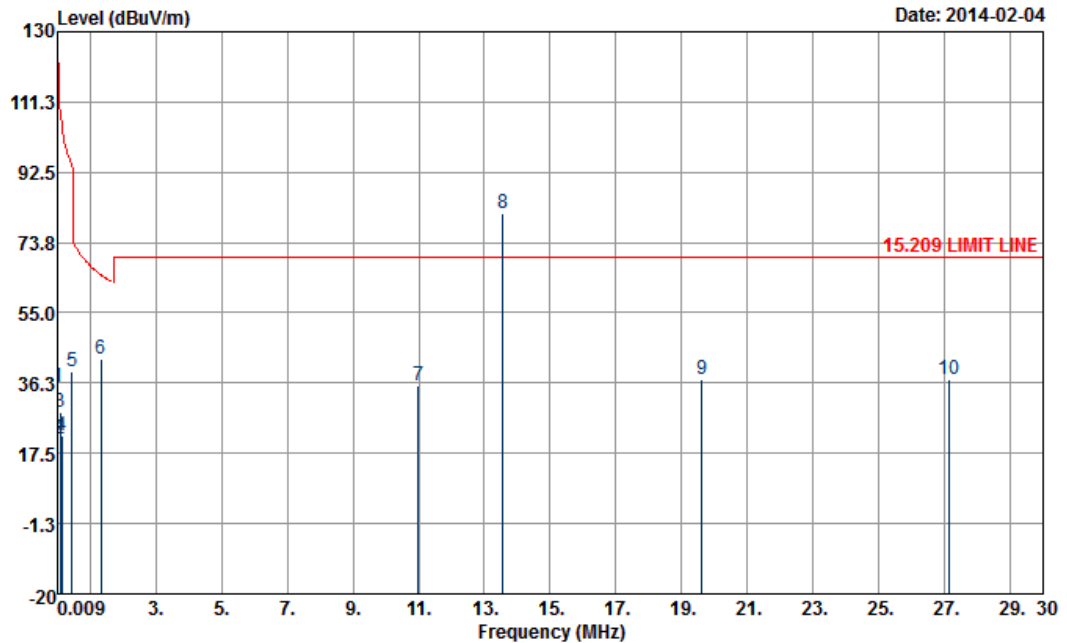

Site : 03CH07-HY
 Condition : 15.209 LIMIT LINE 3m NFC FACTOR(120912)-H HORIZONTAL
 Project : FR 413003
 Mode : 1

	Freq	Level	Over	Limit	ReadAntenna	Cable	A/Pos	T/Pos	Remark	
	MHz	dBuV/m	dB	dBuV/m	dBuV	dB/m	dB	cm	deg	
1	0.02	35.27	-87.24	122.51	14.72	20.26	0.29	---	---	Average
2	0.09	21.47	-87.49	108.96	1.11	20.07	0.29	---	---	Average
3	0.10	28.59	-78.66	107.25	8.23	20.07	0.29	---	---	QP
4	0.14	22.19	-82.34	104.53	1.84	20.06	0.29	---	---	Average
5	0.45	39.37	-55.18	94.55	19.08	20.00	0.29	---	---	Average
6	1.32	42.47	-22.70	65.17	22.15	20.01	0.31	100	164	QP
7	10.99	35.53	-34.47	70.00	15.37	19.77	0.39	---	---	QP
8 *	13.56	81.66			61.51	19.75	0.40	---	---	QP
9	19.63	37.19	-32.81	70.00	16.66	20.10	0.43	---	---	QP
10	27.12	37.24	-32.76	70.00	16.38	20.38	0.48	---	---	QP

Vertical

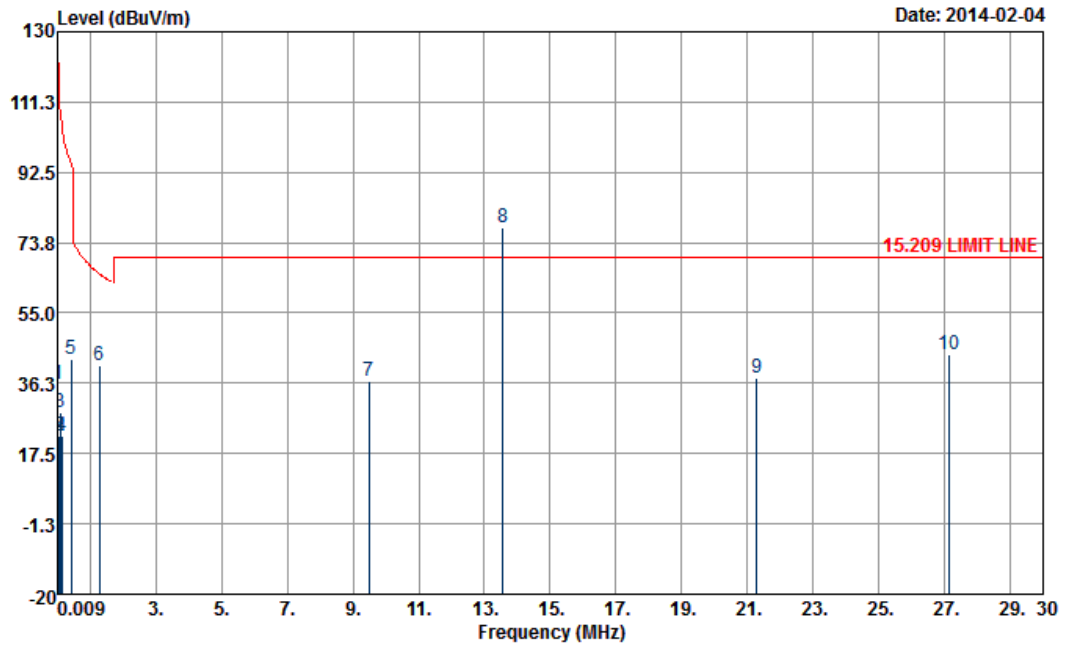

Site : 03CH07-HY
 Condition : 15.209 LIMIT LINE 3m NFC FACTOR(120912)-V VERTICAL
 Project : FR 413003
 Mode : 1

	Freq	Level	Over	Limit	ReadAntenna	Cable	A/Pos	T/Pos	Remark	
	MHz	dBuV/m	dB	dBuV/m	dBuV	dB/m	dB	cm	deg	
1	0.02	36.14	-86.35	122.49	15.59	20.26	0.29	---	---	Average
2	0.06	22.18	-89.43	111.61	1.78	20.11	0.29	---	---	Average
3	0.10	28.48	-78.81	107.29	8.12	20.07	0.29	---	---	QP
4	0.15	22.10	-82.27	104.37	1.77	20.04	0.29	---	---	Average
5	0.44	42.67	-52.12	94.79	22.38	20.00	0.29	---	---	Average
6	1.29	40.84	-24.58	65.42	20.52	20.01	0.31	100	293	QP
7	9.49	36.83	-33.17	70.00	16.70	19.75	0.38	---	---	QP
8 *	13.56	77.57			57.42	19.75	0.40	---	---	QP
9	21.28	37.73	-32.27	70.00	17.04	20.26	0.43	---	---	QP
10	27.12	44.05	-25.95	70.00	23.19	20.38	0.48	---	---	QP

Note:

1. Remark 8 is transmitter's fundamental signal.
2. The amplitude of spurious emissions which are attenuated by more than 20dB below the permissible value has no need to be reported.

Distance extrapolation factor = 40 log (specific distance / test distance) (dB);

Limit line = specific limits (dBuV) + distance extrapolation factor.

3.4.8 Results for Radiated Emissions (30MHz~1GHz)

Final Test Date	Feb. 04, 2014	Test Site No.	03CH07-HY
Temperature	20~22°C	Humidity	49~51%
Test Engineer	Eric Shih	Configurations	Ch. 1

Horizontal

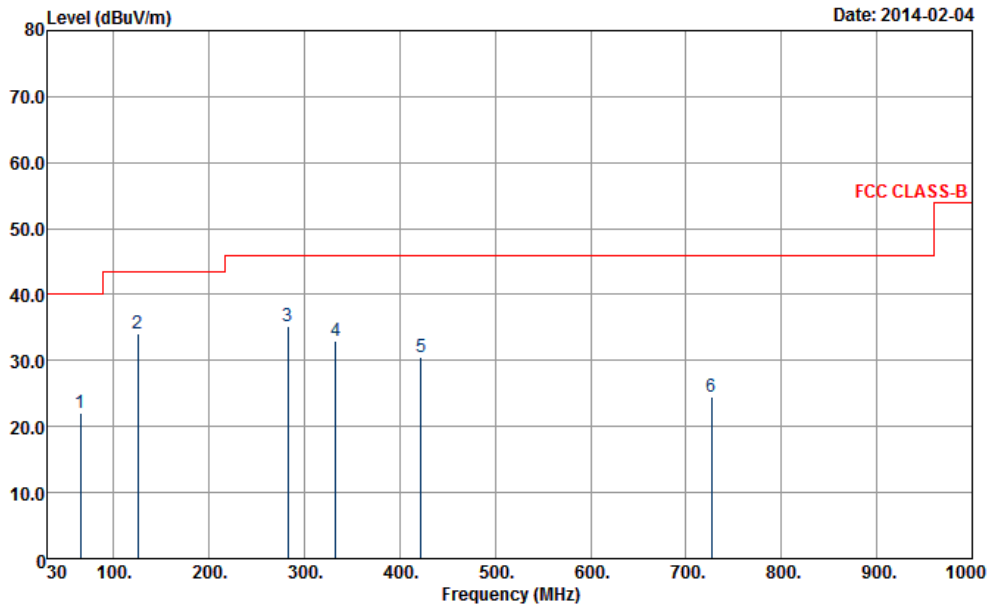

Site : 03CH07-HY
 Condition : FCC CLASS-B 3m LF-ANT(131102) HORIZONTAL
 Project : FR 413003
 Mode : 1

	Freq	Level	Over	Limit	ReadAntenna	Cable	Preamp	A/Pos	T/Pos	Remark	
	MHz	dBuV/m	Limit	Line	Level	Factor	Loss	Factor	cm	deg	
			dB	dBuV/m	dBuV	dB/m	dB	dB			
1	64.83	21.98	-18.02	40.00	46.38	6.00	0.80	31.20	---	---	Peak
2	125.04	34.06	-9.44	43.50	52.44	11.60	1.12	31.10	138	37	Peak
3	282.18	35.20	-10.80	46.00	51.63	12.86	1.65	30.94	---	---	Peak
4	332.90	33.04	-12.96	46.00	48.30	13.88	1.86	31.00	---	---	Peak
5	421.80	30.58	-15.42	46.00	42.41	16.74	2.22	30.79	---	---	Peak
6	727.00	24.62	-21.38	46.00	30.17	21.84	3.01	30.40	---	---	Peak

Vertical

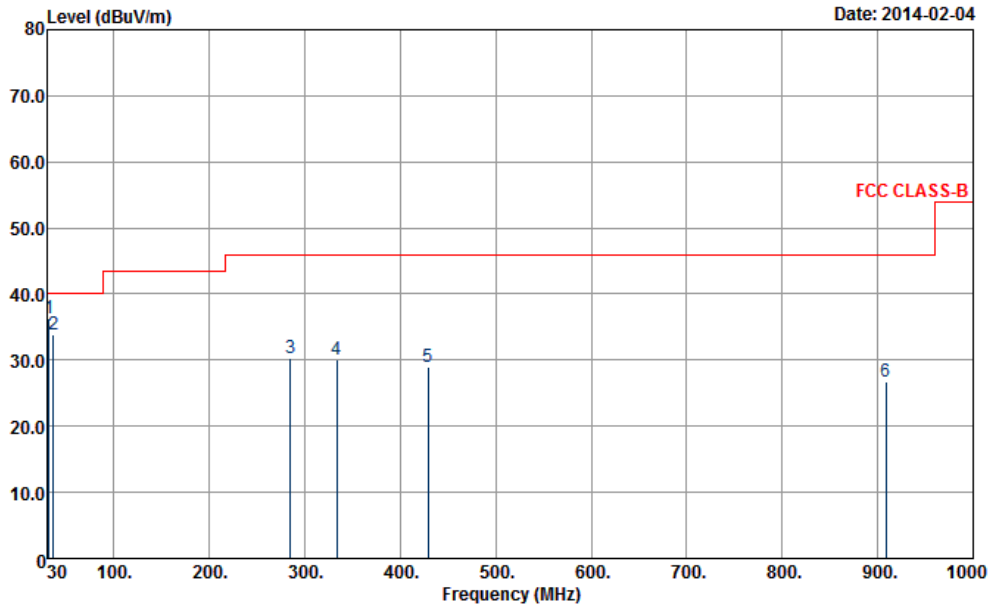

Site : 03CH07-HY
 Condition : FCC CLASS-B 3m LF-ANT(131102) VERTICAL
 Project : FR 413003
 Mode : 1

	Freq	Level	Over	Limit	ReadAntenna	Cable	Preamp	A/Pos	T/Pos	Remark
	MHz	dBuV/m	dB	dBuV/m	dBuV	dB/m	dB	dB	cm	deg
1	31.62	36.21	-3.79	40.00	49.32	17.76	0.55	31.42	178	257 Peak
2	36.48	33.92	-6.08	40.00	49.26	15.32	0.60	31.26	---	---
3	285.15	30.41	-15.59	46.00	46.80	12.95	1.66	31.00	---	---
4	333.60	30.19	-15.81	46.00	45.42	13.91	1.86	31.00	---	---
5	428.80	28.93	-17.07	46.00	40.57	16.88	2.24	30.76	---	---
6	909.00	26.76	-19.24	46.00	30.25	23.47	3.36	30.32	---	---

Note:

The amplitude of spurious emissions which are attenuated by more than 20dB below the permissible value has no need to be reported.

Emission level (dBUV/m) = 20 log Emission level (uV/m).

Corrected Reading: Antenna Factor + Cable Loss + Read Level - Preamp Factor= Level.

3.5 Frequency Stability Measurement

3.5.1 Limit

The frequency tolerance of the carrier signal shall be maintained within +/- 0.01% (100ppm) of the operating frequency over a temperature variation of -20 degrees to +50 degrees C at normal supply voltage, and for a variation in the primary supply voltage from 85% to 115% of the rated supply voltage at a temperature of 20 degrees C. For battery operated equipment, the equipment tests shall be performed using a new battery.

3.5.2 Measuring Instruments and Setting

Please refer to section 4 of equipments list in this report. The following table is the setting of the spectrum analyzer.

Spectrum Parameter	Setting
Attenuation	Auto
Span Frequency	Entire absence of modulation emissions bandwidth
RBW	1 kHz
VBW	3 kHz
Sweep Time	Auto

3.5.3 Test Procedures

1. The transmitter output (antenna port) was connected to the spectrum analyzer.
2. EUT have transmitted absence of modulation signal and fixed channelize.
3. Set the spectrum analyzer span to view the entire absence of modulation emissions bandwidth.
4. Set RBW = 1 kHz, VBW = 3 kHz with peak detector and maxhold settings.
5. fc is declaring of channel frequency. Then the frequency error formula is $(fc-f)/fc \times 10^6$ ppm and the limit is less than ± 100 ppm.
6. The test extreme voltage is to change the primary supply voltage from 85 to 115 percent of the nominal value
7. Extreme temperature rule is -20°C~50°C.

3.5.4 Test Setup Layout

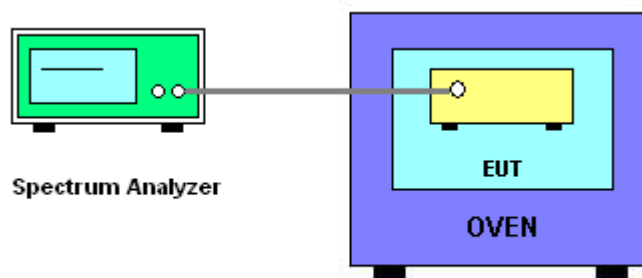

3.5.5 Test Deviation

There is no deviation with the original standard.

3.5.6 EUT Operation during Test

The EUT was programmed to be in continuously un-modulation transmitting mode.

3.5.7 Test Result of Frequency Stability

Final Test Date	Feb. 06, 2014	Test Site No.	TH02-HY
Temperature	22~24°C	Humidity	53~55%
Test Engineer	Tommy Lee	Configurations	Ch. 1

Voltage vs. Frequency Stability

Voltage(V)	Measurement Frequency (MHz)
120	13.559900
102	13.559900
138	13.559920
Max. Deviation (MHz)	-0.000100
Max. Deviation (ppm)	-7.3746

Temperature vs. Frequency Stability

Temperature (°C)	Measurement Frequency (MHz)
-20	13.559910
-10	13.559900
0	13.559910
10	13.559900
20	13.559900
30	13.559900
40	13.559920
50	13.559930
Max. Deviation (MHz)	-0.000100
Max. Deviation (ppm)	-7.3746

3.6 Antenna Requirements

3.6.1 Limit

Except for special regulations, the Low-power Radio-frequency Devices must not be equipped with any jacket for installing an antenna with extension cable. An intentional radiator shall be designed to ensure that no antenna other than that furnished by the responsible party shall be used with the device. The use of a permanently attached antenna or of an antenna that uses a unique coupling to the intentional radiator shall be considered sufficient to comply with the provisions of this Section. The manufacturer may design the unit so that the user can replace a broken antenna, but the use of a standard antenna jack or electrical connector is prohibited.

3.6.2 Antenna Connector Construction

Embedded in Antenna.

4. LIST OF MEASURING EQUIPMENT

Instrument	Manufacturer	Model No.	Serial No.	Characteristics	Calibration Date	Test Date	Due Date	Remark
Spectrum Analyzer	Rohde & Schwarz	FSP40	100055	9kHz~40GHz	Jun. 07, 2013	Feb. 06, 2014	Jun. 06, 2014	Conducted (TH02-HY)
Thermal Chamber	Ten Billion	TTH-D3SP	TBN-930701	N/A	Jul. 19, 2013	Feb. 06, 2014	Jul. 18, 2014	Conducted (TH02-HY)
EMI Test Receiver	Rohde & Schwarz	ESCS 30	100356	9kHz ~ 2.75GHz	Nov. 15, 2013	Feb. 20, 2014	Nov. 14, 2014	Conduction (CO05-HY)
LISN (for auxiliary equipment)	Rohde & Schwarz	ENV216	100081	9kHz ~ 30MHz	Dec. 12, 2013	Feb. 20, 2014	Dec. 11, 2014	Conduction (CO05-HY)
LISN	Rohde & Schwarz	ENV216	100080	9kHz ~ 30MHz	Dec. 04, 2013	Feb. 20, 2014	Dec. 03, 2014	Conduction (CO05-HY)
AC Power Source	ChainTek	APC-1000W	N/A	N/A	N/A	Feb. 20, 2014	N/A	Conduction (CO05-HY)
EMI Test Receiver	Rohde & Schwarz	ESCI 7	100724	9kHz~7GHz	Sep. 06, 2013	Feb. 04, 2014	Sep. 05, 2014	Radiation (03CH07-HY)
Loop Antenna	Rohde & Schwarz	HFH2-Z2	860004/0001	9kHz~30 MhZ	Jul. 03, 2012	Feb. 04, 2014	Jul. 02, 2014	Radiation (03CH07-HY)
Bilog Antenna	Schaffner	CBL6111C	2726	30MHz ~ 1GHz	Oct. 10, 2013	Feb. 04, 2014	Oct. 09, 2014	Radiation (03CH07-HY)
Preamplifier	SONOMA	310N	187231	9kHz~1GHz	May 15, 2013	Feb. 04, 2014	May 14, 2014	Radiation (03CH07-HY)
Turn Table	ChainTek	ChainTek 3000	N/A	0 ~ 360 degree	N/A	Feb. 04, 2014	N/A	Radiation (03CH07-HY)
Antenna Mast	ChainTek	ChainTek 3000	N/A	N/A	N/A	Feb. 04, 2014	N/A	Radiation (03CH07-HY)

5. TEST LOCATION

HWA YA	ADD : No. 52, Hwa Ya 1st Rd., Kwei-Shan Hsiang, Tao Yuan Hsien, Taiwan, R.O.C.
	TEL : 886-3-327-3456
	FAX : 886-3-318-0055

6. TAF CERTIFICATE OF ACCREDITATION



