



# FCC SAR Test Report

**APPLICANT** : VeriFone Inc.  
**EQUIPMENT** : Point of Sale Terminal  
**BRAND NAME** : VeriFone  
**MODEL NAME** : VX680 3G  
**FCC ID** : B32VX680WCDMA  
**STANDARD** : FCC 47 CFR Part 2 (2.1093)  
ANSI/IEEE C95.1-1992  
IEEE 1528-2003  
FCC OET Bulletin 65 Supplement C (Edition 01-01)

The product was completely tested on Nov. 19, 2012. We, SPORTON INTERNATIONAL INC., would like to declare that the tested sample has been evaluated in accordance with the procedures and shown the compliance with the applicable technical standards.

The test results in this report apply exclusively to the tested model / sample. Without written approval of SPORTON INTERNATIONAL INC., the test report shall not be reproduced except in full.

Reviewed by:

Jones Tsai / Manager



## SPORTON INTERNATIONAL INC.

No. 52, Hwa Ya 1<sup>st</sup> Rd., Hwa Ya Technology Park, Kwei-Shan Hsiang, Tao Yuan Hsien, Taiwan, R.O.C.



## Table of Contents

<b>1. Statement of Compliance</b>	<b>4</b>
<b>2. Administration Data</b>	<b>5</b>
2.1 Testing Laboratory	5
2.2 Applicant	5
2.3 Manufacturer	5
2.4 Application Details	5
<b>3. General Information</b>	<b>6</b>
3.1 Description of Equipment Under Test (EUT)	6
3.2 Product Photos	7
3.3 Applied Standard	7
3.4 Device Category and SAR Limits	7
3.5 Test Conditions	7
<b>4. Specific Absorption Rate (SAR)</b>	<b>8</b>
4.1 Introduction	8
4.2 SAR Definition	8
<b>5. SAR Measurement System</b>	<b>9</b>
5.1 E-Field Probe	10
5.2 Data Acquisition Electronics (DAE)	11
5.3 Robot	11
5.4 Measurement Server	11
5.5 Phantom	12
5.6 Device Holder	13
5.7 Data Storage and Evaluation	14
5.8 Test Equipment List	16
<b>6. Tissue Simulating Liquids</b>	<b>17</b>
<b>7. SAR Measurement Evaluation</b>	<b>19</b>
7.1 Purpose of System Performance check	19
7.2 System Setup	19
7.3 SAR System Verification Results	20
<b>8. EUT Testing Position</b>	<b>21</b>
8.1 Body Worn Position	21
<b>9. Measurement Procedures</b>	<b>22</b>
9.1 Spatial Peak SAR Evaluation	22
9.2 Area & Zoom Scan Procedures	23
9.3 Volume Scan Procedures	23
9.4 SAR Averaged Methods	23
9.5 Power Drift Monitoring	23
<b>10. SAR Test Configurations</b>	<b>24</b>
10.1 Exposure Positions Consideration	24
10.2 Conducted RF Output Power (Unit: dBm)	25
<b>11. SAR Test Results</b>	<b>29</b>
11.1 Test Records for Body-worn SAR Test	29
<b>12. Uncertainty Assessment</b>	<b>30</b>
<b>13. References</b>	<b>32</b>
<b>Appendix A. Plots of System Performance Check</b>	
<b>Appendix B. Plots of SAR Measurement</b>	
<b>Appendix C. DASYS Calibration Certificate</b>	
<b>Appendix D. Product Photos</b>	
<b>Appendix E. Test Setup Photos</b>	





### 1. Statement of Compliance

The maximum results of Specific Absorption Rate (SAR) found during testing for **VeriFone Inc. Point of Sale Terminal, VeriFone, VX680 3G** are as follows.

#### <Highest standalone SAR Summary>

Band	Position	SAR <sub>1g</sub> (W/kg)
GSM850	Body (0 cm Gap)	0.564
GSM1900	Body (0 cm Gap)	0.181
WCDMA Band V	Body (0 cm Gap)	0.638
WCDMA Band II	Body (0 cm Gap)	0.295

This device is in compliance with Specific Absorption Rate (SAR) for general population/uncontrolled exposure limits (1.6 W/kg) specified in FCC 47 CFR part 2 (2.1093) and ANSI/IEEE C95.1-1992, and had been tested in accordance with the measurement methods and procedures specified in IEEE 1528-2003 and FCC OET Bulletin 65 Supplement C (Edition 01-01).



**2. Administration Data**

**2.1 Testing Laboratory**

Test Site	SPORTON INTERNATIONAL INC.
Test Site Location	No. 52, Hwa Ya 1 <sup>st</sup> Rd., Hwa Ya Technology Park, Kwei-Shan Hsiang, Tao Yuan Hsien, Taiwan, R.O.C. TEL: +886-3-327-3456 FAX: +886-3-328-4978

**2.2 Applicant**

Company Name	VeriFone Inc.
Address	1400 West Stanford Ranch Road Suite 200 Rocklin CA 95765 USA

**2.3 Manufacturer**

Company Name	Inventec Appliances (Pudong) Co., Ltd.
Address	No. 789 Pu Xing Road, Shanghai, PRC

**2.4 Application Details**

Date of Start during the Test	Nov. 19, 2012
Date of End during the Test	Nov. 19, 2012



### 3. General Information

#### 3.1 Description of Equipment Under Test (EUT)

Product Feature & Specification	
EUT	Point of Sale Terminal
Brand Name	VeriFone
Model Name	VX680 3G
FCC ID	B32VX680WCDMA
IMEI Code	013454000002661
Tx Frequency	GSM850: 824.2 MHz ~ 848.8 MHz GSM1900: 1850.2 MHz ~ 1909.8 MHz WCDMA Band V: 826.4 MHz ~ 846.6 MHz WCDMA Band II: 1852.4 MHz ~ 1907.6 MHz NFC : 13.56 MHz
Measure Maximum Average Output Power to Antenna	GSM850: 32.75 dBm GSM1900: 29.74 dBm WCDMA Band V: 23.40 dBm WCDMA Band II: 22.77 dBm
Antenna Type	WWAN: PIFA Antenna NFC: Fixed Internal Antenna
Uplink Modulations	GPRS: GMSK EDGE: GMSK / 8PSK WCDMA (Rel 99): QPSK HSDPA (Rel 6): QPSK HSUPA (Rel 6): QPSK NFC : ASK
EUT Stage	Identical Prototype
Remark:	<ol style="list-style-type: none"><li>1. The above EUT's information was declared by manufacturer. Please refer to the specifications or user's manual for more detailed description.</li><li>2. Voice call is not supported.</li></ol>



**3.2 Product Photos**

Please refer to Appendix D.

**3.3 Applied Standard**

The Specific Absorption Rate (SAR) testing specification, method, and procedure for this device is in accordance with the following standards:

- FCC 47 CFR Part 2 (2.1093)
- ANSI/IEEE C95.1-1992
- IEEE 1528-2003
- FCC OET Bulletin 65 Supplement C (Edition 01-01)
- FCC KDB 447498 D01 v04
- FCC KDB 648474 D01 v01r01
- FCC KDB 616217 D03 v01
- FCC KDB 941225 D01 v02
- FCC KDB 941225 D03 v01

**3.4 Device Category and SAR Limits**

This device belongs to portable device category because its radiating structure is allowed to be used within 20 centimeters of the body of the user. Limit for General Population/Uncontrolled exposure should be applied for this device, it is 1.6 W/kg as averaged over any 1 gram of tissue.

**3.5 Test Conditions**

**3.5.1 Ambient Condition**

Ambient Temperature	20 to 24 °C
Humidity	< 60 %

**3.5.2 Test Configuration**

The device was controlled by using a base station emulator. Communication between the device and the emulator was established by air link. The distance between the EUT and the antenna of the emulator is larger than 50 cm and the output power radiated from the emulator antenna is at least 30 dB smaller than the output power of EUT. The EUT was set from the emulator to radiate maximum output power during all tests.

## **4. Specific Absorption Rate (SAR)**

### **4.1 Introduction**

SAR is related to the rate at which energy is absorbed per unit mass in an object exposed to a radio field. The SAR distribution in a biological body is complicated and is usually carried out by experimental techniques or numerical modeling. The standard recommends limits for two tiers of groups, occupational/controlled and general population/uncontrolled, based on a person's awareness and ability to exercise control over his or her exposure. In general, occupational/controlled exposure limits are higher than the limits for general population/uncontrolled.

### **4.2 SAR Definition**

The SAR definition is the time derivative (rate) of the incremental energy (dW) absorbed by (dissipated in) an incremental mass (dm) contained in a volume element (dv) of a given density ( $\rho$ ). The equation description is as below:

$$\text{SAR} = \frac{d}{dt} \left( \frac{dW}{dm} \right) = \frac{d}{dt} \left( \frac{dW}{\rho dv} \right)$$

SAR is expressed in units of Watts per kilogram (W/kg)

SAR measurement can be either related to the temperature elevation in tissue by

$$\text{SAR} = C \left( \frac{\delta T}{\delta t} \right)$$

Where: C is the specific heat capacity,  $\delta T$  is the temperature rise and  $\delta t$  is the exposure duration, or related to the electrical field in the tissue by

$$\text{SAR} = \frac{\sigma |E|^2}{\rho}$$

Where:  $\sigma$  is the conductivity of the tissue,  $\rho$  is the mass density of the tissue and E is the RMS electrical field strength.

However for evaluating SAR of low power transmitter, electrical field measurement is typically applied.



## 5. SAR Measurement System

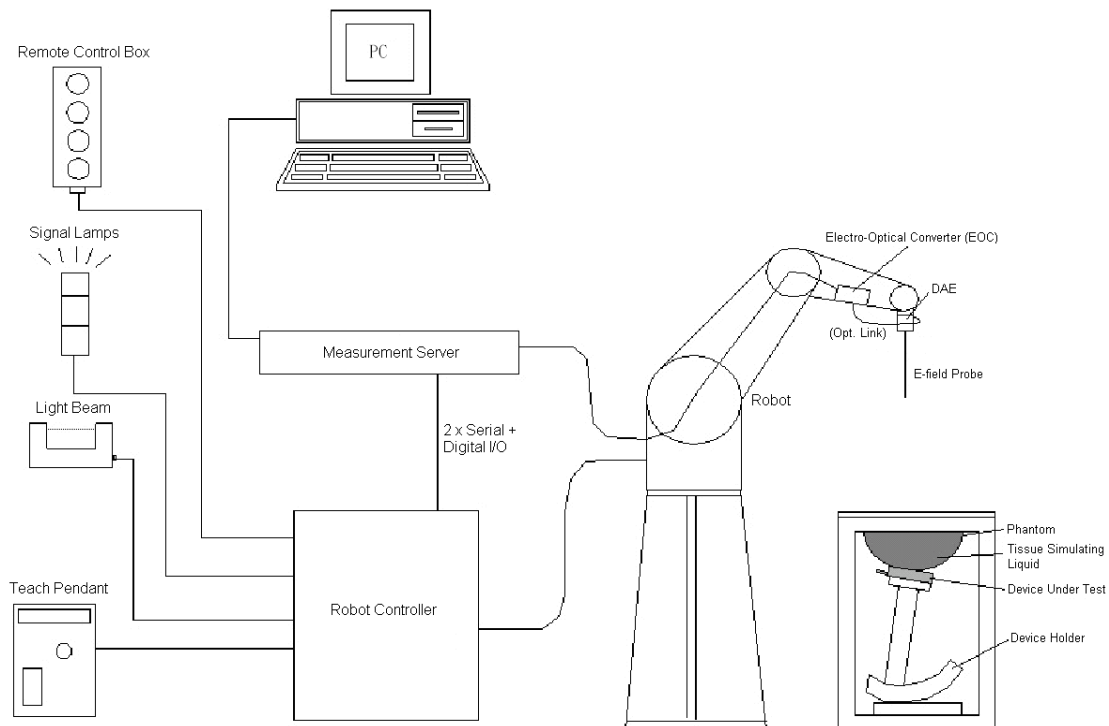

**Fig 5.1 SPEAG DASY System Configurations**

The DASY system for performance compliance tests is illustrated above graphically. This system consists of the following items:

- A standard high precision 6-axis robot with controller, a teach pendant and software
- A data acquisition electronic (DAE) attached to the robot arm extension
- A dosimetric probe equipped with an optical surface detector system
- The electro-optical converter (EOC) performs the conversion between optical and electrical signals
- A measurement server performs the time critical tasks such as signal filtering, control of the robot operation and fast movement interrupts.
- A probe alignment unit which improves the accuracy of the probe positioning
- A computer operating Windows XP
- DASY software
- Remote control with teach pendant and additional circuitry for robot safety such as warning lamps, etc.
- The SAM twin phantom
- A device holder
- Tissue simulating liquid
- Dipole for evaluating the proper functioning of the system

Component details are described in in the following sub-sections.

### 5.1 E-Field Probe

The SAR measurement is conducted with the dosimetric probe (manufactured by SPEAG). The probe is specially designed and calibrated for use in liquid with high permittivity. The dosimetric probe has special calibration in liquid at different frequency. This probe has a built in optical surface detection system to prevent from collision with phantom.

#### 5.1.1 E-Field Probe Specification

##### <ET3DV6 / ET3DV6R Probe >

<b>Construction</b>	Symmetrical design with triangular core Built-in optical fiber for surface detection system. Built-in shielding against static charges. PEEK enclosure material (resistant to organic solvents, e.g., DGBE)	 <p><b>Fig 5.2</b> Photo of ET3DV6/ET3DV6</p>
<b>Frequency</b>	10 MHz to 3 GHz; Linearity: $\pm 0.2$ dB	
<b>Directivity</b>	$\pm 0.2$ dB in HSL (rotation around probe axis) $\pm 0.4$ dB in HSL (rotation normal to probe axis)	
<b>Dynamic Range</b>	5 $\mu$ W/g to 100 mW/g; Linearity: $\pm 0.2$ dB	
<b>Dimensions</b>	Overall length: 330 mm (Tip: 16 mm) Tip diameter: 6.8 mm (Body: 12 mm) Distance from probe tip to dipole centers: 2.7 mm	

##### <EX3DV4 / ES3DV4 Probe >

<b>Construction</b>	Symmetrical design with triangular core Built-in shielding against static charges PEEK enclosure material (resistant to organic solvents, e.g., DGBE)	 <p><b>Fig 5.3</b> Photo of EX3DV4/ES3DV4</p>
<b>Frequency</b>	10 MHz to 6 GHz; Linearity: $\pm 0.2$ dB	
<b>Directivity</b>	$\pm 0.3$ dB in HSL (rotation around probe axis) $\pm 0.5$ dB in tissue material (rotation normal to probe axis)	
<b>Dynamic Range</b>	10 $\mu$ W/g to 100 mW/g; Linearity: $\pm 0.2$ dB (noise: typically $< 1$ $\mu$ W/g)	
<b>Dimensions</b>	Overall length: 330 mm (Tip: 20 mm) Tip diameter: 2.5 mm (Body: 12 mm) Typical distance from probe tip to dipole centers: 1 mm	

#### 5.1.2 E-Field Probe Calibration

Each probe needs to be calibrated according to a dosimetric assessment procedure with accuracy better than  $\pm 10\%$ . The spherical isotropy shall be evaluated and within  $\pm 0.25$ dB. The sensitivity parameters (NormX, NormY, and NormZ), the diode compression parameter (DCP) and the conversion factor (ConvF) of the probe are tested. The calibration data can be referred to appendix C of this report.

### 5.2 Data Acquisition Electronics (DAE)

The data acquisition electronics (DAE) consists of a highly sensitive electrometer-grade preamplifier with auto-zeroing, a channel and gain-switching multiplexer, a fast 16 bit AD-converter and a command decoder and control logic unit. Transmission to the measurement server is accomplished through an optical downlink for data and status information as well as an optical uplink for commands and the clock. The input impedance of the DAE is 200 MOhm; the inputs are symmetrical and floating. Common mode rejection is above 80 dB.



Fig 5.4 Photo of DAE

### 5.3 Robot

The SPEAG DASY system uses the high precision robots (DASY4: RX90BL; DASY5: TX90XL) type from Stäubli SA (France). For the 6-axis controller system, the robot controller version (DASY4: CS7MB; DASY5: CS8c) from Stäubli is used. The Stäubli robot series have many features that are important for our application:

- High precision (repeatability  $\pm 0.035$  mm)
- High reliability (industrial design)
- Jerk-free straight movements
- Low ELF interference (the closed metallic construction shields against motor control fields)

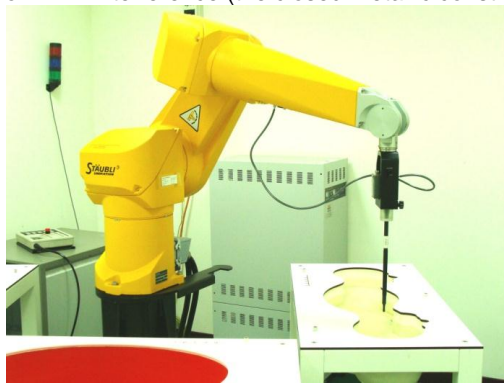

Fig 5.5 Photo of DASY4



Fig 5.6 Photo of DASY5

### 5.4 Measurement Server

The measurement server is based on a PC/104 CPU board with CPU (DASY4: 166 MHz, Intel Pentium; DASY5: 400 MHz, Intel Celeron), chipdisk (DASY4: 32 MB; DASY5: 128 MB), RAM (DASY4: 64 MB, DASY5: 128 MB). The necessary circuits for communication with the DAE electronic box, as well as the 16 bit AD converter system for optical detection and digital I/O interface are contained on the DASY I/O board, which is directly connected to the PC/104 bus of the CPU board.

The measurement server performs all the real-time data evaluation for field measurements and surface detection, controls robot movements and handles safety operations.



Fig 5.7 Photo of Server for DASY4



Fig 5.8 Photo of Server for DASY5

**5.5 Phantom**

**<SAM Twin Phantom>**

<b>Shell Thickness</b>	2 ± 0.2 mm; Center ear point: 6 ± 0.2 mm	 <p><b>Fig 5.9 Photo of SAM Phantom</b></p>
<b>Filling Volume</b>	Approx. 25 liters	
<b>Dimensions</b>	Length: 1000 mm; Width: 500 mm; Height: adjustable feet	
<b>Measurement Areas</b>	Left Hand, Right Hand, Flat Phantom	

The bottom plate contains three pair of bolts for locking the device holder. The device holder positions are adjusted to the standard measurement positions in the three sections. A white cover is provided to tap the phantom during off-periods to prevent water evaporation and changes in the liquid parameters. On the phantom top, three reference markers are provided to identify the phantom position with respect to the robot.

**<ELI4 Phantom>**

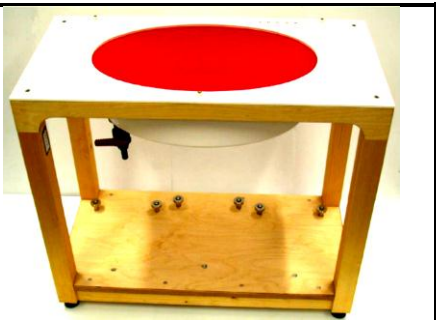
<b>Shell Thickness</b>	2 ± 0.2 mm (sagging: <1%)	 <p><b>Fig 5.10 Photo of ELI4 Phantom</b></p>
<b>Filling Volume</b>	Approx. 30 liters	
<b>Dimensions</b>	Major ellipse axis: 600 mm Minor axis: 400 mm	

The ELI4 phantom is intended for compliance testing of handheld and body-mounted wireless devices in the frequency range of 30 MHz to 6 GHz. ELI4 is fully compatible with standard and all known tissue simulating liquids.

## 5.6 Device Holder

### <Device Holder for SAM Twin Phantom>

The SAR in the phantom is approximately inversely proportional to the square of the distance between the source and the liquid surface. For a source at 5 mm distance, a positioning uncertainty of  $\pm 0.5$  mm would produce a SAR uncertainty of  $\pm 20$  %. Accurate device positioning is therefore crucial for accurate and repeatable measurements. The positions in which the devices must be measured are defined by the standards.

The DASY device holder is designed to cope with different positions given in the standard. It has two scales for the device rotation (with respect to the body axis) and the device inclination (with respect to the line between the ear reference points). The rotation center for both scales is the ear reference point (ERP). Thus the device needs no repositioning when changing the angles.

The DASY device holder is constructed of low-loss POM material having the following dielectric parameters: relative permittivity  $\epsilon = 3$  and loss tangent  $\delta = 0.02$ . The amount of dielectric material has been reduced in the closest vicinity of the device, since measurements have suggested that the influence of the clamp on the test results could thus be lowered.



Fig 5.11 Device Holder

### <Laptop Extension Kit>

The extension is lightweight and made of POM, acrylic glass and foam. It fits easily on the upper part of the mounting device in place of the phone positioned. The extension is fully compatible with the SAM Twin and ELI phantoms.

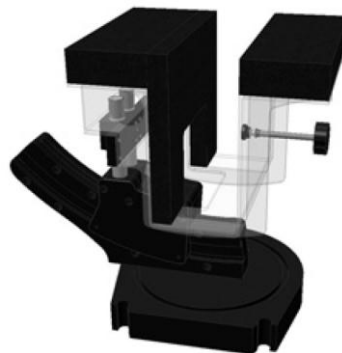

Fig 5.12 Laptop Extension Kit



## 5.7 Data Storage and Evaluation

### 5.7.1 Data Storage

The DASY software stores the assessed data from the data acquisition electronics as raw data (in microvolt readings from the probe sensors), together with all the necessary software parameters for the data evaluation (probe calibration data, liquid parameters and device frequency and modulation data) in measurement files. The post-processing software evaluates the desired unit and format for output each time the data is visualized or exported. This allows verification of the complete software setup even after the measurement and allows correction of erroneous parameter settings. For example, if a measurement has been performed with an incorrect crest factor parameter in the device setup, the parameter can be corrected afterwards and the data can be reevaluated.

The measured data can be visualized or exported in different units or formats, depending on the selected probe type (e.g., [V/m], [A/m], [mW/g]). Some of these units are not available in certain situations or give meaningless results, e.g., a SAR-output in a non-lose media, will always be zero. Raw data can also be exported to perform the evaluation with other software packages.

### 5.7.2 Data Evaluation

The DASY post-processing software (SEMCAD) automatically executes the following procedures to calculate the field units from the microvolt readings at the probe connector. The parameters used in the evaluation are stored in the configuration modules of the software :

<b>Probe parameters :</b>	- Sensitivity	Norm <sub>i</sub> , a <sub>i0</sub> , a <sub>i1</sub> , a <sub>i2</sub>
	- Conversion factor	ConvF <sub>i</sub>
	- Diode compression point	dcp <sub>i</sub>
<b>Device parameters :</b>	- Frequency	f
	- Crest factor	cf
<b>Media parameters :</b>	- Conductivity	σ
	- Density	ρ

These parameters must be set correctly in the software. They can be found in the component documents or they can be imported into the software from the configuration files issued for the DASY components. In the direct measuring mode of the multi-meter option, the parameters of the actual system setup are used. In the scan visualization and export modes, the parameters stored in the corresponding document files are used.

The first step of the evaluation is a linearization of the filtered input signal to account for the compression characteristics of the detector diode. The compensation depends on the input signal, the diode type and the DC-transmission factor from the diode to the evaluation electronics. If the exciting field is pulsed, the crest factor of the signal must be known to correctly compensate for peak power.



The formula for each channel can be given as :

$$V_i = U_i + U_i^2 \cdot \frac{cf}{dcp_i}$$

- with  $V_i$  = compensated signal of channel i, (i = x, y, z)
- $U_i$  = input signal of channel i, (i = x, y, z)
- cf = crest factor of exciting field (DASY parameter)
- dcp<sub>i</sub> = diode compression point (DASY parameter)

From the compensated input signals, the primary field data for each channel can be evaluated :

$$\text{E-field Probes : } E_i = \sqrt{\frac{V_i}{\text{Norm}_i \cdot \text{ConvF}}}$$

$$\text{H-field Probes : } H_i = \sqrt{V_i \cdot \frac{a_{i0} + a_{i1}f + a_{i2}f^2}{f}}$$

- with  $V_i$  = compensated signal of channel i, (i = x, y, z)
- Norm<sub>i</sub> = sensor sensitivity of channel i, (i = x, y, z),  $\mu\text{V}/(\text{V/m})^2$  for E-field Probes
- ConvF = sensitivity enhancement in solution
- $a_{ij}$  = sensor sensitivity factors for H-field probes
- f = carrier frequency [GHz]
- $E_i$  = electric field strength of channel i in V/m
- $H_i$  = magnetic field strength of channel i in A/m

The RSS value of the field components gives the total field strength (Hermitian magnitude) :

$$E_{\text{tot}} = \sqrt{E_x^2 + E_y^2 + E_z^2}$$

The primary field data are used to calculate the derived field units.

$$\text{SAR} = E_{\text{tot}}^2 \cdot \frac{\sigma}{\rho \cdot 1000}$$

- with SAR = local specific absorption rate in mW/g
- $E_{\text{tot}}$  = total field strength in V/m
- $\sigma$  = conductivity in [mho/m] or [Siemens/m]
- $\rho$  = equivalent tissue density in  $\text{g}/\text{cm}^3$

Note that the density is set to 1, to account for actual head tissue density rather than the density of the tissue simulating liquid.





**5.8 Test Equipment List**

Manufacturer	Name of Equipment	Type/Model	Serial Number	Calibration	
				Last Cal.	Due Date
SPEAG	835MHz System Validation Kit	D835V2	499	Mar. 22, 2010	Mar. 21, 2013
SPEAG	1900MHz System Validation Kit	D1900V2	5d041	Mar. 23, 2010	Mar. 22, 2013
SPEAG	Data Acquisition Electronics	DAE4	778	Aug. 27, 2012	Aug. 26, 2013
SPEAG	Dosimetric E-Field Probe	ES3DV3	3270	Sep. 28, 2012	Sep. 27, 2013
Wisewind	Thermometer	ETP-101	TM560	Nov. 16, 2011	Nov. 15, 2012
Wisewind	Thermometer	HTC-1	TM685	Nov. 16, 2011	Nov. 15, 2012
Wisewind	Thermometer	HTC-1	TM659	Nov. 16, 2011	Nov. 15, 2012
H.M.IRIS	Thermometer	TH-08	TM658	Nov. 16, 2011	Nov. 15, 2012
SPEAG	Device Holder	N/A	N/A	NCR	NCR
SPEAG	SAM Phantom	QD 000 P40 C	TP-1383	NCR	NCR
SPEAG	SAM Phantom	QD 000 P40 C	TP-1477	NCR	NCR
Agilent	Network Analyzer	E5071C	MY46101588	May. 11, 2012	May. 10, 2013
Agilent	ESG Vector Series Signal Generator	E4438C	MY49070755	Oct. 02, 2012	Oct. 01, 2013
Anritsu	Radio Communication Analyzer	MT8820C	6201074414	Dec. 21, 2011	Dec. 20, 2012
Agilent	Wireless Communication Test Set	E5515C	MY48360820	Jan. 05, 2012	Jan. 04, 2014
R&S	Universal Digital Radiocommunication Tester	CMU200	114256	Jun. 29, 2012	Jun. 28, 2013
Agilent	Dual Directional Coupler	778D	50422	NCR	NCR
Woken	Attenuator	WK0602-XX	N/A	NCR	NCR
AR	Power Amplifier	5S1G4M2	0328767	NCR	NCR
R&S	Spectrum Analyzer	FSP	101131	Jul. 23, 2012	Jul. 22, 2013

**Table 5.1 Test Equipment List**

**Note:**

1. The calibration certificate of DASY can be referred to appendix C of this report.
2. Referring to KDB 450824 D02, the dipole calibration interval can be extended to 3 years with justification. The dipoles are also not physically damaged, or repaired during the interval.
3. The justification data of dipole D835V2, SN: 499, D1900V2, SN: 5d041, can be found in appendix C. The return loss is < -20dB, within 20% of prior calibration, the impedance is within 5 ohm of prior calibration.



## 6. Tissue Simulating Liquids

For the measurement of the field distribution inside the SAM phantom with DASY, the phantom must be filled with around 25 liters of homogeneous body tissue simulating liquid. For head SAR testing, the liquid height from the ear reference point (ERP) of the phantom to the liquid top surface is larger than 15 cm, which is shown in Fig. 6.1. For body SAR testing, the liquid height from the center of the flat phantom to the liquid top surface is larger than 15 cm, which is shown in Fig. 6.2.

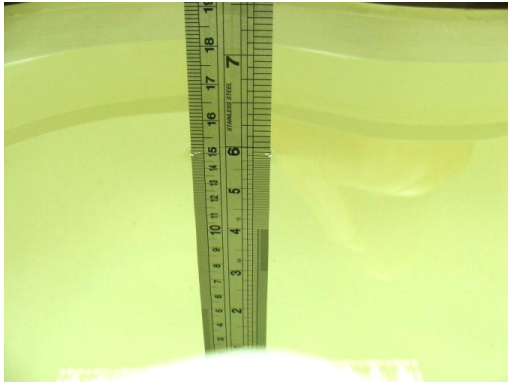

Fig 6.1 Photo of Liquid Height for Head SAR



Fig 6.2 Photo of Liquid Height for Body SAR

The following table gives the recipes for tissue simulating liquid.

Frequency (MHz)	Water (%)	Sugar (%)	Cellulose (%)	Salt (%)	Preventol (%)	DGBE (%)	Conductivity ( $\sigma$ )	Permittivity ( $\epsilon_r$ )
835	50.8	48.2	0	0.9	0.1	0	0.97	55.2
1800, 1900, 2000	70.2	0	0	0.4	0	29.4	1.52	53.3

Table 6.1 Recipes of Tissue Simulating Liquid



The dielectric parameters of the liquids were verified prior to the SAR evaluation using an Agilent 85070D Dielectric Probe Kit and an Agilent Network Analyzer.

The following table shows the measuring results for simulating liquid.

Freq. (MHz)	Liquid Type	Temp. (°C)	Conductivity ( $\sigma$ )	Permittivity ( $\epsilon_r$ )	Conductivity Target ( $\sigma$ )	Permittivity Target ( $\epsilon_r$ )	Delta ( $\sigma$ ) (%)	Delta ( $\epsilon_r$ ) (%)	Limit (%)	Date
835	Body	21.5	0.979	52.653	0.97	55.2	0.93	-4.61	±5	Nov. 19, 2012
1900	Body	21.6	1.546	52.216	1.52	53.3	1.71	-2.03	±5	Nov. 19, 2012

**Table 6.2 Measuring Results for Simulating Liquid**

## 7. SAR Measurement Evaluation

Each DASY system is equipped with one or more system validation kits. These units, together with the predefined measurement procedures within the DASY software, enable the user to conduct the system performance check and system validation. System validation kit includes a dipole, tripod holder to fix it underneath the flat phantom and a corresponding distance holder.

### 7.1 Purpose of System Performance check

The system performance check verifies that the system operates within its specifications. System and operator errors can be detected and corrected. It is recommended that the system performance check be performed prior to any usage of the system in order to guarantee reproducible results. The system performance check uses normal SAR measurements in a simplified setup with a well characterized source. This setup was selected to give a high sensitivity to all parameters that might fail or vary over time. The system check does not intend to replace the calibration of the components, but indicates situations where the system uncertainty is exceeded due to drift or failure.

### 7.2 System Setup

In the simplified setup for system evaluation, the EUT is replaced by a calibrated dipole and the power source is replaced by a continuous wave that comes from a signal generator. The calibrated dipole must be placed beneath the flat phantom section of the SAM twin phantom with the correct distance holder. The distance holder should touch the phantom surface with a light pressure at the reference marking and be oriented parallel to the long side of the phantom. The equipment setup is shown below:

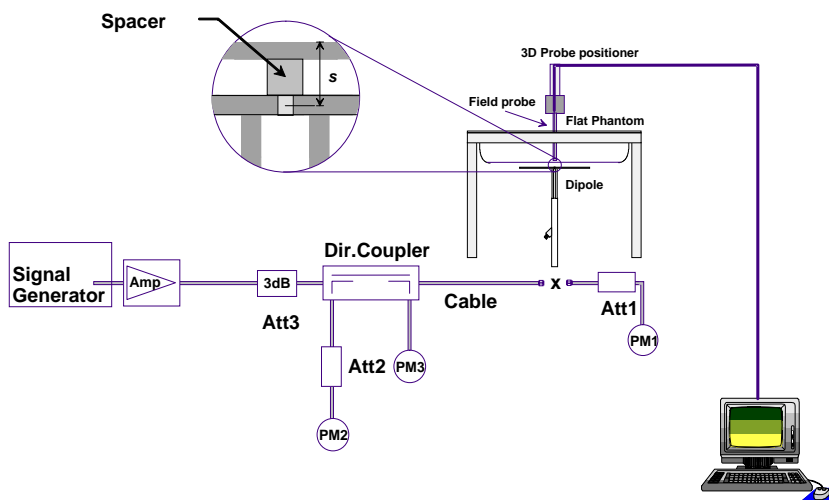

Fig 7.1 System Setup for System Evaluation



Fig 7.2 Photo of Dipole Setup

1. Signal Generator
2. Amplifier
3. Directional Coupler
4. Power Meter
5. Calibrated Dipole

The output power on dipole port must be calibrated to 24 dBm (250 mW) before dipole is connected.



### 7.3 SAR System Verification Results

Comparing to the original SAR value provided by SPEAG, the verification data should be within its specification of 10 %. Table 7.1 shows the target SAR and measured SAR after normalized to 1W input power. The table below indicates the system performance check can meet the variation criterion and the plots can be referred to Appendix A of this report.

Measurement Date	Frequency (MHz)	Liquid Type	Targeted SAR <sub>1g</sub> (W/kg)	Measured SAR <sub>1g</sub> (W/kg)	Normalized SAR <sub>1g</sub> (W/kg)	Deviation (%)
Nov. 19, 2012	835	Body	9.82	2.28	9.12	-7.13
Nov. 19, 2012	1900	Body	40	10.3	41.20	3.00

Table 7.1 Target and Measurement SAR after Normalized

## 8. EUT Testing Position

### 8.1 Body Worn Position

- To position the device parallel to the phantom surface with either keypad up or down.
- To adjust the device parallel to the flat phantom.
- To adjust the distance between the device surface and the flat phantom to 0 cm.

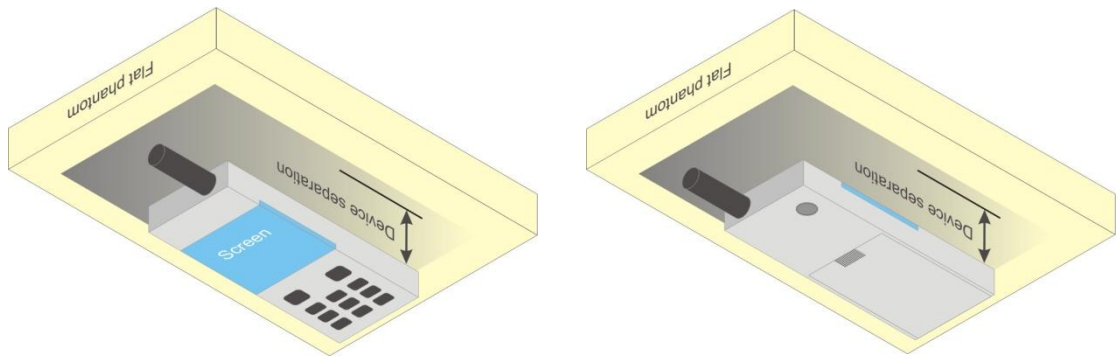

**Fig 8.1 Illustration for Body Worn Position**

#### <EUT Setup Photos>

Please refer to Appendix E for the test setup photos.



## 9. Measurement Procedures

The measurement procedures are as follows:

### <Conducted power measurement>

- (a) For WWAN power measurement, use base station simulator to configure EUT WWAN transmission in conducted connection with RF cable, at maximum power in each supported wireless interface and frequency band.
- (b) Read the WWAN RF power level from the base station simulator.
- (c) For WLAN/BT power measurement, use engineering software to configure EUT WLAN/BT continuously transmission, at maximum RF power in each supported wireless interface and frequency band
- (d) Connect EUT RF port through RF cable to the power meter, and measure WLAN/BT output power

### <SAR measurement>

- (a) Use base station simulator to configure EUT WWAN transmission in radiated connection, and engineering software to configure EUT WLAN/BT continuously transmission, at maximum RF power, in the highest power channel.
- (b) Place the EUT in the positions as Appendix E demonstrates.
- (c) Set scan area, grid size and other setting on the DASY software.
- (d) Measure SAR results for the highest power channel on each testing position.
- (e) Find out the largest SAR result on these testing positions of each band
- (f) Measure SAR results for other channels in worst SAR testing position if the SAR of highest power channel is larger than 0.8 W/kg

According to the test standard, the recommended procedure for assessing the peak spatial-average SAR value consists of the following steps:

- (a) Power reference measurement
- (b) Area scan
- (c) Zoom scan
- (d) Power drift measurement

### 9.1 Spatial Peak SAR Evaluation

The procedure for spatial peak SAR evaluation has been implemented according to the test standard. It can be conducted for 1g and 10g, as well as for user-specific masses. The DASY software includes all numerical procedures necessary to evaluate the spatial peak SAR value.

The base for the evaluation is a "cube" measurement. The measured volume must include the 1g and 10g cubes with the highest averaged SAR values. For that purpose, the center of the measured volume is aligned to the interpolated peak SAR value of a previously performed area scan.

The entire evaluation of the spatial peak values is performed within the post-processing engine (SEMCAD). The system always gives the maximum values for the 1g and 10g cubes. The algorithm to find the cube with highest averaged SAR is divided into the following stages:

- (a) Extraction of the measured data (grid and values) from the Zoom Scan
- (b) Calculation of the SAR value at every measurement point based on all stored data (A/D values and measurement parameters)
- (c) Generation of a high-resolution mesh within the measured volume
- (d) Interpolation of all measured values from the measurement grid to the high-resolution grid
- (e) Extrapolation of the entire 3-D field distribution to the phantom surface over the distance from sensor to surface
- (f) Calculation of the averaged SAR within masses of 1g and 10g



## **9.2 Area & Zoom Scan Procedures**

First Area Scan is used to locate the approximate location(s) of the local peak SAR value(s). The measurement grid within an Area Scan is defined by the grid extent, grid step size and grid offset. Next, in order to determine the EM field distribution in a three-dimensional spatial extension, Zoom Scan is required. The Zoom Scan measures 5x5x7 points with step size 8, 8 and 5 mm for 300 MHz to 3 GHz, and 8x8x8 points with step size 4, 4 and 2.5 mm for 3 GHz to 6 GHz. The Zoom Scan is performed around the highest E-field value to determine the averaged SAR-distribution over 10 g.

## **9.3 Volume Scan Procedures**

The volume scan is used for assess overlapping SAR distributions for antennas transmitting in different frequency bands. It is equivalent to an oversized zoom scan used in standalone measurements. The measurement volume will be used to enclose all the simultaneous transmitting antennas. For antennas transmitting simultaneously in different frequency bands, the volume scan is measured separately in each frequency band. In order to sum correctly to compute the 1g aggregate SAR, the EUT remain in the same test position for all measurements and all volume scan use the same spatial resolution and grid spacing (step-size is 4, 4 and 2.5 mm). When all volume scan were completed, the software, SEMCAD postprocessor can combine and subsequently superpose these measurement data to calculating the multiband SAR.

## **9.4 SAR Averaged Methods**

In DASy, the interpolation and extrapolation are both based on the modified Quadratic Shepard's method. The interpolation scheme combines a least-square fitted function method and a weighted average method which are the two basic types of computational interpolation and approximation.

Extrapolation routines are used to obtain SAR values between the lowest measurement points and the inner phantom surface. The extrapolation distance is determined by the surface detection distance and the probe sensor offset. The uncertainty increases with the extrapolation distance. To keep the uncertainty within 1% for the 1 g and 10 g cubes, the extrapolation distance should not be larger than 5 mm.

## **9.5 Power Drift Monitoring**

All SAR testing is under the EUT install full charged battery and transmit maximum output power. In DASy measurement software, the power reference measurement and power drift measurement procedures are used for monitoring the power drift of EUT during SAR test. Both these procedures measure the field at a specified reference position before and after the SAR testing. The software will calculate the field difference in dB. If the power drifts more than 5%, the SAR will be retested.

## 10. SAR Test Configurations

### 10.1 Exposure Positions Consideration

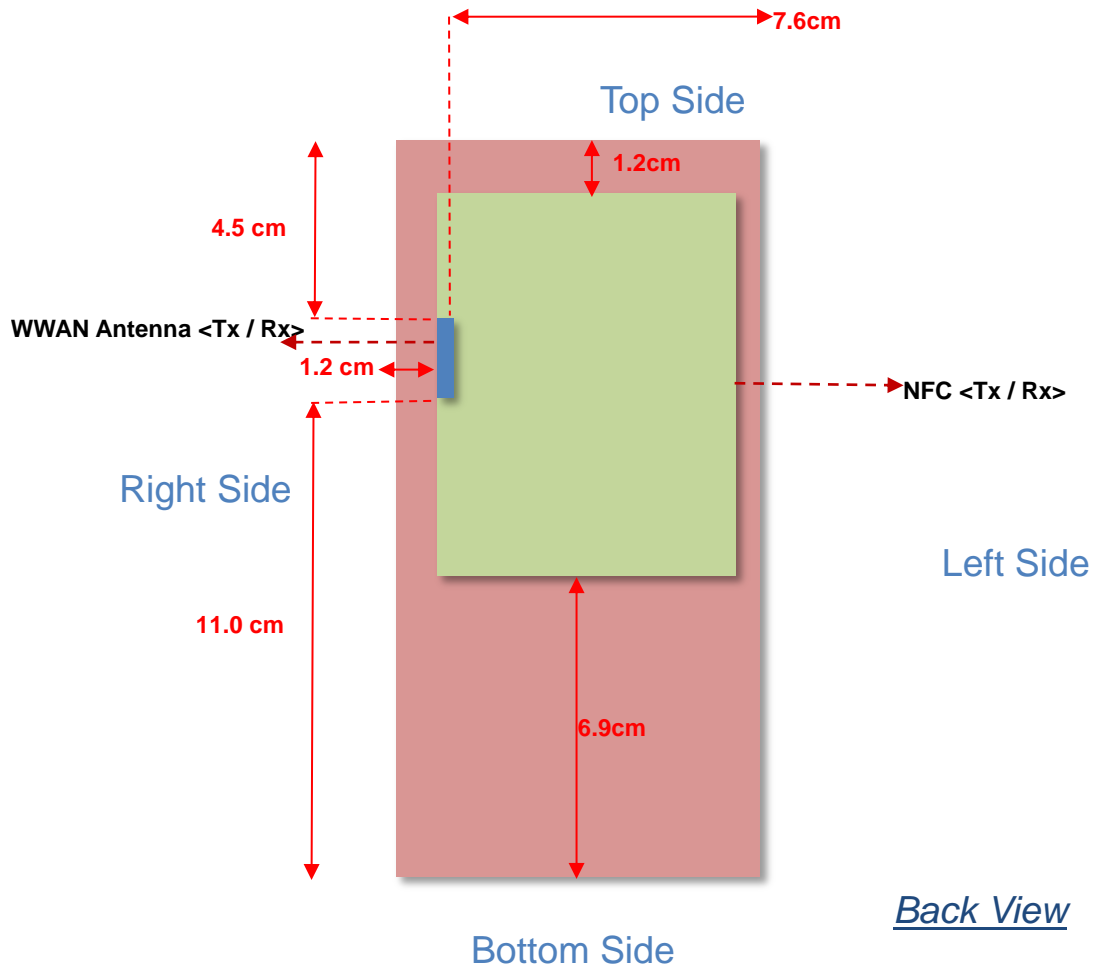

Antennas	Wireless Interface
WWAN Antenna (Tx / Rx)	GSM 850 GSM 1900 WCDMA Band V WCDMA Band II





**10.2 Conducted RF Output Power (Unit: dBm)**

**<GSM Conducted Power>**

Band: GSM850	Burst Average Power (dBm)			Frame-Average Power (dBm)		
Channel	128	189	251	128	189	251
Frequency (MHz)	824.2	836.4	848.8	824.2	836.4	848.8
GPRS (GMSK, 1 Tx slot) – CS1	32.62	32.74	32.75	23.62	23.74	23.75
GPRS (GMSK, 2 Tx slots) – CS1	29.67	29.60	29.87	23.67	23.60	23.87
EDGE (GMSK, 1 Tx slot) – MCS1	32.60	32.70	32.71	23.60	23.70	23.71
EDGE (GMSK, 2 Tx slots) – MCS1	29.51	29.62	29.81	23.51	23.62	23.81
EDGE (8PSK, 1 Tx slot) – MCS5	26.61	26.70	26.73	17.61	17.70	17.73
EDGE (8PSK, 2 Tx slots) – MCS5	23.52	23.50	23.61	17.52	17.50	17.61

**Remark:** The frame-averaged power is linearly scaled the maximum burst averaged power over 8 time slots.  
 The calculated method are shown as below:  
 Frame-averaged power = Maximum burst averaged power (1 Tx Slot) - 9 dB  
 Frame-averaged power = Maximum burst averaged power (2 Tx Slots) - 6 dB  
 Frame-averaged power = Maximum burst averaged power (3 Tx Slots) - 4.26 dB  
 Frame-averaged power = Maximum burst averaged power (4 Tx Slots) - 3 dB

**Note:**

- For Body SAR testing, GPRS and EDGE should be evaluated, therefore the EUT was set in GPRS 2 Tx slots for GSM850 due to its highest frame-average power.
- Per KDB 447498, the maximum output power channel is used for SAR testing and for further SAR test reduction.
- The EUT do not support DTM function.

Band: GSM1900	Burst Average Power (dBm)			Frame-Average Power (dBm)		
Channel	512	661	810	512	661	810
Frequency (MHz)	1850.2	1880.0	1909.8	1850.2	1880.0	1909.8
GPRS (GMSK, 1 Tx slot) – CS1	29.27	29.62	29.74	20.27	20.62	20.74
GPRS (GMSK, 2 Tx slots) – CS1	26.30	26.00	26.33	20.30	20.00	20.33
EDGE (GMSK, 1 Tx slot) – MCS1	28.66	28.44	29.20	19.66	19.44	20.20
EDGE (GMSK, 2 Tx slots) – MCS1	25.66	25.44	25.64	19.66	19.44	19.64
EDGE (8PSK, 1 Tx slot) – MCS5	25.06	24.91	25.10	16.06	15.91	16.10
EDGE (8PSK, 2 Tx slots) – MCS5	21.84	21.70	21.90	15.84	15.70	15.90

**Remark:** The frame-averaged power is linearly scaled the maximum burst averaged power over 8 time slots.  
 The calculated method are shown as below:  
 Frame-averaged power = Maximum burst averaged power (1 Tx Slot) - 9 dB  
 Frame-averaged power = Maximum burst averaged power (2 Tx Slots) - 6 dB  
 Frame-averaged power = Maximum burst averaged power (3 Tx Slots) - 4.26 dB  
 Frame-averaged power = Maximum burst averaged power (4 Tx Slots) - 3 dB

**Note:**

- For Body SAR testing, GPRS and EDGE should be evaluated, therefore the EUT was set in GPRS 1 Tx slot for GSM1900 due to its highest frame-average power.
- Per KDB 447498, the maximum output power channel is used for SAR testing and for further SAR test reduction.
- The EUT do not support DTM function.

**<WCDMA Conducted Power>**

The following tests were conducted according to the test requirements outlines in 3GPP TS 34.121 specification. A summary of these settings are illustrated below:

**HSDPA Setup Configuration:**

- a. The EUT was connected to Base Station referred to the drawing of Setup Configuration.
- b. The RF path losses were compensated into the measurements.
- c. A call was established between EUT and Base Station with following setting:
  - i. Set Gain Factors ( $\beta_c$  and  $\beta_d$ ) and parameters were set according to each
  - ii. Specific sub-test in the following table, C10.1.4, quoted from the TS 34.121
  - iii. Set RMC 12.2Kbps + HSDPA mode.
  - iv. Set Cell Power = -86 dBm
  - v. Set HS-DSCH Configuration Type to FRC (H-set 1, QPSK)
  - vi. Select HSDPA Uplink Parameters
  - vii. Set Delta ACK, Delta NACK and Delta CQI = 8
  - viii. Set Ack-Nack Repetition Factor to 3
  - ix. Set CQI Feedback Cycle (k) to 4 ms
  - x. Set CQI Repetition Factor to 2
  - xi. Power Ctrl Mode = All Up bits
- d. The transmitted maximum output power was recorded.

**Table C.10.1.4:  $\beta$  values for transmitter characteristics tests with HS-DPCCH**

Sub-test	$\beta_c$	$\beta_d$	$\beta_d$ (SF)	$\beta_c/\beta_d$	$\beta_{HS}$ (Note 1, Note 2)	CM (dB) (Note 3)	MPR (dB) (Note 3)
1	2/15	15/15	64	2/15	4/15	0.0	0.0
2	12/15 (Note 4)	15/15 (Note 4)	64	12/15 (Note 4)	24/15	1.0	0.0
3	15/15	8/15	64	15/8	30/15	1.5	0.5
4	15/15	4/15	64	15/4	30/15	1.5	0.5

Note 1:  $\Delta_{ACK}, \Delta_{NACK}$  and  $\Delta_{CQI} = 30/15$  with  $\beta_{HS} = 30/15 * \beta_c$ .

Note 2: For the HS-DPCCH power mask requirement test in clause 5.2C, 5.7A, and the Error Vector Magnitude (EVM) with HS-DPCCH test in clause 5.13.1A, and HSDPA EVM with phase discontinuity in clause 5.13.1AA,  $\Delta_{ACK}$  and  $\Delta_{NACK} = 30/15$  with  $\beta_{HS} = 30/15 * \beta_c$ , and  $\Delta_{CQI} = 24/15$  with  $\beta_{HS} = 24/15 * \beta_c$ .

Note 3: CM = 1 for  $\beta_c/\beta_d = 12/15, \beta_{HS}/\beta_c = 24/15$ . For all other combinations of DPDCH, DPCCH and HS-DPCCH the MPR is based on the relative CM difference. This is applicable for only UEs that support HSDPA in release 6 and later releases.

Note 4: For subtest 2 the  $\beta_c/\beta_d$  ratio of 12/15 for the TFC during the measurement period (TF1, TF0) is achieved by setting the signalled gain factors for the reference TFC (TF1, TF1) to  $\beta_c = 11/15$  and  $\beta_d = 15/15$ .

**Setup Configuration**

**HSUPA Setup Configuration:**

- a. The EUT was connected to Base Station referred to the drawing of Setup Configuration.
- b. The RF path losses were compensated into the measurements.
- c. A call was established between EUT and Base Station with following setting \* :
  - i. Call Configs = 5.2B, 5.9B, 5.10B, and 5.13.2B with QPSK
  - ii. Set the Gain Factors ( $\beta_c$  and  $\beta_d$ ) and parameters (AG Index) were set according to each specific sub-test in the following table, C11.1.3, quoted from the TS 34.121
  - iii. Set Cell Power = -86 dBm
  - iv. Set Channel Type = 12.2k + HSPA
  - v. Set UE Target Power
  - vi. Power Ctrl Mode= Alternating bits
  - vii. Set and observe the E-TFCl
  - viii. Confirm that E-TFCl is equal to the target E-TFCl of 75 for sub-test 1, and other subtest's E-TFCl
- d. The transmitted maximum output power was recorded.

**Table C.11.1.3:  $\beta$  values for transmitter characteristics tests with HS-DPCCH and E-DCH**

Sub-test	$\beta_c$	$\beta_d$	$\beta_d$ (SF)	$\beta_c/\beta_d$	$\beta_{HS}$ (Note 1)	$\beta_{ec}$	$\beta_{ed}$ (Note 5) (Note 6)	$\beta_{ed}$ (SF)	$\beta_{ed}$ (Codes)	CM (dB) (Note 2)	MPR (dB) (Note 2)	AG Index (Note 6)	E-TFCl
1	11/15 (Note 3)	15/15 (Note 3)	64	11/15 (Note 3)	22/15	209/225	1309/225	4	1	1.0	0.0	20	75
2	6/15	15/15	64	6/15	12/15	12/15	94/75	4	1	3.0	2.0	12	67
3	15/15	9/15	64	15/9	30/15	30/15	$\beta_{ed1}: 47/15$ $\beta_{ed2}: 47/15$	4	2	2.0	1.0	15	92
4	2/15	15/15	64	2/15	4/15	2/15	56/75	4	1	3.0	2.0	17	71
5	15/15 (Note 4)	15/15 (Note 4)	64	15/15 (Note 4)	30/15	24/15	134/15	4	1	1.0	0.0	21	81

Note 1:  $\Delta_{ACK}, \Delta_{NACK}$  and  $\Delta_{CQI} = 30/15$  with  $\beta_{hs} = 30/15 * \beta_c$ .

Note 2: CM = 1 for  $\beta_c/\beta_d = 12/15, \beta_{hs}/\beta_c = 24/15$ . For all other combinations of DPDCH, DPCCH, HS-DPCCH, E-DPDCH and E-DPCCH the MPR is based on the relative CM difference.

Note 3: For subtest 1 the  $\beta_c/\beta_d$  ratio of 11/15 for the TFC during the measurement period (TF1, TF0) is achieved by setting the signalled gain factors for the reference TFC (TF1, TF1) to  $\beta_c = 10/15$  and  $\beta_d = 15/15$ .

Note 4: For subtest 5 the  $\beta_c/\beta_d$  ratio of 15/15 for the TFC during the measurement period (TF1, TF0) is achieved by setting the signalled gain factors for the reference TFC (TF1, TF1) to  $\beta_c = 14/15$  and  $\beta_d = 15/15$ .

Note 5: In case of testing by UE using E-DPDCH Physical Layer category 1, Sub-test 3 is omitted according to TS25.306 Table 5.1g.

Note 6:  $\beta_{ed}$  can not be set directly, it is set by Absolute Grant Value.

**Setup Configuration**



WCDMA Average power (dBm)							
Band		WCDMA Band V			WCDMA Band II		
Channel		4132	4182	4233	9262	9400	9538
Frequency (MHz)		826.4	836.4	846.6	1852.4	1880.0	1907.6
3GPP Rel 99	RMC 12.2K	23.34	23.40	23.36	22.77	22.55	22.10
3GPP Rel 6	HSDPA Subtest-1	21.88	21.94	21.95	21.12	21.02	20.70
3GPP Rel 6	HSDPA Subtest-2	21.77	21.81	21.72	20.92	20.87	20.63
3GPP Rel 6	HSDPA Subtest-3	21.57	21.75	21.68	20.87	20.73	20.41
3GPP Rel 6	HSDPA Subtest-4	21.61	21.74	21.59	20.34	20.75	20.55
3GPP Rel 6	HSUPA Subtest-1	22.66	22.87	22.02	21.35	21.82	21.40
3GPP Rel 6	HSUPA Subtest-2	21.70	21.75	21.65	21.35	21.45	21.25
3GPP Rel 6	HSUPA Subtest-3	21.84	21.98	21.71	21.09	21.44	21.14
3GPP Rel 6	HSUPA Subtest-4	21.42	21.63	21.31	20.75	21.00	20.80
3GPP Rel 6	HSUPA Subtest-5	22.71	22.88	22.35	21.39	21.86	21.45

MPR (dB)								
3GPP MPR	Subtest		WCDMA Band V			WCDMA Band II		
0	3GPP Rel 6	HSDPA Subtest-1	0.00	0.00	0.00	0.00	0.00	0.00
0	3GPP Rel 6	HSDPA Subtest-2	0.11	0.13	0.23	0.20	0.15	0.07
≤ 0.5	3GPP Rel 6	HSDPA Subtest-3	0.31	0.19	0.27	0.25	0.29	0.29
≤ 0.5	3GPP Rel 6	HSDPA Subtest-4	0.27	0.20	0.36	0.78	0.27	0.15
0	3GPP Rel 6	HSUPA Subtest-1	0.05	0.01	0.33	0.04	0.04	0.05
≤ 2	3GPP Rel 6	HSUPA Subtest-2	1.01	1.13	0.70	0.04	0.41	0.20
≤ 1	3GPP Rel 6	HSUPA Subtest-3	0.87	0.90	0.64	0.30	0.42	0.31
≤ 2	3GPP Rel 6	HSUPA Subtest-4	1.29	1.25	1.04	0.64	0.86	0.65
0	3GPP Rel 6	HSUPA Subtest-5	0.00	0.00	0.00	0.00	0.00	0.00

Note:

- Applying the subtest setup in Table C.11.1.3 of 3GPP TS 34.121-1 V9.1.0 to Rel. 6 HSPA.
- For Body SAR, per KDB 941225 D01, RMC 12.2kbps setting is used to evaluate SAR. If HSDPA/HSUPA, output power is < 0.25dB higher than RMC, or SAR with RMC 12.2kbps setting is ≤ 1.2W/kg, HSDPA/HSUPA SAR evaluation can be excluded.
- By design, HSDPA/HSUPA RF power will not be larger than RMC 12.2kbps, detailed information is included in Tune-up Procure exhibit.
- It is expected by the manufacturer that MPR for some HSDPA/HSUPA, subtests may differ from the specification of 3GPP, according to the chipset implementation in this model. The implementation and expected deviation are detailed in tune-up procedure exhibit.



## 11. SAR Test Results

### 11.1 Test Records for Body-worn SAR Test

#### <GSM SAR>

Plot No.	Band	Mode	Test Position	Gap (cm)	Ch.	Freq. (MHz)	Burst Average Power (dBm)	Power Drift (dB)	SAR <sub>1g</sub> (W/kg)	Accessory
5	GSM850	GPRS (2 Tx slot)	Front	0cm	251	848.8	29.87	0.02	0.329	Battery1
6	GSM850	GPRS (2 Tx slot)	Back	0cm	251	848.8	29.87	0.02	0.538	Battery1
7	GSM850	GPRS (2 Tx slot)	Back	0cm	251	848.8	29.87	-0.08	0.532	Battery2
<b>8</b>	<b>GSM850</b>	<b>GPRS (2 Tx slot)</b>	<b>Back</b>	<b>0cm</b>	<b>251</b>	<b>848.8</b>	<b>29.87</b>	<b>0.02</b>	<b>0.564</b>	Battery3
1	GSM1900	GPRS (1 Tx slot)	Front	0cm	810	1909.8	29.74	-0.11	0.097	Battery1
2	GSM1900	GPRS (1 Tx slot)	Back	0cm	810	1909.8	29.74	-0.01	0.169	Battery1
3	GSM1900	GPRS (1 Tx slot)	Back	0cm	810	1909.8	29.74	0.04	0.169	Battery2
<b>4</b>	<b>GSM1900</b>	<b>GPRS (1 Tx slot)</b>	<b>Back</b>	<b>0cm</b>	<b>810</b>	<b>1909.8</b>	<b>29.74</b>	<b>-0.03</b>	<b>0.181</b>	Battery3

Note: Per KDB 648474 and KDB 447498, if the highest output channel SAR for each exposure position  $\leq 0.8$  W/kg other channels SAR tests are not necessary.

#### <WCDMA SAR>

Plot No.	Band	Mode	Test Position	Gap (cm)	Ch.	Freq. (MHz)	Average Power (dBm)	Power Drift (dB)	SAR <sub>1g</sub> (W/kg)	Accessory
9	WCDMA V	RMC12.2K	Front	0cm	4182	836.4	23.40	-0.04	0.252	Battery1
10	WCDMA V	RMC12.2K	Back	0cm	4182	836.4	23.40	-0.01	0.636	Battery1
11	WCDMA V	RMC12.2K	Back	0cm	4182	836.4	23.40	-0.01	0.628	Battery2
<b>12</b>	<b>WCDMA V</b>	<b>RMC12.2K</b>	<b>Back</b>	<b>0cm</b>	<b>4182</b>	<b>836.4</b>	<b>23.40</b>	<b>0.03</b>	<b>0.638</b>	Battery3
13	WCDMA II	RMC12.2K	Front	0cm	9262	1852.4	22.77	0.07	0.199	Battery1
14	WCDMA II	RMC12.2K	Back	0cm	9262	1852.4	22.77	0.05	0.258	Battery1
15	WCDMA II	RMC12.2K	Back	0cm	9262	1852.4	22.77	-0.02	0.264	Battery2
<b>16</b>	<b>WCDMA II</b>	<b>RMC12.2K</b>	<b>Back</b>	<b>0cm</b>	<b>9262</b>	<b>1852.4</b>	<b>22.77</b>	<b>0.08</b>	<b>0.295</b>	Battery3

Note: Per KDB 648474 and KDB 447498, if the highest output channel SAR for each exposure position  $\leq 0.8$  W/kg other channels SAR tests are not necessary.

Test Engineer : Aaron Chen and Ted Sun

## 12. Uncertainty Assessment

The component of uncertainty may generally be categorized according to the methods used to evaluate them. The evaluation of uncertainty by the statistical analysis of a series of observations is termed a Type A evaluation of uncertainty. The evaluation of uncertainty by means other than the statistical analysis of a series of observations is termed a Type B evaluation of uncertainty. Each component of uncertainty, however evaluated, is represented by an estimated standard deviation, termed standard uncertainty, which is determined by the positive square root of the estimated variance.

A Type A evaluation of standard uncertainty may be based on any valid statistical method for treating data. This includes calculating the standard deviation of the mean of a series of independent observations; using the method of least squares to fit a curve to the data in order to estimate the parameter of the curve and their standard deviations; or carrying out an analysis of variance in order to identify and quantify random effects in certain kinds of measurement.

A type B evaluation of standard uncertainty is typically based on scientific judgment using all of the relevant information available. These may include previous measurement data, experience, and knowledge of the behavior and properties of relevant materials and instruments, manufacture’s specification, data provided in calibration reports and uncertainties assigned to reference data taken from handbooks. Broadly speaking, the uncertainty is either obtained from an outdoor source or obtained from an assumed distribution, such as the normal distribution, rectangular or triangular distributions indicated in Table 12.1

Uncertainty Distributions	Normal	Rectangular	Triangular	U-Shape
Multi-plying Factor <sup>(a)</sup>	1/k <sup>(b)</sup>	1/√3	1/√6	1/√2

(a) standard uncertainty is determined as the product of the multiplying factor and the estimated range of variations in the measured quantity

(b)  $\kappa$  is the coverage factor

**Table 12.1 Standard Uncertainty for Assumed Distribution**

The combined standard uncertainty of the measurement result represents the estimated standard deviation of the result. It is obtained by combining the individual standard uncertainties of both Type A and Type B evaluation using the usual “root-sum-squares” (RSS) methods of combining standard deviations by taking the positive square root of the estimated variances.

Expanded uncertainty is a measure of uncertainty that defines an interval about the measurement result within which the measured value is confidently believed to lie. It is obtained by multiplying the combined standard uncertainty by a coverage factor. Typically, the coverage factor ranges from 2 to 3. Using a coverage factor allows the true value of a measured quantity to be specified with a defined probability within the specified uncertainty range. For purpose of this document, a coverage factor two is used, which corresponds to confidence interval of about 95 %. The DASY uncertainty Budget is shown in the following tables.



Error Description	Uncertainty Value (±%)	Probability Distribution	Divisor	Ci (1g)	Ci (10g)	Standard Uncertainty (1g)	Standard Uncertainty (10g)
<b>Measurement System</b>							
Probe Calibration	6.0	Normal	1	1	1	± 6.0 %	± 6.0 %
Axial Isotropy	4.7	Rectangular	√3	0.7	0.7	± 1.9 %	± 1.9 %
Hemispherical Isotropy	9.6	Rectangular	√3	0.7	0.7	± 3.9 %	± 3.9 %
Boundary Effects	1.0	Rectangular	√3	1	1	± 0.6 %	± 0.6 %
Linearity	4.7	Rectangular	√3	1	1	± 2.7 %	± 2.7 %
System Detection Limits	1.0	Rectangular	√3	1	1	± 0.6 %	± 0.6 %
Readout Electronics	0.3	Normal	1	1	1	± 0.3 %	± 0.3 %
Response Time	0.8	Rectangular	√3	1	1	± 0.5 %	± 0.5 %
Integration Time	2.6	Rectangular	√3	1	1	± 1.5 %	± 1.5 %
RF Ambient Noise	3.0	Rectangular	√3	1	1	± 1.7 %	± 1.7 %
RF Ambient Reflections	3.0	Rectangular	√3	1	1	± 1.7 %	± 1.7 %
Probe Positioner	0.4	Rectangular	√3	1	1	± 0.2 %	± 0.2 %
Probe Positioning	2.9	Rectangular	√3	1	1	± 1.7 %	± 1.7 %
Max. SAR Eval.	1.0	Rectangular	√3	1	1	± 0.6 %	± 0.6 %
<b>Test Sample Related</b>							
Device Positioning	2.9	Normal	1	1	1	± 2.9 %	± 2.9 %
Device Holder	3.6	Normal	1	1	1	± 3.6 %	± 3.6 %
Power Drift	5.0	Rectangular	√3	1	1	± 2.9 %	± 2.9 %
<b>Phantom and Setup</b>							
Phantom Uncertainty	4.0	Rectangular	√3	1	1	± 2.3 %	± 2.3 %
Liquid Conductivity (Target)	5.0	Rectangular	√3	0.64	0.43	± 1.8 %	± 1.2 %
Liquid Conductivity (Meas.)	2.5	Normal	1	0.64	0.43	± 1.6 %	± 1.1 %
Liquid Permittivity (Target)	5.0	Rectangular	√3	0.6	0.49	± 1.7 %	± 1.4 %
Liquid Permittivity (Meas.)	2.5	Normal	1	0.6	0.49	± 1.5 %	± 1.2 %
<b>Combined Standard Uncertainty</b>						± 11.0 %	± 10.8 %
<b>Coverage Factor for 95 %</b>						K=2	
<b>Expanded Uncertainty</b>						± 22.0 %	± 21.5 %

Table 12.2 Uncertainty Budget of DASY for frequency range 300 MHz to 3 GHz





### **13. References**

- [1] FCC 47 CFR Part 2 "Frequency Allocations and Radio Treaty Matters; General Rules and Regulations"
- [2] ANSI/IEEE Std. C95.1-1992, "IEEE Standard for Safety Levels with Respect to Human Exposure to Radio Frequency Electromagnetic Fields, 3 kHz to 300 GHz", September 1992
- [3] IEEE Std. 1528-2003, "Recommended Practice for Determining the Peak Spatial-Average Specific Absorption Rate (SAR) in the Human Head from Wireless Communications Devices: Measurement Techniques", December 2003
- [4] FCC OET Bulletin 65 (Edition 97-01) Supplement C (Edition 01-01), "Evaluating Compliance with FCC Guidelines for Human Exposure to Radiofrequency Electromagnetic Fields", June 2001
- [5] SPEAG DASY System Handbook
- [6] FCC KDB 447498 D01 v04, "Mobile and Portable Device RF Exposure Procedures and Equipment Authorization Policies", November 2009
- [7] FCC KDB 648474 D01 v01r05, "SAR Evaluation Considerations for Handsets with Multiple Transmitters and Antennas", September 2008
- [8] FCC KDB 941225 D01 v02, "SAR Measurement Procedures for 3G Devices – CDMA 2000 / Ev-Do / WCDMA / HSDPA / HSPA", October 2007
- [9] FCC KDB 941225 D03 v01, "Recommended SAR Test Reduction Procedures for GSM / GPRS / EDGE", December 2008
- [10] FCC KDB 941225 D06 v01, "SAR Evaluation Procedures for Portable Devices with Wireless Router Capabilities", April 2011





## ***Appendix A. Plots of System Performance Check***

The plots are shown as follows.



## ***Appendix B. Plots of SAR Measurement***

The plots are shown as follows.



## **Appendix C. DASYS Calibration Certificate**

The DASYS calibration certificates are shown as follows.