



# FCC TEST REPORT (RFID)

**REPORT NO.:** RF131104C19-2  
**MODEL NO.:** VX675 WIFI-BT  
**FCC ID:** B32VX675WIFIBT  
**RECEIVED:** Nov. 04, 2013  
**TESTED:** Nov. 12, 2013 ~ Nov. 25, 2013  
**ISSUED:** Nov. 28, 2013

**APPLICANT:** VeriFone, Inc.

**ADDRESS:** 1400 West Stanford Ranch Road Suite 200  
Rocklin CA 95765 USA

**ISSUED BY:** Bureau Veritas Consumer Products Services  
(H.K.) Ltd., Taoyuan Branch

**LAB ADDRESS:** No. 47, 14th Ling, Chia Pau Vil., Lin Kou Dist.,  
New Taipei City, Taiwan, R.O.C.

**TEST LOCATION:** No. 19, Hwa Ya 2nd Rd, Wen Hwa Tsuen, Kwei  
Shan Hsiang, Taoyuan Hsien 333, Taiwan, R.O.C.

This report should not be used by the client to claim product certification, approval, or endorsement by TAF or any government agencies.



This report is for your exclusive use. Any copying or replication of this report to or for any other person or entity, or use of our name or trademark, is permitted only with our prior written permission. This report sets forth our findings solely with respect to the test samples identified herein. The results set forth in this report are not indicative or representative of the quality or characteristics of the lot from which a test sample was taken or any similar or identical product unless specifically and expressly noted. Our report includes all of the tests requested by you and the results thereof based upon the information that you provided to us. You have 60 days from date of issuance of this report to notify us of any material error or omission caused by our negligence, provided, however, that such notice shall be in writing and shall specifically address the issue you wish to raise. A failure to raise such issue within the prescribed time shall constitute your unqualified acceptance of the completeness of this report, the tests conducted and the correctness of the report contents. Unless specific mention, the uncertainty of measurement has been explicitly taken into account to declare the compliance or non-compliance to the specification.



# Table of Contents

RELEASE CONTROL RECORD.....	4
1. CERTIFICATION.....	5
2. SUMMARY OF TEST RESULTS.....	6
2.1 MEASUREMENT UNCERTAINTY.....	6
3. GENERAL INFORMATION.....	7
3.1 GENERAL DESCRIPTION OF EUT.....	7
3.2 DESCRIPTION OF TEST MODES.....	8
3.2.1 TEST MODE APPLICABILITY AND TESTED CHANNEL DETAIL.....	8
3.3 DESCRIPTION OF SUPPORT UNITS.....	9
3.3.1 CONFIGURATION OF SYSTEM UNDER TEST.....	9
3.4 GENERAL DESCRIPTION OF APPLIED STANDARDS.....	10
4. TEST TYPES AND RESULTS.....	11
4.1 Radiated Emission Measurement.....	11
4.1.1 LIMITS OF RADIATED EMISSION MEASUREMENT.....	11
4.1.2 TEST INSTRUMENTS.....	12
4.1.3 TEST PROCEDURES.....	13
4.1.4 DEVIATION FROM TEST STANDARD.....	13
4.1.5 TEST SETUP.....	14
4.1.6 EUT OPERATING CONDITIONS.....	14
4.1.7 TEST RESULTS.....	15
4.2 CONDUCTED EMISSION MEASUREMENT.....	23
4.2.1 LIMITS OF CONDUCTED EMISSION MEASUREMENT.....	23
4.2.2 TEST INSTRUMENTS.....	23
4.2.3 TEST PROCEDURES.....	24
4.2.4 DEVIATION FROM TEST STANDARD.....	24
4.2.5 TEST SETUP.....	24
4.2.6 EUT OPERATING CONDITIONS.....	24
4.2.7 TEST RESULTS.....	25
4.3 FREQUENCY STABILITY.....	29
4.3.1 LIMITS OF FREQUENCY STABILITY MEASUREMENT.....	29
4.3.2 TEST INSTRUMENTS.....	29
4.3.3 TEST PROCEDURE.....	29
4.3.4 DEVIATION FROM TEST STANDARD.....	30
4.3.5 TEST SETUP.....	30
4.3.6 EUT OPERATING CONDITION.....	30
4.3.7 TEST RESULTS.....	31
4.4 20dB bandwidth.....	32
4.4.1 LIMITS OF 20dB BANDWIDTH MEASUREMENT.....	32
4.4.2 TEST INSTRUMENTS.....	32
4.4.3 TEST PROCEDURE.....	32
4.4.4 DEVIATION FROM TEST STANDARD.....	32
4.4.5 TEST SETUP.....	32
4.4.6 EUT OPERATING CONDITION.....	32



A D T

4.4.7	TEST RESULTS .....	33
5.	PHOTOGRAPHS OF THE TEST CONFIGURATION.....	34
6.	INFORMATION ON THE TESTING LABORATORIES .....	35
7.	APPENDIX A - MODIFICATIONS RECORDERS FOR ENGINEERING CHANGES TO THE EUT BY THE LAB .....	36



## RELEASE CONTROL RECORD

ISSUE NO.	REASON FOR CHANGE	DATE ISSUED
RF131104C19-2	Original release	Nov. 28, 2013



A D T

## 1. CERTIFICATION

**PRODUCT:** Point of Sale Terminal

**MODEL:** VX675 WIFI-BT

**BRAND:** VeriFone

**APPLICANT:** VeriFone, Inc.

**TESTED:** Nov. 12, 2013 ~ Nov. 25, 2013

**TEST SAMPLE:** Identical Prototype

**STANDARDS:** **FCC Part 15, Subpart C (Section 15.225)**

**FCC Part 15, Subpart C (Section 15.215)**

ANSI C63.10-2009

The above equipment (model: VX675 WIFI-BT) has been tested by **Bureau Veritas Consumer Products Services (H.K.) Ltd., Taoyuan Branch**. The test record, data evaluation & Equipment Under Test (EUT) configurations represented herein are true and accurate accounts of the measurements of the sample's EMC characteristics under the conditions specified in this report.

**PREPARED BY :** Evonne Liu , **DATE :** Nov. 28, 2013  
Evonne Liu / Specialist

**APPROVED BY :** Sam Chen , **DATE :** Nov. 28, 2013  
Sam Chen / Assistant Manager

## 2. SUMMARY OF TEST RESULTS

The EUT has been tested according to the following specifications:

APPLIED STANDARD: FCC PART 15, SUBPART C (SECTION 15.225, 15.215)			
STANDARD SECTION	TEST TYPE AND LIMIT	RESULT	REMARK
15.207	Conducted emission test	PASS	Meet the requirement of limit. Minimum passing margin is -13.40dB at 0.41563MHz.
15.225 (a)	The field strength of any emissions within the band 13.553-13.567 MHz	PASS	Meet the requirement of limit. Minimum passing margin is -45.83dB at 13.56MHz.
15.225 (d)	The field strength of any emissions appearing outside of the 13.110-14.010 MHz band	PASS	Meet the requirement of limit. Minimum passing margin is -5.91dB at 32.43MHz.
15.225 (e)	The frequency tolerance	PASS	Meet the requirement of limit.
15.215 (c)	20dB Bandwidth	PASS	Meet the requirement of limit.

### 2.1 MEASUREMENT UNCERTAINTY

Where relevant, the following measurement uncertainty levels have been estimated for tests performed on the EUT as specified in CISPR 16-4-2:

MEASUREMENT	FREQUENCY	UNCERTAINTY
Conducted Emission	150kHz ~ 30MHz	2.44 dB
Radiated emissions	30MHz ~ 200MHz	3.34 dB
	200MHz ~1000MHz	3.35 dB

This uncertainty represents an expanded uncertainty expressed at approximately the 95% confidence level using a coverage factor of k=2.



### 3. GENERAL INFORMATION

#### 3.1 GENERAL DESCRIPTION OF EUT

<b>EUT</b>	Point of Sale Terminal
<b>MODEL NO.</b>	VX675 WIFI-BT
<b>POWER SUPPLY</b>	5Vdc (adapter) 3.6Vdc (battery)
<b>MODULATION TYPE</b>	ASK
<b>OPERATING FREQUENCY</b>	13.56MHz
<b>ANTENNA TYPE</b>	Integrate Antenna
<b>DATA CABLE</b>	Refer to Note
<b>I/O PORTS</b>	Refer to user's manual
<b>ACCESSORY DEVICES</b>	Refer to Note

**NOTE:**

1. The EUT has following accessories.

ITEM	BRAND	MODEL	DESCRIPTION
Adapter 1	VeriFone	SC1402	I/P: 100-240Vac, 50-60Hz, 150mA O/P: 5Vdc, 1A
Adapter 2	VeriFone	MU06-E050100-A1	I/P: 100-240Vac, 50/60Hz, 0.2A O/P: 5Vdc, 1A
Battery	VeriFone	BPK265-001	Rating : 3.6V, 2200mAh
WLAN/BT Module 1	Ampak	GB86321D	with diversity
WLAN/BT Module 2	Ampak	GB86321G	w/o diversity

\*\* The EUT was tested with WLAN/BT Module 2.

2. The above EUT information is declared by the manufacturer and for more detailed features description, please refer to the manufacturer's specifications or User's Manual.

### 3.2 DESCRIPTION OF TEST MODES

#### 3.2.1 TEST MODE APPLICABILITY AND TESTED CHANNEL DETAIL

EUT CONFIGURE MODE	APPLICABLE TO				DESCRIPTION
	RE	PLC	FS	BW	
A	-	√	-	-	Adapter 1
B	√	√	√	√	Adapter 2

Where **RE:** Radiated Emission      **PLC:** Power Line Conducted Emission  
**FS:** Frequency Stability      **BW:** 20dB Bandwidth

**NOTE:**  
The EUT had been pre-tested on the positioned of each 3 axis. The worst case was found when positioned on Z-plane.

#### RADIATED EMISSION TEST:

- Pre-Scan has been conducted to determine the worst-case mode from all possible combinations between available modulations antenna ports (if EUT with antenna diversity architecture).
- Following channel(s) was (were) selected for the final test as listed below.

EUT CONFIGURE MODE	AVAILABLE CHANNEL	TESTED CHANNEL	MODULATION TYPE
A	1	1	ASK
B	1	1	ASK

#### POWER LINE CONDUCTED EMISSION TEST:

- Pre-Scan has been conducted to determine the worst-case mode from all possible combinations between available modulations antenna ports (if EUT with antenna diversity architecture).
- Following channel(s) was (were) selected for the final test as listed below.

EUT CONFIGURE MODE	AVAILABLE CHANNEL	TESTED CHANNEL	MODULATION TYPE
A	1	1	ASK
B	1	1	ASK

#### FREQUENCY STABILITY:

- Pre-Scan has been conducted to determine the worst-case mode from all possible combinations between available modulations and antenna ports (if EUT with antenna diversity architecture).
- Following channel(s) was (were) selected for the final test as listed below.

EUT CONFIGURE MODE	AVAILABLE CHANNEL	TESTED CHANNEL	MODULATION TYPE
B	1	1	ASK



**20dB BANDWIDTH:**

- Pre-Scan has been conducted to determine the worst-case mode from all possible combinations between available modulations, antenna ports (if EUT with antenna diversity architecture).
- Following channel(s) was (were) selected for the final test as listed below.

EUT CONFIGURE MODE	AVAILABLE CHANNEL	TESTED CHANNEL	MODULATION TYPE
B	1	1	ASK

**TEST CONDITION:**

APPLICABLE TO	ENVIRONMENTAL CONDITIONS	INPUT POWER	TESTED BY
RE	25deg. C, 65%RH	120Vac, 60Hz	David Huang / Anson Lin
FS	25deg. C, 65%RH	120Vac, 60Hz	Howard Kao
PLC	25deg. C, 65%RH	120Vac, 60Hz	Johnson Liao
BW	25deg. C, 65%RH	120Vac, 60Hz	Howard Kao

**3.3 DESCRIPTION OF SUPPORT UNITS**

The EUT has been tested as an independent unit together with other necessary accessories or support units.

**3.3.1 CONFIGURATION OF SYSTEM UNDER TEST**

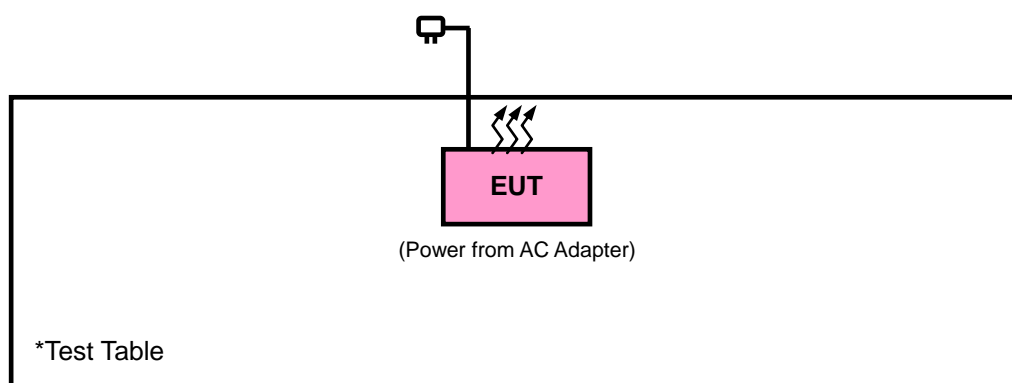

### **3.4 GENERAL DESCRIPTION OF APPLIED STANDARDS**

The EUT is a RFID Product. According to the specifications of the manufacturer, it must comply with the requirements of the following standards:

**FCC Part 15, Subpart C (15.225)**

**FCC Part 15, Subpart C (15.215)**

**ANSI C63.10-2009**

All test items have been performed and recorded as per the above standards.

**NOTE:** The EUT is also considered as a kind of computer peripheral, because the connection to computer is necessary for typical use. It has been verified to comply with the requirements of FCC Part 15, Subpart B, Class B. The test report has been issued separately.

## 4. TEST TYPES AND RESULTS

### 4.1 RADIATED EMISSION MEASUREMENT

#### 4.1.1 LIMITS OF RADIATED EMISSION MEASUREMENT

The field strength of any emissions within the band 13.553-13.567 MHz shall not exceed 15,848 microvolts/meter at 30 meters.

The field strength of any emissions appearing outside of the 13.110-14.010 MHz band shall not exceed the general radiated emission limits in § 15.209.

FREQUENCIES (MHz)	FIELD STRENGTH (microvolts/meter)	MEASUREMENT DISTANCE (meters)
0.009 ~ 0.490	2400/F(kHz)	300
0.490 ~ 1.705	24000/F(kHz)	30
1.705 ~ 30.0	30	30
30 ~ 88	100	3
88 ~ 216	150	3
216 ~ 960	200	3
Above 960	500	3

**NOTE:**

1. The lower limit shall apply at the transition frequencies.
2. Emission level (dBuV/m) = 20 log Emission level (uV/m).
3. As shown in 15.35(b), for frequencies above 1000MHz, the field strength limits are based on average detector, however, the peak field strength of any emission shall not exceed the maximum permitted average limits, specified above by more than 20dB under any condition of modulation.



#### 4.1.2 TEST INSTRUMENTS

DESCRIPTION & MANUFACTURER	MODEL NO.	SERIAL NO.	DATE OF CALIBRATION	DUE DATE OF CALIBRATION
Test Receiver ROHDE & SCHWARZ	ESCI	100744	Apr. 15, 2013	Apr. 14, 2014
Spectrum Analyzer ROHDE & SCHWARZ	FSU43	101261	Dec. 17, 2012	Dec. 16, 2013
BILOG Antenna SCHWARZBECK	VULB9168	9168-472	Mar. 25, 2013	Mar. 24, 2014
HORN Antenna SCHWARZBECK	BBHA 9120 D	9120D-969	Jan. 07, 2013	Jan. 06, 2014
Preamplifier EMCI	EMC 012645	980115	Dec. 28, 2012	Dec. 27, 2013
Preamplifier EMCI	EMC 184045	980116	Dec. 28, 2012	Dec. 27, 2013
Preamplifier EMCI	EMC 330H	980112	Dec. 28, 2012	Dec. 27, 2013
RF signal cable HUBER+SUHNNER	SUCOFLEX 104	309219/4	Oct. 18, 2013	Oct. 17, 2014
RF signal cable HUBER+SUHNNER	SUCOFLEX 104	250130/4	Oct. 18, 2013	Oct. 17, 2014
RF signal cable Worken	RG-213	NA	Dec. 29, 2012	Dec. 28, 2013
Software BV ADT	E3 6.120103	NA	NA	NA
Antenna Tower MF	MFA-440H	NA	NA	NA
Turn Table MF	MFT-201SS	NA	NA	NA
Antenna Tower & Turn Table Controller MF	MF-7802	NA	NA	NA

- NOTE:**
1. The calibration interval of the above test instruments is 12 months and the calibrations are traceable to NML/ROC and NIST/USA.
  2. The calibration interval of the loop antenna is 24 months and the calibrations are traceable to NML/ROC and NIST/USA.
  3. The test was performed in HwaYa Chamber 10.
  4. The FCC Site Registration No. is 690701.
  5. The IC Site Registration No. is IC 7450F-10.

#### 4.1.3 TEST PROCEDURES

- a. The EUT was placed on the top of a rotating table 0.8 meters above the ground at a 3 meter semi-anechoic chamber. The table was rotated 360 degrees to determine the position of the highest radiation.
- b. The EUT was set 3 meters away from the interference-receiving antenna, which was mounted on the top of a variable-height antenna tower.
- c. The antenna is a broadband antenna, and its height is varied from one meter to four meters above the ground to determine the maximum value of the field strength. Both horizontal and vertical polarizations of the antenna are set to make the measurement.
- d. For each suspected emission, the EUT was arranged to its worst case and then the antenna was tuned to heights from 1 meter to 4 meters and the rotatable table was turned from 0 degrees to 360 degrees to find the maximum reading.
- e. The test-receiver system was set to Peak Detect Function and Specified Bandwidth with Maximum Hold Mode.
- f. If the emission level of the EUT in peak mode was lower than the limit specified, then testing could be stopped and the peak values of the EUT would be reported. Otherwise the emissions would be re-tested one by one using peak, quasi-peak or average method as specified and then reported in a data sheet.

**NOTE:**

1. The resolution bandwidth and video bandwidth of test receiver/spectrum analyzer is 120kHz for Quasi-peak detection at frequency below 1GHz.
2. The resolution bandwidth of test receiver/spectrum analyzer is 1 MHz and video bandwidth is 3MHz for Peak detection at frequency above 1GHz.
3. All modes of operation were investigated and the worst-case emissions are reported.

#### 4.1.4 DEVIATION FROM TEST STANDARD

No deviation.

#### 4.1.5 TEST SETUP

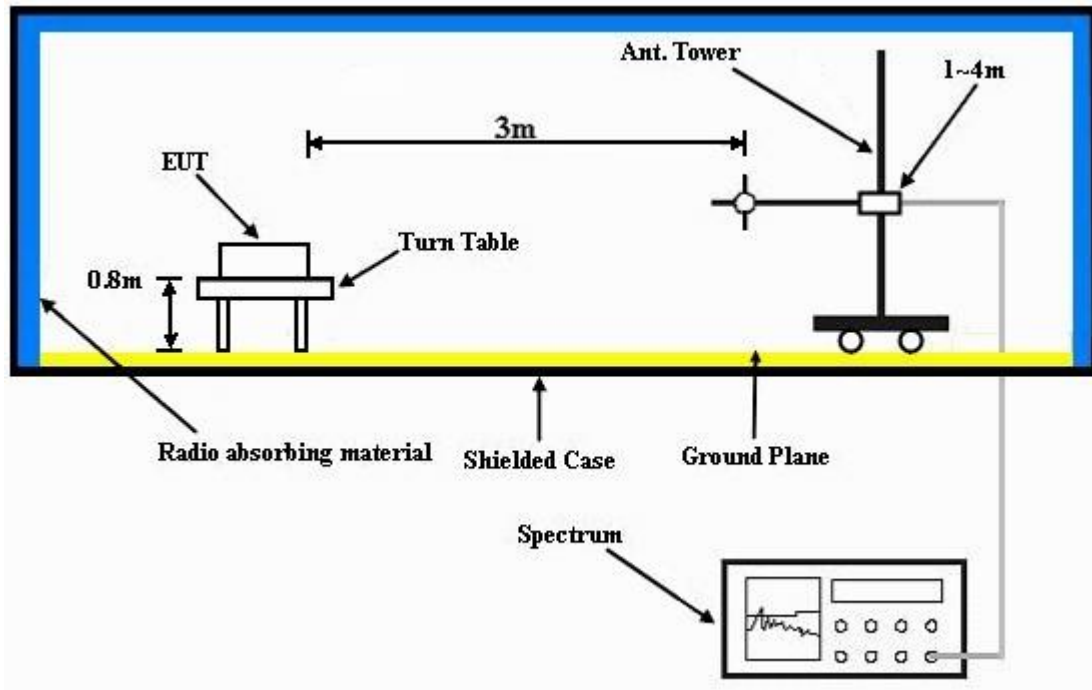

For the actual test configuration, please refer to the attached file (Test Setup Photo).

#### 4.1.6 EUT OPERATING CONDITIONS

Set the EUT under transmission condition continuously at specific channel frequency.

### 4.1.7 TEST RESULTS

EUT TEST CONDITION		MEASUREMENT DETAIL	
CHANNEL	Channel 1	FREQUENCY RANGE	13.553 ~ 13.567MHz
INPUT POWER	120Vac, 60Hz	DETECTOR FUNCTION	Peak (PK)
ENVIRONMENTAL CONDITIONS	25deg. C, 65%RH	TESTED BY	David Huang

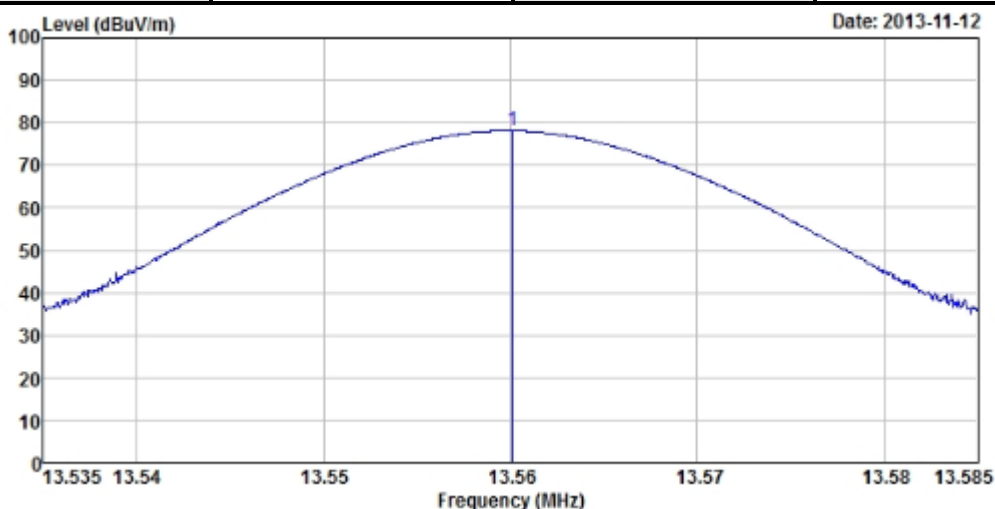

ANTENNA POLARITY & TEST DISTANCE: LOOP ANTENNA OPEN AT 3M								
FREQ. (MHz)	EMISSION LEVEL (dBuV/m)	READ LEVEL (dBuV)	LIMIT (dBuV/m)	MARGIN (dB)	Correction Factor (dB/m)	ANTENNA HEIGHT (cm)	TABLE ANGLE (Degree)	REMARK
13.56	78.17	58.19	124	-45.83	19.98	100	360	Peak

- REMARKS:**
1. Emission level(dBuV/m)= Read Level (dBuV) + Correction Factor(dB/m)
  2. Correction Factor(dB/m) = Antenna Factor (dB/m) + Cable Factor (dB)
  3. The other emission levels were very low against the limit.
  4. Margin value = Emission level – Limit value.
  5. Above limits have been translated by the formula

The measured field strength was extrapolated to distance 30 meters, using the formula that the limit of field strength varies as the inverse distance square (40dB per decade of distance)

Example:

$$\begin{aligned}
 13.56\text{MHz} &= 15848\mu\text{V/m} && 30\text{m} \\
 &= 84\text{dBuV/m} && 30\text{m} \\
 &= 84+20\log(30/3)^2 && 3\text{m} \\
 &= 124\text{dBuV/m}
 \end{aligned}$$



A D T

EUT TEST CONDITION		MEASUREMENT DETAIL	
CHANNEL	Channel 1	FREQUENCY RANGE	13.553 ~ 13.567MHz
INPUT POWER	120Vac, 60Hz	DETECTOR FUNCTION	Peak (PK)
ENVIRONMENTAL CONDITIONS	25deg. C, 65%RH	TESTED BY	David Huang

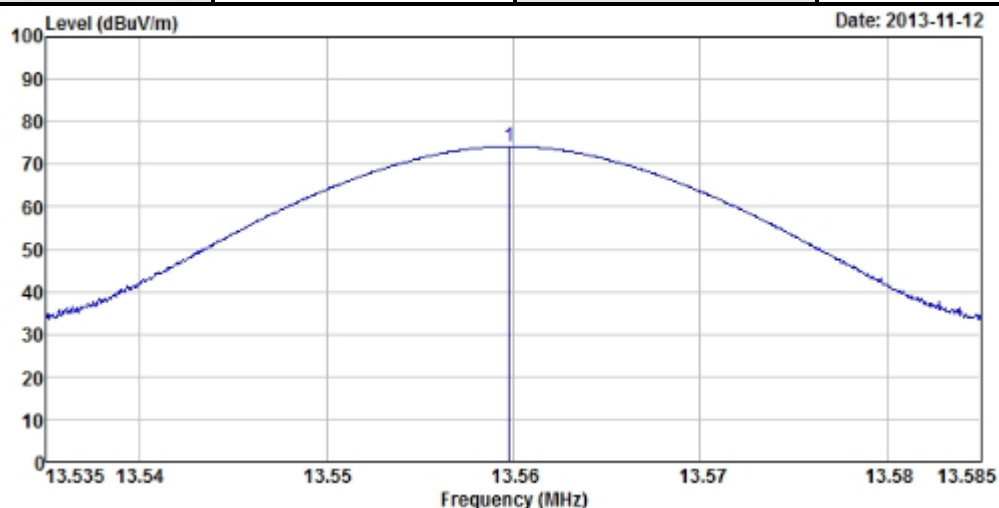

ANTENNA POLARITY & TEST DISTANCE: LOOP ANTENNA CLOSE AT 3M								
FREQ. (MHz)	EMISSION LEVEL (dBuV/m)	READ LEVEL (dBuV)	LIMIT (dBuV/m)	MARGIN (dB)	Correction Factor (dB/m)	ANTENNA HEIGHT (cm)	TABLE ANGLE (Degree)	REMARK
13.56	74.27	54.29	124	-49.73	19.98	100	93	Peak

- REMARKS:**
1. Emission level(dBuV/m)= Read Level (dBuV) + Correction Factor(dB/m)
  2. Correction Factor(dB/m) = Antenna Factor (dB/m) + Cable Factor (dB)
  3. The other emission levels were very low against the limit.
  4. Margin value = Emission level – Limit value.
  5. Above limits have been translated by the formula

The measured field strength was extrapolated to distance 30 meters, using the formula that the limit of field strength varies as the inverse distance square (40dB per decade of distance)

Example:

$$\begin{aligned}
 13.56\text{MHz} &= 15848\mu\text{V/m} && 30\text{m} \\
 &= 84\text{dBuV/m} && 30\text{m} \\
 &= 84+20\log(30/3)^2 && 3\text{m} \\
 &= 124\text{dBuV/m}
 \end{aligned}$$





A D T

EUT TEST CONDITION		MEASUREMENT DETAIL	
CHANNEL	Channel 1	FREQUENCY RANGE	Below 30MHz
INPUT POWER	120Vac, 60Hz	DETECTOR FUNCTION	Peak (PK)
ENVIRONMENTAL CONDITIONS	25deg. C, 65%RH	TESTED BY	David Huang

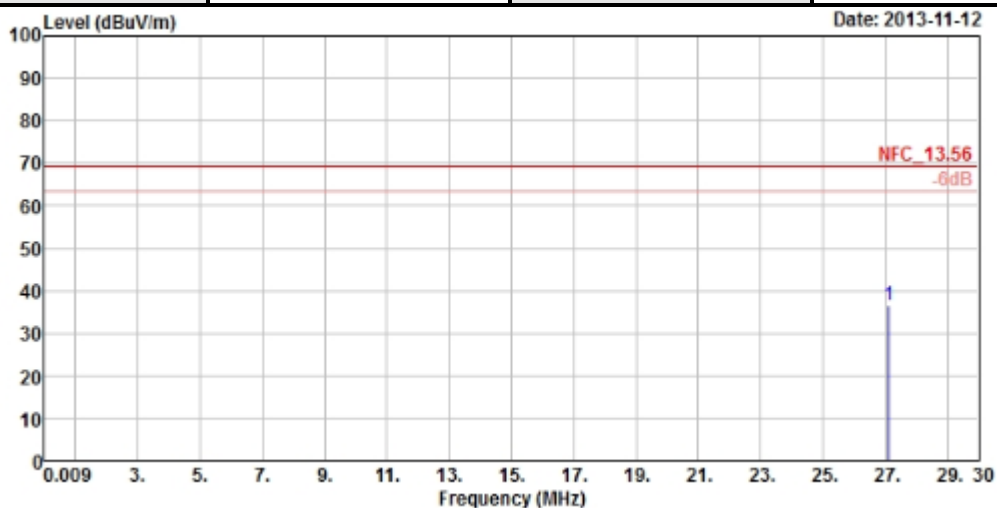

ANTENNA POLARITY & TEST DISTANCE: LOOP ANTENNA OPEN AT 3M								
FREQ. (MHz)	EMISSION LEVEL (dBuV/m)	READ LEVEL (dBuV)	LIMIT (dBuV/m)	MARGIN (dB)	Correction Factor (dB/m)	ANTENNA HEIGHT (cm)	TABLE ANGLE (Degree)	REMARK
27.121	36.64	16.33	69.54	-32.9	20.31	100	0	Peak

- REMARKS:**
1. Emission level(dBuV/m)= Read Level (dBuV) + Correction Factor(dB/m)
  2. Correction Factor(dB/m) = Antenna Factor (dB/m) + Cable Factor (dB)
  3. The other emission levels were very low against the limit.
  4. Margin value = Emission level – Limit value.



A D T

EUT TEST CONDITION		MEASUREMENT DETAIL	
CHANNEL	Channel 1	FREQUENCY RANGE	Below 30MHz
INPUT POWER	120Vac, 60Hz	DETECTOR FUNCTION	Peak (PK)
ENVIRONMENTAL CONDITIONS	25deg. C, 65%RH	TESTED BY	David Huang

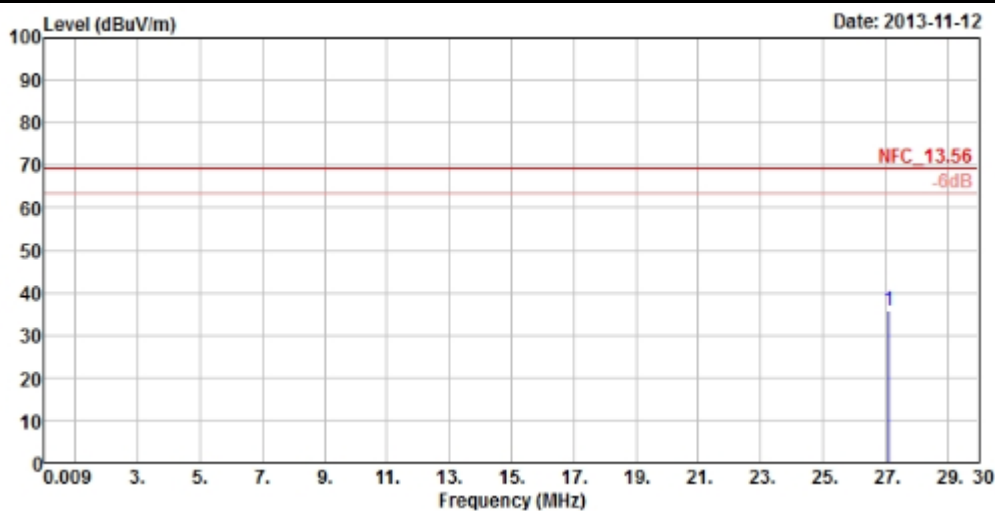

ANTENNA POLARITY & TEST DISTANCE: LOOP ANTENNA CLOSE AT 3M								
FREQ. (MHz)	EMISSION LEVEL (dBuV/m)	READ LEVEL (dBuV)	LIMIT (dBuV/m)	MARGIN (dB)	Correction Factor (dB/m)	ANTENNA HEIGHT (cm)	TABLE ANGLE (Degree)	REMARK
27.121	35.66	15.35	69.54	-33.88	20.31	100	360	Peak

- REMARKS:**
1. Emission level(dBuV/m)= Read Level (dBuV) + Correction Factor(dB/m)
  2. Correction Factor(dB/m) = Antenna Factor (dB/m) + Cable Factor (dB)
  3. The other emission levels were very low against the limit.
  4. Margin value = Emission level – Limit value.

**MODE A**

EUT TEST CONDITION		MEASUREMENT DETAIL	
CHANNEL	Channel 1	FREQUENCY RANGE	30MHz ~ 1GHz
INPUT POWER	120Vac, 60 Hz	DETECTOR FUNCTION	Peak (PK)
ENVIRONMENTAL CONDITIONS	25deg. C, 65%RH	TESTED BY	Anson Lin

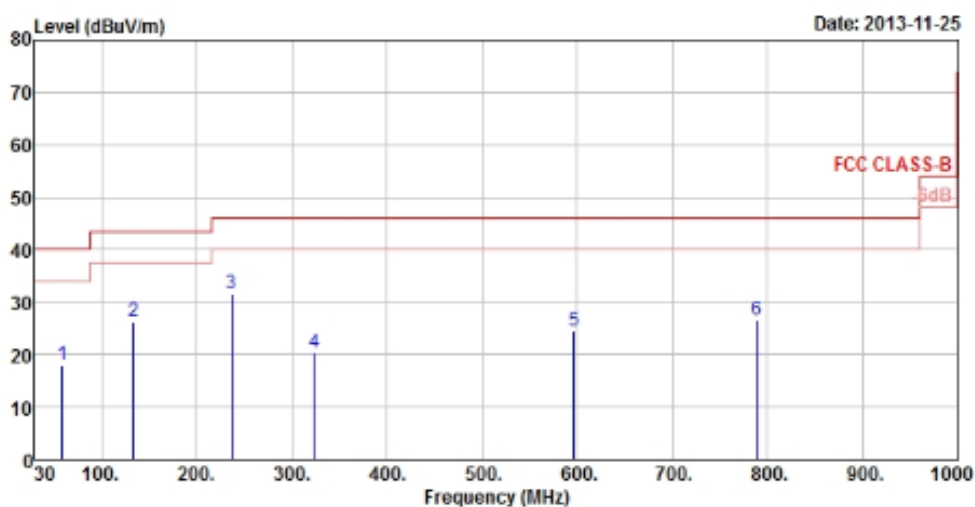
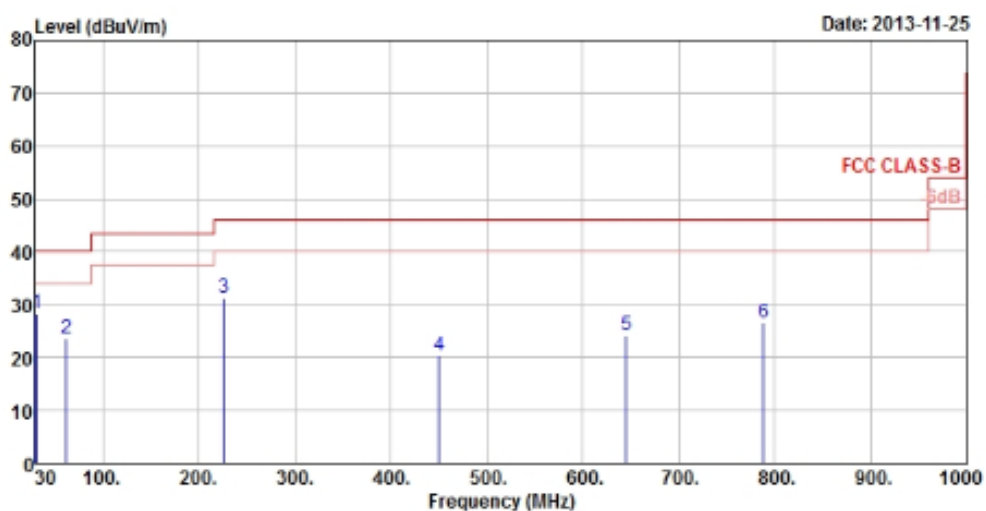
**HORIZONTAL**

**VERTICAL**



A D T

ANTENNA POLARITY & TEST DISTANCE: HORIZONTAL AT 3 M										
FREQ. (MHz)	EMISSION LEVEL (dBuV/m)	READ LEVEL (dBuV)	LIMIT (dBuV/m)	MARGIN (dB)	ANTENNA FACTOR (dB/m)	CABLE LOSS (dB)	PREAMP FACTOR (dB)	ANTENNA HEIGHT (cm)	TABLE ANGLE (Degree)	REMARK
58.89	18.08	36.57	40	-21.92	12.04	0.82	31.35	100	231	Peak
133.68	26.27	44.85	43.5	-17.23	11.94	1.26	31.78	100	147	Peak
236.28	31.45	50.57	46	-14.55	10.91	1.77	31.8	100	292	Peak
323.8	20.49	36.69	46	-25.51	13.52	2.14	31.86	100	145	Peak
596.8	24.63	34.24	46	-21.37	19.52	3.08	32.21	100	243	Peak
789.3	26.47	32.12	46	-19.53	22.08	3.67	31.4	100	187	Peak
ANTENNA POLARITY & TEST DISTANCE: VERTICAL AT 3 M										
FREQ. (MHz)	EMISSION LEVEL (dBuV/m)	READ LEVEL (dBuV)	LIMIT (dBuV/m)	MARGIN (dB)	ANTENNA FACTOR (dB/m)	CABLE LOSS (dB)	PREAMP FACTOR (dB)	ANTENNA HEIGHT (cm)	TABLE ANGLE (Degree)	REMARK
31.08	28.32	46.73	40	-11.68	12.14	0.57	31.12	100	117	Peak
61.86	23.66	42.56	40	-16.34	11.71	0.84	31.45	100	129	Peak
226.29	31.35	50.97	46	-14.65	10.46	1.72	31.8	100	289	Peak
450.5	20.4	33.41	46	-25.6	16.35	2.62	31.98	100	117	Peak
645.1	24.09	32.77	46	-21.91	20.15	3.23	32.06	100	213	Peak
788.6	26.64	32.31	46	-19.36	22.07	3.67	31.41	100	119	Peak

**REMARKS:**

1. Emission Level = Read Level + Antenna Factor + Cable Loss - Preamp Factor  
Margin value = Emission level – Limit value.



### MODE B

EUT TEST CONDITION		MEASUREMENT DETAIL	
CHANNEL	Channel 1	FREQUENCY RANGE	30MHz ~ 1GHz
INPUT POWER	120Vac, 60 Hz	DETECTOR FUNCTION	Peak (PK)
ENVIRONMENTAL CONDITIONS	25deg. C, 65%RH	TESTED BY	David Huang

### HORIZONTAL

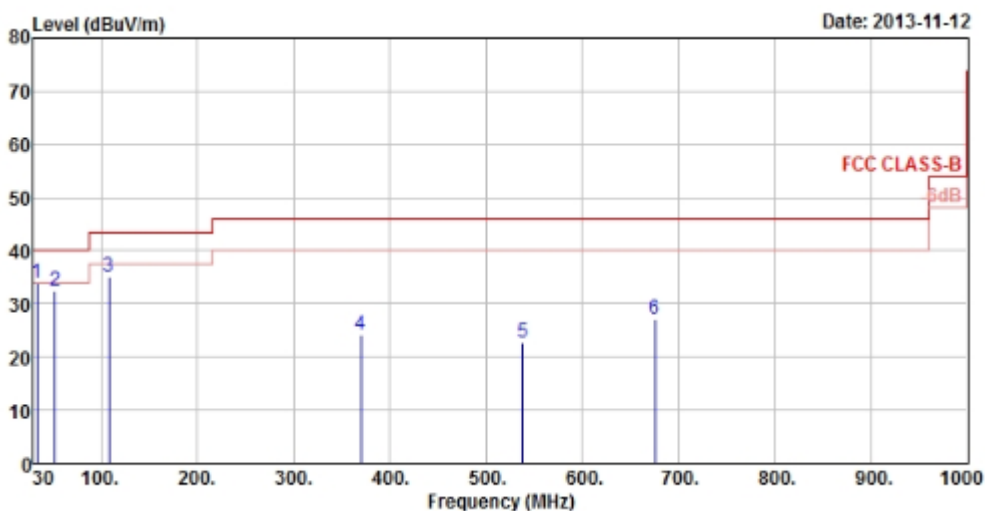

### VERTICAL

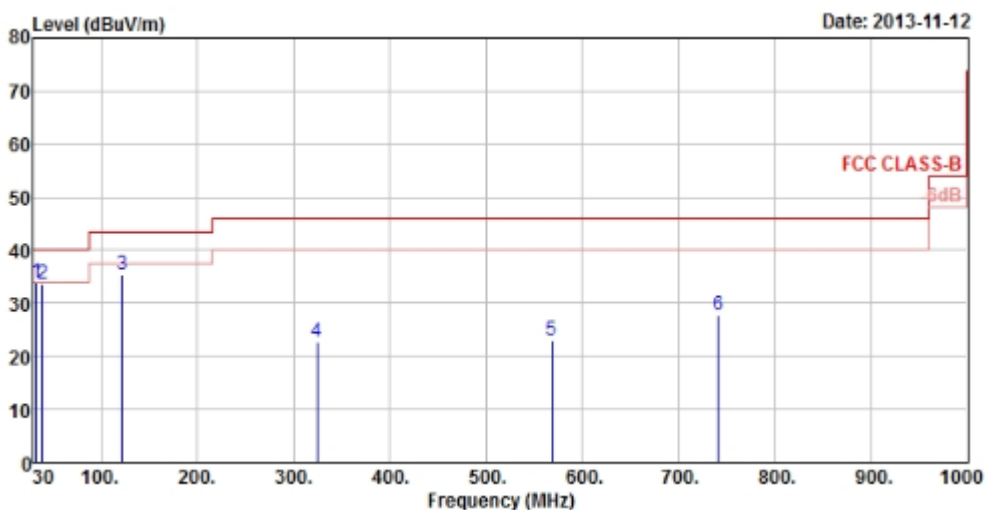



A D T

ANTENNA POLARITY & TEST DISTANCE: HORIZONTAL AT 3 M										
FREQ. (MHz)	EMISSION LEVEL (dBuV/m)	READ LEVEL (dBuV)	LIMIT (dBuV/m)	MARGIN (dB)	ANTENNA FACTOR (dB/m)	CABLE LOSS (dB)	PREAMP FACTOR (dB)	ANTENNA HEIGHT (cm)	TABLE ANGLE (Degree)	REMARK
33.51	33.93	51.79	40	-6.07	12.63	0.59	31.08	100	347	Peak
52.41	32.54	50.32	40	-7.46	12.76	0.78	31.32	100	174	Peak
108.03	35.08	56.02	43.5	-8.42	9.81	1.11	31.86	100	141	Peak
370	24.09	39.07	46	-21.91	14.63	2.31	31.92	100	213	Peak
538	22.83	33.45	46	-23.17	18.19	2.91	31.72	100	148	Peak
675.9	27.15	35.11	46	-18.85	20.53	3.34	31.83	100	163	Peak
ANTENNA POLARITY & TEST DISTANCE: VERTICAL AT 3 M										
FREQ. (MHz)	EMISSION LEVEL (dBuV/m)	READ LEVEL (dBuV)	LIMIT (dBuV/m)	MARGIN (dB)	ANTENNA FACTOR (dB/m)	CABLE LOSS (dB)	PREAMP FACTOR (dB)	ANTENNA HEIGHT (cm)	TABLE ANGLE (Degree)	REMARK
32.43	34.09	52.13	40	-5.91	12.47	0.58	31.09	100	36	Peak
39.18	33.64	50.61	40	-6.36	13.39	0.64	31	100	69	Peak
122.34	35.57	55.12	43.5	-7.93	11.15	1.2	31.9	100	184	Peak
324.5	22.66	38.83	46	-23.34	13.54	2.14	31.85	100	241	Peak
568.1	23.06	33.26	46	-22.94	18.88	3	32.08	100	232	Peak
741	27.65	34.17	46	-18.35	21.39	3.55	31.46	100	184	Peak

**REMARKS:**

1. Emission Level = Read Level + Antenna Factor + Cable Loss - Preamp Factor  
Margin value = Emission level – Limit value.



A D T

## 4.2 CONDUCTED EMISSION MEASUREMENT

### 4.2.1 LIMITS OF CONDUCTED EMISSION MEASUREMENT

FREQUENCY OF EMISSION (MHz)	CONDUCTED LIMIT (dB $\mu$ V)	
	Quasi-peak	Average
0.15 ~ 0.5	66 to 56	56 to 46
0.5 ~ 5	56	46
5 ~ 30	60	50

- NOTE:**
1. The lower limit shall apply at the transition frequencies.
  2. The limit decreases in line with the logarithm of the frequency in the range of 0.15 to 0.50 MHz.
  3. All emanations from a class A/B digital device or system, including any network of conductors and apparatus connected thereto, shall not exceed the level of field strengths specified above.

### 4.2.2 TEST INSTRUMENTS

DESCRIPTION & MANUFACTURER	MODEL NO.	SERIAL NO.	DATE OF CALIBRATION	DUE DATE OF CALIBRATION
Test Receiver ROHDE & SCHWARZ	ESCS30	100290	Dec. 24, 2012	Dec. 23, 2013
RF signal cable Woken	5D-FB	Cable-HYC01-01	Dec. 28, 2012	Dec. 27, 2013
LISN ROHDE & SCHWARZ (EUT)	ESH2-Z5	100312	Jul. 02, 2013	Jul. 01, 2014
LISN ROHDE & SCHWARZ (Peripheral)	ESH3-Z5	835239/001	Feb. 04, 2013	Feb. 03, 2014
Software ADT	BV ADT_Cond_ V7.3.7.3	NA	NA	NA

- NOTE:**
1. The calibration interval of the above test instruments is 12 months and the calibrations are traceable to NML/ROC and NIST/USA.
  2. The test was performed in HwaYa Shielded Room 2.
  3. The VCCI Site Registration No. is C-2047.

#### 4.2.3 TEST PROCEDURES

- The EUT was placed 0.4 meters from the conducting wall of the shielded room with EUT being connected to the power mains through a line impedance stabilization network (LISN). Other support units were connected to the power mains through another LISN. The two LISNs provide 50 ohm/ 50uH of coupling impedance for the measuring instrument.
- Both lines of the power mains connected to the EUT were checked for maximum conducted interference.
- The frequency range from 150kHz to 30MHz was searched. Emission levels under (Limit - 20dB) was not recorded.

**NOTE:** All modes of operation were investigated and the worst-case emissions are reported.

#### 4.2.4 DEVIATION FROM TEST STANDARD

No deviation.

#### 4.2.5 TEST SETUP

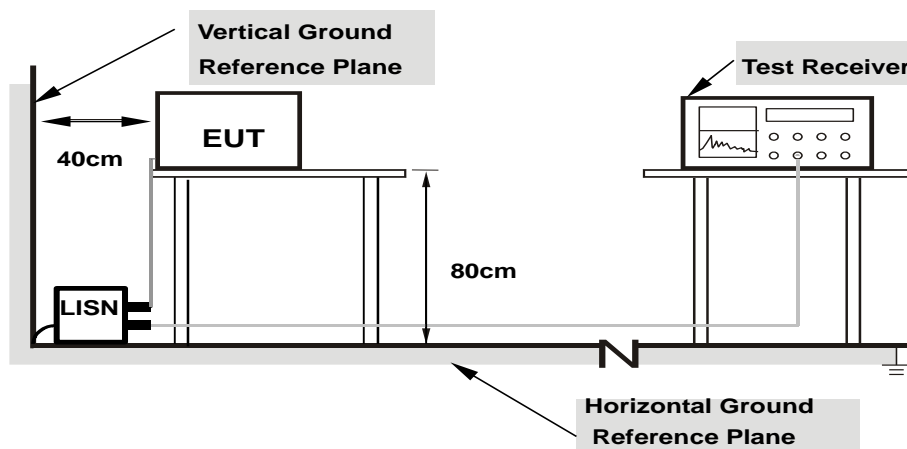

**Note:** 1.Support units were connected to second LISN.  
2.Both of LISNs (AMN) are 80 cm from EUT and at least 80 from other units and other metal planes

For the actual test configuration, please refer to the attached file (Test Setup Photo).

#### 4.2.6 EUT OPERATING CONDITIONS

Same as 4.1.6



## 4.2.7 TEST RESULTS

### MODE A

<b>PHASE</b>	Line 1	<b>6dB BANDWIDTH</b>	9kHz
--------------	--------	----------------------	------

No	Freq. [MHz]	Corr. Factor (dB)	Reading Value [dB (uV)]		Emission Level [dB (uV)]		Limit [dB (uV)]		Margin (dB)	
			Q.P.	AV.	Q.P.	AV.	Q.P.	AV.	Q.P.	AV.
			1	0.16953	0.17	3.87	-0.73	4.04	-0.56	64.98
2	0.83750	0.25	22.04	17.07	22.29	17.32	56.00	46.00	-33.71	-28.68
3	1.69922	0.28	7.32	4.30	7.60	4.58	56.00	46.00	-48.40	-41.42
4	4.37891	0.37	-7.74	-9.85	-7.37	-9.48	56.00	46.00	-63.37	-55.48
5	7.52734	0.41	-7.38	-9.36	-6.97	-8.95	60.00	50.00	-66.97	-58.95
6	17.73438	0.59	-7.31	-9.66	-6.72	-9.07	60.00	50.00	-66.72	-59.07

### REMARKS:

1. Q.P. and AV. are abbreviations of quasi-peak and average individually.
2. The emission levels of other frequencies were very low against the limit.
3. Margin value = Emission level - Limit value
4. Correction factor = Insertion loss + Cable loss
5. Emission Level = Correction Factor + Reading Value.

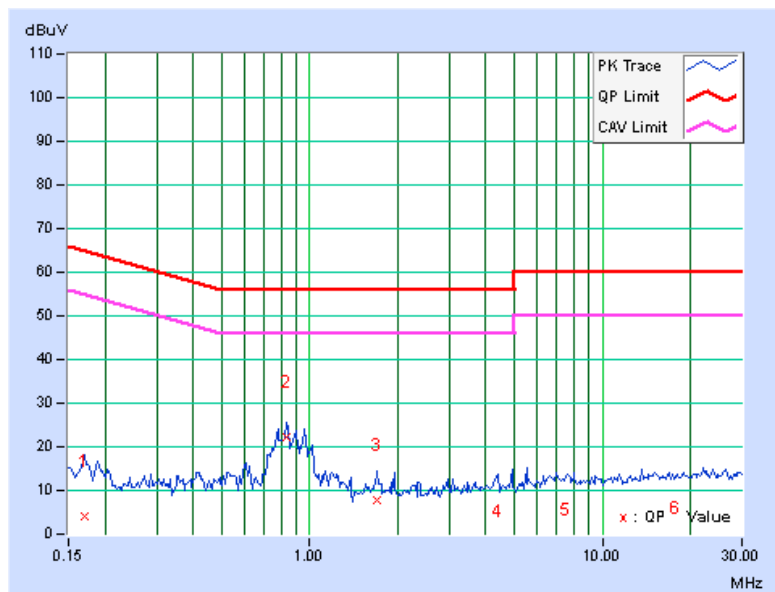

<b>PHASE</b>	Line 2	<b>6dB BANDWIDTH</b>	9kHz
--------------	--------	----------------------	------

No	Freq. [MHz]	Corr. Factor (dB)	Reading Value		Emission Level		Limit		Margin	
			[dB (uV)]		[dB (uV)]		[dB (uV)]		(dB)	
			Q.P.	AV.	Q.P.	AV.	Q.P.	AV.	Q.P.	AV.
1	0.18906	0.18	4.77	0.03	4.95	0.21	64.08	54.08	-59.13	-53.87
2	0.83750	0.24	22.08	17.03	22.32	17.27	56.00	46.00	-33.68	-28.73
3	1.89063	0.27	-2.13	-5.17	-1.86	-4.90	56.00	46.00	-57.86	-50.90
4	4.16406	0.39	-8.49	-10.28	-8.10	-9.89	56.00	46.00	-64.10	-55.89
5	7.79688	0.45	-7.24	-9.33	-6.79	-8.88	60.00	50.00	-66.79	-58.88
6	17.04297	0.66	-7.17	-9.50	-6.51	-8.84	60.00	50.00	-66.51	-58.84

**REMARKS:**

1. Q.P. and AV. are abbreviations of quasi-peak and average individually.
2. The emission levels of other frequencies were very low against the limit.
3. Margin value = Emission level - Limit value
4. Correction factor = Insertion loss + Cable loss
5. Emission Level = Correction Factor + Reading Value.

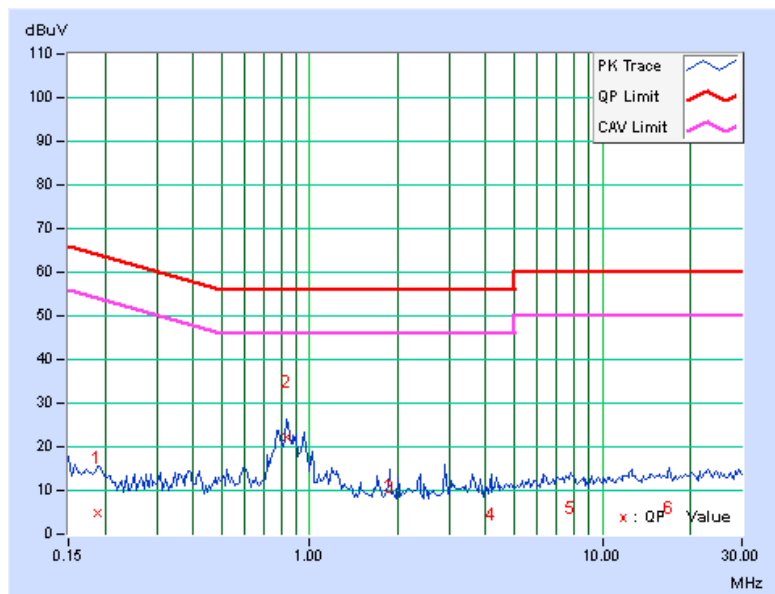

**MODE B**

<b>PHASE</b>	Line 1	<b>6dB BANDWIDTH</b>	9kHz
--------------	--------	----------------------	------

No	Freq. [MHz]	Corr. Factor (dB)	Reading Value [dB (uV)]		Emission Level [dB (uV)]		Limit [dB (uV)]		Margin (dB)	
			Q.P.	AV.	Q.P.	AV.	Q.P.	AV.	Q.P.	AV.
			1	0.40000	0.21	34.45	31.90	34.66	32.11	57.85
2	0.61094	0.23	27.61	14.58	27.84	14.81	56.00	46.00	-28.16	-31.19
3	1.33203	0.27	19.61	7.75	19.88	8.02	56.00	46.00	-36.12	-37.98
4	2.55859	0.31	20.69	7.95	21.00	8.26	56.00	46.00	-35.00	-37.74
5	8.49219	0.41	23.43	14.63	23.84	15.04	60.00	50.00	-36.16	-34.96
6	27.66016	0.55	18.97	9.76	19.52	10.31	60.00	50.00	-40.48	-39.69

**REMARKS:**

1. Q.P. and AV. are abbreviations of quasi-peak and average individually.
2. The emission levels of other frequencies were very low against the limit.
3. Margin value = Emission level - Limit value
4. Correction factor = Insertion loss + Cable loss
5. Emission Level = Correction Factor + Reading Value.

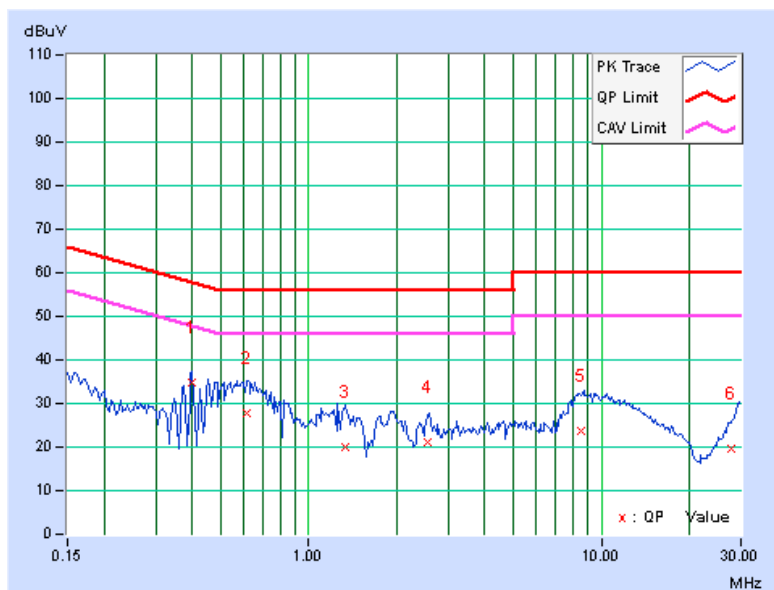

PHASE	Line 2	6dB BANDWIDTH	9kHz
-------	--------	---------------	------

No	Freq. [MHz]	Corr. Factor (dB)	Reading Value [dB (uV)]		Emission Level [dB (uV)]		Limit [dB (uV)]		Margin (dB)	
			Q.P.	AV.	Q.P.	AV.	Q.P.	AV.	Q.P.	AV.
1	0.41563	0.25	36.99	33.89	37.24	34.14	57.54	47.54	-20.30	-13.40
2	0.65781	0.24	21.38	14.45	21.62	14.69	56.00	46.00	-34.38	-31.31
3	1.21484	0.24	19.23	14.42	19.47	14.66	56.00	46.00	-36.53	-31.34
4	4.01563	0.39	16.20	9.71	16.59	10.10	56.00	46.00	-39.41	-35.90
5	8.58594	0.46	23.46	16.77	23.92	17.23	60.00	50.00	-36.08	-32.77
6	15.05859	0.61	17.30	9.40	17.91	10.01	60.00	50.00	-42.09	-39.99

**REMARKS:**

1. Q.P. and AV. are abbreviations of quasi-peak and average individually.
2. The emission levels of other frequencies were very low against the limit.
3. Margin value = Emission level - Limit value
4. Correction factor = Insertion loss + Cable loss
5. Emission Level = Correction Factor + Reading Value.

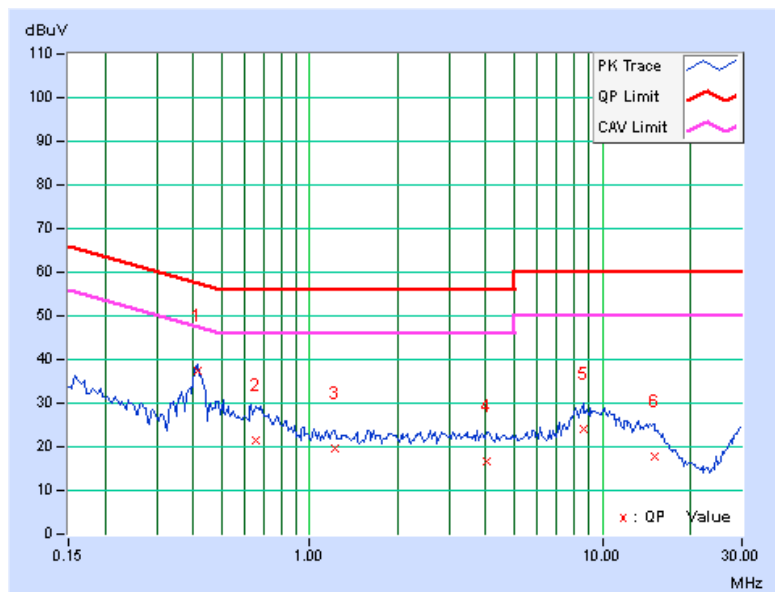

### 4.3 FREQUENCY STABILITY

#### 4.3.1 LIMITS OF FREQUENCY STABILITY MEASUREMENT

The frequency tolerance of the carrier signal shall be maintained within +/- 0.01% of the operating frequency over a temperature variation of -20 degrees to 50 degrees C at normal supply voltage, and for a variation in the primary supply voltage from 85% to 115% of the rated supply voltage at a temperature of 20 degrees C.

#### 4.3.2 TEST INSTRUMENTS

DESCRIPTION & MANUFACTURER	MODEL NO.	SERIAL NO.	DATE OF CALIBRATION	DUE DATE OF CALIBRATION
R&S SPECTRUM ANALYZER	FSP40	100039	Jan. 31, 2013	Jan. 30, 2014
WIT STANDARD TEMPERATURE AND HUMIDITY CHAMBER	TH-4S-C	W981030	Jun. 10, 2013	Jun. 09, 2014

**NOTE:** The calibration interval of the above test instruments is 12 months and the calibrations are traceable to NML/ROC and NIST/USA.

#### 4.3.3 TEST PROCEDURE

- a. The EUT was placed inside the environmental test chamber and powered by nominal DC voltage.
- b. Turn the EUT on and couple its output to a spectrum analyzer.
- c. Turn the EUT off and set the chamber to the highest temperature specified.
- d. Allow sufficient time (approximately 30 min) for the temperature of the chamber to stabilize, turn the EUT on and measure the operating frequency after 2, 5, and 10 minutes.
- e. Repeat step 2 and 3 with the temperature chamber set to the lowest temperature.
- f. The test chamber was allowed to stabilize at +20 degree C for a minimum of 30 minutes. The supply voltage was then adjusted on the EUT from 85% to 115% range and the frequency record.

#### 4.3.4 DEVIATION FROM TEST STANDARD

No deviation.

#### 4.3.5 TEST SETUP

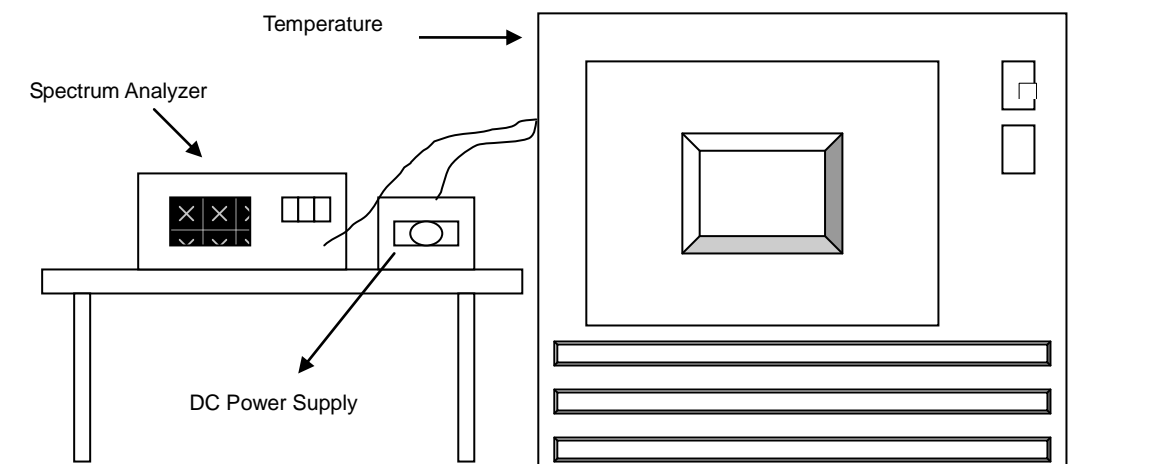

#### 4.3.6 EUT OPERATING CONDITION

Same as Item 4.1.6.



### 4.3.7 TEST RESULTS

FREQUENCY STABILITY VERSUS TEMP.									
TEMP. (°C)	POWER SUPPLY (Vdc)	0 MINUTE		2 MINUTE		5 MINUTE		10 MINUTE	
		Measured Frequency	Frequency Drift	Measured Frequency	Frequency Drift	Measured Frequency	Frequency Drift	Measured Frequency	Frequency Drift
		(MHz)	%	(MHz)	%	(MHz)	%	(MHz)	%
55	5	13.559945	-0.0004	13.55995	-0.0004	13.559965	-0.0003	13.559938	-0.0005
50	5	13.559954	-0.00034	13.559953	-0.00035	13.559942	-0.00043	13.559939	-0.00045
40	5	13.560007	0.00005	13.560015	0.00011	13.560002	0.00001	13.56001	0.00007
30	5	13.56003	0.00022	13.560036	0.00027	13.560045	0.00033	13.560054	0.00040
20	5	13.560057	0.00042	13.560047	0.00035	13.56007	0.00052	13.560062	0.00046
10	5	13.559991	-0.00007	13.559985	-0.00011	13.559975	-0.00018	13.559976	-0.00018
0	5	13.560033	0.00024	13.560046	0.00034	13.560022	0.00016	13.560038	0.00028
-10	5	13.560057	0.00042	13.560065	0.00048	13.560041	0.00030	13.560047	0.00035
-20	5	13.56001	0.00007	13.559986	-0.00010	13.559982	-0.00013	13.559995	-0.00004
-30	5	13.560007	0.00005	13.560051	-0.00013	13.560042	-0.00013	13.560047	-0.00003

FREQUENCY STABILITY VERSUS VOLTAGE									
TEMP. (°C)	POWER SUPPLY (Vdc)	0 MINUTE		2 MINUTE		5 MINUTE		10 MINUTE	
		Measured Frequency	Frequency Drift	Measured Frequency	Frequency Drift	Measured Frequency	Frequency Drift	Measured Frequency	Frequency Drift
		(MHz)	%	(MHz)	%	(MHz)	%	(MHz)	%
20	5.46	13.560055	0.00041	13.560044	0.00032	13.560072	0.00053	13.560065	0.00048
	5	13.560057	0.00042	13.560047	0.00035	13.56007	0.00052	13.560062	0.00046
	4.75	13.560055	0.00041	13.560045	0.00033	13.560072	0.00053	13.560065	0.00048

#### **4.4 20dB BANDWIDTH**

##### **4.4.1 LIMITS OF 20dB BANDWIDTH MEASUREMENT**

The 20dB bandwidth shall be specified in operating frequency band.

##### **4.4.2 TEST INSTRUMENTS**

Same as Item 4.1.2.

##### **4.4.3 TEST PROCEDURE**

The bandwidth of the fundamental frequency was measured by spectrum analyzer with 1kHz RBW and 3kHz VBW. The 20dB bandwidth is defined as the total spectrum the power of which is higher than peak power minus 20dB.

##### **4.4.4 DEVIATION FROM TEST STANDARD**

No deviation.

##### **4.4.5 TEST SETUP**

Same as Item 4.1.5.

##### **4.4.6 EUT OPERATING CONDITION**

Same as Item 4.1.6.



### 4.4.7 TEST RESULTS

20dBc point (Low)	20dBc point (High)	Operating frequency band (MHz)	PASS/FAIL
13.558594359 MHz	13.561190513 MHz	13.553~13.567	PASS

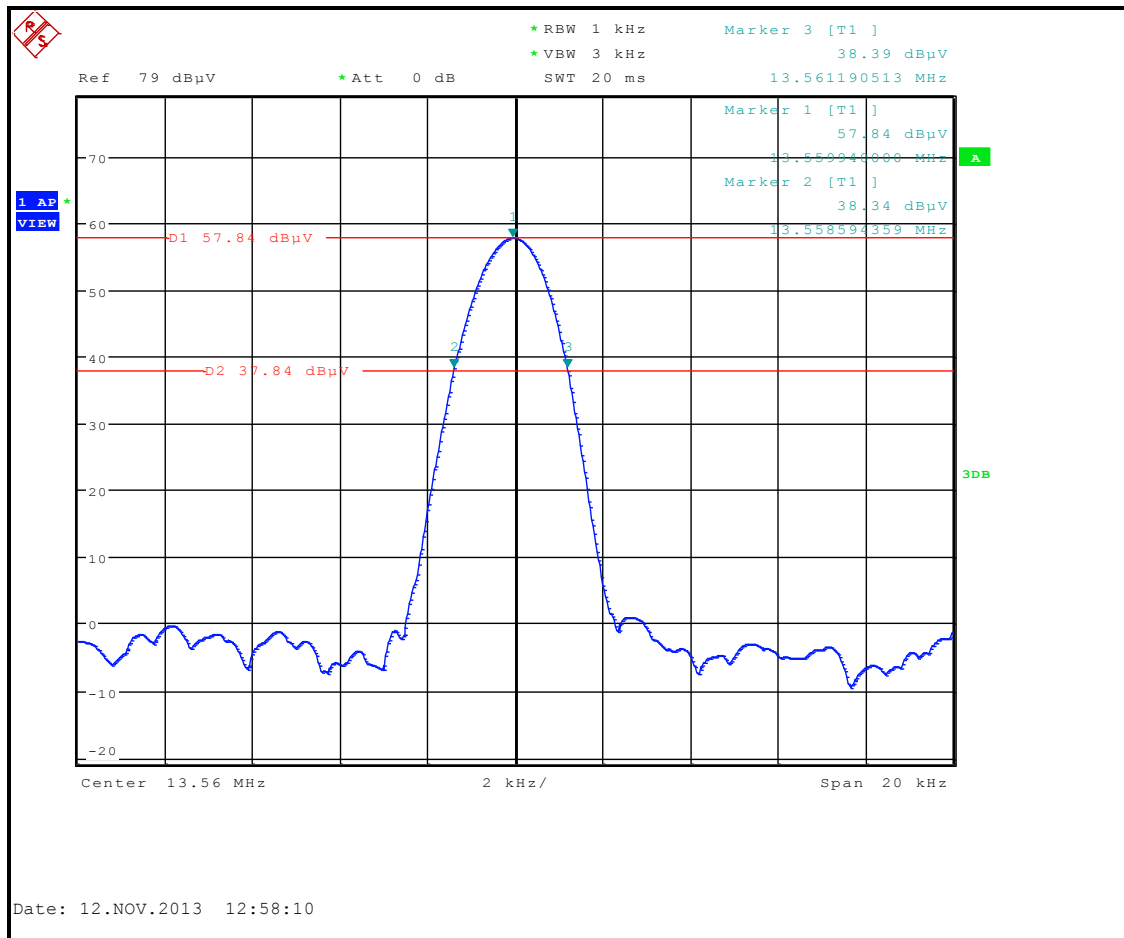

## 5. PHOTOGRAPHS OF THE TEST CONFIGURATION

Please refer to the attached file (Test Setup Photo).

## 6. INFORMATION ON THE TESTING LABORATORIES

We, Bureau Veritas Consumer Products Services (H.K.) Ltd., Taoyuan Branch, were founded in 1988 to provide our best service in EMC, Radio, Telecom and Safety consultation. Our laboratories are accredited and approved according to ISO/IEC 17025.

If you have any comments, please feel free to contact us at the following:

**Linko EMC/RF Lab:**

Tel: 886-2-26052180

Fax: 886-2-26051924

**Hsin Chu EMC/RF Lab:**

Tel: 886-3-5935343

Fax: 886-3-5935342

**Hwa Ya EMC/RF/Safety Telecom Lab:**

Tel: 886-3-3183232

Fax: 886-3-3270892

**Email:** [service.adt@tw.bureauveritas.com](mailto:service.adt@tw.bureauveritas.com)

**Web Site:** [www.bureauveritas-adt.com](http://www.bureauveritas-adt.com)

The address and road map of all our labs can be found in our web site also.

## **7. APPENDIX A - MODIFICATIONS RECORDERS FOR ENGINEERING CHANGES TO THE EUT BY THE LAB**

No any modifications are made to the EUT by the lab during the test.

**--- END ---**