



# FCC TEST REPORT (BLUETOOTH)

**REPORT NO.:** RF131104C19  
**MODEL NO.:** VX675 WIFI-BT  
**FCC ID:** B32VX675WIFIBT  
**RECEIVED:** Nov. 04, 2013  
**TESTED:** Nov. 11, 2013 ~ Nov. 25, 2013  
**ISSUED:** Nov. 28, 2013

**APPLICANT:** VeriFone, Inc.

**ADDRESS:** 1400 West Stanford Ranch Road Suite 200  
Rocklin CA 95765 USA

**ISSUED BY:** Bureau Veritas Consumer Products Services (H.K.)  
Ltd., Taoyuan Branch

**LAB ADDRESS:** No. 47, 14th Ling, Chia Pau Vil., Lin Kou Dist., New  
Taipei City, Taiwan ( R.O.C )

**TEST LOCATION:** No. 19, Hwa Ya 2nd Rd, Wen Hwa Tsuen, Kwei  
Shan Hsiang, Taoyuan Hsien 333, Taiwan, R.O.C.

This report should not be used by the client to claim product certification, approval, or endorsement by TAF or any government agencies.



This report is for your exclusive use. Any copying or replication of this report to or for any other person or entity, or use of our name or trademark, is permitted only with our prior written permission. This report sets forth our findings solely with respect to the test samples identified herein. The results set forth in this report are not indicative or representative of the quality or characteristics of the lot from which a test sample was taken or any similar or identical product unless specifically and expressly noted. Our report includes all of the tests requested by you and the results thereof based upon the information that you provided to us. You have 60 days from date of issuance of this report to notify us of any material error or omission caused by our negligence, provided, however, that such notice shall be in writing and shall specifically address the issue you wish to raise. A failure to raise such issue within the prescribed time shall constitute your unqualified acceptance of the completeness of this report, the tests conducted and the correctness of the report contents. Unless specific mention, the uncertainty of measurement has been explicitly taken into account to declare the compliance or non-compliance to the specification

## Table of Contents

RELEASE CONTROL RECORD .....	4
1. CERTIFICATION.....	5
2. SUMMARY OF TEST RESULTS .....	6
2.1 MEASUREMENT UNCERTAINTY .....	6
3. GENERAL INFORMATION.....	7
3.1 GENERAL DESCRIPTION OF EUT .....	7
3.2 DESCRIPTION OF TEST MODES .....	8
3.2.1 TEST MODE APPLICABILITY AND TESTED CHANNEL DETAIL.....	9
3.3 GENERAL DESCRIPTION OF APPLIED STANDARDS .....	11
3.4 DESCRIPTION OF SUPPORT UNITS .....	11
3.4.1 CONFIGURATION OF SYSTEM UNDER TEST .....	11
4. TEST TYPES AND RESULTS .....	12
4.1 Radiated Emission AND BANDEDGE Measurement .....	12
4.1.1 LIMITS OF RADIATED EMISSION AND BANDEDGE MEASUREMENT .....	12
4.1.2 TEST INSTRUMENTS.....	13
4.1.3 TEST PROCEDURES .....	14
4.1.4 DEVIATION FROM TEST STANDARD .....	14
4.1.5 TEST SETUP .....	15
4.1.6 EUT OPERATING CONDITIONS .....	15
4.1.7 TEST RESULTS.....	16
4.2 CONDUCTED EMISSION MEASUREMENT .....	21
4.2.1 LIMITS OF CONDUCTED EMISSION MEASUREMENT .....	21
4.2.2 TEST INSTRUMENTS.....	21
4.2.3 TEST PROCEDURES .....	22
4.2.4 DEVIATION FROM TEST STANDARD .....	22
4.2.5 TEST SETUP .....	23
4.2.6 EUT OPERATING CONDITIONS .....	23
4.2.7 TEST RESULTS.....	24
4.3 NUMBER OF HOPPING FREQUENCY USED .....	28
4.3.1 LIMIT OF HOPPING FREQUENCY USED .....	28
4.3.2 TEST SETUP .....	28
4.3.3 TEST INSTRUMENTS.....	28
4.3.4 TEST PROCEDURES .....	28
4.3.5 DEVIATION FROM TEST STANDARD .....	28
4.3.6 TEST RESULTS.....	28
4.4 DWELL TIME ON EACH CHANNEL .....	30
4.4.1 LIMIT OF DWELL TIME USED .....	30
4.4.2 TEST SETUP .....	30
4.4.3 TEST INSTRUMENTS.....	30
4.4.4 TEST PROCEDURES .....	30
4.4.5 DEVIATION FROM TEST STANDARD .....	30
4.4.6 TEST RESULTS.....	31
4.5 CHANNEL BANDWIDTH .....	34
4.5.1 LIMITS OF CHANNEL BANDWIDTH .....	34
4.5.2 TEST SETUP .....	34
4.5.3 TEST INSTRUMENTS.....	34



4.5.4	TEST PROCEDURE .....	34
4.5.5	DEVIATION FROM TEST STANDARD .....	34
4.5.6	EUT OPERATING CONDITION .....	34
4.5.7	TEST RESULTS.....	35
4.6	HOPPING CHANNEL SEPARATION .....	36
4.6.1	LIMIT OF HOPPING CHANNEL SEPARATION .....	36
4.6.2	TEST SETUP .....	36
4.6.3	TEST INSTRUMENTS.....	36
4.6.4	TEST PROCEDURES .....	36
4.6.5	DEVIATION FROM TEST STANDARD .....	36
4.6.6	TEST RESULTS.....	37
4.7	MAXIMUM OUTPUT POWER .....	38
4.7.1	LIMITS OF MAXIMUM OUTPUT POWER MEASUREMENT .....	38
4.7.2	TEST SETUP .....	38
4.7.3	TEST INSTRUMENTS.....	38
4.7.4	TEST PROCEDURES .....	38
4.7.5	DEVIATION FROM TEST STANDARD .....	38
4.7.6	EUT OPERATING CONDITION.....	38
4.7.7	TEST RESULTS.....	39
4.8	CONDUCTED OUT OF BAND EMISSION MEASUREMENT .....	40
4.8.1	LIMITS OF CONDUCTED OUT OF BAND EMISSION MEASUREMENT .....	40
4.8.2	TEST INSTRUMENTS.....	40
4.8.3	TEST PROCEDURE .....	40
4.8.4	DEVIATION FROM TEST STANDARD .....	40
4.8.5	EUT OPERATING CONDITION.....	40
4.8.6	TEST RESULTS.....	40
5.	PHOTOGRAPHS OF THE TEST CONFIGURATION.....	44
6.	INFORMATION ON THE TESTING LABORATORIES .....	45
7.	APPENDIX A - Modifications recorders for engineering changes to the eut BY THE LAB ...	46



## RELEASE CONTROL RECORD

ISSUE NO.	REASON FOR CHANGE	DATE ISSUED
RF131104C19	Original release	Nov. 28, 2013



## 1. CERTIFICATION

**PRODUCT:** Point of Sale Terminal  
**MODEL NO.:** VX675 WIFI-BT  
**BRAND:** VeriFone  
**APPLICANT:** VeriFone, Inc.  
**TESTED:** Nov. 11, 2013 ~ Nov. 25, 2013  
**TEST SAMPLE:** Identical Prototype  
**STANDARDS:** **FCC Part 15, Subpart C (Section 15.247)**  
ANSI C63.10-2009

The above equipment (model: VX675 WIFI-BT) has been tested by **Bureau Veritas Consumer Products Services (H.K.) Ltd., Taoyuan Branch**, and found compliance with the requirement of the above standards. The test record, data evaluation & Equipment Under Test (EUT) configurations represented herein are true and accurate accounts of the measurements of the sample's EMC characteristics under the conditions specified in this report.

**PREPARED BY** : Evonne Liu , **DATE** : Nov. 28, 2013  
Evonne Liu / Specialist

**APPROVED BY** : Sam Chen , **DATE** : Nov. 28, 2013  
Sam Chen / Assistant Manager

## 2. SUMMARY OF TEST RESULTS

The EUT has been tested according to the following specifications:

APPLIED STANDARD: FCC Part 15, Subpart C			
STANDARD SECTION	TEST TYPE AND LIMIT	RESULT	REMARK
15.207	AC Power Conducted Emission	PASS	Meet the requirement of limit. Minimum passing margin is -13.40dB at 0.41563MHz.
15.247(a)(1) (iii)	Number of Hopping Frequency Used	PASS	Meet the requirement of limit.
15.247(a)(1) (iii)	Dwell Time on Each Channel	PASS	Meet the requirement of limit.
15.247(a)(1)	1. Hopping Channel Separation 2. Spectrum Bandwidth of a Frequency Hopping Sequence Spread Spectrum System	PASS	Meet the requirement of limit.
15.247(b)	Maximum Peak Output Power	PASS	Meet the requirement of limit.
15.247(d)	Transmitter Radiated Emissions	PASS	Meet the requirement of limit. Minimum passing margin is -6.68dB at 39.45MHz.
15.247(d)	Band Edge Measurement	PASS	Meet the requirement of limit.
15.203	Antenna Requirement	PASS	No antenna connector is used.

**NOTE:** If The Frequency Hopping System operating in 2400-2483.5MHz band and the output power less than 125mW. The hopping channel carrier frequencies separated by a minimum of 25kHz or two-thirds of the 20dB bandwidth of hopping channel whichever is greater.

### 2.1 MEASUREMENT UNCERTAINTY

Where relevant, the following measurement uncertainty levels have been estimated for tests performed on the EUT as specified in CISPR 16-4-2:

MEASUREMENT	FREQUENCY	UNCERTAINTY
Conducted emissions	9kHz~30MHz	2.44 dB
Radiated emissions	30MHz ~ 200MHz	2.93 dB
	200MHz ~1000MHz	2.95 dB
	1GHz ~ 18GHz	2.26 dB
	18GHz ~ 40GHz	1.94 dB

This uncertainty represents an expanded uncertainty expressed at approximately the 95% confidence level using a coverage factor of k=2.

### 3. GENERAL INFORMATION

#### 3.1 GENERAL DESCRIPTION OF EUT

<b>EUT</b>	Point of Sale Terminal
<b>MODEL NO.</b>	VX675 WIFI-BT
<b>POWER SUPPLY</b>	5Vdc (adapter) 3.6Vdc (battery)
<b>MODULATION TYPE</b>	GFSK, $\pi/4$ -DQPSK, 8DPSK
<b>TRANSFER RATE</b>	1/2/3Mbps
<b>OPERATING FREQUENCY</b>	2402 ~ 2480MHz
<b>NUMBER OF CHANNEL</b>	79
<b>CHANNEL SPACING</b>	1MHz
<b>OUTPUT POWER</b>	14.655mW
<b>ANTENNA TYPE</b>	PCB antenna with 0.8dBi gain
<b>ANTENNA CONNECTOR</b>	NA
<b>DATA CABLE</b>	Refer to Note as below
<b>I/O PORTS</b>	Refer to user's manual
<b>ACCESSORY DEVICES</b>	Refer to Note as below

**NOTE:**

1. The EUT has following accessories.

ITEM	BRAND	MODEL	DESCRIPTION
Adapter 1	VeriFone	SC1402	I/P: 100-240Vac, 50-60Hz, 150mA O/P: 5Vdc, 1A
Adapter 2	VeriFone	MU06-E050100-A1	I/P: 100-240Vac, 50/60Hz, 0.2A O/P: 5Vdc, 1A
Battery	VeriFone	BPK265-001	Rating : 3.6V, 2200mAh
WLAN/BT Module 1	Ampak	GB86321D	with diversity
WLAN/BT Module 2	Ampak	GB86321G	w/o diversity

\*\* The EUT was tested with WLAN/BT Module 2.

2. The above EUT information is declared by the manufacturer and for more detailed features description, please refer to the manufacturer's specifications or User's Manual.

### 3.2 DESCRIPTION OF TEST MODES

79 channels are provided to this EUT:

CHANNEL	FREQ. (MHz)	CHANNEL	FREQ. (MHz)	CHANNEL	FREQ. (MHz)	CHANNEL	FREQ. (MHz)
0	2402	20	2422	40	2442	60	2462
1	2403	21	2423	41	2443	61	2463
2	2404	22	2424	42	2444	62	2464
3	2405	23	2425	43	2445	63	2465
4	2406	24	2426	44	2446	64	2466
5	2407	25	2427	45	2447	65	2467
6	2408	26	2428	46	2448	66	2468
7	2409	27	2429	47	2449	67	2469
8	2410	28	2430	48	2450	68	2470
9	2411	29	2431	49	2451	69	2471
10	2412	30	2432	50	2452	70	2472
11	2413	31	2433	51	2453	71	2473
12	2414	32	2434	52	2454	72	2474
13	2415	33	2435	53	2455	73	2475
14	2416	34	2436	54	2456	74	2476
15	2417	35	2437	55	2457	75	2477
16	2418	36	2438	56	2458	76	2478
17	2419	37	2439	57	2459	77	2479
18	2420	38	2440	58	2460	78	2480
19	2421	39	2441	59	2461		



### 3.2.1 TEST MODE APPLICABILITY AND TESTED CHANNEL DETAIL

EUT CONFIGURE MODE	APPLICABLE TO				DESCRIPTION
	RE $\geq$ 1G	RE<1G	PLC	APCM	
A	-	√	-	-	Adapter 1
B	√	√	√	√	Adapter 2

Where **RE $\geq$ 1G**: Radiated Emission above 1GHz      **RE<1G**: Radiated Emission below 1GHz  
**PLC**: Power Line Conducted Emission      **APCM**: Antenna Port Conducted Measurement

**NOTE:** 1. For Radiated emission test, pre-tested GFSK,  $\pi/4$ -DQPSK, GFSK modulation type and found  $\pi/4$ -DQPSK was the worse, therefore chosen for the final test and presented in the test report.  
2. The EUT had been pre-tested on the positioned of each 3 axis. The worst case was found when positioned on **X-plane**.

#### RADIATED EMISSION TEST (ABOVE 1 GHz):

- Pre-Scan has been conducted to determine the worst-case mode from all possible combinations between available modulations, antenna ports (if EUT with antenna diversity architecture) and packet type.
- Following channel(s) was (were) selected for the final test as listed below.

EUT CONFIGURE MODE	AVAILABLE CHANNEL	TESTED CHANNEL	MODULATION TYPE	PACKET TYPE
B	0 to 78	0, 39, 78	GFSK	DH5

#### RADIATED EMISSION TEST (BELOW 1 GHz):

- Pre-Scan has been conducted to determine the worst-case mode from all possible combinations between available modulations, antenna ports (if EUT with antenna diversity architecture) and packet type.
- Following channel(s) was (were) selected for the final test as listed below.

EUT CONFIGURE MODE	AVAILABLE CHANNEL	TESTED CHANNEL	MODULATION TYPE	PACKET TYPE
A	0 to 78	78	GFSK	DH5
B	0 to 78	78	GFSK	DH5

#### POWER LINE CONDUCTED EMISSION TEST:

- Pre-Scan has been conducted to determine the worst-case mode from all possible combinations between available modulations, antenna ports (if EUT with antenna diversity architecture), and packet types.
- Following channel(s) was (were) selected for the final test as listed below.

EUT CONFIGURE MODE	AVAILABLE CHANNEL	TESTED CHANNEL	MODULATION TYPE	PACKET TYPE
A	0 to 78	78	GFSK	DH5
B	0 to 78	78	GFSK	DH5

**ANTENNA PORT CONDUCTED MEASUREMENT:**

- This item includes all test value of each mode, but only includes spectrum plot of worst value of each mode.
- Pre-Scan has been conducted to determine the worst-case mode from all possible combinations between available modulations, antenna ports (if EUT with antenna diversity architecture), and packet types.
- Following channel(s) was (were) selected for the final test as listed below.

EUT CONFIGURE MODE	AVAILABLE CHANNEL	TESTED CHANNEL	MODULATION TYPE	PACKET TYPE
B	0 to 78	0, 39, 78	GFSK	DH5
	0 to 78	0, 39, 78	$\pi/4$ -DQPSK	DH5
	0 to 78	0, 39, 78	8DPSK	DH5

**TEST CONDITION:**

APPLICABLE TO	ENVIRONMENTAL CONDITIONS	INPUT POWER	TESTED BY
RE $\geq$ 1G	25deg. C, 65%RH	120Vac, 60Hz	Johnson Liao
RE<1G	25deg. C, 65%RH	120Vac, 60Hz	Anson Lin / Johnson Liao
PLC	25deg. C, 65%RH	120Vac, 60Hz	Johnson Liao
APCM	25deg. C, 65%RH	120Vac, 60Hz	Dylan Yang

### 3.3 GENERAL DESCRIPTION OF APPLIED STANDARDS

The EUT is a RF Product. According to the specifications of the manufacturer, it must comply with the requirements of the following standards:

**FCC Part 15, Subpart C (15.247)**

**ANSI C63.10-2009**

**FCC Public Notice DA 00-705**

All test items have been performed and recorded as per the above standards.

**NOTE:** The EUT is also considered as a kind of computer peripheral, because the connection to computer is necessary for typical use. It has been verified to comply with the requirements of FCC Part 15, Subpart B, Class B (DoC). The test report has been issued separately.

### 3.4 DESCRIPTION OF SUPPORT UNITS

The EUT has been tested as an independent unit together with other necessary accessories or support units.

#### 3.4.1 CONFIGURATION OF SYSTEM UNDER TEST

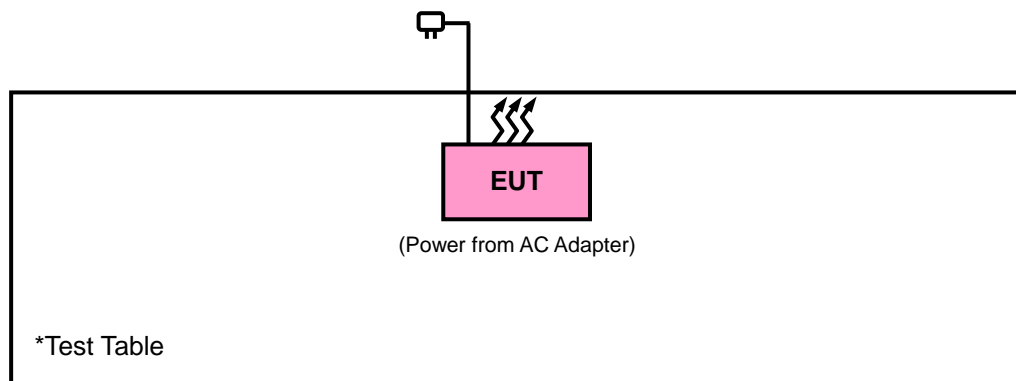

## 4. TEST TYPES AND RESULTS

### 4.1 RADIATED EMISSION AND BANDEDGE MEASUREMENT

#### 4.1.1 LIMITS OF RADIATED EMISSION AND BANDEDGE MEASUREMENT

Radiated emissions which fall in the restricted bands must comply with the radiated emission limits specified as below table. Other emissions shall be at least 20dB below the highest level of the desired power:

FREQUENCIES (MHz)	FIELD STRENGTH (microvolts/meter)	MEASUREMENT DISTANCE (meters)
0.009 ~ 0.490	2400/F(kHz)	300
0.490 ~ 1.705	24000/F(kHz)	30
1.705 ~ 30.0	30	30
30 ~ 88	100	3
88 ~ 216	150	3
216 ~ 960	200	3
Above 960	500	3

**NOTE:**

1. The lower limit shall apply at the transition frequencies.
2. Emission level (dBuV/m) = 20 log Emission level (uV/m).
3. For frequencies above 1000MHz, the field strength limits are based on average detector, however, the peak field strength of any emission shall not exceed the maximum permitted average limits, specified above by more than 20dB under any condition of modulation.

#### 4.1.2 TEST INSTRUMENTS

DESCRIPTION & MANUFACTURER	MODEL NO.	SERIAL NO.	DATE OF CALIBRATION	DUE DATE OF CALIBRATION
Test Receiver ROHDE & SCHWARZ	ESCI	100744	Apr. 15, 2013	Apr. 14, 2014
Spectrum Analyzer ROHDE & SCHWARZ	FSU43	101261	Dec. 17, 2012	Dec. 16, 2013
BILOG Antenna SCHWARZBECK	VULB9168	9168-472	Mar. 25, 2013	Mar. 24, 2014
HORN Antenna SCHWARZBECK	BBHA 9120 D	9120D-969	Jan. 07, 2013	Jan. 06, 2014
HORN Antenna SCHWARZBECK	BBHA 9170	9170-480	Dec. 25, 2012	Dec. 24, 2013
Loop Antenna	HFH2-Z2	100070	Jan. 31, 2012	Jan. 30, 2014
Preamplifier EMCI	EMC 012645	980115	Dec. 28, 2012	Dec. 27, 2013
Preamplifier EMCI	EMC 184045	980116	Dec. 28, 2012	Dec. 27, 2013
Preamplifier EMCI	EMC 330H	980112	Dec. 28, 2012	Dec. 27, 2013
RF signal cable HUBER+SUHNNER	SUCOFLEX 104	309219/4	Oct. 18, 2013	Oct. 17, 2014
RF signal cable HUBER+SUHNNER	SUCOFLEX 104	250130/4	Oct. 18, 2013	Oct. 17, 2014
RF signal cable Worken	RG-213	NA	Dec. 29, 2012	Dec. 28, 2013
Software	E3 6.120103	NA	NA	NA
Antenna Tower MF	MFA-440H	NA	NA	NA
Turn Table MF	MFT-201SS	NA	NA	NA
Antenna Tower & Turn Table Controller MF	MF-7802	NA	NA	NA

- NOTE:**
1. The calibration interval of the above test instruments is 12 months and the calibrations are traceable to NML/ROC and NIST/USA.
  2. The calibration interval of the loop antenna is 24 months and the calibrations are traceable to NML/ROC and NIST/USA.
  3. The test was performed in HwaYa Chamber 10.
  4. The horn antenna and HP preamplifier (model: 8449B) are used only for the measurement of emission frequency above 1GHz if tested.
  5. The FCC Site Registration No. is 690701.
  6. The IC Site Registration No. is IC 7450F-10.

#### 4.1.3 TEST PROCEDURES

- a. The EUT was placed on the top of a rotating table 0.8 meters above the ground at a 3 meter semi-anechoic chamber. The table was rotated 360 degrees to determine the position of the highest radiation.
- b. The EUT was set 3 meters away from the interference-receiving antenna, which was mounted on the top of a variable-height antenna tower.
- c. The antenna is a broadband antenna, and its height is varied from one meter to four meters above the ground to determine the maximum value of the field strength. Both horizontal and vertical polarizations of the antenna are set to make the measurement.
- d. For each suspected emission, the EUT was arranged to its worst case and then the antenna was tuned to heights from 1 meter to 4 meters and the rotatable table was turned from 0 degrees to 360 degrees to find the maximum reading.
- e. The test-receiver system was set to Peak Detect Function and Specified Bandwidth with Maximum Hold Mode.
- f. If the emission level of the EUT in peak mode was lower than the limit specified, then testing could be stopped and the peak values of the EUT would be reported. Otherwise the emissions would be re-tested one by one using peak, quasi-peak or average method as specified and then reported in a data sheet.

**NOTE:**

1. The resolution bandwidth and video bandwidth of test receiver/spectrum analyzer is 120kHz for Quasi-peak detection at frequency below 1GHz.
2. The resolution bandwidth of test receiver/spectrum analyzer is 1 MHz and video bandwidth is 3MHz for Peak detection at frequency above 1GHz.
3. All modes of operation were investigated and the worst-case emissions are reported.

#### 4.1.4 DEVIATION FROM TEST STANDARD

No deviation.

#### 4.1.5 TEST SETUP

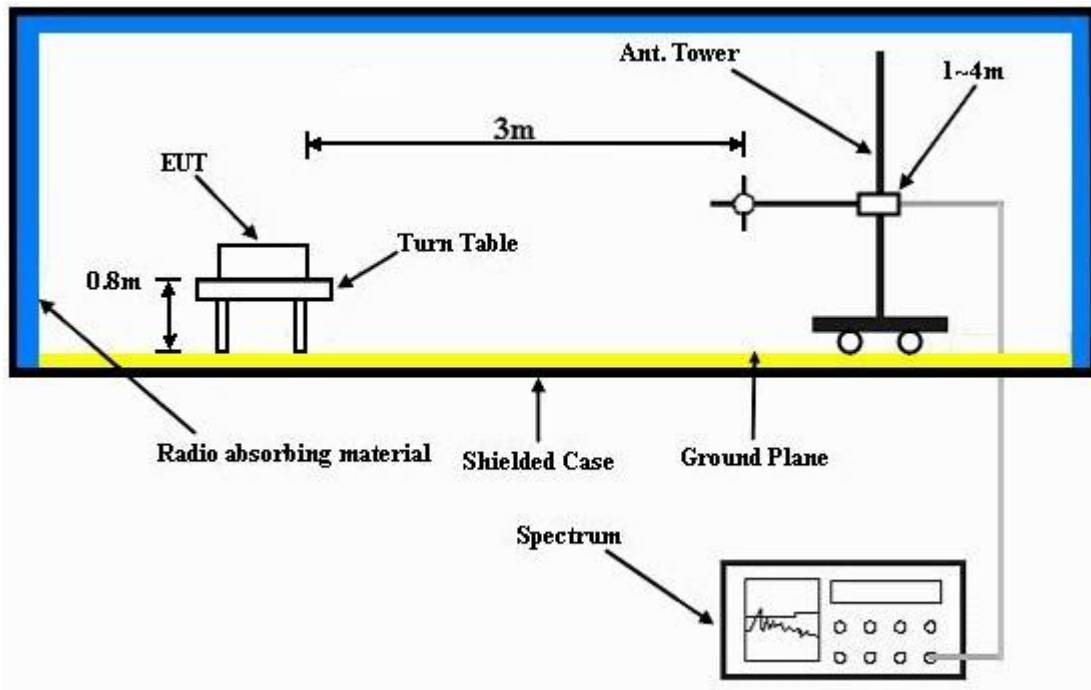

For the actual test configuration, please refer to the attached file (Test Setup Photo).

#### 4.1.6 EUT OPERATING CONDITIONS

- a. Placed the EUT on a testing table.
- b. Use the software to control the EUT under transmission condition continuously at specific channel frequency.

#### 4.1.7 TEST RESULTS

##### ABOVE 1GHz WORST-CASE DATA :

EUT TEST CONDITION		MEASUREMENT DETAIL	
CHANNEL	Channel 0	FREQUENCY RANGE	1GHz ~ 25GHz
INPUT POWER (SYSTEM)	120Vac, 60 Hz	DETECTOR FUNCTION	Peak (PK) Average (AV)
ENVIRONMENTAL CONDITIONS	25deg. C, 65%RH	TESTED BY	Johnson Liao

ANTENNA POLARITY & TEST DISTANCE: HORIZONTAL AT 3 M										
FREQ. (MHz)	EMISSION LEVEL (dBuV/m)	READ LEVEL (dBuV)	LIMIT (dBuV/m)	MARGIN (dB)	ANTENNA FACTOR (dB/m)	CABLE LOSS (dB)	PREAMP FACTOR (dB)	ANTENNA HEIGHT (cm)	TABLE ANGLE (Degree)	REMARK
2390	38.07	45.14	54	-15.93	26.91	3.54	37.52	100	230	Average
2390	52.57	59.64	74	-21.43	26.91	3.54	37.52	100	230	Peak
2402	91.01	98.08			26.91	3.54	37.52	100	230	Average
2402	106.36	113.43			26.91	3.54	37.52	100	230	Peak
2496	33.27	39.7	54	-20.73	27.2	3.62	37.25	100	230	Average
2496	50.18	56.61	74	-23.82	27.2	3.62	37.25	100	230	Peak
ANTENNA POLARITY & TEST DISTANCE: VERTICAL AT 3 M										
FREQ. (MHz)	EMISSION LEVEL (dBuV/m)	READ LEVEL (dBuV)	LIMIT (dBuV/m)	MARGIN (dB)	ANTENNA FACTOR (dB/m)	CABLE LOSS (dB)	PREAMP FACTOR (dB)	ANTENNA HEIGHT (cm)	TABLE ANGLE (Degree)	REMARK
2390	36.59	43.66	54	-17.41	26.91	3.54	37.52	114	192	Average
2390	51.3	58.37	74	-22.7	26.91	3.54	37.52	114	192	Peak
2402	88.96	96.03			26.91	3.54	37.52	114	192	Average
2402	103.71	110.78			26.91	3.54	37.52	114	192	Peak
2500	33.26	39.69	54	-20.74	27.2	3.62	37.25	114	192	Average
2500	50.02	56.45	74	-23.98	27.2	3.62	37.25	114	192	Peak

#### REMARKS:

- Emission Level = Read Level + Antenna Factor + Cable Loss - Preamp Factor  
Margin value = Emission level – Limit value
- 2402MHz: Fundamental frequency.





A D T

EUT TEST CONDITION		MEASUREMENT DETAIL	
CHANNEL	Channel 39	FREQUENCY RANGE	1GHz ~ 25GHz
INPUT POWER (SYSTEM)	120Vac, 60 Hz	DETECTOR FUNCTION	Peak (PK) Average (AV)
ENVIRONMENTAL CONDITIONS	25deg. C, 65%RH	TESTED BY	Johnson Liao

ANTENNA POLARITY & TEST DISTANCE: HORIZONTAL AT 3 M										
FREQ. (MHz)	EMISSION LEVEL (dBuV/m)	READ LEVEL (dBuV)	LIMIT (dBuV/m)	MARGIN (dB)	ANTENNA FACTOR (dB/m)	CABLE LOSS (dB)	PREAMP FACTOR (dB)	ANTENNA HEIGHT (cm)	TABLE ANGLE (Degree)	REMARK
2370	32.87	39.99	54	-21.13	26.86	3.52	37.5	100	229	Average
2370	49.84	56.96	74	-24.16	26.86	3.52	37.5	100	229	Peak
2441	91.34	98.09			27.06	3.58	37.39	100	229	Average
2441	106.99	113.74			27.06	3.58	37.39	100	229	Peak
2496	33.78	40.21	54	-20.22	27.2	3.62	37.25	100	229	Average
2496	50.27	56.7	74	-23.73	27.2	3.62	37.25	100	229	Peak
ANTENNA POLARITY & TEST DISTANCE: VERTICAL AT 3 M										
FREQ. (MHz)	EMISSION LEVEL (dBuV/m)	READ LEVEL (dBuV)	LIMIT (dBuV/m)	MARGIN (dB)	ANTENNA FACTOR (dB/m)	CABLE LOSS (dB)	PREAMP FACTOR (dB)	ANTENNA HEIGHT (cm)	TABLE ANGLE (Degree)	REMARK
2340	32.65	39.87	54	-21.35	26.77	3.5	37.49	114	192	Average
2340	50.11	57.33	74	-23.89	26.77	3.5	37.49	114	192	Peak
2441	89.32	96.07			27.06	3.58	37.39	114	192	Average
2441	104.4	111.15			27.06	3.58	37.39	114	192	Peak
2488	33.49	39.99	54	-20.51	27.2	3.62	37.32	114	192	Average
2488	49.88	56.38	74	-24.12	27.2	3.62	37.32	114	192	Peak

**REMARKS:**

- Emission Level = Read Level + Antenna Factor + Cable Loss - Preamp Factor  
Margin value = Emission level – Limit value
- 2441MHz: Fundamental frequency.

EUT TEST CONDITION		MEASUREMENT DETAIL	
CHANNEL	Channel 78	FREQUENCY RANGE	1GHz ~ 25GHz
INPUT POWER (SYSTEM)	120Vac, 60 Hz	DETECTOR FUNCTION	Peak (PK) Average (AV)
ENVIRONMENTAL CONDITIONS	25deg. C, 65%RH	TESTED BY	Johnson Liao

ANTENNA POLARITY & TEST DISTANCE: HORIZONTAL AT 3 M										
FREQ. (MHz)	EMISSION LEVEL (dBuV/m)	READ LEVEL (dBuV)	LIMIT (dBuV/m)	MARGIN (dB)	ANTENNA FACTOR (dB/m)	CABLE LOSS (dB)	PREAMP FACTOR (dB)	ANTENNA HEIGHT (cm)	TABLE ANGLE (Degree)	REMARK
2330	32.63	39.9	54	-21.37	26.72	3.48	37.47	100	234	Average
2330	49.49	56.76	74	-24.51	26.72	3.48	37.47	100	234	Peak
2480	91.62	98.19			27.15	3.6	37.32	100	234	Average
2480	107.19	113.76			27.15	3.6	37.32	100	234	Peak
2484	44.22	50.79	54	-9.78	27.15	3.6	37.32	100	234	Average
2484	65.41	71.98	74	-8.59	27.15	3.6	37.32	100	234	Peak
ANTENNA POLARITY & TEST DISTANCE: VERTICAL AT 3 M										
FREQ. (MHz)	EMISSION LEVEL (dBuV/m)	READ LEVEL (dBuV)	LIMIT (dBuV/m)	MARGIN (dB)	ANTENNA FACTOR (dB/m)	CABLE LOSS (dB)	PREAMP FACTOR (dB)	ANTENNA HEIGHT (cm)	TABLE ANGLE (Degree)	REMARK
2366	32.58	39.75	54	-21.42	26.81	3.52	37.5	107	142	Average
2366	49.62	56.79	74	-24.38	26.81	3.52	37.5	107	142	Peak
2480	89.12	95.69			27.15	3.6	37.32	107	142	Average
2480	104.2	110.77			27.15	3.6	37.32	107	142	Peak
2484	39.02	45.59	54	-14.98	27.15	3.6	37.32	107	142	Average
2484	62.55	69.12	74	-11.45	27.15	3.6	37.32	107	142	Peak

**REMARKS:**

- Emission Level = Read Level + Antenna Factor + Cable Loss - Preamp Factor  
Margin value = Emission level – Limit value
- 2480MHz: Fundamental frequency.

**BELOW 1GHz WORST-CASE DATA : GFSK  
MODE A**

EUT TEST CONDITION		MEASUREMENT DETAIL	
CHANNEL	Channel 78	FREQUENCY RANGE	30MHz ~ 1GHz
INPUT POWER (SYSTEM)	120Vac, 60 Hz	DETECTOR FUNCTION	Peak (PK)
ENVIRONMENTAL CONDITIONS	25deg. C, 65%RH	TESTED BY	Anson Lin

ANTENNA POLARITY & TEST DISTANCE: HORIZONTAL AT 3 M										
FREQ. (MHz)	EMISSION LEVEL (dBuV/m)	READ LEVEL (dBuV)	LIMIT (dBuV/m)	MARGIN (dB)	ANTENNA FACTOR (dB/m)	CABLE LOSS (dB)	PREAMP FACTOR (dB)	ANTENNA HEIGHT (cm)	TABLE ANGLE (Degree)	REMARK
40.53	19.69	36.49	40	-20.31	13.55	0.67	31.02	100	158	Peak
137.46	27.33	45.53	43.5	-16.17	12.21	1.28	31.69	100	236	Peak
236.28	31.45	50.57	46	-14.55	10.91	1.77	31.8	100	119	Peak
372.1	22.4	37.33	46	-23.6	14.68	2.32	31.93	100	159	Peak
640.2	24.76	33.55	46	-21.24	20.09	3.21	32.09	100	237	Peak
838.3	26.43	31.71	46	-19.57	22.71	3.79	31.78	100	228	Peak
ANTENNA POLARITY & TEST DISTANCE: VERTICAL AT 3 M										
FREQ. (MHz)	EMISSION LEVEL (dBuV/m)	READ LEVEL (dBuV)	LIMIT (dBuV/m)	MARGIN (dB)	ANTENNA FACTOR (dB/m)	CABLE LOSS (dB)	PREAMP FACTOR (dB)	ANTENNA HEIGHT (cm)	TABLE ANGLE (Degree)	REMARK
30.54	30.28	48.69	40	-9.72	12.14	0.57	31.12	100	229	Peak
132.6	30.26	48.93	43.5	-13.24	11.88	1.26	31.81	100	230	Peak
226.29	31.35	50.97	46	-14.65	10.46	1.72	31.8	100	118	Peak
390.3	19.84	34.4	46	-26.16	15.1	2.38	32.04	100	326	Peak
552	22.83	33.35	46	-23.17	18.5	2.95	31.97	100	141	Peak
710.2	24.58	31.9	46	-21.42	20.96	3.46	31.74	100	224	Peak



A D T

**MODE B**

EUT TEST CONDITION		MEASUREMENT DETAIL	
CHANNEL	Channel 78	FREQUENCY RANGE	30MHz ~ 1GHz
INPUT POWER (SYSTEM)	120Vac, 60 Hz	DETECTOR FUNCTION	Peak (PK)
ENVIRONMENTAL CONDITIONS	25deg. C, 65%RH	TESTED BY	Johnson Liao

ANTENNA POLARITY & TEST DISTANCE: HORIZONTAL AT 3 M										
FREQ. (MHz)	EMISSION LEVEL (dBuV/m)	READ LEVEL (dBuV)	LIMIT (dBuV/m)	MARGIN (dB)	ANTENNA FACTOR (dB/m)	CABLE LOSS (dB)	PREAMP FACTOR (dB)	ANTENNA HEIGHT (cm)	TABLE ANGLE (Degree)	REMARK
80.49	29.86	52.27	40	-10.14	8.13	0.97	31.51	100	158	Peak
146.37	36.5	54.21	43.5	-7	12.58	1.33	31.62	100	265	Peak
216.3	34.52	54.46	46	-11.48	10.05	1.67	31.66	110	236	Peak
370	24.54	39.52	46	-21.46	14.63	2.31	31.92	100	210	Peak
621.3	25.17	34.31	46	-20.83	19.87	3.15	32.16	100	254	Peak
797.7	26.97	32.51	46	-19.03	22.19	3.69	31.42	100	227	Peak
ANTENNA POLARITY & TEST DISTANCE: VERTICAL AT 3 M										
FREQ. (MHz)	EMISSION LEVEL (dBuV/m)	READ LEVEL (dBuV)	LIMIT (dBuV/m)	MARGIN (dB)	ANTENNA FACTOR (dB/m)	CABLE LOSS (dB)	PREAMP FACTOR (dB)	ANTENNA HEIGHT (cm)	TABLE ANGLE (Degree)	REMARK
32.97	33.26	51.3	40	-6.74	12.47	0.58	31.09	100	207	Peak
39.45	33.32	50.12	40	-6.68	13.54	0.65	30.99	100	193	Peak
236.28	35.34	54.46	46	-10.66	10.91	1.77	31.8	100	114	Peak
300.7	21.27	38.11	46	-24.73	12.96	2.05	31.85	100	239	Peak
370	20.43	35.41	46	-25.57	14.63	2.31	31.92	100	187	Peak
572.3	23.33	33.44	46	-22.67	18.97	3.01	32.09	100	175	Peak

## 4.2 CONDUCTED EMISSION MEASUREMENT

### 4.2.1 LIMITS OF CONDUCTED EMISSION MEASUREMENT

FREQUENCY OF EMISSION (MHz)	CONDUCTED LIMIT (dB $\mu$ V)	
	Quasi-peak	Average
0.15 ~ 0.5	66 to 56	56 to 46
0.5 ~ 5	56	46
5 ~ 30	60	50

- NOTE:**
1. The lower limit shall apply at the transition frequencies.
  2. The limit decreases in line with the logarithm of the frequency in the range of 0.15 to 0.50 MHz.
  3. All emanations from a class A/B digital device or system, including any network of conductors and apparatus connected thereto, shall not exceed the level of field strengths specified above.

### 4.2.2 TEST INSTRUMENTS

DESCRIPTION & MANUFACTURER	MODEL NO.	SERIAL NO.	DATE OF CALIBRATION	DUE DATE OF CALIBRATION
Test Receiver ROHDE & SCHWARZ	ESCS30	100290	Dec. 24, 2012	Dec. 23, 2013
RF signal cable Woken	5D-FB	Cable-HYC01-01	Dec. 28, 2012	Dec. 27, 2013
LISN ROHDE & SCHWARZ (EUT)	ESH2-Z5	100312	Jul. 02, 2013	Jul. 01, 2014
LISN ROHDE & SCHWARZ (Peripheral)	ESH3-Z5	835239/001	Feb. 04, 2013	Feb. 03, 2014
Software ADT	BV ADT_Cond_ V7.3.7.3	NA	NA	NA

- NOTE:**
1. The calibration interval of the above test instruments is 12 months and the calibrations are traceable to NML/ROC and NIST/USA.
  2. The test was performed in HwaYa Shielded Room 2.
  3. The VCCI Site Registration No. is C-2047.

#### 4.2.3 TEST PROCEDURES

- a. The EUT was placed 0.4 meters from the conducting wall of the shielded room with EUT being connected to the power mains through a line impedance stabilization network (LISN). Other support units were connected to the power mains through another LISN. The two LISNs provide 50 ohm/ 50uH of coupling impedance for the measuring instrument.
- b. Both lines of the power mains connected to the EUT were checked for maximum conducted interference.
- c. The frequency range from 150kHz to 30MHz was searched. Emission levels under (Limit - 20dB) was not recorded.

**NOTE:** All modes of operation were investigated and the worst-case emissions are reported.

#### 4.2.4 DEVIATION FROM TEST STANDARD

No deviation.

#### 4.2.5 TEST SETUP

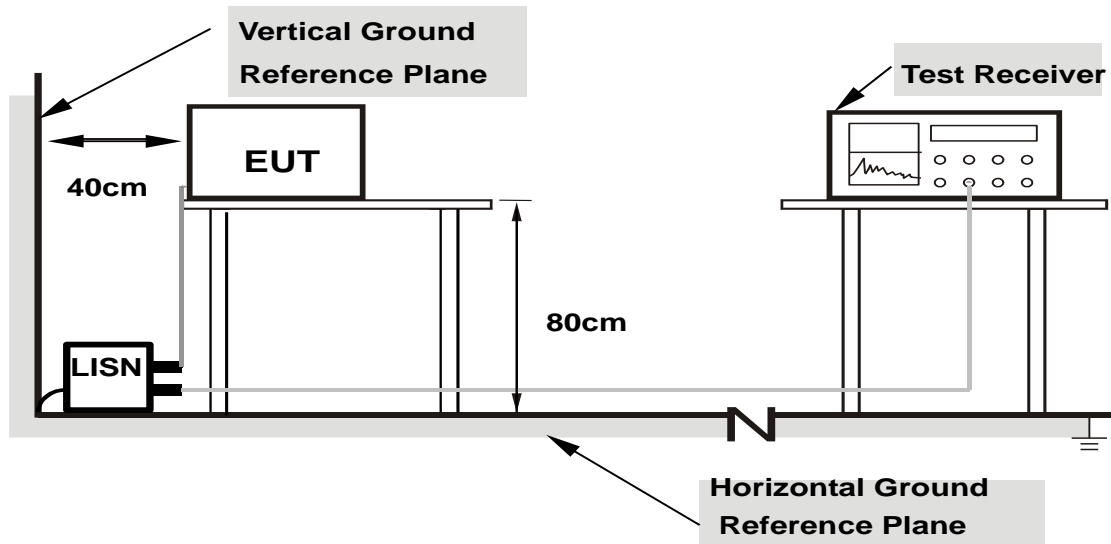

- Note: 1.Support units were connected to second LISN.  
 2.Both of LISNs (AMN) are 80 cm from EUT and at least 80 from other units and other metal planes**

For the actual test configuration, please refer to the attached file (Test Setup Photo).

#### 4.2.6 EUT OPERATING CONDITIONS

Same as 4.1.6

## 4.2.7 TEST RESULTS

### CONDUCTED WORST CASE DATA:

#### MODE A

PHASE	Line 1	6dB BANDWIDTH	9kHz
-------	--------	---------------	------

No	Freq. [MHz]	Corr. Factor (dB)	Reading Value [dB (uV)]		Emission Level [dB (uV)]		Limit [dB (uV)]		Margin (dB)	
			Q.P.	AV.	Q.P.	AV.	Q.P.	AV.	Q.P.	AV.
			1	0.16953	0.17	3.87	-0.73	4.04	-0.56	64.98
2	0.83750	0.25	22.04	17.07	22.29	17.32	56.00	46.00	-33.71	-28.68
3	1.69922	0.28	7.32	4.30	7.60	4.58	56.00	46.00	-48.40	-41.42
4	4.37891	0.37	-7.74	-9.85	-7.37	-9.48	56.00	46.00	-63.37	-55.48
5	7.52734	0.41	-7.38	-9.36	-6.97	-8.95	60.00	50.00	-66.97	-58.95
6	17.73438	0.59	-7.31	-9.66	-6.72	-9.07	60.00	50.00	-66.72	-59.07

#### REMARKS:

1. Q.P. and AV. are abbreviations of quasi-peak and average individually.
2. The emission levels of other frequencies were very low against the limit.
3. Margin value = Emission level - Limit value
4. Correction factor = Insertion loss + Cable loss
5. Emission Level = Correction Factor + Reading Value.

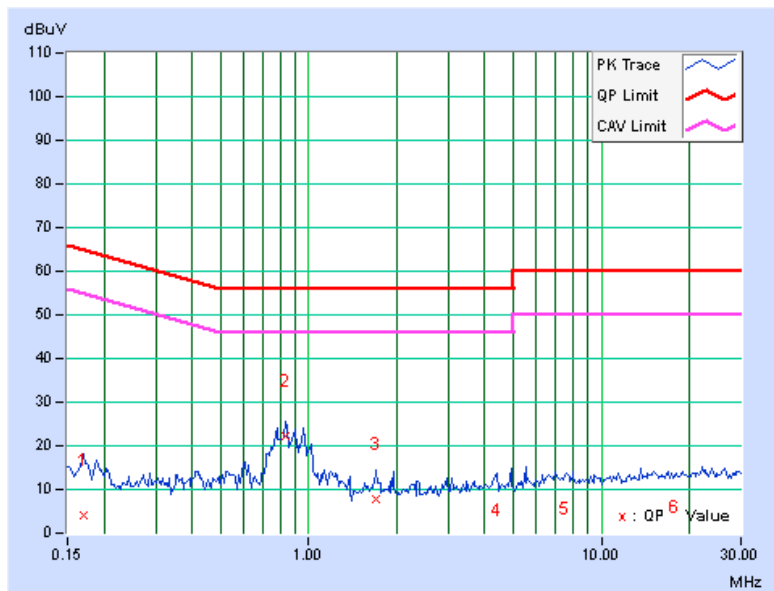



PHASE	Line 2	6dB BANDWIDTH	9kHz
-------	--------	---------------	------

No	Freq. [MHz]	Corr. Factor (dB)	Reading Value [dB (uV)]		Emission Level [dB (uV)]		Limit [dB (uV)]		Margin (dB)	
			Q.P.	AV.	Q.P.	AV.	Q.P.	AV.	Q.P.	AV.
			1	0.18906	0.18	4.77	0.03	4.95	0.21	64.08
2	0.83750	0.24	22.08	17.03	22.32	17.27	56.00	46.00	-33.68	-28.73
3	1.89063	0.27	-2.13	-5.17	-1.86	-4.90	56.00	46.00	-57.86	-50.90
4	4.16406	0.39	-8.49	-10.28	-8.10	-9.89	56.00	46.00	-64.10	-55.89
5	7.79688	0.45	-7.24	-9.33	-6.79	-8.88	60.00	50.00	-66.79	-58.88
6	17.04297	0.66	-7.17	-9.50	-6.51	-8.84	60.00	50.00	-66.51	-58.84

**REMARKS:**

1. Q.P. and AV. are abbreviations of quasi-peak and average individually.
2. The emission levels of other frequencies were very low against the limit.
3. Margin value = Emission level - Limit value
4. Correction factor = Insertion loss + Cable loss
5. Emission Level = Correction Factor + Reading Value.

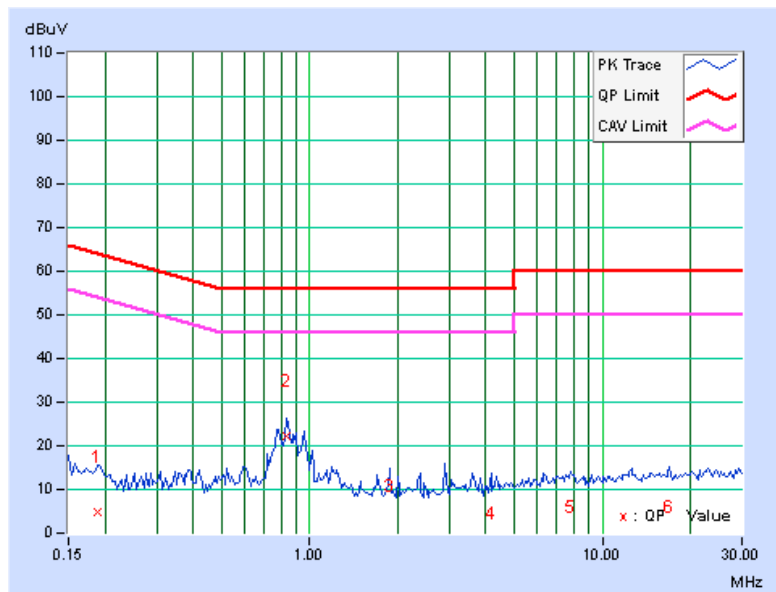

**MODE B**

<b>PHASE</b>	Line 1	<b>6dB BANDWIDTH</b>	9kHz
--------------	--------	----------------------	------

No	Freq. [MHz]	Corr. Factor (dB)	Reading Value		Emission Level		Limit		Margin	
			[dB (uV)]		[dB (uV)]		[dB (uV)]		(dB)	
			Q.P.	AV.	Q.P.	AV.	Q.P.	AV.	Q.P.	AV.
1	0.40000	0.21	34.45	31.90	34.66	32.11	57.85	47.85	-23.19	-15.74
2	0.61094	0.23	27.61	14.58	27.84	14.81	56.00	46.00	-28.16	-31.19
3	1.33203	0.27	19.61	7.75	19.88	8.02	56.00	46.00	-36.12	-37.98
4	2.55859	0.31	20.69	7.95	21.00	8.26	56.00	46.00	-35.00	-37.74
5	8.49219	0.41	23.43	14.63	23.84	15.04	60.00	50.00	-36.16	-34.96
6	27.66016	0.55	18.97	9.76	19.52	10.31	60.00	50.00	-40.48	-39.69

**REMARKS:**

1. Q.P. and AV. are abbreviations of quasi-peak and average individually.
2. The emission levels of other frequencies were very low against the limit.
3. Margin value = Emission level - Limit value
4. Correction factor = Insertion loss + Cable loss
5. Emission Level = Correction Factor + Reading Value.

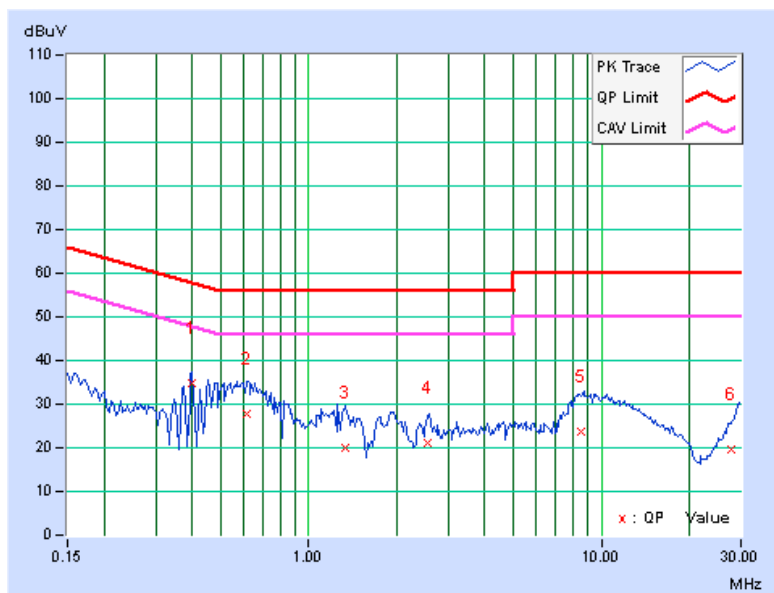

PHASE	Line 2	6dB BANDWIDTH	9kHz
-------	--------	---------------	------

No	Freq. [MHz]	Corr. Factor (dB)	Reading Value [dB (uV)]		Emission Level [dB (uV)]		Limit [dB (uV)]		Margin (dB)	
			Q.P.	AV.	Q.P.	AV.	Q.P.	AV.	Q.P.	AV.
			1	0.41563	0.25	36.99	33.89	37.24	34.14	57.54
2	0.65781	0.24	21.38	14.45	21.62	14.69	56.00	46.00	-34.38	-31.31
3	1.21484	0.24	19.23	14.42	19.47	14.66	56.00	46.00	-36.53	-31.34
4	4.01563	0.39	16.20	9.71	16.59	10.10	56.00	46.00	-39.41	-35.90
5	8.58594	0.46	23.46	16.77	23.92	17.23	60.00	50.00	-36.08	-32.77
6	15.05859	0.61	17.30	9.40	17.91	10.01	60.00	50.00	-42.09	-39.99

**REMARKS:**

1. Q.P. and AV. are abbreviations of quasi-peak and average individually.
2. The emission levels of other frequencies were very low against the limit.
3. Margin value = Emission level - Limit value
4. Correction factor = Insertion loss + Cable loss
5. Emission Level = Correction Factor + Reading Value.

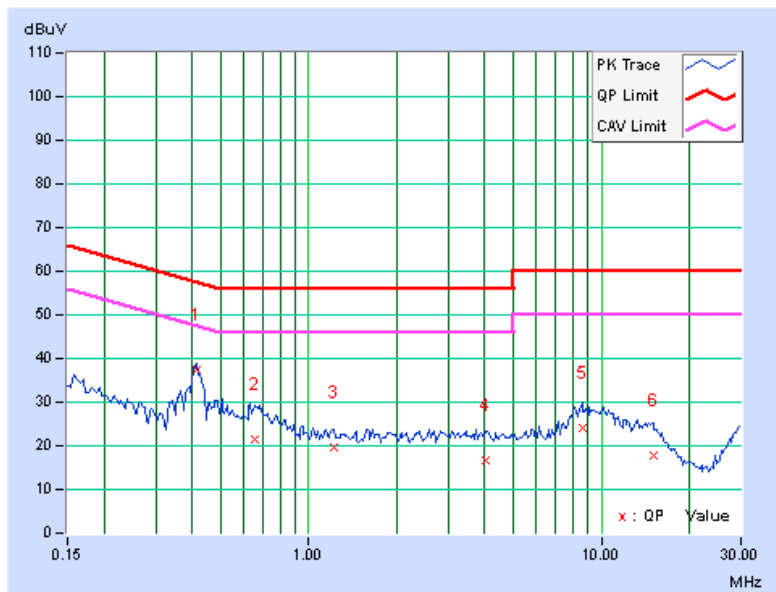

### 4.3 NUMBER OF HOPPING FREQUENCY USED

#### 4.3.1 LIMIT OF HOPPING FREQUENCY USED

At least 15 channels frequencies, and should be equally spaced.

#### 4.3.2 TEST SETUP

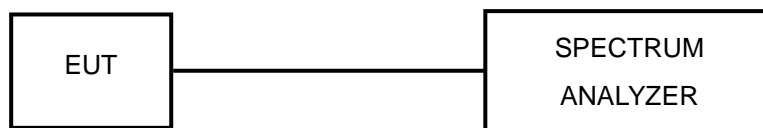

#### 4.3.3 TEST INSTRUMENTS

Refer to section 4.1.2 to get information of above instrument.

#### 4.3.4 TEST PROCEDURES

- a. Check the calibration of the measuring instrument (SA) using either an internal calibrator or a known signal from an external generator.
- b. Turn on the EUT and connect its antenna terminal to measurement via a low loss cable. Then set it to any one measured frequency within its operating range and make sure the instrument is operated in its linear range.
- c. Set the SA on MaxHold Mode, and then keep the EUT in hopping mode. Record all the signals from each channel until each one has been recorded.
- d. Set the SA on View mode and then plot the result on SA screen.
- e. Repeat above procedures until all frequencies measured were complete.

#### 4.3.5 DEVIATION FROM TEST STANDARD

No deviation.

#### 4.3.6 TEST RESULTS

There are 79 hopping frequencies in the hopping mode. Please refer to next page for the test result. On the plot, it shows that the hopping frequencies are equally spaced.



A D T

### $\pi/4$ -DQPSK

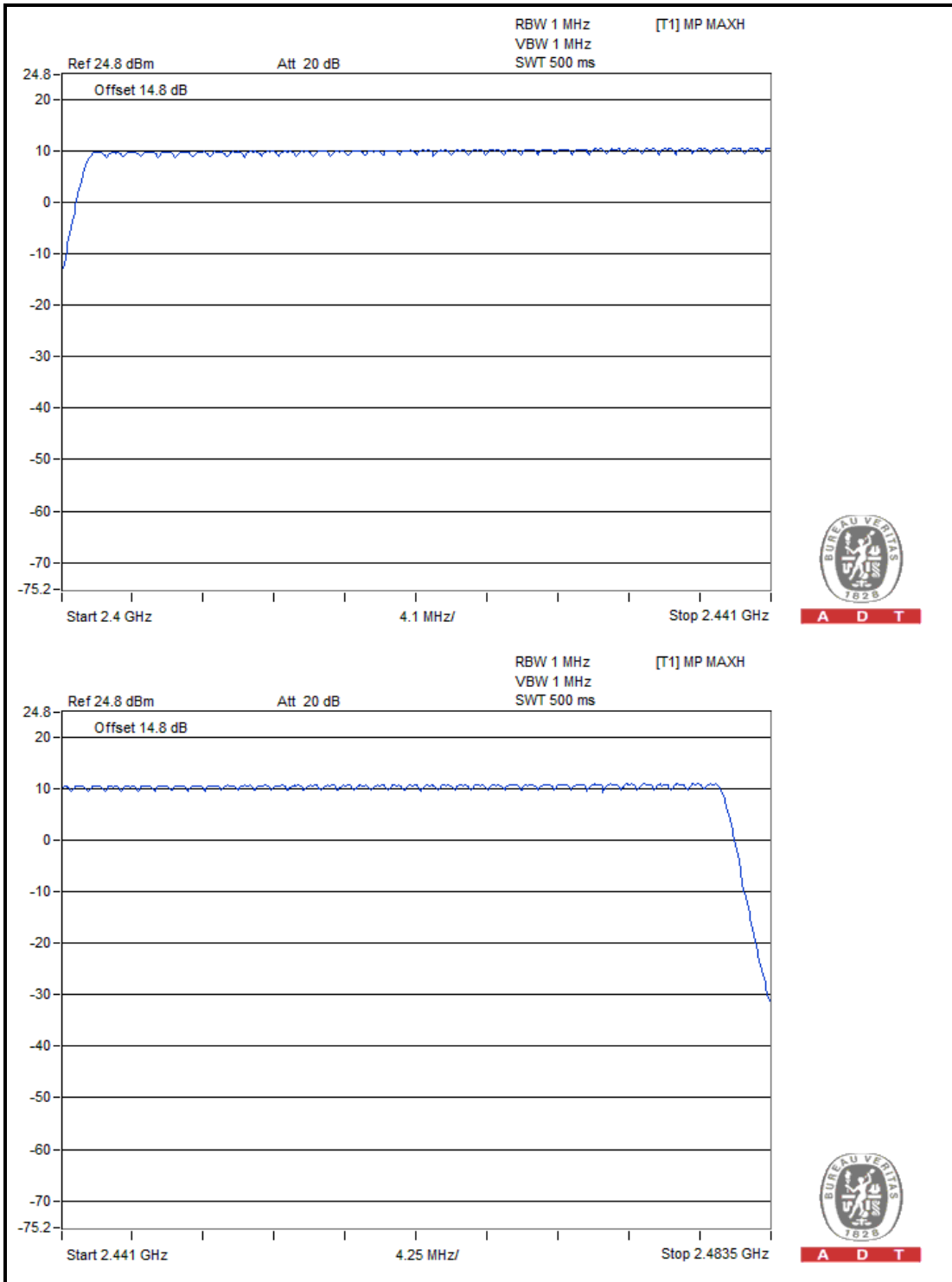

A D T



A D T

## 4.4 DWELL TIME ON EACH CHANNEL

### 4.4.1 LIMIT OF DWELL TIME USED

The average time of occupancy on any channel shall not be greater than 0.4 seconds within a period of 0.4 seconds multiplied by the number of hopping channels employed.

### 4.4.2 TEST SETUP

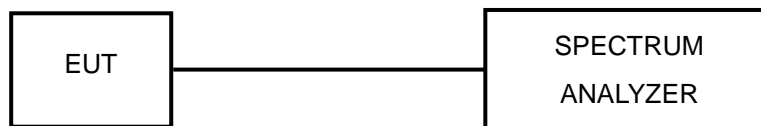

### 4.4.3 TEST INSTRUMENTS

Refer to section 4.1.2 to get information of above instrument.

### 4.4.4 TEST PROCEDURES

- a. Check the calibration of the measuring instrument (SA) using either an internal calibrator or a known signal from an external generator.
- b. Turn on the EUT and connect its antenna terminal to measurement via a low loss cable. Then set it to any one measured frequency within its operating range and make sure the instrument is operated in its linear range.
- c. Adjust the center frequency of SA on any frequency be measured and set SA to zero span mode. And then, set RBW and VBW of spectrum analyzer to proper value.
- d. Measure the time duration of one transmission on the measured frequency. And then plot the result with time difference of this time duration.
- e. Repeat above procedures until all different time-slot modes have been completed.

### 4.4.5 DEVIATION FROM TEST STANDARD

No deviation.

### 4.4.6 TEST RESULTS

#### GFSK

Mode	Average Hopping Channel	Package Transfer Time (usec)	Result (sec)	Limit (sec)
DH1	9.20	493.59	0.14	0.4
DH3	4.60	1754.81	0.26	0.4
DH5	3.60	3004.81	0.34	0.4

**NOTE:**

1. Dwell Time=79(channels) x 0.4(s) x average hopping channel x package transfer time
2. 79 channels come from the Hopping Channel number
3. Average Hopping Channel = hops/sweep time
4. t: Package Transfer Time(us)
5. Test plots of the transmitting time slot are shown as below.

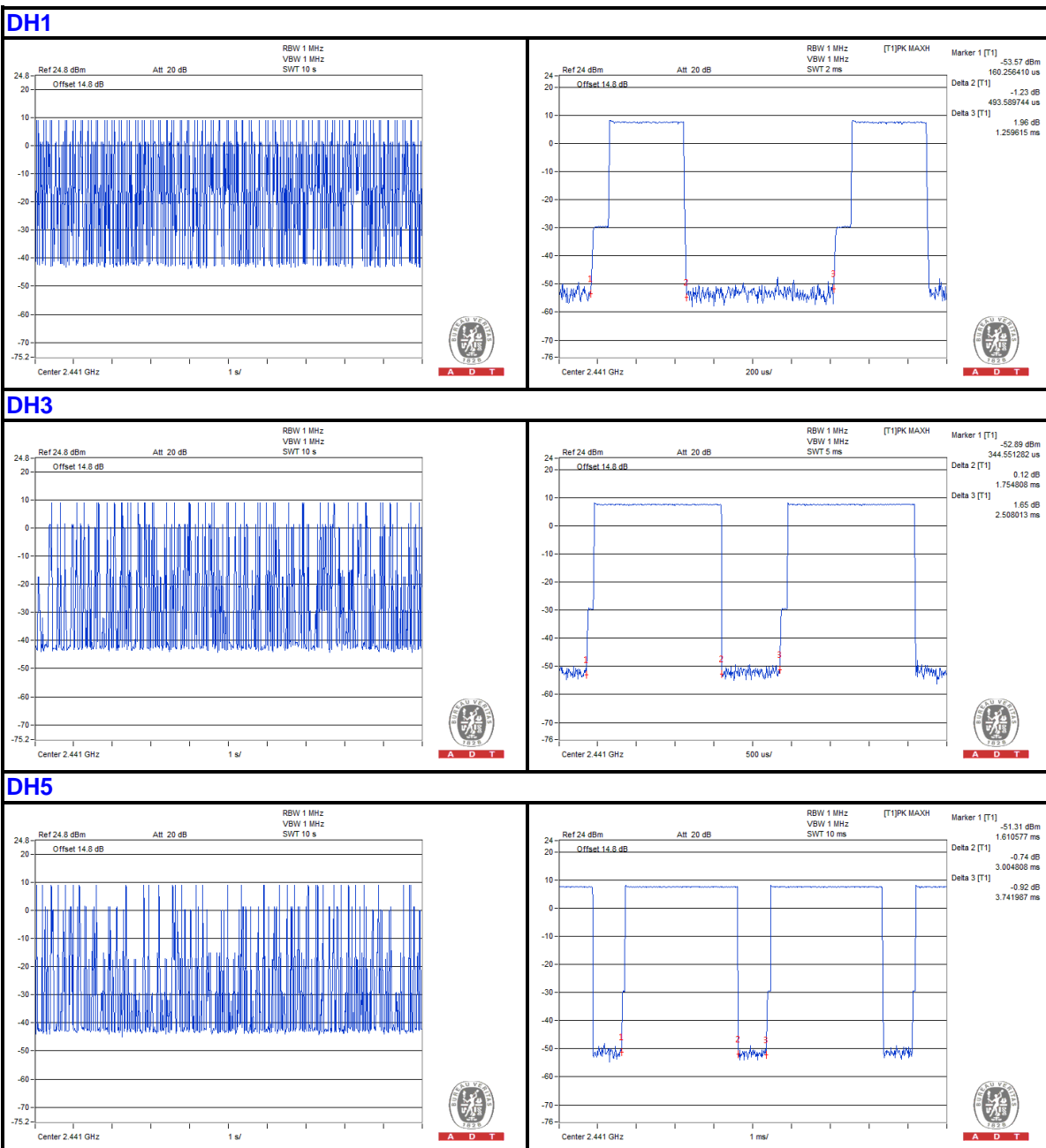

**$\pi/4$ -DQPSK**

Mode	Average Hopping Channel	Package Transfer Time (usec)	Result (sec)	Limit (sec)
DH1	8.90	498.40	0.14	0.4
DH3	4.70	1761.22	0.26	0.4
DH5	3.30	3035.26	0.32	0.4

**NOTE:**

1. Dwell Time=79(channels) x 0.4(s) x average hopping channel x package transfer time
2. 79 channels come from the Hopping Channel number
3. Average Hopping Channel = hops/sweep time
4. t: Package Transfer Time(us)
5. Test plots of the transmitting time slot are shown as below.

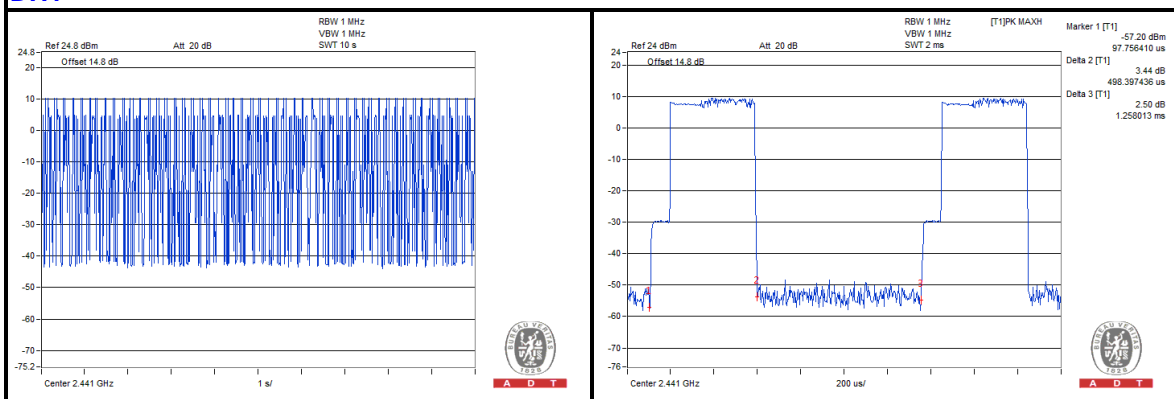
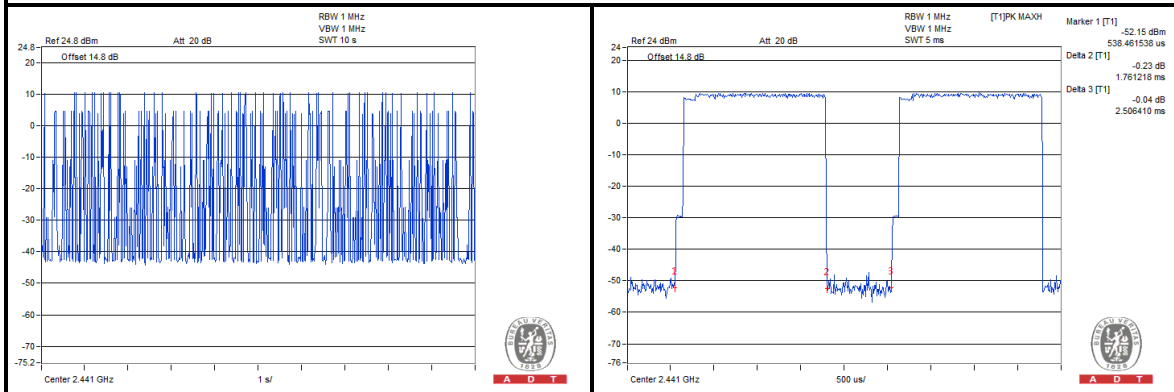
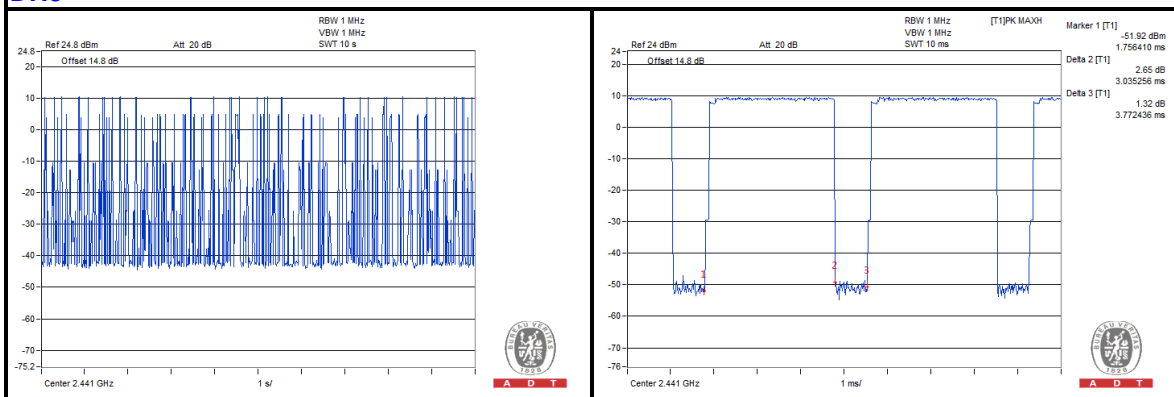
**DH1**

**DH3**

**DH5**



8DPSK

Mode	Average Hopping Channel	Package Transfer Time (usec)	Result (sec)	Limit (sec)
DH1	8.80	496.79	0.14	0.4
DH3	4.30	1762.82	0.24	0.4
DH5	3.60	3036.86	0.35	0.4

NOTE:

1. Dwell Time=79(channels) x 0.4(s) x average hopping channel x package transfer time
2. 79 channels come from the Hopping Channel number
3. Average Hopping Channel = hops/sweep time
4. t: Package Transfer Time(us)
5. Test plots of the transmitting time slot are shown as below.

DH1

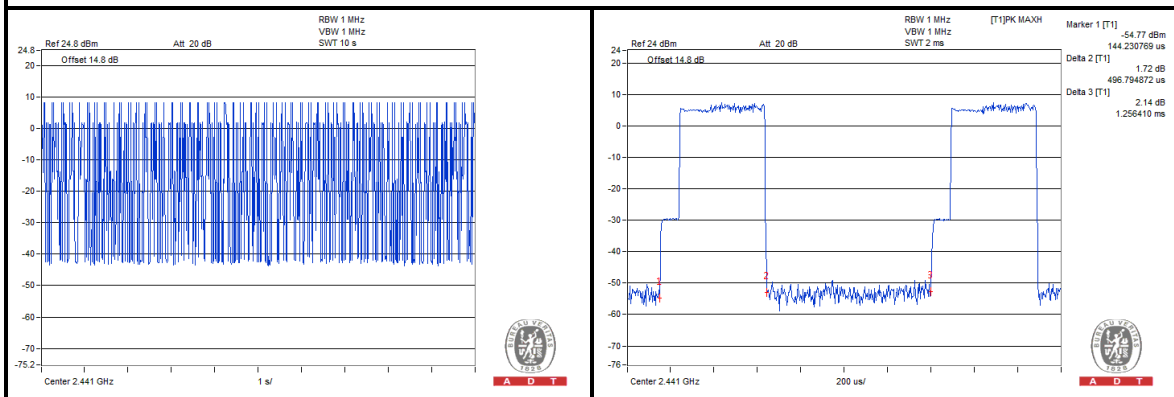

DH3

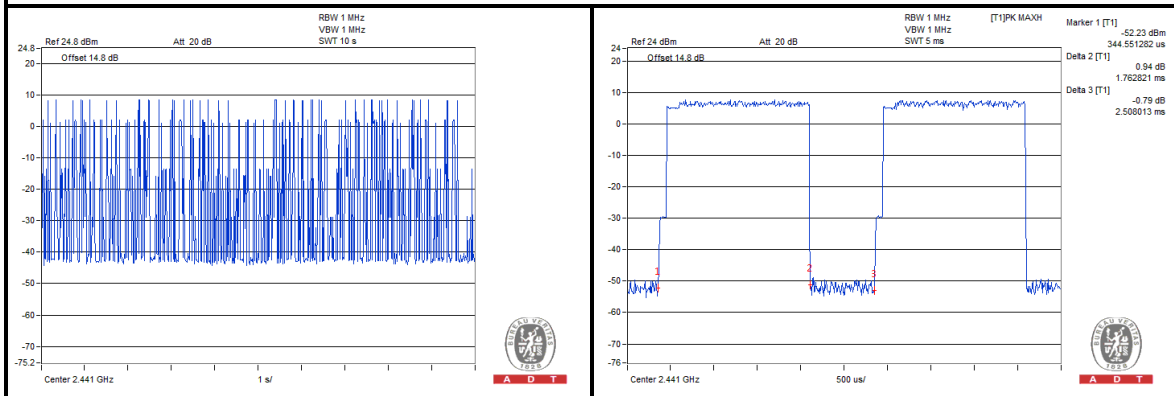

DH5

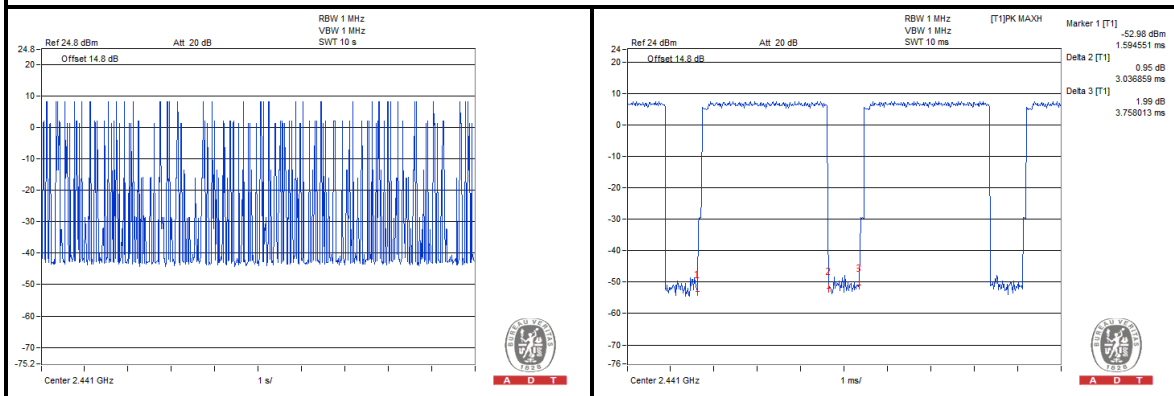

## 4.5 CHANNEL BANDWIDTH

### 4.5.1 LIMITS OF CHANNEL BANDWIDTH

For frequency hopping system operating in the 2400-2483.5MHz, If the 20dB bandwidth of hopping channel is greater than 25kHz, two-thirds 20dB bandwidth of hopping channel shall be a minimum limit for the hopping channel separation.

### 4.5.2 TEST SETUP

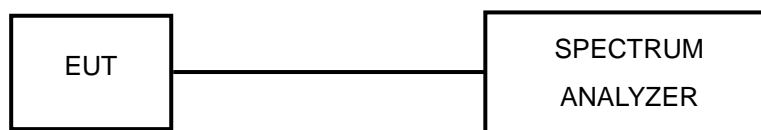

### 4.5.3 TEST INSTRUMENTS

Refer to section 4.1.2 to get information of above instrument.

### 4.5.4 TEST PROCEDURE

- a. Check the calibration of the measuring instrument using either an internal calibrator or a known signal from an external generator.
- b. Turn on the EUT and connect it to measurement instrument. Then set it to any one convenient frequency within its operating range. Set a reference level on the measuring instrument equal to the highest peak value.
- c. Measure the frequency difference of two frequencies that were attenuated 20dB from the reference level. Record the frequency difference as the emission bandwidth.
- d. Repeat above procedures until all frequencies measured were complete.

### 4.5.5 DEVIATION FROM TEST STANDARD

No deviation.

### 4.5.6 EUT OPERATING CONDITION

The software provided by client enabled the EUT to transmit and receive data at lowest, middle and highest channel frequencies individually.

### 4.5.7 TEST RESULTS

CHANNEL	FREQUENCY (MHz)	20dB BANDWIDTH (MHz)		
		GFSK	$\pi/4$ -DQPSK	8DPSK
0	2402	1.01	1.33	1.28
39	2441	1.02	1.34	1.28
78	2480	1.02	1.34	1.28

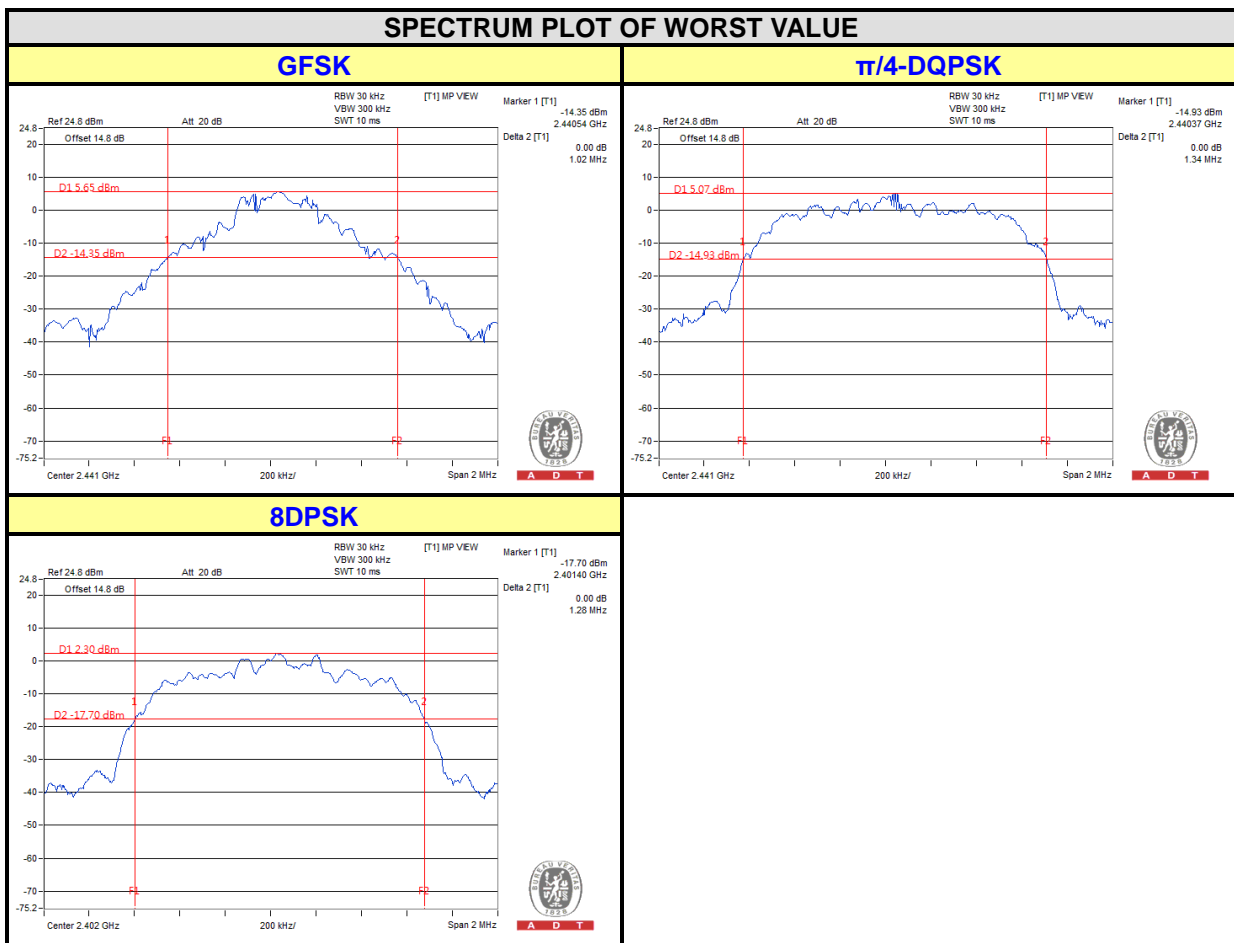

## 4.6 HOPPING CHANNEL SEPARATION

### 4.6.1 LIMIT OF HOPPING CHANNEL SEPARATION

At least 25kHz or two-third of 20dB hopping channel bandwidth (whichever is greater).

### 4.6.2 TEST SETUP

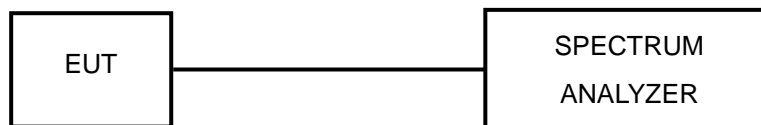

### 4.6.3 TEST INSTRUMENTS

Refer to section 4.1.2 to get information of above instrument.

### 4.6.4 TEST PROCEDURES

1. Check the calibration of the measuring instrument using either an internal calibrator or a known signal from an external generator.
2. Turn on the EUT and connect it to measurement instrument. Then set it to any one convenient frequency within its operating range.
3. By using the MaxHold function record the separation of two adjacent channels.
4. Measure the frequency difference of these two adjacent channels by SA MARK function. And then plot the result on SA screen.
5. Repeat above procedures until all frequencies measured were complete.

### 4.6.5 DEVIATION FROM TEST STANDARD

No deviation.

### 4.6.6 TEST RESULTS

CHAN.	FREQ. (MHz)	ADJACENT CHANNEL SEPARATION (MHz)			20dB BANDWIDTH (MHz)			MINIMUM LIMIT (MHz)			PASS / FAIL
		GFSK	$\pi/4$ -DQPSK	8DPSK	GFSK	$\pi/4$ -DQPSK	8DPSK	GFSK	$\pi/4$ -DQPSK	8DPSK	
0	2402	1.00	1.00	1.00	1.01	1.33	1.28	0.673	0.887	0.853	PASS
39	2441	1.00	1.00	1.00	1.02	1.34	1.28	0.680	0.893	0.853	PASS
78	2480	1.01	1.00	1.01	1.02	1.34	1.28	0.680	0.893	0.853	PASS

**NOTE:** The minimum limit is two-third 20dB bandwidth.

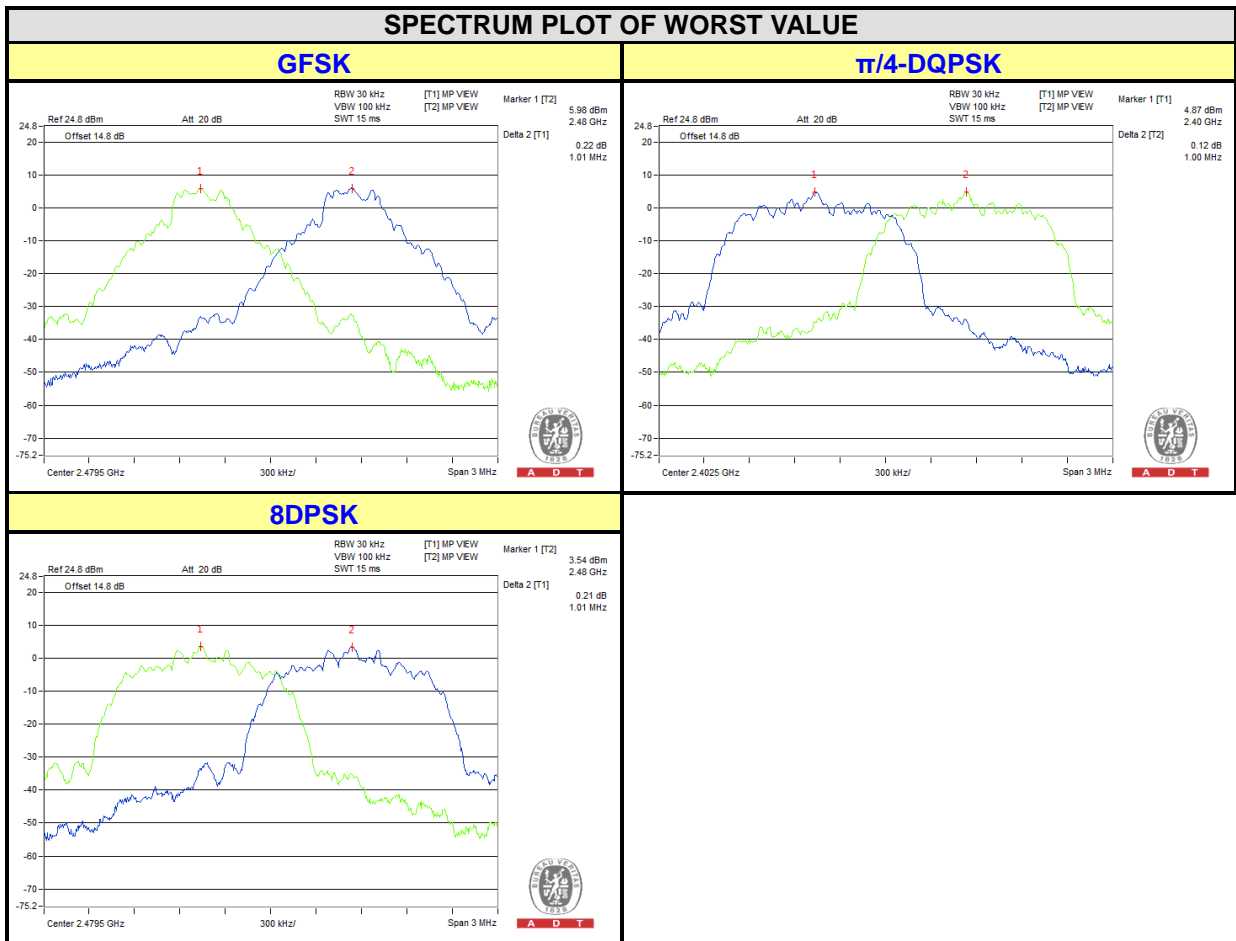

## 4.7 MAXIMUM OUTPUT POWER

### 4.7.1 LIMITS OF MAXIMUM OUTPUT POWER MEASUREMENT

The Maximum Output Power Measurement is 125mW.

### 4.7.2 TEST SETUP

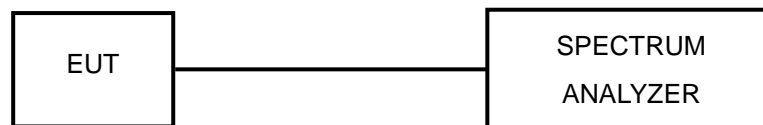

### 4.7.3 TEST INSTRUMENTS

Refer to section 4.1.2 to get information of above instrument.

### 4.7.4 TEST PROCEDURES

- a. Check the calibration of the measuring instrument using either an internal calibrator or a known signal from an external generator.
- b. Turn on the EUT and connect it to measurement instrument. Then set it to any one convenient frequency within its operating range. Set a reference level on the measuring instrument equal to the highest peak value.
- c. The center frequency of the spectrum analyzer is set to the fundamental frequency and using 3MHz RBW and 10 MHz VBW.
- d. Measure the captured power within the band and recording the plot.
- e. Repeat above procedures until all frequencies required were complete.

### 4.7.5 DEVIATION FROM TEST STANDARD

No deviation.

### 4.7.6 EUT OPERATING CONDITION

The software provided by client enabled the EUT to transmit and receive data at lowest, middle and highest channel frequencies individually.

### 4.7.7 TEST RESULTS

CHANNEL	FREQUENCY (MHz)	OUTPUT POWER (mW)			OUTPUT POWER (dBm)			POWER LIMIT (mW)	PASS / FAIL
		GFSK	$\pi/4$ -DQPSK	8DPSK	GFSK	$\pi/4$ -DQPSK	8DPSK		
0	2402	6.592	11.092	6.902	8.19	10.45	8.39	125	PASS
39	2441	8.110	13.243	8.375	9.09	11.22	9.23	125	PASS
78	2480	8.995	14.655	9.141	9.54	11.66	9.61	125	PASS

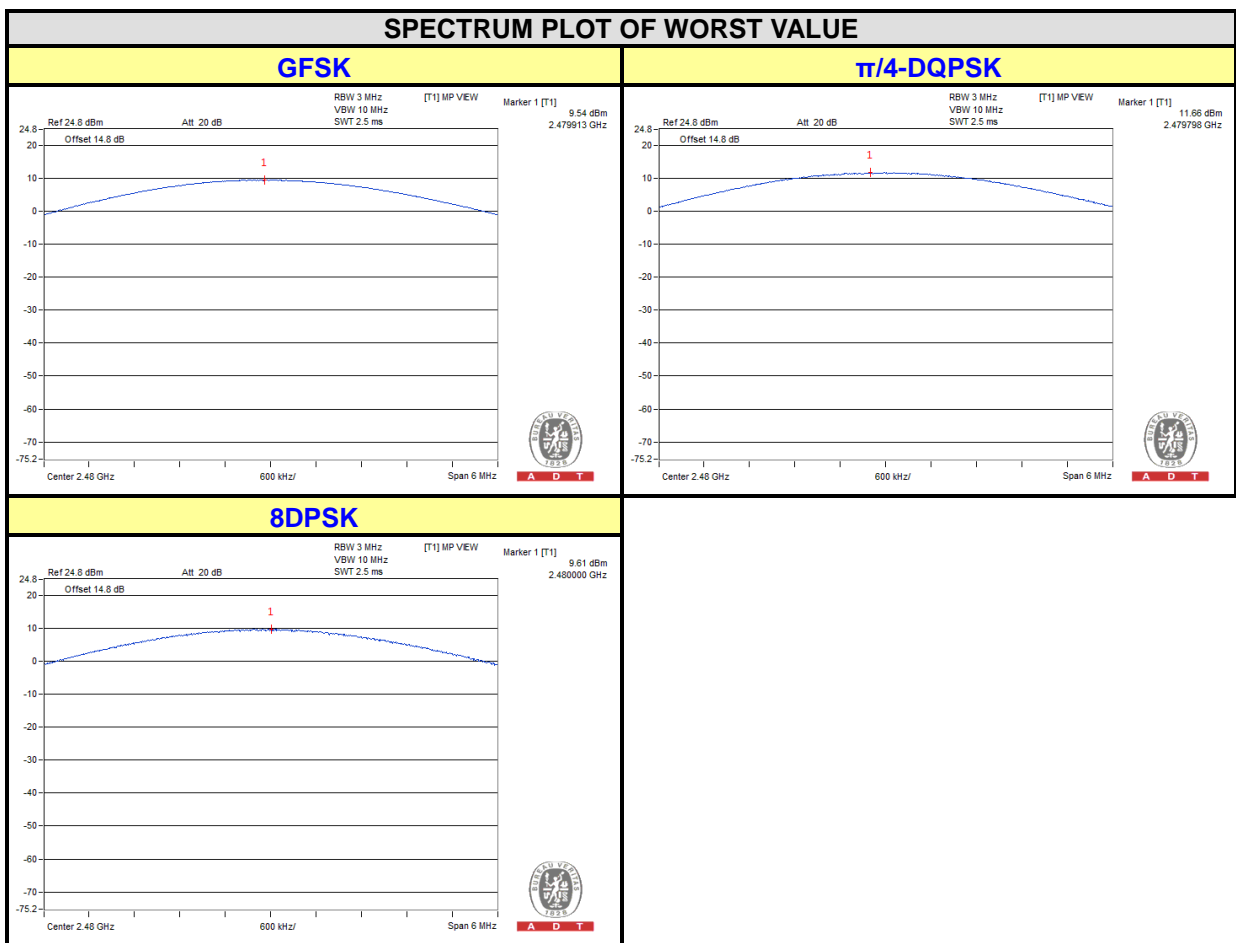

## 4.8 CONDUCTED OUT OF BAND EMISSION MEASUREMENT

### 4.8.1 LIMITS OF CONDUCTED OUT OF BAND EMISSION MEASUREMENT

Below  $-20\text{dB}$  of the highest emission level of operating band (in  $100\text{kHz}$  RBW).

### 4.8.2 TEST INSTRUMENTS

Refer to section 4.1.2 to get information of above instrument.

### 4.8.3 TEST PROCEDURE

1. Set RBW =  $100\text{ kHz}$ .
2. Set VBW =  $300\text{ kHz}$ .
3. Set span to encompass the spectrum to be examined
4. Detector = peak.
5. Trace Mode = max hold.
6. Sweep = auto couple.

### 4.8.4 DEVIATION FROM TEST STANDARD

No deviation.

### 4.8.5 EUT OPERATING CONDITION

The software provided by client enabled the EUT to transmit continuously.

### 4.8.6 TEST RESULTS

The spectrum plots are attached on the following images. D1 line indicates the highest level, D2 line indicates the  $20\text{dB}$  offset below D1. It shows compliance with the requirement.





A D T

### GFSK

#### Hopping disabled\_ Low Channel

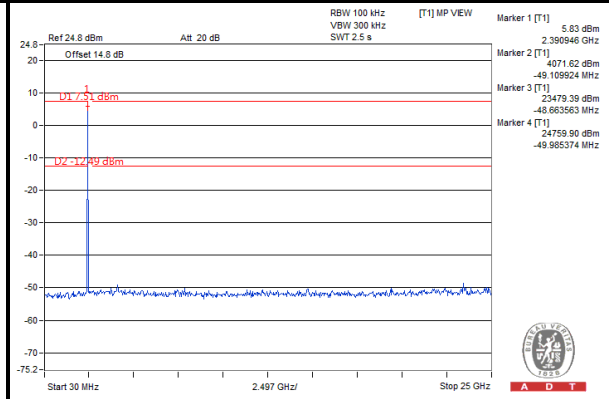
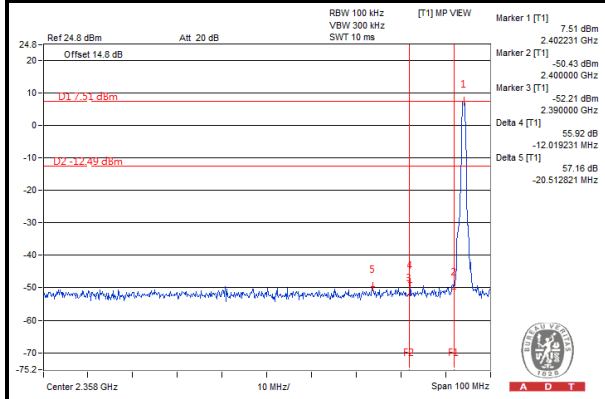

#### Hopping disabled\_ High Channel

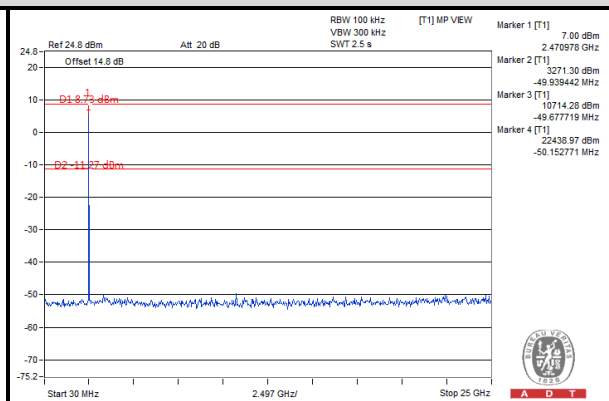
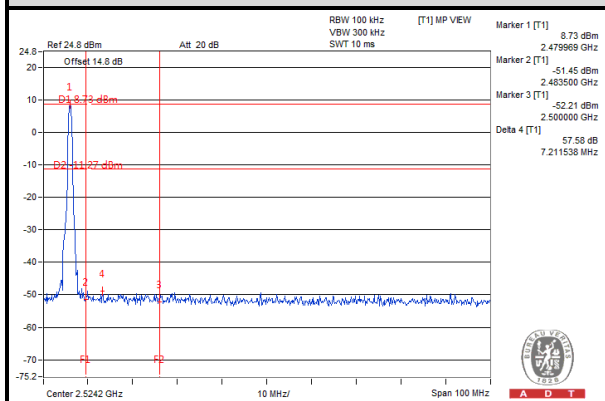

#### Hopping enabled\_ Low Channel

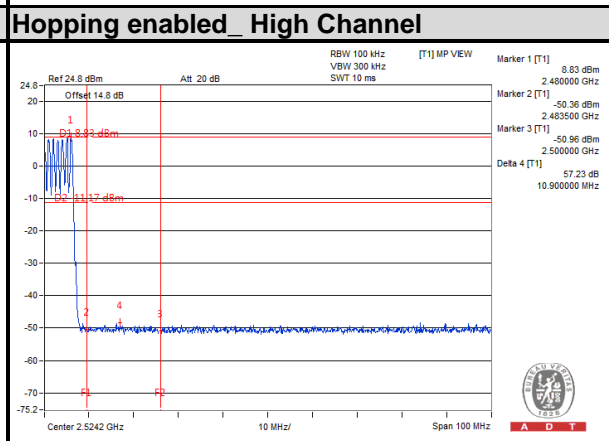
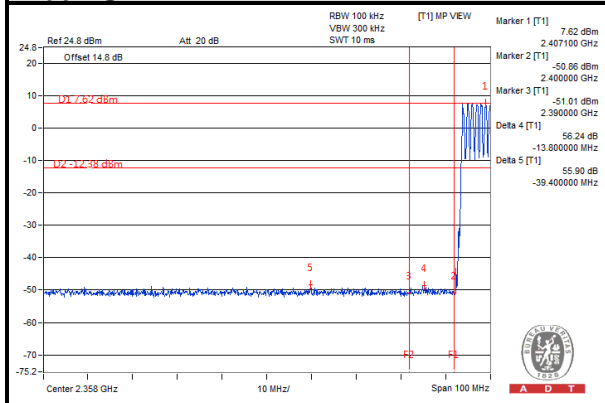



A D T

### $\pi/4$ -DQPSK

#### Hopping disabled\_ Low Channel

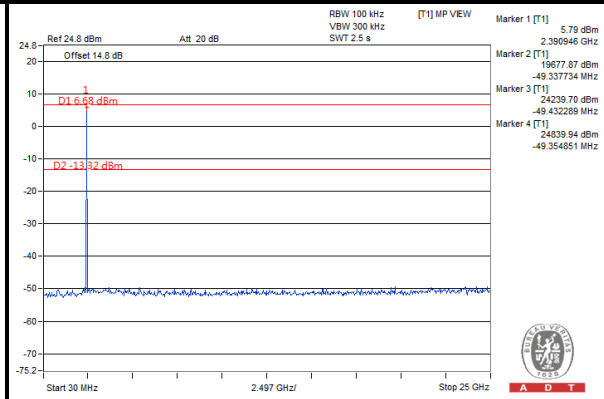
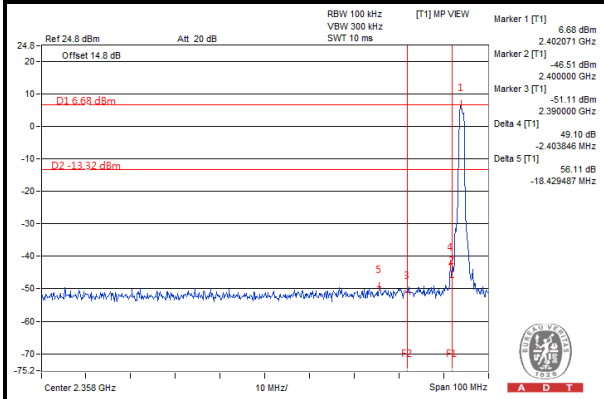

#### Hopping disabled\_ High Channel

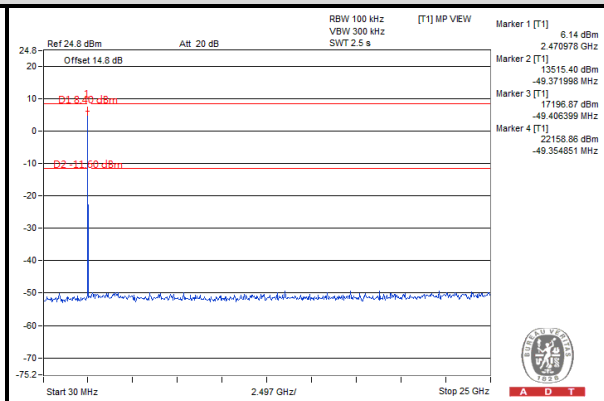
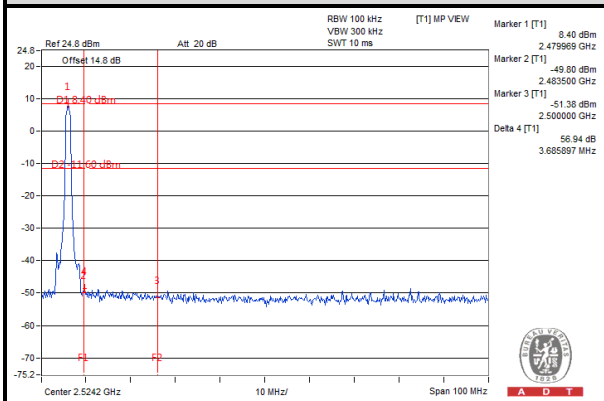

#### Hopping enabled\_ Low Channel

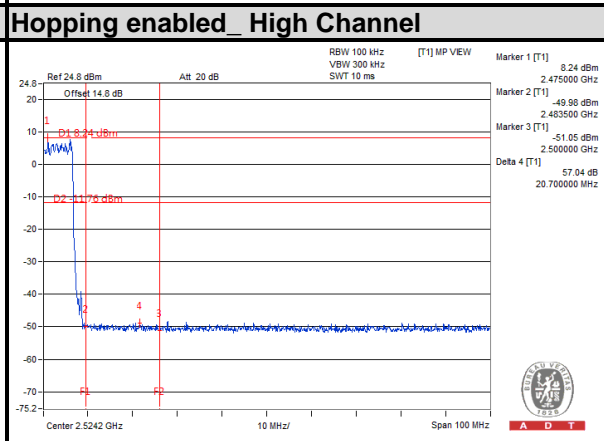
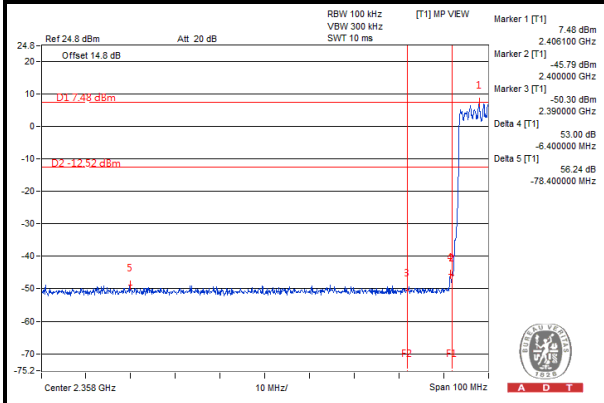



A D T

### 8DPSK

#### Hopping disabled\_ Low Channel

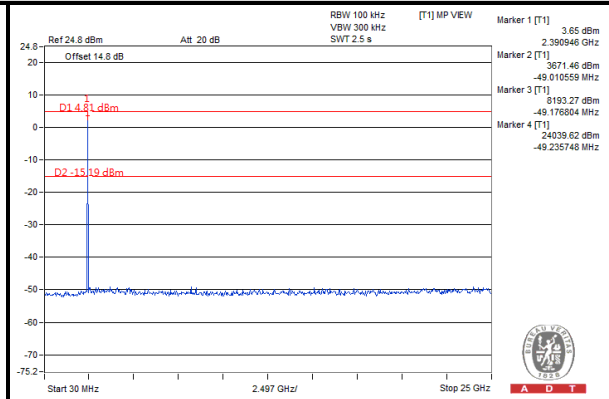
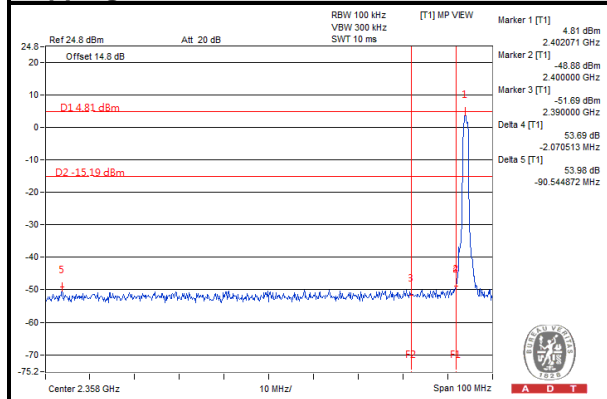

#### Hopping disabled\_ High Channel

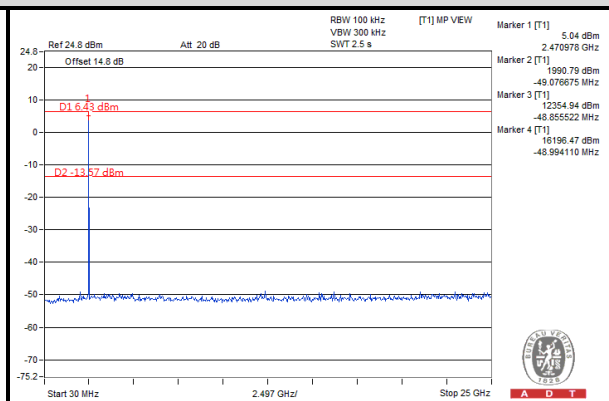
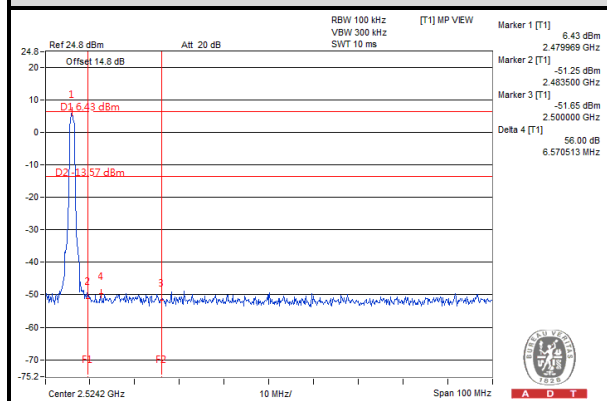

#### Hopping enabled\_ Low Channel

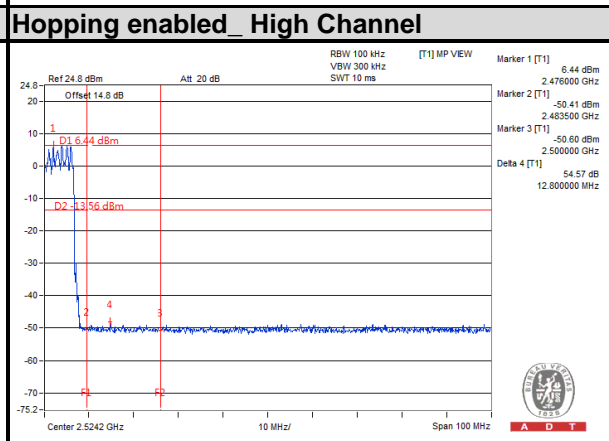
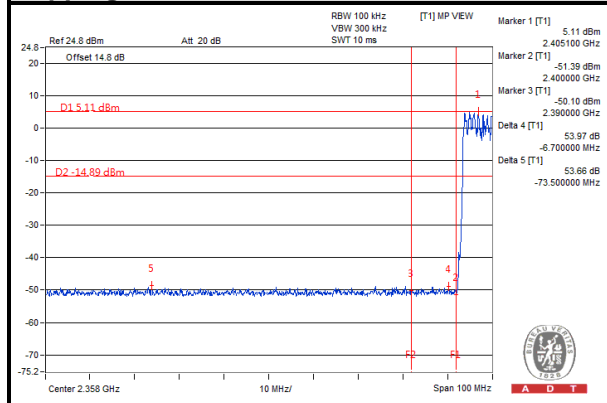



A D T

## 5. PHOTOGRAPHS OF THE TEST CONFIGURATION

Please refer to the attached file (Test Setup Photo).





## 6. INFORMATION ON THE TESTING LABORATORIES

We, Bureau Veritas Consumer Products Services (H.K.) Ltd., Taoyuan Branch, were founded in 1988 to provide our best service in EMC, Radio, Telecom and Safety consultation. Our laboratories are accredited and approved according to ISO/IEC 17025.

If you have any comments, please feel free to contact us at the following:

**Linko EMC/RF Lab:**

Tel: 886-2-26052180

Fax: 886-2-26051924

**Hsin Chu EMC/RF Lab:**

Tel: 886-3-5935343

Fax: 886-3-5935342

**Hwa Ya EMC/RF/Safety Telecom Lab:**

Tel: 886-3-3183232

Fax: 886-3-3270892

**Email:** [service.adt@tw.bureauveritas.com](mailto:service.adt@tw.bureauveritas.com)

**Web Site:** [www.bureauveritas-adt.com](http://www.bureauveritas-adt.com)

The address and road map of all our labs can be found in our web site also.



A D T

## **7. APPENDIX A - MODIFICATIONS RECORDERS FOR ENGINEERING CHANGES TO THE EUT BY THE LAB**

No modifications were made to the EUT by the lab during the test.

**--- END ---**