



**Specific Absorption Rate (SAR) Test Report**  
for  
**VeriFone Inc.**  
on the  
**Point of Sales Terminal**

**Report Number** : FA922024  
**Trade Name** : VeriFone  
**Model Name** : VX610  
**FCC ID** : B32VX610EVDO  
**Date of Testing** : Mar. 07, 2009  
**Issued Date of Report** : Mar. 12, 2009

- The test results refer exclusively to the tested model/sample only.
- Without written approval of SPORTON INTERNATIONAL INC., the test report shall not be reproduced except in full.
- Report Version: Rev. 01

**SPORTON INTERNATIONAL INC.**

**No. 52, Hwa Ya 1<sup>st</sup> Rd., Hwa Ya Technology Park, Kwei-Shan Hsiang, Tao Yuan Hsien, Taiwan, R.O.C.**



Table of Contents

1. Statement of Compliance .....3
2. Administration Data .....4
2.1 Testing Laboratory .....4
2.2 Applicant .....4
2.3 Manufacturer .....4
2.4 Application Details .....4
3. General Information .....5
3.1 Description of Device Under Test (DUT) .....5
3.2 Product Photos .....6
3.3 Applied Standards .....6
3.4 Device Category and SAR Limits .....6
3.5 Test Conditions .....6
3.5.1 Ambient Condition .....6
3.5.2 Test Configuration .....6
4. Specific Absorption Rate (SAR) .....7
4.1 Introduction .....7
4.2 SAR Definition .....7
5. SAR Measurement Setup .....8
5.1 DASYS5 E-Field Probe System .....9
5.1.1 E-Field Probe Specification .....9
5.1.2 E-Field Probe Calibration .....10
5.2 DATA Acquisition Electronics (DAE) .....11
5.3 Robot .....11
5.4 Measurement Server .....11
5.5 SAM Twin Phantom .....12
5.6 Device Holder for SAM Twin Phantom .....13
5.7 Data Storage and Evaluation .....14
5.7.1 Data Storage .....14
5.7.2 Data Evaluation .....14
5.8 Test Equipment List .....16
6. Tissue Simulating Liquids .....17
7. Uncertainty Assessment .....19
8. SAR Measurement Evaluation .....21
8.1 Purpose of System Performance check .....21
8.2 System Setup .....21
8.3 Validation Results .....23
9. Description for DUT Testing Position .....24
10. Measurement Procedures .....25
10.1 Spatial Peak SAR Evaluation .....25
10.2 Scan Procedures .....26
10.3 SAR Averaged Methods .....26
11. SAR Test Results .....27
11.1 Conducted Power .....27
11.2 Test Records for Body SAR Test .....28
12. References .....29

- Appendix A - System Performance Check Data
Appendix B - SAR Measurement Data
Appendix C - Calibration Data
Appendix D - Product Photos
Appendix E - Test Setup Photos
Appendix F - FCC 3G SAR Measurement Procedures



## **1. Statement of Compliance**

The Specific Absorption Rate (SAR) maximum results found during testing for the **VeriFone Inc. Point of Sales Terminal VeriFone VX610** is **1.11 W/kg for CDMA2000 Cellular band body SAR and 1.54 W/kg for CDMA2000 PCS band body SAR** with expanded uncertainty 21.9%. They are in compliance with Specific Absorption Rate (SAR) for general population/uncontrolled exposure limits specified in FCC 47 CFR part 2 (2.1093) and ANSI/IEEE C95.1-1999 and had been tested in accordance with the measurement methods and procedures specified in OET Bulletin 65 Supplement C (Edition 01-01).

Approved by

A handwritten signature in blue ink that reads 'Roy Wu'. The signature is written in a cursive style and is positioned above a horizontal line.

Roy Wu  
Manager



## **2. Administration Data**

### **2.1 Testing Laboratory**

**Company Name :** Sporton International Inc.  
**Address :** No. 52, Hwa-Ya 1<sup>st</sup> RD., Hwa Ya Technology Park, Kwei-Shan Hsiang, TaoYuan Hsien, Taiwan, R.O.C.  
**Test Site :** SAR01-HY  
**Telephone Number :** 886-3-327-3456  
**Fax Number :** 886-3-328-4978

### **2.2 Applicant**

**Company Name :** VeriFone Inc.  
**Address :** 1400 West Stanford Ranch Road, Suite 200, Rocklin CA 95765, USA

### **2.3 Manufacturer**

**Company Name :** Sanmina\_SCI Systems (Kunshan) Co., Ltd.  
**Address :** 312, Qing Yang South Road, Economics and Technical Development Zone, Kunshan, Jiangsu Province, China 215300

### **2.4 Application Details**

**Date of reception of application:** Feb. 20, 2009  
**Start of test :** Mar. 07, 2009  
**End of test :** Mar. 07, 2009



3. General Information

3.1 Description of Device Under Test (DUT)

Product Feature & Specification	
DUT Type	Point of Sales Terminal
Trade Name	VeriFone
Model Name	VX610
FCC ID	B32VX610EVDO
Tx Frequency Range	CDMA2000 Cellular : 824 MHz ~ 849 MHz CDMA2000 PCS : 1850 MHz ~ 1910 MHz
Rx Frequency Range	CDMA2000 Cellular : 869 MHz ~ 894 MHz CDMA2000 PCS : 1930 MHz ~ 1990 MHz
Maximum Output Power	CDMA2000 Cellular (1xRTT) : 23.21 dBm CDMA2000 Cellular (1xEV-DO) : 23.27 dBm CDMA2000 PCS (1xRTT) : 22.33 dBm CDMA2000 PCS (1xEV-DO) : 22.48 dBm
Type of Antenna Connector	N/A
Antenna Type	Dipole Antenna
HW Version	EVT-3
SW Version	OS:QB011013
Type of Modulation	QPSK
DUT Stage	Identical Prototype

List of Accessory:

Specification of Accessory		
AC Adapter 1	Brand Name	VeriFone
	Model Name	AU1360903n
	Power Rating	I/P:100-240Vac, 50-60Hz, 2A; O/P: 9Vdc, 4A
	AC Power Cord Type	1.8 meter non-shielded cable with ferrite core
AC Adapter 2	Brand Name	VeriFone
	Model Name	GC99D036009
	Power Rating	I/P:100-240Vac, 50-60Hz, 1200mA; O/P: 9Vdc, 4A
	AC Power Cord Type	1.8 meter non-shielded cable with ferrite core
Battery	Brand Name	VeriFone
	Model Name	23326-04-R
	Power Rating	7.2Vdc, 1800mAh
	Type	Li-ion

Remark: The above DUT's information was declared by manufacturer. Please refer to the specifications or user's manual for more detailed description.



**3.2 Product Photos**

Refer to Appendix D.

**3.3 Applied Standards**

The Specific Absorption Rate (SAR) testing specification, method and procedure for this Point of Sales Terminal is in accordance with the following standards:

- 47 CFR Part 2 (2.1093)
- IEEE C95.1-1999
- OET Bulletin 65 Supplement C (Edition 01-01)
- Preliminary Guidance for Reviewing Applications for Certification of 3G Device. May 2006
- KDB 941225 D01 v02

**3.4 Device Category and SAR Limits**

This device belongs to portable device category because its radiating structure is allowed to be used within 20 centimeters of the body of the user. Limit for General Population/Uncontrolled exposure should be applied for this device, it is 1.6 W/kg as averaged over any 1 gram of tissue.

**3.5 Test Conditions**

**3.5.1 Ambient Condition**

Ambient Temperature	20-24
Humidity	<60 %

**3.5.2 Test Configuration**

The DUT was set from the emulator to radiate maximum output power during all tests.

The device was controlled by using a base station emulator R&S CMU200. Communication between the device and the emulator was established by air link. The distance between the DUT and the antenna of the emulator is larger than 50 cm and the output power radiated from the emulator antenna is at least 30 dB smaller than the output power of DUT.

Measurements were performed on the lowest, middle, and highest channel for each testing position. However, if the SAR is below 3 dB of limit, measurements were performed only on the middle channel.

For SAR testing, DUT is in CDMA2000 link mode, and its crest factor is 1.

## 4. Specific Absorption Rate (SAR)

### 4.1 Introduction

SAR is related to the rate at which energy is absorbed per unit mass in an object exposed to a radio field. The SAR distribution in a biological body is complicated and is usually carried out by experimental techniques or numerical modeling. The standard recommends limits for two tiers of groups, occupational/controlled and general population/uncontrolled, based on a person's awareness and ability to exercise control over his or her exposure. In general, occupational/controlled exposure limits are higher than the limits for general population/uncontrolled.

### 4.2 SAR Definition

The SAR definition is the time derivative (rate) of the incremental energy (dW) absorbed by (dissipated in) an incremental mass (dm) contained in a volume element (dv) of a given density.

ρ). The equation description is as below:

$$\text{SAR} = \frac{d}{dt} \left( \frac{dW}{dm} \right) = \frac{d}{dt} \left( \frac{dW}{\rho dv} \right)$$

*SAR is expressed in units of Watts per kilogram (W/kg)*

SAR measurement can be either related to the temperature elevation in tissue by

$$\text{SAR} = C \frac{\delta T}{\delta t}$$

, where C is the specific heat capacity,  $\delta T$  is the temperature rise and  $\delta t$  the exposure duration, or related to the electrical field in the tissue by

$$\text{SAR} = \frac{\sigma |E|^2}{\rho}$$

, where  $\sigma$  is the conductivity of the tissue,  $\rho$  is the mass density of the tissue and E is the rms electrical field strength.

However for evaluating SAR of low power transmitter, electrical field measurement is typically applied.

## 5. SAR Measurement Setup

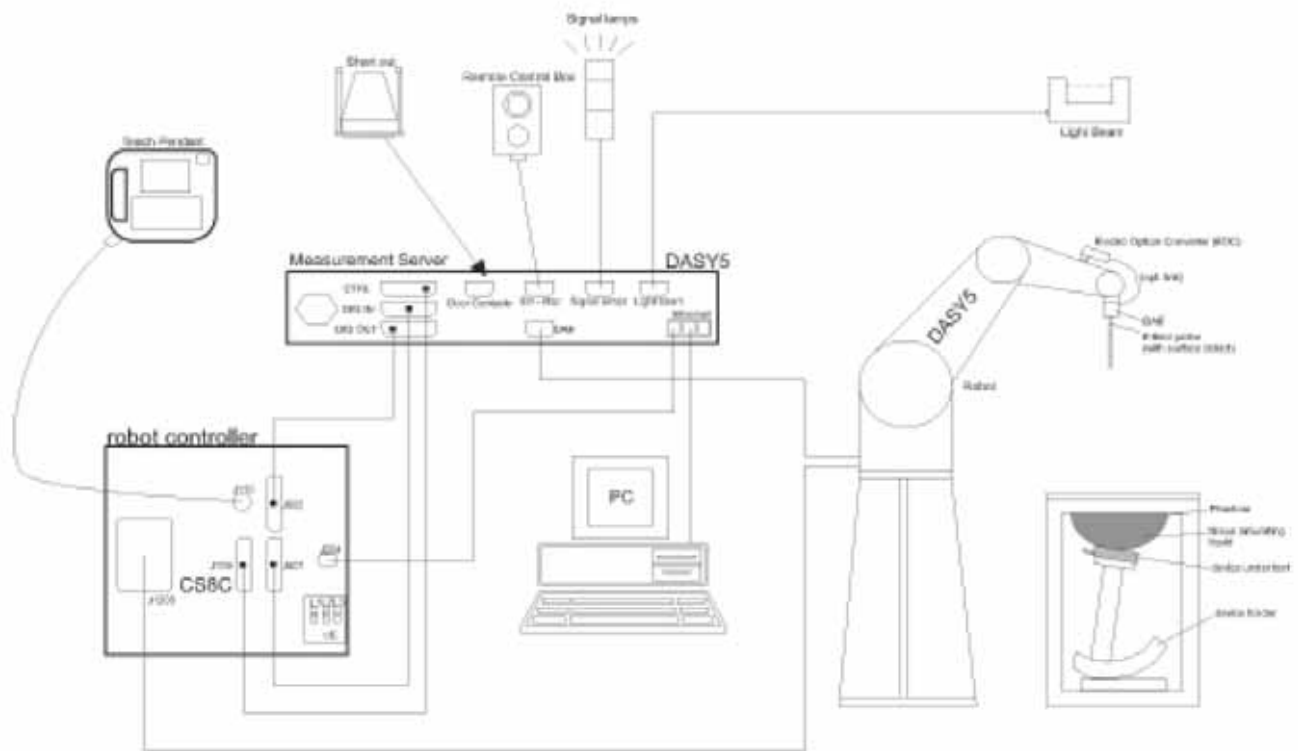

Fig. 5.1 DASY5 System

The DASY5 system for performance compliance tests is illustrated above graphically. This system consists of the following items:

- A standard high precision 6-axis robot with controller, a teach pendant and software
- A data acquisition electronic (DAE) attached to the robot arm extension
- A dosimetric probe equipped with an optical surface detector system
- The electro-optical converter (ECO) performs the conversion between optical and electrical signals
- A measurement server performs the time critical tasks such as signal filtering, control of the robot operation and fast movement interrupts.
- A probe alignment unit which improves the accuracy of the probe positioning
- A computer operating Windows XP
- DASY5 software
- Remote control with teach pendant and additional circuitry for robot safety such as warning lamps, etc.
- The SAM twin phantom
- A device holder
- Tissue simulating liquid
- Dipole for evaluating the proper functioning of the system

Some of the components are described in details in the following sub-sections.



**5.1 DASY5 E-Field Probe System**

The SAR measurement is conducted with the dosimetric probe (manufactured by SPEAG).The probe is specially designed and calibrated for use in liquid with high permittivity. The dosimetric probe has special calibration in liquid at different frequency. This probe has a built in optical surface detection system to prevent from collision with phantom.

**5.1.1 E-Field Probe Specification  
<ET3DV6>**

<b>Construction</b>	Symmetrical design with triangular core Built-in optical fiber for surface detection system Built-in shielding against static charges PEEK enclosure material (resistant to organic solvents)	
<b>Frequency</b>	10 MHz to 3 GHz	
<b>Directivity</b>	± 0.2 dB in brain tissue (rotation around probe axis) ± 0.4 dB in brain tissue (rotation perpendicular to probe axis)	
<b>Dynamic Range</b>	5µW/g to 100mW/g; Linearity: ±0.2dB	
<b>Surface Detection</b>	± 0.2 mm repeatability in air and clear liquids on reflecting surface	
<b>Dimensions</b>	Overall length: 330mm Tip length: 16mm Body diameter: 12mm Tip diameter: 6.8mm Distance from probe tip to dipole centers: 2.7mm	
<b>Application</b>	General dosimetry up to 3GHz Compliance tests for mobile phones and Wireless LAN Fast automatic scanning in arbitrary phantoms	

**Fig. 5.2 Probe Setup on Robot**



**5.1.2 E-Field Probe Calibration**

Each probe needs to be calibrated according to a dosimetric assessment procedure with accuracy better than  $\pm 10\%$ . The spherical isotropy shall be evaluated and within  $\pm 0.25\text{dB}$ . The sensitivity parameters (NormX, NormY, and NormZ), the diode compression parameter (DCP) and the conversion factor (ConvF) of the probe are tested. The calibration data are as below:

<b>ET3DV6 sn1787 (Cal: Aug. 26, 2008)</b>			
<b>Item</b>	<b>X axis</b>	<b>Y axis</b>	<b>Z axis</b>
<b>Sensitivity (<math>\mu\text{V}</math>)</b>	1.63	1.67	2.18
<b>Diode Compression Point (mV)</b>	90	93	92
<b>Conversion Factor (Head / Body)</b>	<b>Frequency (MHz)</b>	<b>X,Y,Z axis</b>	
	800~1000	6.06 / 5.91	
	1650~1850	5.36 / 4.73	
	1850~2050	5.01 / 4.49	
	2350~2550	4.49 / 3.79	
<b>Boundary Effect (Head / Body)</b>	<b>Frequency (MHz)</b>	<b>Alpha</b>	<b>Depth</b>
	800~1000	0.30 / 0.31	2.80 / 2.98
	1650~1850	0.53 / 0.60	2.11 / 2.20
	1850~2050	0.59 / 0.68	1.96 / 1.95
	2350~2550	0.77 / 0.90	1.57 / 1.51

NOTE: The probe parameters have been calibrated by the SPEAG.

### **5.2 DATA Acquisition Electronics (DAE)**

The data acquisition electronics (DAE) consists of a highly sensitive electrometer-grade preamplifier with auto-zeroing, a channel and gain-switching multiplexer, a fast 16 bit AD-converter and a command decoder and control logic unit. Transmission to the measurement server is accomplished through an optical downlink for data and status information as well as an optical uplink for commands and the clock.

The mechanical probe mounting device includes two different sensor systems for frontal and sideways probe contacts. They are used for mechanical surface detection and probe collision detection.

The input impedance of the DAE is 200M Ohm; the inputs are symmetrical and floating. Common mode rejection is above 80dB.

### **5.3 Robot**

The DASY5 system uses the high precision robots TX90 XL type out of the newer series from Stäubli SA (France). For the 6-axis controller DASY5 system, the CS8C robot controller version from Stäubli is used. The XL robot series have many features that are important for our application:

- High precision (repeatability 0.02 mm)
- High reliability (industrial design)
- Jerk-free straight movements
- Low ELF interference (the closed metallic construction shields against motor control fields)
- 6-axis controller

### **5.4 Measurement Server**

The DASY5 measurement server is based on a PC/104 CPU board with  
400 MHz CPU  
128 MB chipdisk and  
128 MB RAM.

Communication with  
the DAE electronic box  
the 16-bit AD-converter system for optical detection and digital I/O interface.

The measurement server performs all the real-time data evaluation for field measurements and surface detection, controls robot movements and handles safety operations.

### **5.5 SAM Twin Phantom**

The SAM twin phantom is a fiberglass shell phantom with 2mm shell thickness (except the ear region where shell thickness increases to 6mm). It has three measurement areas:

- Left head
- Right head
- Flat phantom

The bottom plate contains three pair of bolts for locking the device holder. The device holder positions are adjusted to the standard measurement positions in the three sections. A white cover is provided to tap the phantom during off-periods to prevent water evaporation and changes in the liquid parameters. On the phantom top, three reference markers are provided to identify the phantom position with respect to the robot.

The phantom can be used with the following tissue simulating liquids:

- \*Water-sugar based liquid
- \*Glycol based liquids

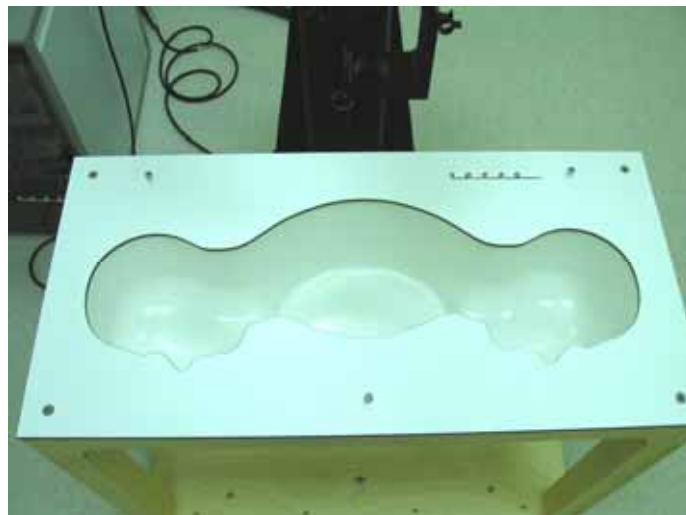

**Fig. 5.3 Top View of Twin Phantom**



**Fig. 5.4 Bottom View of Twin Phantom**

### **5.6 Device Holder for SAM Twin Phantom**

The SAR in the Phantom is approximately inversely proportional to the square of the distance between the source and the liquid surface. For a source in 5 mm distance, a positioning uncertainty of  $\pm 0.5\text{mm}$  would produce a SAR uncertainty of  $\pm 20\%$ . An accurate device position is therefore crucial for accurate and repeatable measurement. The position in which the devices must be measured, are defined by the standards.

The DASY5 device holder is designed to cope with different positions given in the standard. It has two scales for the device rotation (with respect to the body axis) and the device inclination (with respect to the line between the ear reference points). The rotation center for both scales is the ear reference point (EPR).

Thus the device needs no repositioning when changing the angles.

The DASY5 device holder has been made out of low-loss POM material having the following dielectric parameters: relative permittivity  $\epsilon_r = 3$  and loss tangent  $\delta = 0.02$ . The amount of dielectric material has been reduced in the closest vicinity of the device, since measurements have suggested that the influence of the clamp on the test results could thus be lowered.



**Fig. 5.5 Device Holder**



## 5.7 Data Storage and Evaluation

### 5.7.1 Data Storage

The DASY5 software stores the assessed data from the data acquisition electronics as raw data (in microvolt readings from the probe sensors), together with all the necessary software parameters for the data evaluation (probe calibration data, liquid parameters and device frequency and modulation data) in measurement files with the extension. The post-processing software evaluates the desired unit and format for output each time the data is visualized or exported. This allows verification of the complete software setup even after the measurement and allows correction of erroneous parameter settings. For example, if a measurement has been performed with an incorrect crest factor parameter in the device setup, the parameter can be corrected afterwards and the data can be reevaluated.

The measured data can be visualized or exported in different units or formats, depending on the selected probe type (e.g., [V/m], [A/m], [mW/g]). Some of these units are not available in certain situations or give meaningless results, e.g., a SAR-output in a non-lose media, will always be zero. Raw data can also be exported to perform the evaluation with other software packages.

### 5.7.2 Data Evaluation

The DASY5 post-processing software (SEMCAD) automatically executes the following procedures to calculate the field units from the microvolt readings at the probe connector. The parameters used in the evaluation are stored in the configuration modules of the software :

<b>Probe parameters :</b>	- Sensitivity	Norm <sub>j</sub> , a <sub>ρ</sub> , a <sub>i1</sub> , a <sub>2</sub>
	- Conversion factor	ConvF <sub>j</sub>
	- Diode compression point	dcp <sub>j</sub>
<b>Device parameters :</b>	- Frequency	f
	- Crest factor	cf
<b>Media parameters :</b>	- Conductivity	σ
	- Density	ρ

These parameters must be set correctly in the software. They can be found in the component documents or they can be imported into the software from the configuration files issued for the DASY5 components. In the direct measuring mode of the multi-meter option, the parameters of the actual system setup are used. In the scan visualization and export modes, the parameters stored in the corresponding document files are used.

The first step of the evaluation is a linearization of the filtered input signal to account for the compression characteristics of the detector diode. The compensation depends on the input signal, the diode type and the DC-transmission factor from the diode to the evaluation electronics. If the exciting field is pulsed, the crest factor of the signal must be known to correctly compensate for peak power.

The formula for each channel can be given as :

$$V_i = U_i + U_i^2 \cdot \frac{cf}{dcp_i}$$

with  **$V_i$**  = compensated signal of channel  $i$  ( $i = x, y, z$ )  
 **$U_i$**  = input signal of channel  $i$  ( $i = x, y, z$ )  
 **$cf$**  = crest factor of exciting field (DASY parameter)  
 **$dcp_i$**  = diode compression point (DASY parameter)

From the compensated input signals, the primary field data for each channel can be evaluated :

**E-field probes :**  $E_i = \sqrt{\frac{V_i}{Norm_i ConvF}}$

**H-field probes :**  $H_i = \sqrt{V_i \frac{a_{i0} + a_{i1}f + a_{i2}f^2}{f}}$

with  **$V_i$**  = compensated signal of channel  $i$  ( $i = x, y, z$ )  
 **$Norm_i$**  = sensor sensitivity of channel  $i$  ( $i = x, y, z$ )  
 $\mu V/(V/m)^2$  for E-field Probes  
 **$ConvF$**  = sensitivity enhancement in solution  
 **$a_{ij}$**  = sensor sensitivity factors for H-field probes  
 **$f$**  = carrier frequency [GHz]  
 **$E_i$**  = electric field strength of channel  $i$  in V/m  
 **$H_i$**  = magnetic field strength of channel  $i$  in A/m

The RSS value of the field components gives the total field strength (Hermitian magnitude) :

$$E_{tot} = \sqrt{E_x^2 + E_y^2 + E_z^2}$$

The primary field data are used to calculate the derived field units.

$$SAR = E_{tot}^2 \cdot \frac{\sigma}{\rho \cdot 1000}$$

with  **$SAR$**  = local specific absorption rate in mW/g  
 **$E_{tot}$**  = total field strength in V/m  
 $\sigma$  = conductivity in [mho/m] or [Siemens/m]  
 $\rho$  = equivalent tissue density in  $g/cm^3$

\* Note that the density is set to 1, to account for actual head tissue density rather than the density of the tissue simulating liquid.

The power flow density is calculated assuming the excitation field to be a free space field.

$$P_{pwe} = \frac{E_{tot}^2}{3770} \quad \text{or} \quad P_{pwe} = H_{tot}^2 \cdot 37.7$$

with  **$P_{pwe}$**  = equivalent power density of a plane wave in  $mW/cm^2$   
 **$E_{tot}$**  = total electric field strength in V/m  
 **$H_{tot}$**  = total magnetic field strength in A/m



**5.8 Test Equipment List**

Manufacturer	Name of Equipment	Type/Model	Serial Number	Calibration	
				Last Cal.	Due Date
SPEAG	Dosimetric E-Filed Probe	ET3DV6	1787	Aug. 26, 2008	Aug. 25, 2009
SPEAG	Dosimetric E-Filed Probe	ET3DV6	1788	Sep. 23, 2008	Sep. 22, 2009
SPEAG	Dosimetric E-Filed Probe	EX3DV3	3514	Jan. 21, 2009	Jan. 20, 2010
SPEAG	835MHz System Validation Kit	D835V2	499	Mar. 17, 2008	Mar. 16, 2010
SPEAG	900MHz System Validation Kit	D900V2	190	Jul. 16, 2007	Jul. 15, 2009
SPEAG	1800MHz System Validation Kit	D1800V2	2d076	Jul. 10, 2007	Jul. 09, 2009
SPEAG	1900MHz System Validation Kit	D1900V2	5d041	Mar. 28, 2008	Mar. 27, 2010
SPEAG	2000MHz System Validation Kit	D2000V2	1010	Sep. 17, 2008	Sep. 16, 2010
SPEAG	2300MHz System Validation Kit	D2300V2	1006	Sep. 12, 2007	Sep. 11, 2009
SPEAG	2450MHz System Validation Kit	D2450V2	736	Jul. 12, 2007	Jul. 11, 2009
SPEAG	2600MHz System Validation Kit	D2600V2	1008	Sep. 12, 2007	Sep. 11, 2009
SPEAG	3500MHz System Validation Kit	D3500V2	1014	Sep. 19, 2007	Sep. 18, 2009
SPEAG	5GHz System Validation Kit	D5GHzV2	1006	Jan. 24, 2008	Jan. 23, 2010
SPEAG	Data Acquisition Electronics	DAE3	577	Nov. 12, 2008	Nov. 11, 2009
SPEAG	Data Acquisition Electronics	DAE4	778	Sep. 22, 2008	Sep. 21, 2009
SPEAG	Device Holder	N/A	N/A	NCR	NCR
SPEAG	SAM Phantom	QD 000 P40 C	TP-1303	NCR	NCR
SPEAG	SAM Phantom	QD 000 P40 C	TP-1383	NCR	NCR
SPEAG	SAM Phantom	QD 000 P40 C	TP-1446	NCR	NCR
SPEAG	SAM Phantom	QD 000 P40 C	TP-1477	NCR	NCR
SPEAG	ELI4 Phantom	QD 0VA 001 BB	1026	NCR	NCR
SPEAG	ELI4 Phantom	QD 0VA 001 BA	1029	NCR	NCR
Agilent	PNA Series Network Analyzer	E8358A	US40260131	Apr. 02, 2008	Apr. 01, 2009
Agilent	Wireless Communication Test Set	E5515C	MY48360820	Dec. 15, 2008	Dec. 14, 2009
R&S	Universal Radio Communication Tester	CMU200	105934	Nov. 11, 2008	Nov. 10, 2009
Agilent	Dielectric Probe Kit	85070D	US01440205	NCR	NCR
Agilent	Dual Directional Coupler	778D	50422	NCR	NCR
AR	Power Amplifier	5S1G4M2	0328767	NCR	NCR
R&S	Power Meter	NRVD	101394	Oct. 20, 2008	Oct. 19, 2009
R&S	Power Sensor	NRV-Z1	100130	Oct. 20, 2008	Oct. 19, 2009

**Table 5.1 Test Equipment List**



## 6. Tissue Simulating Liquids

For the measurement of the field distribution inside the SAM phantom with DASY4, the phantom must be filled with around 25 liters of homogeneous tissue simulating liquid. The liquid height from the ear reference point (ERP) of the phantom to the liquid top surface is (head SAR) or from the flat phantom to the liquid top surface (body SAR) is 15.2cm.

The following ingredients for tissue simulating liquid are used:

- **Water:** deionized water (pure H<sub>2</sub>O), resistivity 16MΩ- as basis for the liquid
- **Sugar:** refined sugar in crystals, as available in food shops – to reduce relative permittivity
- **Salt:** pure NaCl – to increase conductivity
- **Cellulose:** Hydroxyethyl-cellulose, medium viscosity (75-125 mPa.s, 2% in water, 20°C), CAS#54290-to increase viscosity and to keep sugar in solution.
- **Preservative:** Preventol D-7 Bayer AG, D-51368 Leverkusen, CAS#55965-84-9- to prevent the spread of bacteria and molds.
- **DGMBE:** Deithlenglycol-monobuthyl ether (DGMBE), Fluka Chemie GmbH, CAS#112-34-5 – to reduce relative permittivity.

Table 6.1 gives the recipes for tissue simulating liquid.

Frequency (MHz)	Water (%)	Sugar (%)	Cellulose (%)	Salt (%)	Preventol (%)	DGMBE (%)	Conductivity (σ)	Permittivity (ε <sub>r</sub> )
<b>For Head</b>								
835	40.3	57.9	0.2	1.4	0.2	0	0.90	41.5
900	40.3	57.9	0.2	1.4	0.2	0	0.97	41.5
1800, 1900, 2000	55.2	0	0	0.3	0	44.5	1.40	40.0
2450	55.0	0	0	0	0	45.0	1.80	39.2
<b>For Body</b>								
835	50.8	48.2	0	0.9	0.1	0	0.97	55.2
900	50.8	48.2	0	0.9	0.1	0	1.05	55.0
1800, 1900, 2000	70.2	0	0	0.4	0	29.4	1.52	53.3
2450	68.6	0	0	0	0	31.4	1.95	52.7

**Table 6.1 Recipes of Tissue Simulating Liquid**



Table 6.2 gives the targets for tissue simulating liquid.

Frequency (MHz)	Liquid Type	Conductivity ( $\sigma$ )	$\pm 5\%$ Range	Permittivity ( $\epsilon_r$ )	$\pm 5\%$ Range
835	Head	0.90	0.86 ~ 0.95	41.5	39.4 ~ 43.6
900	Head	0.97	0.92 ~ 1.02	41.5	39.4 ~ 43.6
1800, 1900, 2000	Head	1.40	1.33 ~ 1.47	40.0	38.0 ~ 42.0
2450	Head	1.80	1.71 ~ 1.89	39.2	37.2 ~ 41.2
835	Body	0.97	0.92 ~ 1.02	55.2	52.4 ~ 58.0
900	Body	1.05	1.00 ~ 1.10	55.0	52.3 ~ 57.8
1800, 1900, 2000	Body	1.52	1.44 ~ 1.60	53.3	50.6 ~ 56.0
2450	Body	1.95	1.85 ~ 2.05	52.7	50.1 ~ 55.3

**Table 6.2 Targets of Tissue Simulating Liquid**

The dielectric parameters of the liquids were verified prior to the SAR evaluation using an Agilent 85070D Dielectric Probe Kit and an Agilent Network Analyzer.

Table 6.3 shows the measuring results for simulating liquid.

Band	Temperature ( )	Frequency (MHz)	Conductivity ( $\sigma$ )	Permittivity ( $\epsilon_r$ )	Measurement Date
CDMA2000 Cellular (824 ~ 849 MHz)	21.2	824.70	0.972	54.6	Mar. 07, 2009
		836.52	0.985	54.4	
		848.31	0.996	54.3	
CDMA2000 PCS (1850 ~ 1910 MHz)	21.4	1851.25	1.49	52.7	Mar. 07, 2009
		1880.00	1.52	52.6	
		1908.75	1.55	52.4	

**Table 6.3 Measuring Results for Simulating Liquid**

## **7. Uncertainty Assessment**

The component of uncertainty may generally be categorized according to the methods used to evaluate them. The evaluation of uncertainty by the statistical analysis of a series of observations is termed a Type A evaluation of uncertainty. The evaluation of uncertainty by means other than the statistical analysis of a series of observations is termed a Type B evaluation of uncertainty. Each component of uncertainty, however evaluated, is represented by an estimated standard deviation, termed standard uncertainty, which is determined by the positive square root of the estimated variance.

A Type A evaluation of standard uncertainty may be based on any valid statistical method for treating data. This includes calculating the standard deviation of the mean of a series of independent observations; using the method of least squares to fit a curve to the data in order to estimate the parameter of the curve and their standard deviations; or carrying out an analysis of variance in order to identify and quantify random effects in certain kinds of measurement.

A type B evaluation of standard uncertainty is typically based on scientific judgment using all of the relevant information available. These may include previous measurement data, experience and knowledge of the behavior and properties of relevant materials and instruments, manufacturer's specification, data provided in calibration reports and uncertainties assigned to reference data taken from handbooks. Broadly speaking, the uncertainty is either obtained from an outdoor source or obtained from an assumed distribution, such as the normal distribution, rectangular or triangular distributions indicated in Table 7.1

<b>Uncertainty Distributions</b>	<b>Normal</b>	<b>Rectangular</b>	<b>Triangular</b>	<b>U-shape</b>
<b>Multiplying factor<sup>(a)</sup></b>	$1/k$ <sup>(b)</sup>	$1/\sqrt{3}$	$1/\sqrt{6}$	$1/\sqrt{2}$

(a) standard uncertainty is determined as the product of the multiplying factor and the estimated range of variations in the measured quantity

(b)  $k$  is the coverage factor

**Table 7.1 Standard Uncertainty for Assumed Distribution**

The combined standard uncertainty of the measurement result represents the estimated standard deviation of the result. It is obtained by combining the individual standard uncertainties of both Type A and Type B evaluation using the usual "root-sum-squares" (RSS) methods of combining standard deviations by taking the positive square root of the estimated variances.

Expanded uncertainty is a measure of uncertainty that defines an interval about the measurement result within which the measured value is confidently believed to lie. It is obtained by multiplying the combined standard uncertainty by a coverage factor. Typically, the coverage factor ranges from 2 to 3. Using a coverage factor allows the true value of a measured quantity to be specified with a defined probability within the specified uncertainty range. For purpose of this document, a coverage factor two is used, which corresponds to confidence interval of about 95 %. The DASY5 uncertainty Budget is showed in Table 7.2.



Error Description	Uncertainty Value $\pm$ %	Probability Distribution	Divisor	Ci (1g)	Standard Unc. (1g)	vi or Veff
<b>Measurement Equipment</b>						
Probe Calibration	$\pm 5.9$ %	Normal	1	1	$\pm 5.9$ %	$\infty$
Axial Isotropy	$\pm 4.7$ %	Rectangular	$\sqrt{3}$	0.7	$\pm 1.9$ %	$\infty$
Hemispherical Isotropy	$\pm 9.6$ %	Rectangular	$\sqrt{3}$	0.7	$\pm 3.9$ %	$\infty$
Boundary Effects	$\pm 1.0$ %	Rectangular	$\sqrt{3}$	1	$\pm 0.6$ %	$\infty$
Linearity	$\pm 4.7$ %	Rectangular	$\sqrt{3}$	1	$\pm 2.7$ %	$\infty$
System Detection Limits	$\pm 1.0$ %	Rectangular	$\sqrt{3}$	1	$\pm 0.6$ %	$\infty$
Readout Electronics	$\pm 0.3$ %	Normal	1	1	$\pm 0.3$ %	$\infty$
Response Time	$\pm 0.8$ %	Rectangular	$\sqrt{3}$	1	$\pm 0.5$ %	$\infty$
Integration Time	$\pm 2.6$ %	Rectangular	$\sqrt{3}$	1	$\pm 1.5$ %	$\infty$
RF Ambient Noise	$\pm 3.0$ %	Rectangular	$\sqrt{3}$	1	$\pm 1.7$ %	$\infty$
RF Ambient Reflections	$\pm 3.0$ %	Rectangular	$\sqrt{3}$	1	$\pm 1.7$ %	$\infty$
Probe Positioner	$\pm 0.4$ %	Rectangular	$\sqrt{3}$	1	$\pm 0.2$ %	$\infty$
Probe Positioning	$\pm 2.9$ %	Rectangular	$\sqrt{3}$	1	$\pm 1.7$ %	$\infty$
Max. SAR Eval.	$\pm 1.0$ %	Rectangular	$\sqrt{3}$	1	$\pm 0.6$ %	$\infty$
<b>Test Sample Related</b>						
Device Positioning	$\pm 2.9$ %	Normal	1	1	$\pm 2.9$	145
Device Holder	$\pm 3.6$ %	Normal	1	1	$\pm 3.6$	5
Power Drift	$\pm 5.0$ %	Rectangular	$\sqrt{3}$	1	$\pm 2.9$	$\infty$
<b>Phantom and Setup</b>						
Phantom Uncertainty	$\pm 4.0$ %	Rectangular	$\sqrt{3}$	1	$\pm 2.3$	$\infty$
Liquid Conductivity (target)	$\pm 5.0$ %	Rectangular	$\sqrt{3}$	0.64	$\pm 1.8$	$\infty$
Liquid Conductivity (meas.)	$\pm 2.5$ %	Normal	1	0.64	$\pm 1.6$	$\infty$
Liquid Permittivity (target)	$\pm 5.0$ %	Rectangular	$\sqrt{3}$	0.6	$\pm 1.7$	$\infty$
Liquid Permittivity (meas.)	$\pm 2.5$ %	Normal	1	0.6	$\pm 1.5$	$\infty$
<b>Combined Standard Uncertainty</b>					<b><math>\pm 10.9</math></b>	<b>387</b>
<b>Coverage Factor for 95 %</b>		<b>K=2</b>				
<b>Expanded uncertainty (Coverage factor = 2)</b>					<b><math>\pm 21.9</math></b>	

Table 7.2 Uncertainty Budget of DASY5

## 8. SAR Measurement Evaluation

Each DASY5 system is equipped with one or more system validation kits. These units, together with the predefined measurement procedures within the DASY5 software, enable the user to conduct the system performance check and system validation. System validation kit includes a dipole, tripod holder to fix it underneath the flat phantom and a corresponding distance holder.

### 8.1 Purpose of System Performance check

The system performance check verifies that the system operates within its specifications. System and operator errors can be detected and corrected. It is recommended that the system performance check be performed prior to any usage of the system in order to guarantee reproducible results. The system performance check uses normal SAR measurements in a simplified setup with a well characterized source. This setup was selected to give a high sensitivity to all parameters that might fail or vary over time. The system check does not intend to replace the calibration of the components, but indicates situations where the system uncertainty is exceeded due to drift or failure.

### 8.2 System Setup

In the simplified setup for system evaluation, the DUT is replaced by a calibrated dipole and the power source is replaced by a continuous wave that comes from a signal generator at frequency 835 MHz and 1900 MHz. The calibrated dipole must be placed beneath the flat phantom section of the SAM twin phantom with the correct distance holder. The distance holder should touch the phantom surface with a light pressure at the reference marking and be oriented parallel to the long side of the phantom. The equipment setup is shown below:

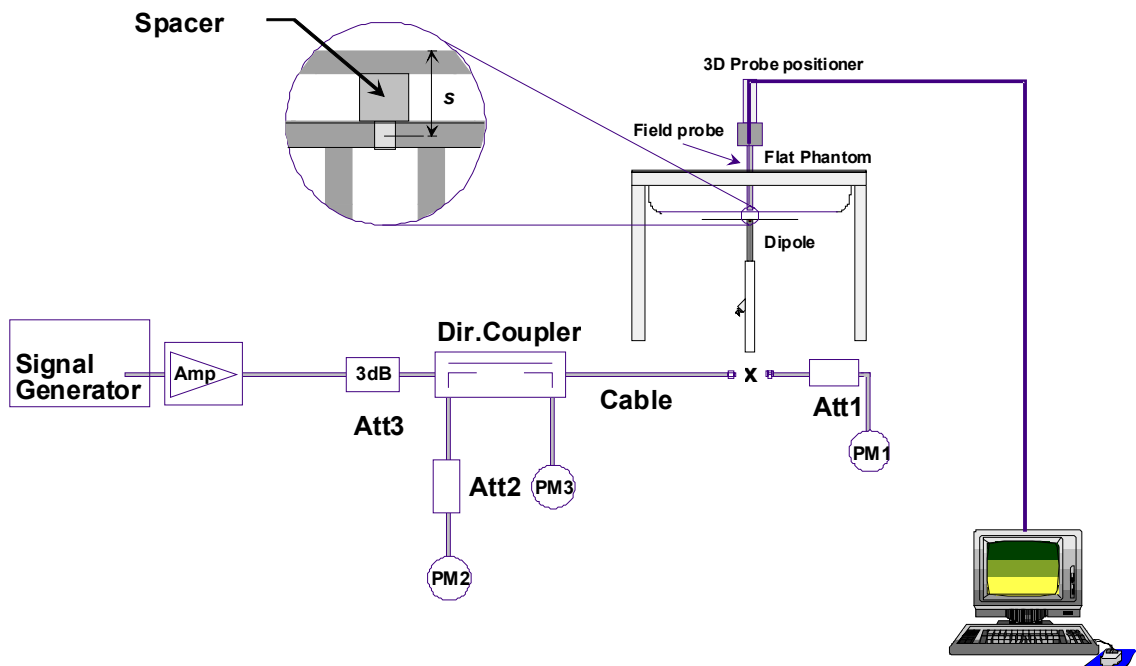

Fig. 8.1 System Setup for System Evaluation

1. Signal Generator
2. Amplifier
3. Directional Coupler
4. Power Meter
5. 835 MHz or 1900 MHz Dipole

The output power on dipole port must be calibrated to 20dBm (100mW) before dipole is connected.



**Fig 8.2 Dipole Setup**



**8.3 Validation Results**

Comparing to the original SAR value provided by SPEAG, the validation data should be within its specification of 10 %. Table 8.1 shows the target SAR and measured SAR after normalized to 1W input power. The table below indicates the system performance check can meet the variation criterion.

Frequency	SAR	Target (W/kg)	Measurement data (W/kg)	Variation	Measurement Date
835MHz	SAR (1g)	9.52	9.94	4.4 %	Mar. 07, 2009
	SAR (10g)	6.37	6.54	2.7 %	
1900MHz	SAR (1g)	40.1	43.3	8.0 %	Mar. 07, 2009
	SAR (10g)	21.3	22.8	7.0 %	

**Table 8.1 Target and Measurement Data Comparison**



## **9. Description for DUT Testing Position**

This DUT was tested in two different positions. One is “Bottom with 0 cm Gap with Antenna 0 degree” and the other is “Bottom with 0 cm Gap with Antenna 90 degree”.

Remark: Please refer to Appendix F for the test setup photos.



## 10. Measurement Procedures

The measurement procedures are as follows:

- Linking DUT with base station emulator CMU200
- Setting CMU200 to allow DUT to radiate maximum output power
- Measuring output power through RF cable and power meter
- Placing the DUT in the positions described in the last section
- Setting scan area, grid size and other setting on the DASY4 software
- Taking data for the lowest, middle, and highest channel

According to the OET Bulletin 65 Supplement C standard, the recommended procedure for assessing the peak spatial-average SAR value consists of the following steps:

- Power reference measurement
- Area scan
- Zoom scan
- Power reference measurement

### 10.1 Spatial Peak SAR Evaluation

The procedure for spatial peak SAR evaluation has been implemented according to the OET Bulletin 65 Supplement C standard. It can be conducted for 1g and 10g, as well as for user-specific masses. The DASY5 software includes all numerical procedures necessary to evaluate the spatial peak SAR value.

The base for the evaluation is a "cube" measurement. The measured volume must include the 1g and 10g cubes with the highest averaged SAR values. For that purpose, the center of the measured volume is aligned to the interpolated peak SAR value of a previously performed area scan.

The entire evaluation of the spatial peak values is performed within the post-processing engine (SEMCAD). The system always gives the maximum values for the 1g and 10g cubes. The algorithm to find the cube with highest averaged SAR is divided into the following stages:

- extraction of the measured data (grid and values) from the Zoom Scan
- calculation of the SAR value at every measurement point based on all stored data (A/D values and measurement parameters)
- generation of a high-resolution mesh within the measured volume
- interpolation of all measured values from the measurement grid to the high-resolution grid
- extrapolation of the entire 3-D field distribution to the phantom surface over the distance from sensor to surface
- calculation of the averaged SAR within masses of 1g and 10g



## **10.2 Scan Procedures**

First Area Scan is used to locate the approximate location(s) of the local peak SAR value(s). The measurement grid within an Area Scan is defined by the grid extent, grid step size and grid offset. Next, in order to determine the EM field distribution in a three-dimensional spatial extension, Zoom Scan is required. The Zoom Scan measures 5x5x7 points with step size 8, 8 and 5 mm. The Zoom Scan is performed around the highest E-field value to determine the averaged SAR-distribution over 1 g.

## **10.3 SAR Averaged Methods**

In DASYS, the interpolation and extrapolation are both based on the modified Quadratic Shepard's method. The interpolation scheme combines a least-square fitted function method and a weighted average method which are the two basic types of computational interpolation and approximation.

Extrapolation routines are used to obtain SAR values between the lowest measurement points and the inner phantom surface. The extrapolation distance is determined by the surface detection distance and the probe sensor offset. The uncertainty increases with the extrapolation distance. To keep the uncertainty within 1% for the 1 g and 10 g cubes, the extrapolation distance should not be larger than 5 mm.



## 11. SAR Test Results

### 11.1 Conducted Power

Conducted Power (dBm)						
Mode \ Band Channel	CDMA2000 Cellular			CDMA2000 PCS		
	1013	384	1013	384	1013	384
1xRTT RC1+SO55	23.08	22.63	22.41	21.50	22.30	21.53
1xRTT RC3+SO55	<b>23.21</b>	22.82	22.35	21.51	<b>22.33</b>	21.48
1xRTT RC3+SO32	22.32	21.85	21.63	20.88	21.57	20.83
1xEV-DO RTAP 9.6K	22.85	22.54	22.62	21.46	22.06	21.47
1xEV-DO RTAP 38.4K	22.97	22.70	22.83	21.56	22.25	21.54
1xEV-DO RTAP 153.6K	<b>23.27</b>	22.82	22.81	21.80	<b>22.35</b>	21.91
1xEV-DO RETAP 128K	22.64	22.18	22.14	21.19	21.85	21.17
1xEV-DO RETAP 2048K	<b>23.07</b>	22.63	22.62	21.60	22.32	21.67
1xEV-DO RETAP 12288K	22.02	21.55	21.54	21.78	<b>22.48</b>	21.15



11.2 Test Records for Body SAR Test

Position	Band	Mode	Ant. degree	Chan.	Freq. (MHz)	Modulation Type	Measured 1g SAR (W/kg)	Limit (W/kg)	Result
Bottom with 0cm Gap	CDMA2000 Cellular	1xRTT RC3_SO55	0	384	836.52	QPSK	1.02	1.6	Pass
Bottom with 0cm Gap	CDMA2000 Cellular	1xRTT RC3_SO55	90	384	836.52	QPSK	0.609	1.6	Pass
Bottom with 0cm Gap	CDMA2000 Cellular	1xEV-DO RTAP_153.6K	0	384	836.52	QPSK	1.06	1.6	Pass
Bottom with 0cm Gap	CDMA2000 Cellular	1xEV-DO RETAP_2048K	0	384	836.52	QPSK	1.01	1.6	Pass
Bottom with 0cm Gap	CDMA2000 Cellular	1xRTT RC3_SO55	0	1013	824.70	QPSK	1.1	1.6	Pass
Bottom with 0cm Gap	CDMA2000 Cellular	1xRTT RC3_SO55	0	777	848.31	QPSK	0.835	1.6	Pass
Bottom with 0cm Gap	CDMA2000 Cellular	1xEV-DO RTAP_153.6K	0	1013	824.70	QPSK	1.08	1.6	Pass
Bottom with 0cm Gap	CDMA2000 Cellular	1xEV-DO RTAP_153.6K	0	777	848.31	QPSK	0.841	1.6	Pass
<b>Bottom with 0cm Gap</b>	<b>CDMA2000 Cellular</b>	<b>1xEV-DO RETAP_2048K</b>	<b>0</b>	<b>1013</b>	<b>824.70</b>	<b>QPSK</b>	<b>1.11</b>	<b>1.6</b>	<b>Pass</b>
Bottom with 0cm Gap	CDMA2000 Cellular	1xEV-DO RETAP_2048K	0	777	848.31	QPSK	0.839	1.6	Pass
Bottom with 0cm Gap	CDMA2000 PCS	1xRTT RC3_SO55	0	600	1880.00	QPSK	1.5	1.6	Pass
Bottom with 0cm Gap	CDMA2000 PCS	1xRTT RC3_SO55	90	600	1880.00	QPSK	1.09	1.6	Pass
<b>Bottom with 0cm Gap</b>	<b>CDMA2000 PCS</b>	<b>1xEV-DO RTAP_153.6K</b>	<b>0</b>	<b>600</b>	<b>1880.00</b>	<b>QPSK</b>	<b>1.54</b>	<b>1.6</b>	<b>Pass</b>
Bottom with 0cm Gap	CDMA2000 PCS	1xEV-DO RETAP_12288K	0	600	1880.00	QPSK	1.54	1.6	Pass
Bottom with 0cm Gap	CDMA2000 PCS	1xRTT RC3_SO55	0	25	1851.25	QPSK	1.3	1.6	Pass
Bottom with 0cm Gap	CDMA2000 PCS	1xRTT RC3_SO55	0	1175	1908.75	QPSK	1.16	1.6	Pass
Bottom with 0cm Gap	CDMA2000 PCS	1xEV-DO RTAP_153.6K	0	25	1851.25	QPSK	1.34	1.6	Pass
Bottom with 0cm Gap	CDMA2000 PCS	1xEV-DO RTAP_153.6K	0	1175	1908.75	QPSK	1.22	1.6	Pass
Bottom with 0cm Gap	CDMA2000 PCS	1xEV-DO RETAP_12288K	0	25	1851.25	QPSK	1.38	1.6	Pass
Bottom with 0cm Gap	CDMA2000 PCS	1xEV-DO RETAP_12288K	0	1175	1908.75	QPSK	1.12	1.6	Pass

Test Engineer : Eric Huang and Robert Liu



## **12. References**

- [1] FCC 47 CFR Part 2 "Frequency Allocations and Radio Treaty Matters; General Rules and Regulations"
- [2] IEEE Std. P1528-2003, "Recommended Practice for Determining the Peak Spatial-Average Specific Absorption Rate (SAR) in the Human Head from Wireless Communications Devices: Measurement Techniques", April 21, 2003
- [3] Supplement C (Edition 01-01) to OET Bulletin 65 (Edition 97-01), "Additional Information for Evaluating Compliance of Mobile and Portable Devices with FCC Limits for Human Exposure to RF Emissions", June 2001
- [4] IEEE Std. C95.1-1999, "IEEE Standard for Safety Levels with Respect to Human Exposure to Radio Frequency Electromagnetic Fields, 3 kHz to 300 GHz", 1999
- [5] Robert J. Renka, "Multivariate Interpolation Of Large Sets Of Scattered Data", University of North Texas ACM Transactions on Mathematical Software, vol. 14, no. 2, June 1988, pp. 139-148
- [6] DASY5 System Handbook
- [7] KDB 941225 D01 v02, "SAR Measurement Procedures for 3G Devices", October 2007
- [8] KDB 941225 D01 SAR test for 3G devices v02, SAR Measurement Procedures for 3G Devices CDMA 2000/Ev-Do/WCDMA/HSDPA/HSPA Oct. 2007 Laboratory Division Office of Engineering and Technology Federal Communications Commission



### Appendix A - System Performance Check Data

Test Laboratory: Sporton International Inc. SAR/HAC Testing Lab

Date: 2009/3/7

#### System Check\_Body\_835MHz\_090307

DUT: Dipole 835 MHz

Communication System: CW; Frequency: 835 MHz; Duty Cycle: 1:1

Medium: MSL\_850 Medium parameters used:  $f = 835 \text{ MHz}$ ;  $\sigma = 0.983 \text{ mho/m}$ ;  $\epsilon_r = 54.4$ ;  $\rho = 1000 \text{ kg/m}^3$

Ambient Temperature : 22.4 ; Liquid Temperature : 21.2

DASY5 Configuration:

- Probe: ET3DV6 - SN1787; ConvF(5.91, 5.91, 5.91); Calibrated: 2008/8/26
- Sensor-Surface: 4mm (Mechanical Surface Detection)
- Electronics: DAE3 Sn577; Calibrated: 2008/11/12
- Phantom: SAM - Front; Type: SAM; Serial: TP-1446
- Measurement SW: DASY5, V5.0 Build 125; SEMCAD X Version 13.4 Build 125

**Pin=100mW/Area Scan (61x61x1):** Measurement grid:  $dx=15\text{mm}$ ,  $dy=15\text{mm}$

Maximum value of SAR (interpolated) = 1.09 mW/g

**Pin=100mW/Zoom Scan (7x7x7)/Cube 0:** Measurement grid:  $dx=5\text{mm}$ ,  $dy=5\text{mm}$ ,  $dz=5\text{mm}$

Reference Value = 34.6 V/m; Power Drift = -0.039 dB

Peak SAR (extrapolated) = 1.4 W/kg

**SAR(1 g) = 0.994 mW/g; SAR(10 g) = 0.654 mW/g**

Maximum value of SAR (measured) = 1.08 mW/g

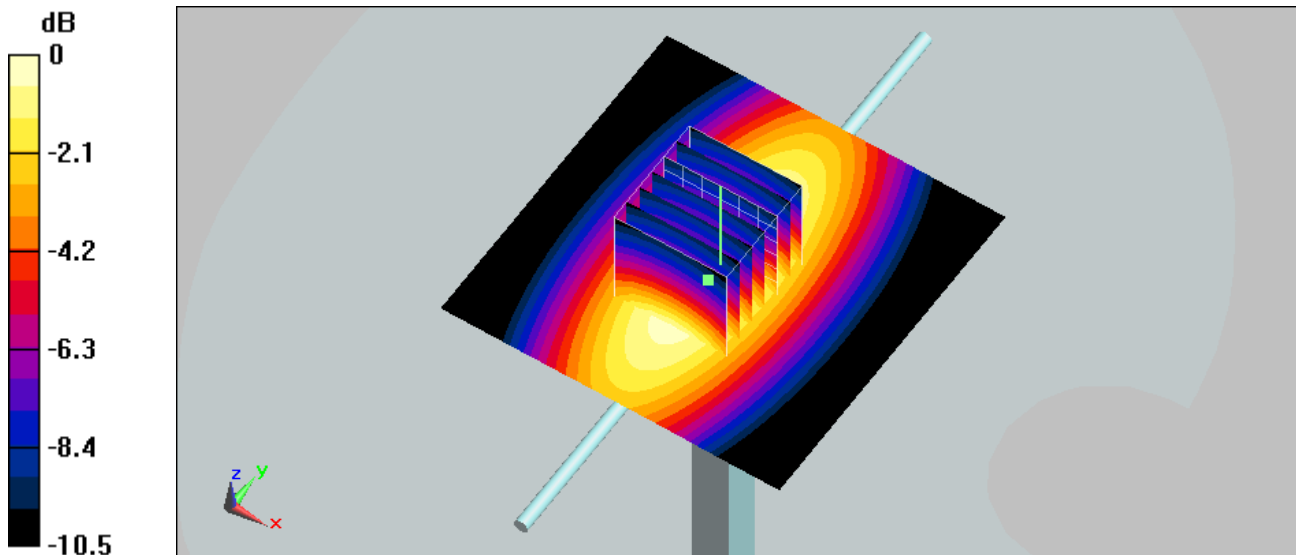

0 dB = 1.08mW/g



Test Laboratory: Sporton International Inc. SAR/HAC Testing Lab

Date: 2009/3/7

**System Check\_Body\_1900MHz\_090307**

**DUT: Dipole 1900 MHz**

Communication System: CW; Frequency: 1900 MHz; Duty Cycle: 1:1  
Medium: MSL\_1900 Medium parameters used:  $f = 1900$  MHz;  $\sigma = 1.54$  mho/m;  $\epsilon_r = 52.5$ ;  $\rho = 1000$  kg/m<sup>3</sup>  
Ambient Temperature : 22.5 ; Liquid Temperature : 21.4

DASY5 Configuration:

- Probe: ET3DV6 - SN1787; ConvF(4.49, 4.49, 4.49); Calibrated: 2008/8/26
- Sensor-Surface: 4mm (Mechanical Surface Detection)
- Electronics: DAE3 Sn577; Calibrated: 2008/11/12
- Phantom: SAM-Back; Type: QD 000 P40 C; Serial: TP-1383
- Measurement SW: DASY5, V5.0 Build 125; SEMCAD X Version 13.4 Build 125

**Pin=100mW/Area Scan (91x91x1):** Measurement grid: dx=10mm, dy=10mm  
Maximum value of SAR (interpolated) = 5 mW/g

**Pin=100mW/Zoom Scan (7x7x7)/Cube 0:** Measurement grid: dx=5mm, dy=5mm, dz=5mm  
Reference Value = 58.8 V/m; Power Drift = -0.016 dB  
Peak SAR (extrapolated) = 7.88 W/kg  
**SAR(1 g) = 4.33 mW/g; SAR(10 g) = 2.28 mW/g**  
Maximum value of SAR (measured) = 4.87 mW/g

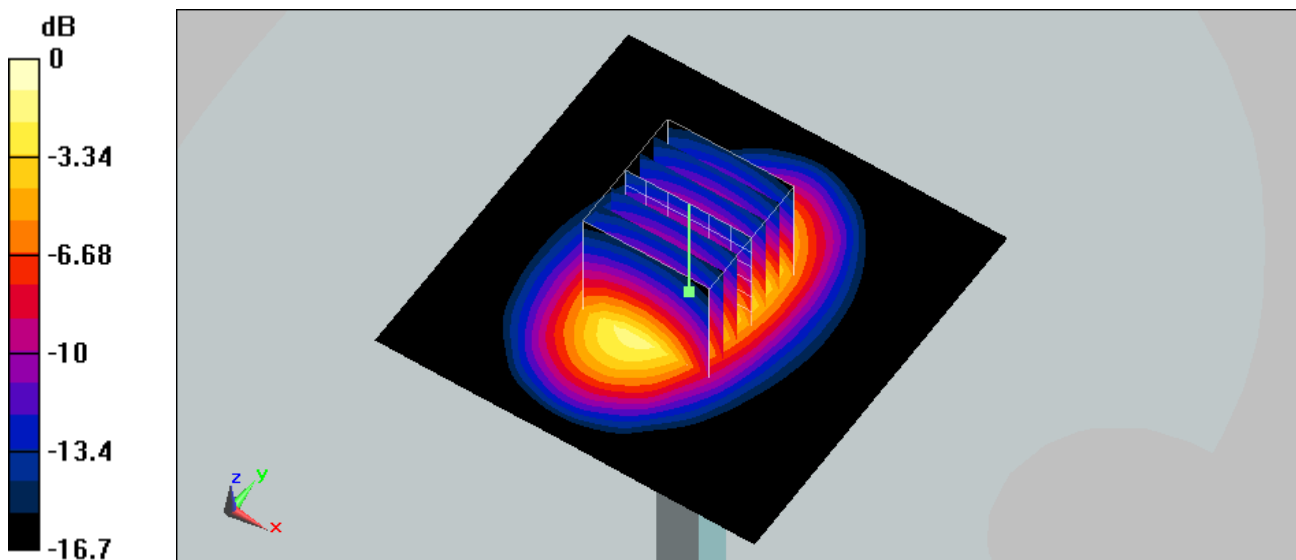

0 dB = 4.87mW/g



### Appendix B - SAR Measurement Data

Test Laboratory: Sporton International Inc. SAR/HAC Testing Lab

Date: 2009/3/7

Body\_CDMA850 Ch384\_Bottom with 0cm Gap\_RC3\_SO55\_Ant with 90 degree

DUT: 922024

Communication System: CDMA ; Frequency: 836.52 MHz;Duty Cycle: 1:1

Medium: MSL\_850 Medium parameters used: f = 837 MHz;  $\sigma$  = 0.985 mho/m;  $\epsilon_r$  = 54.4;  $\rho$  = 1000 kg/m<sup>3</sup>

Ambient Temperature : 22.4 ; Liquid Temperature : 21.2

DASY5 Configuration:

- Probe: ET3DV6 - SN1787; ConvF(5.91, 5.91, 5.91); Calibrated: 2008/8/26
- Sensor-Surface: 4mm (Mechanical Surface Detection)
- Electronics: DAE3 Sn577; Calibrated: 2008/11/12
- Phantom: SAM - Front; Type: SAM; Serial: TP-1446
- Measurement SW: DASY5, V5.0 Build 125; SEMCAD X Version 13.4 Build 125

Ch384/Area Scan (91x161x1): Measurement grid: dx=15mm, dy=15mm

Maximum value of SAR (interpolated) = 0.654 mW/g

Ch384/Zoom Scan (5x5x7)/Cube 0: Measurement grid: dx=8mm, dy=8mm, dz=5mm

Reference Value = 7.61 V/m; Power Drift = -0.118 dB

Peak SAR (extrapolated) = 0.787 W/kg

**SAR(1 g) = 0.609 mW/g; SAR(10 g) = 0.427 mW/g**

Maximum value of SAR (measured) = 0.649 mW/g

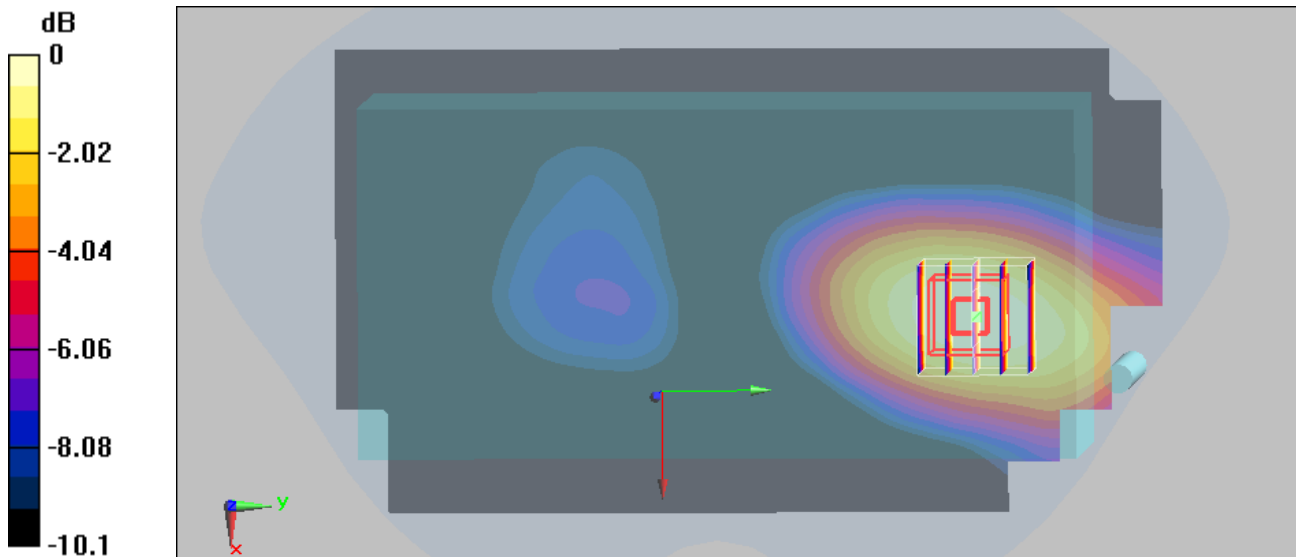

0 dB = 0.649mW/g





Test Laboratory: Sporton International Inc. SAR/HAC Testing Lab

Date: 2009/3/7

**Body\_CDMA850 Ch1013\_Bottom with 0cm Gap\_RETAP\_2048\_Ant with 0 degree**

**DUT: 922024**

Communication System: CDMA ; Frequency: 824.7 MHz;Duty Cycle: 1:1

Medium: MSL\_850 Medium parameters used: f = 825 MHz;  $\sigma$  = 0.972 mho/m;  $\epsilon_r$  = 54.6;  $\rho$  = 1000 kg/m<sup>3</sup>

Ambient Temperature : 22.4 ; Liquid Temperature : 21.2

DASY5 Configuration:

- Probe: ET3DV6 - SN1787; ConvF(5.91, 5.91, 5.91); Calibrated: 2008/8/26
- Sensor-Surface: 4mm (Mechanical Surface Detection)
- Electronics: DAE3 Sn577; Calibrated: 2008/11/12
- Phantom: SAM - Front; Type: SAM; Serial: TP-1446
- Measurement SW: DASY5, V5.0 Build 125; SEMCAD X Version 13.4 Build 125

**Ch1013/Area Scan (91x161x1):** Measurement grid: dx=15mm, dy=15mm

Maximum value of SAR (interpolated) = 1.15 mW/g

**Ch1013/Zoom Scan (5x5x7)/Cube 0:** Measurement grid: dx=8mm, dy=8mm, dz=5mm

Reference Value = 10 V/m; Power Drift = -0.147 dB

Peak SAR (extrapolated) = 1.86 W/kg

**SAR(1 g) = 1.11 mW/g; SAR(10 g) = 0.754 mW/g**

Maximum value of SAR (measured) = 1.2 mW/g

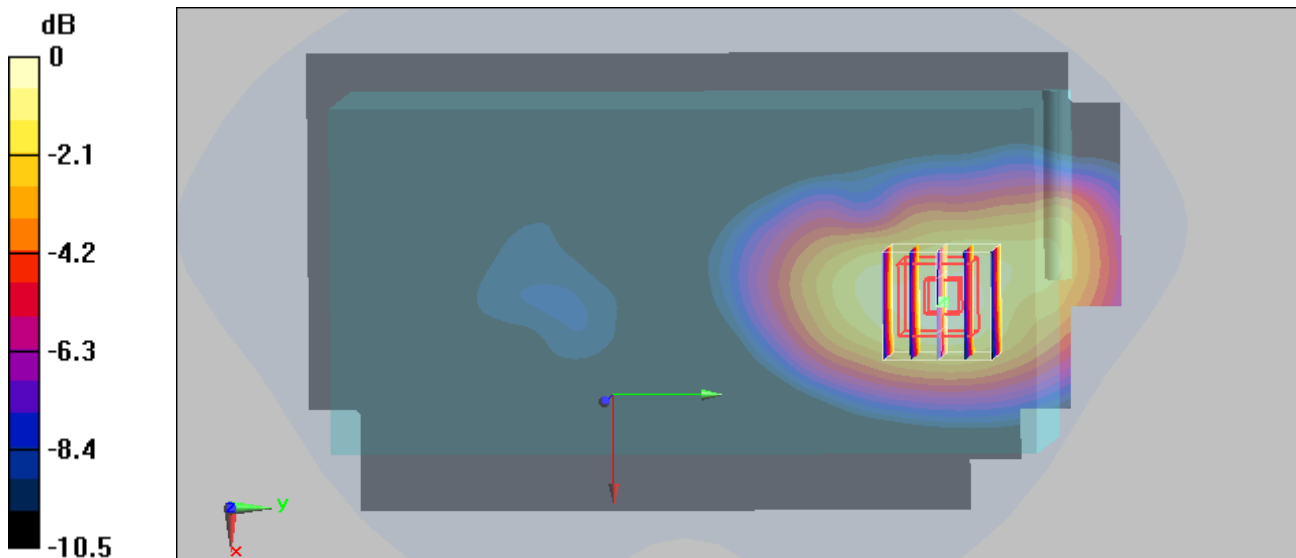

0 dB = 1.2mW/g



Test Laboratory: Sporton International Inc. SAR/HAC Testing Lab

Date: 2009/3/7

**Body\_CDMA1900 Ch600\_Bottom with 0cm Gap\_RC3\_SO55\_Ant with 90 degree**

**DUT: 922024**

Communication System: CDMA ; Frequency: 1880 MHz;Duty Cycle: 1:1  
Medium: MSL\_1900 Medium parameters used: f = 1880 MHz;  $\sigma = 1.52$  mho/m;  $\epsilon_r = 52.6$ ;  $\rho = 1000$  kg/m<sup>3</sup>  
Ambient Temperature : 22.5 ; Liquid Temperature : 21.4

DASY5 Configuration:

- Probe: ET3DV6 - SN1787; ConvF(4.49, 4.49, 4.49); Calibrated: 2008/8/26
- Sensor-Surface: 4mm (Mechanical Surface Detection)
- Electronics: DAE3 Sn577; Calibrated: 2008/11/12
- Phantom: SAM-Back; Type: QD 000 P40 C; Serial: TP-1383
- Measurement SW: DASY5, V5.0 Build 125; SEMCAD X Version 13.4 Build 125

**Ch600/Area Scan (91x161x1):** Measurement grid: dx=15mm, dy=15mm  
Maximum value of SAR (interpolated) = 1.21 mW/g

**Ch600/Zoom Scan (5x5x7)/Cube 0:** Measurement grid: dx=8mm, dy=8mm, dz=5mm  
Reference Value = 16.2 V/m; Power Drift = 0.144 dB  
Peak SAR (extrapolated) = 1.86 W/kg  
**SAR(1 g) = 1.09 mW/g; SAR(10 g) = 0.648 mW/g**  
Maximum value of SAR (measured) = 1.18 mW/g

**Ch600/Zoom Scan (5x5x7)/Cube 1:** Measurement grid: dx=8mm, dy=8mm, dz=5mm  
Reference Value = 16.2 V/m; Power Drift = 0.144 dB  
Peak SAR (extrapolated) = 1.09 W/kg  
**SAR(1 g) = 0.715 mW/g; SAR(10 g) = 0.458 mW/g**  
Maximum value of SAR (measured) = 0.760 mW/g

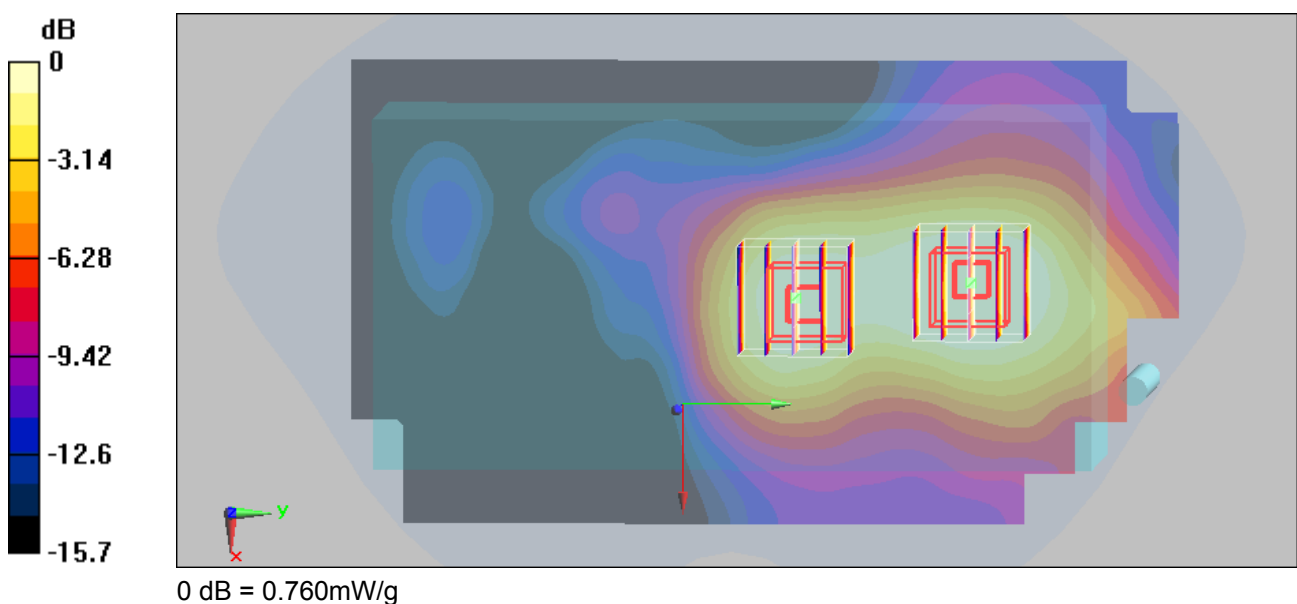



Test Laboratory: Sporton International Inc. SAR/HAC Testing Lab

Date: 2009/3/7

**Body\_CDMA1900 Ch600\_Bottom with 0cm Gap\_RTAP\_153.6K\_Ant with 0 degree**

**DUT: 922024**

Communication System: CDMA ; Frequency: 1880 MHz;Duty Cycle: 1:1  
Medium: MSL\_1900 Medium parameters used: f = 1880 MHz;  $\sigma = 1.52$  mho/m;  $\epsilon_r = 52.6$ ;  $\rho = 1000$  kg/m<sup>3</sup>  
Ambient Temperature : 22.5 ; Liquid Temperature : 21.4

DASY5 Configuration:

- Probe: ET3DV6 - SN1787; ConvF(4.49, 4.49, 4.49); Calibrated: 2008/8/26
- Sensor-Surface: 4mm (Mechanical Surface Detection)
- Electronics: DAE3 Sn577; Calibrated: 2008/11/12
- Phantom: SAM-Back; Type: QD 000 P40 C; Serial: TP-1383
- Measurement SW: DASY5, V5.0 Build 125; SEMCAD X Version 13.4 Build 125

**Ch600/Area Scan (91x161x1):** Measurement grid: dx=15mm, dy=15mm  
Maximum value of SAR (interpolated) = 1.67 mW/g

**Ch600/Zoom Scan (5x5x7)/Cube 0:** Measurement grid: dx=8mm, dy=8mm, dz=5mm  
Reference Value = 16.3 V/m; Power Drift = 0.035 dB  
Peak SAR (extrapolated) = 2.59 W/kg  
**SAR(1 g) = 1.54 mW/g; SAR(10 g) = 0.931 mW/g**  
Maximum value of SAR (measured) = 1.65 mW/g

**Ch600/Zoom Scan (5x5x7)/Cube 1:** Measurement grid: dx=8mm, dy=8mm, dz=5mm  
Reference Value = 16.3 V/m; Power Drift = 0.035 dB  
Peak SAR (extrapolated) = 2.08 W/kg  
**SAR(1 g) = 1.05 mW/g; SAR(10 g) = 0.615 mW/g**  
Maximum value of SAR (measured) = 1.14 mW/g

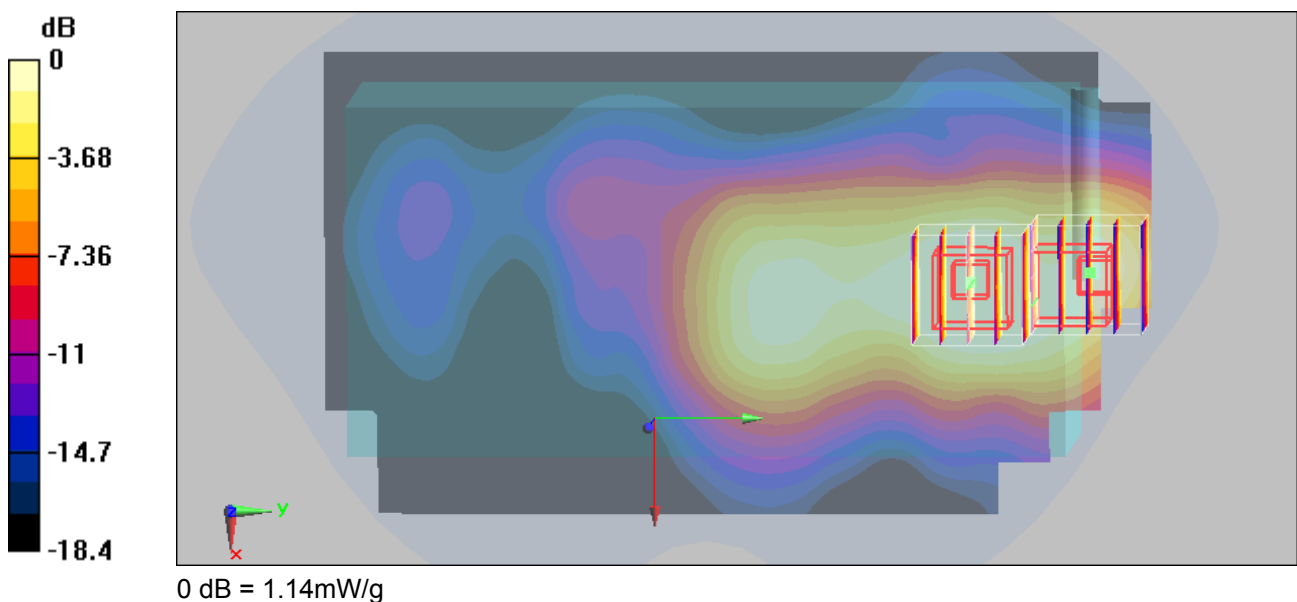



Test Laboratory: Sporton International Inc. SAR/HAC Testing Lab

Date: 2009/3/7

**Body\_CDMA850 Ch1013\_Bottom with 0cm Gap\_RETAP\_2048\_Ant with 0 degree\_2D**

**DUT: 922024**

Communication System: CDMA ; Frequency: 824.7 MHz; Duty Cycle: 1:1  
Medium: MSL\_850 Medium parameters used:  $f = 825$  MHz;  $\sigma = 0.972$  mho/m;  $\epsilon_r = 54.6$ ;  $\rho = 1000$  kg/m<sup>3</sup>  
Ambient Temperature : 22.4 ; Liquid Temperature : 21.2

DASY5 Configuration:

- Probe: ET3DV6 - SN1787; ConvF(5.91, 5.91, 5.91); Calibrated: 2008/8/26
- Sensor-Surface: 4mm (Mechanical Surface Detection)
- Electronics: DAE3 Sn577; Calibrated: 2008/11/12
- Phantom: SAM - Front; Type: SAM; Serial: TP-1446
- Measurement SW: DASY5, V5.0 Build 125; SEMCAD X Version 13.4 Build 125

**Ch1013/Area Scan (91x161x1):** Measurement grid: dx=15mm, dy=15mm  
Maximum value of SAR (interpolated) = 1.15 mW/g

**Ch1013/Zoom Scan (5x5x7)/Cube 0:** Measurement grid: dx=8mm, dy=8mm, dz=5mm  
Reference Value = 10 V/m; Power Drift = -0.147 dB  
Peak SAR (extrapolated) = 1.86 W/kg  
**SAR(1 g) = 1.11 mW/g; SAR(10 g) = 0.754 mW/g**  
Maximum value of SAR (measured) = 1.2 mW/g

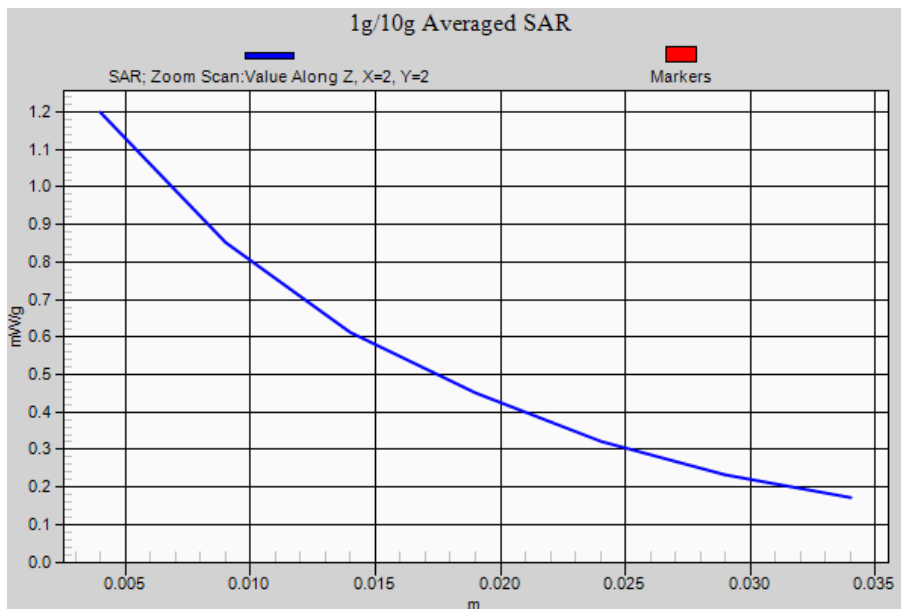



Test Laboratory: Sporton International Inc. SAR/HAC Testing Lab

Date: 2009/3/7

Body\_CDMA1900 Ch600\_Bottom with 0cm Gap\_RTAP\_153.6K\_Ant with 0 degree\_2D

DUT: 922024

Communication System: CDMA ; Frequency: 1880 MHz;Duty Cycle: 1:1  
Medium: MSL\_1900 Medium parameters used: f = 1880 MHz;  $\sigma = 1.52$  mho/m;  $\epsilon_r = 52.6$ ;  $\rho = 1000$  kg/m<sup>3</sup>  
Ambient Temperature : 22.5 ; Liquid Temperature : 21.4

DASY5 Configuration:

- Probe: ET3DV6 - SN1787; ConvF(4.49, 4.49, 4.49); Calibrated: 2008/8/26
- Sensor-Surface: 4mm (Mechanical Surface Detection)
- Electronics: DAE3 Sn577; Calibrated: 2008/11/12
- Phantom: SAM-Back; Type: QD 000 P40 C; Serial: TP-1383
- Measurement SW: DASY5, V5.0 Build 125; SEMCAD X Version 13.4 Build 125

**Ch600/Area Scan (91x161x1):** Measurement grid: dx=15mm, dy=15mm  
Maximum value of SAR (interpolated) = 1.67 mW/g

**Ch600/Zoom Scan (5x5x7)/Cube 0:** Measurement grid: dx=8mm, dy=8mm, dz=5mm  
Reference Value = 16.3 V/m; Power Drift = 0.035 dB  
Peak SAR (extrapolated) = 2.59 W/kg  
**SAR(1 g) = 1.54 mW/g; SAR(10 g) = 0.931 mW/g**  
Maximum value of SAR (measured) = 1.65 mW/g

**Ch600/Zoom Scan (5x5x7)/Cube 1:** Measurement grid: dx=8mm, dy=8mm, dz=5mm  
Reference Value = 16.3 V/m; Power Drift = 0.035 dB  
Peak SAR (extrapolated) = 2.08 W/kg  
**SAR(1 g) = 1.05 mW/g; SAR(10 g) = 0.615 mW/g**  
Maximum value of SAR (measured) = 1.14 mW/g

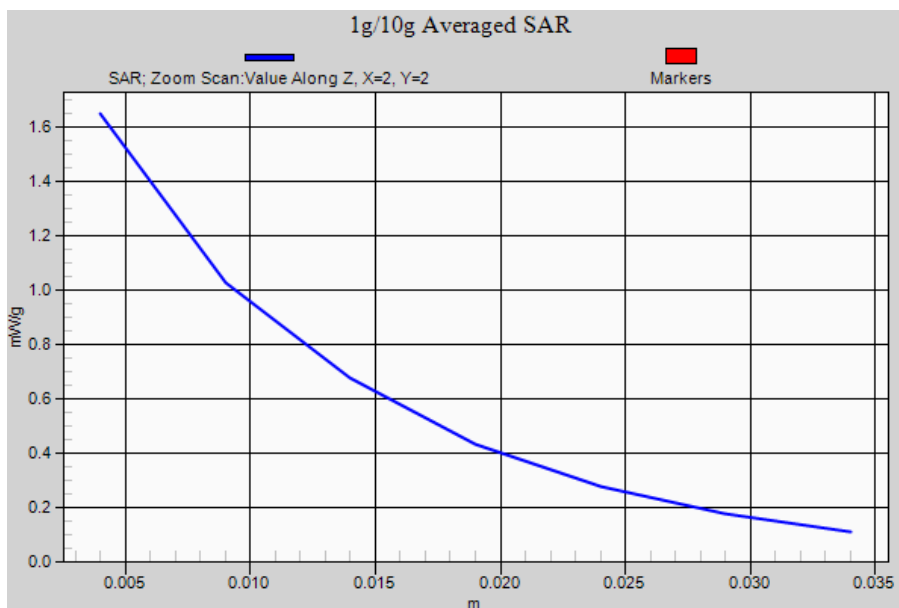



## ***Appendix C – Calibration Data***

Please refer to the calibration certificates of DASY as below.