



VARIANT FCC TEST REPORT (RFID)

REPORT NO.: RF111021C03A-1

MODEL NO.: VX600 Bluetooth

FCC ID: B32VX600BTCTLS

RECEIVED: Feb. 10, 2012

TESTED: Feb. 17 ~ Feb. 18, 2012

ISSUED: Feb. 22, 2012

APPLICANT: VeriFone, Inc.

ADDRESS: 1400 West Stanford Ranch Road Suit 200 Rocklin CA
95765 USA

ISSUED BY: Bureau Veritas Consumer Products Services (H.K.)
Ltd., Taoyuan Branch

LAB ADDRESS: No. 47, 14th Ling, Chia Pau Vil., Lin Kou Dist., New
Taipei City, Taiwan (R.O.C.)

TEST LOCATION: No. 19, Hwa Ya 2nd Rd, Wen Hwa Tsuen, Kwei Shan
Hsiang, Taoyuan Hsien 333, Taiwan, R.O.C.

This test report consists of 30 pages in total. It may be duplicated completely for legal use with the approval of the applicant. It should not be reproduced except in full, without the written approval of our laboratory. The client should not use it to claim product, certification, approval or endorsement by TAF or any government agency. The test results in the report only apply to the tested sample. The test results in this report are traceable to the national or international standards.





Table of Contents

RELEASE CONTROL RECORD	4
1. CERTIFICATION	5
2. SUMMARY OF TEST RESULTS	6
2.1 MEASUREMENT UNCERTAINTY	6
3. GENERAL INFORMATION.....	7
3.1 GENERAL DESCRIPTION OF EUT.....	7
3.2 DESCRIPTION OF TEST MODES.....	8
3.2.1 CONFIGURATION OF SYSTEM UNDER TEST	8
3.2.2 TEST MODE APPLICABILITY AND TESTED CHANNEL DETAIL.....	9
3.3 GENERAL DESCRIPTION OF APPLIED STANDARDS	10
3.4 DESCRIPTION OF SUPPORT UNITS	10
4. TEST TYPES AND RESULTS	11
4.1 RADIATED EMISSION MEASUREMENT	11
4.1.1 LIMITS OF RADIATED EMISSION MEASUREMENT.....	11
4.1.2 TEST INSTRUMENTS	12
4.1.3 TEST PROCEDURES	13
4.1.4 DEVIATION FROM TEST STANDARD	13
4.1.5 TEST SETUP	14
4.1.6 EUT OPERATING CONDITIONS.....	14
4.1.7 TEST RESULTS	15
4.2 CONDUCTED EMISSION MEASUREMENT	19
4.2.1 LIMITS OF CONDUCTED EMISSION MEASUREMENT.....	19
4.2.2 TEST INSTRUMENTS	19
4.2.3 TEST PROCEDURES	20
4.2.4 DEVIATION FROM TEST STANDARD	20
4.2.5 TEST SETUP	21
4.2.6 EUT OPERATING CONDITIONS.....	21
4.2.7 TEST RESULTS	22
4.3 20dB BANDWIDTH	26
4.3.1 LIMITS OF 20dB BANDWIDTH MEASUREMENT	26
4.3.2 TEST INSTRUMENTS	26
4.3.3 TEST PROCEDURE	26
4.3.4 DEVIATION FROM TEST STANDARD	26



A D T

4.3.5	TEST SETUP	26
4.3.6	EUT OPERATING CONDITION	26
4.3.7	TEST RESULTS	27
5.	PHOTOGRAPHS OF THE TEST CONFIGURATION.....	28
6.	INFORMATION ON THE TESTING LABORATORIES	29
7.	APPENDIX A - MODIFICATIONS RECORDERS FOR ENGINEERING CHANGES TO THE EUT BY THE LAB.....	30



A D T

RELEASE CONTROL RECORD

ISSUE NO.	REASON FOR CHANGE	DATE ISSUED
Original release	NA	Feb. 22, 2012



1. CERTIFICATION

PRODUCT: Point of Sale Terminal
MODEL NO.: VX600 Bluetooth
BRAND: VeriFone
APPLICANT: VeriFone, Inc.
TESTED: Feb. 17 ~ Feb. 18, 2012
TEST SAMPLE: ENGINEERING SAMPLE
STANDARDS: **FCC Part 15, Subpart C (Section 15.225)**
FCC Part 15, Subpart C (Section 15.215)
ANSI C63.4-2003
ANSI C63.10-2009

This report is issued as a supplementary report of RF111021C03-1 R1. This report shall be used combined together with its original report.

PREPARED BY : Ivy Lin, **DATE:** Feb. 22, 2012
Ivy Lin / Specialist

APPROVED BY : Gary Chang **DATE:** Feb. 22, 2012
Gary Chang / Technical Manager

NOTE: The conducted emission, radiated emission & 20dB Bandwidth tests were performed for the addendum. Refer to original report for the other test data.

2. SUMMARY OF TEST RESULTS

The EUT has been tested according to the following specifications:

APPLIED STANDARD: FCC PART 15, SUBPART C (SECTION 15.225, 15.215)			
STANDARD SECTION	TEST TYPE AND LIMIT	RESULT	REMARK
15.207	Conducted emission test	PASS	Meet the requirement of limit. Minimum passing margin is -6.05dB at 0.150MHz.
15.225 (a)	The field strength of any emissions within the band 13.553-13.567 MHz	PASS	Meet the requirement of limit. Minimum passing margin is -50.5dB at 13.56MHz.
15.225 (d)	The field strength of any emissions appearing outside of the 13.110-14.010 MHz band	PASS	Meet the requirement of limit. Minimum passing margin is -6.3dB at 199.05MHz.
15.225 (e)	The frequency tolerance	NA	Refer to Note
15.215 (c)	20dB Bandwidth	PASS	Meet the requirement of limit.

NOTE: The conducted emission, radiated emission & 20dB Bandwidth tests were performed for the addendum. Refer to original report for the other test data.

2.1 MEASUREMENT UNCERTAINTY

Where relevant, the following measurement uncertainty levels have been estimated for tests performed on the EUT as specified in CISPR 16-4-2:

MEASUREMENT	FREQUENCY	UNCERTAINTY
Conducted Emission	150kHz ~ 30MHz	2.44 dB
Radiated emissions	30MHz ~ 200MHz	3.19 dB
	200MHz ~1000MHz	3.21 dB

This uncertainty represents an expanded uncertainty expressed at approximately the 95% confidence level using a coverage factor of k=2.

3. GENERAL INFORMATION

3.1 GENERAL DESCRIPTION OF EUT

EUT	Point of Sale Terminal
MODEL NO.	VX600 Bluetooth
FCC ID	B32VX600BTCTLS
POWER SUPPLY	5Vdc (host equipment) 3.7Vdc (battery)
MODULATION TYPE	ASK
OPERATING FREQUENCY	13.56MHz
ANTENNA TYPE	Fix internal antenna
DATA CABLE	Refer to note as below
I/O PORTS	Refer to user's manual
ACCESSORY DEVICES	Battery

NOTE:

1. This report is prepared for FCC class II permissive change. This report is issued as a supplementary report of BV ADT report no.: RF111021C03-1 R1. The difference compared with original report is without bar code function. Therefore, test items of conducted emission, radiated emission & 20dB Bandwidth are re-tested and presented in the test report.
2. The RFID module (brand: VeriFone) module is collocated in this EUT.
3. The EUT uses the following USB cables.

Brand Name	Model No.	Cable length
HUIZHOU SHENGHUA INDUSTRY CO.,	CBL000-021-01-A	1m non-shielded mini USB cable without core

4. The EUT uses following battery.

Battery	
Brand	VeriFone
Model	BPK087-201
Power Rating	3.7Vdc, 1380mAh

5. The above EUT information is declared by manufacturer and for more detailed feature description, please refer to the manufacturer's specifications or user's manual.

3.2 DESCRIPTION OF TEST MODES

The EUT only have one channel.

CHANNEL	FREQUENCY (MHz)
1	13.56

3.2.1 CONFIGURATION OF SYSTEM UNDER TEST

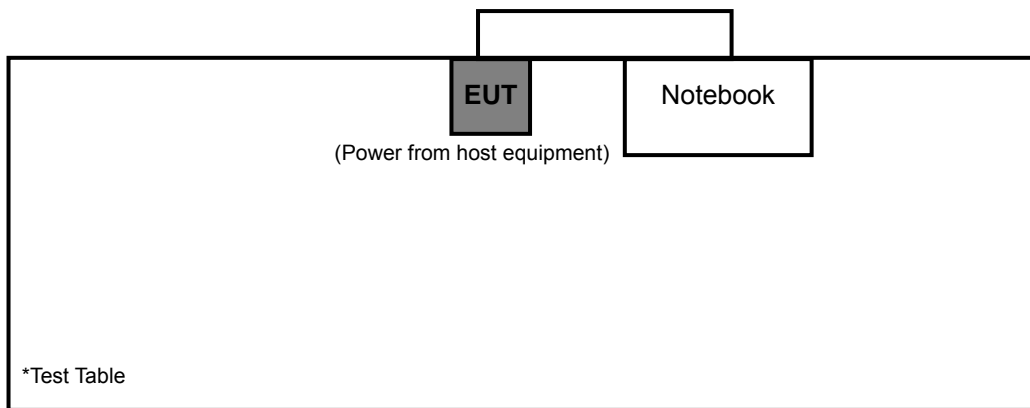



3.2.2 TEST MODE APPLICABILITY AND TESTED CHANNEL DETAIL

EUT CONFIGURE MODE	APPLICABLE TO			DESCRIPTION
	RE	PLC	BW	
-	√	√	√	EUT USB link + notebook + RFID on + BT off + smart card looping + battery charging

Where **RE:** Radiated Emission **PLC:** Power Line Conducted Emission
BW: 20dB Bandwidth

NOTE:

1. The EUT had been pre-tested on the positioned of each 3 axis. The worst case was found when positioned on **Z-plane**
2. The EUT was tested the above mode which was defined by client.

RADIATED EMISSION TEST:

- Pre-Scan has been conducted to determine the worst-case mode from all possible combinations between available modulations antenna ports (if EUT with antenna diversity architecture).
- Following channel(s) was (were) selected for the final test as listed below.

EUT CONFIGURE MODE	AVAILABLE CHANNEL	TESTED CHANNEL	MODULATION TYPE
-	1	1	ASK

POWER LINE CONDUCTED EMISSION TEST:

- Pre-Scan has been conducted to determine the worst-case mode from all possible combinations between available modulations and antenna ports (if EUT with antenna diversity architecture).
- Following channel(s) was (were) selected for the final test as listed below.

EUT CONFIGURE MODE	AVAILABLE CHANNEL	TESTED CHANNEL	MODULATION TYPE
-	1	1	ASK

20dB BANDWIDTH:

- Pre-Scan has been conducted to determine the worst-case mode from all possible combinations between available modulations, antenna ports (if EUT with antenna diversity architecture).
- Following channel(s) was (were) selected for the final test as listed below.

EUT CONFIGURE MODE	AVAILABLE CHANNEL	TESTED CHANNEL	MODULATION TYPE
-	1	1	ASK

TEST CONDITION:

APPLICABLE TO	ENVIRONMENTAL CONDITIONS	INPUT POWER (SYSTEM)	TESTED BY
RE	25deg. C, 65%RH	120Vac, 60Hz	Mark Liao
PLC	25deg. C, 65%RH	120Vac, 60Hz	Mark Liao
BW	25deg. C, 65%RH	120Vac, 60Hz	Mark Liao



3.3 GENERAL DESCRIPTION OF APPLIED STANDARDS

The EUT is a RFID Product. According to the specifications of the manufacturer, it must comply with the requirements of the following standards:

FCC Part 15, Subpart C (15.225)

FCC Part 15, Subpart C (15.215)

ANSI C63.4-2003

ANSI C63.10-2009

All test items have been performed and recorded as per the above standards.

NOTE: The EUT is also considered as a kind of computer peripheral, because the connection to computer is necessary for typical use. It has been verified to comply with the requirements of FCC Part 15, Subpart B, Class B. The test report has been issued separately.

3.4 DESCRIPTION OF SUPPORT UNITS

NO.	PRODUCT	BRAND	MODEL NO.	SERIAL NO.	FCC ID
1	NOTEBOOK	DELL	E5410	1HC2XM1	NA

NO.	SIGNAL CABLE DESCRIPTION OF THE ABOVE SUPPORT UNITS
1	NA

NOTE: All power cords of the above support units are non-shielded (1.8m).

4. TEST TYPES AND RESULTS

4.1 RADIATED EMISSION MEASUREMENT

4.1.1 LIMITS OF RADIATED EMISSION MEASUREMENT

The field strength of any emissions within the band 13.553-13.567 MHz shall not exceed 15,848 microvolts/meter at 30 meters.

The field strength of any emissions appearing outside of the 13.110-14.010 MHz band shall not exceed the general radiated emission limits in § 15.209.

FREQUENCIES (MHz)	FIELD STRENGTH (microvolts/meter)	MEASUREMENT DISTANCE (meters)
0.009 ~ 0.490	2400/F(kHz)	300
0.490 ~ 1.705	24000/F(kHz)	30
1.705 ~ 30.0	30	30
30 ~ 88	100	3
88 ~ 216	150	3
216 ~ 960	200	3
Above 960	500	3

NOTE:

1. The lower limit shall apply at the transition frequencies.
2. Emission level (dBuV/m) = 20 log Emission level (uV/m).
3. As shown in 15.35(b), for frequencies above 1000MHz, the field strength limits are based on average detector, however, the peak field strength of any emission shall not exceed the maximum permitted average limits, specified above by more than 20dB under any condition of modulation.



4.1.2 TEST INSTRUMENTS

DESCRIPTION & MANUFACTURER	MODEL NO.	SERIAL NO.	DATE OF CALIBRATION	DUE DATE OF CALIBRATION
Test Receiver ROHDE & SCHWARZ	ESI7	838496/016	Jan. 03, 2012	Jan. 02, 2013
Spectrum Analyzer ROHDE & SCHWARZ	FSP40	100269	Jan. 30, 2012	Jan. 29, 2013
BILOG Antenna SCHWARZBECK	VULB9168	9168-155	Apr. 12, 2011	Apr. 11, 2012
HORN Antenna SCHWARZBECK	BBHA 9120D	9120D-408	Jan. 05, 2012	Jan. 04, 2013
HORN Antenna SCHWARZBECK	BBHA 9170	148	Jul. 20, 2011	Jul. 19, 2012
Preamplifier Agilent	8449B	3008A01961	Oct. 29, 2011	Oct. 28, 2012
Preamplifier Agilent	8447D	2944A10738	Oct. 29, 2011	Oct. 28, 2012
RF signal cable HUBER+SUHNNER	SUCOFLEX 104	309220/4	Nov. 03, 2011	Nov. 02, 2012
RF signal cable HUBER+SUHNNER	SUCOFLEX 104	250724/4	Nov. 03, 2011	Nov. 02, 2012
RF signal cable HUBER+SUHNNER	SUCOFLEX 104	295012/4	Nov. 03, 2011	Nov. 02, 2012
Software ADT.	ADT_Radiated_ V7.6.15.9.2	NA	NA	NA
Antenna Tower inn-co GmbH	MA 4000	010303	NA	NA
Antenna Tower Controller inn-co GmbH	CO2000	019303	NA	NA
Turn Table ADT.	TT100.	TT93021704	NA	NA
Turn Table Controller ADT.	SC100.	SC93021704	NA	NA

- NOTE:**
1. The calibration interval of the above test instruments is 12 months and the calibrations are traceable to NML/ROC and NIST/USA.
 2. The test was performed in HwaYa Chamber 4.
 3. The horn antenna and HP preamplifier (model: 8449B) are used only for the measurement of emission frequency above 1GHz if tested.
 4. The FCC Site Registration No. is 460141.
 5. The IC Site Registration No. is IC7450F-4.

4.1.3 TEST PROCEDURES

- a. The EUT was placed on the top of a rotating table 0.8 meters above the ground at a 3 meter semi-anechoic chamber. The table was rotated 360 degrees to determine the position of the highest radiation.
- b. The EUT was set 3 meters away from the interference-receiving antenna, which was mounted on the top of a variable-height antenna tower.
- c. The antenna is a broadband antenna, and its height is varied from one meter to four meters above the ground to determine the maximum value of the field strength. Both horizontal and vertical polarizations of the antenna are set to make the measurement.
- d. For each suspected emission, the EUT was arranged to its worst case and then the antenna was tuned to heights from 1 meter to 4 meters and the rotatable table was turned from 0 degrees to 360 degrees to find the maximum reading.
- e. The test-receiver system was set to Peak Detect Function and Specified Bandwidth with Maximum Hold Mode.
- f. If the emission level of the EUT in peak mode was lower than the limit specified, then testing could be stopped and the peak values of the EUT would be reported. Otherwise the emissions would be re-tested one by one using peak, quasi-peak or average method as specified and then reported in a data sheet.

NOTE:

1. The resolution bandwidth and video bandwidth of test receiver/spectrum analyzer is 120kHz for Quasi-peak detection at frequency below 1GHz.
2. The resolution bandwidth of test receiver/spectrum analyzer is 1 MHz and video bandwidth is 3MHz for Peak detection at frequency above 1GHz.
3. All modes of operation were investigated and the worst-case emissions are reported.

4.1.4 DEVIATION FROM TEST STANDARD

No deviation.

4.1.5 TEST SETUP

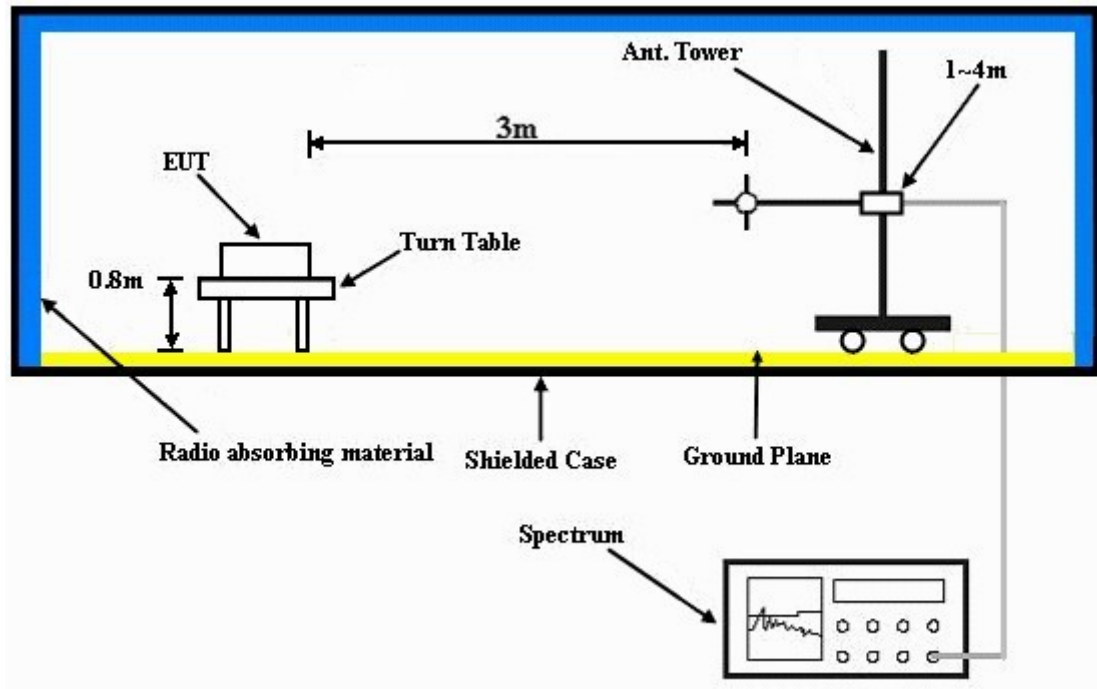

For the actual test configuration, please refer to the attached file (Test Setup Photo).

4.1.6 EUT OPERATING CONDITIONS

Set the EUT under transmission condition continuously at specific channel frequency.



A D T

4.1.7 TEST RESULTS

EUT TEST CONDITION		MEASUREMENT DETAIL	
CHANNEL	Channel 1	FREQUENCY RANGE	13.553 ~ 13.567MHz
INPUT POWER (SYSTEM)	120Vac, 60Hz	DETECTOR FUNCTION	Quasi-Peak
ENVIRONMENTAL CONDITIONS	25deg. C, 65%RH	TESTED BY	Mark Liao

ANTENNA POLARITY & TEST DISTANCE: LOOP ANTENNA OPEN AT 3m								
No.	Freq. (MHz)	Emission Level (dBuV/m)	Limit (dBuV/m)	Margin (dB)	Antenna Height (m)	Table Angle (Degree)	Raw Value (dBuV)	Correction Factor (dB/m)
1	13.56	73.5	124.0	-50.5	1.00	4	53.6	19.9

- REMARKS:**
1. Emission level(dBuV/m)=Raw Value(dBuV) + Correction Factor(dB/m)
 2. Correction Factor(dB/m) = Antenna Factor (dB/m) + Cable Factor (dB)
 3. The other emission levels were very low against the limit.
 4. Margin value = Emission level – Limit value.
 5. Above limits have been translated by the formula

The measured field strength was extrapolated to distance 30 meters, using the formula that the limit of field strength varies as the inverse distance square (40dB per decade of distance)

Example:

$$\begin{aligned}
 13.56\text{MHz} &= 15848\mu\text{V/m} && 30\text{m} \\
 &= 84\text{dBuV/m} && 30\text{m} \\
 &= 84+20\log(30/3)^2 && 3\text{m} \\
 &= 124\text{dBuV/m}
 \end{aligned}$$

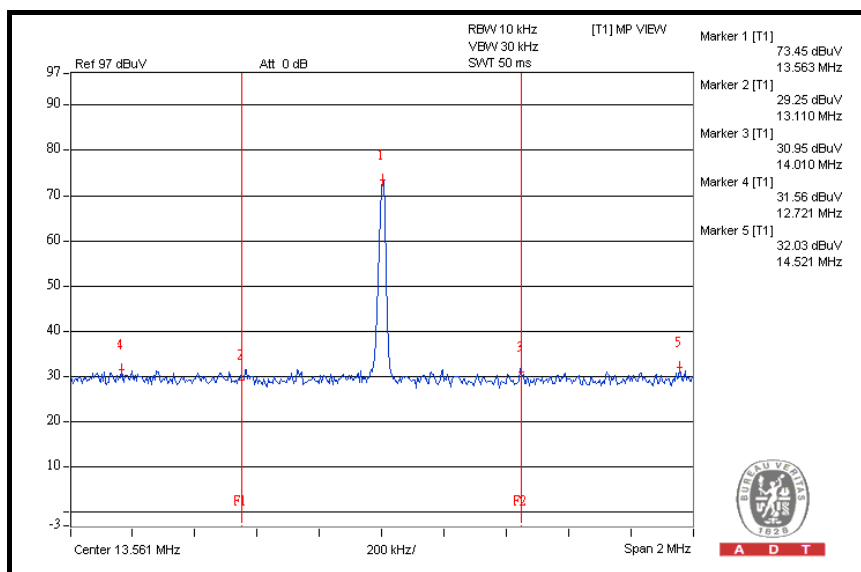



A D T

EUT TEST CONDITION		MEASUREMENT DETAIL	
CHANNEL	Channel 1	FREQUENCY RANGE	13.553 ~ 13.567MHz
INPUT POWER (SYSTEM)	120Vac, 60Hz	DETECTOR FUNCTION	Quasi-Peak
ENVIRONMENTAL CONDITIONS	25deg. C, 65%RH	TESTED BY	Mark Liao

ANTENNA POLARITY & TEST DISTANCE: LOOP ANTENNA CLOSE AT 3m								
No.	Freq. (MHz)	Emission Level (dBuV/m)	Limit (dBuV/m)	Margin (dB)	Antenna Height (m)	Table Angle (Degree)	Raw Value (dBuV)	Correction Factor (dB/m)
1	13.56	69.8	124.0	-54.2	1.00	273	49.9	19.9

- REMARKS:**
1. Emission level(dBuV/m)=Raw Value(dBuV) + Correction Factor(dB/m)
 2. Correction Factor(dB/m) = Antenna Factor (dB/m) + Cable Factor (dB)
 3. The other emission levels were very low against the limit.
 4. Margin value = Emission level – Limit value.
 5. Above limits have been translated by the formula

The measured field strength was extrapolated to distance 30 meters, using the formula that the limit of field strength varies as the inverse distance square (40dB per decade of distance)

Example:

$$\begin{aligned}
 13.56\text{MHz} &= 15848\mu\text{V/m} && 30\text{m} \\
 &= 84\text{dBuV/m} && 30\text{m} \\
 &= 84+20\log(30/3)^2 && 3\text{m} \\
 &= 124\text{dBuV/m}
 \end{aligned}$$

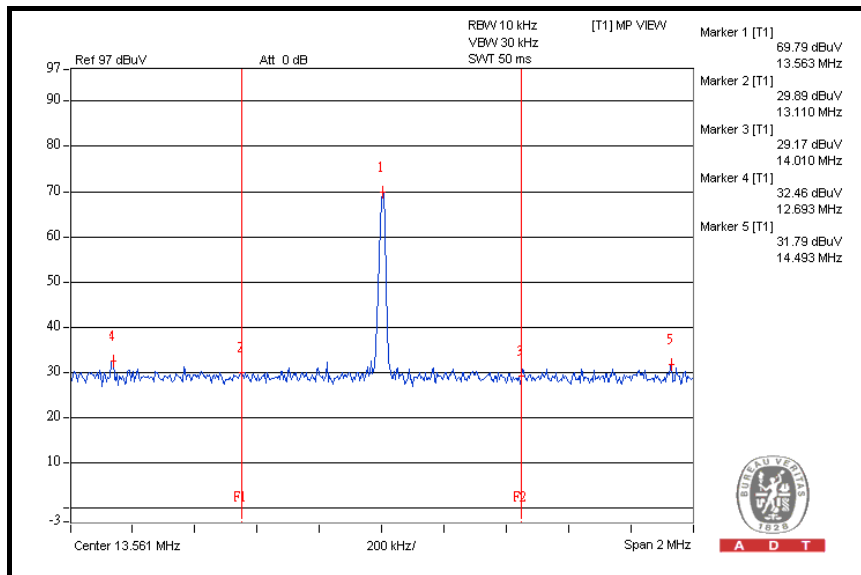



A D T

EUT TEST CONDITION		MEASUREMENT DETAIL	
CHANNEL	Channel 1	FREQUENCY RANGE	Below 30MHz
INPUT POWER (SYSTEM)	120Vac, 60Hz	DETECTOR FUNCTION	Quasi-Peak
ENVIRONMENTAL CONDITIONS	25deg. C, 65%RH	TESTED BY	Mark Liao

ANTENNA POLARITY & TEST DISTANCE: LOOP ANTENNA OPEN AT 3m								
No.	Freq. (MHz)	Emission Level (dBuV/m)	Limit (dBuV/m)	Margin (dB)	Antenna Height (m)	Table Angle (Degree)	Raw Value (dBuV)	Correction Factor (dB/m)
1	13.11	29.30 QP	69.50	-40.30	1.00 V	4	9.40	19.90
2	14.01	31.00 QP	69.50	-38.60	1.00 V	4	11.10	19.90
3	27.12	39.20 QP	69.50	-30.40	1.00 V	210	18.90	20.30
ANTENNA POLARITY & TEST DISTANCE: LOOP ANTENNA CLOSE AT 3m								
No.	Freq. (MHz)	Emission Level (dBuV/m)	Limit (dBuV/m)	Margin (dB)	Antenna Height (m)	Table Angle (Degree)	Raw Value (dBuV)	Correction Factor (dB/m)
1	13.11	29.90 QP	69.50	-39.70	1.00 V	273	10.00	19.90
2	14.01	29.20 QP	69.50	-40.40	1.00 V	273	9.30	19.90
3	27.12	49.00 QP	69.50	-20.60	1.00 V	136	28.70	20.30

- REMARKS:**
1. Emission level(dBuV/m)=Raw Value(dBuV) + Correction Factor(dB/m)
 2. Correction Factor(dB/m) = Antenna Factor (dB/m) + Cable Factor (dB)
 3. The other emission levels were very low against the limit.
 4. Margin value = Emission level – Limit value.



A D T

EUT TEST CONDITION		MEASUREMENT DETAIL	
CHANNEL	Channel 1	FREQUENCY RANGE	Below 1000MHz
INPUT POWER (SYSTEM)	120Vac, 60Hz	DETECTOR FUNCTION	Quasi-Peak
ENVIRONMENTAL CONDITIONS	25deg. C, 65%RH	TESTED BY	Mark Liao

ANTENNA POLARITY & TEST DISTANCE: HORIZONTAL AT 3 M								
NO.	FREQ. (MHz)	EMISSION LEVEL (dBuV/m)	LIMIT (dBuV/m)	MARGIN (dB)	ANTENNA HEIGHT (m)	TABLE ANGLE (Degree)	RAW VALUE (dBuV)	CORRECTION FACTOR (dB/m)
1	142.67	32.50 QP	43.50	-11.00	1.25 H	178	18.40	14.10
2	199.05	37.20 QP	43.50	-6.30	1.25 H	154	25.60	11.60
3	239.88	37.50 QP	46.00	-8.50	1.25 H	184	24.30	13.20
4	265.16	39.60 QP	46.00	-6.40	1.00 H	172	25.30	14.30
5	527.64	30.90 QP	46.00	-15.10	1.50 H	208	9.10	21.80
6	720.12	30.20 QP	46.00	-15.80	1.00 H	169	5.20	25.00
ANTENNA POLARITY & TEST DISTANCE: VERTICAL AT 3 M								
NO.	FREQ. (MHz)	EMISSION LEVEL (dBuV/m)	LIMIT (dBuV/m)	MARGIN (dB)	ANTENNA HEIGHT (m)	TABLE ANGLE (Degree)	RAW VALUE (dBuV)	CORRECTION FACTOR (dB/m)
1	59.06	32.30 QP	40.00	-7.70	1.00 V	118	18.60	13.70
2	142.67	28.20 QP	43.50	-15.30	1.00 V	136	14.10	14.10
3	199.05	29.90 QP	43.50	-13.60	1.00 V	97	18.30	11.60
4	375.98	32.50 QP	46.00	-13.50	1.25 V	133	14.70	17.80
5	527.64	29.90 QP	46.00	-16.10	1.00 V	79	8.10	21.80
6	817.34	29.20 QP	46.00	-16.80	1.50 V	40	1.80	27.40

- REMARKS:**
1. Emission level (dBuV/m) = Raw Value (dBuV) + Correction Factor (dB/m).
 2. Correction Factor (dB/m) = Antenna Factor (dB/m) + Cable Factor (dB).
 3. The other emission levels were very low against the limit.
 4. Margin value = Emission level – Limit value.

4.2 CONDUCTED EMISSION MEASUREMENT

4.2.1 LIMITS OF CONDUCTED EMISSION MEASUREMENT

FREQUENCY OF EMISSION (MHz)	CONDUCTED LIMIT (dB μ V)	
	Quasi-peak	Average
0.15 ~ 0.5	66 to 56	56 to 46
0.5 ~ 5	56	46
5 ~ 30	60	50

- NOTE:**
1. The lower limit shall apply at the transition frequencies.
 2. The limit decreases in line with the logarithm of the frequency in the range of 0.15 to 0.50 MHz.
 3. All emanations from a class A/B digital device or system, including any network of conductors and apparatus connected thereto, shall not exceed the level of field strengths specified above.

4.2.2 TEST INSTRUMENTS

DESCRIPTION & MANUFACTURER	MODEL NO.	SERIAL NO.	DATE OF CALIBRATION	DUE DATE OF CALIBRATION
Test Receiver ROHDE & SCHWARZ	ESCS30	100289	Nov. 19, 2011	Nov. 18, 2012
RF signal cable Woken	5D-FB	Cable-HYCO2-01	Dec. 22, 2011	Dec. 21, 2012
LISN ROHDE & SCHWARZ	ESH2-Z5	100100	Dec. 30, 2011	Dec. 29, 2012
LISN ROHDE & SCHWARZ	ESH3-Z5	100312	Jul. 07, 2011	Jul. 06, 2012
Software ADT	ADT_Cond_ V7.3.7	NA	NA	NA

- NOTE:**
1. The calibration interval of the above test instruments is 12 months and the calibrations are traceable to NML/ROC and NIST/USA.
 2. The test was performed in HwaYa Shielded Room 2.
 3. The VCCI Site Registration No. is C-2047.

4.2.3 TEST PROCEDURES

- a. The EUT was placed 0.4 meters from the conducting wall of the shielded room with EUT being connected to the power mains through a line impedance stabilization network (LISN). Other support units were connected to the power mains through another LISN. The two LISNs provide 50 ohm/ 50uH of coupling impedance for the measuring instrument.
- b. Both lines of the power mains connected to the EUT were checked for maximum conducted interference.
- c. The frequency range from 150kHz to 30MHz was searched. Emission levels under (Limit - 20dB) was not recorded.

NOTE: All modes of operation were investigated and the worst-case emissions are reported.

4.2.4 DEVIATION FROM TEST STANDARD

No deviation.

4.2.5 TEST SETUP

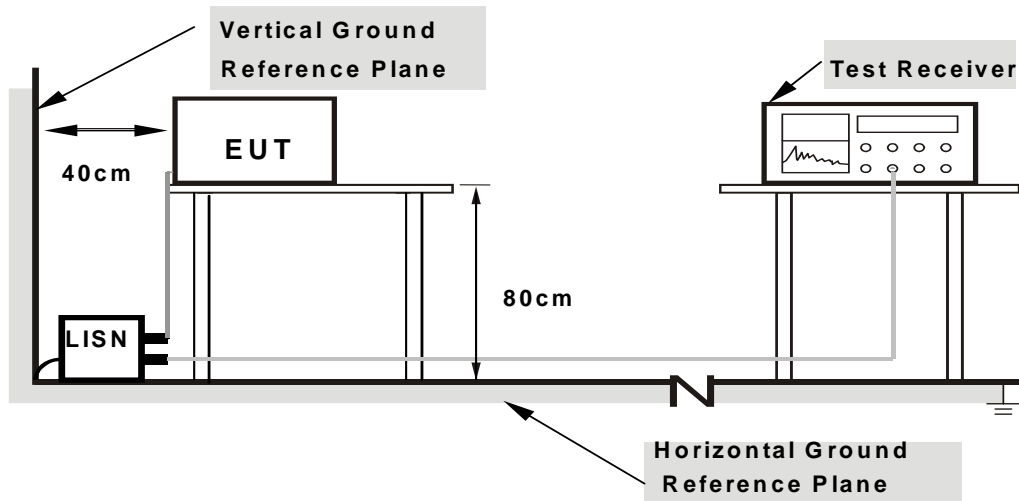

- Note:**
1. Support units were connected to second LISN.
 2. Both of LISNs (AMN) are 80 cm from EUT and at least 80 from other units and other metal planes

For the actual test configuration, please refer to the attached file (Test Setup Photo).

4.2.6 EUT OPERATING CONDITIONS

Same as 4.1.6.

4.2.7 TEST RESULTS

PHASE	Line 1	6dB BANDWIDTH	9kHz
-------	--------	---------------	------

No	Freq. [MHz]	Corr. Factor (dB)	Reading Value [dB (uV)]		Emission Level [dB (uV)]		Limit [dB (uV)]		Margin (dB)	
			Q.P.	AV.	Q.P.	AV.	Q.P.	AV.	Q.P.	AV.
1	0.150	0.15	59.38	37.42	59.53	37.57	66.00	56.00	-6.47	-18.43
2	0.177	0.15	53.37	32.36	53.52	32.51	64.61	54.61	-11.09	-22.10
3	0.396	0.17	33.23	14.94	33.40	15.11	57.93	47.93	-24.54	-32.83
4	1.191	0.20	29.68	14.84	29.88	15.04	56.00	46.00	-26.12	-30.96
5	4.637	0.35	22.54	16.54	22.89	16.89	56.00	46.00	-33.11	-29.11
6	8.594	0.41	24.70	19.17	25.11	19.58	60.00	50.00	-34.89	-30.42

- REMARKS:**
1. Q.P. and AV. are abbreviations of quasi-peak and average individually.
 2. "-": The Quasi-peak reading value also meets average limit and measurement with the average detector is unnecessary.
 3. The emission levels of other frequencies were very low against the limit.
 4. Margin value = Emission level - Limit value
 5. Correction factor = Insertion loss + Cable loss
 6. Emission Level = Correction Factor + Reading Value.
 7. This is RFID signal inductive with measurement system. Please check P24-25 to see test result for EUT with a suitable dummy load.

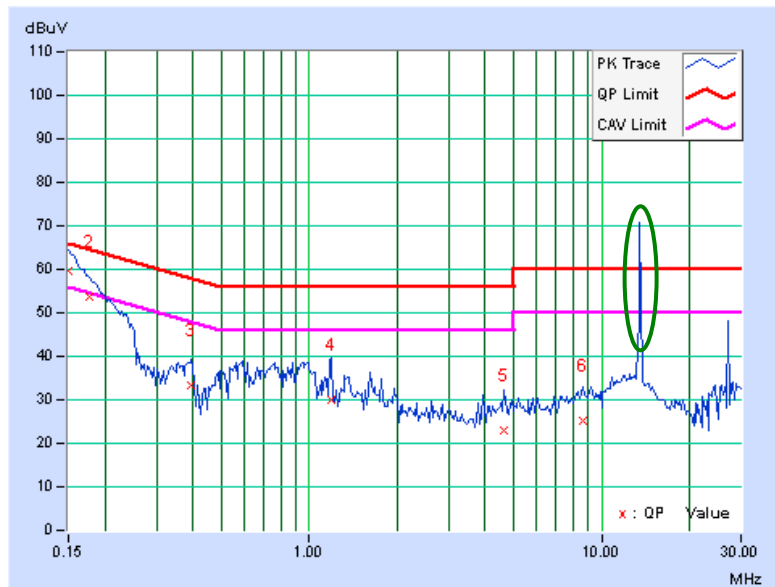

PHASE	Line 2	6dB BANDWIDTH	9kHz
-------	--------	---------------	------

No	Freq. [MHz]	Corr. Factor (dB)	Reading Value		Emission Level		Limit		Margin	
			[dB (uV)]		[dB (uV)]		[dB (uV)]		(dB)	
			Q.P.	AV.	Q.P.	AV.	Q.P.	AV.	Q.P.	AV.
1	0.150	0.13	59.82	37.34	59.95	37.47	66.00	56.00	-6.05	-18.53
2	0.189	0.14	51.91	32.70	52.05	32.84	64.08	54.08	-12.03	-21.24
3	0.244	0.14	43.93	25.45	44.07	25.59	61.97	51.97	-17.89	-26.37
4	0.759	0.18	32.41	18.47	32.59	18.65	56.00	46.00	-23.41	-27.35
5	1.219	0.21	29.94	17.49	30.15	17.70	56.00	46.00	-25.85	-28.30
6	17.945	0.67	26.65	20.81	27.32	21.48	60.00	50.00	-32.68	-28.52

- REMARKS:**
1. Q.P. and AV. are abbreviations of quasi-peak and average individually.
 2. "-": The Quasi-peak reading value also meets average limit and measurement with the average detector is unnecessary.
 3. The emission levels of other frequencies were very low against the limit.
 4. Margin value = Emission level - Limit value
 5. Correction factor = Insertion loss + Cable loss
 6. Emission Level = Correction Factor + Reading Value.
 7. This is RFID signal inductive with measurement system. Please check P24-25 to see test result for EUT with a suitable dummy load.

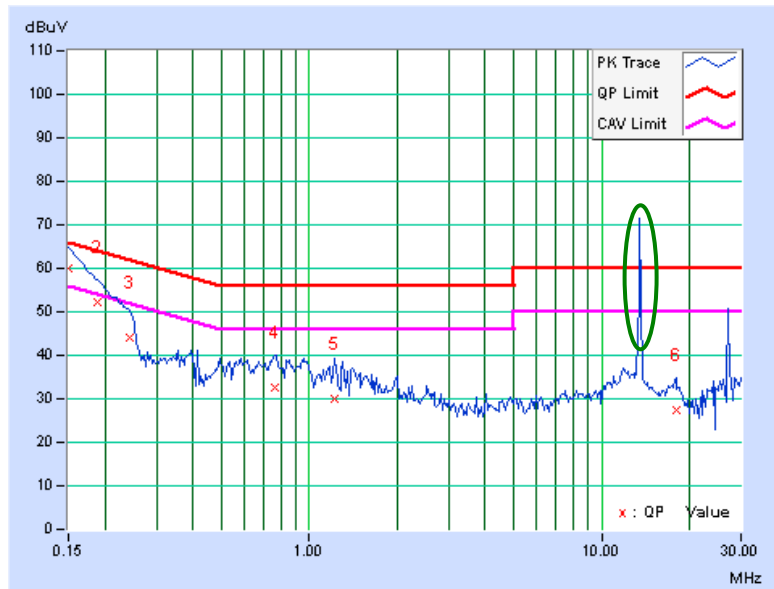



A D T

Test with suitable dummy load

PHASE	Line 1	6dB BANDWIDTH	9kHz
-------	--------	---------------	------

No	Freq. [MHz]	Corr. Factor (dB)	Reading Value		Emission Level		Limit		Margin	
			[dB (uV)]		[dB (uV)]		[dB (uV)]		(dB)	
			Q.P.	AV.	Q.P.	AV.	Q.P.	AV.	Q.P.	AV.
1	0.154	0.15	59.56	39.85	59.71	40.00	65.79	55.79	-6.08	-15.79
2	0.181	0.15	51.99	31.41	52.14	31.56	64.43	54.43	-12.29	-22.87
3	0.384	0.17	31.77	12.30	31.94	12.47	58.18	48.18	-26.25	-35.72
4	0.560	0.18	32.49	14.82	32.67	15.00	56.00	46.00	-23.33	-31.00
5	0.931	0.19	31.20	16.60	31.39	16.79	56.00	46.00	-24.61	-29.21
6	12.477	0.48	29.85	24.66	30.33	25.14	60.00	50.00	-29.67	-24.86

- REMARKS:**
1. Q.P. and AV. are abbreviations of quasi-peak and average individually.
 2. "-": The Quasi-peak reading value also meets average limit and measurement with the average detector is unnecessary.
 3. The emission levels of other frequencies were very low against the limit.
 4. Margin value = Emission level - Limit value
 5. Correction factor = Insertion loss + Cable loss
 6. Emission Level = Correction Factor + Reading Value.

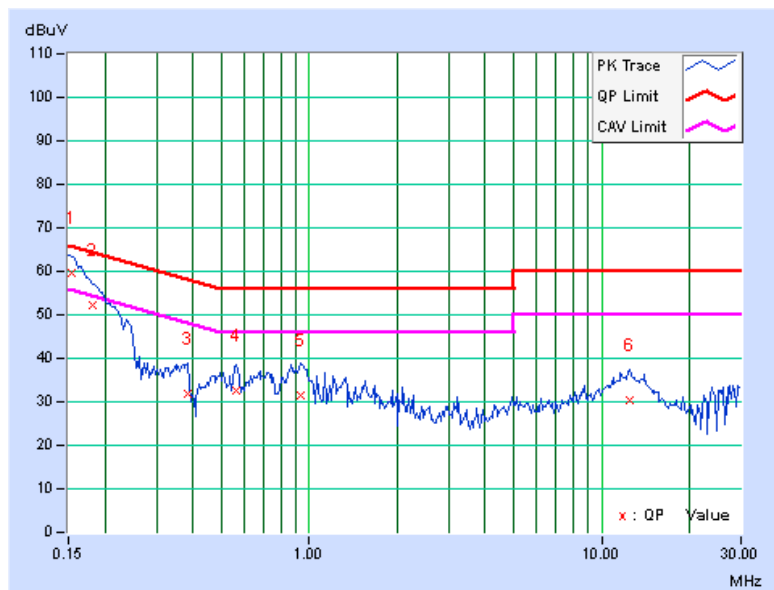



A D T

PHASE	Line 2	6dB BANDWIDTH	9kHz
-------	--------	---------------	------

No	Freq. [MHz]	Corr. Factor (dB)	Reading Value		Emission Level		Limit		Margin	
			[dB (uV)]		[dB (uV)]		[dB (uV)]		(dB)	
			Q.P.	AV.	Q.P.	AV.	Q.P.	AV.	Q.P.	AV.
1	0.154	0.13	60.07	40.26	60.20	40.39	65.79	55.79	-5.59	-15.40
2	0.177	0.14	53.86	32.77	54.00	32.91	64.61	54.61	-10.61	-21.70
3	0.373	0.16	35.50	17.90	35.66	18.06	58.44	48.44	-22.78	-30.38
4	0.552	0.17	32.09	18.85	32.26	19.02	56.00	46.00	-23.74	-26.98
5	0.974	0.19	31.54	19.66	31.73	19.85	56.00	46.00	-24.27	-26.15
6	12.535	0.54	29.64	24.62	30.18	25.16	60.00	50.00	-29.82	-24.84

- REMARKS:**
1. Q.P. and AV. are abbreviations of quasi-peak and average individually.
 2. "-": The Quasi-peak reading value also meets average limit and measurement with the average detector is unnecessary.
 3. The emission levels of other frequencies were very low against the limit.
 4. Margin value = Emission level - Limit value
 5. Correction factor = Insertion loss + Cable loss
 6. Emission Level = Correction Factor + Reading Value.

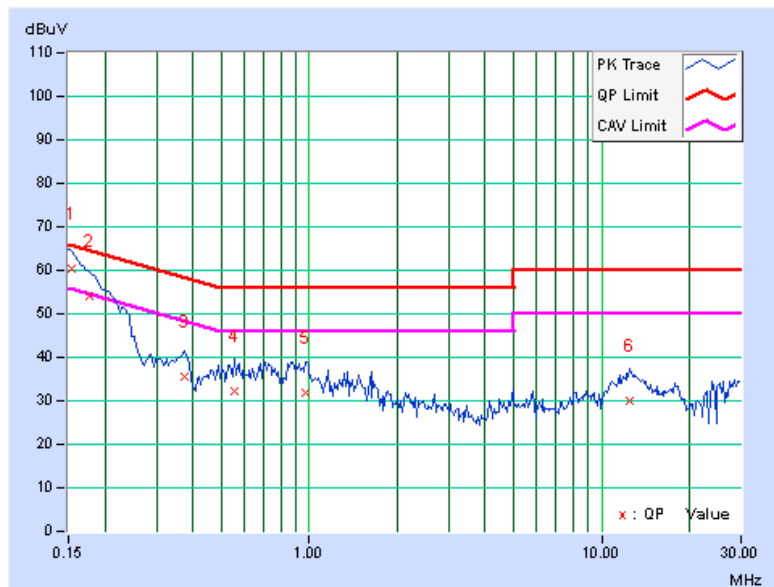

4.3 20dB BANDWIDTH

4.3.1 LIMITS OF 20dB BANDWIDTH MEASUREMENT

The 20dB bandwidth shall be specified in operating frequency band.

4.3.2 TEST INSTRUMENTS

Same as Item 4.1.2.

4.3.3 TEST PROCEDURE

The bandwidth of the fundamental frequency was measured by spectrum analyzer with 1kHz RBW and 1kHz VBW. The 20dB bandwidth is defined as the total spectrum the power of which is higher than peak power minus 20dB.

4.3.4 DEVIATION FROM TEST STANDARD

No deviation.

4.3.5 TEST SETUP

Same as Item 4.1.5.

4.3.6 EUT OPERATING CONDITION

Same as Item 4.1.6.



A D T

4.3.7 TEST RESULTS

20dBc point (Low)	20dBc point (HIGH)	Operating frequency band (MHz)	PASS/FAIL
13.559 MHz	13.5605 MHz	13.553~13.567	PASS

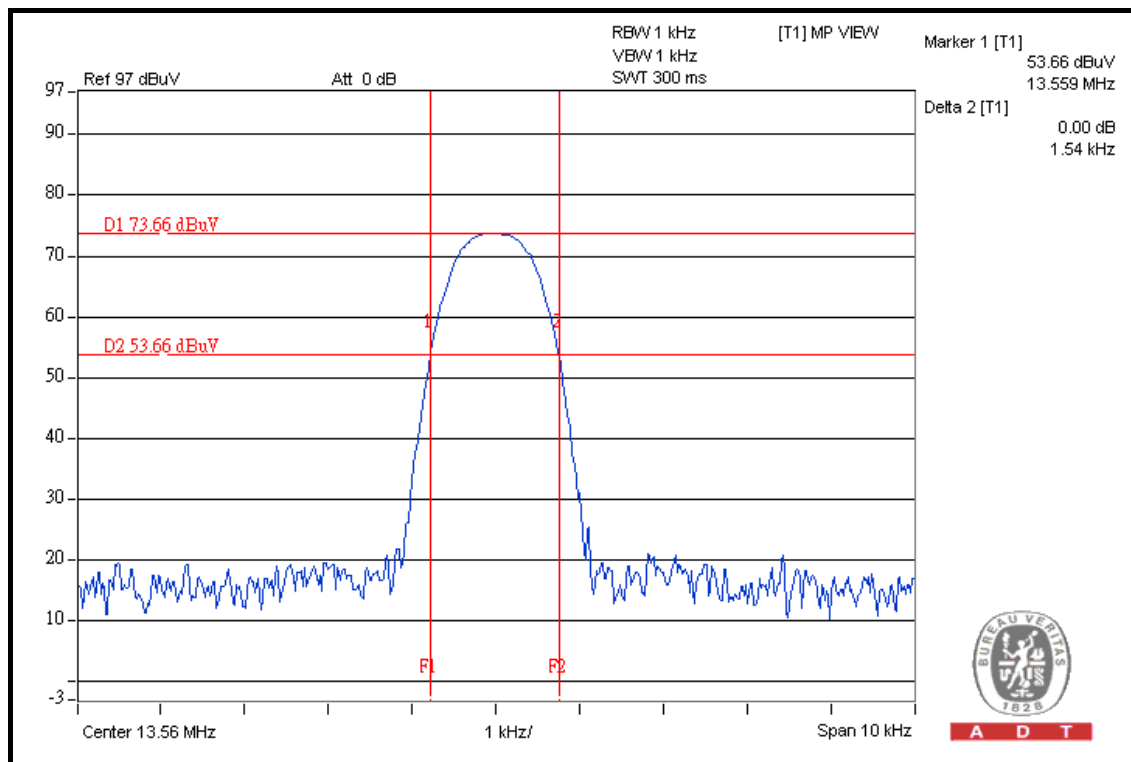



A D T

5. PHOTOGRAPHS OF THE TEST CONFIGURATION

Please refer to the attached file (Test Setup Photo).



6. INFORMATION ON THE TESTING LABORATORIES

We, Bureau Veritas Consumer Products Services (H.K.) Ltd., Taoyuan Branch, were founded in 1988 to provide our best service in EMC, Radio, Telecom and Safety consultation. Our laboratories are accredited and approved according to ISO/IEC 17025.

Copies of accreditation and authorization certificates of our laboratories obtained from approval agencies can be downloaded from our web site: www.adt.com.tw/index.5.phtml. If you have any comments, please feel free to contact us at the following:

Linko EMC/RF Lab

Tel: 886-2-26052180

Fax: 886-2-26051924

Hsin Chu EMC/RF Lab

Tel: 886-3-5935343

Fax: 886-3-5935342

Hwa Ya EMC/RF/Safety/Telecom Lab

Tel: 886-3-3183232

Fax: 886-3-3185050

Email: service.adt@tw.bureauveritas.com

Web Site: www.adt.com.tw

The address and road map of all our labs can be found in our web site also.



A D T

7. APPENDIX A - MODIFICATIONS RECORDERS FOR ENGINEERING CHANGES TO THE EUT BY THE LAB

No modifications are made to the EUT by the lab during the test.

--- END ---