



# FCC TEST REPORT (Bluetooth)

**REPORT NO.:** RF111021C03  
**MODEL NO.:** VX600 Bluetooth  
**FCC ID:** B32VX600BTCTLS  
**RECEIVED:** Oct. 24, 2011  
**TESTED:** Oct. 26 ~ Nov. 07, 2011  
**ISSUED:** Nov. 10, 2011

**APPLICANT:** VeriFone, Inc.

**ADDRESS:** 1400 West Stanford Ranch Road Suit 200 Rocklin  
CA 95765 USA

**ISSUED BY:** Bureau Veritas Consumer Products Services  
(H.K.) Ltd., Taoyuan Branch

**LAB ADDRESS:** No. 47, 14th Ling, Chia Pau Vil., Lin Kou Dist.,  
New Taipei City, Taiwan ( R.O.C )

**TEST LOCATION:** No. 19, Hwa Ya 2nd Rd, Wen Hwa Tsuen, Kwei  
Shan Hsiang, Taoyuan Hsien 333, Taiwan, R.O.C.

This test report consists of 64 pages in total. It may be duplicated completely for legal use with the approval of the applicant. It should not be reproduced except in full, without the written approval of our laboratory. The client should not use it to claim product certification, approval, or endorsement by TAF or any government agency. The test results in the report only apply to the tested sample.



## Table of Contents

RELEASE CONTROL RECORD .....	5
1. CERTIFICATION .....	6
2. SUMMARY OF TEST RESULTS .....	7
2.1 MEASUREMENT UNCERTAINTY .....	7
3. GENERAL INFORMATION.....	8
3.1 GENERAL DESCRIPTION OF EUT.....	8
3.2 DESCRIPTION OF TEST MODES.....	9
3.2.1 CONFIGURATION OF SYSTEM UNDER TEST .....	10
3.2.2 TEST MODE APPLICABILITY AND TESTED CHANNEL DETAIL.....	11
3.3 GENERAL DESCRIPTION OF APPLIED STANDARDS .....	13
3.4 DESCRIPTION OF SUPPORT UNITS .....	13
4. TEST TYPES AND RESULTS .....	14
4.1 RADIATED EMISSION MEASUREMENT .....	14
4.1.1 LIMITS OF RADIATED EMISSION MEASUREMENT.....	14
4.1.2 TEST INSTRUMENTS .....	15
4.1.3 TEST PROCEDURES .....	16
4.1.4 DEVIATION FROM TEST STANDARD .....	16
4.1.5 TEST SETUP .....	17
4.1.6 EUT OPERATING CONDITIONS.....	17
4.1.7 TEST RESULTS .....	18
4.2 CONDUCTED EMISSION MEASUREMENT .....	28
4.2.1 LIMITS OF CONDUCTED EMISSION MEASUREMENT.....	28
4.2.2 TEST INSTRUMENTS .....	28
4.2.3 TEST PROCEDURES .....	29
4.2.4 DEVIATION FROM TEST STANDARD .....	29
4.2.5 TEST SETUP .....	30
4.2.6 EUT OPERATING CONDITIONS.....	30
4.2.7 TEST RESULTS .....	31
4.3 NUMBER OF HOPPING FREQUENCY USED.....	33
4.3.1 LIMIT OF HOPPING FREQUENCY USED .....	33
4.3.2 TEST INSTRUMENTS .....	33
4.3.3 TEST PROCEDURES .....	33
4.3.4 DEVIATION FROM TEST STANDARD .....	34
4.3.5 TEST SETUP .....	34
4.3.6 TEST RESULTS .....	34



4.4	DWELL TIME ON EACH CHANNEL .....	37
4.4.1	LIMIT OF DWELL TIME USED.....	37
4.4.2	TEST INSTRUMENTS .....	37
4.4.3	TEST PROCEDURES .....	37
4.4.4	DEVIATION FROM TEST STANDARD .....	37
4.4.5	TEST SETUP .....	37
4.4.6	TEST RESULTS .....	38
4.5	CHANNEL BANDWIDTH.....	46
4.5.1	LIMITS OF CHANNEL BANDWIDTH .....	46
4.5.2	TEST INSTRUMENTS .....	46
4.5.3	TEST PROCEDURE .....	46
4.5.4	DEVIATION FROM TEST STANDARD .....	46
4.5.5	TEST SETUP .....	46
4.5.6	EUT OPERATING CONDITION .....	47
4.5.7	TEST RESULTS .....	47
4.6	HOPPING CHANNEL SEPARATION .....	49
4.6.1	LIMIT OF HOPPING CHANNEL SEPARATION .....	49
4.6.2	TEST INSTRUMENTS .....	49
4.6.3	TEST PROCEDURES .....	49
4.6.4	DEVIATION FROM TEST STANDARD .....	49
4.6.5	TEST SETUP .....	49
4.6.6	TEST RESULTS .....	50
4.7	MAXIMUM OUTPUT POWER.....	52
4.7.1	LIMITS OF MAXIMUM OUTPUT POWER MEASUREMENT .....	52
4.7.2	TEST INSTRUMENTS .....	52
4.7.3	TEST PROCEDURES .....	52
4.7.4	DEVIATION FROM TEST STANDARD .....	52
4.7.5	TEST SETUP .....	52
4.7.6	EUT OPERATING CONDITION .....	53
4.7.7	TEST RESULTS .....	53
4.8	BAND EDGES MEASUREMENT .....	55
4.8.1	LIMITS OF BAND EDGES MEASUREMENT .....	55
4.8.2	TEST INSTRUMENTS .....	55
4.8.3	TEST PROCEDURE .....	55
4.8.4	DEVIATION FROM TEST STANDARD .....	55
4.8.5	EUT OPERATING CONDITION .....	55
4.8.6	TEST RESULTS .....	56



A D T

5.	PHOTOGRAPHS OF THE TEST CONFIGURATION.....	62
6.	INFORMATION ON THE TESTING LABORATORIES.....	63
7.	APPENDIX A - MODIFICATIONS RECORDERS FOR ENGINEERING CHANGES TO THE EUT BY THE LAB.....	64



A D T

## RELEASE CONTROL RECORD

ISSUE NO.	REASON FOR CHANGE	DATE ISSUED
Original release	NA	Nov. 10, 2011



# 1. CERTIFICATION

**PRODUCT:** Point of Sale Terminal

**MODEL:** VX600 Bluetooth

**BRAND:** VeriFone

**APPLICANT:** VeriFone, Inc.

**TEST SAMPLE:** ENGINEERING SAMPLE

**TESTED:** Oct. 26 ~ Nov. 07, 2011

**STANDARDS:** **FCC Part 15, Subpart C (Section 15.247)**

ANSI C63.4-2003

ANSI C63.10-2009

The above equipment (Model: VX600 Bluetooth) has been tested by **Bureau Veritas Consumer Products Services (H.K.) Ltd., Taoyuan Branch**, and found compliance with the requirement of the above standards. The test record, data evaluation & Equipment Under Test (EUT) configurations represented herein are true and accurate accounts of the measurements of the sample's EMC characteristics under the conditions specified in this report.

PREPARED BY : Ivonne Wu , DATE: Nov. 10, 2011  
Ivonne Wu / Senior Specialist

APPROVED BY : Gary Chang , DATE: Nov. 10, 2011  
Gary Chang / Technical Manager

## 2. SUMMARY OF TEST RESULTS

The EUT has been tested according to the following specifications:

APPLIED STANDARD: FCC Part 15, Subpart C			
STANDARD SECTION	TEST TYPE AND LIMIT	RESULT	REMARK
15.207	AC Power Conducted Emission	PASS	Meet the requirement of limit. Minimum passing margin is -7.73dB at 0.509MHz.
15.247(a)(1)(iii)	Number of Hopping Frequency Used Spec.: At least 15 channels	PASS	Meet the requirement of limit.
15.247(a)(1)(iii)	Dwell Time on Each Channel Spec.: Max. 0.4 second within 31.6 second	PASS	Meet the requirement of limit.
15.247(a)(1)	1. Hopping Channel Separation Spec. : Min. 25 kHz or $\frac{2}{3} * 20$ dB bandwidth, whichever is greater 2. Spectrum Bandwidth of a Frequency Hopping Sequence Spread Spectrum System	PASS	Meet the requirement of limit.
15.247(b)	Maximum Output Power Spec.: max. 21dBm	PASS	Meet the requirement of limit.
15.247(d)	Transmitter Radiated Emissions Spec.: Table 15.209	PASS	Meet the requirement of limit. Minimum passing margin is -7.9dB at 76.56MHz.
15.247(d)	Band Edge Measurement	PASS	Meet the requirement of limit.
15.203	Antenna Requirement	PASS	No antenna connector is used.

**NOTE:** If The Frequency Hopping System operating in 2400-2483.5MHz band and the output power less than 125mW. The hopping channel carrier frequencies separated by a minimum of 25kHz or two-thirds of the 20dB bandwidth of hopping channel whichever is greater.

### 2.1 MEASUREMENT UNCERTAINTY

Where relevant, the following measurement uncertainty levels have been estimated for tests performed on the EUT as specified in CISPR 16-4-2:

MEASUREMENT	FREQUENCY	UNCERTAINTY
Conducted Emission	150kHz ~ 30MHz	2.44 dB
	30MHz ~ 200MHz	2.44 dB
Radiated emissions	200MHz ~1000MHz	3.19 dB
	1GHz ~ 18GHz	3.21 dB
	18GHz ~ 40GHz	2.26 dB

This uncertainty represents an expanded uncertainty expressed at approximately the 95% confidence level using a coverage factor of k=2.

### 3. GENERAL INFORMATION

#### 3.1 GENERAL DESCRIPTION OF EUT

<b>EUT</b>	Point of Sale Terminal
<b>MODEL NO.</b>	VX600 Bluetooth
<b>FCC ID</b>	B32VX600BTCTLS
<b>POWER SUPPLY</b>	5Vdc (host equipment) 3.7Vdc (battery)
<b>MODULATION TYPE</b>	GFSK, $\pi/4$ -DQPSK, 8DPSK
<b>MODULATION TECHNOLOGY</b>	FHSS
<b>TRANSFER RATE</b>	1/2/3Mbps
<b>FREQUENCY RANGE</b>	2402 ~ 2480MHz
<b>NUMBER OF CHANNEL</b>	79
<b>CHANNEL SPACING</b>	1MHz
<b>OUTPUT POWER</b>	1.091mW
<b>ANTENNA TYPE</b>	Fix internal antenna with 1.02dBi gain
<b>ANTENNA CONNECTOR</b>	NA
<b>DATA CABLE</b>	Refer to note as below
<b>I/O PORTS</b>	Refer to user's manual
<b>ACCESSORY DEVICES</b>	Battery

**NOTE:**

1. The Bluetooth module (brand: ISSC, model: IS1657NM) is collocated in this EUT.
2. The EUT uses the following USB cable.

Brand Name	Model No.	Cable length
HUIZHOU SHENGHUA INDUSTRY CO.,	CBL000-021-01-A	1m non-shielded mini USB cable without core

3. The EUT uses following battery.

Battery	
<b>Brand</b>	VeriFone
<b>Model</b>	BPK087-201-01-A
<b>Power Rating</b>	3.7Vdc, 1440mAh

4. The above EUT information is declared by manufacturer and for more detailed feature description, please refer to the manufacturer's specifications or user's manual.



### 3.2 DESCRIPTION OF TEST MODES

79 channels are provided to this EUT:

CHANNEL	FREQ. (MHz)	CHANNEL	FREQ. (MHz)	CHANNEL	FREQ. (MHz)	CHANNEL	FREQ. (MHz)
0	2402	20	2422	40	2442	60	2462
1	2403	21	2423	41	2443	61	2463
2	2404	22	2424	42	2444	62	2464
3	2405	23	2425	43	2445	63	2465
4	2406	24	2426	44	2446	64	2466
5	2407	25	2427	45	2447	65	2467
6	2408	26	2428	46	2448	66	2468
7	2409	27	2429	47	2449	67	2469
8	2410	28	2430	48	2450	68	2470
9	2411	29	2431	49	2451	69	2471
10	2412	30	2432	50	2452	70	2472
11	2413	31	2433	51	2453	71	2473
12	2414	32	2434	52	2454	72	2474
13	2415	33	2435	53	2455	73	2475
14	2416	34	2436	54	2456	74	2476
15	2417	35	2437	55	2457	75	2477
16	2418	36	2438	56	2458	76	2478
17	2419	37	2439	57	2459	77	2479
18	2420	38	2440	58	2460	78	2480
19	2421	39	2441	59	2461		

### 3.2.1 CONFIGURATION OF SYSTEM UNDER TEST

#### TEST MODE A

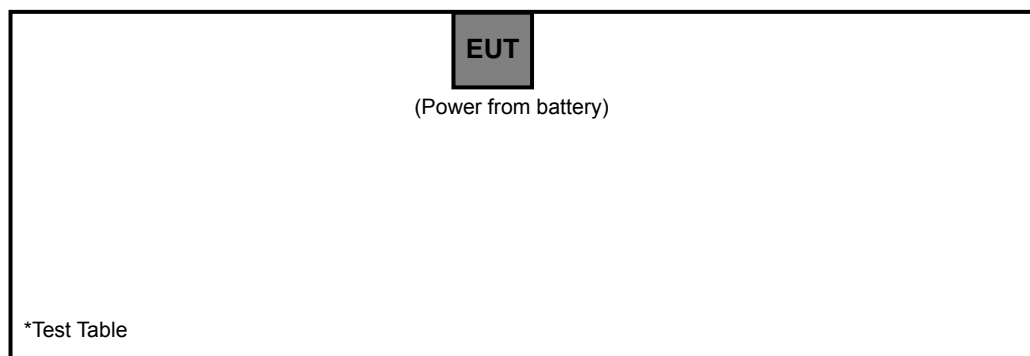

#### TEST MODE B

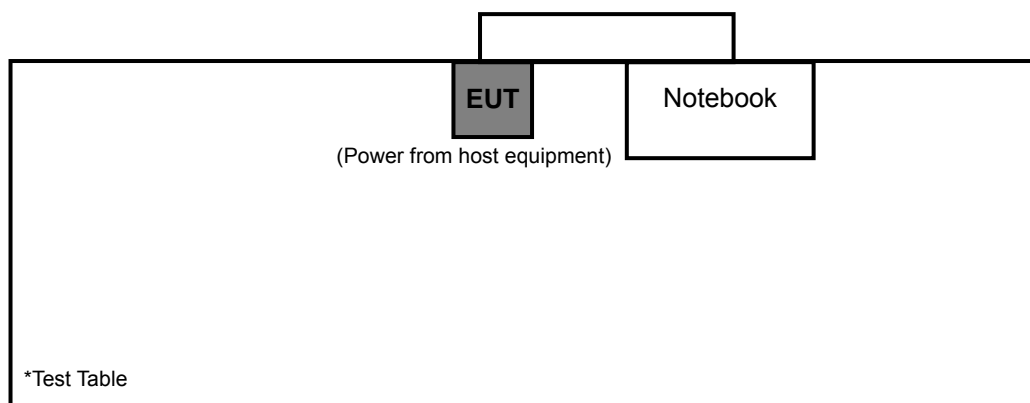

### 3.2.2 TEST MODE APPLICABILITY AND TESTED CHANNEL DETAIL

EUT CONFIGURE MODE	APPLICABLE TO				DESCRIPTION
	RE $\geq$ 1G	RE<1G	PLC	APCM	
A	-	√	-	-	EUT standalone + RFID off + BT on + smart card off + battery standby
B	√	√	√	√	EUT USB link + notebook + RFID off + BT on + smart card off + battery charging

Where **RE $\geq$ 1G**: Radiated Emission above 1GHz

**RE<1G**: Radiated Emission below 1GHz

**PLC**: Power Line Conducted Emission

**APCM**: Antenna Port Conducted Measurement

**NOTE**: "-": Means no effect.

\*The EUT was tested the above modes which are defined by client.

#### RADIATED EMISSION TEST (ABOVE 1 GHz):

- Pre-Scan has been conducted to determine the worst-case mode from all possible combinations between available modulations, XYZ axis, antenna ports (if EUT with antenna diversity architecture) and packet type.
- Following channel(s) was (were) selected for the final test as listed below.

EUT CONFIGURE MODE	AVAILABLE CHANNEL	TESTED CHANNEL	MODULATION TECHNOLOGY	MODULATION TYPE	PACKET TYPE	AXIS
B	0 to 78	0, 39, 78	FHSS	GFSK	DH5	X
B	0 to 78	0, 39, 78	FHSS	8DPSK	DH5	X

#### RADIATED EMISSION TEST (BELOW 1 GHz):

- Pre-Scan has been conducted to determine the worst-case mode from all possible combinations between available modulations, XYZ axis, antenna ports (if EUT with antenna diversity architecture) and packet type.
- Following channel(s) was (were) selected for the final test as listed below.

EUT CONFIGURE MODE	AVAILABLE CHANNEL	TESTED CHANNEL	MODULATION TECHNOLOGY	MODULATION TYPE	PACKET TYPE	AXIS
A, B	0 to 78	0	FHSS	8DPSK	DH5	X

### POWER LINE CONDUCTED EMISSION TEST:

- Pre-Scan has been conducted to determine the worst-case mode from all possible combinations between available modulations, data rates and antenna ports (if EUT with antenna diversity architecture).
- Following channel(s) was (were) selected for the final test as listed below.

EUT CONFIGURE MODE	AVAILABLE CHANNEL	TESTED CHANNEL	MODULATION TECHNOLOGY	MODULATION TYPE	PACKET TYPE
B	0 to 78	0	FHSS	8DPSK	DH5

### ANTENNA PORT CONDUCTED MEASUREMENT:

- This item includes all test value of each mode, but only includes spectrum plot of worst value of each mode.
- Pre-Scan has been conducted to determine the worst-case mode from all possible combinations between available modulations, antenna ports (if EUT with antenna diversity architecture), and packet types.
- Following channel(s) was (were) selected for the final test as listed below.

EUT CONFIGURE MODE	AVAILABLE CHANNEL	TESTED CHANNEL	MODULATION TECHNOLOGY	MODULATION TYPE	PACKET TYPE
B	0 to 78	0, 39, 78	FHSS	GFSK	DH5
B	0 to 78	0, 39, 78	FHSS	8DPSK	DH5

### TEST CONDITION:

APPLICABLE TO	TEST MODE	ENVIRONMENTAL CONDITIONS	INPUT POWER	TESTED BY
RE $\geq$ 1G	B	25deg. C, 68%RH	120Vac, 60Hz (System)	Sun Lin
RE $<$ 1G	A	25deg. C, 68%RH	3.7Vdc	Match Tsui
	B		120Vac, 60Hz (System)	
PLC	B	24deg. C, 64%RH	120Vac, 60Hz (System)	Match Tsui
APCM	B	25deg. C, 68%RH	120Vac, 60Hz (System)	Match Tsui

### 3.3 GENERAL DESCRIPTION OF APPLIED STANDARDS

The EUT is a RF Product. According to the specifications of the manufacturer, it must comply with the requirements of the following standards:

**FCC Part 15, Subpart C (15.247)**

**ANSI C63.4-2003**

**ANSI C63.10-2009**

All test items have been performed and recorded as per the above standards.

**NOTE:** The EUT is also considered as a kind of computer peripheral, because the connection to computer is necessary for typical use. It has been verified to comply with the requirements of FCC Part 15, Subpart B, Class B (DoC). The test report has been issued separately.

### 3.4 DESCRIPTION OF SUPPORT UNITS

The EUT has been tested as an independent unit together with other necessary accessories or support units. The following support units or accessories were used to form a representative test configuration during the tests.

NO.	PRODUCT	BRAND	MODEL NO.	SERIAL NO.	FCC ID
1	NOTEBOOK	DELL	E5410	1HC2XM1	NA

NO.	SIGNAL CABLE DESCRIPTION OF THE ABOVE SUPPORT UNITS
1	NA

**NOTE:** All power cords of the above support units are non-shielded (1.8m).

## 4. TEST TYPES AND RESULTS

### 4.1 RADIATED EMISSION MEASUREMENT

#### 4.1.1 LIMITS OF RADIATED EMISSION MEASUREMENT

Radiated emissions which fall in the restricted bands, as defined in Section 15.205(a), must also comply with the radiated emission limits specified in Section 15.209(a). Other emissions shall be at least 20dB below the highest level of the desired power.

FREQUENCIES (MHz)	FIELD STRENGTH (microvolts/meter)	MEASUREMENT DISTANCE (meters)
0.009 ~ 0.490	2400/F(kHz)	300
0.490 ~ 1.705	24000/F(kHz)	30
1.705 ~ 30.0	30	30
30 ~ 88	100	3
88 ~ 216	150	3
216 ~ 960	200	3
Above 960	500	3

**NOTE:**

1. The lower limit shall apply at the transition frequencies.
2. Emission level (dBuV/m) = 20 log Emission level (uV/m).
3. As shown in 15.35(b), for frequencies above 1000MHz, the field strength limits are based on average detector, however, the peak field strength of any emission shall not exceed the maximum permitted average limits, specified above by more than 20dB under any condition of modulation.

#### 4.1.2 TEST INSTRUMENTS

DESCRIPTION & MANUFACTURER	MODEL NO.	SERIAL NO.	DATE OF CALIBRATION	DUE DATE OF CALIBRATION
Test Receiver ROHDE & SCHWARZ	ESCI	100744	Apr. 19, 2011	Apr. 18, 2012
Spectrum Analyzer ROHDE & SCHWARZ	FSP40	100269	Jan. 06, 2011	Jan. 05, 2012
BILOG Antenna SCHWARZBECK	VULB9168	9168-156	Apr. 12, 2011	Apr. 11, 2012
HORN Antenna SCHWARZBECK	BBHA 9120 D	9120D-563	Sep. 06, 2011	Sep. 05, 2012
HORN Antenna SCHWARZBECK	BBHA 9170	BBHA9170243	Dec. 27, 2010	Dec. 26, 2011
Preamplifier Agilent	8449B	3008A01911	Oct. 29, 2011	Oct. 28, 2012
Preamplifier Agilent	8447D	2944A10638	Oct. 29, 2011	Oct. 28, 2012
RF signal cable HUBER+SUHNNER	SUCOFLEX 104	295013/4 283403/4	Aug. 19, 2011	Aug. 18, 2012
RF signal cable Worken	8D-FB	Cable-HYCH9-01	Aug. 13, 2011	Aug. 12, 2012
Software	ADT_Radiated_ V7.6.15.9.2	NA	NA	NA
Antenna Tower EMCO	2070/2080	512.835.4684	NA	NA
Turn Table EMCO	2087-2.03	NA	NA	NA
Antenna Tower & Turn Table Controller EMCO	2090	NA	NA	NA

- NOTE:**
1. The calibration interval of the above test instruments is 12 months and the calibrations are traceable to NML/ROC and NIST/USA.
  2. The test was performed in HwaYa Chamber 9.
  3. The horn antenna and HP preamplifier (model: 8449B) are used only for the measurement of emission frequency above 1GHz if tested.
  4. The FCC Site Registration No. is 460141.
  5. The IC Site Registration No. is IC 7450F-4.

#### 4.1.3 TEST PROCEDURES

- a. The EUT was placed on the top of a rotating table 0.8 meters above the ground at a 3 meter semi-anechoic chamber. The table was rotated 360 degrees to determine the position of the highest radiation.
- b. The EUT was set 3 meters away from the interference-receiving antenna, which was mounted on the top of a variable-height antenna tower.
- c. The antenna is a broadband antenna, and its height is varied from one meter to four meters above the ground to determine the maximum value of the field strength. Both horizontal and vertical polarizations of the antenna are set to make the measurement.
- d. For each suspected emission, the EUT was arranged to its worst case and then the antenna was tuned to heights from 1 meter to 4 meters and the rotatable table was turned from 0 degrees to 360 degrees to find the maximum reading.
- e. The test-receiver system was set to Peak Detect Function and Specified Bandwidth with Maximum Hold Mode.
- f. If the emission level of the EUT in peak mode was lower than the limit specified, then testing could be stopped and the peak values of the EUT would be reported. Otherwise the emissions would be re-tested one by one using peak, quasi-peak or average method as specified and then reported in a data sheet.

**NOTE:**

1. The resolution bandwidth and video bandwidth of test receiver/spectrum analyzer is 120kHz for Quasi-peak detection at frequency below 1GHz.
2. The resolution bandwidth of test receiver/spectrum analyzer is 1 MHz and video bandwidth is 3MHz for Peak detection at frequency above 1GHz.
3. All modes of operation were investigated and the worst-case emissions are reported.

#### 4.1.4 DEVIATION FROM TEST STANDARD

No deviation.



#### 4.1.5 TEST SETUP

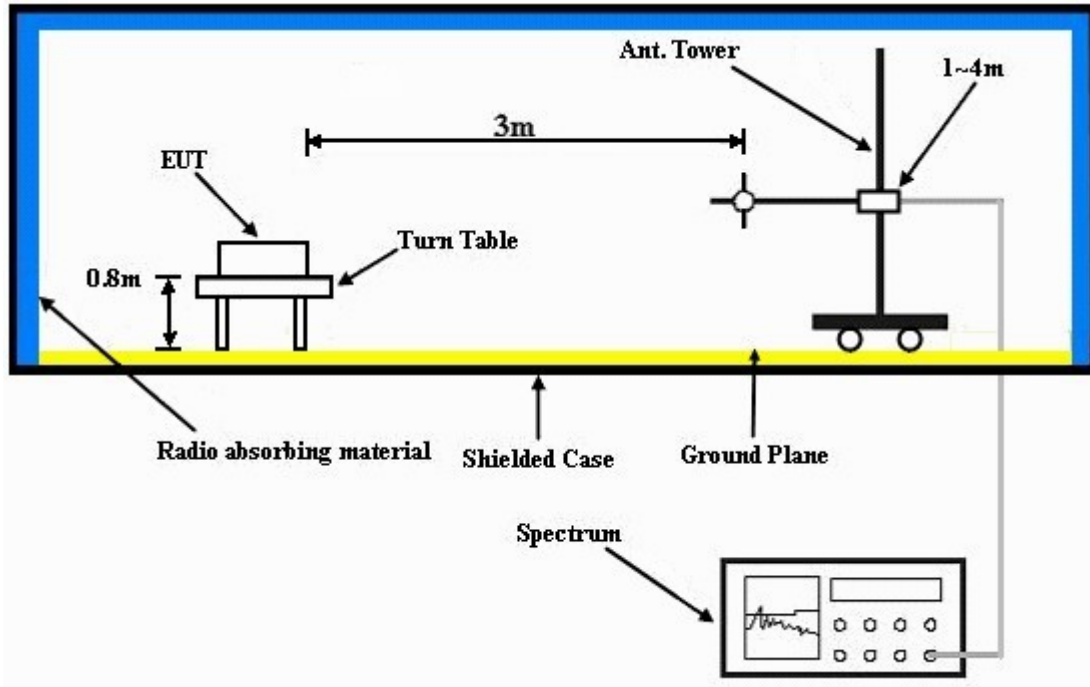

For the actual test configuration, please refer to the attached file (Test Setup Photo).

#### 4.1.6 EUT OPERATING CONDITIONS

- a. Placed the EUT on a testing table.
- b. Set the EUT under transmission condition continuously at specific channel frequency.



### 4.1.7 TEST RESULTS

#### GFSK MODULATION

EUT TEST CONDITION		MEASUREMENT DETAIL	
CHANNEL	Channel 0	FREQUENCY RANGE	1 ~ 25GHz
INPUT POWER (SYSTEM)	120Vac, 60 Hz	DETECTOR FUNCTION	Peak (PK) Average (AV)
ENVIRONMENTAL CONDITIONS	25deg. C, 68%RH	TESTED BY	Match Tsui

ANTENNA POLARITY & TEST DISTANCE: HORIZONTAL AT 3 M								
NO.	FREQ. (MHz)	EMISSION LEVEL (dBuV/m)	LIMIT (dBuV/m)	MARGIN (dB)	ANTENNA HEIGHT (m)	TABLE ANGLE (Degree)	RAW VALUE (dBuV)	CORRECTION FACTOR (dB/m)
1	2390.00	37.1 PK	74.0	-36.9	1.08 H	339	5.60	31.50
2	2390.00	26.0 AV	54.0	-28.0	1.08 H	339	-5.50	31.50
3	#2398.00	41.3 PK	74.4	-33.1	1.08 H	339	9.80	31.50
4	#2398.00	27.3 AV	44.3	-17.0	1.08 H	339	-4.20	31.50
5	#2400.00	48.1 PK	74.4	-26.3	1.08 H	339	16.60	31.50
6	#2400.00	18.0 AV	44.3	-26.3	1.08 H	339	-13.50	31.50
7	*2402.00	94.4 PK			1.08 H	339	62.80	31.60
8	*2402.00	64.3 AV			1.08 H	339	32.70	31.60
9	4804.00	52.9 PK	74.0	-21.1	1.11 H	3	15.30	37.60
10	4804.00	22.8 AV	54.0	-31.2	1.11 H	3	-14.80	37.60

- REMARKS:**
1. Emission level (dBuV/m) = Raw Value (dBuV) + Correction Factor (dB/m).
  2. Correction Factor (dB/m) = Antenna Factor (dB/m) + Cable Factor (dB).
  3. The other emission levels were very low against the limit.
  4. Margin value = Emission level – Limit value.
  5. “ \* “: Fundamental frequency.
  6. The DH5 packet was the worse case duty cycle for a transmit dwell time on a channel, based upon bluetooth theory the transmitter is on 0.625 \* 5 per 296.25 ms per channel. Therefore, the duty cycle correlation factor be equal to:  $20\log(3.125 / 100) = -30.1$  dB.
  7. Average value = peak reading +  $20\log(\text{duty cycle})$ .



A D T

EUT TEST CONDITION		MEASUREMENT DETAIL	
CHANNEL	Channel 0	FREQUENCY RANGE	1 ~ 25GHz
INPUT POWER (SYSTEM)	120Vac, 60 Hz	DETECTOR FUNCTION	Peak (PK) Average (AV)
ENVIRONMENTAL CONDITIONS	25deg. C, 68%RH	TESTED BY	Match Tsui

ANTENNA POLARITY & TEST DISTANCE: VERTICAL AT 3 M								
NO.	FREQ. (MHz)	EMISSION LEVEL (dBuV/m)	LIMIT (dBuV/m)	MARGIN (dB)	ANTENNA HEIGHT (m)	TABLE ANGLE (Degree)	RAW VALUE (dBuV)	CORRECTION FACTOR (dB/m)
1	2390.00	40.2 PK	74.0	-33.8	1.76 V	38	8.70	31.50
2	2390.00	27.3 AV	54.0	-26.7	1.76 V	38	-4.20	31.50
3	#2398.00	37.6 PK	66.7	-29.1	1.76 V	38	6.10	31.50
4	#2398.00	27.6 AV	36.6	-9.0	1.76 V	38	-3.90	31.50
5	#2400.00	38.6 PK	66.7	-28.1	1.76 V	38	7.10	31.50
6	#2400.00	8.5 AV	36.6	-28.1	1.76 V	38	-23.00	31.50
7	*2402.00	86.7 PK			1.76 V	38	55.10	31.60
8	*2402.00	56.6 AV			1.76 V	38	25.00	31.60
9	4804.00	47.3 PK	74.0	-26.7	1.00 V	357	9.70	37.60
10	4804.00	17.2 AV	54.0	-36.8	1.00 V	357	-20.40	37.60

- REMARKS:**
1. Emission level (dBuV/m) = Raw Value (dBuV) + Correction Factor (dB/m).
  2. Correction Factor (dB/m) = Antenna Factor (dB/m) + Cable Factor (dB).
  3. The other emission levels were very low against the limit.
  4. Margin value = Emission level – Limit value.
  5. “ \* “: Fundamental frequency.
  6. The DH5 packet was the worse case duty cycle for a transmit dwell time on a channel, based upon bluetooth theory the transmitter is on 0.625 \* 5 per 296.25 ms per channel. Therefore, the duty cycle correlation factor be equal to:  $20\log(3.125 / 100) = -30.1$  dB.
  7. Average value = peak reading +  $20\log(\text{duty cycle})$ .
  8. "#":The radiated frequency is out the restricted band.



A D T

EUT TEST CONDITION		MEASUREMENT DETAIL	
CHANNEL	Channel 39	FREQUENCY RANGE	1 ~ 25GHz
INPUT POWER (SYSTEM)	120Vac, 60 Hz	DETECTOR FUNCTION	Peak (PK) Average (AV)
ENVIRONMENTAL CONDITIONS	25deg. C, 68%RH	TESTED BY	Match Tsui

ANTENNA POLARITY & TEST DISTANCE: HORIZONTAL AT 3 M								
NO.	FREQ. (MHz)	EMISSION LEVEL (dBuV/m)	LIMIT (dBuV/m)	MARGIN (dB)	ANTENNA HEIGHT (m)	TABLE ANGLE (Degree)	RAW VALUE (dBuV)	CORRECTION FACTOR (dB/m)
1	2390.00	39.3 PK	74.0	-34.7	1.04 H	342	7.80	31.50
2	2390.00	26.8 AV	54.0	-27.2	1.04 H	342	-4.70	31.50
3	*2441.00	94.0 PK			1.04 H	342	62.30	31.70
4	*2441.00	63.9 AV			1.04 H	342	32.20	31.70
5	4882.00	51.4 PK	74.0	-22.6	1.07 H	10	13.60	37.80
6	4882.00	21.3 AV	54.0	-32.7	1.07 H	10	-16.50	37.80
ANTENNA POLARITY & TEST DISTANCE: VERTICAL AT 3 M								
NO.	FREQ. (MHz)	EMISSION LEVEL (dBuV/m)	LIMIT (dBuV/m)	MARGIN (dB)	ANTENNA HEIGHT (m)	TABLE ANGLE (Degree)	RAW VALUE (dBuV)	CORRECTION FACTOR (dB/m)
1	2390.00	38.6 PK	74.0	-35.4	1.74 V	37	7.10	31.50
2	2390.00	26.9 AV	54.0	-27.1	1.74 V	37	-4.60	31.50
3	*2441.00	85.8 PK			1.74 V	37	54.10	31.70
4	*2441.00	55.7 AV			1.74 V	37	24.00	31.70
5	4882.00	46.2 PK	74.0	-27.8	1.00 V	360	8.40	37.80
6	4882.00	16.1 AV	54.0	-37.9	1.00 V	360	-21.70	37.80

- REMARKS:**
1. Emission level (dBuV/m) = Raw Value (dBuV) + Correction Factor (dB/m).
  2. Correction Factor (dB/m) = Antenna Factor (dB/m) + Cable Factor (dB).
  3. The other emission levels were very low against the limit.
  4. Margin value = Emission level – Limit value.
  5. “ \* “: Fundamental frequency.
  6. The DH5 packet was the worse case duty cycle for a transmit dwell time on a channel, based upon bluetooth theory the transmitter is on 0.625 \* 5 per 296.25 ms per channel. Therefore, the duty cycle correlation factor be equal to:  $20\log(3.125 / 100) = -30.1$  dB.
  7. Average value = peak reading +  $20\log(\text{duty cycle})$ .



A D T

EUT TEST CONDITION		MEASUREMENT DETAIL	
CHANNEL	Channel 78	FREQUENCY RANGE	1 ~ 25GHz
INPUT POWER (SYSTEM)	120Vac, 60 Hz	DETECTOR FUNCTION	Peak (PK) Average (AV)
ENVIRONMENTAL CONDITIONS	25deg. C, 68%RH	TESTED BY	Match Tsui

ANTENNA POLARITY & TEST DISTANCE: HORIZONTAL AT 3 M								
NO.	FREQ. (MHz)	EMISSION LEVEL (dBuV/m)	LIMIT (dBuV/m)	MARGIN (dB)	ANTENNA HEIGHT (m)	TABLE ANGLE (Degree)	RAW VALUE (dBuV)	CORRECTION FACTOR (dB/m)
1	*2480.00	91.3 PK			1.04 H	28	59.40	31.90
2	*2480.00	61.2 AV			1.04 H	28	29.30	31.90
3	2483.50	35.5 PK	74.0	-38.5	1.04 H	28	3.60	31.90
4	2483.50	5.4 AV	54.0	-48.6	1.04 H	28	-26.50	31.90
5	2485.50	36.7 PK	74.0	-37.3	1.04 H	28	4.80	31.90
6	2485.50	27.0 AV	54.0	-27.0	1.04 H	28	-4.90	31.90
7	4960.00	46.4 PK	74.0	-27.6	1.00 H	32	8.40	38.00
8	4960.00	16.3 AV	54.0	-37.7	1.00 H	32	-21.70	38.00
ANTENNA POLARITY & TEST DISTANCE: VERTICAL AT 3 M								
NO.	FREQ. (MHz)	EMISSION LEVEL (dBuV/m)	LIMIT (dBuV/m)	MARGIN (dB)	ANTENNA HEIGHT (m)	TABLE ANGLE (Degree)	RAW VALUE (dBuV)	CORRECTION FACTOR (dB/m)
1	*2480.00	83.7 PK			1.62 V	38	51.80	31.90
2	*2480.00	53.6 AV			1.62 V	38	21.70	31.90
3	2483.50	36.4 PK	74.0	-37.6	1.62 V	38	4.50	31.90
4	2483.50	6.3 AV	54.0	-47.7	1.62 V	38	-25.60	31.90
5	2485.50	38.1 PK	74.0	-35.9	1.62 V	38	6.20	31.90
6	2485.50	27.5 AV	54.0	-26.5	1.62 V	38	-4.40	31.90
7	4960.00	45.4 PK	74.0	-28.6	1.00 V	357	7.40	38.00
8	4960.00	15.3 AV	54.0	-38.7	1.00 V	357	-22.70	38.00

- REMARKS:**
1. Emission level (dBuV/m) = Raw Value (dBuV) + Correction Factor (dB/m).
  2. Correction Factor (dB/m) = Antenna Factor (dB/m) + Cable Factor (dB).
  3. The other emission levels were very low against the limit.
  4. Margin value = Emission level – Limit value.
  5. “ \* “: Fundamental frequency.
  6. The DH5 packet was the worse case duty cycle for a transmit dwell time on a channel, based upon bluetooth theory the transmitter is on 0.625 \* 5 per 296.25 ms per channel. Therefore, the duty cycle correlation factor be equal to:  $20\log(3.125 / 100) = -30.1$  dB.
  7. Average value = peak reading +  $20\log(\text{duty cycle})$ .



### 8DPSK MODULATION

EUT TEST CONDITION		MEASUREMENT DETAIL	
CHANNEL	Channel 0	FREQUENCY RANGE	1 ~ 25GHz
INPUT POWER (SYSTEM)	120Vac, 60 Hz	DETECTOR FUNCTION	Peak (PK) Average (AV)
ENVIRONMENTAL CONDITIONS	25deg. C, 68%RH	TESTED BY	Match Tsui

ANTENNA POLARITY & TEST DISTANCE: HORIZONTAL AT 3 M								
NO.	FREQ. (MHz)	EMISSION LEVEL (dBuV/m)	LIMIT (dBuV/m)	MARGIN (dB)	ANTENNA HEIGHT (m)	TABLE ANGLE (Degree)	RAW VALUE (dBuV)	CORRECTION FACTOR (dB/m)
1	2390.00	37.5 PK	74.0	-36.5	1.10 H	6	6.00	31.50
2	2390.00	27.2 AV	54.0	-26.8	1.10 H	6	-4.30	31.50
3	#2398.00	37.7 PK	74.8	-37.1	1.10 H	6	6.20	31.50
4	#2398.00	28.0 AV	44.7	-16.7	1.10 H	6	-3.50	31.50
5	#2400.00	43.3 PK	74.8	-31.5	1.10 H	6	11.80	31.50
6	#2400.00	13.2 AV	44.7	-31.5	1.10 H	6	-18.30	31.50
7	*2402.00	94.8 PK			1.10 H	6	63.20	31.60
8	*2402.00	64.7 AV			1.10 H	6	33.10	31.60
9	4804.00	46.7 PK	74.0	-27.3	1.08 H	18	9.10	37.60
10	4804.00	16.6 AV	54.0	-37.4	1.08 H	18	-21.00	37.60

- REMARKS:**
- Emission level (dBuV/m) = Raw Value (dBuV) + Correction Factor (dB/m).
  - Correction Factor (dB/m) = Antenna Factor (dB/m) + Cable Factor (dB).
  - The other emission levels were very low against the limit.
  - Margin value = Emission level – Limit value.
  - \* \*: Fundamental frequency.
  - The DH5 packet was the worse case duty cycle for a transmit dwell time on a channel, based upon bluetooth theory the transmitter is on 0.625 \* 5 per 296.25 ms per channel. Therefore, the duty cycle correlation factor be equal to:  $20\log(3.125 / 100) = -30.1$  dB.
  - Average value = peak reading +  $20\log(\text{duty cycle})$ .



A D T

EUT TEST CONDITION		MEASUREMENT DETAIL	
CHANNEL	Channel 0	FREQUENCY RANGE	1 ~ 25GHz
INPUT POWER (SYSTEM)	120Vac, 60 Hz	DETECTOR FUNCTION	Peak (PK) Average (AV)
ENVIRONMENTAL CONDITIONS	25deg. C, 68%RH	TESTED BY	Match Tsui

ANTENNA POLARITY & TEST DISTANCE: VERTICAL AT 3 M								
NO.	FREQ. (MHz)	EMISSION LEVEL (dBuV/m)	LIMIT (dBuV/m)	MARGIN (dB)	ANTENNA HEIGHT (m)	TABLE ANGLE (Degree)	RAW VALUE (dBuV)	CORRECTION FACTOR (dB/m)
1	2390.00	38.2 PK	74.0	-35.8	1.77 V	47	6.70	31.50
2	2390.00	27.4 AV	54.0	-26.6	1.77 V	47	-4.10	31.50
3	#2398.00	37.3 PK	67.4	-30.1	1.77 V	47	5.80	31.50
4	#2398.00	27.8 AV	37.3	-9.5	1.77 V	47	-3.70	31.50
5	#2400.00	36.3 PK	67.4	-31.1	1.77 V	47	4.80	31.50
6	#2400.00	6.2 AV	37.3	-31.1	1.77 V	47	-25.30	31.50
7	*2402.00	87.4 PK			1.77 V	47	55.80	31.60
8	*2402.00	57.3 AV			1.77 V	47	25.70	31.60
9	4804.00	45.6 PK	74.0	-28.4	1.02 V	350	8.00	37.60
10	4804.00	15.5 AV	54.0	-38.5	1.02 V	350	-22.10	37.60

- REMARKS:**
1. Emission level (dBuV/m) = Raw Value (dBuV) + Correction Factor (dB/m).
  2. Correction Factor (dB/m) = Antenna Factor (dB/m) + Cable Factor (dB).
  3. The other emission levels were very low against the limit.
  4. Margin value = Emission level – Limit value.
  5. “ \* “: Fundamental frequency.
  6. The DH5 packet was the worse case duty cycle for a transmit dwell time on a channel, based upon bluetooth theory the transmitter is on 0.625 \* 5 per 296.25 ms per channel. Therefore, the duty cycle correlation factor be equal to:  $20\log(3.125 / 100) = -30.1$  dB.
  7. Average value = peak reading +  $20\log(\text{duty cycle})$ .
  8. "#":The radiated frequency is out the restricted band.



A D T

EUT TEST CONDITION		MEASUREMENT DETAIL	
CHANNEL	Channel 39	FREQUENCY RANGE	1 ~ 25GHz
INPUT POWER (SYSTEM)	120Vac, 60 Hz	DETECTOR FUNCTION	Peak (PK) Average (AV)
ENVIRONMENTAL CONDITIONS	25deg. C, 68%RH	TESTED BY	Match Tsui

ANTENNA POLARITY & TEST DISTANCE: HORIZONTAL AT 3 M								
NO.	FREQ. (MHz)	EMISSION LEVEL (dBuV/m)	LIMIT (dBuV/m)	MARGIN (dB)	ANTENNA HEIGHT (m)	TABLE ANGLE (Degree)	RAW VALUE (dBuV)	CORRECTION FACTOR (dB/m)
1	2390.00	38.4 PK	74.0	-35.6	1.06 H	8	6.90	31.50
2	2390.00	27.1 AV	54.0	-26.9	1.06 H	8	-4.40	31.50
3	*2441.00	94.4 PK			1.06 H	8	62.70	31.70
4	*2441.00	64.3 AV			1.06 H	8	32.60	31.70
5	4882.00	47.7 PK	74.0	-26.3	1.04 H	7	9.90	37.80
6	4882.00	17.6 AV	54.0	-36.4	1.04 H	7	-20.20	37.80
ANTENNA POLARITY & TEST DISTANCE: VERTICAL AT 3 M								
NO.	FREQ. (MHz)	EMISSION LEVEL (dBuV/m)	LIMIT (dBuV/m)	MARGIN (dB)	ANTENNA HEIGHT (m)	TABLE ANGLE (Degree)	RAW VALUE (dBuV)	CORRECTION FACTOR (dB/m)
1	2390.00	39.7 PK	74.0	-34.3	1.67 V	46	8.20	31.50
2	2390.00	26.8 AV	54.0	-27.2	1.67 V	46	-4.70	31.50
3	*2441.00	87.4 PK			1.67 V	46	55.70	31.70
4	*2441.00	57.3 AV			1.67 V	46	25.60	31.70
5	4882.00	45.7 PK	74.0	-28.3	1.00 V	360	7.90	37.80
6	4882.00	15.6 AV	54.0	-38.4	1.00 V	360	-22.20	37.80

- REMARKS:**
1. Emission level (dBuV/m) = Raw Value (dBuV) + Correction Factor (dB/m).
  2. Correction Factor (dB/m) = Antenna Factor (dB/m) + Cable Factor (dB).
  3. The other emission levels were very low against the limit.
  4. Margin value = Emission level – Limit value.
  5. “ \* “: Fundamental frequency.
  6. The DH5 packet was the worse case duty cycle for a transmit dwell time on a channel, based upon bluetooth theory the transmitter is on 0.625 \* 5 per 296.25 ms per channel. Therefore, the duty cycle correlation factor be equal to:  $20\log(3.125 / 100) = -30.1$  dB.
  7. Average value = peak reading +  $20\log(\text{duty cycle})$ .





A D T

EUT TEST CONDITION		MEASUREMENT DETAIL	
CHANNEL	Channel 78	FREQUENCY RANGE	1 ~ 25GHz
INPUT POWER (SYSTEM)	120Vac, 60 Hz	DETECTOR FUNCTION	Peak (PK) Average (AV)
ENVIRONMENTAL CONDITIONS	25deg. C, 68%RH	TESTED BY	Match Tsui

**ANTENNA POLARITY & TEST DISTANCE: HORIZONTAL AT 3 M**

NO.	FREQ. (MHz)	EMISSION LEVEL (dBuV/m)	LIMIT (dBuV/m)	MARGIN (dB)	ANTENNA HEIGHT (m)	TABLE ANGLE (Degree)	RAW VALUE (dBuV)	CORRECTION FACTOR (dB/m)
1	*2480.00	92.9 PK			1.07 H	7	61.00	31.90
2	*2480.00	62.8 AV			1.07 H	7	30.90	31.90
3	2483.50	32.6 PK	74.0	-41.4	1.07 H	7	0.70	31.90
4	2483.50	2.5 AV	54.0	-51.5	1.07 H	7	-29.40	31.90
5	2485.50	37.2 PK	74.0	-36.8	1.07 H	7	5.30	31.90
6	2485.50	27.2 AV	54.0	-26.8	1.07 H	7	-4.70	31.90
7	4960.00	45.4 PK	74.0	-28.6	1.00 H	23	7.40	38.00
8	4960.00	15.3 AV	54.0	-38.7	1.00 H	23	-22.70	38.00

**ANTENNA POLARITY & TEST DISTANCE: VERTICAL AT 3 M**

NO.	FREQ. (MHz)	EMISSION LEVEL (dBuV/m)	LIMIT (dBuV/m)	MARGIN (dB)	ANTENNA HEIGHT (m)	TABLE ANGLE (Degree)	RAW VALUE (dBuV)	CORRECTION FACTOR (dB/m)
1	*2480.00	85.8 PK			1.65 V	44	53.90	31.90
2	*2480.00	55.7 AV			1.65 V	44	23.80	31.90
3	2483.50	32.2 PK	74.0	-41.8	1.65 V	44	0.30	31.90
4	2483.50	2.1 AV	54.0	-51.9	1.65 V	44	-29.80	31.90
5	2485.50	37.6 PK	74.0	-36.4	1.65 V	44	5.70	31.90
6	2485.50	27.2 AV	54.0	-26.8	1.65 V	44	-4.70	31.90
7	4960.00	46.0 PK	74.0	-28.0	1.00 V	0	8.00	38.00
8	4960.00	15.9 AV	54.0	-38.1	1.00 V	0	-22.10	38.00

- REMARKS:**
- Emission level (dBuV/m) = Raw Value (dBuV) + Correction Factor (dB/m).
  - Correction Factor (dB/m) = Antenna Factor (dB/m) + Cable Factor (dB).
  - The other emission levels were very low against the limit.
  - Margin value = Emission level – Limit value.
  - \* \*: Fundamental frequency.
  - The DH5 packet was the worse case duty cycle for a transmit dwell time on a channel, based upon bluetooth theory the transmitter is on 0.625 \* 5 per 296.25 ms per channel. Therefore, the duty cycle correlation factor be equal to:  $20\log(3.125 / 100) = -30.1$  dB.
  - Average value = peak reading +  $20\log(\text{duty cycle})$ .



A D T

## BELOW 1GHz WORST-CASE DATA : 8DPSK MODULATION

EUT TEST CONDITION		MEASUREMENT DETAIL	
CHANNEL	Channel 0	FREQUENCY RANGE	Below 1000MHz
INPUT POWER (SYSTEM)	3.7Vdc	DETECTOR FUNCTION	Quasi-Peak
ENVIRONMENTAL CONDITIONS	25deg. C, 68%RH	TESTED BY	Sun Lin
TEST MODE	A		

ANTENNA POLARITY & TEST DISTANCE: HORIZONTAL AT 3 M								
NO.	FREQ. (MHz)	EMISSION LEVEL (dBuV/m)	LIMIT (dBuV/m)	MARGIN (dB)	ANTENNA HEIGHT (m)	TABLE ANGLE (Degree)	RAW VALUE (dBuV)	CORRECTION FACTOR (dB/m)
1	99.89	24.5 QP	43.5	-19.0	1.25 H	55	16.00	8.50
2	134.89	15.8 QP	43.5	-27.7	1.25 H	334	2.50	13.30
3	401.26	17.9 QP	46.0	-28.1	1.25 H	76	0.90	17.00
4	514.03	24.2 QP	46.0	-21.8	1.00 H	160	4.20	20.00
5	543.19	25.4 QP	46.0	-20.6	1.25 H	175	4.60	20.80
6	681.24	22.7 QP	46.0	-23.3	1.25 H	10	-0.30	23.00
ANTENNA POLARITY & TEST DISTANCE: VERTICAL AT 3 M								
NO.	FREQ. (MHz)	EMISSION LEVEL (dBuV/m)	LIMIT (dBuV/m)	MARGIN (dB)	ANTENNA HEIGHT (m)	TABLE ANGLE (Degree)	RAW VALUE (dBuV)	CORRECTION FACTOR (dB/m)
1	30.00	20.9 QP	40.0	-19.1	1.00 V	10	8.90	12.00
2	76.56	23.8 QP	40.0	-16.2	1.00 V	229	13.80	10.00
3	134.89	28.4 QP	43.5	-15.1	1.00 V	316	15.10	13.30
4	158.22	23.1 QP	43.5	-20.4	1.00 V	250	8.90	14.20
5	189.33	22.1 QP	43.5	-21.4	1.00 V	40	11.30	10.80
6	241.83	26.4 QP	46.0	-19.6	1.00 V	208	14.20	12.20

- REMARKS:**
1. Emission level (dBuV/m) = Raw Value (dBuV) + Correction Factor (dB/m).
  2. Correction Factor (dB/m) = Antenna Factor (dB/m) + Cable Factor (dB).
  3. The other emission levels were very low against the limit.
  4. Margin value = Emission level – Limit value.



A D T

EUT TEST CONDITION		MEASUREMENT DETAIL	
CHANNEL	Channel 0	FREQUENCY RANGE	Below 1000MHz
INPUT POWER (SYSTEM)	120Vac, 60 Hz	DETECTOR FUNCTION	Quasi-Peak
ENVIRONMENTAL CONDITIONS	25deg. C, 68%RH	TESTED BY	Sun Lin
TEST MODE	B		

ANTENNA POLARITY & TEST DISTANCE: HORIZONTAL AT 3 M								
NO.	FREQ. (MHz)	EMISSION LEVEL (dBuV/m)	LIMIT (dBuV/m)	MARGIN (dB)	ANTENNA HEIGHT (m)	TABLE ANGLE (Degree)	RAW VALUE (dBuV)	CORRECTION FACTOR (dB/m)
1	77.08	30.5 QP	40.0	-9.5	1.15 H	0	20.60	9.90
2	189.33	25.9 QP	43.5	-17.6	1.00 H	55	15.10	10.80
3	241.83	25.8 QP	46.0	-20.2	1.00 H	262	13.60	12.20
4	300.16	31.5 QP	46.0	-14.5	1.00 H	337	16.80	14.70
5	533.47	26.0 QP	46.0	-20.0	1.25 H	205	5.50	20.50
6	599.58	27.7 QP	46.0	-18.3	1.00 H	277	5.60	22.10
ANTENNA POLARITY & TEST DISTANCE: VERTICAL AT 3 M								
NO.	FREQ. (MHz)	EMISSION LEVEL (dBuV/m)	LIMIT (dBuV/m)	MARGIN (dB)	ANTENNA HEIGHT (m)	TABLE ANGLE (Degree)	RAW VALUE (dBuV)	CORRECTION FACTOR (dB/m)
1	76.56	32.1 QP	40.0	-7.9	1.50 V	265	22.10	10.00
2	134.89	28.7 QP	43.5	-14.8	1.00 V	256	15.40	13.30
3	241.83	25.0 QP	46.0	-21.0	1.00 V	19	12.80	12.20
4	300.16	28.2 QP	46.0	-17.8	1.50 V	259	13.50	14.70
5	444.03	27.1 QP	46.0	-18.9	1.25 V	193	9.00	18.10
6	599.58	28.3 QP	46.0	-17.7	1.25 V	34	6.20	22.10

- REMARKS:**
1. Emission level (dBuV/m) = Raw Value (dBuV) + Correction Factor (dB/m).
  2. Correction Factor (dB/m) = Antenna Factor (dB/m) + Cable Factor (dB).
  3. The other emission levels were very low against the limit.
  4. Margin value = Emission level – Limit value.

## 4.2 CONDUCTED EMISSION MEASUREMENT

### 4.2.1 LIMITS OF CONDUCTED EMISSION MEASUREMENT

FREQUENCY OF EMISSION (MHz)	CONDUCTED LIMIT (dB $\mu$ V)	
	Quasi-peak	Average
0.15 ~ 0.5	66 to 56	56 to 46
0.5 ~ 5	56	46
5 ~ 30	60	50

- NOTE:**
1. The lower limit shall apply at the transition frequencies.
  2. The limit decreases in line with the logarithm of the frequency in the range of 0.15 to 0.50 MHz.
  3. All emanations from a class A/B digital device or system, including any network of conductors and apparatus connected thereto, shall not exceed the level of field strengths specified above.

### 4.2.2 TEST INSTRUMENTS

DESCRIPTION & MANUFACTURER	MODEL NO.	SERIAL NO.	DATE OF CALIBRATION	DUE DATE OF CALIBRATION
Test Receiver ROHDE & SCHWARZ	ESCS30	100291	Nov. 30, 2010	Nov. 29, 2011
RF signal cable Woken	5D-FB	Cable-HYC01-01	Dec. 30, 2010	Dec. 29, 2011
LISN ROHDE & SCHWARZ	ESH3-Z5	100312	Jul. 07, 2011	Jul. 06, 2012
V-LISN SCHWARZBECK	NNBL 8226-2	8226-142	Jun. 30, 2011	Jun. 29, 2012
Software ADT	ADT_Cond_ V7.3.7	NA	NA	NA

- NOTE:**
1. The calibration interval of the above test instruments is 12 months and the calibrations are traceable to NML/ROC and NIST/USA.
  2. The test was performed in HwaYa Shielded Room 1.
  3. The VCCI Site Registration No. is C-2040.

### 4.2.3 TEST PROCEDURES

- a. The EUT was placed 0.4 meters from the conducting wall of the shielded room with EUT being connected to the power mains through a line impedance stabilization network (LISN). Other support units were connected to the power mains through another LISN. The two LISNs provide 50 ohm/ 50uH of coupling impedance for the measuring instrument.
- b. Both lines of the power mains connected to the EUT were checked for maximum conducted interference.
- c. The frequency range from 150kHz to 30MHz was searched. Emission levels under (Limit - 20dB) was not recorded.

**NOTE:** All modes of operation were investigated and the worst-case emissions are reported.

### 4.2.4 DEVIATION FROM TEST STANDARD

No deviation.

#### 4.2.5 TEST SETUP

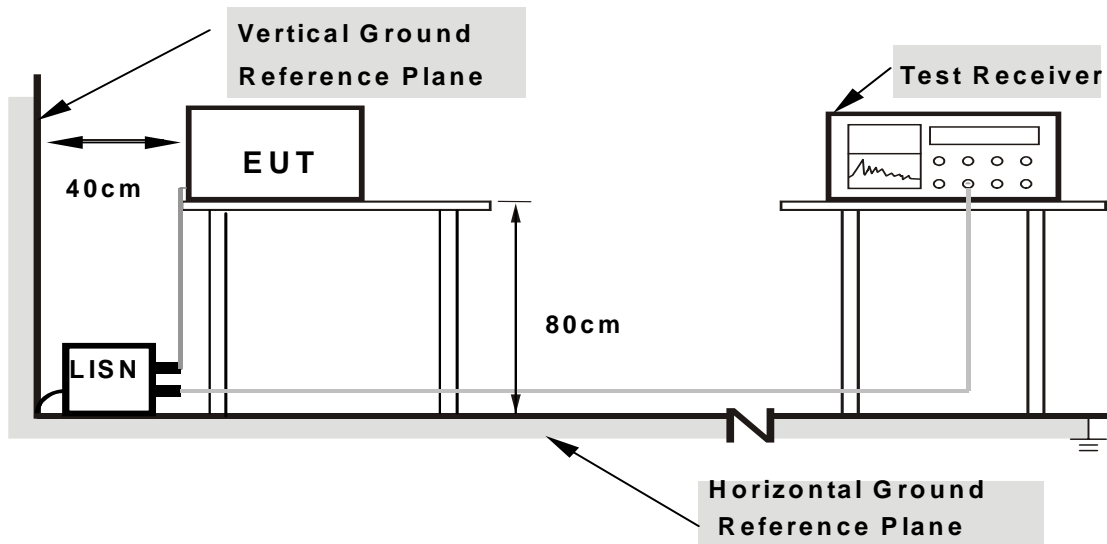

- Note: 1.Support units were connected to second LISN.  
2.Both of LISNs (AMN) are 80 cm from EUT and at least 80 from other units and other metal planes**

For the actual test configuration, please refer to the attached file (Test Setup Photo).

#### 4.2.6 EUT OPERATING CONDITIONS

Same as 4.1.6.

## 4.2.7 TEST RESULTS

### CONDUCTED WORST CASE DATA: 8DPSK

PHASE	Line 1	6dB BANDWIDTH	9kHz
TEST MODE	B		

No	Freq. [MHz]	Corr. Factor (dB)	Reading Value		Emission Level		Limit		Margin	
			[dB (uV)]		[dB (uV)]		[dB (uV)]		(dB)	
			Q.P.	AV.	Q.P.	AV.	Q.P.	AV.	Q.P.	AV.
1	0.154	0.15	31.41	19.05	31.56	19.20	65.79	55.79	-34.23	-36.59
2	0.513	0.17	39.16	36.89	39.33	37.06	56.00	46.00	-16.67	-8.94
3	0.650	0.18	29.25	20.84	29.43	21.02	56.00	46.00	-26.57	-24.98
4	1.719	0.21	27.91	20.23	28.12	20.44	56.00	46.00	-27.88	-25.56
5	2.129	0.23	28.63	19.86	28.86	20.09	56.00	46.00	-27.14	-25.91
6	19.797	1.13	39.34	32.24	40.47	33.37	60.00	50.00	-19.53	-16.63

- REMARKS:**
1. Q.P. and AV. are abbreviations of quasi-peak and average individually.
  2. "-": The Quasi-peak reading value also meets average limit and measurement with the average detector is unnecessary.
  3. The emission levels of other frequencies were very low against the limit.
  4. Margin value = Emission level - Limit value
  5. Correction factor = Insertion loss + Cable loss
  6. Emission Level = Correction Factor + Reading Value.

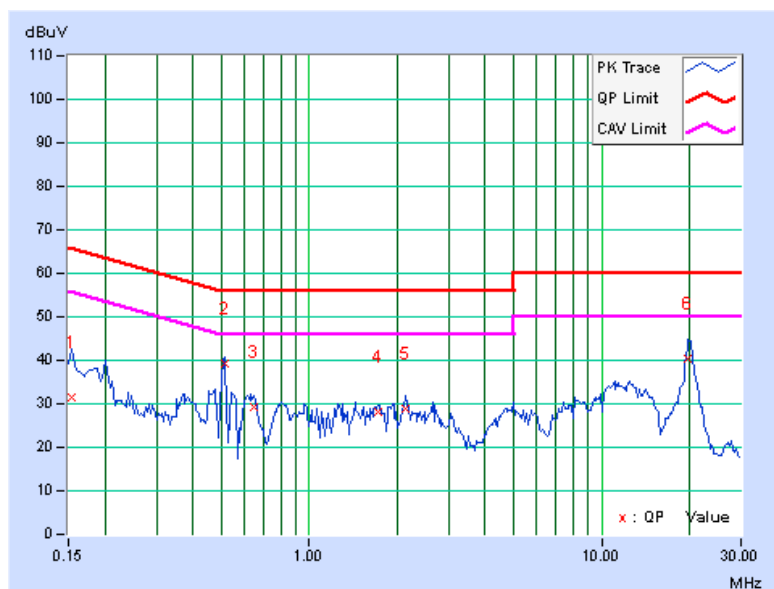

PHASE	Line 2	6dB BANDWIDTH	9kHz
TEST MODE	B		

No	Freq. [MHz]	Corr. Factor (dB)	Reading Value [dB (uV)]		Emission Level [dB (uV)]		Limit [dB (uV)]		Margin (dB)	
			Q.P.	AV.	Q.P.	AV.	Q.P.	AV.	Q.P.	AV.
	1	0.154	0.16	32.27	17.96	32.43	18.12	65.79	55.79	-33.36
2	<b>0.509</b>	<b>0.19</b>	<b>39.06</b>	<b>38.08</b>	<b>39.25</b>	<b>38.27</b>	<b>56.00</b>	<b>46.00</b>	<b>-16.75</b>	<b>-7.73</b>
3	0.637	0.20	26.88	20.96	27.08	21.16	56.00	46.00	-28.92	-24.84
4	1.750	0.23	24.57	17.12	24.80	17.35	56.00	46.00	-31.20	-28.65
5	2.176	0.24	28.72	19.17	28.96	19.41	56.00	46.00	-27.04	-26.59
6	20.095	0.92	36.58	30.16	37.50	31.08	60.00	50.00	-22.50	-18.92

- REMARKS:**
1. Q.P. and AV. are abbreviations of quasi-peak and average individually.
  2. "-": The Quasi-peak reading value also meets average limit and measurement with the average detector is unnecessary.
  3. The emission levels of other frequencies were very low against the limit.
  4. Margin value = Emission level - Limit value
  5. Correction factor = Insertion loss + Cable loss
  6. Emission Level = Correction Factor + Reading Value.

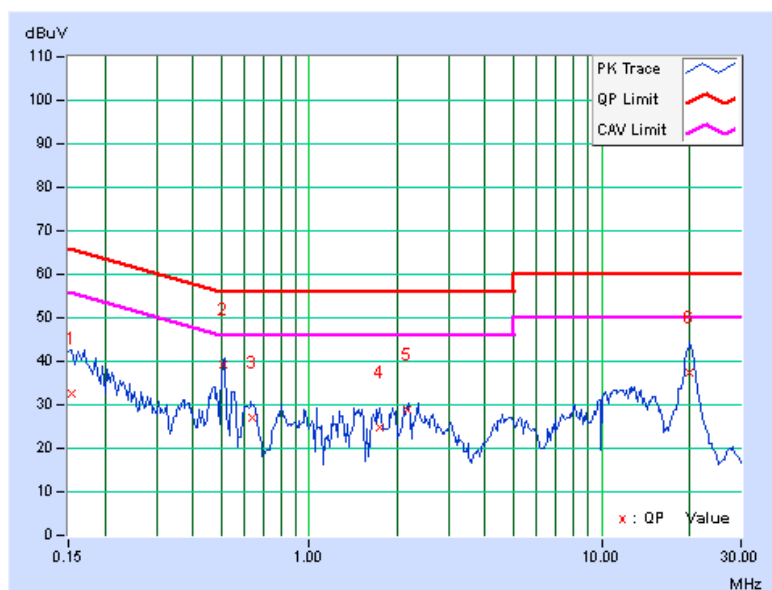



### 4.3 NUMBER OF HOPPING FREQUENCY USED

#### 4.3.1 LIMIT OF HOPPING FREQUENCY USED

At least 15 channels frequencies, and should be equally spaced.

#### 4.3.2 TEST INSTRUMENTS

DESCRIPTION & MANUFACTURER	MODEL NO.	SERIAL NO.	DATE OF CALIBRATION	DUE DATE OF CALIBRATION
SPECTRUM ANALYZER R&S	FSP40	100039	Jan. 11, 2011	Jan. 10, 2012

**NOTE:** The calibration interval of the above test instruments is 12 months and the calibrations are traceable to NML/ROC and NIST/USA.

#### 4.3.3 TEST PROCEDURES

- a. Check the calibration of the measuring instrument (SA) using either an internal calibrator or a known signal from an external generator.
- b. Turn on the EUT and connect its antenna terminal to measurement via a low loss cable. Then set it to any one measured frequency within its operating range and make sure the instrument is operated in its linear range.
- c. Set the SA on MaxHold Mode, and then keep the EUT in hopping mode. Record all the signals from each channel until each one has been recorded.
- d. Set the SA on View mode and then plot the result on SA screen.
- e. Repeat above procedures until all frequencies measured were complete.

#### 4.3.4 DEVIATION FROM TEST STANDARD

No deviation.

#### 4.3.5 TEST SETUP

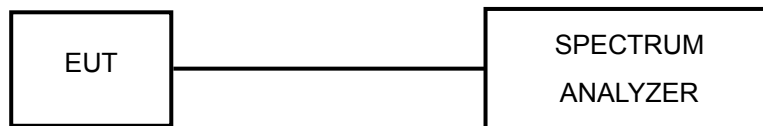

#### 4.3.6 TEST RESULTS

There are 79 hopping frequencies in the hopping mode. Please refer to next two pages for the test result. On the plots, it shows that the hopping frequencies are equally spaced.



A D T

### GFSK

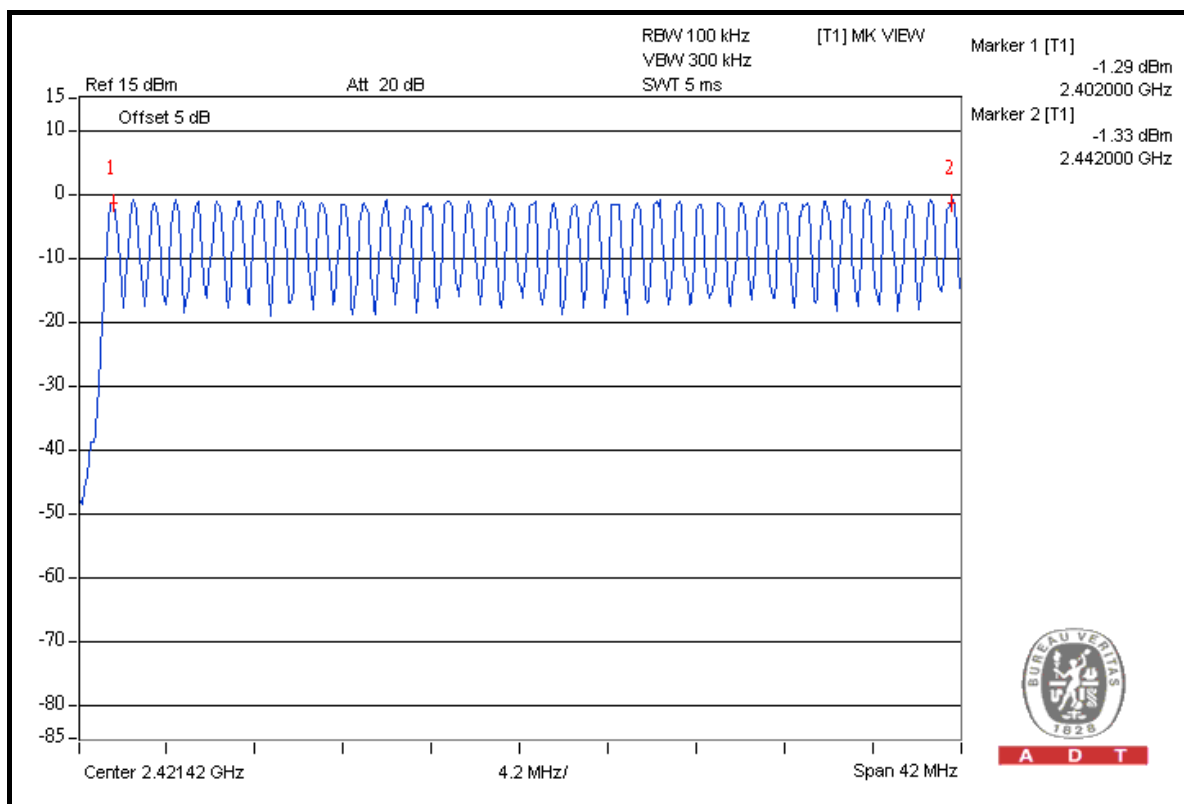

A D T

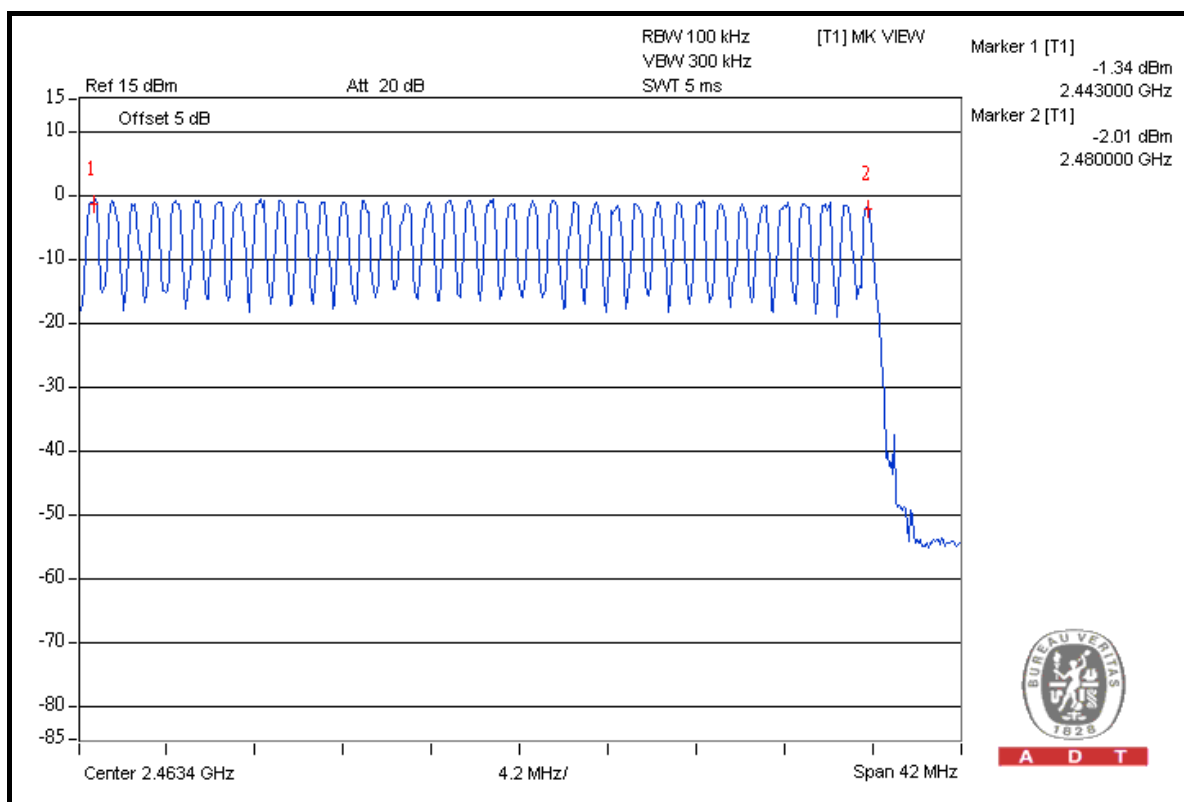

A D T



A D T

### 8DPSK

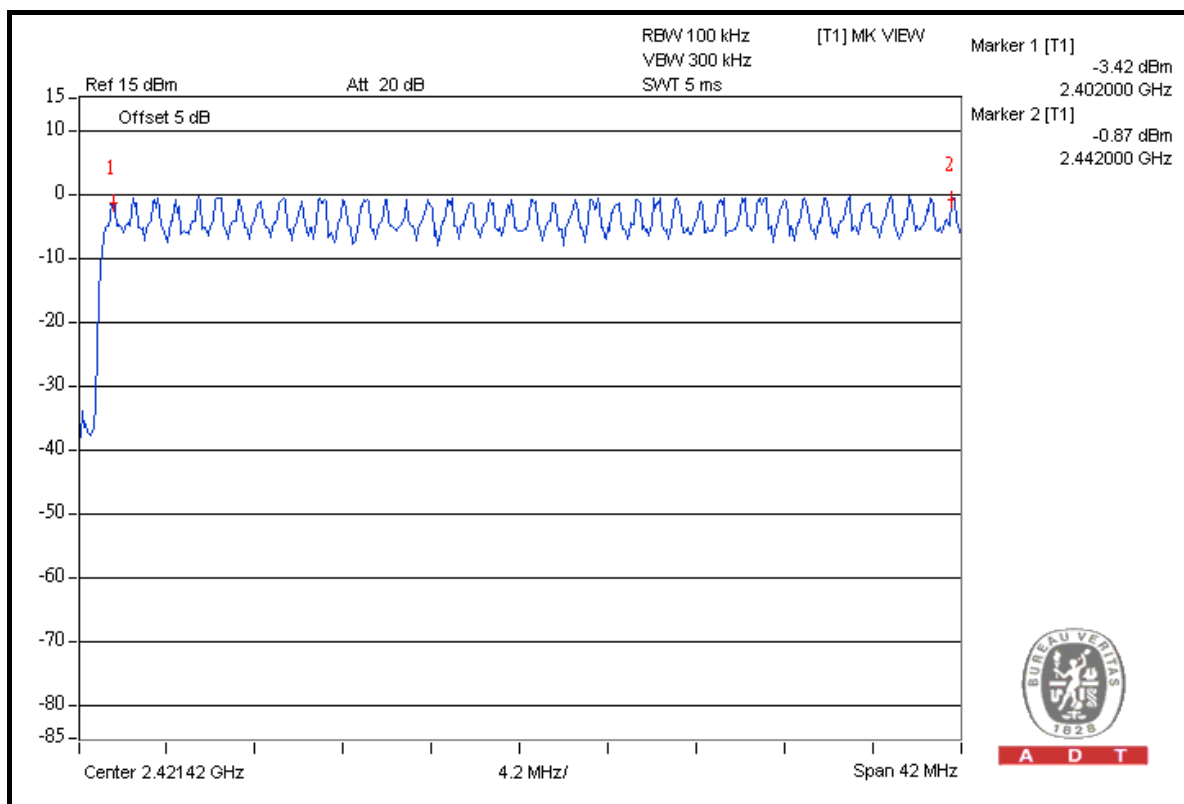

A D T

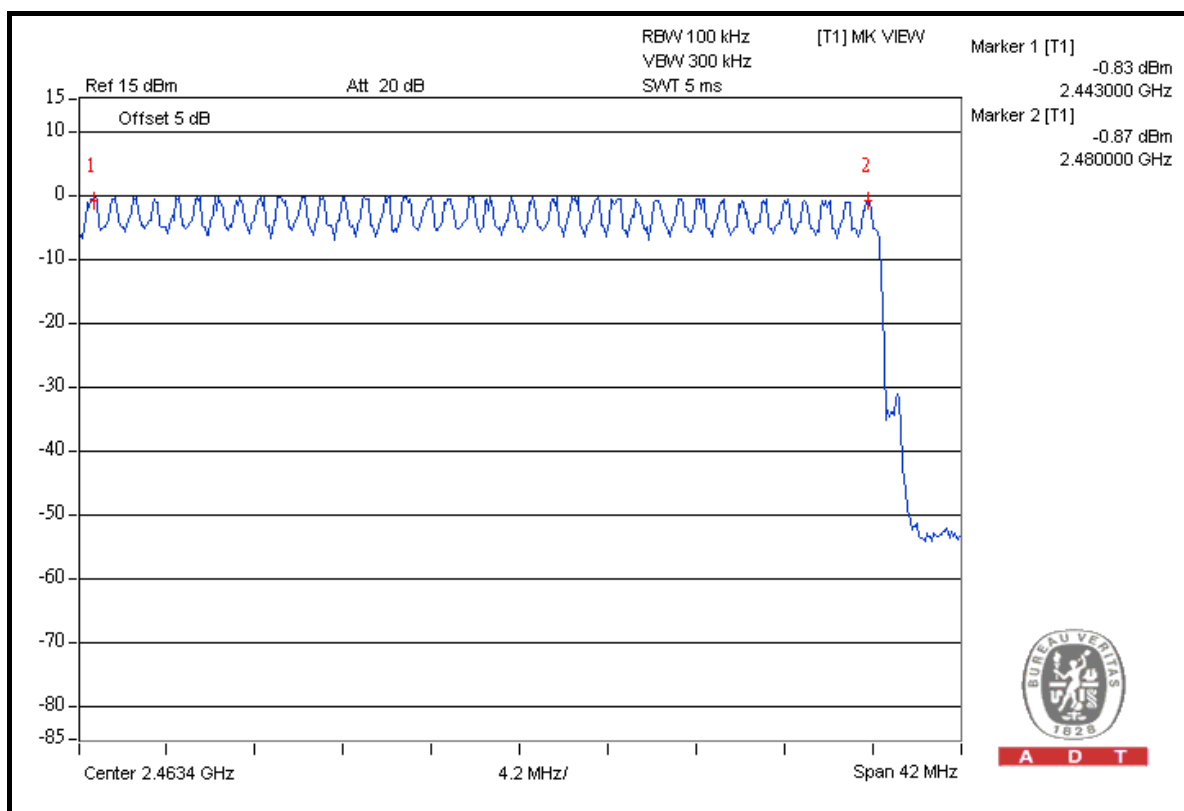

A D T

#### 4.4 DWELL TIME ON EACH CHANNEL

##### 4.4.1 LIMIT OF DWELL TIME USED

The average time of occupancy on any channel shall not be greater than 0.4 seconds within a period of 0.4 seconds multiplied by the number of hopping channels employed.

##### 4.4.2 TEST INSTRUMENTS

DESCRIPTION & MANUFACTURER	MODEL NO.	SERIAL NO.	DATE OF CALIBRATION	DUE DATE OF CALIBRATION
SPECTRUM ANALYZER R&S	FSP40	100039	Jan. 11, 2011	Jan. 10, 2012

**NOTE:** The calibration interval of the above test instruments is 12 months and the calibrations are traceable to NML/ROC and NIST/USA.

##### 4.4.3 TEST PROCEDURES

- a. Check the calibration of the measuring instrument (SA) using either an internal calibrator or a known signal from an external generator.
- b. Turn on the EUT and connect its antenna terminal to measurement via a low loss cable. Then set it to any one measured frequency within its operating range and make sure the instrument is operated in its linear range.
- c. Adjust the center frequency of SA on any frequency be measured and set SA to zero span mode. And then, set RBW and VBW of spectrum analyzer to proper value.
- d. Measure the time duration of one transmission on the measured frequency. And then plot the result with time difference of this time duration.
- e. Repeat above procedures until all different time-slot modes have been completed.

##### 4.4.4 DEVIATION FROM TEST STANDARD

No deviation.

##### 4.4.5 TEST SETUP

Same as 4.3.5.

#### 4.4.6 TEST RESULTS

##### GFSK

Mode	Number of transmission in a 31.6 (79Hopping*0.4)	Length of transmission time (msec)	Result (msec)	Limit (msec)
DH1	51 (times / 5 sec) * 6.32 = 322.32 times	0.438	141.176	400
DH3	25 (times / 5 sec) * 6.32 = 158 times	1.74	274.92	400
DH5	17 (times / 5 sec) * 6.32 = 107.44 times	2.95	316.948	400

**NOTE:** Test plots of the transmitting time slot are shown on next 3 pages.



A D T

### DH1

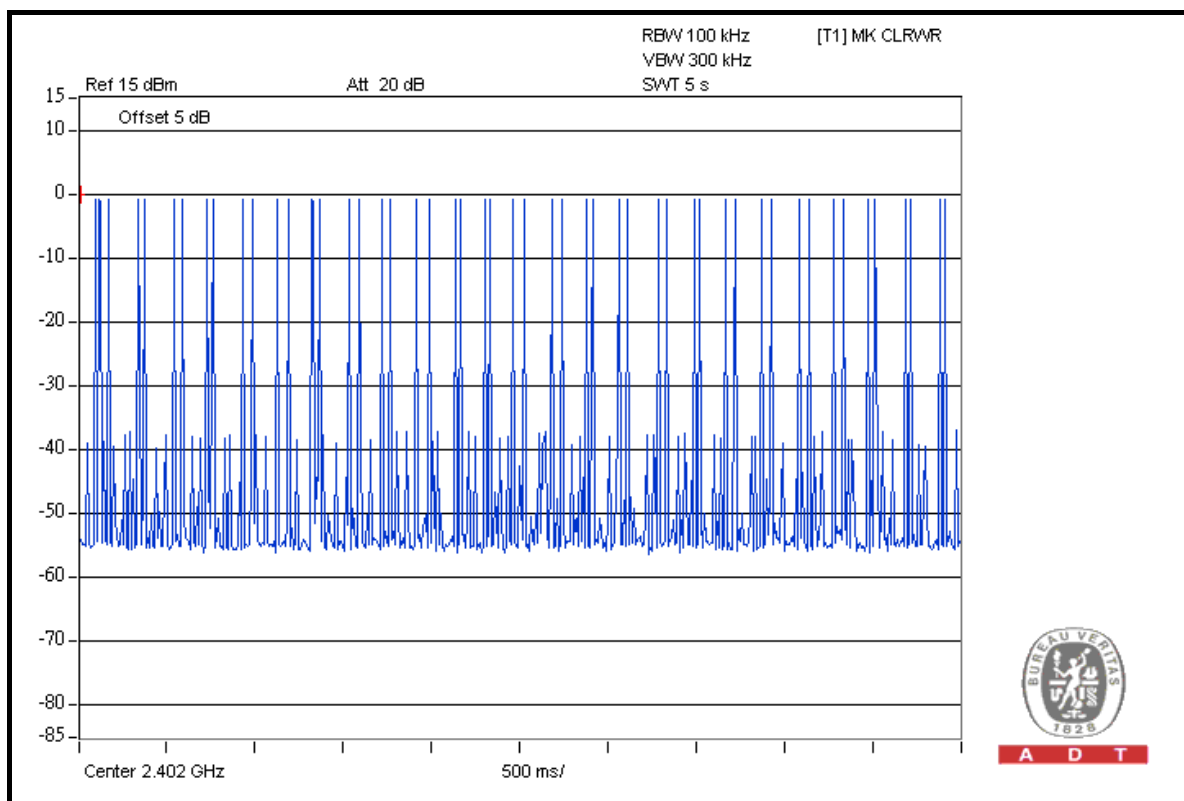

A D T

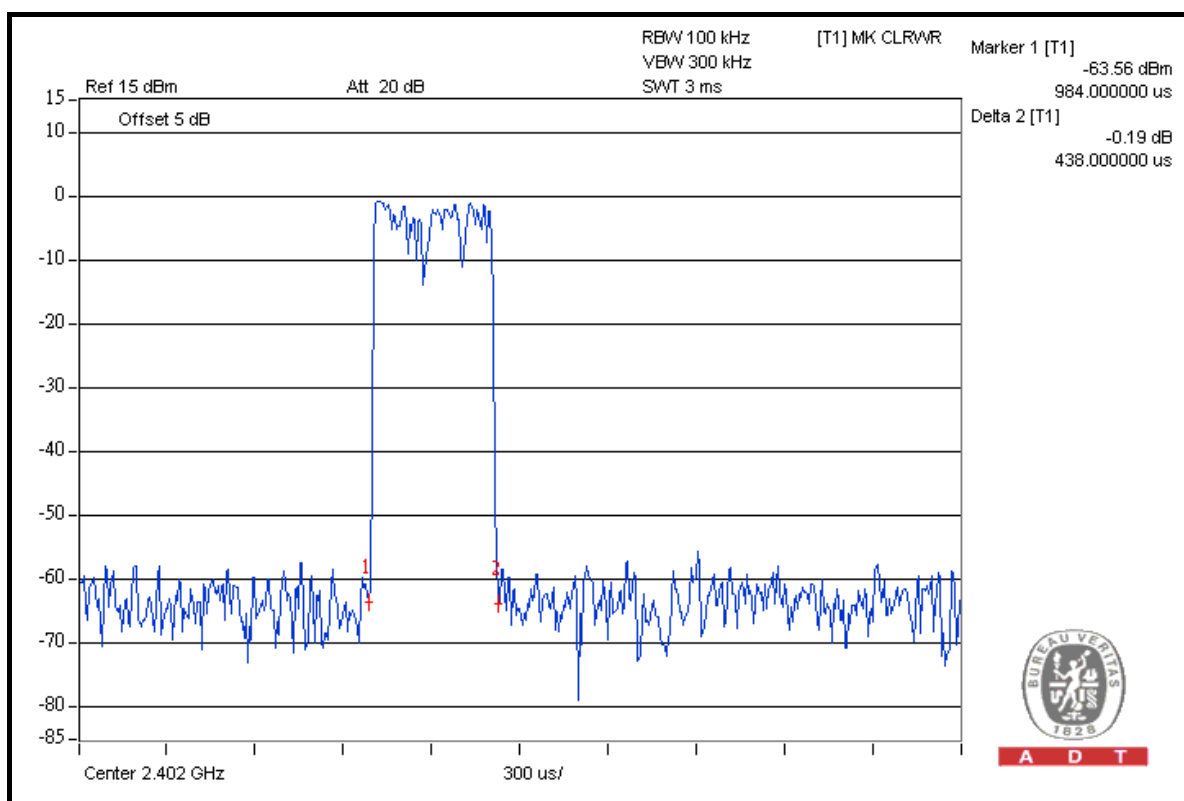

A D T



A D T

### DH3

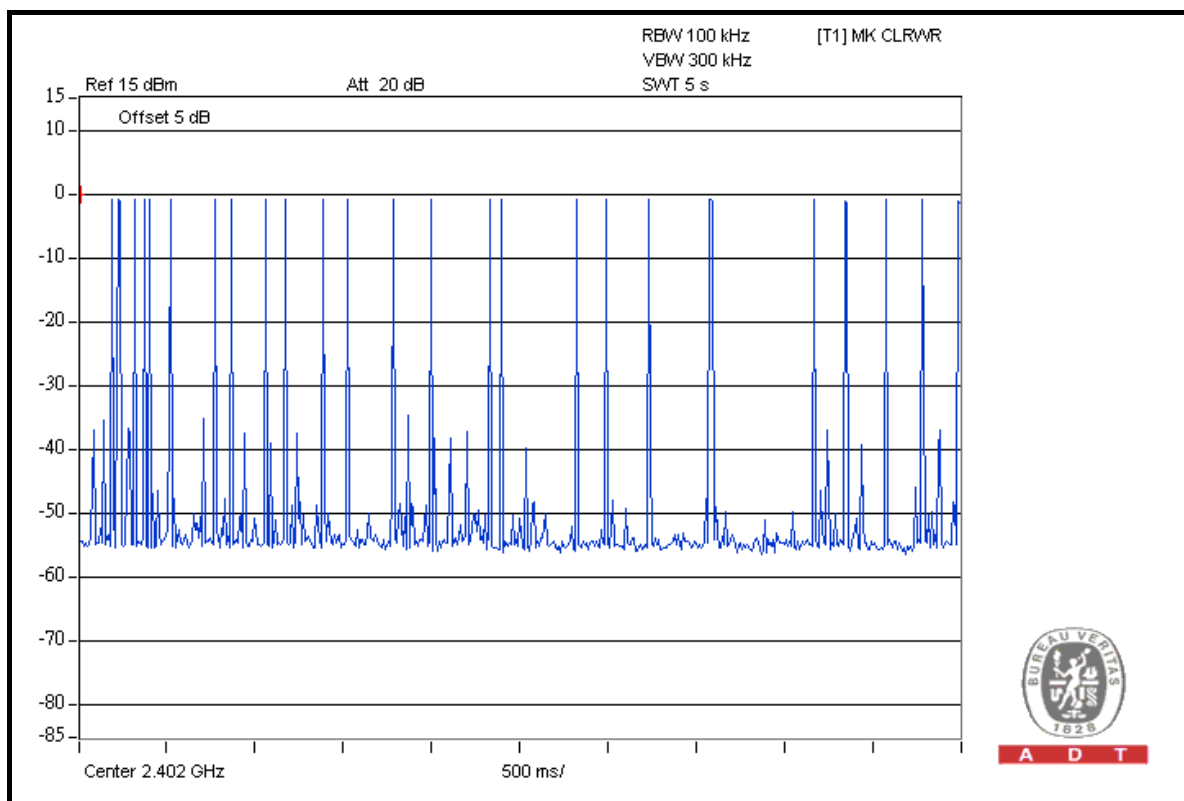

A D T

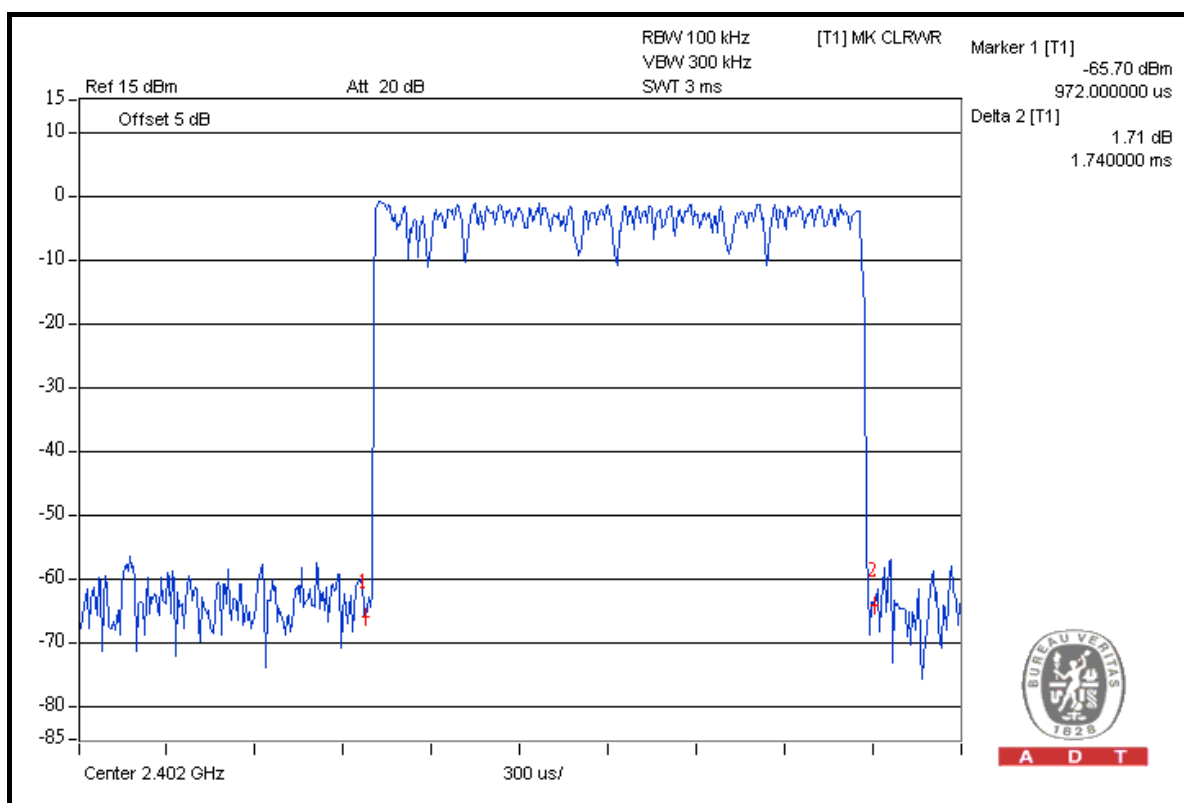

A D T





**8DPSK**

Mode	Number of transmission in a 31.6 (79Hopping*0.4)	Length of transmission time (msec)	Result (msec)	Limit (msec)
DH1	51 (times / 5 sec) * 6.32 = 322.32 times	0.462	148.912	400
DH3	27 (times / 5 sec) * 6.32 = 170.64times	1.698	289.747	400
DH5	16 (times / 5 sec) * 6.32 = 101.12 times	3.04	307.405	400

**NOTE:** Test plots of the transmitting time slot are shown on next 3 pages.



A D T

### DH1

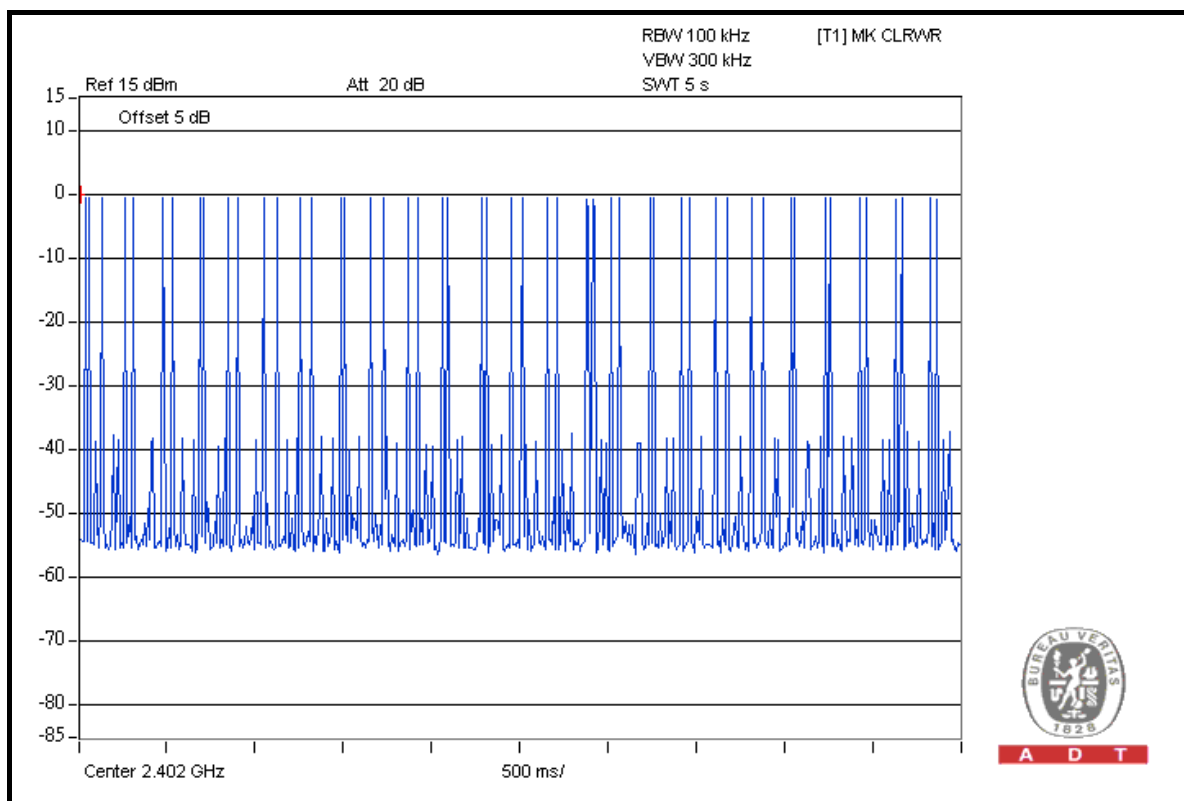

A D T

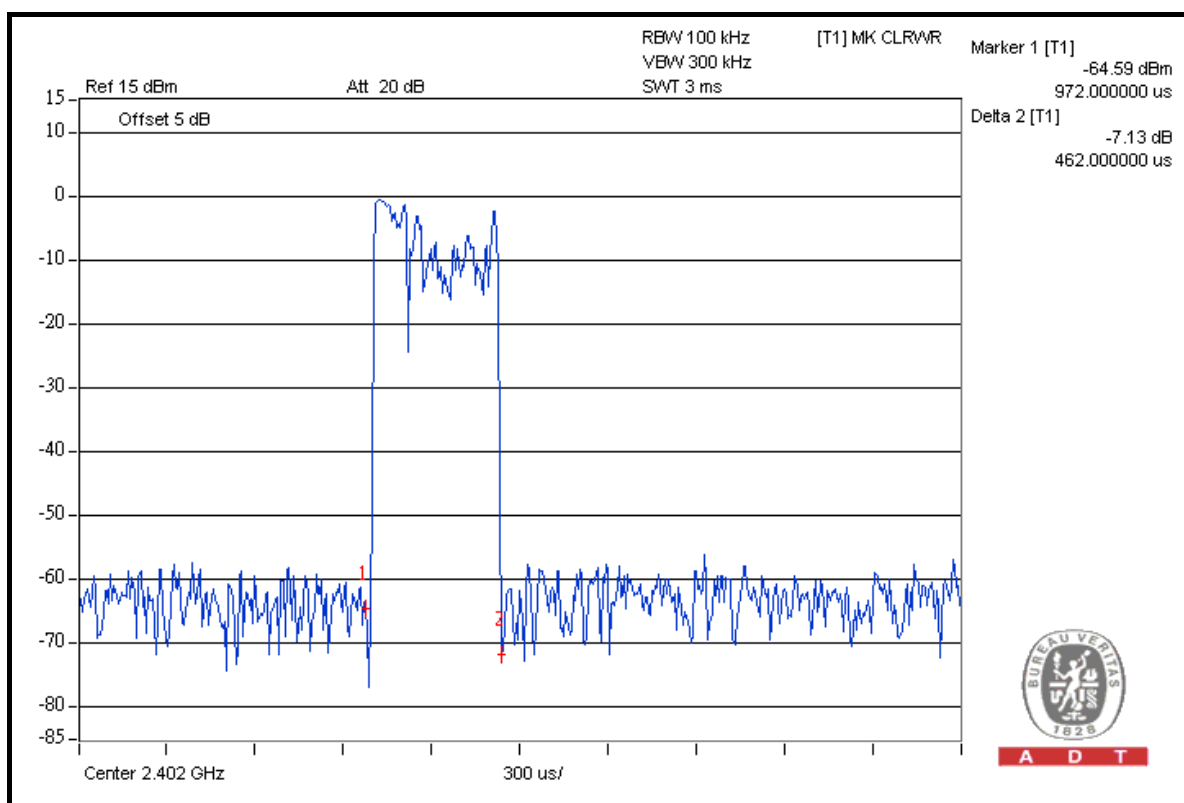

A D T



A D T

### DH3

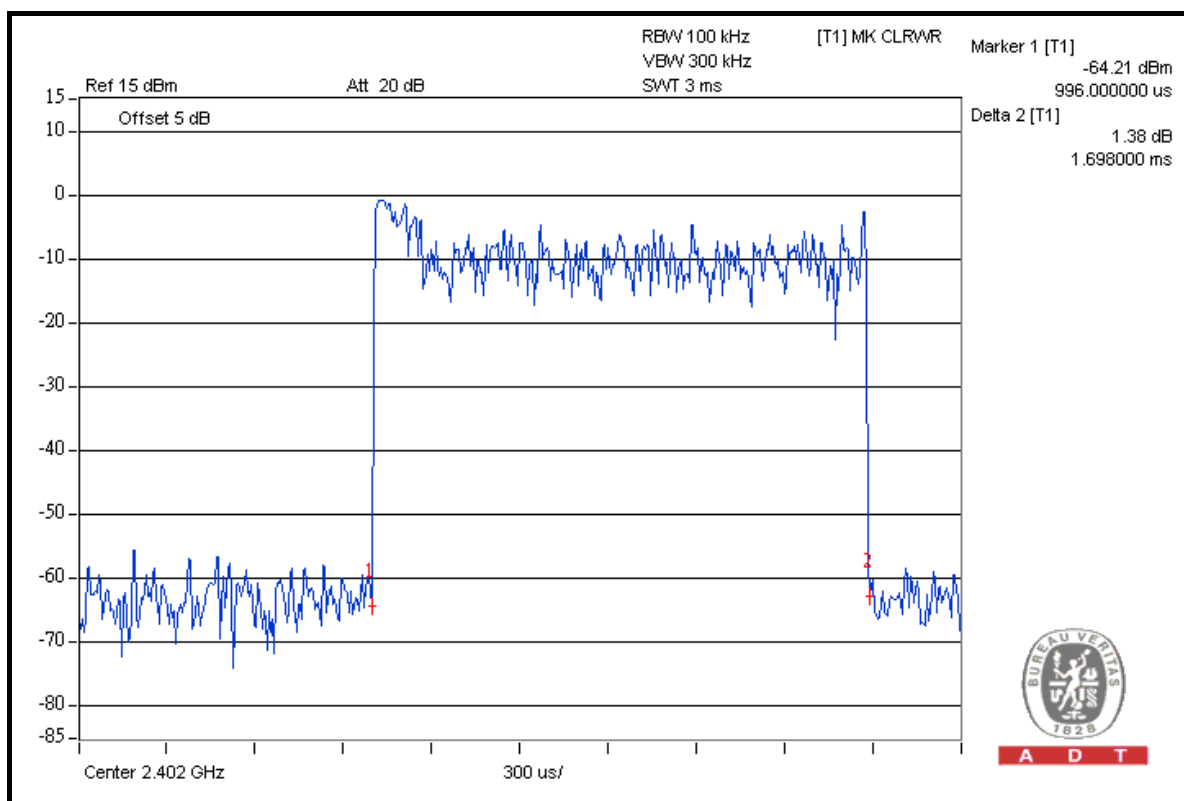
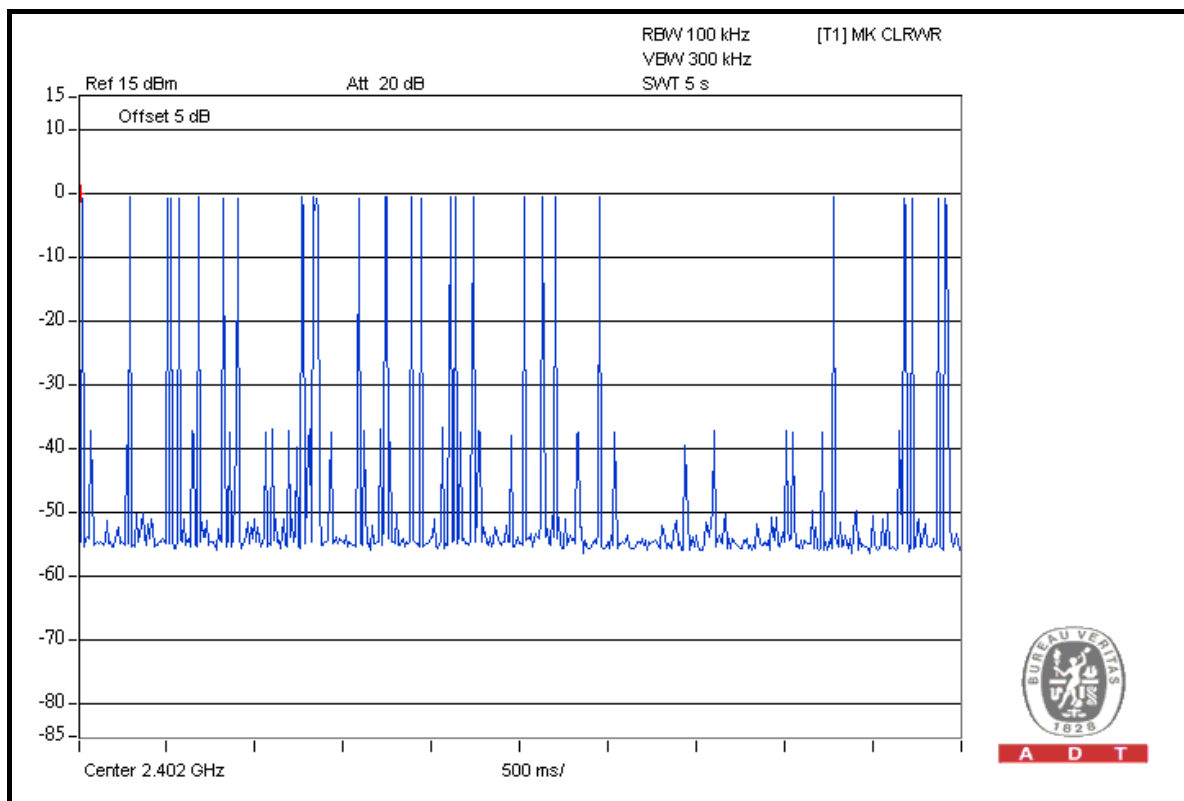



A D T

### DH5

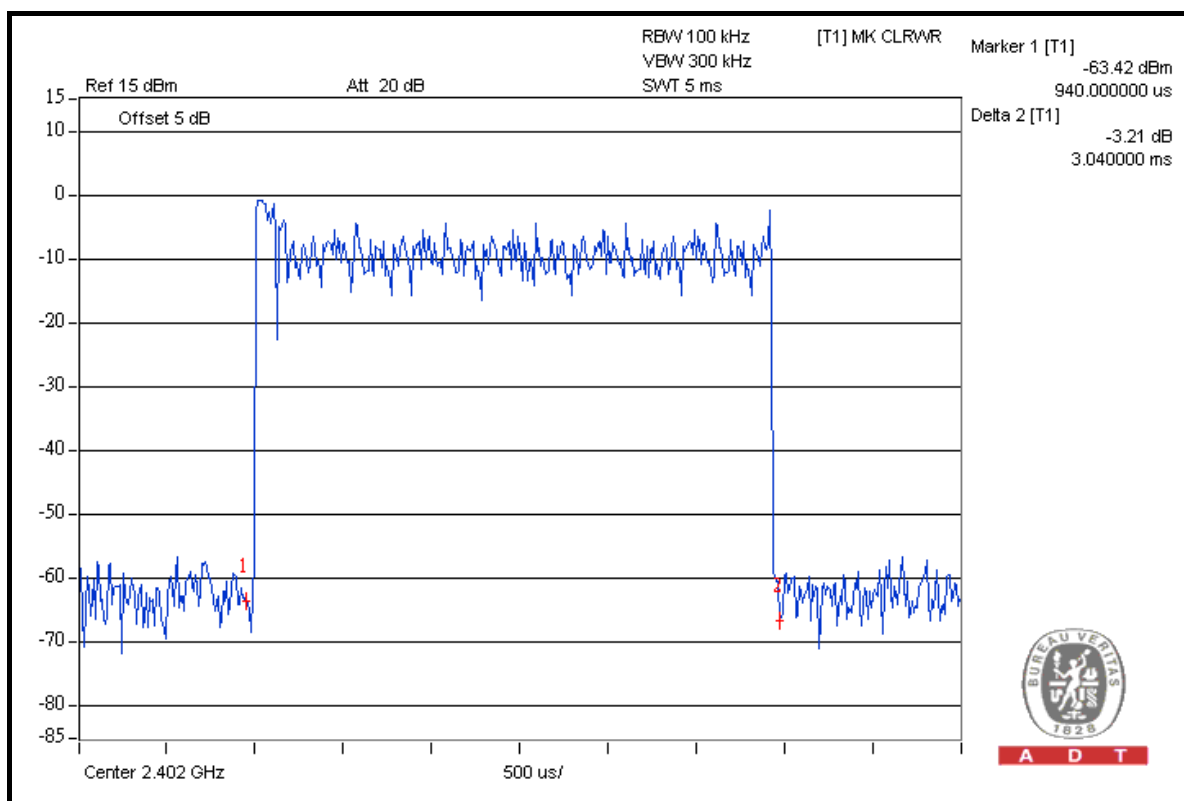
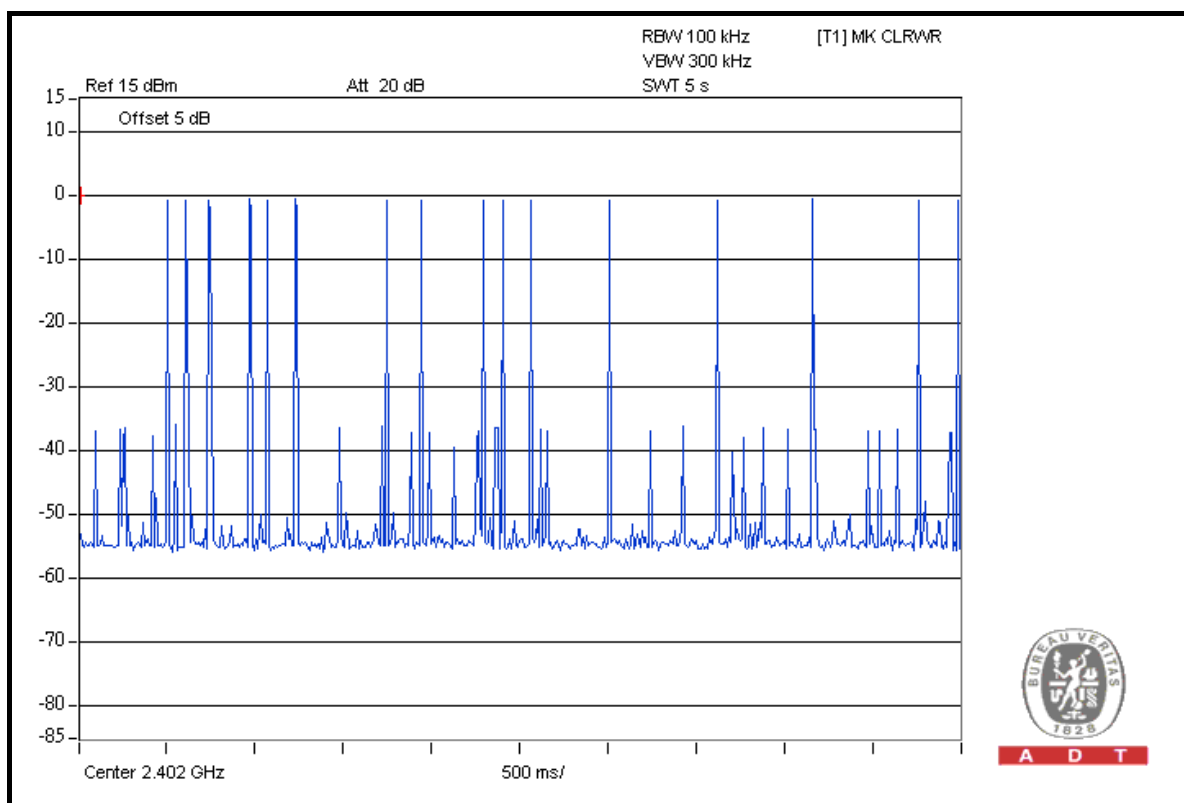

## 4.5 CHANNEL BANDWIDTH

### 4.5.1 LIMITS OF CHANNEL BANDWIDTH

For frequency hopping system operating in the 2400-2483.5MHz, If the 20dB bandwidth of hopping channel is greater than 25kHz, two-thirds 20dB bandwidth of hopping channel shall be a minimum limit for the hopping channel separation.

### 4.5.2 TEST INSTRUMENTS

DESCRIPTION & MANUFACTURER	MODEL NO.	SERIAL NO.	DATE OF CALIBRATION	DUE DATE OF CALIBRATION
SPECTRUM ANALYZER R&S	FSP40	100039	Jan. 11, 2011	Jan. 10, 2012

**NOTE:** The calibration interval of the above test instruments is 12 months and the calibrations are traceable to NML/ROC and NIST/USA.

### 4.5.3 TEST PROCEDURE

- a. Check the calibration of the measuring instrument using either an internal calibrator or a known signal from an external generator.
- b. Turn on the EUT and connect it to measurement instrument. Then set it to any one convenient frequency within its operating range. Set a reference level on the measuring instrument equal to the highest peak value.
- c. Measure the frequency difference of two frequencies that were attenuated 20dB from the reference level. Record the frequency difference as the emission bandwidth.
- d. Repeat above procedures until all frequencies measured were complete.

### 4.5.4 DEVIATION FROM TEST STANDARD

No deviation.

### 4.5.5 TEST SETUP

Same as 4.3.5.

### 4.5.6 EUT OPERATING CONDITION

The software provided by client enabled the EUT to transmit and receive data at lowest, middle and highest channel frequencies individually.

### 4.5.7 TEST RESULTS

#### GFSK

CHANNEL	CHANNEL FREQUENCY (MHz)	20dB BANDWIDTH (MHz)
0	2402	0.943
39	2441	0.943
78	2480	0.945

#### CH 78

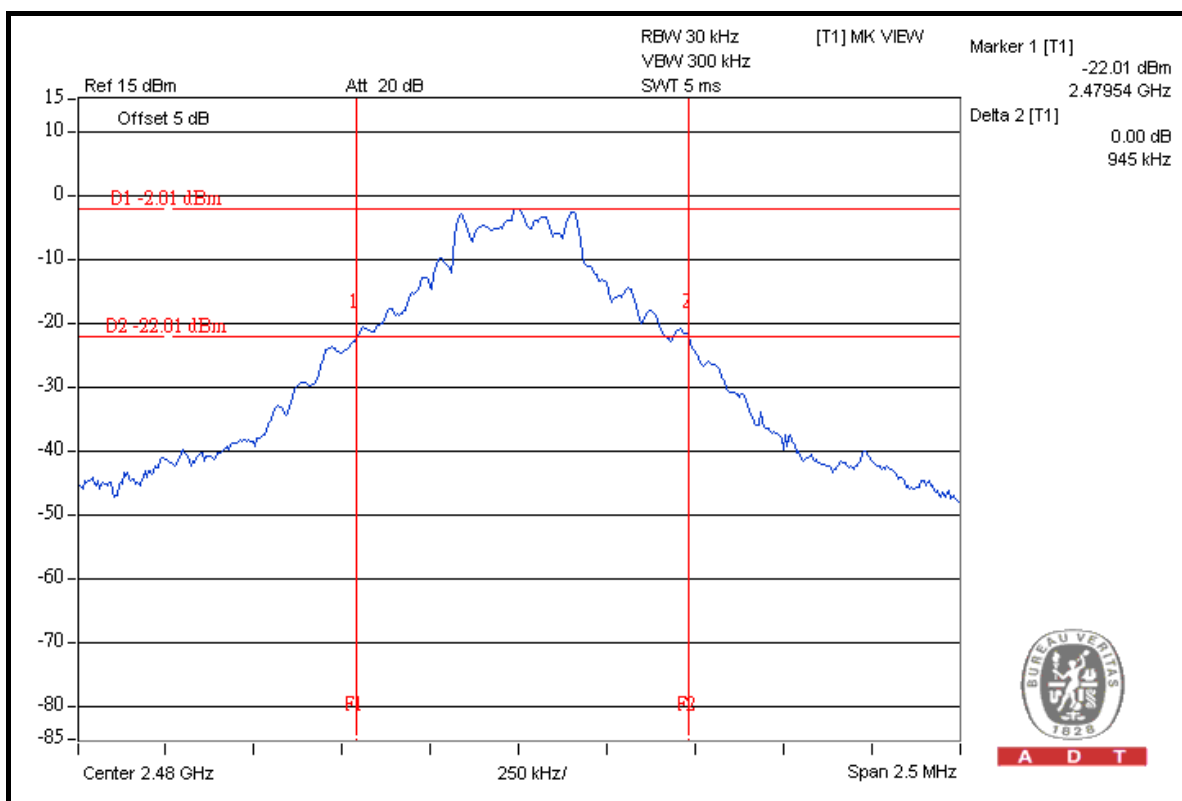

**8DPSK**

CHANNEL	CHANNEL FREQUENCY (MHz)	20dB BANDWIDTH (MHz)
0	2402	1.270
39	2441	1.270
78	2480	1.260

**CH 0**

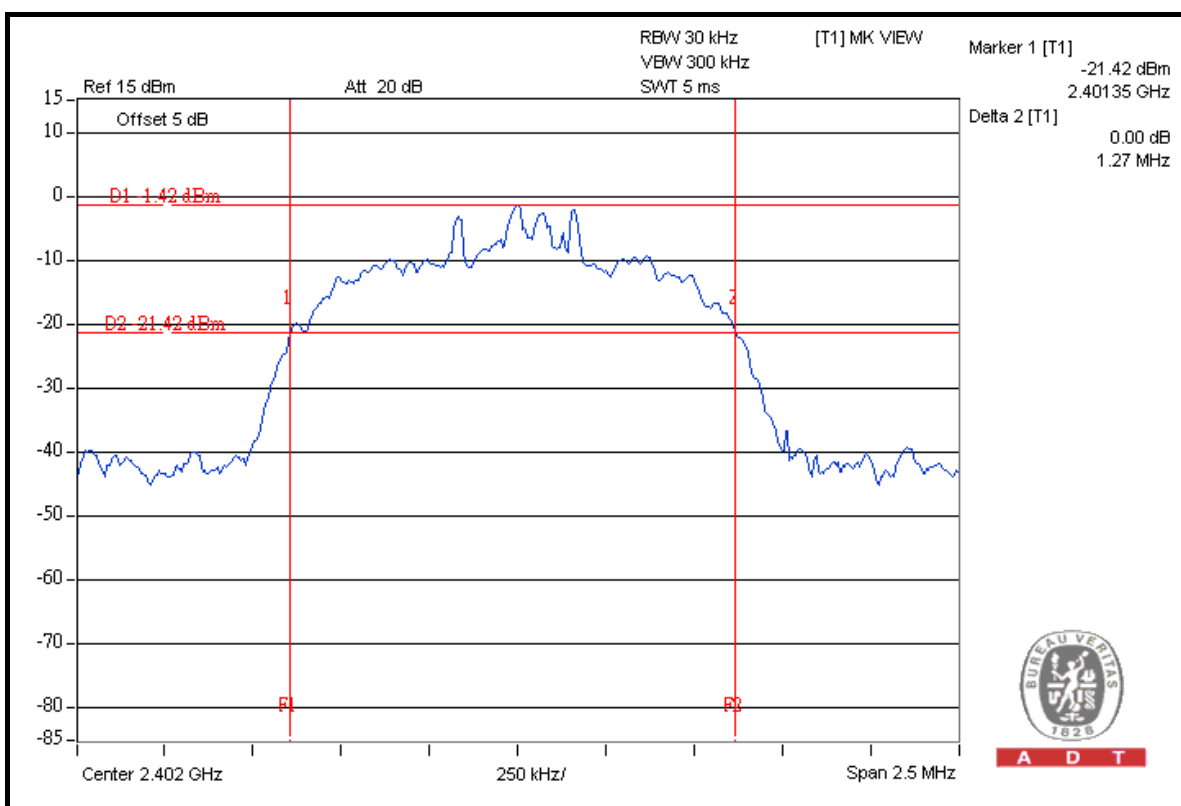



## 4.6 HOPPING CHANNEL SEPARATION

### 4.6.1 LIMIT OF HOPPING CHANNEL SEPARATION

At least 25kHz or two-third of 20dB hopping channel bandwidth (whichever is greater).

### 4.6.2 TEST INSTRUMENTS

DESCRIPTION & MANUFACTURER	MODEL NO.	SERIAL NO.	DATE OF CALIBRATION	DUE DATE OF CALIBRATION
SPECTRUM ANALYZER R&S	FSP40	100039	Jan. 11, 2011	Jan. 10, 2012

**NOTE:** The calibration interval of the above test instruments is 12 months and the calibrations are traceable to NML/ROC and NIST/USA.

### 4.6.3 TEST PROCEDURES

1. Check the calibration of the measuring instrument using either an internal calibrator or a known signal from an external generator.
2. Turn on the EUT and connect it to measurement instrument. Then set it to any one convenient frequency within its operating range.
3. By using the MaxHold function record the separation of two adjacent channels.
4. Measure the frequency difference of these two adjacent channels by SA MARK function. And then plot the result on SA screen.
5. Repeat above procedures until all frequencies measured were complete.

### 4.6.4 DEVIATION FROM TEST STANDARD

No deviation.

### 4.6.5 TEST SETUP

Same as 4.3.5.



**8DPSK**

CHANNEL	FREQUENCY (MHz)	ADJACENT CHANNEL SEPARATION (MHz)	20dB BANDWIDTH (MHz)	MINIMUM LIMIT (MHz)	PASS / FAIL
0	2402	1.010	1.270	0.847	PASS
39	2441	1.010	1.270	0.847	PASS
78	2480	1.000	1.260	0.840	PASS

**NOTE:** The minimum limit is two-third 20dB bandwidth. Test results please refer to next two pages.

**CH 0**

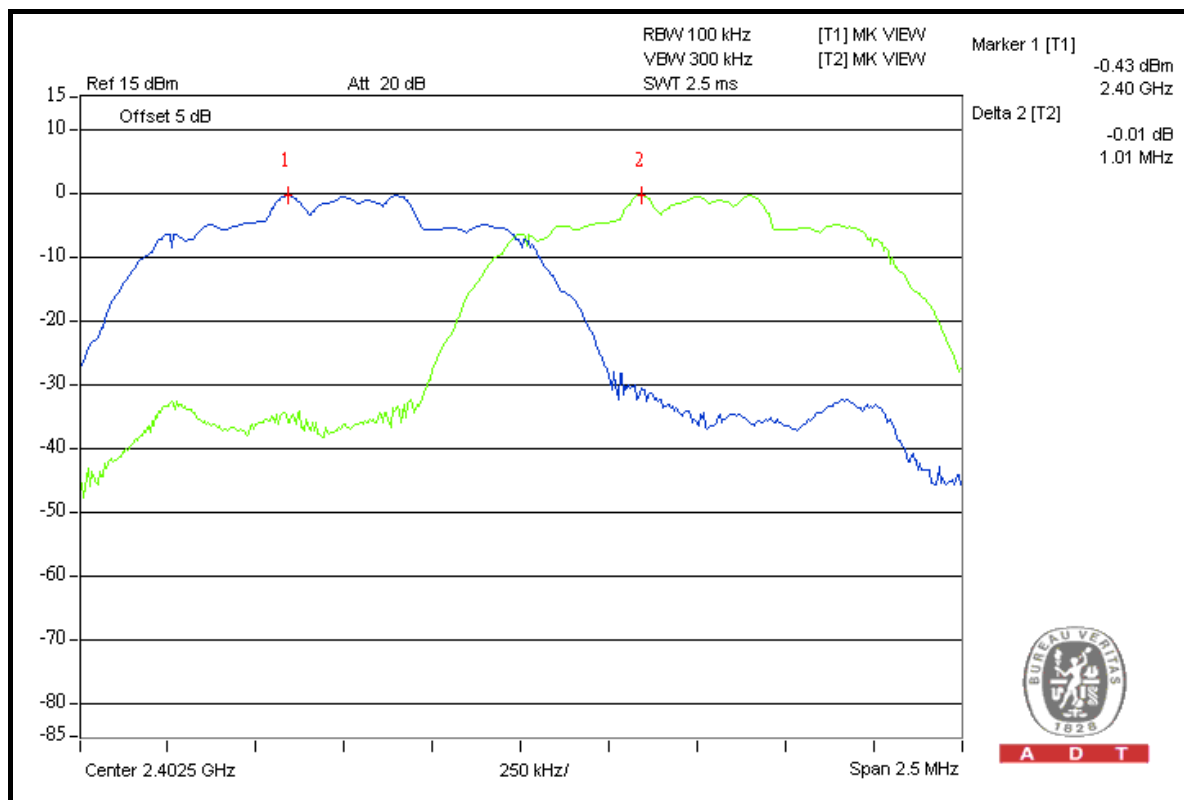

## 4.7 MAXIMUM OUTPUT POWER

### 4.7.1 LIMITS OF MAXIMUM OUTPUT POWER MEASUREMENT

The Maximum Peak Output Power Measurement is 125mW.

### 4.7.2 TEST INSTRUMENTS

DESCRIPTION & MANUFACTURER	MODEL NO.	SERIAL NO.	DATE OF CALIBRATION	DUE DATE OF CALIBRATION
SPECTRUM ANALYZER R&S	FSP40	100039	Jan. 11, 2011	Jan. 10, 2012

**NOTE:** The calibration interval of the above test instruments is 12 months and the calibrations are traceable to NML/ROC and NIST/USA.

### 4.7.3 TEST PROCEDURES

- a. Check the calibration of the measuring instrument using either an internal calibrator or a known signal from an external generator.
- b. Turn on the EUT and connect it to measurement instrument. Then set it to any one convenient frequency within its operating range. Set a reference level on the measuring instrument equal to the highest peak value.
- c. The center frequency of the spectrum analyzer is set to the fundamental frequency and using 3MHz RBW and 10 MHz VBW.
- d. Measure the captured power within the band and recording the plot.
- e. Repeat above procedures until all frequencies required were complete.

### 4.7.4 DEVIATION FROM TEST STANDARD

No deviation.

### 4.7.5 TEST SETUP

Same as 4.3.5.

#### 4.7.6 EUT OPERATING CONDITION

The software provided by client enabled the EUT to transmit and receive data at lowest, middle and highest channel frequencies individually.

#### 4.7.7 TEST RESULTS

##### GFSK

CHANNEL	CHANNEL FREQUENCY (MHz)	POWER OUTPUT (mW)	POWER OUTPUT (dBm)	POWER LIMIT (mW)	PASS/FAIL
0	2402	0.962	-0.17	125	PASS
39	2441	0.942	-0.26	125	PASS
78	2480	0.818	-0.87	125	PASS

##### CH 0

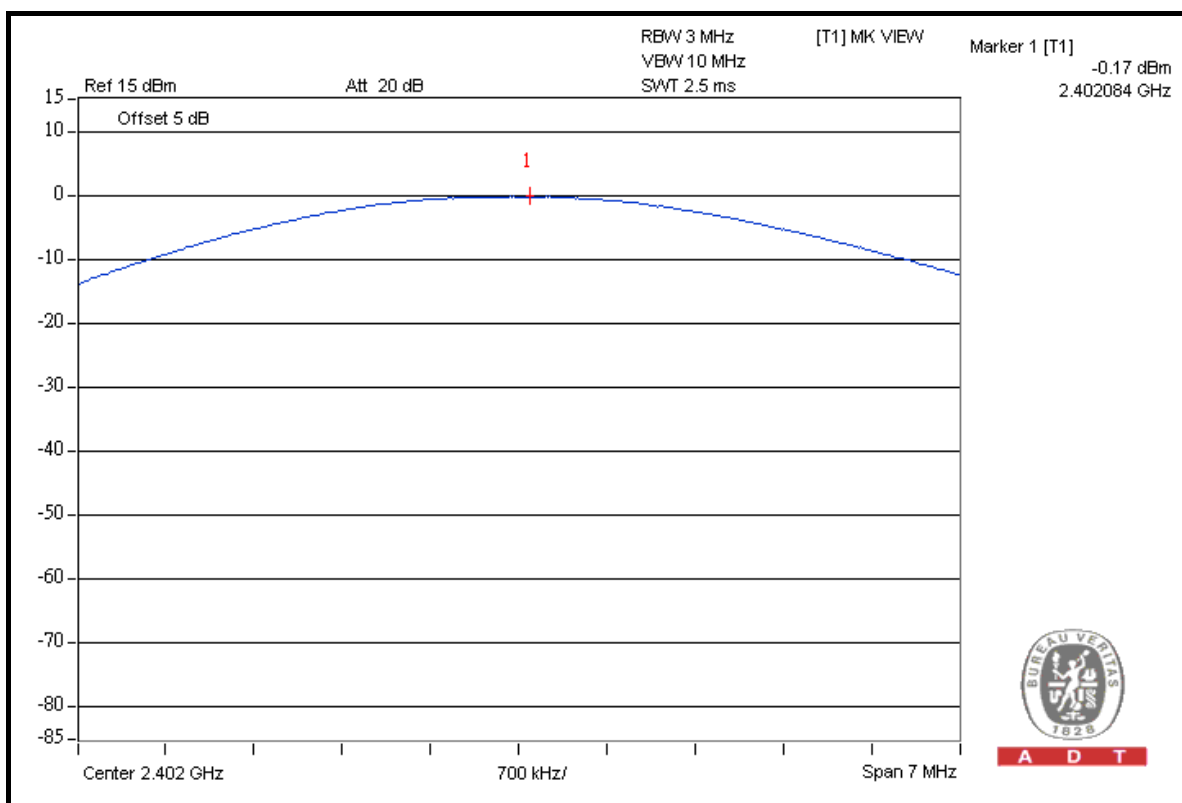



A D T

### 8DPSK

CHANNEL	CHANNEL FREQUENCY (MHz)	POWER OUTPUT (mW)	POWER OUTPUT (dBm)	POWER LIMIT (mW)	PASS/FAIL
0	2402	1.091	0.38	125	PASS
39	2441	1.084	0.35	125	PASS
78	2480	0.948	-0.23	125	PASS

### CH 0

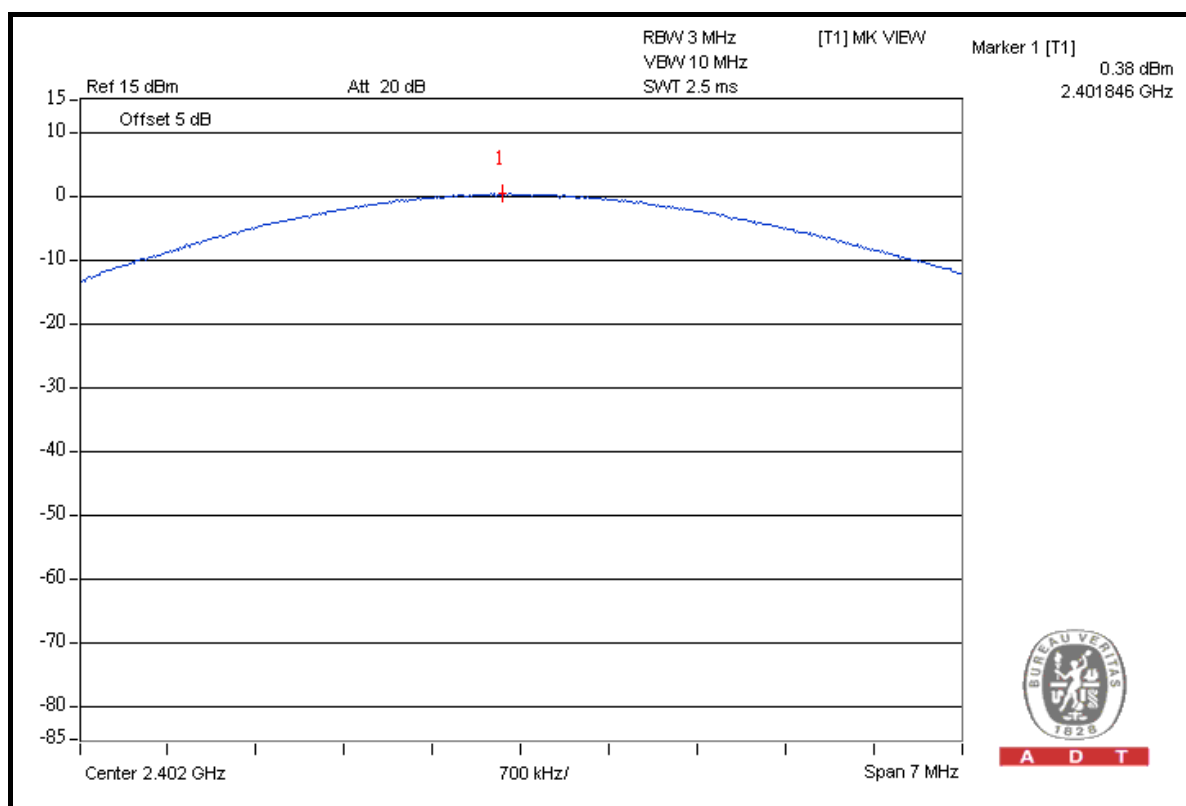

A D T

## 4.8 BAND EDGES MEASUREMENT

### 4.8.1 LIMITS OF BAND EDGES MEASUREMENT

Below  $-20\text{dB}$  of the highest emission level of operating band (in 100KHz RBW).

### 4.8.2 TEST INSTRUMENTS

DESCRIPTION & MANUFACTURER	MODEL NO.	SERIAL NO.	DATE OF CALIBRATION	DUE DATE OF CALIBRATION
SPECTRUM ANALYZER R&S	FSP40	100039	Jan. 11, 2011	Jan. 10, 2012

**NOTE:** The calibration interval of the above test instruments is 12 months and the calibrations are traceable to NML/ROC and NIST/USA.

### 4.8.3 TEST PROCEDURE

The transmitter output was connected to the spectrum analyzer via a low lose cable. Set both RBW and VBW of spectrum analyzer to 100 kHz with suitable frequency span including 100 MHz bandwidth from band edge. The band edges was measured and recorded.

### 4.8.4 DEVIATION FROM TEST STANDARD

No deviation.

### 4.8.5 EUT OPERATING CONDITION

The software provided by client enabled the EUT to transmit and receive data at lowest and highest channel frequencies individually.

#### 4.8.6 TEST RESULTS

The spectrum plots are attached on the following images. D1 line indicates the highest level, D2 line indicates the 20dB offset below D1. It shows compliance with the requirement in part 15.247(d).

#### GFSK

##### RESTRICT BAND (2310 ~ 2390 MHz)

FREQUENCY (MHz)	FUNDAMENTAL EMISSION (dBuV/m)	DELTA (dB)	MAXIMUM FIELD STRENGTH IN RESTRICT BAND (dBuV/m)	LIMIT (dBuV/m)
2402.00 (PK)	94.4	51.63	42.77	74.00
2402.00 (AV)	-	-	12.67	54.00

##### RESTRICT BAND (2483.5 ~ 2500 MHz)

FREQUENCY (MHz)	FUNDAMENTAL EMISSION (dBuV/m)	DELTA (dB)	MAXIMUM FIELD STRENGTH IN RESTRICT BAND (dBuV/m)	LIMIT (dBuV/m)
2480.00 (PK)	91.3	51.74	39.56	74.00
2480.00 (AV)	-	-	9.46	54.00

#### NOTE:

1. Delta = Amplitude between the peak of the fundamental and the peak of the band edge emission. Please check following 2 pages.
2. Maximum field strength in restrict band (PK value) = Fundamental emission (PK value) – Delta.
3. Average value = Peak value + 20 Log (duty cycle) = Peak value – 30.1dB.
4. The DH5 packet was the worse case duty cycle for a transmit dwell time on a channel, based upon Bluetooth theory the transmitter is on 0.625 \* 5 per 296.25 ms per channel. Therefore, the duty cycle correction factor be equal to:  $20\log(3.125/100) = -30.1$  dB.





A D T

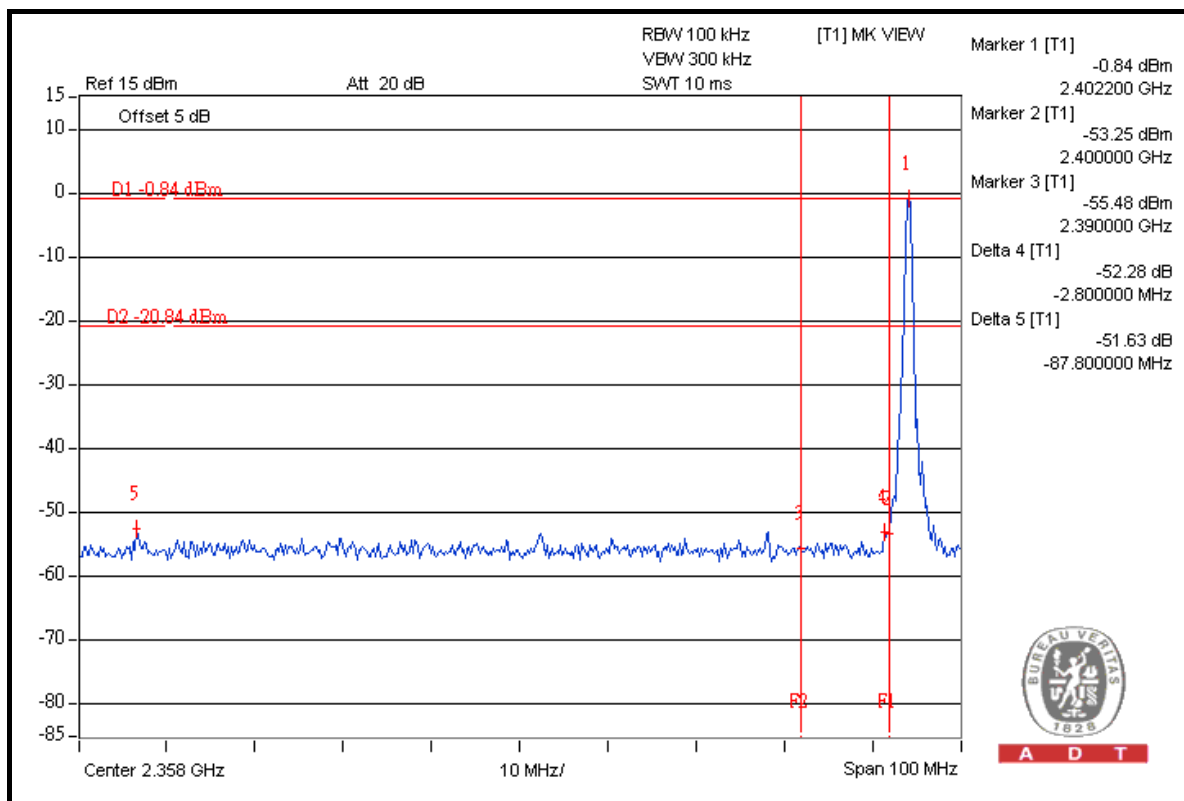

A D T

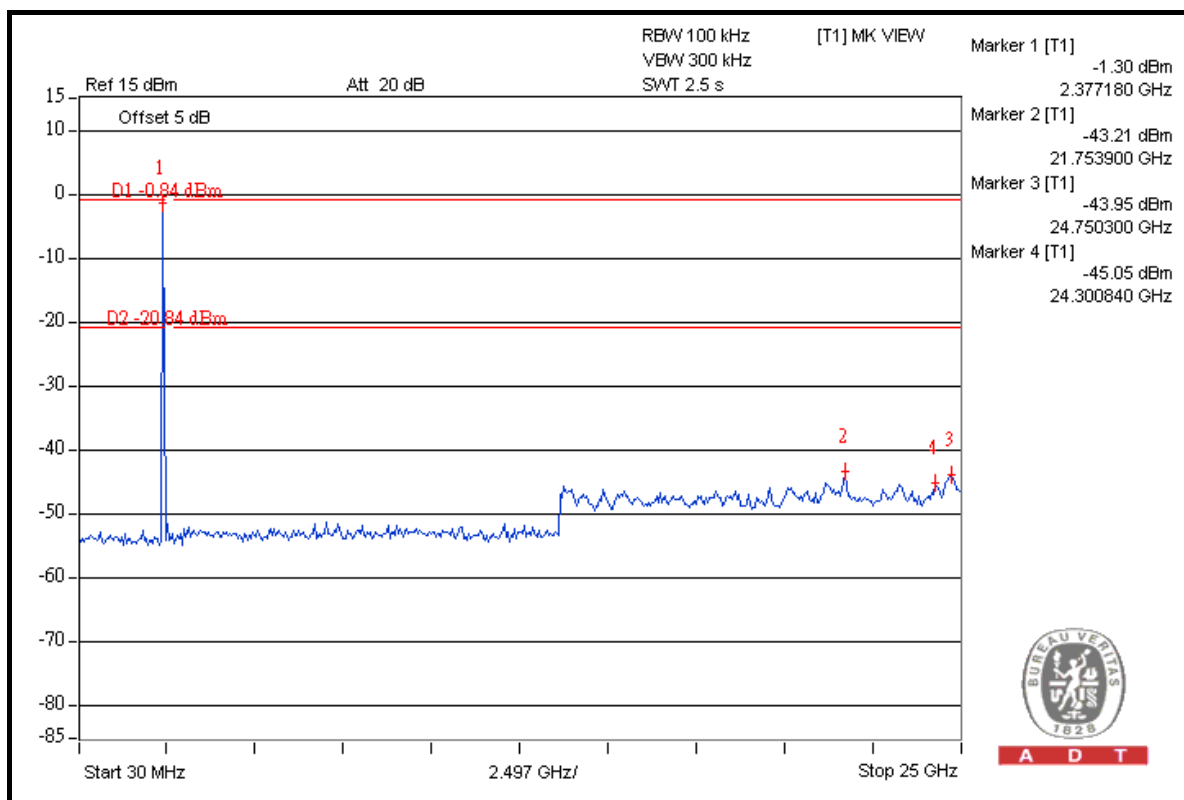

A D T



A D T

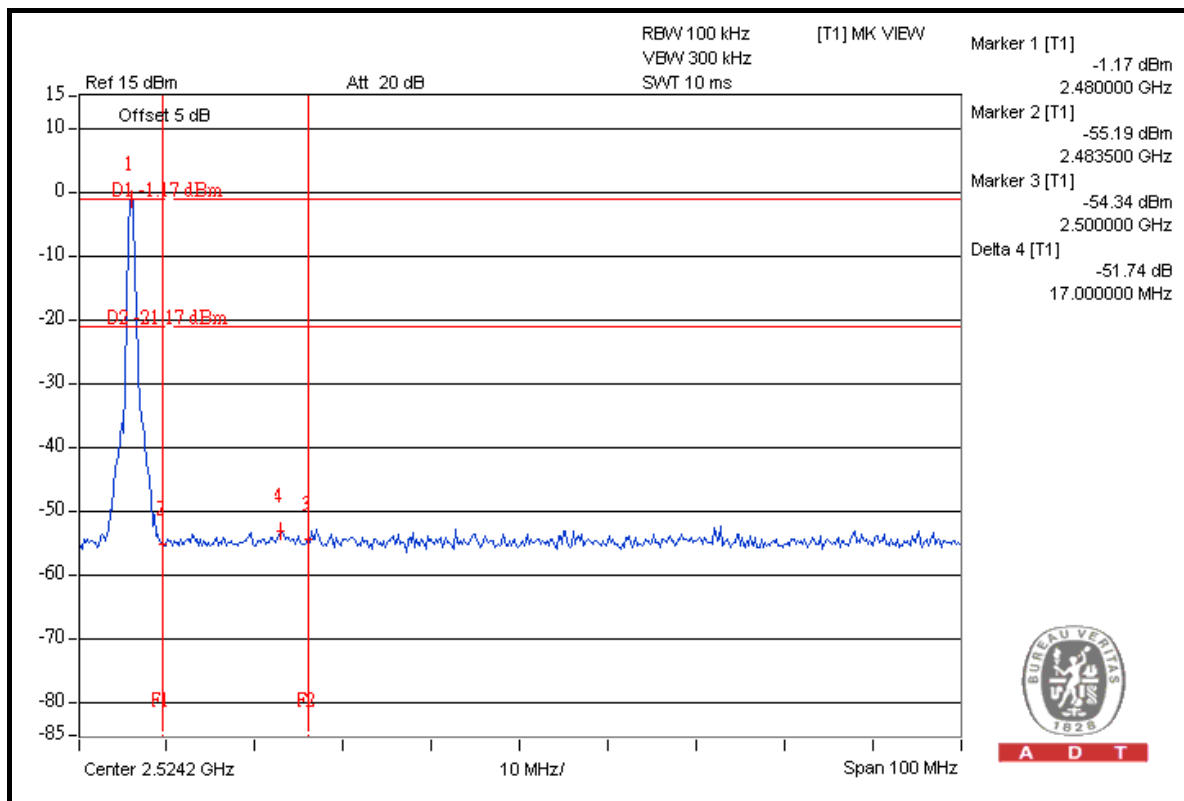

A D T

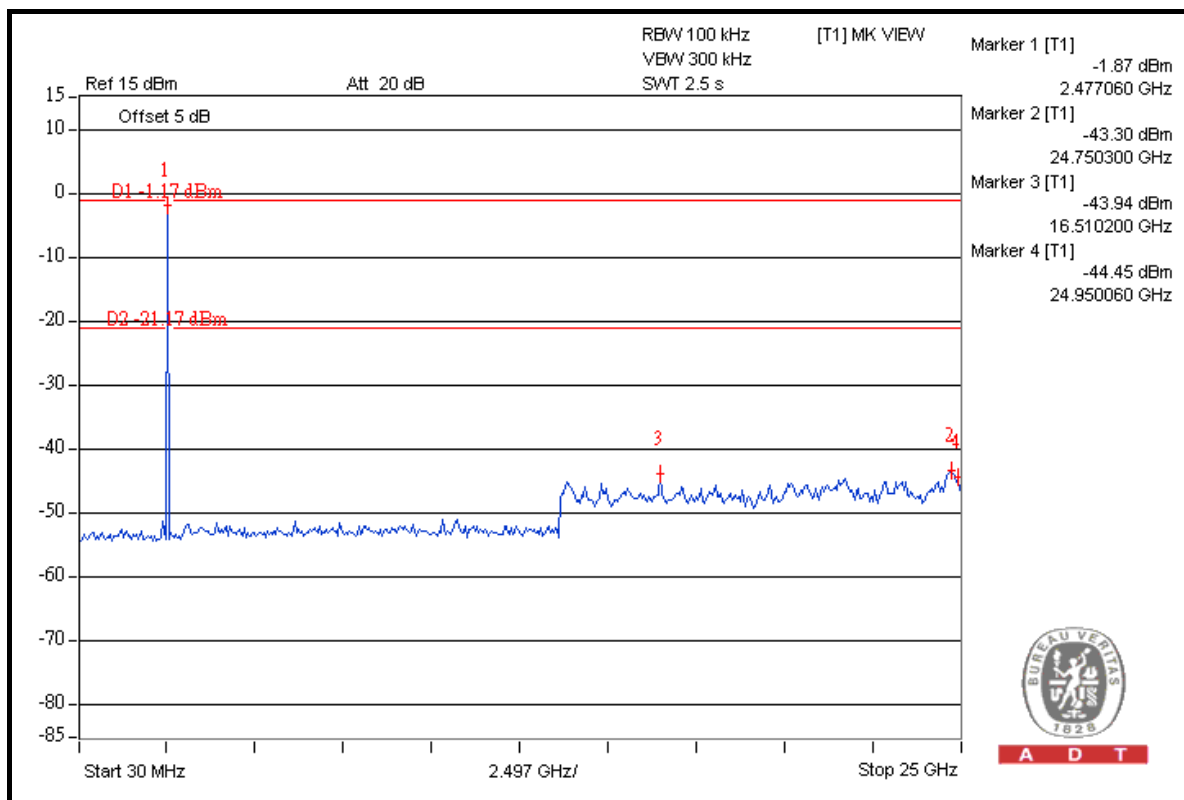

A D T

## 8DPSK

### RESTRICT BAND (2310 ~ 2390 MHz)

FREQUENCY (MHz)	FUNDAMENTAL EMISSION (dBuV/m)	DELTA (dB)	MAXIMUM FIELD STRENGTH IN RESTRICT BAND (dBuV/m)	LIMIT (dBuV/m)
2402.00 (PK)	94.8	51.9	42.9	74.00
2402.00 (AV)	-	-	12.8	54.00

### RESTRICT BAND (2483.5 ~ 2500 MHz)

FREQUENCY (MHz)	FUNDAMENTAL EMISSION (dBuV/m)	DELTA (dB)	MAXIMUM FIELD STRENGTH IN RESTRICT BAND (dBuV/m)	LIMIT (dBuV/m)
2480.00 (PK)	92.9	52.62	40.28	74.00
2480.00 (AV)	-	-	10.18	54.00

#### NOTE:

- Delta = Amplitude between the peak of the fundamental and the peak of the band edge emission. Please check following 2 pages.
- Maximum field strength in restrict band (PK value) = Fundamental emission (PK value) – Delta.
- Average value = Peak value + 20 Log (duty cycle) = Peak value – 30.1dB.
- The DH5 packet was the worse case duty cycle for a transmit dwell time on a channel, based upon Bluetooth theory the transmitter is on 0.625 \* 5 per 296.25 ms per channel. Therefore, the duty cycle correction factor be equal to:  $20\log(3.125/100) = -30.1$  dB.



A D T

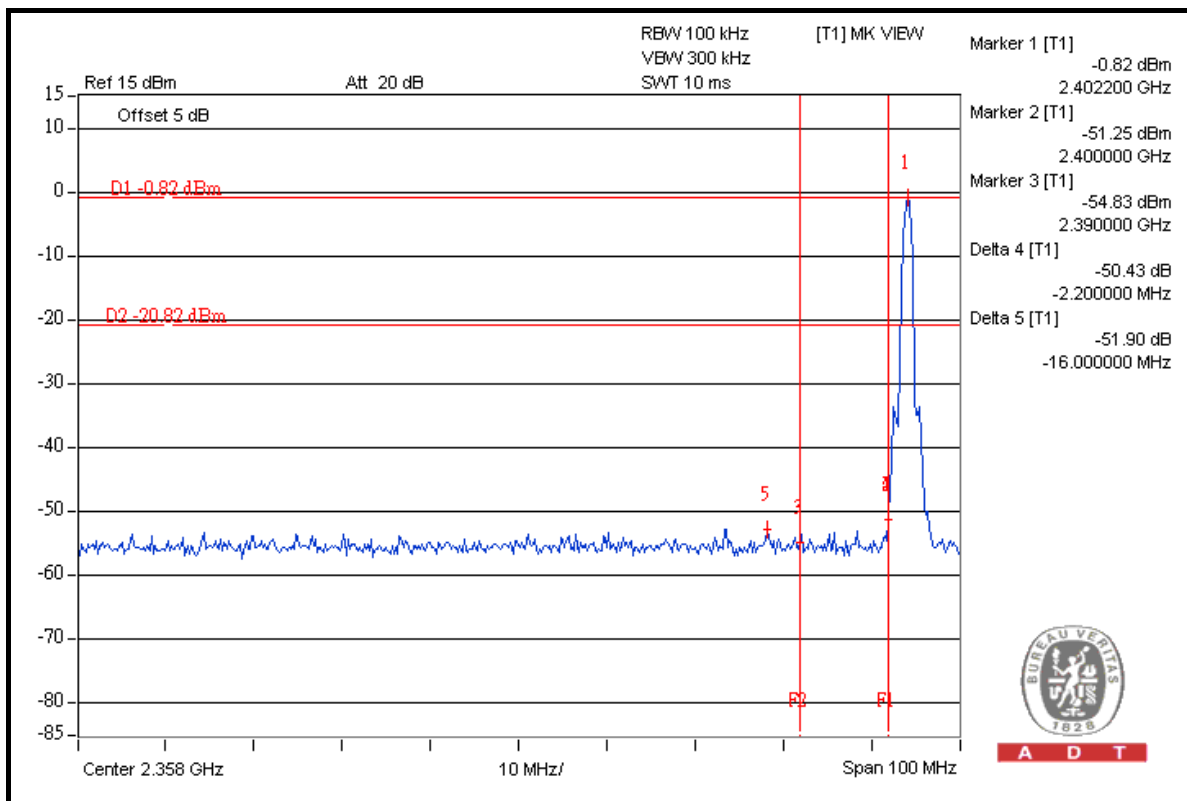

A D T

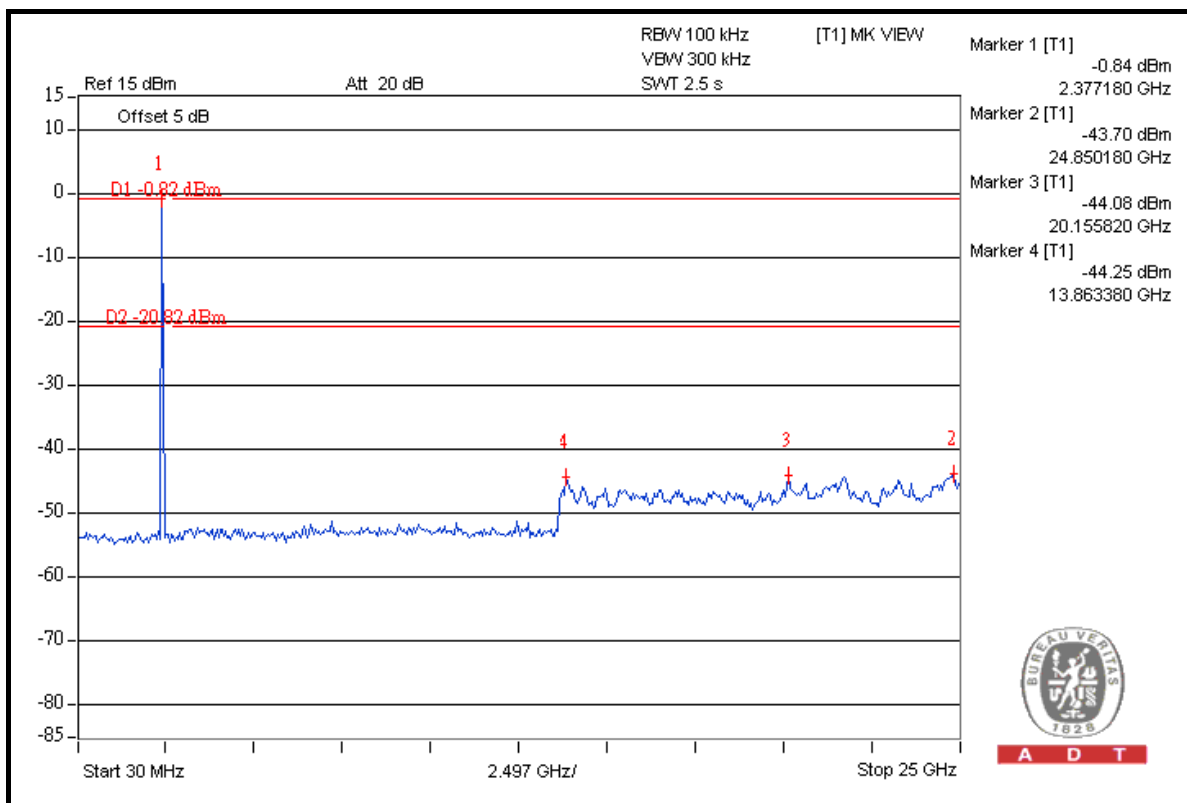

A D T



A D T

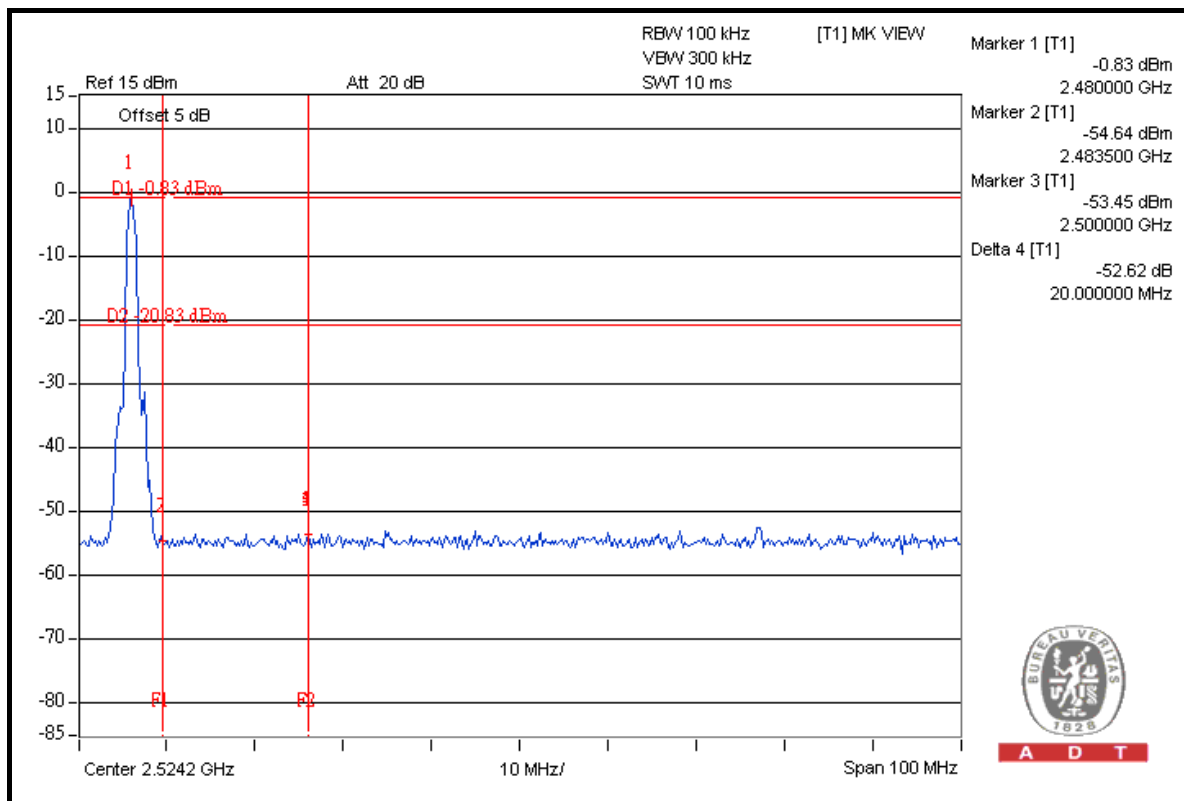

A D T

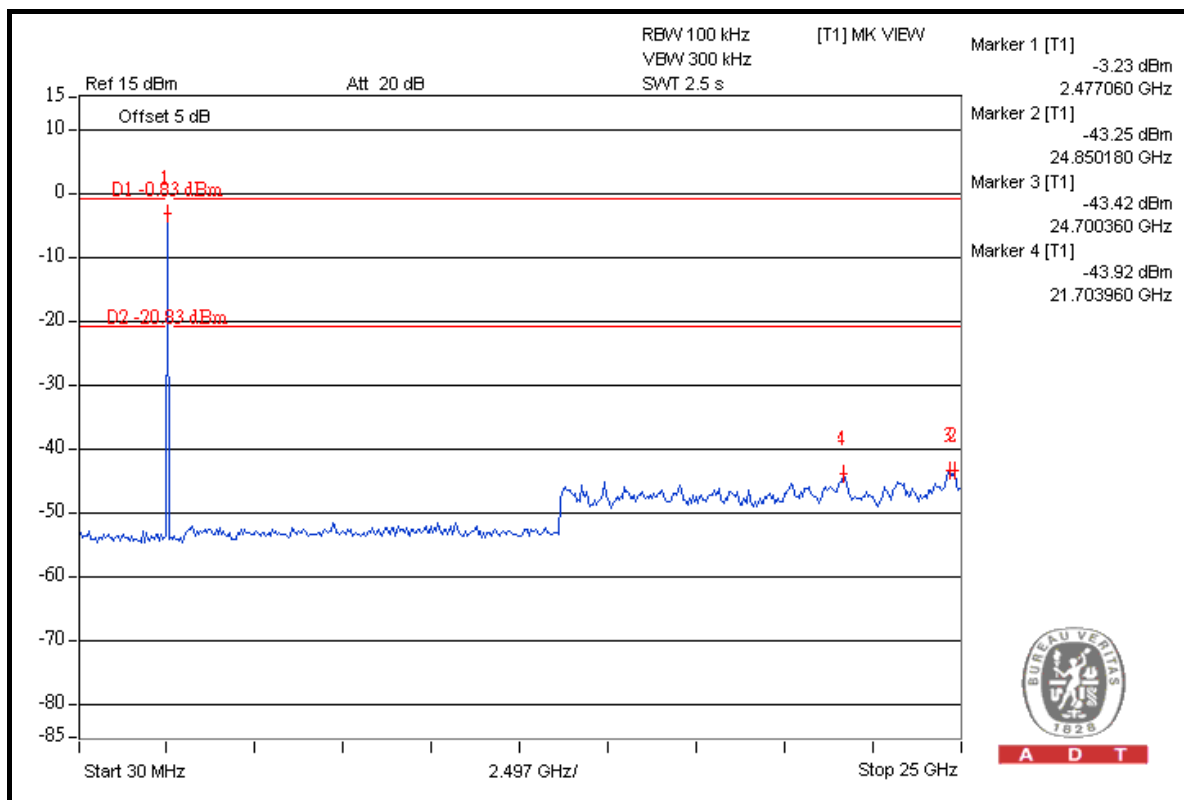

A D T

## 5. PHOTOGRAPHS OF THE TEST CONFIGURATION

Please refer to the attached file (Test Setup Photo).

## 6. INFORMATION ON THE TESTING LABORATORIES

We, Bureau Veritas Consumer Products Services (H.K.) Ltd., Taoyuan Branch, were founded in 1988 to provide our best service in EMC, Radio, Telecom and Safety consultation. Our laboratories are accredited and approved according to ISO/IEC 17025.

Copies of accreditation and authorization certificates of our laboratories obtained from approval agencies can be downloaded from our web site: [www.adt.com.tw/index.5.phtml](http://www.adt.com.tw/index.5.phtml). If you have any comments, please feel free to contact us at the following:

**Linko EMC/RF Lab**

Tel: 886-2-26052180

Fax: 886-2-26051924

**Hsin Chu EMC/RF Lab**

Tel: 886-3-5935343

Fax: 886-3-5935342

**Hwa Ya EMC/RF/Safety/Telecom Lab**

Tel: 886-3-3183232

Fax: 886-3-3185050

**Email:** [service.adt@tw.bureauveritas.com](mailto:service.adt@tw.bureauveritas.com)

**Web Site:** [www.adt.com.tw](http://www.adt.com.tw)

The address and road map of all our labs can be found in our web site also.

## **7. APPENDIX A - MODIFICATIONS RECORDERS FOR ENGINEERING CHANGES TO THE EUT BY THE LAB**

No any modifications are made to the EUT by the lab during the test.

--- END ---