

FCC Test Report

Report No.: RF170406C35-7

FCC ID: B32V400M4G

Test Model: V400m Plus 4G

Received Date: Apr. 06, 2017

Test Date: Apr. 26, 2017 ~ Apr. 29, 2017

Issued Date: May 17, 2017

Applicant: Verifone, Inc.

Address: 1400 West Stanford Ranch Road Suite 200 Rocklin CA 95765 USA

Issued By: Bureau Veritas Consumer Products Services (H.K.) Ltd., Taoyuan Branch

Lab Address: No. 47-2, 14th Ling, Chia Pau Vil., Lin Kou Dist., New Taipei City, Taiwan
(R.O.C)

Test Location (1): No. 19, Hwa Ya 2nd Rd, Wen Hwa Tsuen, Kwei Shan Hsiang, Taoyuan
Hsien 333, Taiwan, R.O.C.



This report is for your exclusive use. Any copying or replication of this report to or for any other person or entity, or use of our name or trademark, is permitted only with our prior written permission. This report sets forth our findings solely with respect to the test samples identified herein. The results set forth in this report are not indicative or representative of the quality or characteristics of the lot from which a test sample was taken or any similar or identical product unless specifically and expressly noted. Our report includes all of the tests requested by you and the results thereof based upon the information that you provided to us. You have 60 days from date of issuance of this report to notify us of any material error or omission caused by our negligence, provided, however, that such notice shall be in writing and shall specifically address the issue you wish to raise. A failure to raise such issue within the prescribed time shall constitute your unqualified acceptance of the completeness of this report, the tests conducted and the correctness of the report contents. Unless specific mention, the uncertainty of measurement has been explicitly taken into account to declare the compliance or non-compliance to the specification. The report must not be used by the client to claim product certification, approval, or endorsement by TAF or any government agencies.

Table of Contents

Release Control Record	4
1 Certificate of Conformity	5
2 Summary of Test Results.....	6
2.1 Measurement Uncertainty.....	6
2.2 Modification Record	6
3 General Information	7
3.1 General Description of EUT	7
3.2 Description of Test Modes.....	9
3.2.1 Test Mode Applicability and Tested Channel Detail.....	11
3.3 Duty Cycle of Test Signal	13
3.4 Description of Support Units	14
3.4.1 Configuration of System under Test	14
3.5 General Description of Applied Standards.....	14
4 Test Types and Results	15
4.1 Radiated Emission and Bandedge Measurement	15
4.1.1 Limits of Radiated Emission and Bandedge Measurement	15
4.1.2 Limits of Unwanted Emission Out of the Restricted Bands	16
4.1.3 Test Instruments	17
4.1.4 Test Procedures.....	18
4.1.5 Deviation from Test Standard	18
4.1.6 Test Set Up	19
4.1.7 EUT Operating Conditions.....	20
4.1.8 Test Results	21
4.2 Conducted Emission Measurement.....	63
4.2.1 Limits of Conducted Emission Measurement	63
4.2.2 Test Instruments	63
4.2.3 Test Procedures.....	64
4.2.4 Deviation from Test Standard	64
4.2.5 Test Setup.....	64
4.2.6 EUT Operating Conditions.....	64
4.2.7 Test Results	65
4.3 Transmit Power Measurement.....	67
4.3.1 Limits of Transmit Power Measurement	67
4.3.2 Test Setup.....	67
4.3.3 Test Instruments	68
4.3.4 Test Procedure	68
4.3.5 Deviation from Test Standard	68
4.3.6 EUT Operating Conditions.....	68
4.3.7 Test Result	69
4.4 Peak Power Spectral Density Measurement	74
4.4.1 Limits of Peak Power Spectral Density Measurement	74
4.4.2 Test Setup.....	74
4.4.3 Test Instruments	74
4.4.4 Test Procedures.....	74
4.4.5 Deviation from Test Standard	75
4.4.6 EUT Operating Conditions.....	75
4.4.7 Test Results	76
4.5 Frequency Stability	81
4.5.1 Limit of Frequency Stability Measurement	81
4.5.2 Test Setup.....	81
4.5.3 Test Instruments	81
4.5.4 Test Procedure	81
4.5.5 Deviation from Test Standard	81

4.5.6 EUT Operating Condition	81
4.5.7 Test Results	82
4.6 6 dB Bandwidth Measurement.....	83
4.6.1 Limits of 6 dB Bandwidth Measurement.....	83
4.6.2 Test Setup.....	83
4.6.3 Test Instruments	83
4.6.4 Test Procedure	83
4.6.5 Deviation from Test Standard	83
4.6.6 EUT Operating Condition	83
4.6.7 Test Results	84
5 Pictures of Test Arrangements.....	86
Annex A- Radiated Out of Band Emisison (OOBE) Measurement (For U-NII-3 band).....	87
Appendix – Information on the Testing Laboratories	90

Release Control Record

Issue No.	Description	Date Issued
RF170406C35-7	Original Release	May 17, 2017

1 Certificate of Conformity

Product: Point of Sale Terminal

Brand: Verifone

Test Model: V400m Plus 4G

Sample Status: Identical Prototype

Applicant: Verifone, Inc.

Test Date: Apr. 26, 2017 ~ Apr. 29, 2017

Standards: 47 CFR FCC Part 15, Subpart E (Section 15.407)
ANSI C63.10:2013

The above equipment has been tested by **Bureau Veritas Consumer Products Services (H.K.) Ltd., Taoyuan Branch**, and found compliance with the requirement of the above standards. The test record, data evaluation & Equipment Under Test (EUT) configurations represented herein are true and accurate accounts of the measurements of the sample's EMC characteristics under the conditions specified in this report.

Prepared by :



Date:

May 17, 2017

Ivonne Wu / Supervisor

Approved by :



Date:

May 17, 2017

David Huang / Project Engineer

2 Summary of Test Results

47 CFR FCC Part 15, Subpart E (Section 15.407)			
FCC Clause	Test Item	Result	Remarks
15.407(b)(6)	AC Power Conducted Emissions	Pass	Meet the requirement of limit. Minimum passing margin is -14.21 dB at 0.56418 MHz.
15.407(b) (1/2/3/4(i/ii)/6)	Radiated Emissions & Band Edge Measurement	Pass	Meet the requirement of limit. Minimum passing margin is -4.77 dB at 5150 MHz.
15.407(a)(1/2/3)	Max Average Transmit Power	Pass	Meet the requirement of limit.
15.407(a)(1/2/3)	Peak Power Spectral Density	Pass	Meet the requirement of limit.
15.407(e)	6 dB Bandwidth	Pass	Meet the requirement of limit. (U-NII-3 Band only)
15.407(g)	Frequency Stability	Pass	Meet the requirement of limit.
15.203	Antenna Requirement	Pass	No antenna connector is used.

*For U-NII-3 band compliance with rule part 15.407(b)(4)(i), the OOB test plots were recorded in Annex A.

2.1 Measurement Uncertainty

Where relevant, the following measurement uncertainty levels have been estimated for tests performed on the EUT as specified in CISPR 16-4-2:

Measurement	Frequency	Expanded Uncertainty (k=2) (±)
Conducted Emissions at mains ports	150 kHz ~ 30 MHz	2.44 dB
Radiated Emissions up to 1 GHz	30 MHz ~ 200 MHz	2.93 dB
	200 MHz ~ 1000 MHz	2.95 dB
Radiated Emissions above 1 GHz	1 GHz ~ 18 GHz	2.26 dB
	18 GHz ~ 40 GHz	1.94 dB

2.2 Modification Record

There were no modifications required for compliance.

3 General Information

3.1 General Description of EUT

Product	Point of Sale Terminal
Brand	Verifone
Test Model	V400m Plus 4G
Status of EUT	Identical Prototype
Power Supply Rating	5.0 Vdc (adapter) 3.85 Vdc (Li-ion battery)
Modulation Type	256QAM, 64QAM, 16QAM, QPSK, BPSK
Modulation Technology	OFDM
Transfer Rate	802.11a: 54.0/ 48.0/ 36.0/ 24.0/ 18.0/ 12.0/ 9.0/ 6.0 Mbps 802.11n: up to MCS7 802.11ac: up to V9
Operating Frequency	5180 ~ 5240 MHz, 5260 ~ 5320 MHz, 5500 ~ 5700 MHz, 5745 ~ 5825 MHz
Number of Channel	5180 ~ 5240 MHz: 4 for 802.11a, 802.11n (HT20) 2 for 802.11n (HT40) 1 for 802.11ac (VHT80) 5260 ~ 5320 MHz: 4 for 802.11a, 802.11n (HT20) 2 for 802.11n (HT40) 1 for 802.11ac (VHT80) 5500 ~ 5700 MHz: 11 for 802.11a, 802.11n (HT20) 5 for 802.11n (HT40) 2 for 802.11ac (VHT80) 5745 ~ 5825 MHz: 5 for 802.11a, 802.11n (HT20) 2 for 802.11n (HT40) 1 for 802.11ac (VHT80)
Output Power	18.493 mW for 5180 ~ 5240 MHz 14.859 mW for 5260 ~ 5320 MHz 14.723 mW for 5500 ~ 5700 MHz 16.827 mW for 5745 ~ 5825 MHz
Antenna Type	PCB antenna with 3.15 dBi gain (5180 ~ 5240 MHz) PCB antenna with 2.95 dBi gain (5260 ~ 5320 MHz) PCB antenna with 2.87 dBi gain (5500 ~ 5700 MHz) PCB antenna with 3.13 dBi gain (5745 ~ 5825 MHz)
Antenna Connector	N/A
Accessory Device	Refer to Note as below
Data Cable Supplied	Refer to Note as below

Note:

1. The EUT provides one transmitter and receiver.

Modulation Mode	Tx Function
802.11a	1TX
802.11n (HT20)	1TX
802.11n (HT40)	1TX
802.11ac (HT20)	1TX
802.11ac (HT40)	1TX
802.11ac (VHT80)	1TX

* The modulation and bandwidth are similar for 802.11n mode for HT20 / HT40 and 802.11ac mode for HT20 / HT40, therefore investigated worst case to representative mode in test report. (Final test mode refer section 3.2.1)

2. The EUT contains following accessory devices.

Product	Brand	Model	Description
Adapter 1	Verifone	AM11A-050A	I/P: 100-240 Vac, 50/60 Hz, 500 mA O/P: 5 Vdc, 2.2 A 1.75m non-shielded cable w/o core Manufacturer: Pihong
Adapter 2	Verifone	VF0402	I/P: 100-240 Vac, 50/60 Hz, 500 mA O/P: 5 Vdc, 2.2 A 1.75m non-shielded cable w/o core Manufacturer: Salcomp
Battery	Verifone	BPK475-001	3.85 Vdc, 2890 mAh

3. The above EUT information is declared by manufacturer and for more detailed features description, please refer to the manufacturer's specifications or user's manual.

3.2 Description of Test Modes

For 5180 ~ 5240 MHz

4 channels are provided for 802.11a, 802.11n (HT20):

Channel	Frequency (MHz)	Channel	Frequency (MHz)
36	5180	44	5220
40	5200	48	5240

2 channels are provided for 802.11n (HT40):

Channel	Frequency (MHz)	Channel	Frequency (MHz)
38	5190	46	5230

1 channel is provided for 802.11ac (VHT80):

Channel	Frequency (MHz)
42	5210

For 5260 ~ 5320 MHz

4 channels are provided for 802.11a, 802.11n (HT20):

Channel	Frequency (MHz)	Channel	Frequency (MHz)
52	5260	60	5300
56	5280	64	5320

2 channels are provided for 802.11n (HT40):

Channel	Frequency (MHz)	Channel	Frequency (MHz)
54	5270	62	5310

1 channel is provided for 802.11ac (VHT80):

Channel	Frequency (MHz)
58	5290

For 5500 ~ 5700 MHz

11 channels are provided for 802.11a, 802.11n (HT20):

Channel	Frequency (MHz)	Channel	Frequency (MHz)
100	5500	124	5620
104	5520	128	5640
108	5540	132	5660
112	5560	136	5680
116	5580	140	5700
120	5600		

5 channels are provided for 802.11n (HT40):

Channel	Frequency (MHz)	Channel	Frequency (MHz)
102	5510	126	5630
110	5550	134	5670
118	5590		

2 channels are provided for 802.11ac (VHT80):

Channel	Frequency (MHz)	Channel	Frequency (MHz)
106	5530	122	5610

For 5745 ~ 5825 MHz:

5 channels are provided for 802.11a, 802.11n (HT20):

Channel	Frequency (MHz)	Channel	Frequency (MHz)
149	5745	161	5805
153	5765	165	5825
157	5785		

2 channels are provided for 802.11n (HT40):

Channel	Frequency (MHz)	Channel	Frequency (MHz)
151	5755	159	5795

1 channel is provided for 802.11ac (VHT80):

Channel	Frequency (MHz)
155	5775

3.2.1 Test Mode Applicability and Tested Channel Detail

EUT Configure Mode	Applicable To				Description
	RE \geq 1G	RE $<$ 1G	PLC	APCM	
-	√	√	√	√	-

Where **RE \geq 1G**: Radiated Emission above 1 GHz **RE $<$ 1G**: Radiated Emission below 1 GHz
PLC: Power Line Conducted Emission **APCM**: Antenna Port Conducted Measurement

Note:

- The EUT had been pre-tested on the positioned of each 3 axis. The worst case was found when positioned on **Z-plane** for 5180-5240MHz&5260-5320MHz&5500-5700MHz and **X-plane** for 5745-5825MHz.
- "-" means no effect.

Radiated Emission Test (Above 1 GHz):

- Pre-Scan has been conducted to determine the worst-case mode from all possible combinations between available modulations, data rates and antenna ports (if EUT with antenna diversity architecture).
- Following channel(s) was (were) selected for the final test as listed below.

EUT Configure Mode	Frequency Band (MHz)	Mode	Available Channel	Tested Channel	Modulation Technology	Modulation Type	Data Rate (Mbps)
-	5180-5240	802.11a	36 to 48	36, 44, 48	OFDM	BPSK	6.0
-		802.11n (HT20)	36 to 48	36, 44, 48	OFDM	BPSK	MCS0
-		802.11n (HT40)	38 to 46	38, 46	OFDM	BPSK	MCS0
-		802.11ac (VHT80)	42	42	OFDM	BPSK	MCS0
-	5260-5320	802.11a	52 to 64	52, 60, 64	OFDM	BPSK	6.0
-		802.11n (HT20)	52 to 64	52, 60, 64	OFDM	BPSK	MCS0
-		802.11n (HT40)	54 to 62	54, 62	OFDM	BPSK	MCS0
-		802.11ac (VHT80)	58	58	OFDM	BPSK	MCS0
-	5500-5700	802.11a	100 to 140	100, 116, 140	OFDM	BPSK	6.0
-		802.11n (HT20)	100 to 140	100, 116, 140	OFDM	BPSK	MCS0
-		802.11n (HT40)	102 to 134	102, 110, 134	OFDM	BPSK	MCS0
-		802.11ac (VHT80)	106 to 122	106, 122	OFDM	BPSK	MCS0
-	5745-5825	802.11a	149 to 165	149, 157, 165	OFDM	BPSK	6.0
-		802.11n (HT20)	149 to 165	149, 157, 165	OFDM	BPSK	MCS0
-		802.11n (HT40)	151 to 159	151, 159	OFDM	BPSK	MCS0
-		802.11ac (VHT80)	155	155	OFDM	BPSK	MCS0

Radiated Emission Test (Below 1 GHz):

- Pre-Scan has been conducted to determine the worst-case mode from all possible combinations between available modulations, data rates and antenna ports (if EUT with antenna diversity architecture).
- Following channel(s) was (were) selected for the final test as listed below.

EUT Configure Mode	Frequency Band (MHz)	Mode	Available Channel	Tested Channel	Modulation Technology	Modulation Type	Data Rate (Mbps)
-	5180-5240	802.11n (HT40)	38 to 46	38	OFDM	BPSK	MCS0
-	5260-5320	802.11n (HT40)	54 to 62	62	OFDM	BPSK	MCS0
-	5500-5700	802.11a	100 to 140	140	OFDM	BPSK	6.0
-	5745-5825	802.11n (HT20)	149 to 165	149	OFDM	BPSK	MCS0

Power Line Conducted Emission Test:

Pre-Scan has been conducted to determine the worst-case mode from all possible combinations between available modulations, data rates and antenna ports (if EUT with antenna diversity architecture).

Following channel(s) was (were) selected for the final test as listed below.

EUT Configure Mode	Frequency Band (MHz)	Mode	Available Channel	Tested Channel	Modulation Technology	Modulation Type	Data Rate (Mbps)
-	5180-5320	802.11n (HT40)	38 to 46	38	OFDM	BPSK	MCS0

Antenna Port Conducted Measurement:

This item includes all test value of each mode, but only includes spectrum plot of worst value of each mode.

Pre-Scan has been conducted to determine the worst-case mode from all possible combinations between available modulations, data rates and antenna ports (if EUT with antenna diversity architecture).

Following channel(s) was (were) selected for the final test as listed below.

EUT Configure Mode	Frequency Band (MHz)	Mode	Available Channel	Tested Channel	Modulation Technology	Modulation Type	Data Rate (Mbps)
-	5180-5240	802.11a	36 to 48	36, 44, 48	OFDM	BPSK	6.0
-		802.11n (HT20)	36 to 48	36, 44, 48	OFDM	BPSK	MCS0
-		802.11n (HT40)	38 to 46	38, 46	OFDM	BPSK	MCS0
-		802.11ac (VHT80)	42	42	OFDM	BPSK	MCS0
-	5260-5320	802.11a	52 to 64	52, 60, 64	OFDM	BPSK	6.0
-		802.11n (HT20)	52 to 64	52, 60, 64	OFDM	BPSK	MCS0
-		802.11n (HT40)	54 to 62	54, 62	OFDM	BPSK	MCS0
-		802.11ac (VHT80)	58	58	OFDM	BPSK	MCS0
-	5500-5700	802.11a	100 to 140	100, 116, 140	OFDM	BPSK	6.0
-		802.11n (HT20)	100 to 140	100, 116, 140	OFDM	BPSK	MCS0
-		802.11n (HT40)	102 to 134	102, 110, 134	OFDM	BPSK	MCS0
-		802.11ac (VHT80)	106 to 122	106, 122	OFDM	BPSK	MCS0
-	5745-5825	802.11a	149 to 165	149, 157, 165	OFDM	BPSK	6.0
-		802.11n (HT20)	149 to 165	149, 157, 165	OFDM	BPSK	MCS0
-		802.11n (HT40)	151 to 159	151, 159	OFDM	BPSK	MCS0
-		802.11ac (VHT80)	155	155	OFDM	BPSK	MCS0

Test Condition:

Applicable To	Environmental Conditions	Input Power	Tested by
RE≥1G	25 deg. C, 65 % RH	120 Vac, 60 Hz	Getaz Yang
RE<1G	25 deg. C, 65 % RH	120 Vac, 60 Hz	Getaz Yang
PLC	25 deg. C, 65 % RH	120 Vac, 60 Hz	Getaz Yang
APCM	25 deg. C, 65 % RH	120 Vac, 60 Hz	Anson Lin

3.3 Duty Cycle of Test Signal

MODULATION TYPE: BPSK

Duty cycle of test signal is < 98 %, duty factor is required.

802.11a: Duty cycle = 184/206 = 0.893, Duty factor = $10 * \log(1/0.893) = 0.49$

802.11n (HT20): Duty cycle = 1.332/1.365 = 0.976, Duty factor = $10 * \log(1/0.976) = 0.11$

802.11n (HT40): Duty cycle = 662/685 = 0.966, Duty factor = $10 * \log(1/0.966) = 0.15$

802.11ac (VHT80): Duty cycle = 331/354 = 0.935, Duty factor = $10 * \log(1/0.935) = 0.29$

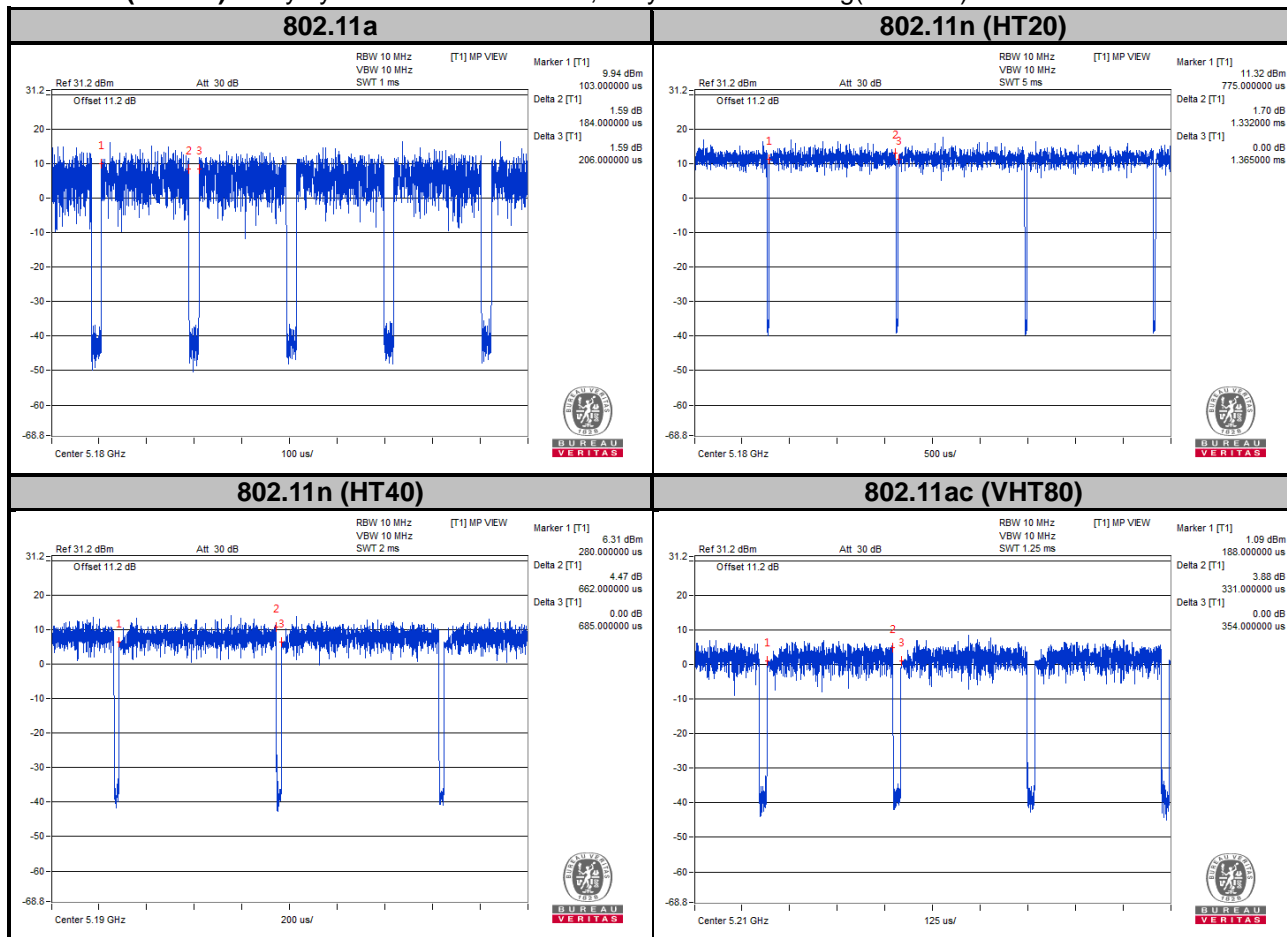

3.4 Description of Support Units

The EUT has been tested as an independent unit together with other necessary accessories or support units.

3.4.1 Configuration of System under Test

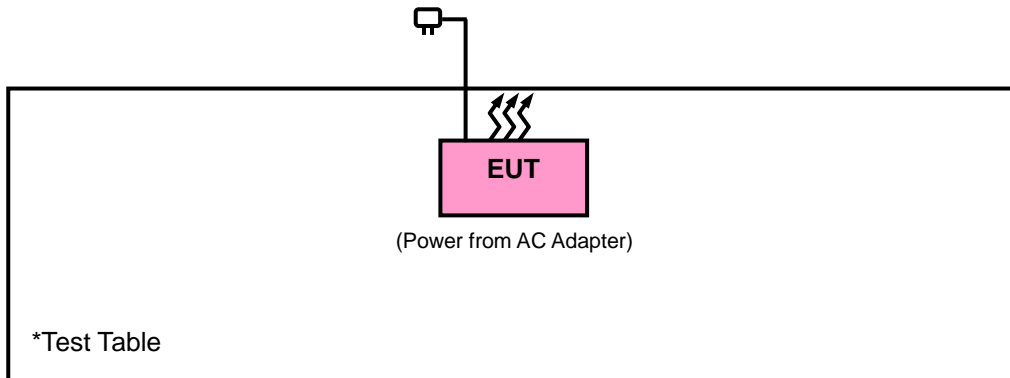

3.5 General Description of Applied Standards

The EUT is a RF Product. According to the specifications of the manufacturer, it must comply with the requirements of the following standards:

FCC Part 15, Subpart E (15.407)

789033 D02 General UNII Test Procedures New Rules v01r04

644545 D01 Guidance for IEEE 802 11ac v01r02

ANSI C63.10-2013

All test items have been performed and recorded as per the above standards.

Note: The EUT has been verified to comply with the requirements of FCC Part 15, Subpart B, Class B (DoC).
The test report has been issued separately.

4 Test Types and Results

4.1 Radiated Emission and Bandedge Measurement

4.1.1 Limits of Radiated Emission and Bandedge Measurement

Radiated emissions which fall in the restricted bands must comply with the radiated emission limits specified as below table. Other emissions shall be at least 20 dB below the highest level of the desired power:

Frequencies (MHz)	Field Strength (microvolts/meter)	Measurement Distance (meters)
0.009 ~ 0.490	2400/F (kHz)	300
0.490 ~ 1.705	24000/F (kHz)	30
1.705 ~ 30.0	30	30
30 ~ 88	100	3
88 ~ 216	150	3
216 ~ 960	200	3
Above 960	500	3

Note:

1. The lower limit shall apply at the transition frequencies.
2. Emission level (dBuV/m) = 20 log Emission level (uV/m).
3. For frequencies above 1000 MHz, the field strength limits are based on average detector, however, the peak field strength of any emission shall not exceed the maximum permitted average limits, specified above by more than 20 dB under any condition of modulation.

4.1.2 Limits of Unwanted Emission Out of the Restricted Bands

Applicable To		Limit	
789033 D02 General UNII Test Procedures New Rules v01r03		Field Strength at 3 m	
		PK: 74 (dBµV/m)	AV: 54 (dBµV/m)
Frequency Band	Applicable To	EIRP Limit	Equivalent Field Strength at 3 m
5150~5250 MHz	15.407(b)(1)	PK: -27 (dBm/MHz)	PK: 68.2 (dBµV/m)
5250~5350 MHz	15.407(b)(2)		
5470~5725 MHz	15.407(b)(3)		
5725~5850 MHz	15.407(b)(4)(i)	PK:-27 (dBm/MHz) ^{*1} PK:10 (dBm/MHz) ^{*2} PK:15.6 (dBm/MHz) ^{*3} PK:27 (dBm/MHz) ^{*4}	PK: 68.2 (dBµV/m) ^{*1} PK:105.2 (dBµV/m) ^{*2} PK: 110.8 (dBµV/m) ^{*3} PK:122.2 (dBµV/m) ^{*4}
	15.407(b)(4)(ii)	Emission limits in section 15.247(d)	

^{*1} beyond 75 MHz or more above of the band edge.

^{*2} below the band edge increasing linearly to 10 dBm/MHz at 25 MHz above.

^{*3} below the band edge increasing linearly to a level of 15.6 dBm/MHz at 5 MHz above.

^{*4} from 5 MHz above or below the band edge increasing linearly to a level of 27 dBm/MHz at the band edge.

Note:

The following formula is used to convert the equipment isotropic radiated power (eirp) to field strength:

$$E = \frac{1000000\sqrt{30P}}{3} \mu\text{V/m, where } P \text{ is the eirp (Watts).}$$

4.1.3 Test Instruments

Description & Manufacturer	Model No.	Serial No.	Date of Calibration	Due Date of Calibration
Test Receiver Agilent	N9038A	MY51210203	Feb. 17, 2017	Feb. 16, 2018
Spectrum Analyzer Agilent	N9010A	MY52220314	Dec. 16, 2016	Dec. 15, 2017
Spectrum Analyzer ROHDE & SCHWARZ	FSU43	101261	Dec. 13, 2016	Dec. 12, 2017
BILOG Antenna SCHWARZBECK	VULB9168	9168-472	Dec. 26, 2016	Dec. 27, 2017
HORN Antenna SCHWARZBECK	BBHA 9120 D	9120D-969	Dec. 12, 2016	Dec. 13, 2017
HORN Antenna SCHWARZBECK	BBHA 9170	9170-480	Dec. 14, 2016	Dec. 13, 2017
Fixed Attenuator Mini-Circuits	BW-N10W5+	NA	Jul. 08, 2016	Jul. 07, 2017
Loop Antenna	EM-6879	269	Aug. 11, 2016	Aug. 10, 2017
Bluetooth Tester	CBT	100980	Apr. 27, 2015	Apr. 26, 2017
Preamplifier EMCI	EMC 012645	980115	Oct. 21, 2016	Oct. 20, 2017
Preamplifier EMCI	EMC 184045	980116	Oct. 21, 2016	Oct. 20, 2017
Preamplifier EMCI	EMC 330H	980112	Oct. 21, 2016	Oct. 20, 2017
Power Meter Anritsu	ML2495A	1232002	Sep. 08, 2016	Sep. 07, 2017
Power Sensor Anritsu	MA2411B	1207325	Sep. 08, 2016	Sep. 07, 2017
RF signal cable HUBER+SUHNNER	SUCOFLEX 104	309219/4 2950114	Oct. 21, 2016	Oct. 20, 2017
RF signal cable HUBER+SUHNNER	SUCOFLEX 104	250130/4	Oct. 21, 2016	Oct. 20, 2017
RF Coaxial Cable Worken	8D-FB	Cable-Ch10-01	Oct. 21, 2016	Oct. 20, 2017
Software BV ADT	E3 6.120103	NA	NA	NA
Antenna Tower MF	MFA-440H	NA	NA	NA
Turn Table MF	MFT-201SS	NA	NA	NA
Antenna Tower & Turn Table Controller MF	MF-7802	NA	NA	NA

- Note: 1. The calibration interval of the above test instruments is 12 / 24 months and the calibrations are traceable to NML/ROC and NIST/USA.
2. The test was performed in HwaYa Chamber 10.
3. The horn antenna and preamplifier (model: EMC 184045) are used only for the measurement of emission frequency above 1 GHz if tested.
4. The FCC Site Registration No. is 690701.
5. The IC Site Registration No. is IC7450F-10.

4.1.4 Test Procedures

- a. The EUT was placed on the top of a rotating table 0.8 meters (for below 1 GHz) / 1.5 meters (for above 1 GHz) above the ground at 3 meter chamber room for test. The table was rotated 360 degrees to determine the position of the highest radiation.
- b. The EUT was set 3 meters away from the interference-receiving antenna, which was mounted on the top of a variable-height antenna tower.
- c. The height of antenna is varied from one meter to four meters above the ground to determine the maximum value of the field strength. Both horizontal and vertical polarizations of the antenna are set to make the measurement.
- d. For each suspected emission, the EUT was arranged to its worst case and then the antenna was tuned to heights from 1 meter to 4 meters and the rotatable table was turned from 0 degrees to 360 degrees to find the maximum reading.
- e. The test-receiver system was set to quasi-peak detect function and specified bandwidth with maximum hold mode when the test frequency is below 1 GHz.
- f. The test-receiver system was set to peak and average detected function and specified bandwidth with maximum hold mode when the test frequency is above 1 GHz. If the peak reading value also meets average limit, measurement with the average detector is unnecessary.

Note:

1. The resolution bandwidth and video bandwidth of test receiver/spectrum analyzer is 120 kHz & 360 kHz for Quasi-peak detection (QP) at frequency below 1 GHz.
2. The resolution bandwidth of test receiver/spectrum analyzer is 1 MHz and the video bandwidth is 3 MHz for Peak detection (PK) at frequency above 1 GHz.
3. The resolution bandwidth of test receiver/spectrum analyzer is 1 MHz and the video bandwidth is 1/T for RMS Average (Duty cycle < 98 %) for Peak detection at frequency above 1 GHz.
4. The resolution bandwidth of test receiver/spectrum analyzer is 1 MHz and the video bandwidth is 10 Hz (Duty cycle \geq 98 %) for Average detection (AV) at frequency above 1 GHz.
5. All modes of operation were investigated and the worst-case emissions are reported.

4.1.5 Deviation from Test Standard

No deviation.

4.1.6 Test Set Up

<Radiated emission below 30MHz>

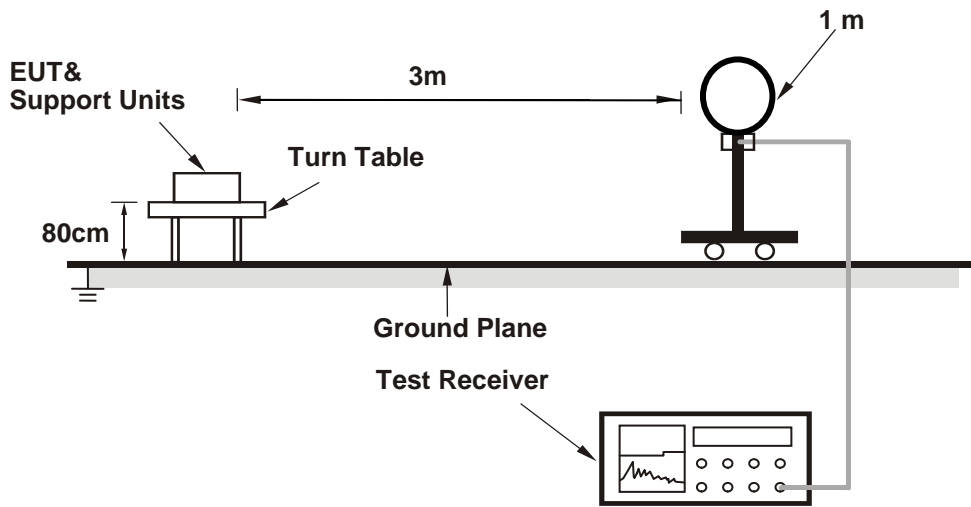

<Frequency Range below 1 GHz>

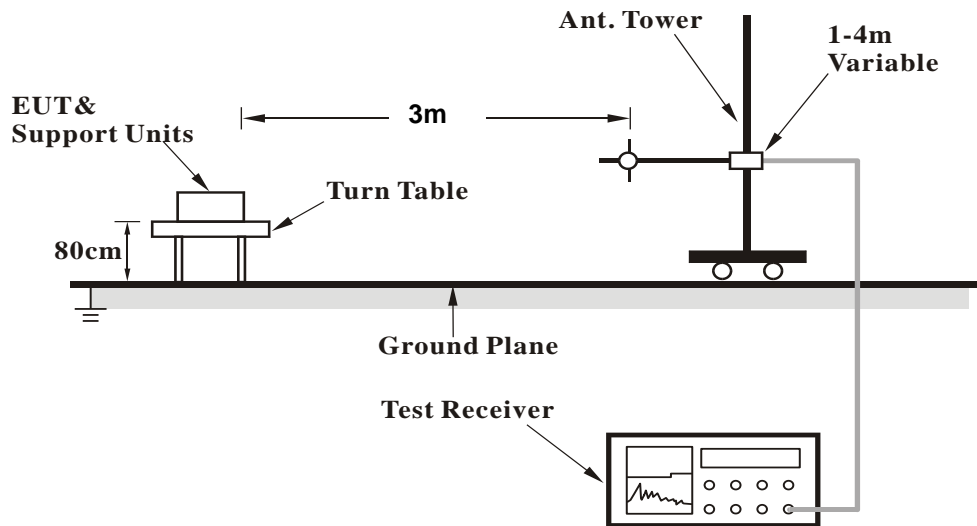

<Frequency Range above 1 GHz>

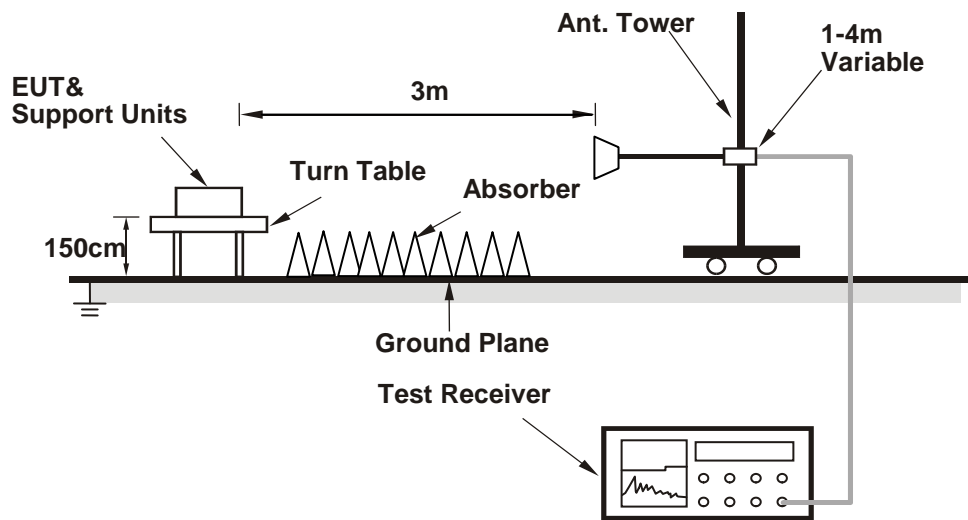

For the actual test configuration, please refer to the attached file (Test Setup Photo).

4.1.7 EUT Operating Conditions

- a. Placed the EUT on a testing table.
- b. Use the software to control the EUT under transmission condition continuously at specific channel frequency.

4.1.8 Test Results
 Above 1 GHz Data :
 802.11a

EUT Test Condition		Measurement Detail	
Channel	Channel 36	Frequency Range	1 GHz ~ 40 GHz
Input Power	120 Vac, 60 Hz	Detector Function	Peak (PK) Average (AV)
Environmental Conditions	25 deg. C, 65 % RH	Tested By	Getaz Yang

Antenna Polarity & Test Distance: Horizontal at 3 m										
Frequency (MHz)	Emission Level (dBuV/m)	Read Level (dBuV)	Limit (dBuV/m)	Margin (dB)	Antenna Factor (dB/m)	Cable Loss (dB)	Preamp Factor (dB)	Antenna Height (cm)	Table Angle (Degree)	Remark
5149.85	39	38.8	54	-15	31.32	6.2	37.32	201	253	Average
5150	56.62	56.42	74	-17.38	31.32	6.2	37.32	201	253	Peak
5180	85.01	84.78			31.35	6.22	37.34	201	253	Average
5180	96.41	96.18			31.35	6.22	37.34	201	253	Peak
*10360	54.43	58.33	68.2	-13.77	39.19	9.05	52.14	111	230	Peak

Antenna Polarity & Test Distance: Vertical at 3 m										
Frequency (MHz)	Emission Level (dBuV/m)	Read Level (dBuV)	Limit (dBuV/m)	Margin (dB)	Antenna Factor (dB/m)	Cable Loss (dB)	Preamp Factor (dB)	Antenna Height (cm)	Table Angle (Degree)	Remark
5148.8	41.46	41.26	54	-12.54	31.32	6.2	37.32	200	276	Average
5148.95	61.73	61.53	74	-12.27	31.32	6.2	37.32	200	276	Peak
5180	89.88	89.65			31.35	6.22	37.34	200	276	Average
5180	102.1	101.87			31.35	6.22	37.34	200	276	Peak
*10360	54.47	58.37	68.2	-13.73	39.19	9.05	52.14	135	133	Peak

Remarks:

- Emission Level = Read Level + Antenna Factor + Cable Loss - Preamp Factor
 Margin value = Emission level – Limit value
- 5180 MHz: Fundamental Frequency
- *: Out of Restricted Band

EUT Test Condition		Measurement Detail	
Channel	Channel 44	Frequency Range	1 GHz ~ 40 GHz
Input Power	120 Vac, 60 Hz	Detector Function	Peak (PK) Average (AV)
Environmental Conditions	25 deg. C, 65 % RH	Tested By	Getaz Yang

Antenna Polarity & Test Distance: Horizontal at 3 m										
Frequency (MHz)	Emission Level (dBuV/m)	Read Level (dBuV)	Limit (dBuV/m)	Margin (dB)	Antenna Factor (dB/m)	Cable Loss (dB)	Preamp Factor (dB)	Antenna Height (cm)	Table Angle (Degree)	Remark
5002.55	50.85	50.75	74	-23.15	31.2	6.13	37.23	201	251	Peak
5130.95	38.33	38.12	54	-15.67	31.31	6.2	37.3	201	251	Average
5220	85	84.75	54			6.24	37.36	201	251	Average
5220	96.62	96.37	74			6.24	37.36	201	251	Peak
5381.02	50.93	50.29	74	-23.07	31.51	6.31	37.18	201	251	Peak
5444.27	38.7	37.94	54	-15.3	31.55	6.34	37.13	201	251	Average
*10440	53.07	57.17	68.2	-15.13	39.29	9.09	52.48	108	228	Peak
Antenna Polarity & Test Distance: Vertical at 3 m										
Frequency (MHz)	Emission Level (dBuV/m)	Read Level (dBuV)	Limit (dBuV/m)	Margin (dB)	Antenna Factor (dB/m)	Cable Loss (dB)	Preamp Factor (dB)	Antenna Height (cm)	Table Angle (Degree)	Remark
5053.7	51.54	51.38	74	-22.46	31.24	6.17	37.25	200	291	Peak
5141.9	38.54	38.32	54	-15.46	31.32	6.2	37.3	200	291	Average
5220	91.08	90.83	54			6.24	37.36	200	291	Average
5220	102.82	102.57	74			6.24	37.36	200	291	Peak
5405.55	39.12	38.46	54	-14.88	31.52	6.32	37.18	200	291	Average
5435.25	51.39	50.65	74	-22.61	31.55	6.32	37.13	200	291	Peak
*10440	52.46	56.56	68.2	-15.74	39.29	9.09	52.48	133	155	Peak

Remarks:

- Emission Level = Read Level + Antenna Factor + Cable Loss - Preamp Factor
Margin value = Emission level – Limit value
- 5220 MHz: Fundamental Frequency
- *: Out of Restricted Band

EUT Test Condition		Measurement Detail	
Channel	Channel 48	Frequency Range	1 GHz ~ 40 GHz
Input Power	120 Vac, 60 Hz	Detector Function	Peak (PK) Average (AV)
Environmental Conditions	25 deg. C, 65 % RH	Tested By	Getaz Yang

Antenna Polarity & Test Distance: Horizontal at 3 m										
Frequency (MHz)	Emission Level (dBuV/m)	Read Level (dBuV)	Limit (dBuV/m)	Margin (dB)	Antenna Factor (dB/m)	Cable Loss (dB)	Preamp Factor (dB)	Antenna Height (cm)	Table Angle (Degree)	Remark
5066.3	50.48	50.31	74	-23.52	31.25	6.17	37.25	198	251	Peak
5106.05	38.41	38.21	54	-15.59	31.29	6.19	37.28	198	251	Average
5240	85.23	84.91			31.39	6.25	37.32	198	251	Average
5240	96.61	96.29			31.39	6.25	37.32	198	251	Peak
5439.54	38.68	37.92	54	-15.32	31.55	6.34	37.13	198	251	Average
5446.91	50.96	50.19	74	-23.04	31.56	6.34	37.13	198	251	Peak
*10480	52.77	57.02	68.2	-15.43	39.37	9.09	52.71	108	219	Peak

Antenna Polarity & Test Distance: Vertical at 3 m										
Frequency (MHz)	Emission Level (dBuV/m)	Read Level (dBuV)	Limit (dBuV/m)	Margin (dB)	Antenna Factor (dB/m)	Cable Loss (dB)	Preamp Factor (dB)	Antenna Height (cm)	Table Angle (Degree)	Remark
5080.1	51.02	50.85	74	-22.98	31.27	6.17	37.27	200	276	Peak
5143.1	38.43	38.21	54	-15.57	31.32	6.2	37.3	200	276	Average
5240	91.05	90.73			31.39	6.25	37.32	200	276	Average
5240	102.52	102.2			31.39	6.25	37.32	200	276	Peak
5425.24	38.92	38.2	54	-15.08	31.53	6.32	37.13	200	276	Average
5440.42	51.36	50.6	74	-22.64	31.55	6.34	37.13	200	276	Peak
*10480	52.88	57.13	68.2	-15.32	39.37	9.09	52.71	136	155	Peak

Remarks:

- Emission Level = Read Level + Antenna Factor + Cable Loss - Preamp Factor
Margin value = Emission level – Limit value
- 5240 MHz: Fundamental Frequency
- *: Out of Restricted Band

EUT Test Condition		Measurement Detail	
Channel	Channel 52	Frequency Range	1 GHz ~ 40 GHz
Input Power	120 Vac, 60 Hz	Detector Function	Peak (PK) Average (AV)
Environmental Conditions	25 deg. C, 65 % RH	Tested By	Getaz Yang

Antenna Polarity & Test Distance: Horizontal at 3 m										
Frequency (MHz)	Emission Level (dBuV/m)	Read Level (dBuV)	Limit (dBuV/m)	Margin (dB)	Antenna Factor (dB/m)	Cable Loss (dB)	Preamp Factor (dB)	Antenna Height (cm)	Table Angle (Degree)	Remark
5054	51.12	50.96	74	-22.88	31.24	6.17	37.25	205	269	Peak
5122.1	38.43	38.25	54	-15.57	31.29	6.19	37.3	205	269	Average
5260	86.26	85.87			31.41	6.25	37.27	205	269	Average
5260	98.06	97.67			31.41	6.25	37.27	205	269	Peak
5438.77	38.72	37.96	54	-15.28	31.55	6.34	37.13	205	269	Average
5455.27	51.17	50.35	74	-22.83	31.56	6.34	37.08	205	269	Peak
*10520	53.36	57.64	68.2	-14.84	39.43	9.12	52.83	126	211	Peak
Antenna Polarity & Test Distance: Vertical at 3 m										
Frequency (MHz)	Emission Level (dBuV/m)	Read Level (dBuV)	Limit (dBuV/m)	Margin (dB)	Antenna Factor (dB/m)	Cable Loss (dB)	Preamp Factor (dB)	Antenna Height (cm)	Table Angle (Degree)	Remark
5015.15	51.05	50.92	74	-22.95	31.21	6.15	37.23	197	244	Peak
5097.05	38.43	38.24	54	-15.57	31.28	6.19	37.28	197	244	Average
5260	89.83	89.44			31.41	6.25	37.27	197	244	Average
5260	100.83	100.44			31.41	6.25	37.27	197	244	Peak
5427.22	51.13	50.41	74	-22.87	31.53	6.32	37.13	197	244	Peak
5447.79	38.91	38.14	54	-15.09	31.56	6.34	37.13	197	244	Average
*10520	53.26	57.54	68.2	-14.94	39.43	9.12	52.83	109	88	Peak

Remarks:

- Emission Level = Read Level + Antenna Factor + Cable Loss - Preamp Factor
Margin value = Emission level – Limit value
- 5260 MHz: Fundamental Frequency
- *: Out of Restricted Band

EUT Test Condition		Measurement Detail	
Channel	Channel 60	Frequency Range	1 GHz ~ 40 GHz
Input Power	120 Vac, 60 Hz	Detector Function	Peak (PK) Average (AV)
Environmental Conditions	25 deg. C, 65 % RH	Tested By	Getaz Yang

Antenna Polarity & Test Distance: Horizontal at 3 m										
Frequency (MHz)	Emission Level (dBuV/m)	Read Level (dBuV)	Limit (dBuV/m)	Margin (dB)	Antenna Factor (dB/m)	Cable Loss (dB)	Preamp Factor (dB)	Antenna Height (cm)	Table Angle (Degree)	Remark
5120.45	38.45	38.27	54	-15.55	31.29	6.19	37.3	190	279	Average
5131.85	50.8	50.59	74	-23.2	31.31	6.2	37.3	190	279	Peak
5300	87.39	86.87			31.44	6.27	37.19	190	279	Average
5300	98.85	98.33			31.44	6.27	37.19	190	279	Peak
5376.73	51.8	51.18	74	-22.2	31.49	6.31	37.18	190	279	Peak
5424.14	38.96	38.29	54	-15.04	31.53	6.32	37.18	190	279	Average
10600	43.96	47.64	54	-10.04	39.57	9.16	52.41	125	208	Average
10600	53.59	57.27	74	-20.41	39.57	9.16	52.41	125	208	Peak

Antenna Polarity & Test Distance: Vertical at 3 m										
Frequency (MHz)	Emission Level (dBuV/m)	Read Level (dBuV)	Limit (dBuV/m)	Margin (dB)	Antenna Factor (dB/m)	Cable Loss (dB)	Preamp Factor (dB)	Antenna Height (cm)	Table Angle (Degree)	Remark
5125.85	38.53	38.32	54	-15.47	31.31	6.2	37.3	196	244	Average
5129.3	51.29	51.08	74	-22.71	31.31	6.2	37.3	196	244	Peak
5300	90.4	89.88			31.44	6.27	37.19	196	244	Average
5300	102.6	102.08			31.44	6.27	37.19	196	244	Peak
5350.22	39.77	39.18	54	-14.23	31.48	6.29	37.18	196	244	Average
5351.87	51.54	50.95	74	-22.46	31.48	6.29	37.18	196	244	Peak
10600	44.16	47.84	54	-9.84	39.57	9.16	52.41	105	94	Average
10600	54.29	57.97	74	-19.71	39.57	9.16	52.41	105	94	Peak

Remarks:

- Emission Level = Read Level + Antenna Factor + Cable Loss - Preamp Factor
Margin value = Emission level – Limit value
- 5300 MHz: Fundamental Frequency

EUT Test Condition		Measurement Detail	
Channel	Channel 64	Frequency Range	1 GHz ~ 40 GHz
Input Power	120 Vac, 60 Hz	Detector Function	Peak (PK) Average (AV)
Environmental Conditions	25 deg. C, 65 % RH	Tested By	Getaz Yang

Antenna Polarity & Test Distance: Horizontal at 3 m										
Frequency (MHz)	Emission Level (dBuV/m)	Read Level (dBuV)	Limit (dBuV/m)	Margin (dB)	Antenna Factor (dB/m)	Cable Loss (dB)	Preamp Factor (dB)	Antenna Height (cm)	Table Angle (Degree)	Remark
5320	86.76	86.21			31.45	6.29	37.19	193	277	Average
5320	97.8	97.25			31.45	6.29	37.19	193	277	Peak
5350.11	58.28	57.69	74	-15.72	31.48	6.29	37.18	193	277	Peak
5350.44	40.1	39.51	54	-13.9	31.48	6.29	37.18	193	277	Average
10640	44.3	47.75	54	-9.7	39.62	9.2	52.27	123	219	Average
10640	54.75	58.2	74	-19.25	39.62	9.2	52.27	123	219	Peak

Antenna Polarity & Test Distance: Vertical at 3 m										
Frequency (MHz)	Emission Level (dBuV/m)	Read Level (dBuV)	Limit (dBuV/m)	Margin (dB)	Antenna Factor (dB/m)	Cable Loss (dB)	Preamp Factor (dB)	Antenna Height (cm)	Table Angle (Degree)	Remark
5320	89.74	89.19			31.45	6.29	37.19	190	244	Average
5320	101.72	101.17			31.45	6.29	37.19	190	244	Peak
5350.77	41.96	41.37	54	-12.04	31.48	6.29	37.18	190	244	Average
5351.1	63.32	62.73	74	-10.68	31.48	6.29	37.18	190	244	Peak
10640	44.41	47.86	54	-9.59	39.62	9.2	52.27	108	98	Average
10640	54.16	57.61	74	-19.84	39.62	9.2	52.27	108	98	Peak

Remarks:

- Emission Level = Read Level + Antenna Factor + Cable Loss - Preamp Factor
Margin value = Emission level – Limit value
- 5320 MHz: Fundamental Frequency

EUT Test Condition		Measurement Detail	
Channel	Channel 100	Frequency Range	1 GHz ~ 40 GHz
Input Power	120 Vac, 60 Hz	Detector Function	Peak (PK) Average (AV)
Environmental Conditions	25 deg. C, 65 % RH	Tested By	Getaz Yang

Antenna Polarity & Test Distance: Horizontal at 3 m										
Frequency (MHz)	Emission Level (dBuV/m)	Read Level (dBuV)	Limit (dBuV/m)	Margin (dB)	Antenna Factor (dB/m)	Cable Loss (dB)	Preamp Factor (dB)	Antenna Height (cm)	Table Angle (Degree)	Remark
5459.76	51.52	50.7	74	-22.48	31.56	6.34	37.08	196	314	Peak
5459.92	39.48	38.66	54	-14.52	31.56	6.34	37.08	196	314	Average
*5468.72	59.11	58.28	68.2	-9.09	31.57	6.34	37.08	196	314	Peak
5500	86	85.07			31.6	6.36	37.03	196	314	Average
5500	98.04	97.11			31.6	6.36	37.03	196	314	Peak
11000	44.05	47.95	54	-9.95	40.2	9.35	53.45	102	226	Average
11000	55.92	59.82	74	-18.08	40.2	9.35	53.45	102	226	Peak
Antenna Polarity & Test Distance: Vertical at 3 m										
Frequency (MHz)	Emission Level (dBuV/m)	Read Level (dBuV)	Limit (dBuV/m)	Margin (dB)	Antenna Factor (dB/m)	Cable Loss (dB)	Preamp Factor (dB)	Antenna Height (cm)	Table Angle (Degree)	Remark
5459.6	40.62	39.8	54	-13.38	31.56	6.34	37.08	189	288	Average
5459.92	55.58	54.76	74	-18.42	31.56	6.34	37.08	189	288	Peak
*5470	62.03	61.2	68.2	-6.17	31.57	6.34	37.08	189	288	Peak
5500	90.25	89.32			31.6	6.36	37.03	189	288	Average
5500	102.05	101.12			31.6	6.36	37.03	189	288	Peak
11000	43.95	47.85	54	-10.05	40.2	9.35	53.45	100	94	Average
11000	55.01	58.91	74	-18.99	40.2	9.35	53.45	100	94	Peak

Remarks:

- Emission Level = Read Level + Antenna Factor + Cable Loss - Preamp Factor
Margin value = Emission level – Limit value
- 5500 MHz: Fundamental Frequency
- *: Out of Restricted Band

EUT Test Condition		Measurement Detail	
Channel	Channel 116	Frequency Range	1 GHz ~ 40 GHz
Input Power	120 Vac, 60 Hz	Detector Function	Peak (PK) Average (AV)
Environmental Conditions	25 deg. C, 65 % RH	Tested By	Getaz Yang

Antenna Polarity & Test Distance: Horizontal at 3 m										
Frequency (MHz)	Emission Level (dBuV/m)	Read Level (dBuV)	Limit (dBuV/m)	Margin (dB)	Antenna Factor (dB/m)	Cable Loss (dB)	Preamp Factor (dB)	Antenna Height (cm)	Table Angle (Degree)	Remark
5371.44	51.34	50.72	74	-22.66	31.49	6.31	37.18	196	312	Peak
5441.36	38.83	38.07	54	-15.17	31.55	6.34	37.13	196	312	Average
*5470.64	50.86	50.03	68.2	-17.34	31.57	6.34	37.08	196	312	Peak
5580	85.66	84.62			31.71	6.49	37.16	196	312	Average
5580	96.85	95.81			31.71	6.49	37.16	196	312	Peak
*5725.8	52.08	50.8	68.2	-16.12	31.96	6.75	37.43	196	312	Peak
11160	43.94	47.66	54	-10.06	40.1	9.57	53.39	101	221	Average
11160	54.43	58.15	74	-19.57	40.1	9.57	53.39	101	221	Peak

Antenna Polarity & Test Distance: Vertical at 3 m										
Frequency (MHz)	Emission Level (dBuV/m)	Read Level (dBuV)	Limit (dBuV/m)	Margin (dB)	Antenna Factor (dB/m)	Cable Loss (dB)	Preamp Factor (dB)	Antenna Height (cm)	Table Angle (Degree)	Remark
5432.08	51	50.26	74	-23	31.55	6.32	37.13	202	284	Peak
5437.36	38.89	38.13	54	-15.11	31.55	6.34	37.13	202	284	Average
*5468.24	49.61	48.78	68.2	-18.59	31.57	6.34	37.08	202	284	Peak
5580	90.84	89.8			31.71	6.49	37.16	202	284	Average
5580	101.95	100.91			31.71	6.49	37.16	202	284	Peak
*5724.04	51.8	50.58	68.2	-16.4	31.96	6.69	37.43	202	284	Peak
11160	44.04	47.76	54	-9.96	40.1	9.57	53.39	100	98	Average
11160	54.48	58.2	74	-19.52	40.1	9.57	53.39	100	98	Peak

Remarks:

- Emission Level = Read Level + Antenna Factor + Cable Loss - Preamp Factor
Margin value = Emission level – Limit value
- 5580 MHz: Fundamental Frequency
- *: Out of Restricted Band

EUT Test Condition		Measurement Detail	
Channel	Channel 140	Frequency Range	1 GHz ~ 40 GHz
Input Power	120 Vac, 60 Hz	Detector Function	Peak (PK) Average (AV)
Environmental Conditions	25 deg. C, 65 % RH	Tested By	Getaz Yang

Antenna Polarity & Test Distance: Horizontal at 3 m										
Frequency (MHz)	Emission Level (dBuV/m)	Read Level (dBuV)	Limit (dBuV/m)	Margin (dB)	Antenna Factor (dB/m)	Cable Loss (dB)	Preamp Factor (dB)	Antenna Height (cm)	Table Angle (Degree)	Remark
5399.28	51.26	50.6	74	-22.74	31.52	6.32	37.18	199	248	Peak
5450.16	38.81	37.99	54	-15.19	31.56	6.34	37.08	199	248	Average
*5468.08	50.52	49.69	68.2	-17.68	31.57	6.34	37.08	199	248	Peak
5700	86.87	85.68			31.9	6.69	37.4	199	248	Average
5700	97.77	96.58			31.9	6.69	37.4	199	248	Peak
*5724.52	57.62	56.4	68.2	-10.58	31.96	6.69	37.43	199	248	Peak
11400	45.53	47.79	54	-8.47	39.96	9.91	52.13	105	215	Average
11400	56.03	58.29	74	-17.97	39.96	9.91	52.13	105	215	Peak

Antenna Polarity & Test Distance: Vertical at 3 m										
Frequency (MHz)	Emission Level (dBuV/m)	Read Level (dBuV)	Limit (dBuV/m)	Margin (dB)	Antenna Factor (dB/m)	Cable Loss (dB)	Preamp Factor (dB)	Antenna Height (cm)	Table Angle (Degree)	Remark
5399.28	50.57	49.91	74	-23.43	31.52	6.32	37.18	202	282	Peak
5400.4	38.82	38.16	54	-15.18	31.52	6.32	37.18	202	282	Average
*5468.24	49.26	48.43	68.2	-18.94	31.57	6.34	37.08	202	282	Peak
5700	91.58	90.39			31.9	6.69	37.4	202	282	Average
5700	104.37	103.18			31.9	6.69	37.4	202	282	Peak
*5724.92	62.42	61.2	68.2	-5.78	31.96	6.69	37.43	202	282	Peak
11400	45.6	47.86	54	-8.4	39.96	9.91	52.13	101	94	Average
11400	56.45	58.71	74	-17.55	39.96	9.91	52.13	101	94	Peak

Remarks:

- Emission Level = Read Level + Antenna Factor + Cable Loss - Preamp Factor
Margin value = Emission level – Limit value
- 5700 MHz: Fundamental Frequency
- *: Out of Restricted Band

EUT Test Condition		Measurement Detail	
Channel	Channel 149	Frequency Range	1 GHz ~ 40 GHz
Input Power	120 Vac, 60 Hz	Detector Function	Peak (PK) Average (AV)
Environmental Conditions	25 deg. C, 65 % RH	Tested By	Getaz Yang

<Spurious Emission>

Antenna Polarity & Test Distance: Horizontal at 3 m										
Frequency (MHz)	Emission Level (dBuV/m)	Read Level (dBuV)	Limit (dBuV/m)	Margin (dB)	Antenna Factor (dB/m)	Cable Loss (dB)	Preamp Factor (dB)	Antenna Height (cm)	Table Angle (Degree)	Remark
5745	93.11	91.84			31.99	6.75	37.47	202	242	Average
5745	104.79	103.52			31.99	6.75	37.47	202	242	Peak
11490	44.81	47.7	54	-9.19	39.91	10.03	52.83	165	149	Average
11490	55.64	58.53	74	-18.36	39.91	10.03	52.83	165	149	Peak
Antenna Polarity & Test Distance: Vertical at 3 m										
Frequency (MHz)	Emission Level (dBuV/m)	Read Level (dBuV)	Limit (dBuV/m)	Margin (dB)	Antenna Factor (dB/m)	Cable Loss (dB)	Preamp Factor (dB)	Antenna Height (cm)	Table Angle (Degree)	Remark
5745	87.28	86.01			31.99	6.75	37.47	164	165	Average
5745	99.18	97.91			31.99	6.75	37.47	164	165	Peak
11490	44.87	47.76	54	-9.13	39.91	10.03	52.83	121	77	Average
11490	56.3	59.19	74	-17.7	39.91	10.03	52.83	121	77	Peak

<Out of Band Emission (OOBE)>

Antenna Polarity & Test Distance: Horizontal at 3 m										
Frequency (MHz)	Emission Level (dBuV/m)	Read Level (dBuV)	Limit (dBuV/m)	Margin (dB)	Antenna Factor (dB/m)	Cable Loss (dB)	Preamp Factor (dB)	Antenna Height (cm)	Table Angle (Degree)	Remark
*5592.75	51.37	50.3	68.2	-16.83	31.74	6.49	37.16	202	242	Peak
5654.025	49.57	48.44	71.19	-21.62	31.85	6.62	37.34	202	242	Peak
5920.975	50.95	49.18	71.17	-20.22	32.26	7.01	37.5	202	242	Peak
*5979.4	52.26	50.32	68.2	-15.94	32.37	7.08	37.51	202	242	Peak
Antenna Polarity & Test Distance: Vertical at 3 m										
Frequency (MHz)	Emission Level (dBuV/m)	Read Level (dBuV)	Limit (dBuV/m)	Margin (dB)	Antenna Factor (dB/m)	Cable Loss (dB)	Preamp Factor (dB)	Antenna Height (cm)	Table Angle (Degree)	Remark
*5575.175	51.04	49.96	68.2	-17.16	31.71	6.49	37.12	164	165	Peak
5655.45	52.29	51.16	72.25	-19.96	31.85	6.62	37.34	164	165	Peak
5920.025	50.17	48.4	71.87	-21.7	32.26	7.01	37.5	164	165	Peak
*5957.075	52.29	50.37	68.2	-15.91	32.34	7.08	37.5	164	165	Peak

Remarks:

- Emission Level = Read Level + Antenna Factor + Cable Loss - Preamp Factor
Margin value = Emission level – Limit value
- 5745 MHz: Fundamental Frequency
- *: Out of Restricted Band

EUT Test Condition		Measurement Detail	
Channel	Channel 157	Frequency Range	1 GHz ~ 40 GHz
Input Power	120 Vac, 60 Hz	Detector Function	Peak (PK) Average (AV)
Environmental Conditions	25 deg. C, 65 % RH	Tested By	Getaz Yang

<Spurious Emission>

Antenna Polarity & Test Distance: Horizontal at 3 m										
Frequency (MHz)	Emission Level (dBuV/m)	Read Level (dBuV)	Limit (dBuV/m)	Margin (dB)	Antenna Factor (dB/m)	Cable Loss (dB)	Preamp Factor (dB)	Antenna Height (cm)	Table Angle (Degree)	Remark
5785	94.34	93.02			32.04	6.82	37.54	202	244	Average
5785	104.96	103.64			32.04	6.82	37.54	202	244	Peak
11570	43.82	47.28	54	-10.18	39.78	10.09	53.33	101	174	Average
11570	53.81	57.27	74	-20.19	39.78	10.09	53.33	101	174	Peak
Antenna Polarity & Test Distance: Vertical at 3 m										
Frequency (MHz)	Emission Level (dBuV/m)	Read Level (dBuV)	Limit (dBuV/m)	Margin (dB)	Antenna Factor (dB/m)	Cable Loss (dB)	Preamp Factor (dB)	Antenna Height (cm)	Table Angle (Degree)	Remark
5785	88.35	87.03			32.04	6.82	37.54	162	163	Average
5785	99.22	97.9			32.04	6.82	37.54	162	163	Peak
11570	44.37	47.83	54	-9.63	39.78	10.09	53.33	100	122	Average
11570	54.67	58.13	74	-19.33	39.78	10.09	53.33	100	122	Peak

<Out of Band Emission (OOBE)>

Antenna Polarity & Test Distance: Horizontal at 3 m										
Frequency (MHz)	Emission Level (dBuV/m)	Read Level (dBuV)	Limit (dBuV/m)	Margin (dB)	Antenna Factor (dB/m)	Cable Loss (dB)	Preamp Factor (dB)	Antenna Height (cm)	Table Angle (Degree)	Remark
*5598.925	51.44	50.34	68.2	-16.76	31.77	6.49	37.16	202	244	Peak
5655.45	48.68	47.55	72.25	-23.57	31.85	6.62	37.34	202	244	Peak
5920.5	49.86	48.09	71.52	-21.66	32.26	7.01	37.5	202	244	Peak
*5959.925	52.53	50.62	68.2	-15.67	32.34	7.08	37.51	202	244	Peak
Antenna Polarity & Test Distance: Vertical at 3 m										
Frequency (MHz)	Emission Level (dBuV/m)	Read Level (dBuV)	Limit (dBuV/m)	Margin (dB)	Antenna Factor (dB/m)	Cable Loss (dB)	Preamp Factor (dB)	Antenna Height (cm)	Table Angle (Degree)	Remark
*5590.85	51.28	50.21	68.2	-16.92	31.74	6.49	37.16	162	163	Peak
5655.45	49.86	48.73	72.25	-22.39	31.85	6.62	37.34	162	163	Peak
5917.65	50.86	49.09	73.62	-22.76	32.26	7.01	37.5	162	163	Peak
*5942.35	52.58	50.68	68.2	-15.62	32.32	7.08	37.5	162	163	Peak

Remarks:

- Emission Level = Read Level + Antenna Factor + Cable Loss - Preamp Factor
Margin value = Emission level – Limit value
- 5785 MHz: Fundamental Frequency
- *: Out of Restricted Band

EUT Test Condition		Measurement Detail	
Channel	Channel 165	Frequency Range	1 GHz ~ 40 GHz
Input Power	120 Vac, 60 Hz	Detector Function	Peak (PK) Average (AV)
Environmental Conditions	25 deg. C, 65 % RH	Tested By	Getaz Yang

<Spurious Emission>

Antenna Polarity & Test Distance: Horizontal at 3 m										
Frequency (MHz)	Emission Level (dBuV/m)	Read Level (dBuV)	Limit (dBuV/m)	Margin (dB)	Antenna Factor (dB/m)	Cable Loss (dB)	Preamp Factor (dB)	Antenna Height (cm)	Table Angle (Degree)	Remark
5825	93.29	91.82			32.12	6.88	37.53	202	244	Average
5825	104.72	103.25			32.12	6.88	37.53	202	244	Peak
11650	43.89	47.44	54	-10.11	39.65	10.15	53.35	100	145	Average
11650	53.2	56.75	74	-20.8	39.65	10.15	53.35	100	145	Peak
Antenna Polarity & Test Distance: Vertical at 3 m										
Frequency (MHz)	Emission Level (dBuV/m)	Read Level (dBuV)	Limit (dBuV/m)	Margin (dB)	Antenna Factor (dB/m)	Cable Loss (dB)	Preamp Factor (dB)	Antenna Height (cm)	Table Angle (Degree)	Remark
5825	89.15	87.68			32.12	6.88	37.53	161	165	Average
5825	99.83	98.36			32.12	6.88	37.53	161	165	Peak
11650	44.13	47.68	54	-9.87	39.65	10.15	53.35	100	162	Average
11650	54.33	57.88	74	-19.67	39.65	10.15	53.35	100	162	Peak

<Out of Band Emission (OOBE)>

Antenna Polarity & Test Distance: Horizontal at 3 m										
Frequency (MHz)	Emission Level (dBuV/m)	Read Level (dBuV)	Limit (dBuV/m)	Margin (dB)	Antenna Factor (dB/m)	Cable Loss (dB)	Preamp Factor (dB)	Antenna Height (cm)	Table Angle (Degree)	Remark
*5626.475	52.2	51.07	68.2	-16	31.79	6.56	37.22	202	244	Peak
5654.5	49.74	48.61	71.54	-21.8	31.85	6.62	37.34	202	244	Peak
5921.925	49.89	48.09	70.47	-20.58	32.29	7.01	37.5	202	244	Peak
*5940.925	52.51	50.61	68.2	-15.69	32.32	7.08	37.5	202	244	Peak
Antenna Polarity & Test Distance: Vertical at 3 m										
Frequency (MHz)	Emission Level (dBuV/m)	Read Level (dBuV)	Limit (dBuV/m)	Margin (dB)	Antenna Factor (dB/m)	Cable Loss (dB)	Preamp Factor (dB)	Antenna Height (cm)	Table Angle (Degree)	Remark
*5624.1	51.09	49.96	68.2	-17.11	31.79	6.56	37.22	161	165	Peak
5658.775	49.46	48.33	74.72	-25.26	31.85	6.62	37.34	161	165	Peak
5919.55	50.55	48.78	72.22	-21.67	32.26	7.01	37.5	161	165	Peak
*5982.25	52.23	50.29	68.2	-15.97	32.37	7.08	37.51	161	165	Peak

Remarks:

- Emission Level = Read Level + Antenna Factor + Cable Loss - Preamp Factor
Margin value = Emission level – Limit value
- 5825 MHz: Fundamental Frequency
- *: Out of Restricted Band

802.11n (HT20)

EUT Test Condition		Measurement Detail	
Channel	Channel 36	Frequency Range	1 GHz ~ 40 GHz
Input Power	120 Vac, 60 Hz	Detector Function	Peak (PK) Average (AV)
Environmental Conditions	25 deg. C, 65 % RH	Tested By	Getaz Yang

Antenna Polarity & Test Distance: Horizontal at 3 m

Frequency (MHz)	Emission Level (dBuV/m)	Read Level (dBuV)	Limit (dBuV/m)	Margin (dB)	Antenna Factor (dB/m)	Cable Loss (dB)	Preamp Factor (dB)	Antenna Height (cm)	Table Angle (Degree)	Remark
5129.3	38.74	38.53	54	-15.26	31.31	6.2	37.3	200	252	Average
5149.55	51.93	51.73	74	-22.07	31.32	6.2	37.32	200	252	Peak
5180	86.98	86.75			31.35	6.22	37.34	200	252	Average
5180	96.05	95.82			31.35	6.22	37.34	200	252	Peak
*10360	51.96	55.86	68.2	-16.24	39.19	9.05	52.14	118	234	Peak

Antenna Polarity & Test Distance: Vertical at 3 m

Frequency (MHz)	Emission Level (dBuV/m)	Read Level (dBuV)	Limit (dBuV/m)	Margin (dB)	Antenna Factor (dB/m)	Cable Loss (dB)	Preamp Factor (dB)	Antenna Height (cm)	Table Angle (Degree)	Remark
5147.45	58.82	58.62	74	-15.18	31.32	6.2	37.32	200	273	Peak
5149.7	41.7	41.5	54	-12.3	31.32	6.2	37.32	200	273	Average
5180	93.21	92.98			31.35	6.22	37.34	200	273	Average
5180	102.25	102.02			31.35	6.22	37.34	200	273	Peak
*10360	52.11	56.01	68.2	-16.09	39.19	9.05	52.14	134	155	Peak

Remarks:

- Emission Level = Read Level + Antenna Factor + Cable Loss - Preamp Factor
Margin value = Emission level – Limit value
- 5180 MHz: Fundamental Frequency
- *: Out of Restricted Band

EUT Test Condition		Measurement Detail	
Channel	Channel 44	Frequency Range	1 GHz ~ 40 GHz
Input Power	120 Vac, 60 Hz	Detector Function	Peak (PK) Average (AV)
Environmental Conditions	25 deg. C, 65 % RH	Tested By	Getaz Yang

Antenna Polarity & Test Distance: Horizontal at 3 m										
Frequency (MHz)	Emission Level (dBuV/m)	Read Level (dBuV)	Limit (dBuV/m)	Margin (dB)	Antenna Factor (dB/m)	Cable Loss (dB)	Preamp Factor (dB)	Antenna Height (cm)	Table Angle (Degree)	Remark
5138	38.33	38.12	54	-15.67	31.31	6.2	37.3	199	252	Average
5146.1	51.59	51.39	74	-22.41	31.32	6.2	37.32	199	252	Peak
5220	88.38	88.13			31.37	6.24	37.36	199	252	Average
5220	96.79	96.54			31.37	6.24	37.36	199	252	Peak
5407.53	38.79	38.13	54	-15.21	31.52	6.32	37.18	199	252	Average
5413.58	50.65	49.98	74	-23.35	31.53	6.32	37.18	199	252	Peak
*10440	52.26	56.36	68.2	-15.94	39.29	9.09	52.48	111	228	Peak
Antenna Polarity & Test Distance: Vertical at 3 m										
Frequency (MHz)	Emission Level (dBuV/m)	Read Level (dBuV)	Limit (dBuV/m)	Margin (dB)	Antenna Factor (dB/m)	Cable Loss (dB)	Preamp Factor (dB)	Antenna Height (cm)	Table Angle (Degree)	Remark
5131.55	50.62	50.41	74	-23.38	31.31	6.2	37.3	200	275	Peak
5147.75	38.58	38.38	54	-15.42	31.32	6.2	37.32	200	275	Average
5220	93.36	93.11			31.37	6.24	37.36	200	275	Average
5220	102.53	102.28			31.37	6.24	37.36	200	275	Peak
5440.86	38.81	38.05	54	-15.19	31.55	6.34	37.13	200	275	Average
5458.68	51.07	50.25	74	-22.93	31.56	6.34	37.08	200	275	Peak
*10440	52.17	56.27	68.2	-16.03	39.29	9.09	52.48	136	152	Peak

Remarks:

- Emission Level = Read Level + Antenna Factor + Cable Loss - Preamp Factor
Margin value = Emission level – Limit value
- 5220 MHz: Fundamental Frequency
- *: Out of Restricted Band

EUT Test Condition		Measurement Detail	
Channel	Channel 48	Frequency Range	1 GHz ~ 40 GHz
Input Power	120 Vac, 60 Hz	Detector Function	Peak (PK) Average (AV)
Environmental Conditions	25 deg. C, 65 % RH	Tested By	Getaz Yang

Antenna Polarity & Test Distance: Horizontal at 3 m										
Frequency (MHz)	Emission Level (dBuV/m)	Read Level (dBuV)	Limit (dBuV/m)	Margin (dB)	Antenna Factor (dB/m)	Cable Loss (dB)	Preamp Factor (dB)	Antenna Height (cm)	Table Angle (Degree)	Remark
5023.55	51.14	51	74	-22.86	31.23	6.15	37.24	199	243	Peak
5040.5	38.42	38.27	54	-15.58	31.24	6.15	37.24	199	243	Average
5240	87.07	86.75			31.39	6.25	37.32	199	243	Average
5240	96.28	95.96			31.39	6.25	37.32	199	243	Peak
5413.14	51.45	50.78	74	-22.55	31.53	6.32	37.18	199	243	Peak
5444.82	38.64	37.88	54	-15.36	31.55	6.34	37.13	199	243	Average
*10480	53.26	57.51	68.2	-14.94	39.37	9.09	52.71	113	233	Peak
Antenna Polarity & Test Distance: Vertical at 3 m										
Frequency (MHz)	Emission Level (dBuV/m)	Read Level (dBuV)	Limit (dBuV/m)	Margin (dB)	Antenna Factor (dB/m)	Cable Loss (dB)	Preamp Factor (dB)	Antenna Height (cm)	Table Angle (Degree)	Remark
5022.95	50.73	50.59	74	-23.27	31.23	6.15	37.24	200	290	Peak
5148.95	38.41	38.21	54	-15.59	31.32	6.2	37.32	200	290	Average
5240	93.66	93.34			31.39	6.25	37.32	200	290	Average
5240	102.12	101.8			31.39	6.25	37.32	200	290	Peak
5425.57	38.97	38.25	54	-15.03	31.53	6.32	37.13	200	290	Average
5453.18	50.91	50.09	74	-23.09	31.56	6.34	37.08	200	290	Peak
*10480	53.77	58.02	68.2	-14.43	39.37	9.09	52.71	133	151	Peak

Remarks:

- Emission Level = Read Level + Antenna Factor + Cable Loss - Preamp Factor
Margin value = Emission level – Limit value
- 5240 MHz: Fundamental Frequency
- *: Out of Restricted Band

EUT Test Condition		Measurement Detail	
Channel	Channel 52	Frequency Range	1 GHz ~ 40 GHz
Input Power	120 Vac, 60 Hz	Detector Function	Peak (PK) Average (AV)
Environmental Conditions	25 deg. C, 65 % RH	Tested By	Getaz Yang

Antenna Polarity & Test Distance: Horizontal at 3 m										
Frequency (MHz)	Emission Level (dBuV/m)	Read Level (dBuV)	Limit (dBuV/m)	Margin (dB)	Antenna Factor (dB/m)	Cable Loss (dB)	Preamp Factor (dB)	Antenna Height (cm)	Table Angle (Degree)	Remark
5012.45	50.81	50.7	74	-23.19	31.21	6.13	37.23	201	276	Peak
5020.55	38.5	38.36	54	-15.5	31.23	6.15	37.24	201	276	Average
5260	88.44	88.05			31.41	6.25	37.27	201	276	Average
5260	97.91	97.52			31.41	6.25	37.27	201	276	Peak
5424.03	50.91	50.24	74	-23.09	31.53	6.32	37.18	201	276	Peak
5437.78	38.8	38.04	54	-15.2	31.55	6.34	37.13	201	276	Average
*10520	53.99	58.27	68.2	-14.21	39.43	9.12	52.83	127	212	Peak

Antenna Polarity & Test Distance: Vertical at 3 m										
Frequency (MHz)	Emission Level (dBuV/m)	Read Level (dBuV)	Limit (dBuV/m)	Margin (dB)	Antenna Factor (dB/m)	Cable Loss (dB)	Preamp Factor (dB)	Antenna Height (cm)	Table Angle (Degree)	Remark
5102.15	50.27	50.08	74	-23.73	31.28	6.19	37.28	194	245	Peak
5123.75	38.42	38.22	54	-15.58	31.31	6.19	37.3	194	245	Average
5260	91.86	91.47			31.41	6.25	37.27	194	245	Average
5260	101.1	100.71			31.41	6.25	37.27	194	245	Peak
5399.17	51.22	50.56	74	-22.78	31.52	6.32	37.18	194	245	Peak
5446.91	39.06	38.29	54	-14.94	31.56	6.34	37.13	194	245	Average
*10520	53.31	57.59	68.2	-14.89	39.43	9.12	52.83	110	68	Peak

Remarks:

- Emission Level = Read Level + Antenna Factor + Cable Loss - Preamp Factor
Margin value = Emission level – Limit value
- 5260 MHz: Fundamental Frequency
- *: Out of Restricted Band

EUT Test Condition		Measurement Detail	
Channel	Channel 60	Frequency Range	1 GHz ~ 40 GHz
Input Power	120 Vac, 60 Hz	Detector Function	Peak (PK) Average (AV)
Environmental Conditions	25 deg. C, 65 % RH	Tested By	Getaz Yang

Antenna Polarity & Test Distance: Horizontal at 3 m										
Frequency (MHz)	Emission Level (dBuV/m)	Read Level (dBuV)	Limit (dBuV/m)	Margin (dB)	Antenna Factor (dB/m)	Cable Loss (dB)	Preamp Factor (dB)	Antenna Height (cm)	Table Angle (Degree)	Remark
5028.5	50.3	50.16	74	-23.7	31.23	6.15	37.24	201	267	Peak
5131.1	38.43	38.22	54	-15.57	31.31	6.2	37.3	201	267	Average
5300	88.41	87.89			31.44	6.27	37.19	201	267	Average
5300	97.41	96.89			31.44	6.27	37.19	201	267	Peak
5407.2	50.68	50.02	74	-23.32	31.52	6.32	37.18	201	267	Peak
5439.65	38.8	38.04	54	-15.2	31.55	6.34	37.13	201	267	Average
10600	43.75	47.43	54	-10.25	39.57	9.16	52.41	128	207	Average
10600	53.7	57.38	74	-20.3	39.57	9.16	52.41	128	207	Peak

Antenna Polarity & Test Distance: Vertical at 3 m										
Frequency (MHz)	Emission Level (dBuV/m)	Read Level (dBuV)	Limit (dBuV/m)	Margin (dB)	Antenna Factor (dB/m)	Cable Loss (dB)	Preamp Factor (dB)	Antenna Height (cm)	Table Angle (Degree)	Remark
5048.75	38.45	38.31	54	-15.55	31.24	6.15	37.25	191	244	Average
5118.95	50.28	50.1	74	-23.72	31.29	6.19	37.3	191	244	Peak
5300	92.34	91.82			31.44	6.27	37.19	191	244	Average
5300	100.99	100.47			31.44	6.27	37.19	191	244	Peak
5351.98	39.38	38.79	54	-14.62	31.48	6.29	37.18	191	244	Average
5419.63	51.07	50.4	74	-22.93	31.53	6.32	37.18	191	244	Peak
10600	43.66	47.34	54	-10.34	39.57	9.16	52.41	107	88	Average
10600	53.21	56.89	74	-20.79	39.57	9.16	52.41	107	88	Peak

Remarks:

- Emission Level = Read Level + Antenna Factor + Cable Loss - Preamp Factor
Margin value = Emission level – Limit value
- 5300 MHz: Fundamental Frequency

EUT Test Condition		Measurement Detail	
Channel	Channel 64	Frequency Range	1 GHz ~ 40 GHz
Input Power	120 Vac, 60 Hz	Detector Function	Peak (PK) Average (AV)
Environmental Conditions	25 deg. C, 65 % RH	Tested By	Getaz Yang

Antenna Polarity & Test Distance: Horizontal at 3 m										
Frequency (MHz)	Emission Level (dBuV/m)	Read Level (dBuV)	Limit (dBuV/m)	Margin (dB)	Antenna Factor (dB/m)	Cable Loss (dB)	Preamp Factor (dB)	Antenna Height (cm)	Table Angle (Degree)	Remark
5320	88.85	88.3			31.45	6.29	37.19	193	256	Average
5320	97.93	97.38			31.45	6.29	37.19	193	256	Peak
5350.88	39.45	38.86	54	-14.55	31.48	6.29	37.18	193	256	Average
5350.88	58.3	57.71	74	-15.7	31.48	6.29	37.18	193	256	Peak
10640	44.2	47.65	54	-9.8	39.62	9.2	52.27	131	218	Average
10640	54.7	58.15	74	-19.3	39.62	9.2	52.27	131	218	Peak

Antenna Polarity & Test Distance: Vertical at 3 m										
Frequency (MHz)	Emission Level (dBuV/m)	Read Level (dBuV)	Limit (dBuV/m)	Margin (dB)	Antenna Factor (dB/m)	Cable Loss (dB)	Preamp Factor (dB)	Antenna Height (cm)	Table Angle (Degree)	Remark
5320	92.33	91.78			31.45	6.29	37.19	192	243	Average
5320	100.99	100.44			31.45	6.29	37.19	192	243	Peak
5352.42	41.09	40.5	54	-12.91	31.48	6.29	37.18	192	243	Average
5356.38	59.13	58.54	74	-14.87	31.48	6.29	37.18	192	243	Peak
10640	44.33	47.78	54	-9.67	39.62	9.2	52.27	108	88	Average
10640	54.41	57.86	74	-19.59	39.62	9.2	52.27	108	88	Peak

Remarks:

- Emission Level = Read Level + Antenna Factor + Cable Loss - Preamp Factor
Margin value = Emission level – Limit value
- 5320 MHz: Fundamental Frequency

EUT Test Condition		Measurement Detail	
Channel	Channel 100	Frequency Range	1 GHz ~ 40 GHz
Input Power	120 Vac, 60 Hz	Detector Function	Peak (PK) Average (AV)
Environmental Conditions	25 deg. C, 65 % RH	Tested By	Getaz Yang

Antenna Polarity & Test Distance: Horizontal at 3 m										
Frequency (MHz)	Emission Level (dBuV/m)	Read Level (dBuV)	Limit (dBuV/m)	Margin (dB)	Antenna Factor (dB/m)	Cable Loss (dB)	Preamp Factor (dB)	Antenna Height (cm)	Table Angle (Degree)	Remark
5459.76	39.46	38.64	54	-14.54	31.56	6.34	37.08	199	247	Average
5460.08	52.04	51.22	74	-21.96	31.56	6.34	37.08	199	247	Peak
*5469.2	52.15	51.32	68.2	-16.05	31.57	6.34	37.08	199	247	Peak
5500	89.19	88.26			31.6	6.36	37.03	199	247	Average
5500	97.71	96.78			31.6	6.36	37.03	199	247	Peak
11000	43.85	47.75	54	-10.15	40.2	9.35	53.45	103	223	Average
11000	53.37	57.27	74	-20.63	40.2	9.35	53.45	103	223	Peak
Antenna Polarity & Test Distance: Vertical at 3 m										
Frequency (MHz)	Emission Level (dBuV/m)	Read Level (dBuV)	Limit (dBuV/m)	Margin (dB)	Antenna Factor (dB/m)	Cable Loss (dB)	Preamp Factor (dB)	Antenna Height (cm)	Table Angle (Degree)	Remark
5457.36	40.46	39.64	54	-13.54	31.56	6.34	37.08	195	288	Average
5458	52.59	51.77	74	-21.41	31.56	6.34	37.08	195	288	Peak
*5469.36	55.51	54.68	68.2	-12.69	31.57	6.34	37.08	195	288	Peak
5500	92.36	91.43			31.6	6.36	37.03	195	288	Average
5500	101.51	100.58			31.6	6.36	37.03	195	288	Peak
11000	43.95	47.85	54	-10.05	40.2	9.35	53.45	101	99	Average
11000	52.51	56.41	74	-21.49	40.2	9.35	53.45	101	99	Peak

Remarks:

- Emission Level = Read Level + Antenna Factor + Cable Loss - Preamp Factor
Margin value = Emission level – Limit value
- 5500 MHz: Fundamental Frequency
- *: Out of Restricted Band

EUT Test Condition		Measurement Detail	
Channel	Channel 116	Frequency Range	1 GHz ~ 40 GHz
Input Power	120 Vac, 60 Hz	Detector Function	Peak (PK) Average (AV)
Environmental Conditions	25 deg. C, 65 % RH	Tested By	Getaz Yang

Antenna Polarity & Test Distance: Horizontal at 3 m										
Frequency (MHz)	Emission Level (dBuV/m)	Read Level (dBuV)	Limit (dBuV/m)	Margin (dB)	Antenna Factor (dB/m)	Cable Loss (dB)	Preamp Factor (dB)	Antenna Height (cm)	Table Angle (Degree)	Remark
5403.44	51.1	50.44	74	-22.9	31.52	6.32	37.18	197	312	Peak
5404.56	38.95	38.29	54	-15.05	31.52	6.32	37.18	197	312	Average
*5470.8	49.6	48.77	68.2	-18.6	31.57	6.34	37.08	197	312	Peak
5580	88.81	87.77			31.71	6.49	37.16	197	312	Average
5580	97.97	96.93			31.71	6.49	37.16	197	312	Peak
*5724.84	50.94	49.72	68.2	-17.26	31.96	6.69	37.43	197	312	Peak
11160	43.97	47.69	54	-10.03	40.1	9.57	53.39	103	229	Average
11160	54.44	58.16	74	-19.56	40.1	9.57	53.39	103	229	Peak

Antenna Polarity & Test Distance: Vertical at 3 m										
Frequency (MHz)	Emission Level (dBuV/m)	Read Level (dBuV)	Limit (dBuV/m)	Margin (dB)	Antenna Factor (dB/m)	Cable Loss (dB)	Preamp Factor (dB)	Antenna Height (cm)	Table Angle (Degree)	Remark
5422.32	39.04	38.37	54	-14.96	31.53	6.32	37.18	195	287	Average
5438.48	51.85	51.09	74	-22.15	31.55	6.34	37.13	195	287	Peak
*5469.52	49.95	49.12	68.2	-18.25	31.57	6.34	37.08	195	287	Peak
5580	93.11	92.07			31.71	6.49	37.16	195	287	Average
5580	101.82	100.78			31.71	6.49	37.16	195	287	Peak
*5724.2	50.65	49.43	68.2	-17.55	31.96	6.69	37.43	195	287	Peak
11160	44.05	47.77	54	-9.95	40.1	9.57	53.39	100	88	Average
11160	54.51	58.23	74	-19.49	40.1	9.57	53.39	100	88	Peak

Remarks:

- Emission Level = Read Level + Antenna Factor + Cable Loss - Preamp Factor
Margin value = Emission level – Limit value
- 5580 MHz: Fundamental Frequency
- *: Out of Restricted Band

EUT Test Condition		Measurement Detail	
Channel	Channel 140	Frequency Range	1 GHz ~ 40 GHz
Input Power	120 Vac, 60 Hz	Detector Function	Peak (PK) Average (AV)
Environmental Conditions	25 deg. C, 65 % RH	Tested By	Getaz Yang

Antenna Polarity & Test Distance: Horizontal at 3 m										
Frequency (MHz)	Emission Level (dBuV/m)	Read Level (dBuV)	Limit (dBuV/m)	Margin (dB)	Antenna Factor (dB/m)	Cable Loss (dB)	Preamp Factor (dB)	Antenna Height (cm)	Table Angle (Degree)	Remark
5427.44	51.11	50.39	74	-22.89	31.53	6.32	37.13	206	245	Peak
5454.96	38.78	37.96	54	-15.22	31.56	6.34	37.08	206	245	Average
*5470.64	50.67	49.84	68.2	-17.53	31.57	6.34	37.08	206	245	Peak
5700	87.7	86.51			31.9	6.69	37.4	206	245	Average
5700	97.56	96.37			31.9	6.69	37.4	206	245	Peak
*5725.24	52.24	50.96	68.2	-15.96	31.96	6.75	37.43	206	245	Peak
11400	45.5	47.76	54	-8.5	39.96	9.91	52.13	105	225	Average
11400	56.4	58.66	74	-17.6	39.96	9.91	52.13	105	225	Peak

Antenna Polarity & Test Distance: Vertical at 3 m										
Frequency (MHz)	Emission Level (dBuV/m)	Read Level (dBuV)	Limit (dBuV/m)	Margin (dB)	Antenna Factor (dB/m)	Cable Loss (dB)	Preamp Factor (dB)	Antenna Height (cm)	Table Angle (Degree)	Remark
5384.08	51.11	50.47	74	-22.89	31.51	6.31	37.18	196	287	Peak
5444.72	38.88	38.12	54	-15.12	31.55	6.34	37.13	196	287	Average
*5468.24	49.24	48.41	68.2	-18.96	31.57	6.34	37.08	196	287	Peak
5700	92.94	91.75			31.9	6.69	37.4	196	287	Average
5700	102.33	101.14			31.9	6.69	37.4	196	287	Peak
*5725.4	58.44	57.16	68.2	-9.76	31.96	6.75	37.43	196	287	Peak
11400	45.5	47.76	54	-8.5	39.96	9.91	52.13	100	95	Average
11400	55.61	57.87	74	-18.39	39.96	9.91	52.13	100	95	Peak

Remarks:

- Emission Level = Read Level + Antenna Factor + Cable Loss - Preamp Factor
Margin value = Emission level – Limit value
- 5700 MHz: Fundamental Frequency
- *: Out of Restricted Band

EUT Test Condition		Measurement Detail	
Channel	Channel 149	Frequency Range	1 GHz ~ 40 GHz
Input Power	120 Vac, 60 Hz	Detector Function	Peak (PK) Average (AV)
Environmental Conditions	25 deg. C, 65 % RH	Tested By	Getaz Yang

<Spurious Emission>

Antenna Polarity & Test Distance: Horizontal at 3 m										
Frequency (MHz)	Emission Level (dBuV/m)	Read Level (dBuV)	Limit (dBuV/m)	Margin (dB)	Antenna Factor (dB/m)	Cable Loss (dB)	Preamp Factor (dB)	Antenna Height (cm)	Table Angle (Degree)	Remark
5745	94.93	93.66			31.99	6.75	37.47	202	239	Average
5745	104.2	102.93			31.99	6.75	37.47	202	239	Peak
11490	44.61	47.5	54	-9.39	39.91	10.03	52.83	100	162	Average
11490	53.92	56.81	74	-20.08	39.91	10.03	52.83	100	162	Peak
Antenna Polarity & Test Distance: Vertical at 3 m										
Frequency (MHz)	Emission Level (dBuV/m)	Read Level (dBuV)	Limit (dBuV/m)	Margin (dB)	Antenna Factor (dB/m)	Cable Loss (dB)	Preamp Factor (dB)	Antenna Height (cm)	Table Angle (Degree)	Remark
5745	90.61	89.34			31.99	6.75	37.47	153	167	Average
5745	99.76	98.49			31.99	6.75	37.47	153	167	Peak
11490	44.92	47.81	54	-9.08	39.91	10.03	52.83	100	159	Average
11490	54.67	57.56	74	-19.33	39.91	10.03	52.83	100	159	Peak

<Out of Band Emission (OOBE)>

Antenna Polarity & Test Distance: Horizontal at 3 m										
Frequency (MHz)	Emission Level (dBuV/m)	Read Level (dBuV)	Limit (dBuV/m)	Margin (dB)	Antenna Factor (dB/m)	Cable Loss (dB)	Preamp Factor (dB)	Antenna Height (cm)	Table Angle (Degree)	Remark
*5626	51.57	50.44	68.2	-16.63	31.79	6.56	37.22	202	239	Peak
5654.025	51.38	50.25	71.19	-19.81	31.85	6.62	37.34	202	239	Peak
5912.9	51.57	49.8	77.13	-25.56	32.26	7.01	37.5	202	239	Peak
*5943.3	52.59	50.69	68.2	-15.61	32.32	7.08	37.5	202	239	Peak
Antenna Polarity & Test Distance: Vertical at 3 m										
Frequency (MHz)	Emission Level (dBuV/m)	Read Level (dBuV)	Limit (dBuV/m)	Margin (dB)	Antenna Factor (dB/m)	Cable Loss (dB)	Preamp Factor (dB)	Antenna Height (cm)	Table Angle (Degree)	Remark
*5638.825	50.93	49.83	68.2	-17.27	31.82	6.56	37.28	153	167	Peak
5655.45	50.06	48.93	72.25	-22.19	31.85	6.62	37.34	153	167	Peak
5920.5	51.24	49.47	71.52	-20.28	32.26	7.01	37.5	153	167	Peak
*5960.4	52.61	50.7	68.2	-15.59	32.34	7.08	37.51	153	167	Peak

Remarks:

- Emission Level = Read Level + Antenna Factor + Cable Loss - Preamp Factor
Margin value = Emission level – Limit value
- 5745 MHz: Fundamental Frequency
- *: Out of Restricted Band

EUT Test Condition		Measurement Detail	
Channel	Channel 157	Frequency Range	1 GHz ~ 40 GHz
Input Power	120 Vac, 60 Hz	Detector Function	Peak (PK) Average (AV)
Environmental Conditions	25 deg. C, 65 % RH	Tested By	Getaz Yang

<Spurious Emission>

Antenna Polarity & Test Distance: Horizontal at 3 m										
Frequency (MHz)	Emission Level (dBuV/m)	Read Level (dBuV)	Limit (dBuV/m)	Margin (dB)	Antenna Factor (dB/m)	Cable Loss (dB)	Preamp Factor (dB)	Antenna Height (cm)	Table Angle (Degree)	Remark
5785	95.47	94.15			32.04	6.82	37.54	202	241	Average
5785	104.35	103.03			32.04	6.82	37.54	202	241	Peak
11565	44	47.34	54	-10	39.81	10.09	53.24	100	111	Average
11565	53.31	56.65	74	-20.69	39.81	10.09	53.24	100	111	Peak
Antenna Polarity & Test Distance: Vertical at 3 m										
Frequency (MHz)	Emission Level (dBuV/m)	Read Level (dBuV)	Limit (dBuV/m)	Margin (dB)	Antenna Factor (dB/m)	Cable Loss (dB)	Preamp Factor (dB)	Antenna Height (cm)	Table Angle (Degree)	Remark
5785	90.79	89.47			32.04	6.82	37.54	153	166	Average
5785	99.33	98.01			32.04	6.82	37.54	153	166	Peak
11570	44.22	47.68	54	-9.78	39.78	10.09	53.33	100	155	Average
11570	54.51	57.97	74	-19.49	39.78	10.09	53.33	100	155	Peak

<Out of Band Emission (OOBE)>

Antenna Polarity & Test Distance: Horizontal at 3 m										
Frequency (MHz)	Emission Level (dBuV/m)	Read Level (dBuV)	Limit (dBuV/m)	Margin (dB)	Antenna Factor (dB/m)	Cable Loss (dB)	Preamp Factor (dB)	Antenna Height (cm)	Table Angle (Degree)	Remark
*5639.3	52.04	50.94	68.2	-16.16	31.82	6.56	37.28	202	241	Peak
5654.5	49.1	47.97	71.54	-22.44	31.85	6.62	37.34	202	241	Peak
5919.075	51.66	49.89	72.57	-20.91	32.26	7.01	37.5	202	241	Peak
*5959.45	52.24	50.32	68.2	-15.96	32.34	7.08	37.5	202	241	Peak
Antenna Polarity & Test Distance: Vertical at 3 m										
Frequency (MHz)	Emission Level (dBuV/m)	Read Level (dBuV)	Limit (dBuV/m)	Margin (dB)	Antenna Factor (dB/m)	Cable Loss (dB)	Preamp Factor (dB)	Antenna Height (cm)	Table Angle (Degree)	Remark
*5598.925	51.24	50.14	68.2	-16.96	31.77	6.49	37.16	153	166	Peak
5654.025	50.24	49.11	71.19	-20.95	31.85	6.62	37.34	153	166	Peak
5918.125	51.28	49.51	73.27	-21.99	32.26	7.01	37.5	153	166	Peak
*5980.825	52.2	50.26	68.2	-16	32.37	7.08	37.51	153	166	Peak

Remarks:

- Emission Level = Read Level + Antenna Factor + Cable Loss - Preamp Factor
Margin value = Emission level – Limit value
- 5785 MHz: Fundamental Frequency
- *: Out of Restricted Band

EUT Test Condition		Measurement Detail	
Channel	Channel 165	Frequency Range	1 GHz ~ 40 GHz
Input Power	120 Vac, 60 Hz	Detector Function	Peak (PK) Average (AV)
Environmental Conditions	25 deg. C, 65 % RH	Tested By	Getaz Yang

<Spurious Emission>

Antenna Polarity & Test Distance: Horizontal at 3 m										
Frequency (MHz)	Emission Level (dBuV/m)	Read Level (dBuV)	Limit (dBuV/m)	Margin (dB)	Antenna Factor (dB/m)	Cable Loss (dB)	Preamp Factor (dB)	Antenna Height (cm)	Table Angle (Degree)	Remark
5825	97.21	95.74			32.12	6.88	37.53	202	241	Average
5825	104.84	103.37			32.12	6.88	37.53	202	241	Peak
11650	43.7	47.25	54	-10.3	39.65	10.15	53.35	100	117	Average
11650	53.82	57.37	74	-20.18	39.65	10.15	53.35	100	117	Peak
Antenna Polarity & Test Distance: Vertical at 3 m										
Frequency (MHz)	Emission Level (dBuV/m)	Read Level (dBuV)	Limit (dBuV/m)	Margin (dB)	Antenna Factor (dB/m)	Cable Loss (dB)	Preamp Factor (dB)	Antenna Height (cm)	Table Angle (Degree)	Remark
5825	91.26	89.79			32.12	6.88	37.53	153	166	Average
5825	99.86	98.39			32.12	6.88	37.53	153	166	Peak
11650	44.37	47.92	54	-9.63	39.65	10.15	53.35	100	192	Average
11650	54.74	58.29	74	-19.26	39.65	10.15	53.35	100	192	Peak

<Out of Band Emission (OOBE)>

Antenna Polarity & Test Distance: Horizontal at 3 m										
Frequency (MHz)	Emission Level (dBuV/m)	Read Level (dBuV)	Limit (dBuV/m)	Margin (dB)	Antenna Factor (dB/m)	Cable Loss (dB)	Preamp Factor (dB)	Antenna Height (cm)	Table Angle (Degree)	Remark
*5632.175	51.06	49.99	68.2	-17.14	31.79	6.56	37.28	202	241	Peak
5657.825	51.08	49.95	74.01	-22.93	31.85	6.62	37.34	202	241	Peak
5913.85	52.19	50.42	76.42	-24.23	32.26	7.01	37.5	202	241	Peak
*5944.725	52.99	51.09	68.2	-15.21	32.32	7.08	37.5	202	241	Peak
Antenna Polarity & Test Distance: Vertical at 3 m										
Frequency (MHz)	Emission Level (dBuV/m)	Read Level (dBuV)	Limit (dBuV/m)	Margin (dB)	Antenna Factor (dB/m)	Cable Loss (dB)	Preamp Factor (dB)	Antenna Height (cm)	Table Angle (Degree)	Remark
*5605.575	51.35	50.24	68.2	-16.85	31.77	6.56	37.22	153	166	Peak
5654.5	49.28	48.15	71.54	-22.26	31.85	6.62	37.34	153	166	Peak
5919.075	51.41	49.64	72.57	-21.16	32.26	7.01	37.5	153	166	Peak
*5933.8	51.75	49.95	68.2	-16.45	32.29	7.01	37.5	153	166	Peak

Remarks:

- Emission Level = Read Level + Antenna Factor + Cable Loss - Preamp Factor
Margin value = Emission level – Limit value
- 5825 MHz: Fundamental Frequency
- *: Out of Restricted Band

802.11n (HT40)

EUT Test Condition		Measurement Detail	
Channel	Channel 38	Frequency Range	1 GHz ~ 40 GHz
Input Power	120 Vac, 60 Hz	Detector Function	Peak (PK) Average (AV)
Environmental Conditions	25 deg. C, 65 % RH	Tested By	Getaz Yang

Antenna Polarity & Test Distance: Horizontal at 3 m

Frequency (MHz)	Emission Level (dBuV/m)	Read Level (dBuV)	Limit (dBuV/m)	Margin (dB)	Antenna Factor (dB/m)	Cable Loss (dB)	Preamp Factor (dB)	Antenna Height (cm)	Table Angle (Degree)	Remark
5147.15	58.07	57.87	74	-15.93	31.32	6.2	37.32	200	252	Peak
5149.4	42.52	42.32	54	-11.48	31.32	6.2	37.32	200	252	Average
5190	83.45	83.22			31.35	6.22	37.34	200	252	Average
5190	92.27	92.04			31.35	6.22	37.34	200	252	Peak
5425.35	39.37	38.65	54	-14.63	31.53	6.32	37.13	200	252	Average
5454.83	50.99	50.17	74	-23.01	31.56	6.34	37.08	200	252	Peak
*10380	53.18	57.17	68.2	-15.02	39.21	9.05	52.25	112	231	Peak

Antenna Polarity & Test Distance: Vertical at 3 m

Frequency (MHz)	Emission Level (dBuV/m)	Read Level (dBuV)	Limit (dBuV/m)	Margin (dB)	Antenna Factor (dB/m)	Cable Loss (dB)	Preamp Factor (dB)	Antenna Height (cm)	Table Angle (Degree)	Remark
5147	65.79	65.59	74	-8.21	31.32	6.2	37.32	200	275	Peak
5150	49.23	49.03	54	-4.77	31.32	6.2	37.32	200	275	Average
5190	90.04	89.81			31.35	6.22	37.34	200	275	Average
5190	98.64	98.41			31.35	6.22	37.34	200	275	Peak
5447.02	50.94	50.17	74	-23.06	31.56	6.34	37.13	200	275	Peak
5448.56	39.16	38.39	54	-14.84	31.56	6.34	37.13	200	275	Average
*10380	52.22	56.21	68.2	-15.98	39.21	9.05	52.25	136	154	Peak

Remarks:

- Emission Level = Read Level + Antenna Factor + Cable Loss - Preamp Factor
Margin value = Emission level – Limit value
- 5190 MHz: Fundamental Frequency
- *: Out of Restricted Band

EUT Test Condition		Measurement Detail	
Channel	Channel 46	Frequency Range	1 GHz ~ 40 GHz
Input Power	120 Vac, 60 Hz	Detector Function	Peak (PK) Average (AV)
Environmental Conditions	25 deg. C, 65 % RH	Tested By	Getaz Yang

Antenna Polarity & Test Distance: Horizontal at 3 m										
Frequency (MHz)	Emission Level (dBuV/m)	Read Level (dBuV)	Limit (dBuV/m)	Margin (dB)	Antenna Factor (dB/m)	Cable Loss (dB)	Preamp Factor (dB)	Antenna Height (cm)	Table Angle (Degree)	Remark
5031.5	50.31	50.17	74	-23.69	31.23	6.15	37.24	208	252	Peak
5125.1	38.98	38.78	54	-15.02	31.31	6.19	37.3	208	252	Average
5230	83.01	82.7			31.39	6.24	37.32	208	252	Average
5230	92.17	91.86			31.39	6.24	37.32	208	252	Peak
5444.49	50.82	50.06	74	-23.18	31.55	6.34	37.13	208	252	Peak
5448.12	39.17	38.4	54	-14.83	31.56	6.34	37.13	208	252	Average
*10460	52.61	56.8	68.2	-15.59	39.32	9.09	52.6	117	239	Peak
Antenna Polarity & Test Distance: Vertical at 3 m										
Frequency (MHz)	Emission Level (dBuV/m)	Read Level (dBuV)	Limit (dBuV/m)	Margin (dB)	Antenna Factor (dB/m)	Cable Loss (dB)	Preamp Factor (dB)	Antenna Height (cm)	Table Angle (Degree)	Remark
5144	39.39	39.19	54	-14.61	31.32	6.2	37.32	200	288	Average
5149.85	53.26	53.06	74	-20.74	31.32	6.2	37.32	200	288	Peak
5230	89.93	89.62			31.39	6.24	37.32	200	288	Average
5230	98.91	98.6			31.39	6.24	37.32	200	288	Peak
5351.43	39.44	38.85	54	-14.56	31.48	6.29	37.18	200	288	Average
5426.78	51.39	50.67	74	-22.61	31.53	6.32	37.13	200	288	Peak
*10460	52.41	56.6	68.2	-15.79	39.32	9.09	52.6	132	156	Peak

Remarks:

- Emission Level = Read Level + Antenna Factor + Cable Loss - Preamp Factor
Margin value = Emission level – Limit value
- 5230 MHz: Fundamental Frequency
- *: Out of Restricted Band

EUT Test Condition		Measurement Detail	
Channel	Channel 54	Frequency Range	1 GHz ~ 40 GHz
Input Power	120 Vac, 60 Hz	Detector Function	Peak (PK) Average (AV)
Environmental Conditions	25 deg. C, 65 % RH	Tested By	Getaz Yang

Antenna Polarity & Test Distance: Horizontal at 3 m										
Frequency (MHz)	Emission Level (dBuV/m)	Read Level (dBuV)	Limit (dBuV/m)	Margin (dB)	Antenna Factor (dB/m)	Cable Loss (dB)	Preamp Factor (dB)	Antenna Height (cm)	Table Angle (Degree)	Remark
5133.5	51.66	51.45	74	-22.34	31.31	6.2	37.3	201	255	Peak
5149.85	38.78	38.58	54	-15.22	31.32	6.2	37.32	201	255	Average
5270	85.64	85.25			31.41	6.25	37.27	201	255	Average
5270	95.11	94.72			31.41	6.25	37.27	201	255	Peak
5350.55	39.34	38.75	54	-14.66	31.48	6.29	37.18	201	255	Average
5354.29	51.93	51.34	74	-22.07	31.48	6.29	37.18	201	255	Peak
*10540	51.96	56.07	68.2	-16.24	39.46	9.12	52.69	122	221	Peak
Antenna Polarity & Test Distance: Vertical at 3 m										
Frequency (MHz)	Emission Level (dBuV/m)	Read Level (dBuV)	Limit (dBuV/m)	Margin (dB)	Antenna Factor (dB/m)	Cable Loss (dB)	Preamp Factor (dB)	Antenna Height (cm)	Table Angle (Degree)	Remark
5058.95	50.92	50.75	74	-23.08	31.25	6.17	37.25	193	290	Peak
5149.55	39.22	39.02	54	-14.78	31.32	6.2	37.32	193	290	Average
5270	90.35	89.96			31.41	6.25	37.27	193	290	Average
5270	98.97	98.58			31.41	6.25	37.27	193	290	Peak
5351.98	40.44	39.85	54	-13.56	31.48	6.29	37.18	193	290	Average
5352.86	56.33	55.74	74	-17.67	31.48	6.29	37.18	193	290	Peak
*10540	54.12	58.23	68.2	-14.08	39.46	9.12	52.69	111	87	Peak

Remarks:

- Emission Level = Read Level + Antenna Factor + Cable Loss - Preamp Factor
Margin value = Emission level – Limit value
- 5270 MHz: Fundamental Frequency
- *: Out of Restricted Band

EUT Test Condition		Measurement Detail	
Channel	Channel 62	Frequency Range	1 GHz ~ 40 GHz
Input Power	120 Vac, 60 Hz	Detector Function	Peak (PK) Average (AV)
Environmental Conditions	25 deg. C, 65 % RH	Tested By	Getaz Yang

Antenna Polarity & Test Distance: Horizontal at 3 m										
Frequency (MHz)	Emission Level (dBuV/m)	Read Level (dBuV)	Limit (dBuV/m)	Margin (dB)	Antenna Factor (dB/m)	Cable Loss (dB)	Preamp Factor (dB)	Antenna Height (cm)	Table Angle (Degree)	Remark
5018.15	50.75	50.63	74	-23.25	31.21	6.15	37.24	201	248	Peak
5134.4	38.78	38.57	54	-15.22	31.31	6.2	37.3	201	248	Average
5310	85.41	84.88			31.45	6.27	37.19	201	248	Average
5310	95.64	95.11			31.45	6.27	37.19	201	248	Peak
5350	43.46	42.87	54	-10.54	31.48	6.29	37.18	201	248	Average
5350.88	63.61	63.02	74	-10.39	31.48	6.29	37.18	201	248	Peak
10620	44.15	47.74	54	-9.85	39.59	9.16	52.34	127	217	Average
10620	55.28	58.87	74	-18.72	39.59	9.16	52.34	127	217	Peak

Antenna Polarity & Test Distance: Vertical at 3 m										
Frequency (MHz)	Emission Level (dBuV/m)	Read Level (dBuV)	Limit (dBuV/m)	Margin (dB)	Antenna Factor (dB/m)	Cable Loss (dB)	Preamp Factor (dB)	Antenna Height (cm)	Table Angle (Degree)	Remark
5001.65	50.8	50.7	74	-23.2	31.2	6.13	37.23	195	289	Peak
5145.2	38.87	38.67	54	-15.13	31.32	6.2	37.32	195	289	Average
5310	90.84	90.31			31.45	6.27	37.19	195	289	Average
5310	99.62	99.09			31.45	6.27	37.19	195	289	Peak
5350	46.35	45.76	54	-7.65	31.48	6.29	37.18	195	289	Average
5351.21	63.22	62.63	74	-10.78	31.48	6.29	37.18	195	289	Peak
10620	43.77	47.36	54	-10.23	39.59	9.16	52.34	113	89	Average
10620	54.54	58.13	74	-19.46	39.59	9.16	52.34	113	89	Peak

Remarks:

- Emission Level = Read Level + Antenna Factor + Cable Loss - Preamp Factor
Margin value = Emission level – Limit value
- 5310 MHz: Fundamental Frequency

EUT Test Condition		Measurement Detail	
Channel	Channel 102	Frequency Range	1 GHz ~ 40 GHz
Input Power	120 Vac, 60 Hz	Detector Function	Peak (PK) Average (AV)
Environmental Conditions	25 deg. C, 65 % RH	Tested By	Getaz Yang

Antenna Polarity & Test Distance: Horizontal at 3 m										
Frequency (MHz)	Emission Level (dBuV/m)	Read Level (dBuV)	Limit (dBuV/m)	Margin (dB)	Antenna Factor (dB/m)	Cable Loss (dB)	Preamp Factor (dB)	Antenna Height (cm)	Table Angle (Degree)	Remark
5457.04	53.62	52.8	74	-20.38	31.56	6.34	37.08	203	246	Peak
5460.08	40.69	39.87	54	-13.31	31.56	6.34	37.08	203	246	Average
*5469.68	56.75	55.92	68.2	-11.45	31.57	6.34	37.08	203	246	Peak
5510	86.02	85.12			31.6	6.36	37.06	203	246	Average
5510	96.09	95.19			31.6	6.36	37.06	203	246	Peak
*5724.6	50.43	49.21	68.2	-17.77	31.96	6.69	37.43	203	246	Peak
11020	43.7	47.65	54	-10.3	40.19	9.35	53.49	101	225	Average
11020	53.66	57.61	74	-20.34	40.19	9.35	53.49	101	225	Peak

Antenna Polarity & Test Distance: Vertical at 3 m										
Frequency (MHz)	Emission Level (dBuV/m)	Read Level (dBuV)	Limit (dBuV/m)	Margin (dB)	Antenna Factor (dB/m)	Cable Loss (dB)	Preamp Factor (dB)	Antenna Height (cm)	Table Angle (Degree)	Remark
5455.44	59.81	58.99	74	-14.19	31.56	6.34	37.08	200	287	Peak
5460.08	42.81	41.99	54	-11.19	31.56	6.34	37.08	200	287	Average
*5469.2	61.19	60.36	68.2	-7.01	31.57	6.34	37.08	200	287	Peak
5510	90.76	89.86			31.6	6.36	37.06	200	287	Average
5510	100.1	99.2			31.6	6.36	37.06	200	287	Peak
*5725.88	51.62	50.34	68.2	-16.58	31.96	6.75	37.43	200	287	Peak
11020	43.89	47.84	54	-10.11	40.19	9.35	53.49	100	97	Average
11020	53.41	57.36	74	-20.59	40.19	9.35	53.49	100	97	Peak

Remarks:

- Emission Level = Read Level + Antenna Factor + Cable Loss - Preamp Factor
Margin value = Emission level – Limit value
- 5510 MHz: Fundamental Frequency
- *: Out of Restricted Band

EUT Test Condition		Measurement Detail	
Channel	Channel 110	Frequency Range	1 GHz ~ 40 GHz
Input Power	120 Vac, 60 Hz	Detector Function	Peak (PK) Average (AV)
Environmental Conditions	25 deg. C, 65 % RH	Tested By	Getaz Yang

Antenna Polarity & Test Distance: Horizontal at 3 m										
Frequency (MHz)	Emission Level (dBuV/m)	Read Level (dBuV)	Limit (dBuV/m)	Margin (dB)	Antenna Factor (dB/m)	Cable Loss (dB)	Preamp Factor (dB)	Antenna Height (cm)	Table Angle (Degree)	Remark
5453.68	52.27	51.45	74	-21.73	31.56	6.34	37.08	205	245	Peak
5455.6	39.73	38.91	54	-14.27	31.56	6.34	37.08	205	245	Average
*5469.68	51.23	50.4	68.2	-16.97	31.57	6.34	37.08	205	245	Peak
5550	87.13	86.12			31.68	6.42	37.09	205	245	Average
5550	96.42	95.41			31.68	6.42	37.09	205	245	Peak
*5725.16	50.7	49.42	68.2	-17.5	31.96	6.75	37.43	205	245	Peak
11100	43.79	47.8	54	-10.21	40.14	9.46	53.61	103	238	Average
11100	54.37	58.38	74	-19.63	40.14	9.46	53.61	103	238	Peak

Antenna Polarity & Test Distance: Vertical at 3 m										
Frequency (MHz)	Emission Level (dBuV/m)	Read Level (dBuV)	Limit (dBuV/m)	Margin (dB)	Antenna Factor (dB/m)	Cable Loss (dB)	Preamp Factor (dB)	Antenna Height (cm)	Table Angle (Degree)	Remark
5421.04	52.37	51.7	74	-21.63	31.53	6.32	37.18	203	286	Peak
5458.96	40.24	39.42	54	-13.76	31.56	6.34	37.08	203	286	Average
*5470.48	51.19	50.36	68.2	-17.01	31.57	6.34	37.08	203	286	Peak
5550	90.69	89.68			31.68	6.42	37.09	203	286	Average
5550	99.89	98.88			31.68	6.42	37.09	203	286	Peak
*5725.8	50.94	49.66	68.2	-17.26	31.96	6.75	37.43	203	286	Peak
11100	43.84	47.85	54	-10.16	40.14	9.46	53.61	101	94	Average
11100	52.99	57	74	-21.01	40.14	9.46	53.61	101	94	Peak

Remarks:

- Emission Level = Read Level + Antenna Factor + Cable Loss - Preamp Factor
Margin value = Emission level – Limit value
- 5550 MHz: Fundamental Frequency
- *: Out of Restricted Band

EUT Test Condition		Measurement Detail	
Channel	Channel 134	Frequency Range	1 GHz ~ 40 GHz
Input Power	120 Vac, 60 Hz	Detector Function	Peak (PK) Average (AV)
Environmental Conditions	25 deg. C, 65 % RH	Tested By	Getaz Yang

Antenna Polarity & Test Distance: Horizontal at 3 m										
Frequency (MHz)	Emission Level (dBuV/m)	Read Level (dBuV)	Limit (dBuV/m)	Margin (dB)	Antenna Factor (dB/m)	Cable Loss (dB)	Preamp Factor (dB)	Antenna Height (cm)	Table Angle (Degree)	Remark
5453.2	39.14	38.32	54	-14.86	31.56	6.34	37.08	197	248	Average
5456.56	51.42	50.6	74	-22.58	31.56	6.34	37.08	197	248	Peak
*5470.64	50.5	49.67	68.2	-17.7	31.57	6.34	37.08	197	248	Peak
5670	86.29	85.13			31.88	6.62	37.34	197	248	Average
5670	96.35	95.19			31.88	6.62	37.34	197	248	Peak
*5725.56	52.06	50.78	68.2	-16.14	31.96	6.75	37.43	197	248	Peak
11340	44.85	47.56	54	-9.15	40	9.8	52.51	103	226	Average
11340	54.66	57.37	74	-19.34	40	9.8	52.51	103	226	Peak

Antenna Polarity & Test Distance: Vertical at 3 m										
Frequency (MHz)	Emission Level (dBuV/m)	Read Level (dBuV)	Limit (dBuV/m)	Margin (dB)	Antenna Factor (dB/m)	Cable Loss (dB)	Preamp Factor (dB)	Antenna Height (cm)	Table Angle (Degree)	Remark
5403.28	51.56	50.9	74	-22.44	31.52	6.32	37.18	204	286	Peak
5459.12	39.47	38.65	54	-14.53	31.56	6.34	37.08	204	286	Average
*5469.36	50.48	49.65	68.2	-17.72	31.57	6.34	37.08	204	286	Peak
5670	91.36	90.2			31.88	6.62	37.34	204	286	Average
5670	100.55	99.39			31.88	6.62	37.34	204	286	Peak
*5724.28	57.5	56.28	68.2	-10.7	31.96	6.69	37.43	204	286	Peak
11340	45.08	47.79	54	-8.92	40	9.8	52.51	101	96	Average
11340	55.16	57.87	74	-18.84	40	9.8	52.51	101	96	Peak

Remarks:

- Emission Level = Read Level + Antenna Factor + Cable Loss - Preamp Factor
Margin value = Emission level – Limit value
- 5670 MHz: Fundamental Frequency
- *: Out of Restricted Band

EUT Test Condition		Measurement Detail	
Channel	Channel 151	Frequency Range	1 GHz ~ 40 GHz
Input Power	120 Vac, 60 Hz	Detector Function	Peak (PK) Average (AV)
Environmental Conditions	25 deg. C, 65 % RH	Tested By	Getaz Yang

<Spurious Emission>

Antenna Polarity & Test Distance: Horizontal at 3 m										
Frequency (MHz)	Emission Level (dBuV/m)	Read Level (dBuV)	Limit (dBuV/m)	Margin (dB)	Antenna Factor (dB/m)	Cable Loss (dB)	Preamp Factor (dB)	Antenna Height (cm)	Table Angle (Degree)	Remark
5755	94.03	92.74			32.01	6.75	37.47	202	242	Average
5755	102.58	101.29			32.01	6.75	37.47	202	242	Peak
11510	44.18	47.32	54	-9.82	39.9	10.03	53.07	100	112	Average
11510	53.53	56.67	74	-20.47	39.9	10.03	53.07	100	112	Peak
Antenna Polarity & Test Distance: Vertical at 3 m										
Frequency (MHz)	Emission Level (dBuV/m)	Read Level (dBuV)	Limit (dBuV/m)	Margin (dB)	Antenna Factor (dB/m)	Cable Loss (dB)	Preamp Factor (dB)	Antenna Height (cm)	Table Angle (Degree)	Remark
5755	88.15	86.86			32.01	6.75	37.47	153	162	Average
5755	96.74	95.45			32.01	6.75	37.47	153	162	Peak
11510	44.52	47.66	54	-9.48	39.9	10.03	53.07	100	103	Average
11510	54.21	57.35	74	-19.79	39.9	10.03	53.07	100	103	Peak

<Out of Band Emission (OOBE)>

Antenna Polarity & Test Distance: Horizontal at 3 m										
Frequency (MHz)	Emission Level (dBuV/m)	Read Level (dBuV)	Limit (dBuV/m)	Margin (dB)	Antenna Factor (dB/m)	Cable Loss (dB)	Preamp Factor (dB)	Antenna Height (cm)	Table Angle (Degree)	Remark
*5600.35	52.26	51.09	68.2	-15.94	31.77	6.56	37.16	202	242	Peak
5656.875	49.86	48.73	73.31	-23.45	31.85	6.62	37.34	202	242	Peak
5921.45	50.84	49.07	70.82	-19.98	32.26	7.01	37.5	202	242	Peak
*5983.675	52.65	50.71	68.2	-15.55	32.37	7.08	37.51	202	242	Peak
Antenna Polarity & Test Distance: Vertical at 3 m										
Frequency (MHz)	Emission Level (dBuV/m)	Read Level (dBuV)	Limit (dBuV/m)	Margin (dB)	Antenna Factor (dB/m)	Cable Loss (dB)	Preamp Factor (dB)	Antenna Height (cm)	Table Angle (Degree)	Remark
*5573.275	51.46	50.38	68.2	-16.74	31.71	6.49	37.12	153	162	Peak
5653.55	49.13	47.94	70.84	-21.71	31.85	6.62	37.28	153	162	Peak
5920.5	50.95	49.18	71.52	-20.57	32.26	7.01	37.5	153	162	Peak
*5959.925	52.35	50.44	68.2	-15.85	32.34	7.08	37.51	153	162	Peak

Remarks:

- Emission Level = Read Level + Antenna Factor + Cable Loss - Preamp Factor
Margin value = Emission level – Limit value
- 5755 MHz: Fundamental Frequency
- *: Out of Restricted Band

EUT Test Condition		Measurement Detail	
Channel	Channel 159	Frequency Range	1 GHz ~ 40 GHz
Input Power	120 Vac, 60 Hz	Detector Function	Peak (PK) Average (AV)
Environmental Conditions	25 deg. C, 65 % RH	Tested By	Getaz Yang

<Spurious Emission>

Antenna Polarity & Test Distance: Horizontal at 3 m										
Frequency (MHz)	Emission Level (dBuV/m)	Read Level (dBuV)	Limit (dBuV/m)	Margin (dB)	Antenna Factor (dB/m)	Cable Loss (dB)	Preamp Factor (dB)	Antenna Height (cm)	Table Angle (Degree)	Remark
5795	93.78	92.43			32.07	6.82	37.54	202	244	Average
5795	102.57	101.22			32.07	6.82	37.54	202	244	Peak
11590	43.9	47.4	54	-10.1	39.74	10.09	53.33	100	114	Average
11590	53.88	57.38	74	-20.12	39.74	10.09	53.33	100	114	Peak
Antenna Polarity & Test Distance: Vertical at 3 m										
Frequency (MHz)	Emission Level (dBuV/m)	Read Level (dBuV)	Limit (dBuV/m)	Margin (dB)	Antenna Factor (dB/m)	Cable Loss (dB)	Preamp Factor (dB)	Antenna Height (cm)	Table Angle (Degree)	Remark
5795	87.44	86.09			32.07	6.82	37.54	153	164	Average
5795	96.7	95.35			32.07	6.82	37.54	153	164	Peak
11590	44.36	47.86	54	-9.64	39.74	10.09	53.33	100	184	Average
11590	54.76	58.26	74	-19.24	39.74	10.09	53.33	100	184	Peak

<Out of Band Emission (OOBE)>

Antenna Polarity & Test Distance: Horizontal at 3 m										
Frequency (MHz)	Emission Level (dBuV/m)	Read Level (dBuV)	Limit (dBuV/m)	Margin (dB)	Antenna Factor (dB/m)	Cable Loss (dB)	Preamp Factor (dB)	Antenna Height (cm)	Table Angle (Degree)	Remark
*5644.525	52.26	51.1	68.2	-15.94	31.82	6.62	37.28	202	244	Peak
5659.25	52.92	51.79	75.07	-22.15	31.85	6.62	37.34	202	244	Peak
5922.875	50.09	48.29	69.77	-19.68	32.29	7.01	37.5	202	244	Peak
*5934.75	53.01	51.21	68.2	-15.19	32.29	7.01	37.5	202	244	Peak
Antenna Polarity & Test Distance: Vertical at 3 m										
Frequency (MHz)	Emission Level (dBuV/m)	Read Level (dBuV)	Limit (dBuV/m)	Margin (dB)	Antenna Factor (dB/m)	Cable Loss (dB)	Preamp Factor (dB)	Antenna Height (cm)	Table Angle (Degree)	Remark
*5614.6	51.23	50.12	68.2	-16.97	31.77	6.56	37.22	153	164	Peak
5653.075	49.45	48.26	70.49	-21.04	31.85	6.62	37.28	153	164	Peak
5920.975	48.68	46.91	71.17	-22.49	32.26	7.01	37.5	153	164	Peak
*5971.8	52.51	50.6	68.2	-15.69	32.34	7.08	37.51	153	164	Peak

Remarks:

- Emission Level = Read Level + Antenna Factor + Cable Loss - Preamp Factor
Margin value = Emission level – Limit value
- 5795 MHz: Fundamental Frequency
- *: Out of Restricted Band

802.11ac (VHT80)

EUT Test Condition		Measurement Detail	
Channel	Channel 42	Frequency Range	1 GHz ~ 40 GHz
Input Power	120 Vac, 60 Hz	Detector Function	Peak (PK) Average (AV)
Environmental Conditions	25 deg. C, 65 % RH	Tested By	Getaz Yang

Antenna Polarity & Test Distance: Horizontal at 3 m

Frequency (MHz)	Emission Level (dBuV/m)	Read Level (dBuV)	Limit (dBuV/m)	Margin (dB)	Antenna Factor (dB/m)	Cable Loss (dB)	Preamp Factor (dB)	Antenna Height (cm)	Table Angle (Degree)	Remark
5148.65	44.97	44.77	54	-9.03	31.32	6.2	37.32	202	251	Average
5150	56.18	55.98	74	-17.82	31.32	6.2	37.32	202	251	Peak
5210	78.13	77.88			31.37	6.24	37.36	202	251	Average
5210	89.31	89.06			31.37	6.24	37.36	202	251	Peak
5381.24	51.21	50.57	74	-22.79	31.51	6.31	37.18	202	251	Peak
5393.12	40.03	39.39	54	-13.97	31.51	6.31	37.18	202	251	Average
*10420	54.19	58.19	68.2	-14.01	39.27	9.09	52.36	111	228	Peak

Antenna Polarity & Test Distance: Vertical at 3 m

Frequency (MHz)	Emission Level (dBuV/m)	Read Level (dBuV)	Limit (dBuV/m)	Margin (dB)	Antenna Factor (dB/m)	Cable Loss (dB)	Preamp Factor (dB)	Antenna Height (cm)	Table Angle (Degree)	Remark
5149.55	58.22	58.02	74	-15.78	31.32	6.2	37.32	200	261	Peak
5150	47.37	47.17	54	-6.63	31.32	6.2	37.32	200	261	Average
5210	85.6	85.35			31.37	6.24	37.36	200	261	Average
5210	94.11	93.86			31.37	6.24	37.36	200	261	Peak
5369.47	51.68	51.06	74	-22.32	31.49	6.31	37.18	200	261	Peak
5393.45	40.56	39.92	54	-13.44	31.51	6.31	37.18	200	261	Average
*10420	52.98	56.98	68.2	-15.22	39.27	9.09	52.36	140	159	Peak

Remarks:

- Emission Level = Read Level + Antenna Factor + Cable Loss - Preamp Factor
Margin value = Emission level – Limit value
- 5210 MHz: Fundamental Frequency
- *: Out of Restricted Band

EUT Test Condition		Measurement Detail	
Channel	Channel 58	Frequency Range	1 GHz ~ 40 GHz
Input Power	120 Vac, 60 Hz	Detector Function	Peak (PK) Average (AV)
Environmental Conditions	25 deg. C, 65 % RH	Tested By	Getaz Yang

Antenna Polarity & Test Distance: Horizontal at 3 m										
Frequency (MHz)	Emission Level (dBuV/m)	Read Level (dBuV)	Limit (dBuV/m)	Margin (dB)	Antenna Factor (dB/m)	Cable Loss (dB)	Preamp Factor (dB)	Antenna Height (cm)	Table Angle (Degree)	Remark
5014.25	38.84	38.71	54	-15.16	31.21	6.15	37.23	192	247	Average
5112.35	51.12	50.92	74	-22.88	31.29	6.19	37.28	192	247	Peak
5290	82.01	81.54			31.43	6.27	37.23	192	247	Average
5290	90.55	90.08			31.43	6.27	37.23	192	247	Peak
5350.11	40.98	40.39	54	-13.02	31.48	6.29	37.18	192	247	Average
5366.72	56.42	55.8	74	-17.58	31.49	6.31	37.18	192	247	Peak
*10580	54.21	57.92	68.2	-13.99	39.54	9.16	52.41	124	214	Peak
Antenna Polarity & Test Distance: Vertical at 3 m										
Frequency (MHz)	Emission Level (dBuV/m)	Read Level (dBuV)	Limit (dBuV/m)	Margin (dB)	Antenna Factor (dB/m)	Cable Loss (dB)	Preamp Factor (dB)	Antenna Height (cm)	Table Angle (Degree)	Remark
5099.9	51.06	50.87	74	-22.94	31.28	6.19	37.28	197	245	Peak
5137.85	39.32	39.11	54	-14.68	31.31	6.2	37.3	197	245	Average
5290	85.02	84.55			31.43	6.27	37.23	197	245	Average
5290	94.09	93.62			31.43	6.27	37.23	197	245	Peak
5350	42.5	41.91	54	-11.5	31.48	6.29	37.18	197	245	Average
5350.55	56.22	55.63	74	-17.78	31.48	6.29	37.18	197	245	Peak
*10580	54.48	58.19	68.2	-13.72	39.54	9.16	52.41	106	92	Peak

Remarks:

- Emission Level = Read Level + Antenna Factor + Cable Loss - Preamp Factor
Margin value = Emission level – Limit value
- 5290 MHz: Fundamental Frequency
- *: Out of Restricted Band

EUT Test Condition		Measurement Detail	
Channel	Channel 106	Frequency Range	1 GHz ~ 40 GHz
Input Power	120 Vac, 60 Hz	Detector Function	Peak (PK) Average (AV)
Environmental Conditions	25 deg. C, 65 % RH	Tested By	Getaz Yang

Antenna Polarity & Test Distance: Horizontal at 3 m										
Frequency (MHz)	Emission Level (dBuV/m)	Read Level (dBuV)	Limit (dBuV/m)	Margin (dB)	Antenna Factor (dB/m)	Cable Loss (dB)	Preamp Factor (dB)	Antenna Height (cm)	Table Angle (Degree)	Remark
5458.16	52.87	52.05	74	-21.13	31.56	6.34	37.08	199	250	Peak
5458.8	40.79	39.97	54	-13.21	31.56	6.34	37.08	199	250	Average
*5470.8	52.7	51.87	68.2	-15.5	31.57	6.34	37.08	199	250	Peak
5530	81.29	80.33			31.63	6.42	37.09	199	250	Average
5530	90.39	89.43			31.63	6.42	37.09	199	250	Peak
*5725.88	50.9	49.62	68.2	-17.3	31.96	6.75	37.43	199	250	Peak
11060	43.54	47.49	54	-10.46	40.16	9.46	53.57	102	229	Average
11060	53.16	57.11	74	-20.84	40.16	9.46	53.57	102	229	Peak

Antenna Polarity & Test Distance: Vertical at 3 m										
Frequency (MHz)	Emission Level (dBuV/m)	Read Level (dBuV)	Limit (dBuV/m)	Margin (dB)	Antenna Factor (dB/m)	Cable Loss (dB)	Preamp Factor (dB)	Antenna Height (cm)	Table Angle (Degree)	Remark
5457.52	55.1	54.28	74	-18.9	31.56	6.34	37.08	203	286	Peak
5459.76	43.3	42.48	54	-10.7	31.56	6.34	37.08	203	286	Average
*5470.96	55.72	54.89	68.2	-12.48	31.57	6.34	37.08	203	286	Peak
5530	85.22	84.26			31.63	6.42	37.09	203	286	Average
5530	94.72	93.76			31.63	6.42	37.09	203	286	Peak
*5724.52	51.71	50.49	68.2	-16.49	31.96	6.69	37.43	203	286	Peak
11060	43.82	47.77	54	-10.18	40.16	9.46	53.57	103	92	Average
11060	52.54	56.49	74	-21.46	40.16	9.46	53.57	103	92	Peak

Remarks:

- Emission Level = Read Level + Antenna Factor + Cable Loss - Preamp Factor
Margin value = Emission level – Limit value
- 5530 MHz: Fundamental Frequency
- *: Out of Restricted Band

EUT Test Condition		Measurement Detail	
Channel	Channel 122	Frequency Range	1 GHz ~ 40 GHz
Input Power	120 Vac, 60 Hz	Detector Function	Peak (PK) Average (AV)
Environmental Conditions	25 deg. C, 65 % RH	Tested By	Getaz Yang

Antenna Polarity & Test Distance: Horizontal at 3 m										
Frequency (MHz)	Emission Level (dBuV/m)	Read Level (dBuV)	Limit (dBuV/m)	Margin (dB)	Antenna Factor (dB/m)	Cable Loss (dB)	Preamp Factor (dB)	Antenna Height (cm)	Table Angle (Degree)	Remark
5369.2	50.51	49.89	74	-23.49	31.49	6.31	37.18	199	247	Peak
5456.24	39.55	38.73	54	-14.45	31.56	6.34	37.08	199	247	Average
*5468.88	49.86	49.03	68.2	-18.34	31.57	6.34	37.08	199	247	Peak
5610	85.73	84.62			31.77	6.56	37.22	199	247	Average
5610	90.73	89.62			31.77	6.56	37.22	199	247	Peak
*5725.64	50.73	49.45	68.2	-17.47	31.96	6.75	37.43	199	247	Peak
11220	44.62	47.89	54	-9.38	40.07	9.69	53.03	105	225	Average
11220	54.36	57.63	74	-19.64	40.07	9.69	53.03	105	225	Peak

Antenna Polarity & Test Distance: Vertical at 3 m										
Frequency (MHz)	Emission Level (dBuV/m)	Read Level (dBuV)	Limit (dBuV/m)	Margin (dB)	Antenna Factor (dB/m)	Cable Loss (dB)	Preamp Factor (dB)	Antenna Height (cm)	Table Angle (Degree)	Remark
5431.12	51.53	50.79	74	-22.47	31.55	6.32	37.13	205	282	Peak
5443.44	39.88	39.12	54	-14.12	31.55	6.34	37.13	205	282	Average
*5470.48	50.19	49.36	68.2	-18.01	31.57	6.34	37.08	205	282	Peak
5610	85.34	84.23			31.77	6.56	37.22	205	282	Average
5610	94.84	93.73			31.77	6.56	37.22	205	282	Peak
*5724.68	51.37	50.15	68.2	-16.83	31.96	6.69	37.43	205	282	Peak
11220	44.5	47.77	54	-9.5	40.07	9.69	53.03	100	89	Average
11220	54.77	58.04	74	-19.23	40.07	9.69	53.03	100	89	Peak

Remarks:

- Emission Level = Read Level + Antenna Factor + Cable Loss - Preamp Factor
Margin value = Emission level – Limit value
- 5610 MHz: Fundamental Frequency
- *: Out of Restricted Band

EUT Test Condition		Measurement Detail	
Channel	Channel 155	Frequency Range	1 GHz ~ 40 GHz
Input Power	120 Vac, 60 Hz	Detector Function	Peak (PK) Average (AV)
Environmental Conditions	25 deg. C, 65 % RH	Tested By	Getaz Yang

<Spurious Emission>

Antenna Polarity & Test Distance: Horizontal at 3 m										
Frequency (MHz)	Emission Level (dBuV/m)	Read Level (dBuV)	Limit (dBuV/m)	Margin (dB)	Antenna Factor (dB/m)	Cable Loss (dB)	Preamp Factor (dB)	Antenna Height (cm)	Table Angle (Degree)	Remark
5775	88.47	87.11			32.04	6.82	37.5	202	242	Average
5775	97.57	96.21			32.04	6.82	37.5	202	242	Peak
11550	43.83	47.17	54	-10.17	39.81	10.09	53.24	100	119	Average
11550	53.48	56.82	74	-20.52	39.81	10.09	53.24	100	119	Peak
Antenna Polarity & Test Distance: Vertical at 3 m										
Frequency (MHz)	Emission Level (dBuV/m)	Read Level (dBuV)	Limit (dBuV/m)	Margin (dB)	Antenna Factor (dB/m)	Cable Loss (dB)	Preamp Factor (dB)	Antenna Height (cm)	Table Angle (Degree)	Remark
5775	82.35	80.99			32.04	6.82	37.5	152	168	Average
5775	91.55	90.19			32.04	6.82	37.5	152	168	Peak
11550	44.4	47.74	54	-9.6	39.81	10.09	53.24	100	201	Average
11550	54.6	57.94	74	-19.4	39.81	10.09	53.24	100	201	Peak

<Out of Band Emission (OOBE)>

Antenna Polarity & Test Distance: Horizontal at 3 m										
Frequency (MHz)	Emission Level (dBuV/m)	Read Level (dBuV)	Limit (dBuV/m)	Margin (dB)	Antenna Factor (dB/m)	Cable Loss (dB)	Preamp Factor (dB)	Antenna Height (cm)	Table Angle (Degree)	Remark
*5639.3	53.31	52.21	68.2	-14.89	31.82	6.56	37.28	202	242	Peak
5653.075	52.4	51.21	70.49	-18.09	31.85	6.62	37.28	202	242	Peak
5917.175	50.16	48.39	73.97	-23.81	32.26	7.01	37.5	202	242	Peak
*5971.8	53.34	51.43	68.2	-14.86	32.34	7.08	37.51	202	242	Peak
Antenna Polarity & Test Distance: Vertical at 3 m										
Frequency (MHz)	Emission Level (dBuV/m)	Read Level (dBuV)	Limit (dBuV/m)	Margin (dB)	Antenna Factor (dB/m)	Cable Loss (dB)	Preamp Factor (dB)	Antenna Height (cm)	Table Angle (Degree)	Remark
*5597.975	51.78	50.71	68.2	-16.42	31.74	6.49	37.16	152	168	Peak
5654.025	48.68	47.55	71.19	-22.51	31.85	6.62	37.34	152	168	Peak
5920.5	49.75	47.98	71.52	-21.77	32.26	7.01	37.5	152	168	Peak
*5952.8	52.62	50.72	68.2	-15.58	32.32	7.08	37.5	152	168	Peak

Remarks:

- Emission Level = Read Level + Antenna Factor + Cable Loss - Preamp Factor
Margin value = Emission level – Limit value
- 5775 MHz: Fundamental Frequency
- *: Out of Restricted Band

9 kHz ~ 30 MHz DATA:

The amplitude of spurious emissions attenuated more than 20 dB below the permissible value is not required to be report.

30 MHz ~ 1 GHz WORST-CASE DATA:

802.11n (HT40)

EUT Test Condition		Measurement Detail	
Channel	Channel 38	Frequency Range	30 MHz ~ 1 GHz
Input Power	120 Vac, 60 Hz	Detector Function	Peak (PK) Quasi-peak (QP)
Environmental Conditions	25 deg. C, 65 % RH	Tested By	Getaz Yang

Antenna Polarity & Test Distance: Horizontal at 3 m										
Frequency (MHz)	Emission Level (dBuV/m)	Read Level (dBuV)	Limit (dBuV/m)	Margin (dB)	Antenna Factor (dB/m)	Cable Loss (dB)	Preamp Factor (dB)	Antenna Height (cm)	Table Angle (Degree)	Remark
41.64	23.7	40.53	40	-16.3	13.56	0.66	31.05	128	221	Peak
69.77	21.43	41.63	40	-18.57	10.77	0.85	31.82	106	94	Peak
127.97	27.28	46.47	43.5	-16.22	11.55	1.14	31.88	114	264	Peak
198.78	30.37	51.41	43.5	-13.13	9.43	1.29	31.76	134	172	Peak
275.41	31.68	49.82	46	-14.32	12.22	1.56	31.92	124	240	Peak
335.55	32.72	49.01	46	-13.28	13.8	1.73	31.82	131	84	Peak
Antenna Polarity & Test Distance: Vertical at 3 m										
Frequency (MHz)	Emission Level (dBuV/m)	Read Level (dBuV)	Limit (dBuV/m)	Margin (dB)	Antenna Factor (dB/m)	Cable Loss (dB)	Preamp Factor (dB)	Antenna Height (cm)	Table Angle (Degree)	Remark
40.67	34.74	51.56	40	-5.26	13.55	0.65	31.02	134	70	Peak
69.77	31.42	51.62	40	-8.58	10.77	0.85	31.82	120	200	Peak
127.97	31.69	50.88	43.5	-11.81	11.55	1.14	31.88	124	245	Peak
188.11	28.02	48.28	43.5	-15.48	10.19	1.25	31.7	128	323	Peak
270.56	28.39	46.77	46	-17.61	12.08	1.55	32.01	136	81	Peak
455.83	27.78	41.32	46	-18.22	16.45	2	31.99	137	162	Peak

Remarks:

1. Emission Level = Read Level + Antenna Factor + Cable Loss - Preamp Factor

Margin value = Emission level – Limit value

802.11n (HT40)

EUT Test Condition		Measurement Detail	
Channel	Channel 62	Frequency Range	30 MHz ~ 1 GHz
Input Power	120 Vac, 60 Hz	Detector Function	Peak (PK) Quasi-peak (QP)
Environmental Conditions	25 deg. C, 65 % RH	Tested By	Getaz Yang

Antenna Polarity & Test Distance: Horizontal at 3 m

Frequency (MHz)	Emission Level (dBuV/m)	Read Level (dBuV)	Limit (dBuV/m)	Margin (dB)	Antenna Factor (dB/m)	Cable Loss (dB)	Preamp Factor (dB)	Antenna Height (cm)	Table Angle (Degree)	Remark
40.67	23.8	40.62	40	-16.2	13.55	0.65	31.02	101	327	Peak
68.8	22	42.03	40	-18	10.89	0.85	31.77	109	243	Peak
133.79	27.66	46.36	43.5	-15.84	11.94	1.14	31.78	120	353	Peak
193.93	30.53	51.2	43.5	-12.97	9.77	1.27	31.71	102	195	Peak
308.39	31.67	48.79	46	-14.33	13.15	1.66	31.93	113	112	Peak
389.87	23.29	38.35	46	-22.71	15.1	1.88	32.04	139	221	Peak

Antenna Polarity & Test Distance: Vertical at 3 m

Frequency (MHz)	Emission Level (dBuV/m)	Read Level (dBuV)	Limit (dBuV/m)	Margin (dB)	Antenna Factor (dB/m)	Cable Loss (dB)	Preamp Factor (dB)	Antenna Height (cm)	Table Angle (Degree)	Remark
41.64	34.44	51.27	40	-5.56	13.56	0.66	31.05	126	274	Peak
68.8	31.86	51.89	40	-8.14	10.89	0.85	31.77	129	356	Peak
127.97	30.9	50.09	43.5	-12.6	11.55	1.14	31.88	110	184	Peak
259.89	27.31	45.87	46	-18.69	11.77	1.52	31.85	103	213	Peak
389.87	26.72	41.78	46	-19.28	15.1	1.88	32.04	108	6	Peak
466.5	27.29	40.54	46	-18.71	16.66	2.02	31.93	123	23	Peak

Remarks:

- Emission Level = Read Level + Antenna Factor + Cable Loss - Preamp Factor
Margin value = Emission level – Limit value

802.11a

EUT Test Condition		Measurement Detail	
Channel	Channel 140	Frequency Range	30 MHz ~ 1 GHz
Input Power	120 Vac, 60 Hz	Detector Function	Peak (PK) Quasi-peak (QP)
Environmental Conditions	25 deg. C, 65 % RH	Tested By	Getaz Yang

Antenna Polarity & Test Distance: Horizontal at 3 m										
Frequency (MHz)	Emission Level (dBuV/m)	Read Level (dBuV)	Limit (dBuV/m)	Margin (dB)	Antenna Factor (dB/m)	Cable Loss (dB)	Preamp Factor (dB)	Antenna Height (cm)	Table Angle (Degree)	Remark
40.67	23.3	40.12	40	-16.7	13.55	0.65	31.02	122	273	Peak
62.98	22.43	41.51	40	-17.57	11.59	0.83	31.5	134	211	Peak
127.97	26.85	46.04	43.5	-16.65	11.55	1.14	31.88	101	325	Peak
198.78	29.61	50.65	43.5	-13.89	9.43	1.29	31.76	131	307	Peak
264.74	31.45	49.94	46	-14.55	11.91	1.54	31.94	135	241	Peak
340.4	33.33	49.5	46	-12.67	13.91	1.74	31.82	103	237	Peak
Antenna Polarity & Test Distance: Vertical at 3 m										
Frequency (MHz)	Emission Level (dBuV/m)	Read Level (dBuV)	Limit (dBuV/m)	Margin (dB)	Antenna Factor (dB/m)	Cable Loss (dB)	Preamp Factor (dB)	Antenna Height (cm)	Table Angle (Degree)	Remark
40.67	34.4	51.22	40	-5.6	13.55	0.65	31.02	125	155	Peak
68.8	31.48	51.51	40	-8.52	10.89	0.85	31.77	130	151	Peak
123.12	31.46	50.98	43.5	-12.04	11.22	1.15	31.89	107	116	Peak
183.26	27.7	47.73	43.5	-15.8	10.53	1.23	31.79	119	358	Peak
258.92	28.17	46.77	46	-17.83	11.74	1.52	31.86	138	124	Peak
461.65	28.83	42.23	46	-17.17	16.56	2.01	31.97	100	64	Peak

Remarks:

- Emission Level = Read Level + Antenna Factor + Cable Loss - Preamp Factor
Margin value = Emission level – Limit value

802.11n (HT20)

EUT Test Condition		Measurement Detail	
Channel	Channel 149	Frequency Range	30 MHz ~ 1 GHz
Input Power	120 Vac, 60 Hz	Detector Function	Peak (PK) Quasi-peak (QP)
Environmental Conditions	25 deg. C, 65 % RH	Tested By	Getaz Yang

Antenna Polarity & Test Distance: Horizontal at 3 m

Frequency (MHz)	Emission Level (dBuV/m)	Read Level (dBuV)	Limit (dBuV/m)	Margin (dB)	Antenna Factor (dB/m)	Cable Loss (dB)	Preamp Factor (dB)	Antenna Height (cm)	Table Angle (Degree)	Remark
41.64	23	39.83	40	-17	13.56	0.66	31.05	126	175	Peak
62.98	21.82	40.9	40	-18.18	11.59	0.83	31.5	138	250	Peak
128.94	26.09	45.22	43.5	-17.41	11.61	1.14	31.88	103	196	Peak
193.93	30.02	50.69	43.5	-13.48	9.77	1.27	31.71	118	76	Peak
264.74	31.53	50.02	46	-14.47	11.91	1.54	31.94	131	239	Peak
347.19	32.52	48.51	46	-13.48	14.08	1.76	31.83	113	97	Peak

Antenna Polarity & Test Distance: Vertical at 3 m

Frequency (MHz)	Emission Level (dBuV/m)	Read Level (dBuV)	Limit (dBuV/m)	Margin (dB)	Antenna Factor (dB/m)	Cable Loss (dB)	Preamp Factor (dB)	Antenna Height (cm)	Table Angle (Degree)	Remark
41.64	33.87	50.7	40	-6.13	13.56	0.66	31.05	112	189	Peak
67.83	30.07	49.95	40	-9.93	11	0.85	31.73	136	68	Peak
127.97	30.31	49.5	43.5	-13.19	11.55	1.14	31.88	127	198	Peak
259.89	27.15	45.71	46	-18.85	11.77	1.52	31.85	123	262	Peak
329.73	27.23	43.66	46	-18.77	13.66	1.72	31.81	121	261	Peak
455.83	27.98	41.52	46	-18.02	16.45	2	31.99	129	92	Peak

Remarks:

- Emission Level = Read Level + Antenna Factor + Cable Loss - Preamp Factor
Margin value = Emission level – Limit value

4.2 Conducted Emission Measurement

4.2.1 Limits of Conducted Emission Measurement

Frequency (MHz)	Conducted Limit (dBuV)	
	Quasi-peak	Average
0.15 - 0.5	66 - 56	56 - 46
0.50 - 5.0	56	46
5.0 - 30.0	60	50

Note: 1. The lower limit shall apply at the transition frequencies.

2. The limit decreases in line with the logarithm of the frequency in the range of 0.15 to 0.50 MHz.

4.2.2 Test Instruments

Description & Manufacturer	Model No.	Serial No.	Date Of Calibration	Due Date Of Calibration
Test Receiver ROHDE & SCHWARZ	ESCI	100613	Nov. 21, 2016	Nov. 20, 2017
RF signal cable (with 10dB PAD) Woken	5D-FB	Cable-cond1-01	Dec. 22, 2016	Dec. 21, 2017
LISN ROHDE & SCHWARZ (EUT)	ESH3-Z5	835239/001	Mar. 10, 2017	Mar. 09, 2018
LISN ROHDE & SCHWARZ (Peripheral)	ESH3-Z5	100311	Jul. 28, 2016	Jul. 27, 2017
Software ADT	BV ADT_Cond_ V7.3.7.3	NA	NA	NA

- Note:**
1. The calibration interval of the above test instruments is 12 months and the calibrations are traceable to NML/ROC and NIST/USA.
 2. The test was performed in HwaYa Shielded Room 1.
 3. The VCCI Site Registration No. is C-2040.

4.2.3 Test Procedures

- a. The EUT was placed 0.4 meters from the conducting wall of the shielded room with EUT being connected to the power mains through a line impedance stabilization network (LISN). Other support units were connected to the power mains through another LISN. The two LISNs provide 50 ohm/ 50uH of coupling impedance for the measuring instrument.
- b. Both lines of the power mains connected to the EUT were checked for maximum conducted interference.
- c. The frequency range from 150 kHz to 30 MHz was searched. Emission levels under (Limit -20 dB) was not recorded.

Note: All modes of operation were investigated and the worst-case emissions are reported.

4.2.4 Deviation from Test Standard

No deviation.

4.2.5 Test Setup

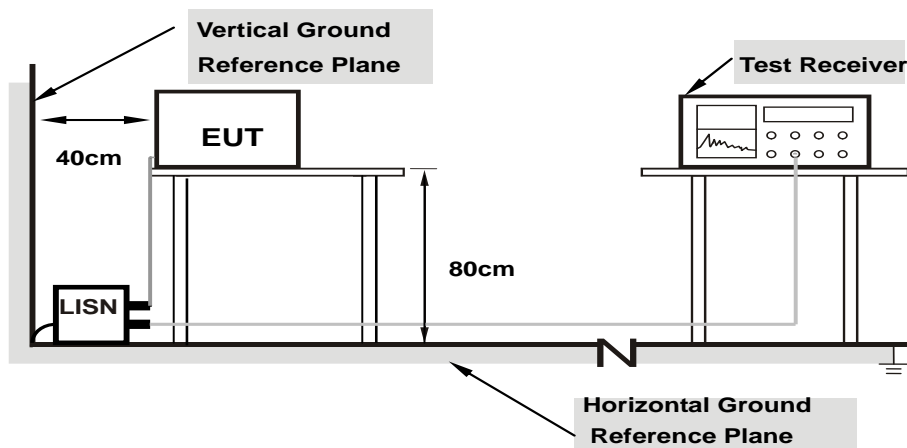

- Note:**
- 1.Support units were connected to second LISN.
 - 2.Both of LISNs (AMN) are 80 cm from EUT and at least 80 from other units and other metal planes

For the actual test configuration, please refer to the attached file (Test Setup Photo).

4.2.6 EUT Operating Conditions

- a. Placed the EUT on a testing table.
- b. Use the software to control the EUT under transmission condition continuously at specific channel frequency.

4.2.7 Test Results

Frequency Range	150kHz ~ 30MHz	Detector Function & Resolution Bandwidth	Quasi-Peak (QP) / Average (AV), 9kHz
Input Power	120Vac, 60Hz	Environmental Conditions	25°C, 65%RH
Tested by	Getaz Yang	Test Date	2017/4/26

Phase Of Power : Line (L)										
No	Frequency (MHz)	Correction Factor (dB)	Reading Value (dBuV)		Emission Level (dBuV)		Limit (dBuV)		Margin (dB)	
			Q.P.	AV.	Q.P.	AV.	Q.P.	AV.	Q.P.	AV.
1	0.15000	10.34	39.82	26.12	50.16	36.46	66.00	56.00	-15.84	-19.54
2	0.16564	10.35	36.83	25.80	47.18	36.15	65.18	55.18	-18.00	-19.03
3	0.19301	10.37	33.60	20.12	43.97	30.49	63.91	53.91	-19.94	-23.42
4	0.56866	10.40	30.50	20.48	40.90	30.88	56.00	46.00	-15.10	-15.12
5	0.63520	10.40	28.28	20.08	38.68	30.48	56.00	46.00	-17.32	-15.52
6	1.40902	10.42	22.61	12.99	33.03	23.41	56.00	46.00	-22.97	-22.59

Remarks:

1. Q.P. and AV. are abbreviations of quasi-peak and average individually.
2. The emission levels of other frequencies were very low against the limit.
3. Margin value = Emission level – Limit value
4. Correction factor = Insertion loss + Cable loss
5. Emission Level = Correction Factor + Reading Value

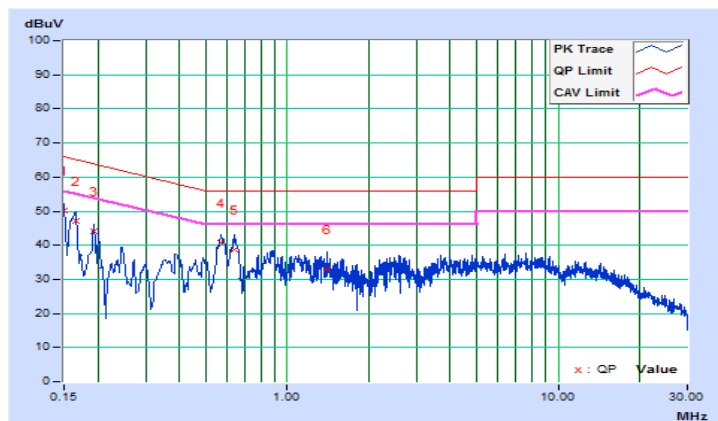

Frequency Range	150kHz ~ 30MHz	Detector Function & Resolution Bandwidth	Quasi-Peak (QP) / Average (AV), 9kHz
Input Power	120Vac, 60Hz	Environmental Conditions	25°C, 65%RH
Tested by	Getaz Yang	Test Date	2017/4/26

Phase Of Power : Neutral (N)										
No	Frequency (MHz)	Correction Factor (dB)	Reading Value (dBuV)		Emission Level (dBuV)		Limit (dBuV)		Margin (dB)	
			Q.P.	AV.	Q.P.	AV.	Q.P.	AV.	Q.P.	AV.
1	0.15391	10.11	35.17	21.35	45.28	31.46	65.79	55.79	-20.51	-24.33
2	0.16967	10.12	33.60	19.22	43.72	29.34	64.98	54.98	-21.26	-25.64
3	0.19561	10.14	32.58	20.02	42.72	30.16	63.79	53.79	-21.07	-23.63
4	0.56418	10.16	30.13	21.63	40.29	31.79	56.00	46.00	-15.71	-14.21
5	0.63093	10.16	28.66	21.32	38.82	31.48	56.00	46.00	-17.18	-14.52
6	1.38947	10.19	27.87	19.51	38.06	29.70	56.00	46.00	-17.94	-16.30

Remarks:

1. Q.P. and AV. are abbreviations of quasi-peak and average individually.
2. The emission levels of other frequencies were very low against the limit.
3. Margin value = Emission level – Limit value
4. Correction factor = Insertion loss + Cable loss
5. Emission Level = Correction Factor + Reading Value

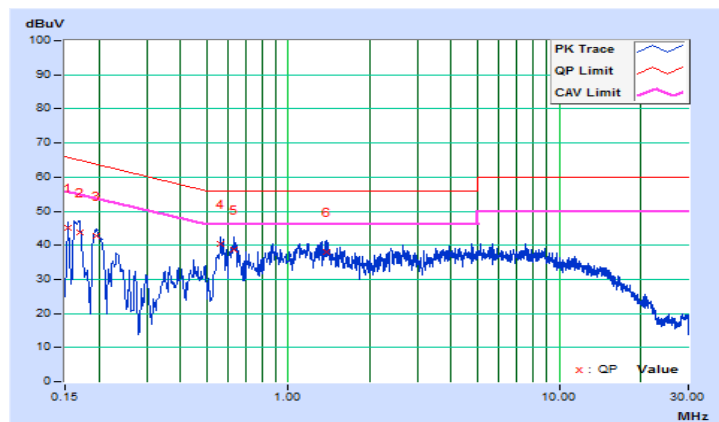

4.3 Transmit Power Measurement

4.3.1 Limits of Transmit Power Measurement

Operation Band	EUT Category	Limit
U-NII-1	Outdoor Access Point	1 Watt (30 dBm) (Max. e.i.r.p \leq 125 mW (21 dBm) at any elevation angle above 30 degrees as measured from the horizon)
	Fixed point-to-point Access Point	1 Watt (30 dBm)
	Indoor Access Point	1 Watt (30 dBm)
	√ Mobile and Portable client device	250 mW (24 dBm)
U-NII-2A	√	250 mW (24 dBm) or 11 dBm+10 log B*
U-NII-2C	√	250 mW (24 dBm) or 11 dBm+10 log B*
U-NII-3	√	1 Watt (30 dBm)

*B is the 26 dB emission bandwidth in megahertz

4.3.2 Test Setup

<Power Output Measurement>

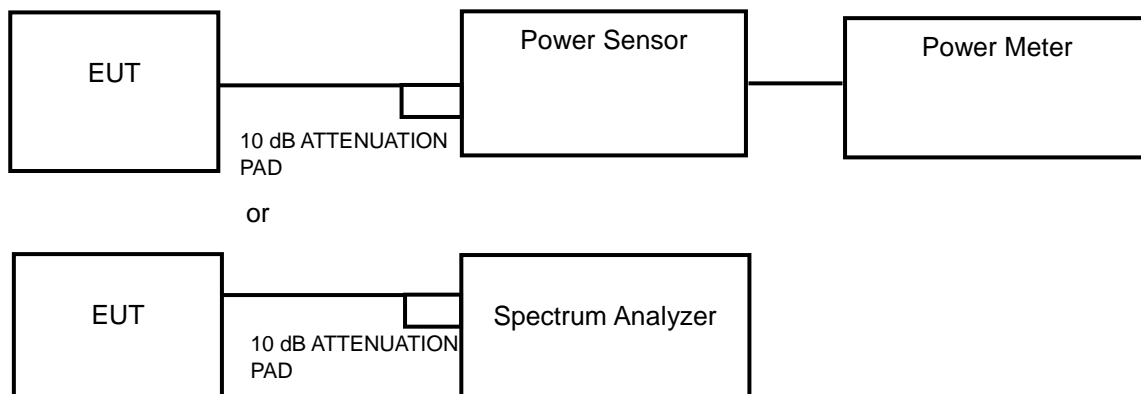

<26 dB Bandwidth>

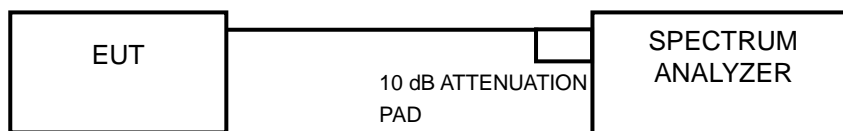

4.3.3 Test Instruments

Refer to section 4.1.2 to get information of above instrument.

4.3.4 Test Procedure

Average Power Measurement

<802.11a, 802.11n (HT20), 802.11n (HT40)>

Method PM is used to perform output power measurement, trigger and gating function of wide band power meter is enabled to measure max output power of TX on burst. Duty factor is not added to measured value.

<802.11ac (VHT80)>

Method SA-1 is used to perform output power measurement, trigger and gating function of spectrum analyzer is enabled to measure max output power of TX on burst. Duty factor is not added to measured value.

26 dB Bandwidth

- 1) Set RBW = approximately 1 % of the emission bandwidth.
- 2) Set the VBW > RBW.
- 3) Detector = Peak.
- 4) Trace mode = max hold.
- 5) Measure the maximum width of the emission that is 26 dB down from the peak of the emission. Compare this with the RBW setting of the analyzer. Readjust RBW and repeat measurement as needed until the RBW/EBW ratio is approximately 1 %.

4.3.5 Deviation from Test Standard

No deviation.

4.3.6 EUT Operating Conditions

The software provided by client to enable the EUT under transmission condition continuously at lowest, middle and highest channel frequencies individually.

4.3.7 Test Result

Power Output:

802.11a

Channel	Frequency (MHz)	Maximum Conducted Power (mW)	Maximum Conducted Power (dBm)	Power Limit (dBm)	Pass / Fail
36	5180	17.498	12.43	24	Pass
44	5220	18.493	12.67	24	Pass
48	5240	16.106	12.07	24	Pass
52	5260	14.859	11.72	24	Pass
60	5300	13.213	11.21	24	Pass
64	5320	12.735	11.05	24	Pass
100	5500	11.298	10.53	24	Pass
116	5580	12.618	11.01	24	Pass
140	5700	14.060	11.48	24	Pass
149	5745	15.668	11.95	30	Pass
157	5785	16.827	12.26	30	Pass
165	5825	16.255	12.11	30	Pass

Note:

For U-NII-2A, U-NII-2C Band:

1. $11 \text{ dBm} + 10\log(21.72) = 24.37 \text{ dBm} > 24 \text{ dBm}$.
2. $11 \text{ dBm} + 10\log(21.60) = 24.34 \text{ dBm} > 24 \text{ dBm}$.
3. $11 \text{ dBm} + 10\log(21.63) = 24.35 \text{ dBm} > 24 \text{ dBm}$.
4. $11 \text{ dBm} + 10\log(21.48) = 24.32 \text{ dBm} > 24 \text{ dBm}$.
5. $11 \text{ dBm} + 10\log(21.66) = 24.36 \text{ dBm} > 24 \text{ dBm}$.
6. $11 \text{ dBm} + 10\log(21.48) = 24.32 \text{ dBm} > 24 \text{ dBm}$.

802.11n (HT20)

Channel	Frequency (MHz)	Maximum Conducted Power (mW)	Maximum Conducted Power (dBm)	Power Limit (dBm)	Pass / Fail
36	5180	15.668	11.95	24	Pass
44	5220	15.996	12.04	24	Pass
48	5240	14.355	11.57	24	Pass
52	5260	13.397	11.27	24	Pass
60	5300	11.588	10.64	24	Pass
64	5320	11.324	10.54	24	Pass
100	5500	10.186	10.08	24	Pass
116	5580	11.776	10.71	24	Pass
140	5700	14.388	11.58	24	Pass
149	5745	14.894	11.73	30	Pass
157	5785	15.417	11.88	30	Pass
165	5825	15.560	11.92	30	Pass

Note:

For U-NII-2A, U-NII-2C Band:

1. $11 \text{ dBm} + 10\log(21.85) = 24.39 \text{ dBm} > 24 \text{ dBm}$.
2. $11 \text{ dBm} + 10\log(21.87) = 24.40 \text{ dBm} > 24 \text{ dBm}$.
3. $11 \text{ dBm} + 10\log(21.88) = 24.40 \text{ dBm} > 24 \text{ dBm}$.
4. $11 \text{ dBm} + 10\log(21.73) = 24.37 \text{ dBm} > 24 \text{ dBm}$.
5. $11 \text{ dBm} + 10\log(21.97) = 24.42 \text{ dBm} > 24 \text{ dBm}$.
6. $11 \text{ dBm} + 10\log(21.94) = 24.41 \text{ dBm} > 24 \text{ dBm}$.

802.11n (HT40)

Channel	Frequency (MHz)	Maximum Conducted Power (mW)	Maximum Conducted Power (dBm)	Power Limit (dBm)	Pass / Fail
38	5190	15.631	11.94	24	Pass
46	5230	14.388	11.58	24	Pass
54	5270	12.134	10.84	24	Pass
62	5310	11.940	10.77	24	Pass
102	5510	10.914	10.38	24	Pass
110	5550	12.106	10.83	24	Pass
134	5670	14.723	11.68	24	Pass
151	5755	15.812	11.99	30	Pass
159	5795	15.704	11.96	30	Pass

Note:

For U-NII-2A, U-NII-2C Band:

1. $11 \text{ dBm} + 10\log(41.28) = 27.16 \text{ dBm} > 24 \text{ dBm}$.
2. $11 \text{ dBm} + 10\log(41.54) = 27.18 \text{ dBm} > 24 \text{ dBm}$.
3. $11 \text{ dBm} + 10\log(47.76) = 27.79 \text{ dBm} > 24 \text{ dBm}$.
4. $11 \text{ dBm} + 10\log(41.18) = 27.15 \text{ dBm} > 24 \text{ dBm}$.
5. $11 \text{ dBm} + 10\log(41.19) = 27.15 \text{ dBm} > 24 \text{ dBm}$.

802.11ac (VHT80)

Channel	Frequency (MHz)	Maximum Conducted Power (mW)	Maximum Conducted Power (dBm)	Power Limit (dBm)	Pass / Fail
42	5210	8.492	9.29	24	Pass
58	5290	6.180	7.91	24	Pass
106	5530	6.095	7.85	24	Pass
122	5610	5.957	7.75	24	Pass
155	5775	8.750	9.42	30	Pass

Note:

For U-NII-2A, U-NII-2C Band:

1. $11 \text{ dBm} + 10\log(82.51) = 30.17 \text{ dBm} > 24 \text{ dBm}$.
2. $11 \text{ dBm} + 10\log(82.07) = 30.14 \text{ dBm} > 24 \text{ dBm}$.
3. $11 \text{ dBm} + 10\log(82.23) = 30.15 \text{ dBm} > 24 \text{ dBm}$.

26 dB Bandwidth:
802.11a

Channel	Frequency (MHz)	26 dBc Bandwidth (MHz)
36	5180	21.41
44	5220	21.49
48	5240	21.72
52	5260	21.72
60	5300	21.60
64	5320	21.63
100	5500	21.48
116	5580	21.66
140	5700	21.48

802.11n (HT20)

Channel	Frequency (MHz)	26 dBc Bandwidth (MHz)
36	5180	21.83
44	5220	22.00
48	5240	21.76
52	5260	21.85
60	5300	21.87
64	5320	21.88
100	5500	21.73
116	5580	21.97
140	5700	21.94

802.11n (HT40)

Channel	Frequency (MHz)	26 dBc Bandwidth (MHz)
38	5190	41.31
46	5230	41.32
54	5270	41.28
62	5310	41.54
102	5510	47.76
110	5550	41.18
134	5670	41.19

802.11ac (VHT80)

Channel	Frequency (MHz)	26 dBc Bandwidth (MHz)
42	5210	82.33
58	5290	82.51
106	5530	82.07
122	5610	82.23

Spectrum Plot of Worst Value

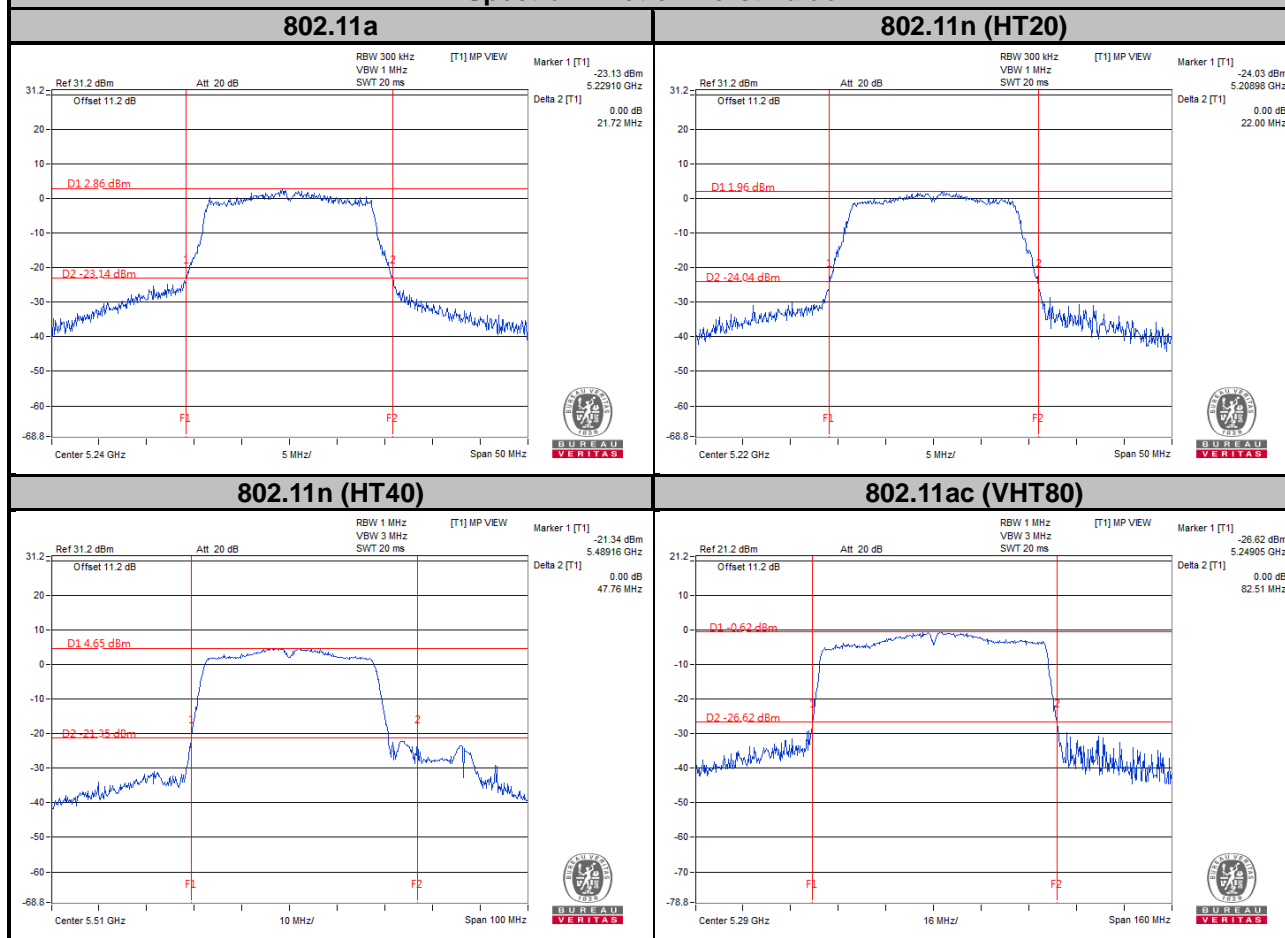

4.4 Peak Power Spectral Density Measurement

4.4.1 Limits of Peak Power Spectral Density Measurement

Operation Band	EUT Category		Limit
U-NII-1		Outdoor Access Point	17 dBm/MHz
		Fixed point-to-point Access Point	
		Indoor Access Point	
	√	Mobile and Portable client device	11 dBm/MHz
U-NII-2A		√	11 dBm/MHz
U-NII-2C		√	11 dBm/MHz
U-NII-3		√	30 dBm/500 kHz

4.4.2 Test Setup

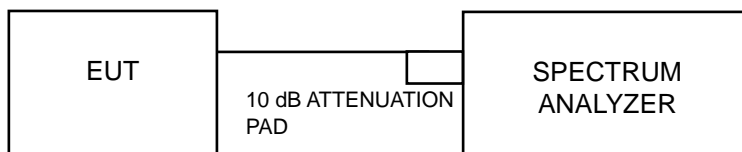

4.4.3 Test Instruments

Refer to section 4.1.3 to get information of above instrument.

4.4.4 Test Procedures

For U-NII-1, U-NII-2A, U-NII-2C band:

Using method SA-2

1. Set span to encompass the entire emission bandwidth (EBW) of the signal.
2. Set RBW = 1 MHz, Set VBW \geq 3 RBW, Detector = RMS
3. Sweep time = auto, trigger set to "free run".
4. Trace average at least 100 traces in power averaging mode.
5. Record the max value and add 10 log (1/duty cycle)

※For U-NII-3:

1. Set span to encompass the entire emission bandwidth (EBW) of the signal.
2. Set RBW = 500 kHz, Set VBW \geq 3 RBW, Detector = RMS
3. Use the peak marker function to determine the maximum power level in any 500 kHz band segment within the fundamental EBW.
4. Sweep time = auto, trigger set to "free run".
5. Trace average at least 100 traces in power averaging mode.
6. Record the max value and add 10 log (1/duty cycle)

4.4.5 Deviation from Test Standard

No deviation.

4.4.6 EUT Operating Conditions

The software provided by client to enable the EUT under transmission condition continuously at lowest, middle and highest channel frequencies individually.

4.4.7 Test Results

802.11a

Channel	Frequency (MHz)	PSD w/o Duty Factor (dBm/MHz)	Duty Factor (dB)	PSD with Duty Factor (dBm/MHz)	Maximum Limit (dBm/MHz)	Pass / Fail
36	5180	-1.42	0.49	-0.93	11	Pass
44	5220	-1.72	0.49	-1.23	11	Pass
48	5240	-1.82	0.49	-1.33	11	Pass
52	5260	-1.97	0.49	-1.48	11	Pass
60	5300	-2.06	0.49	-1.57	11	Pass
64	5320	-2.09	0.49	-1.60	11	Pass
100	5500	-1.58	0.49	-1.09	11	Pass
116	5580	-1.78	0.49	-1.29	11	Pass
140	5700	-1.95	0.49	-1.46	11	Pass

Note: Refer to section 3.3 for duty cycle spectrum plot.

802.11n (HT20)

Channel	Frequency (MHz)	PSD w/o Duty Factor (dBm/MHz)	Duty Factor (dB)	PSD with Duty Factor (dBm/MHz)	Maximum Limit (dBm/MHz)	Pass / Fail
36	5180	-0.43	0.11	-0.32	11	Pass
44	5220	-0.80	0.11	-0.69	11	Pass
48	5240	-1.28	0.11	-1.17	11	Pass
52	5260	-1.19	0.11	-1.08	11	Pass
60	5300	-1.54	0.11	-1.43	11	Pass
64	5320	-1.30	0.11	-1.19	11	Pass
100	5500	-1.06	0.11	-0.95	11	Pass
116	5580	-1.04	0.11	-0.93	11	Pass
140	5700	-1.38	0.11	-1.27	11	Pass

Note: Refer to section 3.3 for duty cycle spectrum plot.

802.11n (HT40)

Channel	Frequency (MHz)	PSD w/o Duty Factor (dBm/MHz)	Duty Factor (dB)	PSD with Duty Factor (dBm/MHz)	Maximum Limit (dBm/MHz)	Pass / Fail
38	5190	-3.60	0.15	-3.45	11	Pass
46	5230	-3.57	0.15	-3.42	11	Pass
54	5270	-4.07	0.15	-3.92	11	Pass
62	5310	-4.48	0.15	-4.33	11	Pass
102	5510	-3.55	0.15	-3.40	11	Pass
110	5550	-3.64	0.15	-3.49	11	Pass
134	5670	-3.66	0.15	-3.51	11	Pass

Note: Refer to section 3.3 for duty cycle spectrum plot.

802.11ac (VHT80)

Channel	Frequency (MHz)	PSD w/o Duty Factor (dBm/MHz)	Duty Factor (dB)	PSD with Duty Factor (dBm/MHz)	Maximum Limit (dBm/MHz)	Pass / Fail
42	5210	-10.44	0.29	-10.15	11	Pass
58	5290	-10.79	0.29	-10.50	11	Pass
106	5530	-10.68	0.29	-10.39	11	Pass
122	5610	-10.84	0.29	-10.55	11	Pass

Note: Refer to section 3.3 for duty cycle spectrum plot.

Spectrum Plot of Worst Value

802.11a

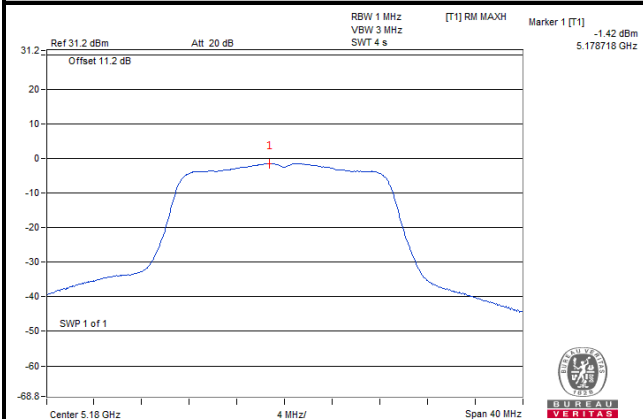

802.11n (HT20)

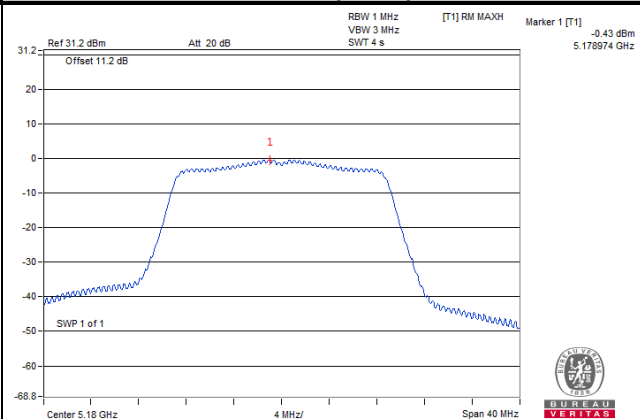

802.11n (HT40)

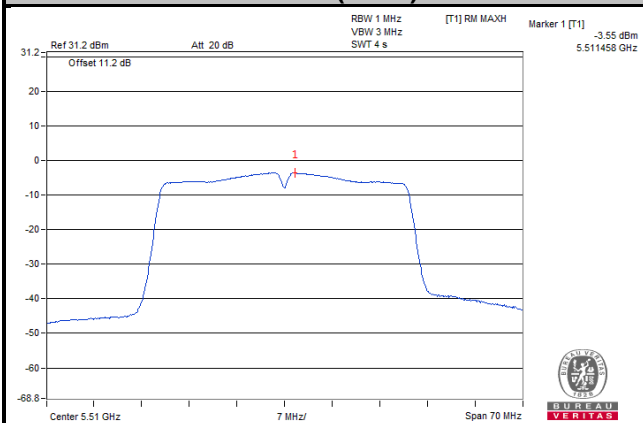

802.11ac (VHT80)

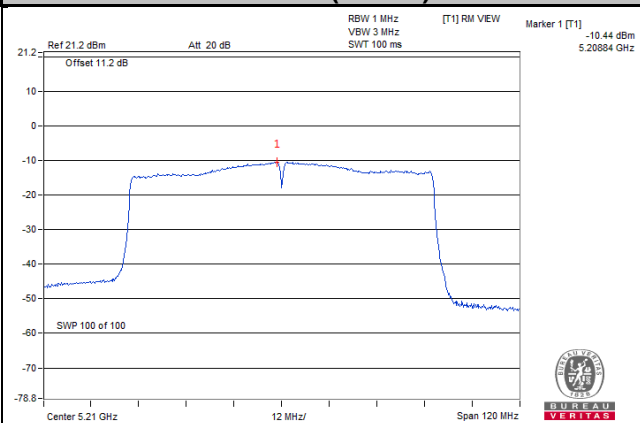

For U-NII-3 Band

802.11a

Channel	Frequency (MHz)	PSD w/o Duty Factor (dBm/500 kHz)	Duty Factor (dB)	PSD with Duty Factor (dBm/500 kHz)	Limit (dBm/500 kHz)	Pass / Fail
149	5745	-4.49	0.49	-4.00	30	Pass
157	5785	-3.92	0.49	-3.43	30	Pass
165	5825	-4.65	0.49	-4.16	30	Pass

Note: Refer to section 3.3 for duty cycle spectrum plot.

802.11n (HT20)

Channel	Frequency (MHz)	PSD w/o Duty Factor (dBm/500 kHz)	Duty Factor (dB)	PSD with Duty Factor (dBm/500 kHz)	Limit (dBm/500 kHz)	Pass / Fail
149	5745	-3.88	0.11	-3.77	30	Pass
157	5785	-3.31	0.11	-3.20	30	Pass
165	5825	-3.76	0.11	-3.65	30	Pass

Note: Refer to section 3.3 for duty cycle spectrum plot.

802.11n (HT40)

Channel	Frequency (MHz)	PSD w/o Duty Factor (dBm/500 kHz)	Duty Factor (dB)	PSD with Duty Factor (dBm/500 kHz)	Limit (dBm/500 kHz)	Pass / Fail
151	5755	-6.80	0.15	-6.65	30	Pass
159	5795	-7.00	0.15	-6.85	30	Pass

Note: Refer to section 3.3 for duty cycle spectrum plot.

802.11ac (VHT80)

Channel	Frequency (MHz)	PSD w/o Duty Factor (dBm/500 kHz)	Duty Factor (dB)	PSD with Duty Factor (dBm/500 kHz)	Limit (dBm/500 kHz)	Pass / Fail
155	5775	-11.65	0.29	-11.36	30	Pass

Note: Refer to section 3.3 for duty cycle spectrum plot.

Spectrum Plot of Worst Value

802.11a

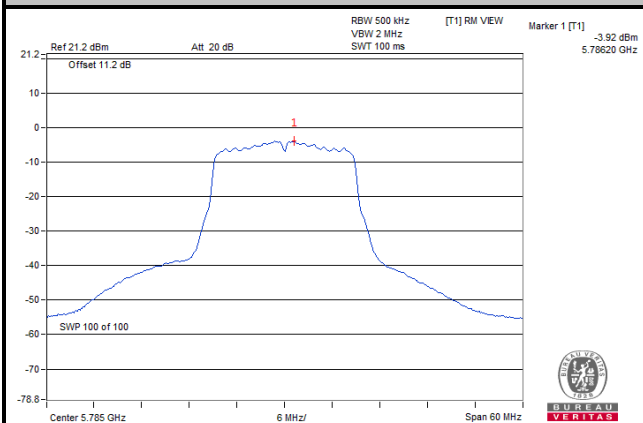

802.11n (HT20)

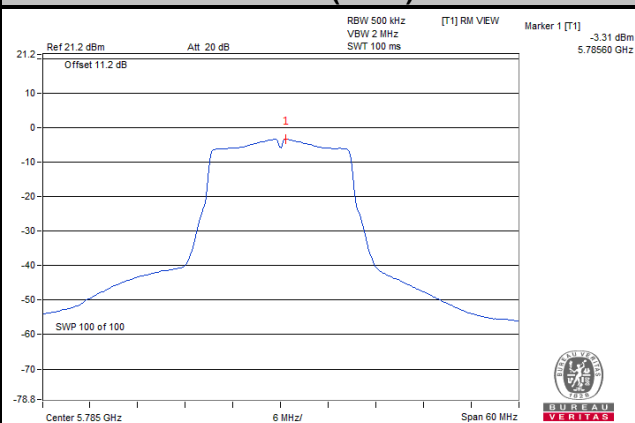

802.11n (HT40)

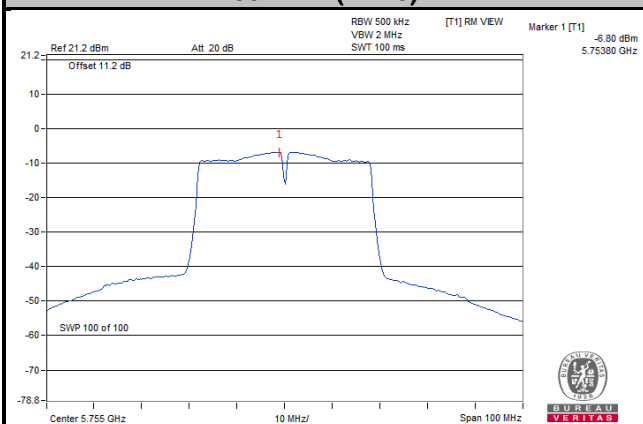

802.11ac (VHT80)

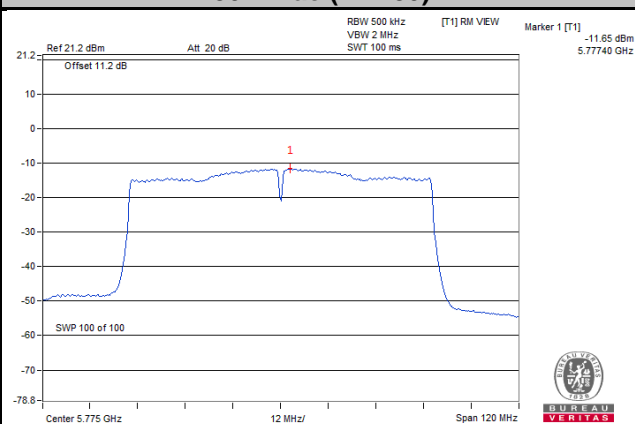

4.5 Frequency Stability

4.5.1 Limit of Frequency Stability Measurement

The frequency of the carrier signal shall be maintained within band of operation.

4.5.2 Test Setup

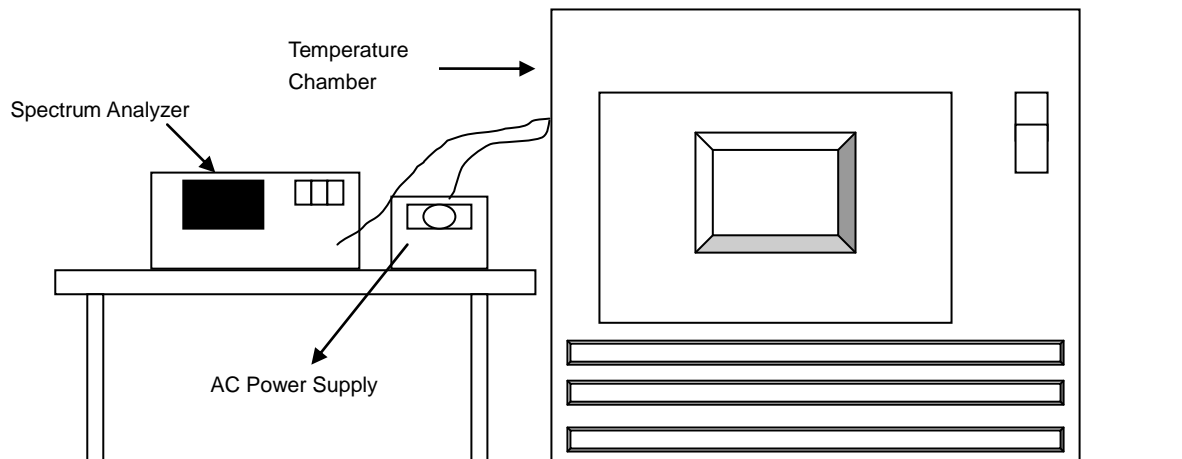

4.5.3 Test Instruments

Refer to section 4.1.3 to get information of above instrument.

4.5.4 Test Procedure

- To ensure emission at the band edge is maintained within the authorized band, those values shall be measured by radiation emissions at upper and lower frequency points, and finally compensated by frequency deviation as procedures below.
- The EUT was operated at the maximum output power, and connected to the spectrum analyzer, which is set to maximum hold function and peak detector. The peak value of the power envelope was measured and noted. The upper and lower frequency points were respectively measured relatively 10 dB lower than the measured peak value.
- The frequency deviation was calculated by adding the upper frequency point and the lower frequency point divided by two. Those detailed values of frequency deviation are provided in table below.

4.5.5 Deviation from Test Standard

No deviation.

4.5.6 EUT Operating Condition

Set the EUT transmit at un-modulation mode to test frequency stability.

4.5.7 Test Results

Frequency Stability Versus Temp.									
Operating Frequency: 5320 MHz									
Temp. (°C)	Power Supply (Vac)	0 Minute		2 Minute		5 Minute		10 Minute	
		Measured Frequency (MHz)	Frequency Drift (ppm)	Measured Frequency (MHz)	Frequency Drift (ppm)	Measured Frequency (MHz)	Frequency Drift (ppm)	Measured Frequency (MHz)	Frequency Drift (ppm)
50	120	5179.9911	-0.00017	5179.9922	-0.00015	5179.9911	-0.00017	5179.9916	-0.00016
40	120	5179.9959	-0.00008	5179.9973	-0.00005	5179.9962	-0.00007	5180	0.00000
30	120	5179.9992	-0.00002	5179.9979	-0.00004	5179.9985	-0.00003	5179.9977	-0.00004
20	120	5180.0044	0.00008	5180.0059	0.00011	5180.0027	0.00005	5180.0053	0.00010
10	120	5180.0224	0.00043	5180.02	0.00039	5180.0219	0.00042	5180.0202	0.00039
0	120	5179.9762	-0.00046	5179.9779	-0.00043	5179.978	-0.00042	5179.9773	-0.00044
-10	120	5179.9862	-0.00027	5179.9858	-0.00027	5179.9857	-0.00028	5179.9857	-0.00028
-20	120	5179.9965	-0.00007	5179.9987	-0.00003	5179.9969	-0.00006	5179.9953	-0.00009
-30	120	5180.0081	0.00016	5180.0088	0.00017	5180.0063	0.00012	5180.0081	0.00016

Frequency Stability Versus Temp.									
Operating Frequency: 5320 MHz									
Temp. (°C)	Power Supply (Vac)	0 Minute		2 Minute		5 Minute		10 Minute	
		Measured Frequency (MHz)	Frequency Drift (ppm)	Measured Frequency (MHz)	Frequency Drift (ppm)	Measured Frequency (MHz)	Frequency Drift (ppm)	Measured Frequency (MHz)	Frequency Drift (ppm)
20	138	5180.0046	0.00009	5180.0065	0.00013	5180.0035	0.00007	5180.0063	0.00012
	120	5180.0044	0.00008	5180.0059	0.00011	5180.0027	0.00005	5180.0053	0.00010
	102	5180.0037	0.00007	5180.0066	0.00013	5180.0018	0.00003	5180.0057	0.00011

4.6 6 dB Bandwidth Measurement

4.6.1 Limits of 6 dB Bandwidth Measurement

The minimum of 6 dB Bandwidth Measurement is 0.5 MHz.

4.6.2 Test Setup

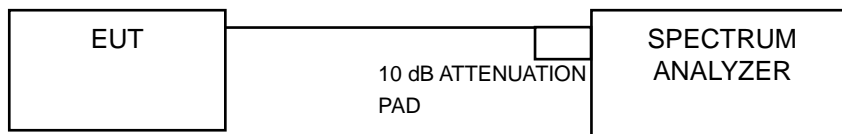

4.6.3 Test Instruments

Refer to section 4.1.3 to get information of above instrument.

4.6.4 Test Procedure

MEASUREMENT PROCEDURE REF

- Set resolution bandwidth (RBW) = 100 kHz
- Set the video bandwidth (VBW) $\geq 3 \times$ RBW, Detector = Peak.
- Trace mode = max hold.
- Sweep = auto couple.
- Measure the maximum width of the emission that is constrained by the frequencies associated with the two amplitude points (upper and lower) that are attenuated by 6 dB relative to the maximum level measured in the fundamental emission

4.6.5 Deviation from Test Standard

No deviation.

4.6.6 EUT Operating Condition

The software provided by client to enable the EUT under transmission condition continuously at lowest, middle and highest channel frequencies individually.

4.6.7 Test Results

802.11a

Channel	Frequency (MHz)	6 dB Bandwidth (MHz)	Minimum Limit (MHz)	Pass / Fail
149	5745	17.75	0.5	Pass
157	5785	17.70	0.5	Pass
165	5825	17.69	0.5	Pass

802.11n (HT20)

Channel	Frequency (MHz)	6 dB Bandwidth (MHz)	Minimum Limit (MHz)	Pass / Fail
149	5745	17.58	0.5	Pass
157	5785	16.96	0.5	Pass
165	5825	17.56	0.5	Pass

802.11n (HT40)

Channel	Frequency (MHz)	6 dB Bandwidth (MHz)	Minimum Limit (MHz)	Pass / Fail
151	5755	35.77	0.5	Pass
159	5795	35.76	0.5	Pass

802.11ac (VHT80)

Channel	Frequency (MHz)	6 dB Bandwidth (MHz)	Minimum Limit (MHz)	Pass / Fail
155	5775	75.83	0.5	Pass

Spectrum Plot of Worst Value

802.11a

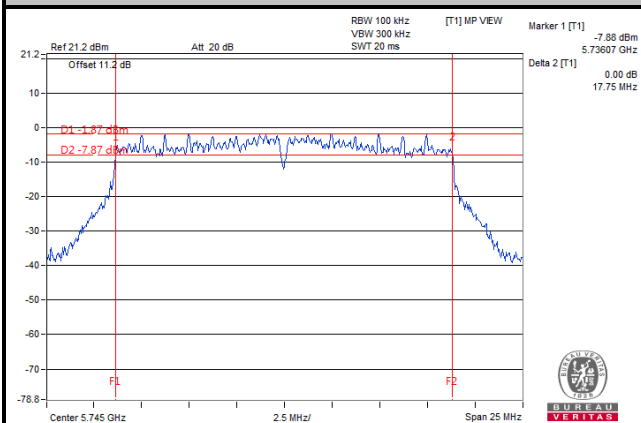

802.11n (HT20)

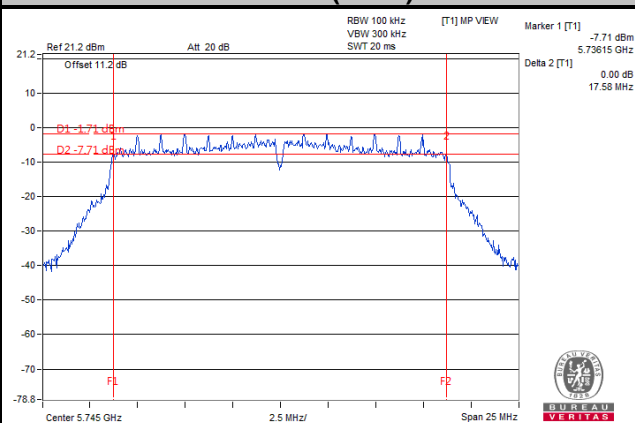

802.11n (HT40)

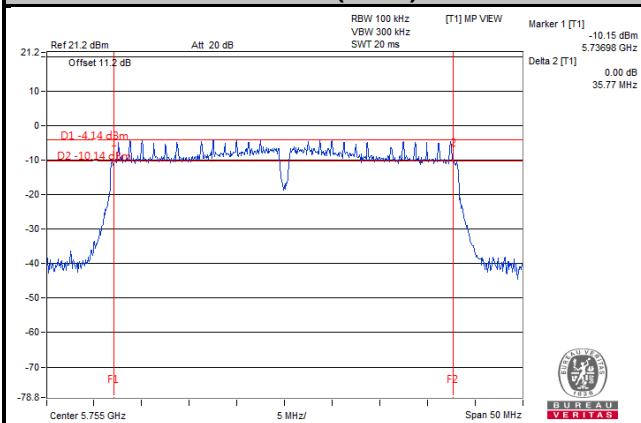

802.11ac (VHT80)

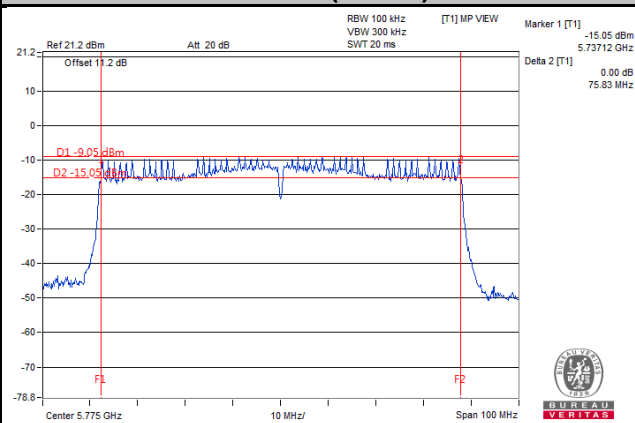

5 Pictures of Test Arrangements

Please refer to the attached file (Test Setup Photo).

Annex A- Radiated Out of Band Emisison (OOBE) Measurement (For U-NII-3 band)

802.11a

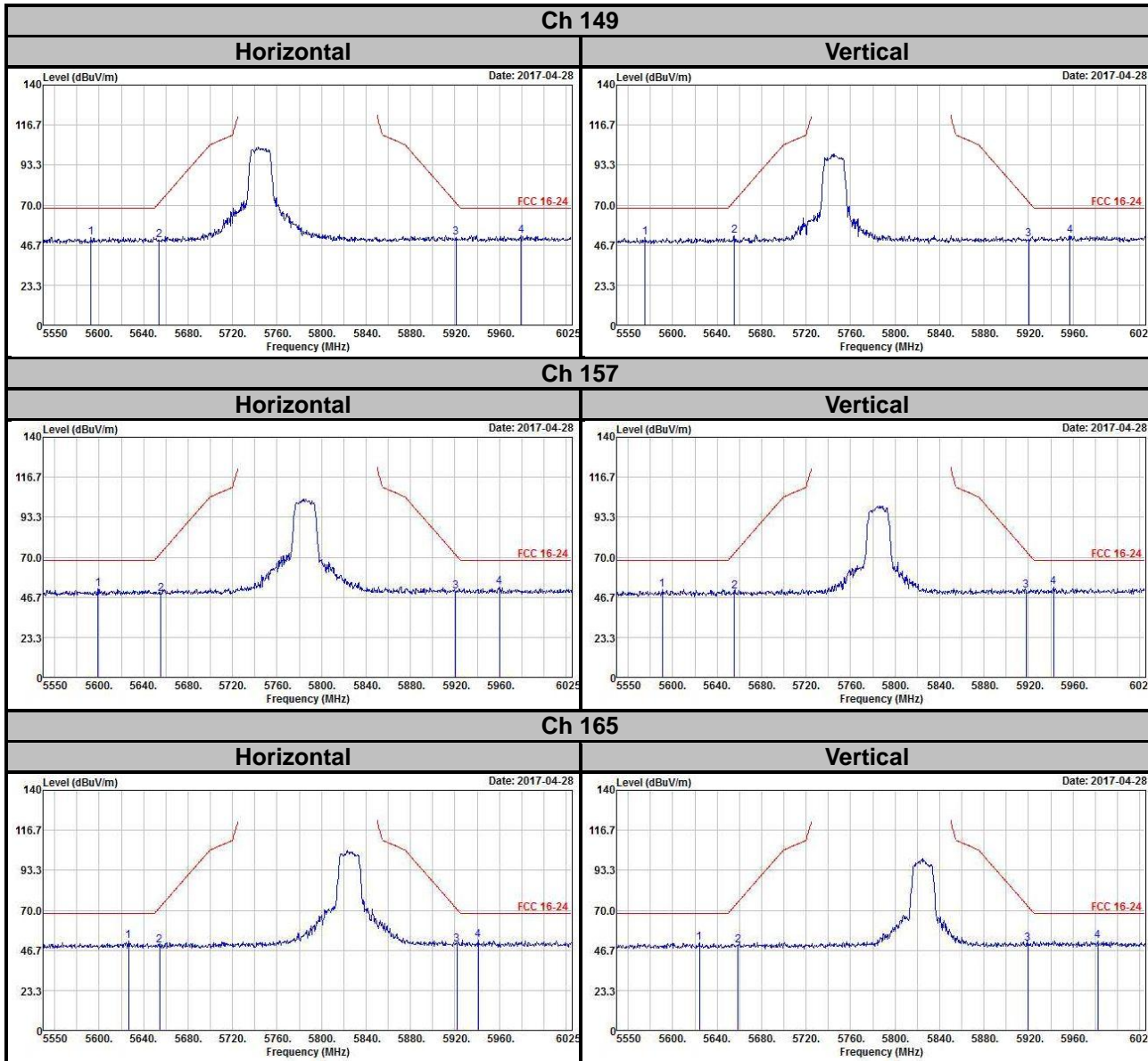

802.11n (HT20)

Ch 149

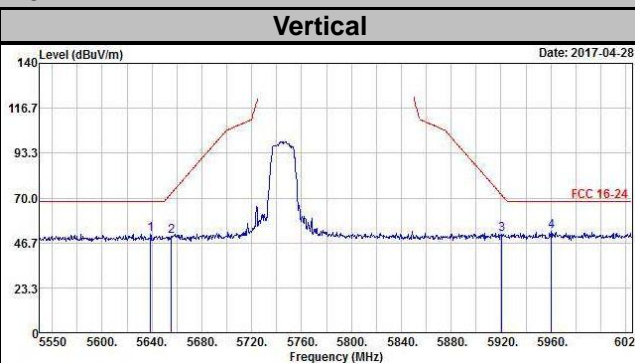
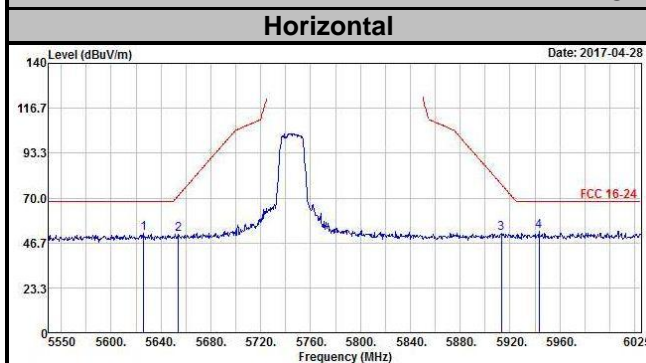

Ch 157

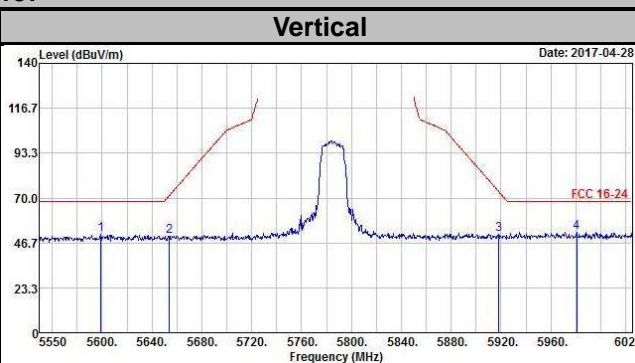
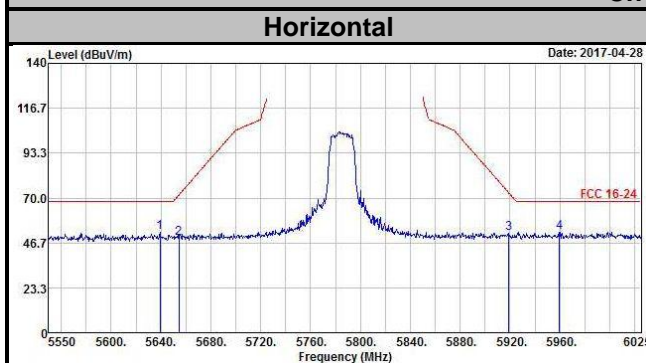

Ch 165

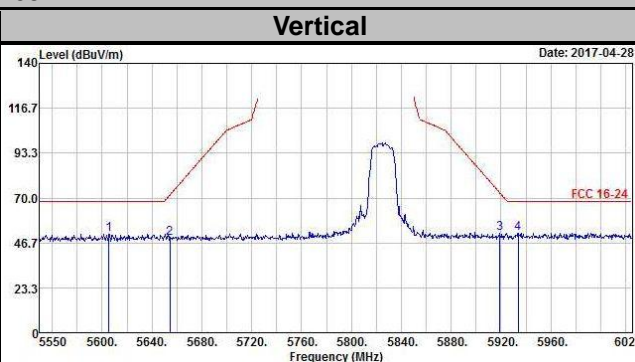
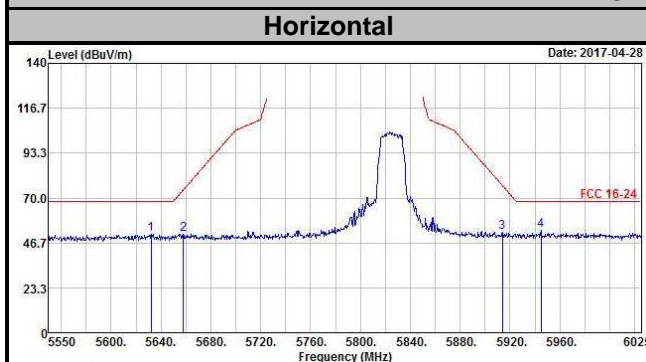

802.11n (HT40)

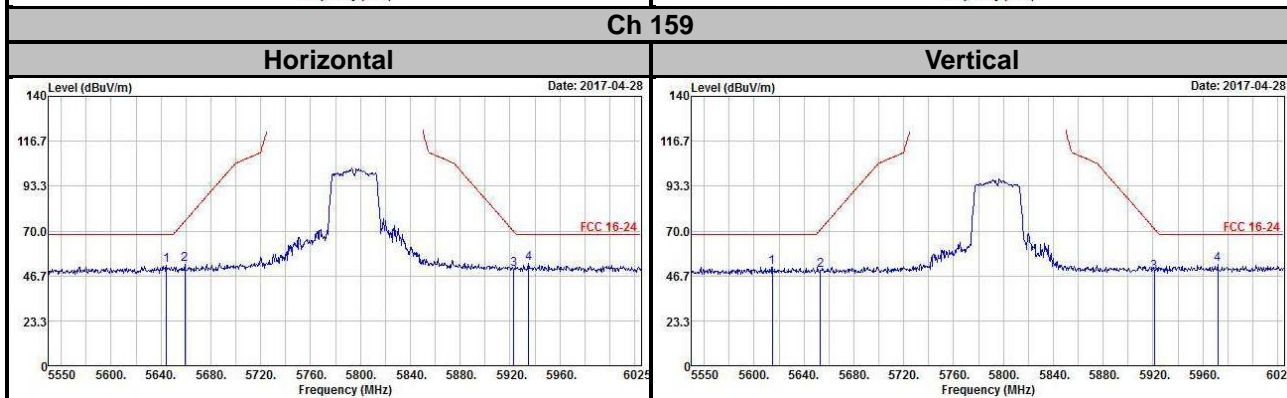
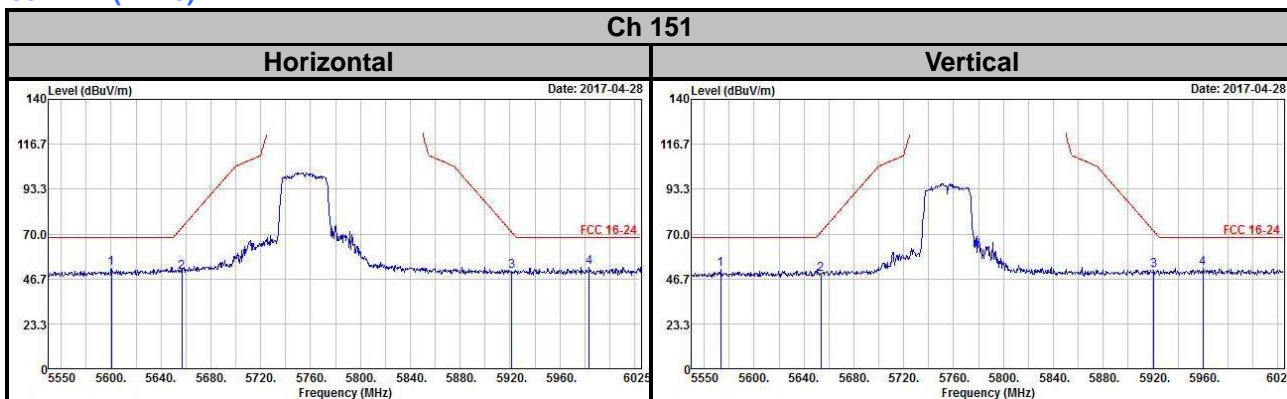

802.11ac (VHT80)

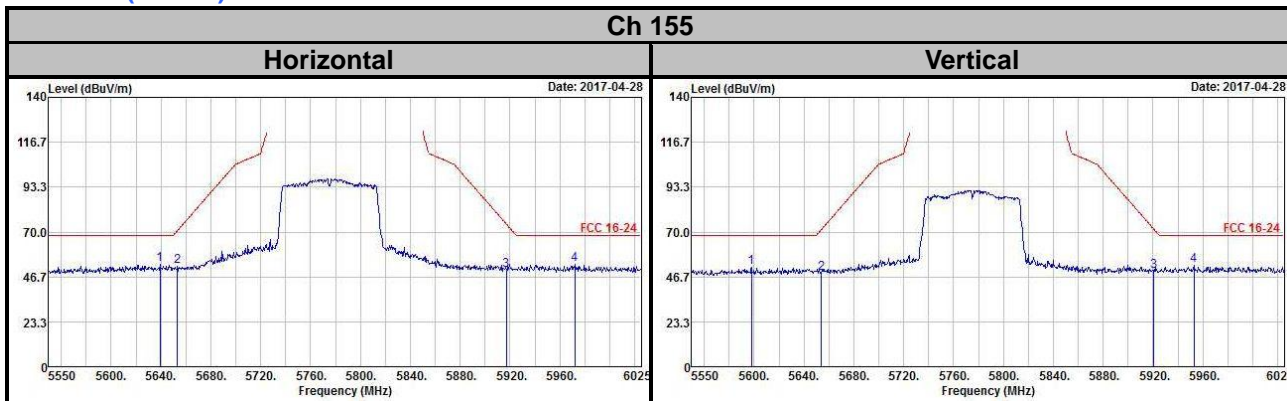

Appendix – Information on the Testing Laboratories

We, Bureau Veritas Consumer Products Services (H.K.) Ltd., Taoyuan Branch, were founded in 1988 to provide our best service in EMC, Radio, Telecom and Safety consultation. Our laboratories are accredited and approved according to ISO/IEC 17025.

If you have any comments, please feel free to contact us at the following:

Linko EMC/RF Lab

Tel: 886-2-26052180

Fax: 886-2-26051924

Hsin Chu EMC/RF/Telecom Lab

Tel: 886-3-6668565

Fax: 886-3-6668323

Hwa Ya EMC/RF/Safety

Tel: 886-3-3183232

Fax: 886-3-3270892

Email: service.adt@tw.bureauveritas.com

Web Site: www.bureauveritas-adt.com

The address and road map of all our labs can be found in our web site also.

--- END ---