

FCC Test Report

Report No.: RF161114C10-6

FCC ID: B32V400M3G

Test Model: V400m Plus 3G

Received Date: Nov. 14, 2016

Test Date: Nov. 21, 2016 ~ Nov. 27, 2016

Issued Date: Dec. 15, 2016

Applicant: Verifone, Inc.

Address: 1400 West Stanford Ranch Road Suite 200 Rocklin CA 95765 USA

Issued By: Bureau Veritas Consumer Products Services (H.K.) Ltd., Taoyuan Branch

Lab Address: No. 47-2, 14th Ling, Chia Pau Vil., Lin Kou Dist., New Taipei City, Taiwan
(R.O.C)

Test Location (1): No. 19, Hwa Ya 2nd Rd, Wen Hwa Tsuen, Kwei Shan Hsiang, Taoyuan
Hsien 333, Taiwan, R.O.C.



This report is for your exclusive use. Any copying or replication of this report to or for any other person or entity, or use of our name or trademark, is permitted only with our prior written permission. This report sets forth our findings solely with respect to the test samples identified herein. The results set forth in this report are not indicative or representative of the quality or characteristics of the lot from which a test sample was taken or any similar or identical product unless specifically and expressly noted. Our report includes all of the tests requested by you and the results thereof based upon the information that you provided to us. You have 60 days from date of issuance of this report to notify us of any material error or omission caused by our negligence, provided, however, that such notice shall be in writing and shall specifically address the issue you wish to raise. A failure to raise such issue within the prescribed time shall constitute your unqualified acceptance of the completeness of this report, the tests conducted and the correctness of the report contents. Unless specific mention, the uncertainty of measurement has been explicitly taken into account to declare the compliance or non-compliance to the specification. The report must not be used by the client to claim product certification, approval, or endorsement by TAF or any government agencies.

Table of Contents

Release Control Record	4
1 Certificate of Conformity	5
2 Summary of Test Results	6
2.1 Measurement Uncertainty	6
2.2 Modification Record	6
3 General Information	7
3.1 General Description of EUT	7
3.2 Description of Test Modes.....	9
3.2.1 Test Mode Applicability and Tested Channel Detail	11
3.3 Duty Cycle of Test Signal	13
3.4 Description of Support Units	14
3.4.1 Configuration of System under Test	14
3.5 General Description of Applied Standards.....	14
4 Test Types and Results	15
4.1 Radiated Emission and Bandedge Measurement	15
4.1.1 Limits of Radiated Emission and Bandedge Measurement	15
4.1.2 Limits of Unwanted Emission Out of the Restricted Bands	16
4.1.3 Test Instruments	17
4.1.4 Test Procedures.....	18
4.1.5 Deviation from Test Standard	18
4.1.6 Test Set Up	19
4.1.7 EUT Operating Conditions.....	19
4.1.8 Test Results	20
4.2 Conducted Emission Measurement.....	62
4.2.1 Limits of Conducted Emission Measurement	62
4.2.2 Test Instruments	62
4.2.3 Test Procedures.....	63
4.2.4 Deviation from Test Standard	63
4.2.5 Test Setup.....	63
4.2.6 EUT Operating Conditions.....	63
4.2.7 Test Results	64
4.3 Transmit Power Measurement.....	66
4.3.1 Limits of Transmit Power Measurement	66
4.3.2 Test Setup.....	66
4.3.3 Test Instruments	67
4.3.4 Test Procedure	67
4.3.5 Deviation from Test Standard	67
4.3.6 EUT Operating Conditions.....	67
4.3.7 Test Result	68
4.4 Peak Power Spectral Density Measurement	73
4.4.1 Limits of Peak Power Spectral Density Measurement	73
4.4.2 Test Setup.....	73
4.4.3 Test Instruments	73
4.4.4 Test Procedures.....	73
4.4.5 Deviation from Test Standard	74
4.4.6 EUT Operating Conditions.....	74
4.4.7 Test Results	75
4.5 Frequency Stability	80
4.5.1 Limit of Frequency Stability Measurement	80
4.5.2 Test Setup.....	80
4.5.3 Test Instruments	80
4.5.4 Test Procedure	80
4.5.5 Deviation from Test Standard	80

4.5.6 EUT Operating Condition	80
4.5.7 Test Results	81
4.6 6 dB Bandwidth Measurement.....	82
4.6.1 Limits of 6 dB Bandwidth Measurement.....	82
4.6.2 Test Setup.....	82
4.6.3 Test Instruments	82
4.6.4 Test Procedure	82
4.6.5 Deviation from Test Standard	82
4.6.6 EUT Operating Condition	82
4.6.7 Test Results	83
5 Pictures of Test Arrangements.....	85
Annex A- Radiated Out of Band Emisison (OOBE) Measurement (For U-NII-3 band)	86
Appendix – Information on the Testing Laboratories	89

Release Control Record

Issue No.	Description	Date Issued
RF161114C10-6	Original Release	Dec. 15, 2016

1 Certificate of Conformity

Product: Point of Sale Terminal
Brand: Verifone
Test Model: V400m Plus 3G
Sample Status: Identical Prototype
Applicant: Verifone, Inc.
Test Date: Nov. 21, 2016 ~ Nov. 27, 2016
Standards: 47 CFR FCC Part 15, Subpart E (Section 15.407)
ANSI C63.10:2013

The above equipment has been tested by **Bureau Veritas Consumer Products Services (H.K.) Ltd., Taoyuan Branch**, and found compliance with the requirement of the above standards. The test record, data evaluation & Equipment Under Test (EUT) configurations represented herein are true and accurate accounts of the measurements of the sample's EMC characteristics under the conditions specified in this report.

Prepared by :  , **Date:** Dec. 15, 2016
Ivonne Wu / Supervisor

Approved by :  , **Date:** Dec. 15, 2016
Stanley Wu / Assistant Manager

2 Summary of Test Results

47 CFR FCC Part 15, Subpart E (Section 15.407)			
FCC Clause	Test Item	Result	Remarks
15.407(b)(6)	AC Power Conducted Emissions	Pass	Meet the requirement of limit. Minimum passing margin is -6.17 dB at 0.48600 MHz.
15.407(b) (1/2/3/4(i/ii)/6)	Radiated Emissions & Band Edge Measurement	Pass	Meet the requirement of limit. Minimum passing margin is -0.38 dB at 5150 MHz.
15.407(a)(1/2/3)	Max Average Transmit Power	Pass	Meet the requirement of limit.
15.407(a)(1/2/3)	Peak Power Spectral Density	Pass	Meet the requirement of limit.
15.407(e)	6 dB Bandwidth	Pass	Meet the requirement of limit. (U-NII-3 Band only)
15.407(g)	Frequency Stability	Pass	Meet the requirement of limit.
15.203	Antenna Requirement	Pass	No antenna connector is used.

*For U-NII-3 band compliance with rule part 15.407(b)(4)(i), the OOB test plots were recorded in Annex A.

2.1 Measurement Uncertainty

Where relevant, the following measurement uncertainty levels have been estimated for tests performed on the EUT as specified in CISPR 16-4-2:

Measurement	Frequency	Expanded Uncertainty (k=2) (±)
Conducted Emissions at mains ports	150 kHz ~ 30 MHz	2.44 dB
Radiated Emissions up to 1 GHz	30 MHz ~ 200 MHz	2.93 dB
	200 MHz ~ 1000 MHz	2.95 dB
Radiated Emissions above 1 GHz	1 GHz ~ 18 GHz	2.26 dB
	18 GHz ~ 40 GHz	1.94 dB

2.2 Modification Record

There were no modifications required for compliance.

3 General Information

3.1 General Description of EUT

Product	Point of Sale Terminal
Brand	Verifone
Test Model	V400m Plus 3G
Status of EUT	Identical Prototype
Power Supply Rating	5.0 Vdc (adapter or host equipment) 3.85 Vdc (Li-ion battery)
Modulation Type	256QAM, 64QAM, 16QAM, QPSK, BPSK
Modulation Technology	OFDM
Transfer Rate	802.11a: 54.0/ 48.0/ 36.0/ 24.0/ 18.0/ 12.0/ 9.0/ 6.0 Mbps 802.11n: up to MCS7 802.11ac: up to V9
Operating Frequency	5180 ~ 5240 MHz, 5260 ~ 5320 MHz, 5500 ~ 5700 MHz, 5745 ~ 5825 MHz
Number of Channel	5180 ~ 5240 MHz: 4 for 802.11a, 802.11n (HT20) 2 for 802.11n (HT40) 1 for 802.11ac (VHT80) 5260 ~ 5320 MHz: 4 for 802.11a, 802.11n (HT20) 2 for 802.11n (HT40) 1 for 802.11ac (VHT80) 5500 ~ 5700 MHz: 11 for 802.11a, 802.11n (HT20) 5 for 802.11n (HT40) 2 for 802.11ac (VHT80) 5745 ~ 5825 MHz: 5 for 802.11a, 802.11n (HT20) 2 for 802.11n (HT40) 1 for 802.11ac (VHT80)
Output Power	14.322 mW for 5180 ~ 5240 MHz 15.959 mW for 5260 ~ 5320 MHz 16.331 mW for 5500 ~ 5700 MHz 12.359 mW for 5745 ~ 5825 MHz
Antenna Type	PCB antenna with 3.15 dBi gain (5180 ~ 5240 MHz) PCB antenna with 2.95 dBi gain (5260 ~ 5320 MHz) PCB antenna with 2.87 dBi gain (5500 ~ 5700 MHz) PCB antenna with 3.13 dBi gain (5745 ~ 5825 MHz)
Antenna Connector	N/A
Accessory Device	Refer to Note as below
Data Cable Supplied	Refer to Note as below

Note:

1. The EUT provides one transmitter and receiver.

Modulation Mode	Tx Function
802.11b	1TX
802.11g	1TX
802.11a	1TX
802.11n (HT20)	1TX
802.11n (HT40)	1TX
802.11ac (HT20)	1TX
802.11ac (HT40)	1TX
802.11ac (VHT80)	1TX

* The modulation and bandwidth are similar for 802.11n mode for HT20 / HT40 and 802.11ac mode for HT20 / HT40, therefore investigated worst case to representative mode in test report. (Final test mode refer section 3.2.1)

2. The EUT contains following accessory devices.

Product	Brand	Model	Description
Adapter 1	Verifone	AM11A-050A	I/P: 100-240 Vac, 50/60 Hz, 500 mA O/P: 5 Vdc, 2.2 A 1.75m non-shielded cable w/o core Manufacturer: Phihong
Adapter 2	Verifone	VF0402	I/P: 100-240 Vac, 50/60 Hz, 500 mA O/P: 5 Vdc, 2.2 A 1.75m non-shielded cable w/o core Manufacturer: Salcomp
Battery	Verifone	BPK475-001	3.85 Vdc, 2890 mAh

3. The above EUT information is declared by manufacturer and for more detailed features description, please refer to the manufacturer's specifications or user's manual.

3.2 Description of Test Modes

For 5180 ~ 5240 MHz

4 channels are provided for 802.11a, 802.11n (HT20):

Channel	Frequency (MHz)	Channel	Frequency (MHz)
36	5180	44	5220
40	5200	48	5240

2 channels are provided for 802.11n (HT40):

Channel	Frequency (MHz)	Channel	Frequency (MHz)
38	5190	46	5230

1 channel is provided for 802.11ac (VHT80):

Channel	Frequency (MHz)
42	5210

For 5260 ~ 5320 MHz

4 channels are provided for 802.11a, 802.11n (HT20):

Channel	Frequency (MHz)	Channel	Frequency (MHz)
52	5260	60	5300
56	5280	64	5320

2 channels are provided for 802.11n (HT40):

Channel	Frequency (MHz)	Channel	Frequency (MHz)
54	5270	62	5310

1 channel is provided for 802.11ac (VHT80):

Channel	Frequency (MHz)
58	5290

For 5500 ~ 5700 MHz

11 channels are provided for 802.11a, 802.11n (HT20):

Channel	Frequency (MHz)	Channel	Frequency (MHz)
100	5500	124	5620
104	5520	128	5640
108	5540	132	5660
112	5560	136	5680
116	5580	140	5700
120	5600		

5 channels are provided for 802.11n (HT40):

Channel	Frequency (MHz)	Channel	Frequency (MHz)
102	5510	126	5630
110	5550	134	5670
118	5590		

2 channels are provided for 802.11ac (VHT80):

Channel	Frequency (MHz)	Channel	Frequency (MHz)
106	5530	122	5610

For 5745 ~ 5825 MHz

5 channels are provided for 802.11a, 802.11n (HT20):

Channel	Frequency (MHz)	Channel	Frequency (MHz)
149	5745	161	5805
153	5765	165	5825
157	5785		

2 channels are provided for 802.11n (HT40):

Channel	Frequency (MHz)	Channel	Frequency (MHz)
151	5755	159	5795

1 channel is provided for 802.11ac (VHT80):

Channel	Frequency (MHz)
155	5775

3.2.1 Test Mode Applicability and Tested Channel Detail

EUT Configure Mode	Applicable To				Description
	RE \geq 1G	RE $<$ 1G	PLC	APCM	
-	√	√	√	√	-

Where **RE \geq 1G**: Radiated Emission above 1 GHz **RE $<$ 1G**: Radiated Emission below 1 GHz
PLC: Power Line Conducted Emission **APCM**: Antenna Port Conducted Measurement

Note:

1. The EUT had been pre-tested on the positioned of each 3 axis. The worst case was found when positioned on **X-plane**.
2. "-" means no effect.

Radiated Emission Test (Above 1 GHz):

- Pre-Scan has been conducted to determine the worst-case mode from all possible combinations between available modulations, data rates and antenna ports (if EUT with antenna diversity architecture).
- Following channel(s) was (were) selected for the final test as listed below.

EUT Configure Mode	Frequency Band (MHz)	Mode	Available Channel	Tested Channel	Modulation Technology	Modulation Type	Data Rate (Mbps)
-	5180-5240	802.11a	36 to 48	36, 44, 48	OFDM	BPSK	6.0
-		802.11n (HT20)	36 to 48	36, 44, 48	OFDM	BPSK	MCS0
-		802.11n (HT40)	38 to 46	38, 46	OFDM	BPSK	MCS0
-		802.11ac (VHT80)	42	42	OFDM	BPSK	V0
-	5260-5320	802.11a	52 to 64	52, 60, 64	OFDM	BPSK	6.0
-		802.11n (HT20)	52 to 64	52, 60, 64	OFDM	BPSK	MCS0
-		802.11n (HT40)	54 to 62	54, 62	OFDM	BPSK	MCS0
-		802.11ac (VHT80)	58	58	OFDM	BPSK	V0
-	5500-5700	802.11a	100 to 140	100, 116, 140	OFDM	BPSK	6.0
-		802.11n (HT20)	100 to 140	100, 116, 140	OFDM	BPSK	MCS0
-		802.11n (HT40)	102 to 134	102, 110, 134	OFDM	BPSK	MCS0
-		802.11ac (VHT80)	106 to 122	106, 122	OFDM	BPSK	V0
-	5745-5825	802.11a	149 to 165	149, 157, 165	OFDM	BPSK	6.0
-		802.11n (HT20)	149 to 165	149, 157, 165	OFDM	BPSK	MCS0
-		802.11n (HT40)	151 to 159	151, 159	OFDM	BPSK	MCS0
-		802.11ac (VHT80)	155	155	OFDM	BPSK	V0

Radiated Emission Test (Below 1 GHz):

- Pre-Scan has been conducted to determine the worst-case mode from all possible combinations between available modulations, data rates and antenna ports (if EUT with antenna diversity architecture).
- Following channel(s) was (were) selected for the final test as listed below.

EUT Configure Mode	Frequency Band (MHz)	Mode	Available Channel	Tested Channel	Modulation Technology	Modulation Type	Data Rate (Mbps)
-	5180-5240	802.11ac (VHT80)	42	42	OFDM	BPSK	V0
-	5260-5320	802.11n (HT40)	54 to 62	62	OFDM	BPSK	MCS0
-	5500-5700	802.11a	100 to 140	140	OFDM	BPSK	6.0
-	5745-5825	802.11a	149 to 165	149	OFDM	BPSK	6.0

Power Line Conducted Emission Test:

Pre-Scan has been conducted to determine the worst-case mode from all possible combinations between available modulations, data rates and antenna ports (if EUT with antenna diversity architecture).

Following channel(s) was (were) selected for the final test as listed below.

EUT Configure Mode	Frequency Band (MHz)	Mode	Available Channel	Tested Channel	Modulation Technology	Modulation Type	Data Rate (Mbps)
-	5180-5320	802.11ac (VHT80)	42	42	OFDM	BPSK	V0

Antenna Port Conducted Measurement:

This item includes all test value of each mode, but only includes spectrum plot of worst value of each mode.

Pre-Scan has been conducted to determine the worst-case mode from all possible combinations between available modulations, data rates and antenna ports (if EUT with antenna diversity architecture).

Following channel(s) was (were) selected for the final test as listed below.

EUT Configure Mode	Frequency Band (MHz)	Mode	Available Channel	Tested Channel	Modulation Technology	Modulation Type	Data Rate (Mbps)
-	5180-5240	802.11a	36 to 48	36, 44, 48	OFDM	BPSK	6.0
-		802.11n (HT20)	36 to 48	36, 44, 48	OFDM	BPSK	MCS0
-		802.11n (HT40)	38 to 46	38, 46	OFDM	BPSK	MCS0
-		802.11ac (VHT80)	42	42	OFDM	BPSK	V0
-	5260-5320	802.11a	52 to 64	52, 60, 64	OFDM	BPSK	6.0
-		802.11n (HT20)	52 to 64	52, 60, 64	OFDM	BPSK	MCS0
-		802.11n (HT40)	54 to 62	54, 62	OFDM	BPSK	MCS0
-		802.11ac (VHT80)	58	58	OFDM	BPSK	V0
-	5500-5700	802.11a	100 to 140	100, 116, 140	OFDM	BPSK	6.0
-		802.11n (HT20)	100 to 140	100, 116, 140	OFDM	BPSK	MCS0
-		802.11n (HT40)	102 to 134	102, 110, 134	OFDM	BPSK	MCS0
-		802.11ac (VHT80)	106 to 122	106, 122	OFDM	BPSK	V0
-	5745-5825	802.11a	149 to 165	149, 157, 165	OFDM	BPSK	6.0
-		802.11n (HT20)	149 to 165	149, 157, 165	OFDM	BPSK	MCS0
-		802.11n (HT40)	151 to 159	151, 159	OFDM	BPSK	MCS0
-		802.11ac (VHT80)	155	155	OFDM	BPSK	V0

Test Condition:

Applicable To	Environmental Conditions	Input Power	Tested by
RE \geq 1G	25 deg. C, 65 % RH	120 Vac, 60 Hz	Getaz Yang
RE $<$ 1G	25 deg. C, 65 % RH	120 Vac, 60 Hz	Getaz Yang
PLC	25 deg. C, 65 % RH	120 Vac, 60 Hz	Toby Tian
APCM	25 deg. C, 65 % RH	3.85 Vdc	Carlos Chen

3.3 Duty Cycle of Test Signal

MODULATION TYPE: BPSK

Duty cycle of test signal is < 98 %, duty factor is required.

802.11a: Duty cycle = $1.425/1.456 = 0.979$, Duty factor = $10 * \log(1/0.979) = 0.09$

802.11n (HT20): Duty cycle of test signal is > 98 %, duty factor is not required.

802.11n (HT40): Duty cycle = $663/685 = 0.968$, Duty factor = $10 * \log(1/0.968) = 0.14$

802.11ac (VHT80): Duty cycle = $325/360 = 0.903$, Duty factor = $10 * \log(1/0.903) = 0.44$

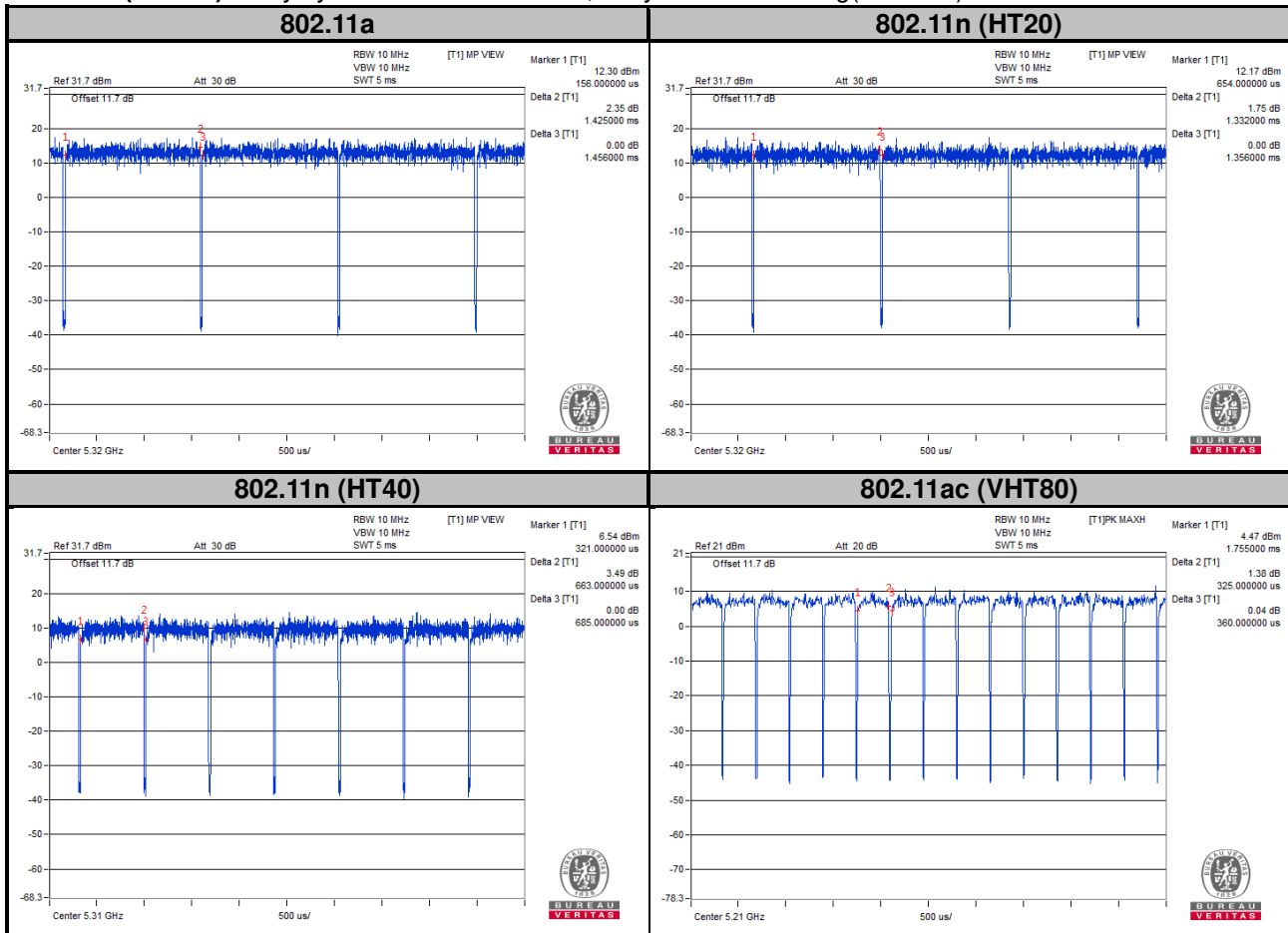

3.4 Description of Support Units

The EUT has been tested as an independent unit together with other necessary accessories or support units.

3.4.1 Configuration of System under Test

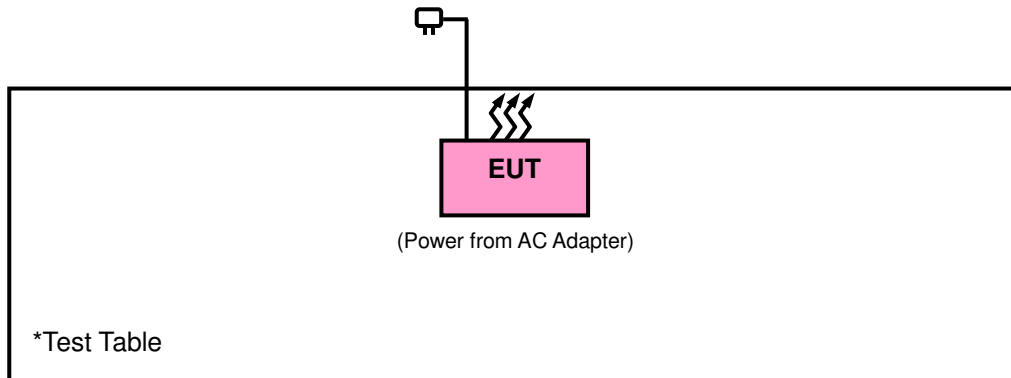

3.5 General Description of Applied Standards

The EUT is a RF Product. According to the specifications of the manufacturer, it must comply with the requirements of the following standards:

FCC Part 15, Subpart E (15.407)

789033 D02 General UNII Test Procedures New Rules v01r03

644545 D01 Guidance for IEEE 802 11ac v01r02

ANSI C63.10-2013

All test items have been performed and recorded as per the above standards.

Note: The EUT has been verified to comply with the requirements of FCC Part 15, Subpart B, Class B (DoC).
The test report has been issued separately.

4 Test Types and Results

4.1 Radiated Emission and Bandedge Measurement

4.1.1 Limits of Radiated Emission and Bandedge Measurement

Radiated emissions which fall in the restricted bands must comply with the radiated emission limits specified as below table. Other emissions shall be at least 20 dB below the highest level of the desired power:

Frequencies (MHz)	Field Strength (microvolts/meter)	Measurement Distance (meters)
0.009 ~ 0.490	2400/F (kHz)	300
0.490 ~ 1.705	24000/F (kHz)	30
1.705 ~ 30.0	30	30
30 ~ 88	100	3
88 ~ 216	150	3
216 ~ 960	200	3
Above 960	500	3

Note:

1. The lower limit shall apply at the transition frequencies.
2. Emission level (dBuV/m) = 20 log Emission level (uV/m).
3. For frequencies above 1000 MHz, the field strength limits are based on average detector, however, the peak field strength of any emission shall not exceed the maximum permitted average limits, specified above by more than 20 dB under any condition of modulation.

4.1.2 Limits of Unwanted Emission Out of the Restricted Bands

Applicable To		Limit	
789033 D02 General UNII Test Procedures New Rules v01r03		Field Strength at 3 m	
		PK: 74 (dBμV/m)	AV: 54 (dBμV/m)
Frequency Band	Applicable To	EIRP Limit	Equivalent Field Strength at 3 m
5150~5250 MHz	15.407(b)(1)	PK: -27 (dBm/MHz)	PK: 68.2 (dBμV/m)
5250~5350 MHz	15.407(b)(2)		
5470~5725 MHz	15.407(b)(3)		
5725~5850 MHz	15.407(b)(4)(i)	PK:-27 (dBm/MHz) ^{*1} PK:10 (dBm/MHz) ^{*2} PK:15.6 (dBm/MHz) ^{*3} PK:27 (dBm/MHz) ^{*4}	PK: 68.2 (dBμV/m) ^{*1} PK:105.2 (dBμV/m) ^{*2} PK: 110.8 (dBμV/m) ^{*3} PK:122.2 (dBμV/m) ^{*4}
	15.407(b)(4)(ii)	Emission limits in section 15.247(d)	

^{*1} beyond 75 MHz or more above of the band edge.

^{*2} below the band edge increasing linearly to 10 dBm/MHz at 25 MHz above.

^{*3} below the band edge increasing linearly to a level of 15.6 dBm/MHz at 5 MHz above.

^{*4} from 5 MHz above or below the band edge increasing linearly to a level of 27 dBm/MHz at the band edge.

Note:

The following formula is used to convert the equipment isotropic radiated power (eirp) to field strength:

$$E = \frac{1000000\sqrt{30P}}{3} \mu\text{V/m, where } P \text{ is the eirp (Watts).}$$

4.1.3 Test Instruments

Description & Manufacturer	Model No.	Serial No.	Date of Calibration	Due Date of Calibration
Test Receiver Agilent	N9038A	MY51210203	Jan. 21, 2016	Jan. 20, 2017
Spectrum Analyzer Agilent	N9010A	MY52220314	Dec. 16, 2016	Dec. 15, 2017
Spectrum Analyzer ROHDE & SCHWARZ	FSU43	101261	Dec. 17, 2015	Dec. 16, 2016
BILOG Antenna SCHWARZBECK	VULB9168	9168-472	Jan. 07, 2016	Jan. 06, 2017
HORN Antenna SCHWARZBECK	BBHA 9120 D	9120D-969	Jan. 04, 2016	Jan. 03, 2017
HORN Antenna SCHWARZBECK	BBHA 9170	9170-480	Jan. 08, 2016	Jan. 07, 2017
Fixed Attenuator Mini-Circuits	BW-N10W5+	NA	Jul. 08, 2016	Jul. 07, 2017
Loop Antenna	EM-6879	269	Aug. 11, 2016	Aug. 10, 2017
Bluetooth Tester	CBT	100980	Apr. 27, 2015	Apr. 26, 2017
Preamplifier EMCI	EMC 012645	980115	Oct. 21, 2016	Oct. 20, 2017
Preamplifier EMCI	EMC 184045	980116	Oct. 21, 2016	Oct. 20, 2017
Preamplifier EMCI	EMC 330H	980112	Oct. 21, 2016	Oct. 20, 2017
Power Meter Anritsu	ML2495A	1232002	Sep. 08, 2016	Sep. 07, 2017
Power Sensor Anritsu	MA2411B	1207325	Sep. 08, 2016	Sep. 07, 2017
RF signal cable HUBER+SUHNNER	SUCOFLEX 104	309219/4 2950114	Oct. 21, 2016	Oct. 20, 2017
RF signal cable HUBER+SUHNNER	SUCOFLEX 104	250130/4	Oct. 21, 2016	Oct. 20, 2017
RF Coaxial Cable Worken	8D-FB	Cable-Ch10-01	Oct. 21, 2016	Oct. 20, 2017
Software BV ADT	E3 6.120103	NA	NA	NA
Antenna Tower MF	MFA-440H	NA	NA	NA
Turn Table MF	MFT-201SS	NA	NA	NA
Antenna Tower & Turn Table Controller MF	MF-7802	NA	NA	NA
Fixed Attenuator Mini-Circuits	BW-N10W5+	NA	Jul. 08, 2016	Jul. 07, 2017

- Note: 1. The calibration interval of the above test instruments is 12 / 24 months and the calibrations are traceable to NML/ROC and NIST/USA.
2. The test was performed in HwaYa Chamber 10.
3. The horn antenna and preamplifier (model: EMC 184045) are used only for the measurement of emission frequency above 1 GHz if tested.
4. The FCC Site Registration No. is 690701.
5. The IC Site Registration No. is IC7450F-10.

4.1.4 Test Procedures

- a. The EUT was placed on the top of a rotating table 0.8 meters (for below 1 GHz) / 1.5 meters (for above 1 GHz) above the ground at 3 meter chamber room for test. The table was rotated 360 degrees to determine the position of the highest radiation.
- b. The EUT was set 3 meters away from the interference-receiving antenna, which was mounted on the top of a variable-height antenna tower.
- c. The height of antenna is varied from one meter to four meters above the ground to determine the maximum value of the field strength. Both horizontal and vertical polarizations of the antenna are set to make the measurement.
- d. For each suspected emission, the EUT was arranged to its worst case and then the antenna was tuned to heights from 1 meter to 4 meters and the rotatable table was turned from 0 degrees to 360 degrees to find the maximum reading.
- e. The test-receiver system was set to quasi-peak detect function and specified bandwidth with maximum hold mode when the test frequency is below 1 GHz.
- f. The test-receiver system was set to peak and average detected function and specified bandwidth with maximum hold mode when the test frequency is above 1 GHz. If the peak reading value also meets average limit, measurement with the average detector is unnecessary.

Note:

1. The resolution bandwidth and video bandwidth of test receiver/spectrum analyzer is 120 kHz & 360 kHz for Quasi-peak detection (QP) at frequency below 1 GHz.
2. The resolution bandwidth of test receiver/spectrum analyzer is 1 MHz and the video bandwidth is 3 MHz for Peak detection (PK) at frequency above 1 GHz.
3. The resolution bandwidth of test receiver/spectrum analyzer is 1 MHz and the video bandwidth is 1/T for RMS Average (Duty cycle < 98 %) for Peak detection at frequency above 1 GHz.
4. The resolution bandwidth of test receiver/spectrum analyzer is 1 MHz and the video bandwidth is 10 Hz (Duty cycle ≥ 98 %) for Average detection (AV) at frequency above 1 GHz.
5. All modes of operation were investigated and the worst-case emissions are reported.

4.1.5 Deviation from Test Standard

No deviation.

4.1.6 Test Set Up

<Frequency Range below 1 GHz>

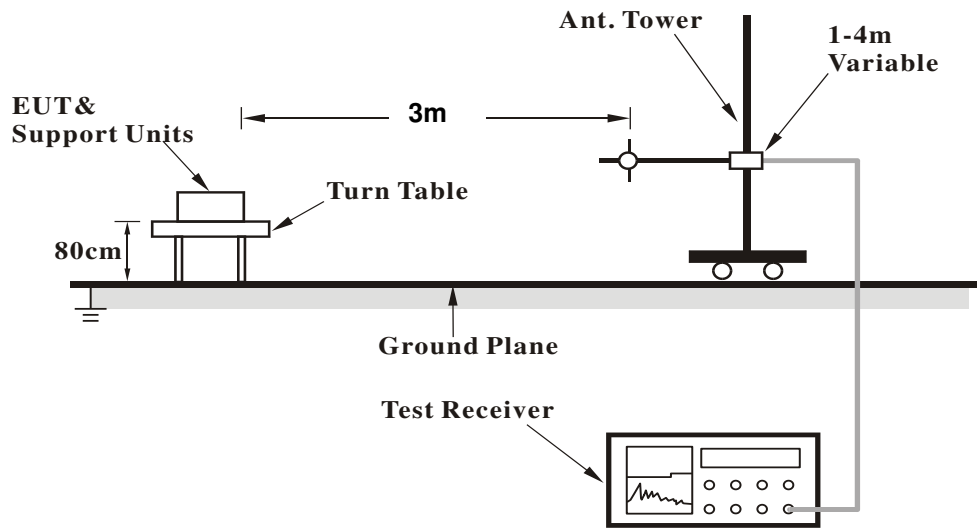

<Frequency Range above 1 GHz>

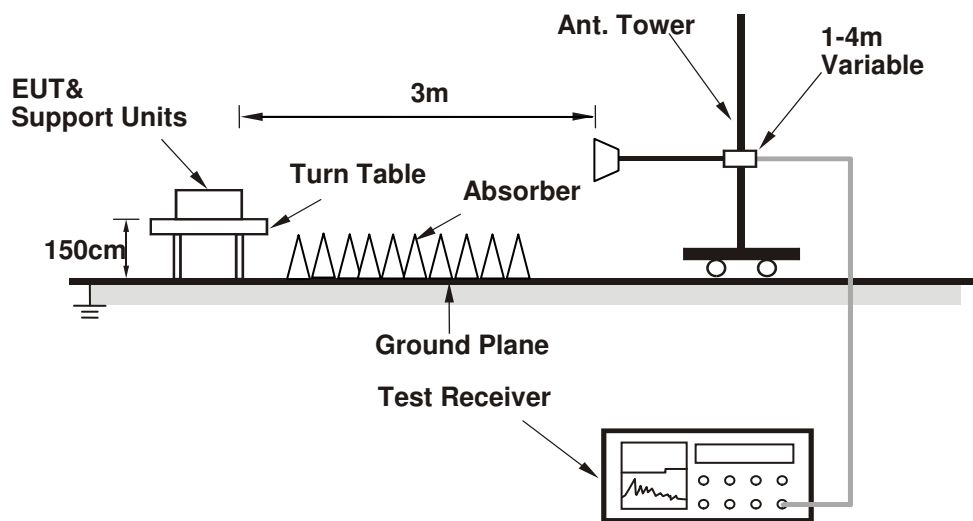

For the actual test configuration, please refer to the attached file (Test Setup Photo).

4.1.7 EUT Operating Conditions

- a. Placed the EUT on a testing table.
- b. Use the software to control the EUT under transmission condition continuously at specific channel frequency.

4.1.8 Test Results
Above 1 GHz Data :
802.11a

EUT Test Condition		Measurement Detail	
Channel	Channel 36	Frequency Range	1 GHz ~ 40 GHz
Input Power	120 Vac, 60 Hz	Detector Function	Peak (PK) Average (AV)
Environmental Conditions	25 deg. C, 65 % RH	Tested By	Getaz Yang

Antenna Polarity & Test Distance: Horizontal at 3 m										
Frequency (MHz)	Emission Level (dBuV/m)	Read Level (dBuV)	Limit (dBuV/m)	Margin (dB)	Antenna Factor (dB/m)	Cable Loss (dB)	Preamp Factor (dB)	Antenna Height (cm)	Table Angle (Degree)	Remark
5146	49.61	49.41	54	-4.39	31.32	6.2	37.32	200	277	Average
5146	64.54	64.34	74	-9.46	31.32	6.2	37.32	200	277	Peak
5180	95.54	95.31			31.35	6.22	37.34	200	277	Average
5180	103.19	102.96			31.35	6.22	37.34	200	277	Peak
5450	41.24	40.42	54	-12.76	31.56	6.34	37.08	200	277	Average
5450	60.25	59.43	74	-13.75	31.56	6.34	37.08	200	277	Peak
*10360	53.74	57.64	68.2	-14.46	39.19	9.05	52.14	100	188	Peak
Antenna Polarity & Test Distance: Vertical at 3 m										
Frequency (MHz)	Emission Level (dBuV/m)	Read Level (dBuV)	Limit (dBuV/m)	Margin (dB)	Antenna Factor (dB/m)	Cable Loss (dB)	Preamp Factor (dB)	Antenna Height (cm)	Table Angle (Degree)	Remark
5064	44.79	44.62	54	-9.21	31.25	6.17	37.25	200	177	Average
5064	60.67	60.5	74	-13.33	31.25	6.17	37.25	200	177	Peak
5180	90.69	90.46			31.35	6.22	37.34	200	177	Average
5180	98.08	97.85			31.35	6.22	37.34	200	177	Peak
5372	40.99	40.37	54	-13.01	31.49	6.31	37.18	200	177	Average
5372	60.79	60.17	74	-13.21	31.49	6.31	37.18	200	177	Peak
*10360	52.7	56.6	68.2	-15.5	39.19	9.05	52.14	101	302	Peak

Remarks:

- Emission Level = Read Level + Antenna Factor + Cable Loss - Preamp Factor
 Margin value = Emission level – Limit value
- 5180 MHz: Fundamental Frequency
- *: Out of Restricted Band

EUT Test Condition		Measurement Detail	
Channel	Channel 44	Frequency Range	1 GHz ~ 40 GHz
Input Power	120 Vac, 60 Hz	Detector Function	Peak (PK) Average (AV)
Environmental Conditions	25 deg. C, 65 % RH	Tested By	Getaz Yang

Antenna Polarity & Test Distance: Horizontal at 3 m										
Frequency (MHz)	Emission Level (dBuV/m)	Read Level (dBuV)	Limit (dBuV/m)	Margin (dB)	Antenna Factor (dB/m)	Cable Loss (dB)	Preamp Factor (dB)	Antenna Height (cm)	Table Angle (Degree)	Remark
5022	41.1	40.96	54	-12.9	31.23	6.15	37.24	200	260	Average
5022	59.43	59.29	74	-14.57	31.23	6.15	37.24	200	260	Peak
5220	95.99	95.74			31.37	6.24	37.36	200	260	Average
5220	103.54	103.29			31.37	6.24	37.36	200	260	Peak
5460	41.61	40.79	54	-12.39	31.56	6.34	37.08	200	260	Average
5460	61.32	60.5	74	-12.68	31.56	6.34	37.08	200	260	Peak
*10440	49.35	53.45	68.2	-18.85	39.29	9.09	52.48	100	179	Peak

Antenna Polarity & Test Distance: Vertical at 3 m										
Frequency (MHz)	Emission Level (dBuV/m)	Read Level (dBuV)	Limit (dBuV/m)	Margin (dB)	Antenna Factor (dB/m)	Cable Loss (dB)	Preamp Factor (dB)	Antenna Height (cm)	Table Angle (Degree)	Remark
5064	40.66	40.49	54	-13.34	31.25	6.17	37.25	200	172	Average
5064	59.81	59.64	74	-14.19	31.25	6.17	37.25	200	172	Peak
5220	90.96	90.71			31.37	6.24	37.36	200	172	Average
5220	98.29	98.04			31.37	6.24	37.36	200	172	Peak
5450	41.37	40.55	54	-12.63	31.56	6.34	37.08	200	172	Average
5450	61.05	60.23	74	-12.95	31.56	6.34	37.08	200	172	Peak
*10440	49.05	53.15	68.2	-19.15	39.29	9.09	52.48	101	303	Peak

Remarks:

- Emission Level = Read Level + Antenna Factor + Cable Loss - Preamp Factor
Margin value = Emission level – Limit value
- 5220 MHz: Fundamental Frequency
- *: Out of Restricted Band

EUT Test Condition		Measurement Detail	
Channel	Channel 48	Frequency Range	1 GHz ~ 40 GHz
Input Power	120 Vac, 60 Hz	Detector Function	Peak (PK) Average (AV)
Environmental Conditions	25 deg. C, 65 % RH	Tested By	Getaz Yang

Antenna Polarity & Test Distance: Horizontal at 3 m										
Frequency (MHz)	Emission Level (dBuV/m)	Read Level (dBuV)	Limit (dBuV/m)	Margin (dB)	Antenna Factor (dB/m)	Cable Loss (dB)	Preamp Factor (dB)	Antenna Height (cm)	Table Angle (Degree)	Remark
5032	40.7	40.56	54	-13.3	31.23	6.15	37.24	200	258	Average
5032	59.95	59.81	74	-14.05	31.23	6.15	37.24	200	258	Peak
5230	95.92	95.61			31.39	6.24	37.32	200	258	Average
5230	103.15	102.84			31.39	6.24	37.32	200	258	Peak
5350	41.38	40.79	54	-12.62	31.48	6.29	37.18	200	258	Average
5350	60.13	59.54	74	-13.87	31.48	6.29	37.18	200	258	Peak
*10480	50.03	54.28	68.2	-18.17	39.37	9.09	52.71	101	175	Peak

Antenna Polarity & Test Distance: Vertical at 3 m										
Frequency (MHz)	Emission Level (dBuV/m)	Read Level (dBuV)	Limit (dBuV/m)	Margin (dB)	Antenna Factor (dB/m)	Cable Loss (dB)	Preamp Factor (dB)	Antenna Height (cm)	Table Angle (Degree)	Remark
5070	40.75	40.6	54	-13.25	31.25	6.17	37.27	200	170	Average
5070	59.76	59.61	74	-14.24	31.25	6.17	37.27	200	170	Peak
5240	91.02	90.7			31.39	6.25	37.32	200	170	Average
5240	98	97.68			31.39	6.25	37.32	200	170	Peak
5404	41.23	40.57	54	-12.77	31.52	6.32	37.18	200	170	Average
5404	59.96	59.3	74	-14.04	31.52	6.32	37.18	200	170	Peak
*10480	50.35	54.6	68.2	-17.85	39.37	9.09	52.71	101	300	Peak

Remarks:

- Emission Level = Read Level + Antenna Factor + Cable Loss - Preamp Factor
Margin value = Emission level – Limit value
- 5240 MHz: Fundamental Frequency
- *: Out of Restricted Band

EUT Test Condition		Measurement Detail	
Channel	Channel 52	Frequency Range	1 GHz ~ 40 GHz
Input Power	120 Vac, 60 Hz	Detector Function	Peak (PK) Average (AV)
Environmental Conditions	25 deg. C, 65 % RH	Tested By	Getaz Yang

Antenna Polarity & Test Distance: Horizontal at 3 m										
Frequency (MHz)	Emission Level (dBuV/m)	Read Level (dBuV)	Limit (dBuV/m)	Margin (dB)	Antenna Factor (dB/m)	Cable Loss (dB)	Preamp Factor (dB)	Antenna Height (cm)	Table Angle (Degree)	Remark
5002	40.66	40.56	54	-13.34	31.2	6.13	37.23	217	257	Average
5002	59.66	59.56	74	-14.34	31.2	6.13	37.23	217	257	Peak
5260	96.04	95.65			31.41	6.25	37.27	217	257	Average
5260	103.39	103			31.41	6.25	37.27	217	257	Peak
5426	41.37	40.65	54	-12.63	31.53	6.32	37.13	217	257	Average
5426	59.91	59.19	74	-14.09	31.53	6.32	37.13	217	257	Peak
*10520	51.47	55.75	68.2	-16.73	39.43	9.12	52.83	150	160	Peak

Antenna Polarity & Test Distance: Vertical at 3 m										
Frequency (MHz)	Emission Level (dBuV/m)	Read Level (dBuV)	Limit (dBuV/m)	Margin (dB)	Antenna Factor (dB/m)	Cable Loss (dB)	Preamp Factor (dB)	Antenna Height (cm)	Table Angle (Degree)	Remark
5048	40.61	40.47	54	-13.39	31.24	6.15	37.25	208	170	Average
5048	60.29	60.15	74	-13.71	31.24	6.15	37.25	208	170	Peak
5260	91.75	91.36			31.41	6.25	37.27	208	170	Average
5260	98.63	98.24			31.41	6.25	37.27	208	170	Peak
5460	41.17	40.35	54	-12.83	31.56	6.34	37.08	208	170	Average
5460	60.21	59.39	74	-13.79	31.56	6.34	37.08	208	170	Peak
*10520	51.54	55.82	68.2	-16.66	39.43	9.12	52.83	103	31	Peak

Remarks:

- Emission Level = Read Level + Antenna Factor + Cable Loss - Preamp Factor
Margin value = Emission level – Limit value
- 5260 MHz: Fundamental Frequency
- *: Out of Restricted Band

EUT Test Condition		Measurement Detail	
Channel	Channel 60	Frequency Range	1 GHz ~ 40 GHz
Input Power	120 Vac, 60 Hz	Detector Function	Peak (PK) Average (AV)
Environmental Conditions	25 deg. C, 65 % RH	Tested By	Getaz Yang

Antenna Polarity & Test Distance: Horizontal at 3 m										
Frequency (MHz)	Emission Level (dBuV/m)	Read Level (dBuV)	Limit (dBuV/m)	Margin (dB)	Antenna Factor (dB/m)	Cable Loss (dB)	Preamp Factor (dB)	Antenna Height (cm)	Table Angle (Degree)	Remark
5060	40.76	40.59	54	-13.24	31.25	6.17	37.25	201	256	Average
5060	60.15	59.98	74	-13.85	31.25	6.17	37.25	201	256	Peak
5300	95.95	95.43			31.44	6.27	37.19	201	256	Average
5300	103.17	102.65			31.44	6.27	37.19	201	256	Peak
5444	42.55	41.79	54	-11.45	31.55	6.34	37.13	201	256	Average
5444	60.66	59.9	74	-13.34	31.55	6.34	37.13	201	256	Peak
10600	41.63	45.31	54	-12.37	39.57	9.16	52.41	148	162	Average
10600	51.65	55.33	74	-22.35	39.57	9.16	52.41	148	162	Peak

Antenna Polarity & Test Distance: Vertical at 3 m										
Frequency (MHz)	Emission Level (dBuV/m)	Read Level (dBuV)	Limit (dBuV/m)	Margin (dB)	Antenna Factor (dB/m)	Cable Loss (dB)	Preamp Factor (dB)	Antenna Height (cm)	Table Angle (Degree)	Remark
5078	40.68	40.51	54	-13.32	31.27	6.17	37.27	205	169	Average
5078	59.48	59.31	74	-14.52	31.27	6.17	37.27	205	169	Peak
5300	91.22	90.7			31.44	6.27	37.19	205	169	Average
5300	98.23	97.71			31.44	6.27	37.19	205	169	Peak
5418	41.41	40.74	54	-12.59	31.53	6.32	37.18	205	169	Average
5418	60.18	59.51	74	-13.82	31.53	6.32	37.18	205	169	Peak
10600	41.98	45.66	54	-12.02	39.57	9.16	52.41	102	33	Average
10600	51.74	55.42	74	-22.26	39.57	9.16	52.41	102	33	Peak

Remarks:

- Emission Level = Read Level + Antenna Factor + Cable Loss - Preamp Factor
Margin value = Emission level – Limit value
- 5300 MHz: Fundamental Frequency

EUT Test Condition		Measurement Detail	
Channel	Channel 64	Frequency Range	1 GHz ~ 40 GHz
Input Power	120 Vac, 60 Hz	Detector Function	Peak (PK) Average (AV)
Environmental Conditions	25 deg. C, 65 % RH	Tested By	Getaz Yang

Antenna Polarity & Test Distance: Horizontal at 3 m										
Frequency (MHz)	Emission Level (dBuV/m)	Read Level (dBuV)	Limit (dBuV/m)	Margin (dB)	Antenna Factor (dB/m)	Cable Loss (dB)	Preamp Factor (dB)	Antenna Height (cm)	Table Angle (Degree)	Remark
5124	40.58	40.38	54	-13.42	31.31	6.19	37.3	203	259	Average
5124	61.22	61.02	74	-12.78	31.31	6.19	37.3	203	259	Peak
5320	95.62	95.07			31.45	6.29	37.19	203	259	Average
5320	102.76	102.21			31.45	6.29	37.19	203	259	Peak
5350	44.19	43.6	54	-9.81	31.48	6.29	37.18	203	259	Average
5350	62.46	61.87	74	-11.54	31.48	6.29	37.18	203	259	Peak
10640	40.77	44.22	54	-13.23	39.62	9.2	52.27	151	161	Average
10640	47.93	51.38	74	-26.07	39.62	9.2	52.27	151	161	Peak

Antenna Polarity & Test Distance: Vertical at 3 m										
Frequency (MHz)	Emission Level (dBuV/m)	Read Level (dBuV)	Limit (dBuV/m)	Margin (dB)	Antenna Factor (dB/m)	Cable Loss (dB)	Preamp Factor (dB)	Antenna Height (cm)	Table Angle (Degree)	Remark
5044	40.45	40.31	54	-13.55	31.24	6.15	37.25	205	166	Average
5044	60.56	60.42	74	-13.44	31.24	6.15	37.25	205	166	Peak
5320	91.14	90.59			31.45	6.29	37.19	205	166	Average
5320	98.2	97.65			31.45	6.29	37.19	205	166	Peak
5350	42.2	41.61	54	-11.8	31.48	6.29	37.18	205	166	Average
5350	61.78	61.19	74	-12.22	31.48	6.29	37.18	205	166	Peak
10640	41.23	44.68	54	-12.77	39.62	9.2	52.27	102	33	Average
10640	49.24	52.69	74	-24.76	39.62	9.2	52.27	102	33	Peak

Remarks:

- Emission Level = Read Level + Antenna Factor + Cable Loss - Preamp Factor
Margin value = Emission level – Limit value
- 5320 MHz: Fundamental Frequency

EUT Test Condition		Measurement Detail	
Channel	Channel 100	Frequency Range	1 GHz ~ 40 GHz
Input Power	120 Vac, 60 Hz	Detector Function	Peak (PK) Average (AV)
Environmental Conditions	25 deg. C, 65 % RH	Tested By	Getaz Yang

Antenna Polarity & Test Distance: Horizontal at 3 m										
Frequency (MHz)	Emission Level (dBuV/m)	Read Level (dBuV)	Limit (dBuV/m)	Margin (dB)	Antenna Factor (dB/m)	Cable Loss (dB)	Preamp Factor (dB)	Antenna Height (cm)	Table Angle (Degree)	Remark
5352	42.69	42.1	54	-11.31	31.48	6.29	37.18	200	253	Average
5352	60.32	59.73	74	-13.68	31.48	6.29	37.18	200	253	Peak
*5470	60.29	59.47	68.2	-7.91	31.56	6.34	37.08	200	253	Peak
5500	93.35	92.42			31.6	6.36	37.03	200	253	Average
5500	100.61	99.68			31.6	6.36	37.03	200	253	Peak
*5725	58.73	57.45	68.2	-9.47	31.96	6.75	37.43	200	253	Peak
11000	42.45	46.35	54	-11.55	40.2	9.35	53.45	100	180	Average
11000	52.54	56.44	74	-21.46	40.2	9.35	53.45	100	180	Peak

Antenna Polarity & Test Distance: Vertical at 3 m										
Frequency (MHz)	Emission Level (dBuV/m)	Read Level (dBuV)	Limit (dBuV/m)	Margin (dB)	Antenna Factor (dB/m)	Cable Loss (dB)	Preamp Factor (dB)	Antenna Height (cm)	Table Angle (Degree)	Remark
5406	41.7	41.04	54	-12.3	31.52	6.32	37.18	195	173	Average
5406	60.01	59.35	74	-13.99	31.52	6.32	37.18	195	173	Peak
*5470	60.13	59.3	68.2	-8.07	31.57	6.34	37.08	195	173	Peak
5500	90.19	89.26			31.6	6.36	37.03	195	173	Average
5500	97.26	96.33			31.6	6.36	37.03	195	173	Peak
*5725	58.3	57.02	68.2	-9.9	31.96	6.75	37.43	195	173	Peak
11000	41.68	45.58	54	-12.32	40.2	9.35	53.45	100	305	Average
11000	51.76	55.66	74	-22.24	40.2	9.35	53.45	100	305	Peak

Remarks:

- Emission Level = Read Level + Antenna Factor + Cable Loss - Preamp Factor
Margin value = Emission level – Limit value
- 5500 MHz: Fundamental Frequency
- *: Out of Restricted Band

EUT Test Condition		Measurement Detail	
Channel	Channel 116	Frequency Range	1 GHz ~ 40 GHz
Input Power	120 Vac, 60 Hz	Detector Function	Peak (PK) Average (AV)
Environmental Conditions	25 deg. C, 65 % RH	Tested By	Getaz Yang

Antenna Polarity & Test Distance: Horizontal at 3 m										
Frequency (MHz)	Emission Level (dBuV/m)	Read Level (dBuV)	Limit (dBuV/m)	Margin (dB)	Antenna Factor (dB/m)	Cable Loss (dB)	Preamp Factor (dB)	Antenna Height (cm)	Table Angle (Degree)	Remark
5388	41.01	40.37	54	-12.99	31.51	6.31	37.18	210	256	Average
5388	59.82	59.18	74	-14.18	31.51	6.31	37.18	210	256	Peak
*5470	57.87	57.04	68.2	-10.33	31.57	6.34	37.08	210	256	Peak
5580	93.38	92.34			31.71	6.49	37.16	210	256	Average
5580	100.19	99.15			31.71	6.49	37.16	210	256	Peak
*5725	60.45	59.17	68.2	-7.75	31.96	6.75	37.43	210	256	Peak
11160	42.61	46.33	54	-11.39	40.1	9.57	53.39	100	273	Average
11160	51.84	55.56	74	-22.16	40.1	9.57	53.39	100	273	Peak

Antenna Polarity & Test Distance: Vertical at 3 m										
Frequency (MHz)	Emission Level (dBuV/m)	Read Level (dBuV)	Limit (dBuV/m)	Margin (dB)	Antenna Factor (dB/m)	Cable Loss (dB)	Preamp Factor (dB)	Antenna Height (cm)	Table Angle (Degree)	Remark
5380	40.82	40.18	54	-13.18	31.51	6.31	37.18	176	180	Average
5380	60.07	59.43	74	-13.93	31.51	6.31	37.18	176	180	Peak
*5470	60.47	59.64	68.2	-7.73	31.57	6.34	37.08	176	180	Peak
5580	90.6	89.56			31.71	6.49	37.16	176	180	Average
5580	97.97	96.93			31.71	6.49	37.16	176	180	Peak
*5725	61.06	59.78	68.2	-7.14	31.96	6.75	37.43	176	180	Peak
11160	41.54	45.26	54	-12.46	40.1	9.57	53.39	100	165	Average
11160	51.04	54.76	74	-22.96	40.1	9.57	53.39	100	165	Peak

Remarks:

- Emission Level = Read Level + Antenna Factor + Cable Loss - Preamp Factor
Margin value = Emission level – Limit value
- 5580 MHz: Fundamental Frequency
- *: Out of Restricted Band

EUT Test Condition		Measurement Detail	
Channel	Channel 140	Frequency Range	1 GHz ~ 40 GHz
Input Power	120 Vac, 60 Hz	Detector Function	Peak (PK) Average (AV)
Environmental Conditions	25 deg. C, 65 % RH	Tested By	Getaz Yang

Antenna Polarity & Test Distance: Horizontal at 3 m										
Frequency (MHz)	Emission Level (dBuV/m)	Read Level (dBuV)	Limit (dBuV/m)	Margin (dB)	Antenna Factor (dB/m)	Cable Loss (dB)	Preamp Factor (dB)	Antenna Height (cm)	Table Angle (Degree)	Remark
5448	40.99	40.22	54	-13.01	31.56	6.34	37.13	207	254	Average
5448	59.92	59.15	74	-14.08	31.56	6.34	37.13	207	254	Peak
*5470	59.61	58.78	68.2	-8.59	31.57	6.34	37.08	207	254	Peak
5700	95.78	94.59			31.9	6.69	37.4	207	254	Average
5700	102.23	101.04			31.9	6.69	37.4	207	254	Peak
*5725	61.7	60.42	68.2	-6.5	31.96	6.75	37.43	207	254	Peak
11400	43.9	46.16	54	-10.1	39.96	9.91	52.13	100	135	Average
11400	53.09	55.35	74	-20.91	39.96	9.91	52.13	100	135	Peak

Antenna Polarity & Test Distance: Vertical at 3 m										
Frequency (MHz)	Emission Level (dBuV/m)	Read Level (dBuV)	Limit (dBuV/m)	Margin (dB)	Antenna Factor (dB/m)	Cable Loss (dB)	Preamp Factor (dB)	Antenna Height (cm)	Table Angle (Degree)	Remark
5360	40.91	40.3	54	-13.09	31.48	6.31	37.18	195	170	Average
5360	60.42	59.81	74	-13.58	31.48	6.31	37.18	195	170	Peak
*5470	58.32	57.49	68.2	-9.88	31.57	6.34	37.08	195	170	Peak
5700	92.56	91.37			31.9	6.69	37.4	195	170	Average
5700	100.23	99.04			31.9	6.69	37.4	195	170	Peak
*5725	61.93	60.65	68.2	-6.27	31.96	6.75	37.43	195	170	Peak
11400	43.6	45.86	54	-10.4	39.96	9.91	52.13	100	253	Average
11400	52.37	54.63	74	-21.63	39.96	9.91	52.13	100	253	Peak

Remarks:

- Emission Level = Read Level + Antenna Factor + Cable Loss - Preamp Factor
Margin value = Emission level – Limit value
- 5700 MHz: Fundamental Frequency
- *: Out of Restricted Band

EUT Test Condition		Measurement Detail	
Channel	Channel 149	Frequency Range	1 GHz ~ 40 GHz
Input Power	120 Vac, 60 Hz	Detector Function	Peak (PK) Average (AV)
Environmental Conditions	25 deg. C, 65 % RH	Tested By	Getaz Yang

<Spurious Emission>

Antenna Polarity & Test Distance: Horizontal at 3 m										
Frequency (MHz)	Emission Level (dBuV/m)	Read Level (dBuV)	Limit (dBuV/m)	Margin (dB)	Antenna Factor (dB/m)	Cable Loss (dB)	Preamp Factor (dB)	Antenna Height (cm)	Table Angle (Degree)	Remark
5745	96.29	95.02			31.99	6.75	37.47	206	253	Average
5745	103.54	102.27			31.99	6.75	37.47	206	253	Peak
11490	44.02	46.91	54	-9.98	39.91	10.03	52.83	100	162	Average
11490	52.76	55.65	74	-21.24	39.91	10.03	52.83	100	162	Peak
Antenna Polarity & Test Distance: Vertical at 3 m										
Frequency (MHz)	Emission Level (dBuV/m)	Read Level (dBuV)	Limit (dBuV/m)	Margin (dB)	Antenna Factor (dB/m)	Cable Loss (dB)	Preamp Factor (dB)	Antenna Height (cm)	Table Angle (Degree)	Remark
5745	93.49	92.22			31.99	6.75	37.47	204	166	Average
5745	101.07	99.8			31.99	6.75	37.47	204	166	Peak
11490	43.51	46.4	54	-10.49	39.91	10.03	52.83	100	184	Average
11490	51.81	54.7	74	-22.19	39.91	10.03	52.83	100	184	Peak

<Out of Band Emission (OOBE)>

Antenna Polarity & Test Distance: Horizontal at 3 m										
Frequency (MHz)	Emission Level (dBuV/m)	Read Level (dBuV)	Limit (dBuV/m)	Margin (dB)	Antenna Factor (dB/m)	Cable Loss (dB)	Preamp Factor (dB)	Antenna Height (cm)	Table Angle (Degree)	Remark
*5640.25	52.2	51.1	68.2	-16	31.82	6.56	37.28	225	255	Peak
5665.425	50.12	48.99	79.65	-29.53	31.85	6.62	37.34	225	255	Peak
5911.95	51.67	49.9	77.83	-26.16	32.26	7.01	37.5	225	255	Peak
*5934.275	49.86	48.06	68.2	-18.34	32.29	7.01	37.5	225	255	Peak
Antenna Polarity & Test Distance: Vertical at 3 m										
Frequency (MHz)	Emission Level (dBuV/m)	Read Level (dBuV)	Limit (dBuV/m)	Margin (dB)	Antenna Factor (dB/m)	Cable Loss (dB)	Preamp Factor (dB)	Antenna Height (cm)	Table Angle (Degree)	Remark
*5642.15	50.36	49.2	68.2	-17.84	31.82	6.62	37.28	163	169	Peak
5666.375	50.27	49.14	80.35	-30.08	31.85	6.62	37.34	163	169	Peak
5920.5	51.16	49.39	71.52	-20.36	32.26	7.01	37.5	163	169	Peak
*5934.275	51.1	49.3	68.2	-17.1	32.29	7.01	37.5	163	169	Peak

Remarks:

- Emission Level = Read Level + Antenna Factor + Cable Loss - Preamp Factor
Margin value = Emission level – Limit value
- 5745 MHz: Fundamental Frequency
- *: Out of Restricted Band

EUT Test Condition		Measurement Detail	
Channel	Channel 157	Frequency Range	1 GHz ~ 40 GHz
Input Power	120 Vac, 60 Hz	Detector Function	Peak (PK) Average (AV)
Environmental Conditions	25 deg. C, 65 % RH	Tested By	Getaz Yang

<Spurious Emission>

Antenna Polarity & Test Distance: Horizontal at 3 m										
Frequency (MHz)	Emission Level (dBuV/m)	Read Level (dBuV)	Limit (dBuV/m)	Margin (dB)	Antenna Factor (dB/m)	Cable Loss (dB)	Preamp Factor (dB)	Antenna Height (cm)	Table Angle (Degree)	Remark
5785	94.01	92.69			32.04	6.82	37.54	209	251	Average
5785	103.53	102.21			32.04	6.82	37.54	209	251	Peak
11570	43.64	47.1	54	-10.36	39.78	10.09	53.33	100	196	Average
11570	52.96	56.42	74	-21.04	39.78	10.09	53.33	100	196	Peak
Antenna Polarity & Test Distance: Vertical at 3 m										
Frequency (MHz)	Emission Level (dBuV/m)	Read Level (dBuV)	Limit (dBuV/m)	Margin (dB)	Antenna Factor (dB/m)	Cable Loss (dB)	Preamp Factor (dB)	Antenna Height (cm)	Table Angle (Degree)	Remark
5785	91.88	90.56			32.04	6.82	37.54	149	169	Average
5785	101.25	99.93			32.04	6.82	37.54	149	169	Peak
11570	42.9	46.36	54	-11.1	39.78	10.09	53.33	100	160	Average
11570	52	55.46	74	-22	39.78	10.09	53.33	100	160	Peak

<Out of Band Emission (OOBE)>

Antenna Polarity & Test Distance: Horizontal at 3 m										
Frequency (MHz)	Emission Level (dBuV/m)	Read Level (dBuV)	Limit (dBuV/m)	Margin (dB)	Antenna Factor (dB/m)	Cable Loss (dB)	Preamp Factor (dB)	Antenna Height (cm)	Table Angle (Degree)	Remark
*5643.575	50.18	49.02	68.2	-18.02	31.82	6.62	37.28	209	251	Peak
5661.625	50.52	49.39	76.83	-26.31	31.85	6.62	37.34	209	251	Peak
5913.85	52.12	50.35	76.42	-24.3	32.26	7.01	37.5	209	251	Peak
*5935.7	51.26	49.46	68.2	-16.94	32.29	7.01	37.5	209	251	Peak
Antenna Polarity & Test Distance: Vertical at 3 m										
Frequency (MHz)	Emission Level (dBuV/m)	Read Level (dBuV)	Limit (dBuV/m)	Margin (dB)	Antenna Factor (dB/m)	Cable Loss (dB)	Preamp Factor (dB)	Antenna Height (cm)	Table Angle (Degree)	Remark
*5639.3	51.75	50.65	68.2	-16.45	31.82	6.56	37.28	149	169	Peak
5664	51.2	50.07	78.59	-27.39	31.85	6.62	37.34	149	169	Peak
5906.25	51.84	50.06	82.04	-30.2	32.26	7.01	37.49	149	169	Peak
*5944.25	51.92	50.02	68.2	-16.28	32.32	7.08	37.5	149	169	Peak

Remarks:

- Emission Level = Read Level + Antenna Factor + Cable Loss - Preamp Factor
Margin value = Emission level – Limit value
- 5785 MHz: Fundamental Frequency
- *: Out of Restricted Band

EUT Test Condition		Measurement Detail	
Channel	Channel 165	Frequency Range	1 GHz ~ 40 GHz
Input Power	120 Vac, 60 Hz	Detector Function	Peak (PK) Average (AV)
Environmental Conditions	25 deg. C, 65 % RH	Tested By	Getaz Yang

<Spurious Emission>

Antenna Polarity & Test Distance: Horizontal at 3 m										
Frequency (MHz)	Emission Level (dBuV/m)	Read Level (dBuV)	Limit (dBuV/m)	Margin (dB)	Antenna Factor (dB/m)	Cable Loss (dB)	Preamp Factor (dB)	Antenna Height (cm)	Table Angle (Degree)	Remark
5825	96.36	94.89			32.12	6.88	37.53	209	255	Average
5825	103.12	101.65			32.12	6.88	37.53	209	255	Peak
11650	42.99	46.54	54	-11.01	39.65	10.15	53.35	100	198	Average
11650	51.79	55.34	74	-22.21	39.65	10.15	53.35	100	198	Peak
Antenna Polarity & Test Distance: Vertical at 3 m										
Frequency (MHz)	Emission Level (dBuV/m)	Read Level (dBuV)	Limit (dBuV/m)	Margin (dB)	Antenna Factor (dB/m)	Cable Loss (dB)	Preamp Factor (dB)	Antenna Height (cm)	Table Angle (Degree)	Remark
5825	93.31	91.84			32.12	6.88	37.53	163	167	Average
5825	100.51	99.04			32.12	6.88	37.53	163	167	Peak
11650	42.54	46.09	54	-11.46	39.65	10.15	53.35	100	95	Average
11650	50.73	54.28	74	-23.27	39.65	10.15	53.35	100	95	Peak

<Out of Band Emission (OOBE)>

Antenna Polarity & Test Distance: Horizontal at 3 m										
Frequency (MHz)	Emission Level (dBuV/m)	Read Level (dBuV)	Limit (dBuV/m)	Margin (dB)	Antenna Factor (dB/m)	Cable Loss (dB)	Preamp Factor (dB)	Antenna Height (cm)	Table Angle (Degree)	Remark
*5637.4	50.49	49.39	68.2	-17.71	31.82	6.56	37.28	209	255	Peak
5657.825	51.19	50.06	74.01	-22.82	31.85	6.62	37.34	209	255	Peak
5908.15	50.77	48.99	80.63	-29.86	32.26	7.01	37.49	209	255	Peak
*5941.4	50.62	48.72	68.2	-17.58	32.32	7.08	37.5	209	255	Peak
Antenna Polarity & Test Distance: Vertical at 3 m										
Frequency (MHz)	Emission Level (dBuV/m)	Read Level (dBuV)	Limit (dBuV/m)	Margin (dB)	Antenna Factor (dB/m)	Cable Loss (dB)	Preamp Factor (dB)	Antenna Height (cm)	Table Angle (Degree)	Remark
*5640.25	50.66	49.56	68.2	-17.54	31.82	6.56	37.28	163	167	Peak
5656.4	49.7	48.57	72.95	-23.25	31.85	6.62	37.34	163	167	Peak
5914.325	50.18	48.41	76.07	-25.89	32.26	7.01	37.5	163	167	Peak
*5930.95	51.46	49.66	68.2	-16.74	32.29	7.01	37.5	163	167	Peak

Remarks:

- Emission Level = Read Level + Antenna Factor + Cable Loss - Preamp Factor
Margin value = Emission level – Limit value
- 5825 MHz: Fundamental Frequency
- *: Out of Restricted Band

802.11n (HT20)

EUT Test Condition		Measurement Detail	
Channel	Channel 36	Frequency Range	1 GHz ~ 40 GHz
Input Power	120 Vac, 60 Hz	Detector Function	Peak (PK) Average (AV)
Environmental Conditions	25 deg. C, 65 % RH	Tested By	Getaz Yang

Antenna Polarity & Test Distance: Horizontal at 3 m

Frequency (MHz)	Emission Level (dBuV/m)	Read Level (dBuV)	Limit (dBuV/m)	Margin (dB)	Antenna Factor (dB/m)	Cable Loss (dB)	Preamp Factor (dB)	Antenna Height (cm)	Table Angle (Degree)	Remark
5148	48.03	47.83	54	-5.97	31.32	6.2	37.32	200	276	Average
5148	63.87	63.67	74	-10.13	31.32	6.2	37.32	200	276	Peak
5180	95.78	95.55			31.35	6.22	37.34	200	276	Average
5180	102.99	102.76			31.35	6.22	37.34	200	276	Peak
5404	41.46	40.8	54	-12.54	31.52	6.32	37.18	200	276	Average
5404	60.36	59.7	74	-13.64	31.52	6.32	37.18	200	276	Peak
*10360	49.54	53.44	68.2	-18.66	39.19	9.05	52.14	100	180	Peak

Antenna Polarity & Test Distance: Vertical at 3 m

Frequency (MHz)	Emission Level (dBuV/m)	Read Level (dBuV)	Limit (dBuV/m)	Margin (dB)	Antenna Factor (dB/m)	Cable Loss (dB)	Preamp Factor (dB)	Antenna Height (cm)	Table Angle (Degree)	Remark
5132	42.68	42.47	54	-11.32	31.31	6.2	37.3	200	180	Average
5132	59.98	59.77	74	-14.02	31.31	6.2	37.3	200	180	Peak
5180	90.15	89.92			31.35	6.22	37.34	200	180	Average
5180	97.53	97.3			31.35	6.22	37.34	200	180	Peak
5386	41.01	40.37	54	-12.99	31.51	6.31	37.18	200	180	Average
5386	60.07	59.43	74	-13.93	31.51	6.31	37.18	200	180	Peak
*10360	51.08	54.98	68.2	-17.12	39.19	9.05	52.14	102	302	Peak

Remarks:

- Emission Level = Read Level + Antenna Factor + Cable Loss - Preamp Factor
Margin value = Emission level – Limit value
- 5180 MHz: Fundamental Frequency
- *: Out of Restricted Band

EUT Test Condition		Measurement Detail	
Channel	Channel 44	Frequency Range	1 GHz ~ 40 GHz
Input Power	120 Vac, 60 Hz	Detector Function	Peak (PK) Average (AV)
Environmental Conditions	25 deg. C, 65 % RH	Tested By	Getaz Yang

Antenna Polarity & Test Distance: Horizontal at 3 m										
Frequency (MHz)	Emission Level (dBuV/m)	Read Level (dBuV)	Limit (dBuV/m)	Margin (dB)	Antenna Factor (dB/m)	Cable Loss (dB)	Preamp Factor (dB)	Antenna Height (cm)	Table Angle (Degree)	Remark
5058	40.98	40.81	54	-13.02	31.25	6.17	37.25	200	254	Average
5058	60.21	60.04	74	-13.79	31.25	6.17	37.25	200	254	Peak
5220	95.5	95.25			31.37	6.24	37.36	200	254	Average
5220	102.32	102.07			31.37	6.24	37.36	200	254	Peak
5454	41.26	40.44	54	-12.74	31.56	6.34	37.08	200	254	Average
5454	60.55	59.73	74	-13.45	31.56	6.34	37.08	200	254	Peak
*10440	49.82	53.92	68.2	-18.38	39.29	9.09	52.48	101	179	Peak

Antenna Polarity & Test Distance: Vertical at 3 m										
Frequency (MHz)	Emission Level (dBuV/m)	Read Level (dBuV)	Limit (dBuV/m)	Margin (dB)	Antenna Factor (dB/m)	Cable Loss (dB)	Preamp Factor (dB)	Antenna Height (cm)	Table Angle (Degree)	Remark
5084	40.61	40.44	54	-13.39	31.27	6.17	37.27	200	168	Average
5084	59.47	59.3	74	-14.53	31.27	6.17	37.27	200	168	Peak
5220	90	89.75			31.37	6.24	37.36	200	168	Average
5220	97.36	97.11			31.37	6.24	37.36	200	168	Peak
5406	41.19	40.53	54	-12.81	31.52	6.32	37.18	200	168	Average
5406	62.1	61.44	74	-11.9	31.52	6.32	37.18	200	168	Peak
*10440	48.86	52.96	68.2	-19.34	39.29	9.09	52.48	102	303	Peak

Remarks:

- Emission Level = Read Level + Antenna Factor + Cable Loss - Preamp Factor
Margin value = Emission level – Limit value
- 5220 MHz: Fundamental Frequency
- *: Out of Restricted Band

EUT Test Condition		Measurement Detail	
Channel	Channel 48	Frequency Range	1 GHz ~ 40 GHz
Input Power	120 Vac, 60 Hz	Detector Function	Peak (PK) Average (AV)
Environmental Conditions	25 deg. C, 65 % RH	Tested By	Getaz Yang

Antenna Polarity & Test Distance: Horizontal at 3 m										
Frequency (MHz)	Emission Level (dBuV/m)	Read Level (dBuV)	Limit (dBuV/m)	Margin (dB)	Antenna Factor (dB/m)	Cable Loss (dB)	Preamp Factor (dB)	Antenna Height (cm)	Table Angle (Degree)	Remark
5030	40.97	40.83	54	-13.03	31.23	6.15	37.24	202	255	Average
5030	60.86	60.72	74	-13.14	31.23	6.15	37.24	202	255	Peak
5240	95.68	95.36			31.39	6.25	37.32	202	255	Average
5240	102.51	102.19			31.39	6.25	37.32	202	255	Peak
5382	41.26	40.62	54	-12.74	31.51	6.31	37.18	202	255	Average
5382	61.8	61.16	74	-12.2	31.51	6.31	37.18	202	255	Peak
*10480	49.48	53.73	68.2	-18.72	39.37	9.09	52.71	105	175	Peak

Antenna Polarity & Test Distance: Vertical at 3 m										
Frequency (MHz)	Emission Level (dBuV/m)	Read Level (dBuV)	Limit (dBuV/m)	Margin (dB)	Antenna Factor (dB/m)	Cable Loss (dB)	Preamp Factor (dB)	Antenna Height (cm)	Table Angle (Degree)	Remark
5132	40.75	40.54	54	-13.25	31.31	6.2	37.3	200	172	Average
5132	60.3	60.09	74	-13.7	31.31	6.2	37.3	200	172	Peak
5240	89.93	89.61			31.39	6.25	37.32	200	172	Average
5240	97.37	97.05			31.39	6.25	37.32	200	172	Peak
5396	41.21	40.56	54	-12.79	31.52	6.31	37.18	200	172	Average
5396	60.12	59.47	74	-13.88	31.52	6.31	37.18	200	172	Peak
*10480	49.26	53.51	68.2	-18.94	39.37	9.09	52.71	100	301	Peak

Remarks:

- Emission Level = Read Level + Antenna Factor + Cable Loss - Preamp Factor
Margin value = Emission level – Limit value
- 5240 MHz: Fundamental Frequency
- *: Out of Restricted Band

EUT Test Condition		Measurement Detail	
Channel	Channel 52	Frequency Range	1 GHz ~ 40 GHz
Input Power	120 Vac, 60 Hz	Detector Function	Peak (PK) Average (AV)
Environmental Conditions	25 deg. C, 65 % RH	Tested By	Getaz Yang

Antenna Polarity & Test Distance: Horizontal at 3 m										
Frequency (MHz)	Emission Level (dBuV/m)	Read Level (dBuV)	Limit (dBuV/m)	Margin (dB)	Antenna Factor (dB/m)	Cable Loss (dB)	Preamp Factor (dB)	Antenna Height (cm)	Table Angle (Degree)	Remark
5020	40.57	40.45	54	-13.43	31.21	6.15	37.24	197	238	Average
5020	60.49	60.37	74	-13.51	31.21	6.15	37.24	197	238	Peak
5260	95.76	95.37			31.41	6.25	37.27	197	238	Average
5260	102.78	102.39			31.41	6.25	37.27	197	238	Peak
5418	41.45	40.78	54	-12.55	31.53	6.32	37.18	197	238	Average
5418	59.85	59.18	74	-14.15	31.53	6.32	37.18	197	238	Peak
*10520	52.03	56.31	68.2	-16.17	39.43	9.12	52.83	151	160	Peak

Antenna Polarity & Test Distance: Vertical at 3 m										
Frequency (MHz)	Emission Level (dBuV/m)	Read Level (dBuV)	Limit (dBuV/m)	Margin (dB)	Antenna Factor (dB/m)	Cable Loss (dB)	Preamp Factor (dB)	Antenna Height (cm)	Table Angle (Degree)	Remark
5026	40.53	40.39	54	-13.47	31.23	6.15	37.24	198	172	Average
5026	60.18	60.04	74	-13.82	31.23	6.15	37.24	198	172	Peak
5260	90.31	89.92			31.41	6.25	37.27	198	172	Average
5260	97.65	97.26			31.41	6.25	37.27	198	172	Peak
5416	41.21	40.54	54	-12.79	31.53	6.32	37.18	198	172	Average
5416	61.21	60.54	74	-12.79	31.53	6.32	37.18	198	172	Peak
*10520	50.07	54.35	68.2	-18.13	39.43	9.12	52.83	102	32	Peak

Remarks:

- Emission Level = Read Level + Antenna Factor + Cable Loss - Preamp Factor
Margin value = Emission level – Limit value
- 5260 MHz: Fundamental Frequency
- *: Out of Restricted Band

EUT Test Condition		Measurement Detail	
Channel	Channel 60	Frequency Range	1 GHz ~ 40 GHz
Input Power	120 Vac, 60 Hz	Detector Function	Peak (PK) Average (AV)
Environmental Conditions	25 deg. C, 65 % RH	Tested By	Getaz Yang

Antenna Polarity & Test Distance: Horizontal at 3 m										
Frequency (MHz)	Emission Level (dBuV/m)	Read Level (dBuV)	Limit (dBuV/m)	Margin (dB)	Antenna Factor (dB/m)	Cable Loss (dB)	Preamp Factor (dB)	Antenna Height (cm)	Table Angle (Degree)	Remark
5022	40.59	40.45	54	-13.41	31.23	6.15	37.24	208	239	Average
5022	60.19	60.05	74	-13.81	31.23	6.15	37.24	208	239	Peak
5300	95.32	94.8			31.44	6.27	37.19	208	239	Average
5300	102.48	101.96			31.44	6.27	37.19	208	239	Peak
5440	42.1	41.34	54	-11.9	31.55	6.34	37.13	208	239	Average
5440	60.6	59.84	74	-13.4	31.55	6.34	37.13	208	239	Peak
10600	41.55	45.23	54	-12.45	39.57	9.16	52.41	150	159	Average
10600	50.68	54.36	74	-23.32	39.57	9.16	52.41	150	159	Peak

Antenna Polarity & Test Distance: Vertical at 3 m										
Frequency (MHz)	Emission Level (dBuV/m)	Read Level (dBuV)	Limit (dBuV/m)	Margin (dB)	Antenna Factor (dB/m)	Cable Loss (dB)	Preamp Factor (dB)	Antenna Height (cm)	Table Angle (Degree)	Remark
5012	40.56	40.45	54	-13.44	31.21	6.13	37.23	206	170	Average
5012	59.86	59.75	74	-14.14	31.21	6.13	37.23	206	170	Peak
5300	90.44	89.92			31.44	6.27	37.19	206	170	Average
5300	97.28	96.76			31.44	6.27	37.19	206	170	Peak
5412	41.05	40.38	54	-12.95	31.53	6.32	37.18	206	170	Average
5412	59.41	58.74	74	-14.59	31.53	6.32	37.18	206	170	Peak
10600	41.85	45.53	54	-12.15	39.57	9.16	52.41	105	31	Average
10600	49.92	53.6	74	-24.08	39.57	9.16	52.41	105	31	Peak

Remarks:

- Emission Level = Read Level + Antenna Factor + Cable Loss - Preamp Factor
Margin value = Emission level – Limit value
- 5300 MHz: Fundamental Frequency

EUT Test Condition		Measurement Detail	
Channel	Channel 64	Frequency Range	1 GHz ~ 40 GHz
Input Power	120 Vac, 60 Hz	Detector Function	Peak (PK) Average (AV)
Environmental Conditions	25 deg. C, 65 % RH	Tested By	Getaz Yang

Antenna Polarity & Test Distance: Horizontal at 3 m										
Frequency (MHz)	Emission Level (dBuV/m)	Read Level (dBuV)	Limit (dBuV/m)	Margin (dB)	Antenna Factor (dB/m)	Cable Loss (dB)	Preamp Factor (dB)	Antenna Height (cm)	Table Angle (Degree)	Remark
5060	40.56	40.39	54	-13.44	31.25	6.17	37.25	202	272	Average
5060	61.05	60.88	74	-12.95	31.25	6.17	37.25	202	272	Peak
5320	94.87	94.32			31.45	6.29	37.19	202	272	Average
5320	102.07	101.52			31.45	6.29	37.19	202	272	Peak
5350	43.74	43.15	54	-10.26	31.48	6.29	37.18	202	272	Average
5350	62.18	61.59	74	-11.82	31.48	6.29	37.18	202	272	Peak
10640	40.87	44.32	54	-13.13	39.62	9.2	52.27	150	161	Average
10640	50.31	53.76	74	-23.69	39.62	9.2	52.27	150	161	Peak

Antenna Polarity & Test Distance: Vertical at 3 m										
Frequency (MHz)	Emission Level (dBuV/m)	Read Level (dBuV)	Limit (dBuV/m)	Margin (dB)	Antenna Factor (dB/m)	Cable Loss (dB)	Preamp Factor (dB)	Antenna Height (cm)	Table Angle (Degree)	Remark
5064	40.59	40.42	54	-13.41	31.25	6.17	37.25	202	171	Average
5064	60.33	60.16	74	-13.67	31.25	6.17	37.25	202	171	Peak
5320	89.9	89.35			31.45	6.29	37.19	202	171	Average
5320	97.18	96.63			31.45	6.29	37.19	202	171	Peak
5444	42.27	41.51	54	-11.73	31.55	6.34	37.13	202	171	Average
5444	60.12	59.36	74	-13.88	31.55	6.34	37.13	202	171	Peak
10640	41.3	44.75	54	-12.7	39.62	9.2	52.27	102	33	Average
10640	50.67	54.12	74	-23.33	39.62	9.2	52.27	102	33	Peak

Remarks:

- Emission Level = Read Level + Antenna Factor + Cable Loss - Preamp Factor
Margin value = Emission level – Limit value
- 5320 MHz: Fundamental Frequency

EUT Test Condition		Measurement Detail	
Channel	Channel 100	Frequency Range	1 GHz ~ 40 GHz
Input Power	120 Vac, 60 Hz	Detector Function	Peak (PK) Average (AV)
Environmental Conditions	25 deg. C, 65 % RH	Tested By	Getaz Yang

Antenna Polarity & Test Distance: Horizontal at 3 m										
Frequency (MHz)	Emission Level (dBuV/m)	Read Level (dBuV)	Limit (dBuV/m)	Margin (dB)	Antenna Factor (dB/m)	Cable Loss (dB)	Preamp Factor (dB)	Antenna Height (cm)	Table Angle (Degree)	Remark
5436	42	41.26	54	-12	31.55	6.32	37.13	205	253	Average
5436	60.39	59.65	74	-13.61	31.55	6.32	37.13	205	253	Peak
*5470	60.23	59.4	68.2	-7.97	31.57	6.34	37.08	205	253	Peak
5500	92.1	91.17			31.6	6.36	37.03	205	253	Average
5500	99.01	98.08			31.6	6.36	37.03	205	253	Peak
*5725	59.83	58.55	68.2	-8.37	31.96	6.75	37.43	205	253	Peak
11000	42.57	46.47	54	-11.43	40.2	9.35	53.45	100	110	Average
11000	52.2	56.1	74	-21.8	40.2	9.35	53.45	100	110	Peak

Antenna Polarity & Test Distance: Vertical at 3 m										
Frequency (MHz)	Emission Level (dBuV/m)	Read Level (dBuV)	Limit (dBuV/m)	Margin (dB)	Antenna Factor (dB/m)	Cable Loss (dB)	Preamp Factor (dB)	Antenna Height (cm)	Table Angle (Degree)	Remark
5420	41.44	40.77	54	-12.56	31.53	6.32	37.18	195	167	Average
5420	60.35	59.68	74	-13.65	31.53	6.32	37.18	195	167	Peak
*5470	59.59	58.76	68.2	-8.61	31.57	6.34	37.08	195	167	Peak
5500	90.73	89.8			31.6	6.36	37.03	195	167	Average
5500	97.61	96.68			31.6	6.36	37.03	195	167	Peak
*5725	59.1	57.82	68.2	-9.1	31.96	6.75	37.43	195	167	Peak
11000	41.93	45.83	54	-12.07	40.2	9.35	53.45	100	119	Average
11000	51.02	54.92	74	-22.98	40.2	9.35	53.45	100	119	Peak

Remarks:

- Emission Level = Read Level + Antenna Factor + Cable Loss - Preamp Factor
Margin value = Emission level – Limit value
- 5500 MHz: Fundamental Frequency
- *: Out of Restricted Band

EUT Test Condition		Measurement Detail	
Channel	Channel 116	Frequency Range	1 GHz ~ 40 GHz
Input Power	120 Vac, 60 Hz	Detector Function	Peak (PK) Average (AV)
Environmental Conditions	25 deg. C, 65 % RH	Tested By	Getaz Yang

Antenna Polarity & Test Distance: Horizontal at 3 m										
Frequency (MHz)	Emission Level (dBuV/m)	Read Level (dBuV)	Limit (dBuV/m)	Margin (dB)	Antenna Factor (dB/m)	Cable Loss (dB)	Preamp Factor (dB)	Antenna Height (cm)	Table Angle (Degree)	Remark
5452	41.02	40.2	54	-12.98	31.56	6.34	37.08	209	256	Average
5452	60.96	60.14	74	-13.04	31.56	6.34	37.08	209	256	Peak
*5470	59.5	58.67	68.2	-8.7	31.57	6.34	37.08	209	256	Peak
5580	92.98	91.94			31.71	6.49	37.16	209	256	Average
5580	100.33	99.29			31.71	6.49	37.16	209	256	Peak
*5725	60.46	59.18	68.2	-7.74	31.96	6.75	37.43	209	256	Peak
11160	42.6	46.32	54	-11.4	40.1	9.57	53.39	100	320	Average
11160	51.44	55.16	74	-22.56	40.1	9.57	53.39	100	320	Peak

Antenna Polarity & Test Distance: Vertical at 3 m										
Frequency (MHz)	Emission Level (dBuV/m)	Read Level (dBuV)	Limit (dBuV/m)	Margin (dB)	Antenna Factor (dB/m)	Cable Loss (dB)	Preamp Factor (dB)	Antenna Height (cm)	Table Angle (Degree)	Remark
5380	40.87	40.23	54	-13.13	31.51	6.31	37.18	177	179	Average
5380	60.23	59.59	74	-13.77	31.51	6.31	37.18	177	179	Peak
*5470	58.45	57.62	68.2	-9.75	31.57	6.34	37.08	177	179	Peak
5580	90.72	89.68			31.71	6.49	37.16	177	179	Average
5580	97.78	96.74			31.71	6.49	37.16	177	179	Peak
*5725	59.5	58.22	68.2	-8.7	31.96	6.75	37.43	177	179	Peak
11160	41.67	45.39	54	-12.33	40.1	9.57	53.39	100	242	Average
11160	50.56	54.28	74	-23.44	40.1	9.57	53.39	100	242	Peak

Remarks:

- Emission Level = Read Level + Antenna Factor + Cable Loss - Preamp Factor
Margin value = Emission level – Limit value
- 5580 MHz: Fundamental Frequency
- *: Out of Restricted Band

EUT Test Condition		Measurement Detail	
Channel	Channel 140	Frequency Range	1 GHz ~ 40 GHz
Input Power	120 Vac, 60 Hz	Detector Function	Peak (PK) Average (AV)
Environmental Conditions	25 deg. C, 65 % RH	Tested By	Getaz Yang

Antenna Polarity & Test Distance: Horizontal at 3 m										
Frequency (MHz)	Emission Level (dBuV/m)	Read Level (dBuV)	Limit (dBuV/m)	Margin (dB)	Antenna Factor (dB/m)	Cable Loss (dB)	Preamp Factor (dB)	Antenna Height (cm)	Table Angle (Degree)	Remark
5436	41.16	40.42	54	-12.84	31.55	6.32	37.13	207	252	Average
5436	60.81	60.07	74	-13.19	31.55	6.32	37.13	207	252	Peak
*5470	59.55	58.72	68.2	-8.65	31.57	6.34	37.08	207	252	Peak
5700	94.48	93.29			31.9	6.69	37.4	207	252	Average
5700	101.57	100.38			31.9	6.69	37.4	207	252	Peak
*5725	58.47	57.19	68.2	-9.73	31.96	6.75	37.43	207	252	Peak
11400	44.62	46.88	54	-9.38	39.96	9.91	52.13	100	106	Average
11400	53.85	56.11	74	-20.15	39.96	9.91	52.13	100	106	Peak

Antenna Polarity & Test Distance: Vertical at 3 m										
Frequency (MHz)	Emission Level (dBuV/m)	Read Level (dBuV)	Limit (dBuV/m)	Margin (dB)	Antenna Factor (dB/m)	Cable Loss (dB)	Preamp Factor (dB)	Antenna Height (cm)	Table Angle (Degree)	Remark
5408	40.95	40.29	54	-13.05	31.52	6.32	37.18	196	170	Average
5408	60.14	59.48	74	-13.86	31.52	6.32	37.18	196	170	Peak
*5470	58.41	57.58	68.2	-9.79	31.57	6.34	37.08	196	170	Peak
5700	92.58	91.39			31.9	6.69	37.4	196	170	Average
5700	99.72	98.53			31.9	6.69	37.4	196	170	Peak
*5725	60.92	59.64	68.2	-7.28	31.96	6.75	37.43	196	170	Peak
11400	43.42	45.68	54	-10.58	39.96	9.91	52.13	100	223	Average
11400	52.56	54.82	74	-21.44	39.96	9.91	52.13	100	223	Peak

Remarks:

- Emission Level = Read Level + Antenna Factor + Cable Loss - Preamp Factor
Margin value = Emission level – Limit value
- 5700 MHz: Fundamental Frequency
- *: Out of Restricted Band

EUT Test Condition		Measurement Detail	
Channel	Channel 149	Frequency Range	1 GHz ~ 40 GHz
Input Power	120 Vac, 60 Hz	Detector Function	Peak (PK) Average (AV)
Environmental Conditions	25 deg. C, 65 % RH	Tested By	Getaz Yang

<Spurious Emission>

Antenna Polarity & Test Distance: Horizontal at 3 m										
Frequency (MHz)	Emission Level (dBuV/m)	Read Level (dBuV)	Limit (dBuV/m)	Margin (dB)	Antenna Factor (dB/m)	Cable Loss (dB)	Preamp Factor (dB)	Antenna Height (cm)	Table Angle (Degree)	Remark
5745	96.07	94.8			31.99	6.75	37.47	217	262	Average
5745	103.12	101.85			31.99	6.75	37.47	217	262	Peak
11490	43.85	46.74	54	-10.15	39.91	10.03	52.83	100	122	Average
11490	52.8	55.69	74	-21.2	39.91	10.03	52.83	100	122	Peak
Antenna Polarity & Test Distance: Vertical at 3 m										
Frequency (MHz)	Emission Level (dBuV/m)	Read Level (dBuV)	Limit (dBuV/m)	Margin (dB)	Antenna Factor (dB/m)	Cable Loss (dB)	Preamp Factor (dB)	Antenna Height (cm)	Table Angle (Degree)	Remark
5745	93.22	91.95			31.99	6.75	37.47	203	178	Average
5745	100.29	99.02			31.99	6.75	37.47	203	178	Peak
11490	43.31	46.2	54	-10.69	39.91	10.03	52.83	100	177	Average
11490	52.04	54.93	74	-21.96	39.91	10.03	52.83	100	177	Peak

<Out of Band Emission (OOBE)>

Antenna Polarity & Test Distance: Horizontal at 3 m										
Frequency (MHz)	Emission Level (dBuV/m)	Read Level (dBuV)	Limit (dBuV/m)	Margin (dB)	Antenna Factor (dB/m)	Cable Loss (dB)	Preamp Factor (dB)	Antenna Height (cm)	Table Angle (Degree)	Remark
*5643.575	50.41	49.25	68.2	-17.79	31.82	6.62	37.28	217	262	Peak
5657.825	50.56	49.43	74.01	-23.45	31.85	6.62	37.34	217	262	Peak
5918.6	51.38	49.61	72.92	-21.54	32.26	7.01	37.5	217	262	Peak
*5937.125	51.02	49.22	68.2	-17.18	32.29	7.01	37.5	217	262	Peak
Antenna Polarity & Test Distance: Vertical at 3 m										
Frequency (MHz)	Emission Level (dBuV/m)	Read Level (dBuV)	Limit (dBuV/m)	Margin (dB)	Antenna Factor (dB/m)	Cable Loss (dB)	Preamp Factor (dB)	Antenna Height (cm)	Table Angle (Degree)	Remark
*5640.725	50.38	49.28	68.2	-17.82	31.82	6.56	37.28	203	178	Peak
5656.875	49.42	48.29	73.31	-23.89	31.85	6.62	37.34	203	178	Peak
5922.4	51.19	49.39	70.12	-18.93	32.29	7.01	37.5	203	178	Peak
*5938.55	51.43	49.6	68.2	-16.77	32.32	7.01	37.5	203	178	Peak

Remarks:

- Emission Level = Read Level + Antenna Factor + Cable Loss - Preamp Factor
Margin value = Emission level – Limit value
- 5745 MHz: Fundamental Frequency
- *: Out of Restricted Band

EUT Test Condition		Measurement Detail	
Channel	Channel 157	Frequency Range	1 GHz ~ 40 GHz
Input Power	120 Vac, 60 Hz	Detector Function	Peak (PK) Average (AV)
Environmental Conditions	25 deg. C, 65 % RH	Tested By	Getaz Yang

<Spurious Emission>

Antenna Polarity & Test Distance: Horizontal at 3 m										
Frequency (MHz)	Emission Level (dBuV/m)	Read Level (dBuV)	Limit (dBuV/m)	Margin (dB)	Antenna Factor (dB/m)	Cable Loss (dB)	Preamp Factor (dB)	Antenna Height (cm)	Table Angle (Degree)	Remark
5785	93.26	91.94			32.04	6.82	37.54	216	256	Average
5785	103.15	101.83			32.04	6.82	37.54	216	256	Peak
11570	43.51	46.97	54	-10.49	39.78	10.09	53.33	100	154	Average
11570	52.84	56.3	74	-21.16	39.78	10.09	53.33	100	154	Peak
Antenna Polarity & Test Distance: Vertical at 3 m										
Frequency (MHz)	Emission Level (dBuV/m)	Read Level (dBuV)	Limit (dBuV/m)	Margin (dB)	Antenna Factor (dB/m)	Cable Loss (dB)	Preamp Factor (dB)	Antenna Height (cm)	Table Angle (Degree)	Remark
5785	91.11	89.79			32.04	6.82	37.54	162	174	Average
5785	100.19	98.87			32.04	6.82	37.54	162	174	Peak
11570	42.86	46.32	54	-11.14	39.78	10.09	53.33	100	111	Average
11570	52.65	56.11	74	-21.35	39.78	10.09	53.33	100	111	Peak

<Out of Band Emission (OOBE)>

Antenna Polarity & Test Distance: Horizontal at 3 m										
Frequency (MHz)	Emission Level (dBuV/m)	Read Level (dBuV)	Limit (dBuV/m)	Margin (dB)	Antenna Factor (dB/m)	Cable Loss (dB)	Preamp Factor (dB)	Antenna Height (cm)	Table Angle (Degree)	Remark
*5645.475	50.09	48.93	68.2	-18.11	31.82	6.62	37.28	216	256	Peak
5661.625	49.97	48.84	76.83	-26.86	31.85	6.62	37.34	216	256	Peak
5918.125	52.08	50.31	73.27	-21.19	32.26	7.01	37.5	216	256	Peak
*5948.05	50.87	48.97	68.2	-17.33	32.32	7.08	37.5	216	256	Peak
Antenna Polarity & Test Distance: Vertical at 3 m										
Frequency (MHz)	Emission Level (dBuV/m)	Read Level (dBuV)	Limit (dBuV/m)	Margin (dB)	Antenna Factor (dB/m)	Cable Loss (dB)	Preamp Factor (dB)	Antenna Height (cm)	Table Angle (Degree)	Remark
*5624.575	49.98	48.85	68.2	-18.22	31.79	6.56	37.22	162	174	Peak
5668.275	50.67	49.51	81.76	-31.09	31.88	6.62	37.34	162	174	Peak
5920.025	51.73	49.96	71.87	-20.14	32.26	7.01	37.5	162	174	Peak
*5950.425	51.6	49.7	68.2	-16.6	32.32	7.08	37.5	162	174	Peak

Remarks:

- Emission Level = Read Level + Antenna Factor + Cable Loss - Preamp Factor
Margin value = Emission level – Limit value
- 5785 MHz: Fundamental Frequency
- *: Out of Restricted Band

EUT Test Condition		Measurement Detail	
Channel	Channel 165	Frequency Range	1 GHz ~ 40 GHz
Input Power	120 Vac, 60 Hz	Detector Function	Peak (PK) Average (AV)
Environmental Conditions	25 deg. C, 65 % RH	Tested By	Getaz Yang

<Spurious Emission>

Antenna Polarity & Test Distance: Horizontal at 3 m										
Frequency (MHz)	Emission Level (dBuV/m)	Read Level (dBuV)	Limit (dBuV/m)	Margin (dB)	Antenna Factor (dB/m)	Cable Loss (dB)	Preamp Factor (dB)	Antenna Height (cm)	Table Angle (Degree)	Remark
5825	96.31	94.84			32.12	6.88	37.53	214	253	Average
5825	103.17	101.7			32.12	6.88	37.53	214	253	Peak
11650	43.31	46.86	54	-10.69	39.65	10.15	53.35	100	103	Average
11650	51.94	55.49	74	-22.06	39.65	10.15	53.35	100	103	Peak
Antenna Polarity & Test Distance: Vertical at 3 m										
Frequency (MHz)	Emission Level (dBuV/m)	Read Level (dBuV)	Limit (dBuV/m)	Margin (dB)	Antenna Factor (dB/m)	Cable Loss (dB)	Preamp Factor (dB)	Antenna Height (cm)	Table Angle (Degree)	Remark
5825	93.21	91.74			32.12	6.88	37.53	140	177	Average
5825	100.28	98.81			32.12	6.88	37.53	140	177	Peak
11650	42.66	46.21	54	-11.34	39.65	10.15	53.35	100	141	Average
11650	51.67	55.22	74	-22.33	39.65	10.15	53.35	100	141	Peak

<Out of Band Emission (OOBE)>

Antenna Polarity & Test Distance: Horizontal at 3 m										
Frequency (MHz)	Emission Level (dBuV/m)	Read Level (dBuV)	Limit (dBuV/m)	Margin (dB)	Antenna Factor (dB/m)	Cable Loss (dB)	Preamp Factor (dB)	Antenna Height (cm)	Table Angle (Degree)	Remark
*5643.575	51.33	50.17	68.2	-16.87	31.82	6.62	37.28	214	253	Peak
5662.1	50.64	49.51	77.18	-26.54	31.85	6.62	37.34	214	253	Peak
5916.225	52.88	51.11	74.67	-21.79	32.26	7.01	37.5	214	253	Peak
*5928.575	51.58	49.78	68.2	-16.62	32.29	7.01	37.5	214	253	Peak
Antenna Polarity & Test Distance: Vertical at 3 m										
Frequency (MHz)	Emission Level (dBuV/m)	Read Level (dBuV)	Limit (dBuV/m)	Margin (dB)	Antenna Factor (dB/m)	Cable Loss (dB)	Preamp Factor (dB)	Antenna Height (cm)	Table Angle (Degree)	Remark
*5644.525	50.53	49.37	68.2	-17.67	31.82	6.62	37.28	140	177	Peak
5657.825	50.99	49.86	74.01	-23.02	31.85	6.62	37.34	140	177	Peak
5917.65	51.18	49.41	73.62	-22.44	32.26	7.01	37.5	140	177	Peak
*5932.375	51.46	49.66	68.2	-16.74	32.29	7.01	37.5	140	177	Peak

Remarks:

- Emission Level = Read Level + Antenna Factor + Cable Loss - Preamp Factor
Margin value = Emission level – Limit value
- 5825 MHz: Fundamental Frequency
- *: Out of Restricted Band

802.11n (HT40)

EUT Test Condition		Measurement Detail	
Channel	Channel 38	Frequency Range	1 GHz ~ 40 GHz
Input Power	120 Vac, 60 Hz	Detector Function	Peak (PK) Average (AV)
Environmental Conditions	25 deg. C, 65 % RH	Tested By	Getaz Yang

Antenna Polarity & Test Distance: Horizontal at 3 m

Frequency (MHz)	Emission Level (dBuV/m)	Read Level (dBuV)	Limit (dBuV/m)	Margin (dB)	Antenna Factor (dB/m)	Cable Loss (dB)	Preamp Factor (dB)	Antenna Height (cm)	Table Angle (Degree)	Remark
5150	52.73	52.53	54	-1.27	31.32	6.2	37.32	200	265	Average
5150	67.95	67.75	74	-6.05	31.32	6.2	37.32	200	265	Peak
5190	91.99	91.76			31.35	6.22	37.34	200	265	Average
5190	98.88	98.65			31.35	6.22	37.34	200	265	Peak
5442	41.57	40.81	54	-12.43	31.55	6.34	37.13	200	265	Average
5442	60.58	59.82	74	-13.42	31.55	6.34	37.13	200	265	Peak
*10380	49.72	53.71	68.2	-18.48	39.21	9.05	52.25	102	189	Peak

Antenna Polarity & Test Distance: Vertical at 3 m

Frequency (MHz)	Emission Level (dBuV/m)	Read Level (dBuV)	Limit (dBuV/m)	Margin (dB)	Antenna Factor (dB/m)	Cable Loss (dB)	Preamp Factor (dB)	Antenna Height (cm)	Table Angle (Degree)	Remark
5148	49.43	49.23	54	-4.57	31.32	6.2	37.32	200	175	Average
5148	62.59	62.39	74	-11.41	31.32	6.2	37.32	200	175	Peak
5190	89.04	88.81			31.35	6.22	37.34	200	175	Average
5190	96.27	96.04			31.35	6.22	37.34	200	175	Peak
5458	41.52	40.7	54	-12.48	31.56	6.34	37.08	200	175	Average
5458	61.06	60.24	74	-12.94	31.56	6.34	37.08	200	175	Peak
*10380	49.72	53.71	68.2	-18.48	39.21	9.05	52.25	107	301	Peak

Remarks:

- Emission Level = Read Level + Antenna Factor + Cable Loss - Preamp Factor
Margin value = Emission level – Limit value
- 5190 MHz: Fundamental Frequency
- *: Out of Restricted Band

EUT Test Condition		Measurement Detail	
Channel	Channel 46	Frequency Range	1 GHz ~ 40 GHz
Input Power	120 Vac, 60 Hz	Detector Function	Peak (PK) Average (AV)
Environmental Conditions	25 deg. C, 65 % RH	Tested By	Getaz Yang

Antenna Polarity & Test Distance: Horizontal at 3 m										
Frequency (MHz)	Emission Level (dBuV/m)	Read Level (dBuV)	Limit (dBuV/m)	Margin (dB)	Antenna Factor (dB/m)	Cable Loss (dB)	Preamp Factor (dB)	Antenna Height (cm)	Table Angle (Degree)	Remark
5076	42.6	42.43	54	-11.4	31.27	6.17	37.27	200	259	Average
5076	60.26	60.09	74	-13.74	31.27	6.17	37.27	200	259	Peak
5230	91.95	91.64			31.39	6.24	37.32	200	259	Average
5230	99	98.69			31.39	6.24	37.32	200	259	Peak
5440	41.84	41.08	54	-12.16	31.55	6.34	37.13	200	259	Average
5440	60.55	59.79	74	-13.45	31.55	6.34	37.13	200	259	Peak
*10460	49.58	53.77	68.2	-18.62	39.32	9.09	52.6	102	175	Peak

Antenna Polarity & Test Distance: Vertical at 3 m										
Frequency (MHz)	Emission Level (dBuV/m)	Read Level (dBuV)	Limit (dBuV/m)	Margin (dB)	Antenna Factor (dB/m)	Cable Loss (dB)	Preamp Factor (dB)	Antenna Height (cm)	Table Angle (Degree)	Remark
5040	40.98	40.83	54	-13.02	31.24	6.15	37.24	200	172	Average
5040	60.37	60.22	74	-13.63	31.24	6.15	37.24	200	172	Peak
5230	89.8	89.49			31.39	6.24	37.32	200	172	Average
5230	96.67	96.36			31.39	6.24	37.32	200	172	Peak
5420	41.65	40.98	54	-12.35	31.53	6.32	37.18	200	172	Average
5420	60.66	59.99	74	-13.34	31.53	6.32	37.18	200	172	Peak
*10460	48.67	52.86	68.2	-19.53	39.32	9.09	52.6	101	300	Peak

Remarks:

- Emission Level = Read Level + Antenna Factor + Cable Loss - Preamp Factor
Margin value = Emission level – Limit value
- 5230 MHz: Fundamental Frequency
- *: Out of Restricted Band

EUT Test Condition		Measurement Detail	
Channel	Channel 54	Frequency Range	1 GHz ~ 40 GHz
Input Power	120 Vac, 60 Hz	Detector Function	Peak (PK) Average (AV)
Environmental Conditions	25 deg. C, 65 % RH	Tested By	Getaz Yang

Antenna Polarity & Test Distance: Horizontal at 3 m										
Frequency (MHz)	Emission Level (dBuV/m)	Read Level (dBuV)	Limit (dBuV/m)	Margin (dB)	Antenna Factor (dB/m)	Cable Loss (dB)	Preamp Factor (dB)	Antenna Height (cm)	Table Angle (Degree)	Remark
5092	41.42	41.22	54	-12.58	31.28	6.19	37.27	199	237	Average
5092	60.46	60.26	74	-13.54	31.28	6.19	37.27	199	237	Peak
5270	92.53	92.14			31.41	6.25	37.27	199	237	Average
5270	99.2	98.81			31.41	6.25	37.27	199	237	Peak
5426	43.48	42.76	54	-10.52	31.53	6.32	37.13	199	237	Average
5426	60.56	59.84	74	-13.44	31.53	6.32	37.13	199	237	Peak
*10540	50.26	54.37	68.2	-17.94	39.46	9.12	52.69	150	163	Peak

Antenna Polarity & Test Distance: Vertical at 3 m										
Frequency (MHz)	Emission Level (dBuV/m)	Read Level (dBuV)	Limit (dBuV/m)	Margin (dB)	Antenna Factor (dB/m)	Cable Loss (dB)	Preamp Factor (dB)	Antenna Height (cm)	Table Angle (Degree)	Remark
5140	41.25	41.03	54	-12.75	31.32	6.2	37.3	216	172	Average
5140	60.56	60.34	74	-13.44	31.32	6.2	37.3	216	172	Peak
5270	88.72	88.33			31.41	6.25	37.27	216	172	Average
5270	95.85	95.46			31.41	6.25	37.27	216	172	Peak
5384	41.72	41.08	54	-12.28	31.51	6.31	37.18	216	172	Average
5384	60.31	59.67	74	-13.69	31.51	6.31	37.18	216	172	Peak
*10540	50.51	54.62	68.2	-17.69	39.46	9.12	52.69	102	32	Peak

Remarks:

- Emission Level = Read Level + Antenna Factor + Cable Loss - Preamp Factor
Margin value = Emission level – Limit value
- 5270 MHz: Fundamental Frequency
- *: Out of Restricted Band

EUT Test Condition		Measurement Detail	
Channel	Channel 62	Frequency Range	1 GHz ~ 40 GHz
Input Power	120 Vac, 60 Hz	Detector Function	Peak (PK) Average (AV)
Environmental Conditions	25 deg. C, 65 % RH	Tested By	Getaz Yang

Antenna Polarity & Test Distance: Horizontal at 3 m										
Frequency (MHz)	Emission Level (dBuV/m)	Read Level (dBuV)	Limit (dBuV/m)	Margin (dB)	Antenna Factor (dB/m)	Cable Loss (dB)	Preamp Factor (dB)	Antenna Height (cm)	Table Angle (Degree)	Remark
5030	41.07	40.93	54	-12.93	31.23	6.15	37.24	201	273	Average
5030	59.88	59.74	74	-14.12	31.23	6.15	37.24	201	273	Peak
5310	92.07	91.54			31.45	6.27	37.19	201	273	Average
5310	99.25	98.72			31.45	6.27	37.19	201	273	Peak
5350	49.09	48.5	54	-4.91	31.48	6.29	37.18	201	273	Average
5350	67.08	66.49	74	-6.92	31.48	6.29	37.18	201	273	Peak
10620	41.53	45.12	54	-12.47	39.59	9.16	52.34	150	161	Average
10620	51.07	54.66	74	-22.93	39.59	9.16	52.34	150	161	Peak

Antenna Polarity & Test Distance: Vertical at 3 m										
Frequency (MHz)	Emission Level (dBuV/m)	Read Level (dBuV)	Limit (dBuV/m)	Margin (dB)	Antenna Factor (dB/m)	Cable Loss (dB)	Preamp Factor (dB)	Antenna Height (cm)	Table Angle (Degree)	Remark
5008	40.96	40.85	54	-13.04	31.21	6.13	37.23	195	170	Average
5008	60.88	60.77	74	-13.12	31.21	6.13	37.23	195	170	Peak
5310	91.87	91.34			31.45	6.27	37.19	195	170	Average
5310	96.52	95.99			31.45	6.27	37.19	195	170	Peak
5350	44.34	43.75	54	-9.66	31.48	6.29	37.18	195	170	Average
5350	63.38	62.79	74	-10.62	31.48	6.29	37.18	195	170	Peak
10620	42.01	45.6	54	-11.99	39.59	9.16	52.34	104	30	Average
10620	51.81	55.4	74	-22.19	39.59	9.16	52.34	104	30	Peak

Remarks:

- Emission Level = Read Level + Antenna Factor + Cable Loss - Preamp Factor
Margin value = Emission level – Limit value
- 5310 MHz: Fundamental Frequency

EUT Test Condition		Measurement Detail	
Channel	Channel 102	Frequency Range	1 GHz ~ 40 GHz
Input Power	120 Vac, 60 Hz	Detector Function	Peak (PK) Average (AV)
Environmental Conditions	25 deg. C, 65 % RH	Tested By	Getaz Yang

Antenna Polarity & Test Distance: Horizontal at 3 m										
Frequency (MHz)	Emission Level (dBuV/m)	Read Level (dBuV)	Limit (dBuV/m)	Margin (dB)	Antenna Factor (dB/m)	Cable Loss (dB)	Preamp Factor (dB)	Antenna Height (cm)	Table Angle (Degree)	Remark
5392	43.6	42.96	54	-10.4	31.51	6.31	37.18	205	258	Average
5392	60.44	59.8	74	-13.56	31.51	6.31	37.18	205	258	Peak
*5470	61.48	60.65	68.2	-6.72	31.57	6.34	37.08	205	258	Peak
5510	90.81	89.91			31.6	6.36	37.06	205	258	Average
5510	97.5	96.6			31.6	6.36	37.06	205	258	Peak
*5725	60.09	58.81	68.2	-8.11	31.96	6.75	37.43	205	258	Peak
11020	42.52	46.47	54	-11.48	40.19	9.35	53.49	100	233	Average
11020	52.05	56	74	-21.95	40.19	9.35	53.49	100	233	Peak

Antenna Polarity & Test Distance: Vertical at 3 m										
Frequency (MHz)	Emission Level (dBuV/m)	Read Level (dBuV)	Limit (dBuV/m)	Margin (dB)	Antenna Factor (dB/m)	Cable Loss (dB)	Preamp Factor (dB)	Antenna Height (cm)	Table Angle (Degree)	Remark
5420	42.01	41.34	54	-11.99	31.53	6.32	37.18	194	169	Average
5420	61.42	60.75	74	-12.58	31.53	6.32	37.18	194	169	Peak
*5470	58.36	57.53	68.2	-9.84	31.57	6.34	37.08	194	169	Peak
5510	87.15	86.25			31.6	6.36	37.06	194	169	Average
5510	93.87	92.97			31.6	6.36	37.06	194	169	Peak
*5725	58.69	57.41	68.2	-9.51	31.96	6.75	37.43	194	169	Peak
11020	41.66	45.61	54	-12.34	40.19	9.35	53.49	100	135	Average
11020	51.21	55.16	74	-22.79	40.19	9.35	53.49	100	135	Peak

Remarks:

- Emission Level = Read Level + Antenna Factor + Cable Loss - Preamp Factor
Margin value = Emission level – Limit value
- 5510 MHz: Fundamental Frequency
- *: Out of Restricted Band

EUT Test Condition		Measurement Detail	
Channel	Channel 110	Frequency Range	1 GHz ~ 40 GHz
Input Power	120 Vac, 60 Hz	Detector Function	Peak (PK) Average (AV)
Environmental Conditions	25 deg. C, 65 % RH	Tested By	Getaz Yang

Antenna Polarity & Test Distance: Horizontal at 3 m										
Frequency (MHz)	Emission Level (dBuV/m)	Read Level (dBuV)	Limit (dBuV/m)	Margin (dB)	Antenna Factor (dB/m)	Cable Loss (dB)	Preamp Factor (dB)	Antenna Height (cm)	Table Angle (Degree)	Remark
5352	41.36	40.77	54	-12.64	31.48	6.29	37.18	201	243	Average
5352	59.87	59.28	74	-14.13	31.48	6.29	37.18	201	243	Peak
*5470	58.62	57.79	68.2	-9.58	31.57	6.34	37.08	201	243	Peak
5550	90.82	89.81			31.68	6.42	37.09	201	243	Average
5550	97.88	96.87			31.68	6.42	37.09	201	243	Peak
*5725	60.55	59.27	68.2	-7.65	31.96	6.75	37.43	201	243	Peak
11000	42.55	46.45	54	-11.45	40.2	9.35	53.45	100	106	Average
11000	52.61	56.51	74	-21.39	40.2	9.35	53.45	100	106	Peak

Antenna Polarity & Test Distance: Vertical at 3 m										
Frequency (MHz)	Emission Level (dBuV/m)	Read Level (dBuV)	Limit (dBuV/m)	Margin (dB)	Antenna Factor (dB/m)	Cable Loss (dB)	Preamp Factor (dB)	Antenna Height (cm)	Table Angle (Degree)	Remark
5436	41.1	40.36	54	-12.9	31.55	6.32	37.13	184	165	Average
5436	60.64	59.9	74	-13.36	31.55	6.32	37.13	184	165	Peak
*5470	58.75	57.92	68.2	-9.45	31.57	6.34	37.08	184	165	Peak
5550	87.55	86.54			31.68	6.42	37.09	184	165	Average
5550	94.79	93.78			31.68	6.42	37.09	184	165	Peak
*5725	59.44	58.16	68.2	-8.76	31.96	6.75	37.43	184	165	Peak
11000	41.43	45.33	54	-12.57	40.2	9.35	53.45	100	220	Average
11000	52.45	56.35	74	-21.55	40.2	9.35	53.45	100	220	Peak

Remarks:

- Emission Level = Read Level + Antenna Factor + Cable Loss - Preamp Factor
Margin value = Emission level – Limit value
- 5550 MHz: Fundamental Frequency
- *: Out of Restricted Band

EUT Test Condition		Measurement Detail	
Channel	Channel 134	Frequency Range	1 GHz ~ 40 GHz
Input Power	120 Vac, 60 Hz	Detector Function	Peak (PK) Average (AV)
Environmental Conditions	25 deg. C, 65 % RH	Tested By	Getaz Yang

Antenna Polarity & Test Distance: Horizontal at 3 m										
Frequency (MHz)	Emission Level (dBuV/m)	Read Level (dBuV)	Limit (dBuV/m)	Margin (dB)	Antenna Factor (dB/m)	Cable Loss (dB)	Preamp Factor (dB)	Antenna Height (cm)	Table Angle (Degree)	Remark
5406	41.33	40.67	54	-12.67	31.52	6.32	37.18	206	251	Average
5406	60.13	59.47	74	-13.87	31.52	6.32	37.18	206	251	Peak
*5470	58.38	57.55	68.2	-9.82	31.57	6.34	37.08	206	251	Peak
5670	91.74	90.58			31.88	6.62	37.34	206	251	Average
5670	99.26	98.1			31.88	6.62	37.34	206	251	Peak
*5725	59.58	58.3	68.2	-8.62	31.96	6.75	37.43	206	251	Peak
11340	43.58	46.29	54	-10.42	40	9.8	52.51	100	89	Average
11340	52.01	54.72	74	-21.99	40	9.8	52.51	100	89	Peak

Antenna Polarity & Test Distance: Vertical at 3 m										
Frequency (MHz)	Emission Level (dBuV/m)	Read Level (dBuV)	Limit (dBuV/m)	Margin (dB)	Antenna Factor (dB/m)	Cable Loss (dB)	Preamp Factor (dB)	Antenna Height (cm)	Table Angle (Degree)	Remark
5394	41.3	40.66	54	-12.7	31.51	6.31	37.18	198	177	Average
5394	61.08	60.44	74	-12.92	31.51	6.31	37.18	198	177	Peak
*5470	57.75	56.92	68.2	-10.45	31.57	6.34	37.08	198	177	Peak
5670	88.88	87.72			31.88	6.62	37.34	198	177	Average
5670	96.33	95.17			31.88	6.62	37.34	198	177	Peak
*5725	59.35	58.07	68.2	-8.85	31.96	6.75	37.43	198	177	Peak
11340	42.59	45.3	54	-11.41	40	9.8	52.51	100	191	Average
11340	51.46	54.17	74	-22.54	40	9.8	52.51	100	191	Peak

Remarks:

- Emission Level = Read Level + Antenna Factor + Cable Loss - Preamp Factor
Margin value = Emission level – Limit value
- 5670 MHz: Fundamental Frequency
- *: Out of Restricted Band

EUT Test Condition		Measurement Detail	
Channel	Channel 151	Frequency Range	1 GHz ~ 40 GHz
Input Power	120 Vac, 60 Hz	Detector Function	Peak (PK) Average (AV)
Environmental Conditions	25 deg. C, 65 % RH	Tested By	Getaz Yang

<Spurious Emission>

Antenna Polarity & Test Distance: Horizontal at 3 m										
Frequency (MHz)	Emission Level (dBuV/m)	Read Level (dBuV)	Limit (dBuV/m)	Margin (dB)	Antenna Factor (dB/m)	Cable Loss (dB)	Preamp Factor (dB)	Antenna Height (cm)	Table Angle (Degree)	Remark
5755	92.15	90.86			32.01	6.75	37.47	202	254	Average
5755	100.11	98.82			32.01	6.75	37.47	202	254	Peak
11510	43.77	46.91	54	-10.23	39.9	10.03	53.07	100	137	Average
11510	52.41	55.55	74	-21.59	39.9	10.03	53.07	100	137	Peak
Antenna Polarity & Test Distance: Vertical at 3 m										
Frequency (MHz)	Emission Level (dBuV/m)	Read Level (dBuV)	Limit (dBuV/m)	Margin (dB)	Antenna Factor (dB/m)	Cable Loss (dB)	Preamp Factor (dB)	Antenna Height (cm)	Table Angle (Degree)	Remark
5755	89.77	88.48			32.01	6.75	37.47	178	170	Average
5755	97.05	95.76			32.01	6.75	37.47	178	170	Peak
11510	43.42	46.56	54	-10.58	39.9	10.03	53.07	100	114	Average
11510	51.85	54.99	74	-22.15	39.9	10.03	53.07	100	114	Peak

<Out of Band Emission (OOBE)>

Antenna Polarity & Test Distance: Horizontal at 3 m										
Frequency (MHz)	Emission Level (dBuV/m)	Read Level (dBuV)	Limit (dBuV/m)	Margin (dB)	Antenna Factor (dB/m)	Cable Loss (dB)	Preamp Factor (dB)	Antenna Height (cm)	Table Angle (Degree)	Remark
*5637.875	50.5	49.4	68.2	-17.7	31.82	6.56	37.28	202	254	Peak
5654.5	51.04	49.91	71.54	-20.5	31.85	6.62	37.34	202	254	Peak
5921.925	51.15	49.35	70.47	-19.32	32.29	7.01	37.5	202	254	Peak
*5937.125	51.85	50.05	68.2	-16.35	32.29	7.01	37.5	202	254	Peak
Antenna Polarity & Test Distance: Vertical at 3 m										
Frequency (MHz)	Emission Level (dBuV/m)	Read Level (dBuV)	Limit (dBuV/m)	Margin (dB)	Antenna Factor (dB/m)	Cable Loss (dB)	Preamp Factor (dB)	Antenna Height (cm)	Table Angle (Degree)	Remark
*5640.25	49.71	48.61	68.2	-18.49	31.82	6.56	37.28	178	170	Peak
5661.15	50.67	49.54	76.48	-25.81	31.85	6.62	37.34	178	170	Peak
5913.85	51.17	49.4	76.42	-25.25	32.26	7.01	37.5	178	170	Peak
*5932.375	50.58	48.78	68.2	-17.62	32.29	7.01	37.5	178	170	Peak

Remarks:

- Emission Level = Read Level + Antenna Factor + Cable Loss - Preamp Factor
Margin value = Emission level – Limit value
- 5755 MHz: Fundamental Frequency
- *: Out of Restricted Band

EUT Test Condition		Measurement Detail	
Channel	Channel 159	Frequency Range	1 GHz ~ 40 GHz
Input Power	120 Vac, 60 Hz	Detector Function	Peak (PK) Average (AV)
Environmental Conditions	25 deg. C, 65 % RH	Tested By	Getaz Yang

<Spurious Emission>

Antenna Polarity & Test Distance: Horizontal at 3 m										
Frequency (MHz)	Emission Level (dBuV/m)	Read Level (dBuV)	Limit (dBuV/m)	Margin (dB)	Antenna Factor (dB/m)	Cable Loss (dB)	Preamp Factor (dB)	Antenna Height (cm)	Table Angle (Degree)	Remark
5795	92.74	91.39			32.07	6.82	37.54	218	252	Average
5795	100.45	99.1			32.07	6.82	37.54	218	252	Peak
11590	43.3	46.8	54	-10.7	39.74	10.09	53.33	100	147	Average
11590	52.12	55.62	74	-21.88	39.74	10.09	53.33	100	147	Peak
Antenna Polarity & Test Distance: Vertical at 3 m										
Frequency (MHz)	Emission Level (dBuV/m)	Read Level (dBuV)	Limit (dBuV/m)	Margin (dB)	Antenna Factor (dB/m)	Cable Loss (dB)	Preamp Factor (dB)	Antenna Height (cm)	Table Angle (Degree)	Remark
5795	90.06	88.71			32.07	6.82	37.54	185	167	Average
5795	97.57	96.22			32.07	6.82	37.54	185	167	Peak
11590	42.77	46.27	54	-11.23	39.74	10.09	53.33	100	169	Average
11590	51.79	55.29	74	-22.21	39.74	10.09	53.33	100	169	Peak

<Out of Band Emission (OOBE)>

Antenna Polarity & Test Distance: Horizontal at 3 m										
Frequency (MHz)	Emission Level (dBuV/m)	Read Level (dBuV)	Limit (dBuV/m)	Margin (dB)	Antenna Factor (dB/m)	Cable Loss (dB)	Preamp Factor (dB)	Antenna Height (cm)	Table Angle (Degree)	Remark
*5642.15	49.92	48.76	68.2	-18.28	31.82	6.62	37.28	218	252	Peak
5662.575	50.86	49.73	77.54	-26.68	31.85	6.62	37.34	218	252	Peak
5918.125	51.75	49.98	73.27	-21.52	32.26	7.01	37.5	218	252	Peak
*5933.8	51.55	49.75	68.2	-16.65	32.29	7.01	37.5	218	252	Peak
Antenna Polarity & Test Distance: Vertical at 3 m										
Frequency (MHz)	Emission Level (dBuV/m)	Read Level (dBuV)	Limit (dBuV/m)	Margin (dB)	Antenna Factor (dB/m)	Cable Loss (dB)	Preamp Factor (dB)	Antenna Height (cm)	Table Angle (Degree)	Remark
*5641.675	50.45	49.29	68.2	-17.75	31.82	6.62	37.28	185	167	Peak
5659.725	51.13	50	75.42	-24.29	31.85	6.62	37.34	185	167	Peak
5921.925	52.55	50.75	70.47	-17.92	32.29	7.01	37.5	185	167	Peak
*5938.075	51.79	49.99	68.2	-16.41	32.29	7.01	37.5	185	167	Peak

Remarks:

- Emission Level = Read Level + Antenna Factor + Cable Loss - Preamp Factor
Margin value = Emission level – Limit value
- 5795 MHz: Fundamental Frequency
- *: Out of Restricted Band

802.11ac (VHT80)

EUT Test Condition		Measurement Detail	
Channel	Channel 42	Frequency Range	1 GHz ~ 40 GHz
Input Power	120 Vac, 60 Hz	Detector Function	Peak (PK) Average (AV)
Environmental Conditions	25 deg. C, 65 % RH	Tested By	Getaz Yang

Antenna Polarity & Test Distance: Horizontal at 3 m

Frequency (MHz)	Emission Level (dBuV/m)	Read Level (dBuV)	Limit (dBuV/m)	Margin (dB)	Antenna Factor (dB/m)	Cable Loss (dB)	Preamp Factor (dB)	Antenna Height (cm)	Table Angle (Degree)	Remark
5150	53.62	53.42	54	-0.38	31.32	6.2	37.32	200	272	Average
5150	63.17	62.97	74	-10.83	31.32	6.2	37.32	200	272	Peak
5210	88.57	88.32			31.37	6.24	37.36	200	272	Average
5210	95.32	95.07			31.37	6.24	37.36	200	272	Peak
5402	42.77	42.11	54	-11.23	31.52	6.32	37.18	200	272	Average
5402	60.79	60.13	74	-13.21	31.52	6.32	37.18	200	272	Peak
*10420	49.57	53.57	68.2	-18.63	39.27	9.09	52.36	102	175	Peak

Antenna Polarity & Test Distance: Vertical at 3 m

Frequency (MHz)	Emission Level (dBuV/m)	Read Level (dBuV)	Limit (dBuV/m)	Margin (dB)	Antenna Factor (dB/m)	Cable Loss (dB)	Preamp Factor (dB)	Antenna Height (cm)	Table Angle (Degree)	Remark
5144	48.15	47.95	54	-5.85	31.32	6.2	37.32	200	175	Average
5144	61.03	60.83	74	-12.97	31.32	6.2	37.32	200	175	Peak
5210	82.94	82.69			31.37	6.24	37.36	200	175	Average
5210	90.02	89.77			31.37	6.24	37.36	200	175	Peak
5450	42.02	41.2	54	-11.98	31.56	6.34	37.08	200	175	Average
5450	60.82	60	74	-13.18	31.56	6.34	37.08	200	175	Peak
*10420	49.22	53.22	68.2	-18.98	39.27	9.09	52.36	101	301	Peak

Remarks:

- Emission Level = Read Level + Antenna Factor + Cable Loss - Preamp Factor
Margin value = Emission level – Limit value
- 5210 MHz: Fundamental Frequency
- *: Out of Restricted Band

EUT Test Condition		Measurement Detail	
Channel	Channel 58	Frequency Range	1 GHz ~ 40 GHz
Input Power	120 Vac, 60 Hz	Detector Function	Peak (PK) Average (AV)
Environmental Conditions	25 deg. C, 65 % RH	Tested By	Getaz Yang

Antenna Polarity & Test Distance: Horizontal at 3 m										
Frequency (MHz)	Emission Level (dBuV/m)	Read Level (dBuV)	Limit (dBuV/m)	Margin (dB)	Antenna Factor (dB/m)	Cable Loss (dB)	Preamp Factor (dB)	Antenna Height (cm)	Table Angle (Degree)	Remark
5106	42.07	41.87	54	-11.93	31.29	6.19	37.28	200	268	Average
5106	60.02	59.82	74	-13.98	31.29	6.19	37.28	200	268	Peak
5290	88.24	87.77			31.43	6.27	37.23	200	268	Average
5290	95.12	94.65			31.43	6.27	37.23	200	268	Peak
5358	47.86	47.25	54	-6.14	31.48	6.31	37.18	200	268	Average
5358	61.04	60.43	74	-12.96	31.48	6.31	37.18	200	268	Peak
*10580	49.73	53.44	68.2	-18.47	39.54	9.16	52.41	148	162	Peak

Antenna Polarity & Test Distance: Vertical at 3 m										
Frequency (MHz)	Emission Level (dBuV/m)	Read Level (dBuV)	Limit (dBuV/m)	Margin (dB)	Antenna Factor (dB/m)	Cable Loss (dB)	Preamp Factor (dB)	Antenna Height (cm)	Table Angle (Degree)	Remark
5146	41.56	41.36	54	-12.44	31.32	6.2	37.32	196	174	Average
5146	59.69	59.49	74	-14.31	31.32	6.2	37.32	196	174	Peak
5290	83.73	83.26			31.43	6.27	37.23	196	174	Average
5290	90.7	90.23			31.43	6.27	37.23	196	174	Peak
5354	43.64	43.05	54	-10.36	31.48	6.29	37.18	196	174	Average
5354	60.21	59.62	74	-13.79	31.48	6.29	37.18	196	174	Peak
*10580	49.53	53.24	68.2	-18.67	39.54	9.16	52.41	101	35	Peak

Remarks:

- Emission Level = Read Level + Antenna Factor + Cable Loss - Preamp Factor
Margin value = Emission level – Limit value
- 5290 MHz: Fundamental Frequency
- *: Out of Restricted Band

EUT Test Condition		Measurement Detail	
Channel	Channel 106	Frequency Range	1 GHz ~ 40 GHz
Input Power	120 Vac, 60 Hz	Detector Function	Peak (PK) Average (AV)
Environmental Conditions	25 deg. C, 65 % RH	Tested By	Getaz Yang

Antenna Polarity & Test Distance: Horizontal at 3 m										
Frequency (MHz)	Emission Level (dBuV/m)	Read Level (dBuV)	Limit (dBuV/m)	Margin (dB)	Antenna Factor (dB/m)	Cable Loss (dB)	Preamp Factor (dB)	Antenna Height (cm)	Table Angle (Degree)	Remark
5438	45.58	44.82	54	-8.42	31.55	6.34	37.13	206	254	Average
5438	61.24	60.48	74	-12.76	31.55	6.34	37.13	206	254	Peak
*5470	60.27	59.44	68.2	-7.93	31.57	6.34	37.08	206	254	Peak
5530	85.99	85.03			31.63	6.42	37.09	206	254	Average
5530	93.32	92.36			31.63	6.42	37.09	206	254	Peak
*5725	59.08	71.86	68.2	-9.12	31.96	7.72	52.46	206	254	Peak
11060	42.43	46.38	54	-11.57	40.16	9.46	53.57	100	315	Average
11060	50.95	54.9	74	-23.05	40.16	9.46	53.57	100	315	Peak

Antenna Polarity & Test Distance: Vertical at 3 m										
Frequency (MHz)	Emission Level (dBuV/m)	Read Level (dBuV)	Limit (dBuV/m)	Margin (dB)	Antenna Factor (dB/m)	Cable Loss (dB)	Preamp Factor (dB)	Antenna Height (cm)	Table Angle (Degree)	Remark
5432	43.64	42.9	54	-10.36	31.55	6.32	37.13	204	168	Average
5432	60.27	59.53	74	-13.73	31.55	6.32	37.13	204	168	Peak
*5470	58.87	58.04	68.2	-9.33	31.57	6.34	37.08	204	168	Peak
5530	84.42	83.46			31.63	6.42	37.09	204	168	Average
5530	90.78	89.82			31.63	6.42	37.09	204	168	Peak
*5725	59.21	57.93	68.2	-8.99	31.96	6.75	37.43	204	168	Peak
11060	41.79	45.74	54	-12.21	40.16	9.46	53.57	100	11	Average
11060	51.55	55.5	74	-22.45	40.16	9.46	53.57	100	11	Peak

Remarks:

- Emission Level = Read Level + Antenna Factor + Cable Loss - Preamp Factor
Margin value = Emission level – Limit value
- 5530 MHz: Fundamental Frequency
- *: Out of Restricted Band

EUT Test Condition		Measurement Detail	
Channel	Channel 122	Frequency Range	1 GHz ~ 40 GHz
Input Power	120 Vac, 60 Hz	Detector Function	Peak (PK) Average (AV)
Environmental Conditions	25 deg. C, 65 % RH	Tested By	Getaz Yang

Antenna Polarity & Test Distance: Horizontal at 3 m										
Frequency (MHz)	Emission Level (dBuV/m)	Read Level (dBuV)	Limit (dBuV/m)	Margin (dB)	Antenna Factor (dB/m)	Cable Loss (dB)	Preamp Factor (dB)	Antenna Height (cm)	Table Angle (Degree)	Remark
5440	41.62	40.86	54	-12.38	31.55	6.34	37.13	209	253	Average
5440	60.18	59.42	74	-13.82	31.55	6.34	37.13	209	253	Peak
*5470	59.14	58.31	68.2	-9.06	31.57	6.34	37.08	209	253	Peak
5610	86.02	84.91			31.77	6.56	37.22	209	253	Average
5610	93.14	92.03			31.77	6.56	37.22	209	253	Peak
*5725	60.31	59.03	68.2	-7.89	31.96	6.75	37.43	209	253	Peak
11220	42.83	46.1	54	-11.17	40.07	9.69	53.03	100	205	Average
11220	51.65	54.92	74	-22.35	40.07	9.69	53.03	100	205	Peak

Antenna Polarity & Test Distance: Vertical at 3 m										
Frequency (MHz)	Emission Level (dBuV/m)	Read Level (dBuV)	Limit (dBuV/m)	Margin (dB)	Antenna Factor (dB/m)	Cable Loss (dB)	Preamp Factor (dB)	Antenna Height (cm)	Table Angle (Degree)	Remark
5374	41.32	40.7	54	-12.68	31.49	6.31	37.18	176	166	Average
5374	59.84	59.22	74	-14.16	31.49	6.31	37.18	176	166	Peak
*5470	58.26	57.43	68.2	-9.94	31.57	6.34	37.08	176	166	Peak
5610	83.48	82.37			31.77	6.56	37.22	176	166	Average
5610	90.63	89.52			31.77	6.56	37.22	176	166	Peak
*5725	59.07	57.79	68.2	-9.13	31.96	6.75	37.43	176	166	Peak
11220	42.35	45.62	54	-11.65	40.07	9.69	53.03	100	300	Average
11220	51.49	54.76	74	-22.51	40.07	9.69	53.03	100	300	Peak

Remarks:

- Emission Level = Read Level + Antenna Factor + Cable Loss - Preamp Factor
Margin value = Emission level – Limit value
- 5610 MHz: Fundamental Frequency
- *: Out of Restricted Band

EUT Test Condition		Measurement Detail	
Channel	Channel 155	Frequency Range	1 GHz ~ 40 GHz
Input Power	120 Vac, 60 Hz	Detector Function	Peak (PK) Average (AV)
Environmental Conditions	25 deg. C, 65 % RH	Tested By	Getaz Yang

<Spurious Emission>

Antenna Polarity & Test Distance: Horizontal at 3 m										
Frequency (MHz)	Emission Level (dBuV/m)	Read Level (dBuV)	Limit (dBuV/m)	Margin (dB)	Antenna Factor (dB/m)	Cable Loss (dB)	Preamp Factor (dB)	Antenna Height (cm)	Table Angle (Degree)	Remark
5775	88.66	87.3			32.04	6.82	37.5	209	260	Average
5775	95.62	94.26			32.04	6.82	37.5	209	260	Peak
11550	43.4	46.74	54	-10.6	39.81	10.09	53.24	100	134	Average
11550	51.94	55.28	74	-22.06	39.81	10.09	53.24	100	134	Peak
Antenna Polarity & Test Distance: Vertical at 3 m										
Frequency (MHz)	Emission Level (dBuV/m)	Read Level (dBuV)	Limit (dBuV/m)	Margin (dB)	Antenna Factor (dB/m)	Cable Loss (dB)	Preamp Factor (dB)	Antenna Height (cm)	Table Angle (Degree)	Remark
5775	85.78	84.42			32.04	6.82	37.5	169	168	Average
5775	92.79	91.43			32.04	6.82	37.5	169	168	Peak
11550	42.93	46.27	54	-11.07	39.81	10.09	53.24	100	102	Average
11550	51.01	54.35	74	-22.99	39.81	10.09	53.24	100	102	Peak

<Out of Band Emission (OOBE)>

Antenna Polarity & Test Distance: Horizontal at 3 m										
Frequency (MHz)	Emission Level (dBuV/m)	Read Level (dBuV)	Limit (dBuV/m)	Margin (dB)	Antenna Factor (dB/m)	Cable Loss (dB)	Preamp Factor (dB)	Antenna Height (cm)	Table Angle (Degree)	Remark
*5646.425	51.6	50.44	68.2	-16.6	31.82	6.62	37.28	209	260	Peak
5666.375	52.72	51.59	80.35	-27.63	31.85	6.62	37.34	209	260	Peak
5912.9	52.51	50.74	77.13	-24.62	32.26	7.01	37.5	209	260	Peak
*5930.95	52.3	50.5	68.2	-15.9	32.29	7.01	37.5	209	260	Peak
Antenna Polarity & Test Distance: Vertical at 3 m										
Frequency (MHz)	Emission Level (dBuV/m)	Read Level (dBuV)	Limit (dBuV/m)	Margin (dB)	Antenna Factor (dB/m)	Cable Loss (dB)	Preamp Factor (dB)	Antenna Height (cm)	Table Angle (Degree)	Remark
*5645	50.44	49.28	68.2	-17.76	31.82	6.62	37.28	169	168	Peak
5657.35	50.18	49.05	73.66	-23.48	31.85	6.62	37.34	169	168	Peak
5904.825	52.13	50.35	83.09	-30.96	32.26	7.01	37.49	169	168	Peak
*5939.5	52.81	50.98	68.2	-15.39	32.32	7.01	37.5	169	168	Peak

Remarks:

- Emission Level = Read Level + Antenna Factor + Cable Loss - Preamp Factor
Margin value = Emission level – Limit value
- 5775 MHz: Fundamental Frequency
- *: Out of Restricted Band

9 kHz ~ 30 MHz DATA:

The amplitude of spurious emissions attenuated more than 20 dB below the permissible value is not required to be report.

30 MHz ~ 1 GHz WORST-CASE DATA:

802.11ac (VHT80)

EUT Test Condition		Measurement Detail	
Channel	Channel 42	Frequency Range	30 MHz ~ 1 GHz
Input Power	120 Vac, 60 Hz	Detector Function	Peak (PK) Quasi-peak (QP)
Environmental Conditions	25 deg. C, 65 % RH	Tested By	Getaz Yang

Antenna Polarity & Test Distance: Horizontal at 3 m										
Frequency (MHz)	Emission Level (dBuV/m)	Read Level (dBuV)	Limit (dBuV/m)	Margin (dB)	Antenna Factor (dB/m)	Cable Loss (dB)	Preamp Factor (dB)	Antenna Height (cm)	Table Angle (Degree)	Remark
90.14	27.15	49.84	43.5	-16.35	8.3	0.97	31.96	119	257	Peak
198.78	29.92	50.96	43.5	-13.58	9.43	1.29	31.76	111	358	Peak
347.19	36.15	52.14	46	-9.85	14.08	1.76	31.83	111	175	Peak
461.65	23.91	37.31	46	-22.09	16.56	2.01	31.97	126	82	Peak
635.28	20.99	30.74	46	-25.01	20.03	2.33	32.11	119	143	Peak
826.37	28.02	34.48	46	-17.98	22.57	2.65	31.68	133	217	Peak
Antenna Polarity & Test Distance: Vertical at 3 m										
Frequency (MHz)	Emission Level (dBuV/m)	Read Level (dBuV)	Limit (dBuV/m)	Margin (dB)	Antenna Factor (dB/m)	Cable Loss (dB)	Preamp Factor (dB)	Antenna Height (cm)	Table Angle (Degree)	Remark
90.14	31.72	54.41	43.5	-11.78	8.3	0.97	31.96	137	170	Peak
176.47	28.58	48.11	43.5	-14.92	11.1	1.17	31.8	104	333	Peak
301.6	28.59	45.82	46	-17.41	12.99	1.64	31.86	106	277	Peak
429.64	21.43	35.56	46	-24.57	15.93	1.95	32.01	140	125	Peak
665.35	24.35	33.43	46	-21.65	20.4	2.39	31.87	140	257	Peak
828.31	28.7	35.16	46	-17.3	22.59	2.65	31.7	106	360	Peak

Remarks:

1. Emission Level = Read Level + Antenna Factor + Cable Loss - Preamp Factor

Margin value = Emission level – Limit value

802.11n (HT40)

EUT Test Condition		Measurement Detail	
Channel	Channel 62	Frequency Range	30 MHz ~ 1 GHz
Input Power	120 Vac, 60 Hz	Detector Function	Peak (PK) Quasi-peak (QP)
Environmental Conditions	25 deg. C, 65 % RH	Tested By	Getaz Yang

Antenna Polarity & Test Distance: Horizontal at 3 m

Frequency (MHz)	Emission Level (dBuV/m)	Read Level (dBuV)	Limit (dBuV/m)	Margin (dB)	Antenna Factor (dB/m)	Cable Loss (dB)	Preamp Factor (dB)	Antenna Height (cm)	Table Angle (Degree)	Remark
127	30.48	49.75	43.5	-13.02	11.48	1.14	31.89	135	21	Peak
175.5	31.21	50.65	43.5	-12.29	11.19	1.16	31.79	117	343	Peak
303.54	38.64	55.85	46	-7.36	13.03	1.64	31.88	119	194	Peak
635.28	20.99	30.74	46	-25.01	20.03	2.33	32.11	132	43	Peak
801.15	27.33	33.91	46	-18.67	22.24	2.61	31.43	122	161	Peak
939.86	30.97	36.35	46	-15.03	23.73	2.82	31.93	108	39	Peak

Antenna Polarity & Test Distance: Vertical at 3 m

Frequency (MHz)	Emission Level (dBuV/m)	Read Level (dBuV)	Limit (dBuV/m)	Margin (dB)	Antenna Factor (dB/m)	Cable Loss (dB)	Preamp Factor (dB)	Antenna Height (cm)	Table Angle (Degree)	Remark
32.91	30.46	48.48	40	-9.54	12.47	0.6	31.09	110	24	Peak
72.68	29.82	50.66	40	-10.18	10.05	0.85	31.74	137	136	Peak
258.92	37.51	56.11	46	-8.49	11.74	1.52	31.86	103	18	Peak
532.46	26.86	38.35	46	-19.14	18.06	2.15	31.7	137	196	Peak
665.35	24.35	33.43	46	-21.65	20.4	2.39	31.87	135	213	Peak
949.56	30.01	35.2	46	-15.99	23.79	2.84	31.82	122	94	Peak

Remarks:

- Emission Level = Read Level + Antenna Factor + Cable Loss - Preamp Factor
Margin value = Emission level – Limit value

802.11a

EUT Test Condition		Measurement Detail	
Channel	Channel 140	Frequency Range	30 MHz ~ 1 GHz
Input Power	120 Vac, 60 Hz	Detector Function	Peak (PK) Quasi-peak (QP)
Environmental Conditions	25 deg. C, 65 % RH	Tested By	Getaz Yang

Antenna Polarity & Test Distance: Horizontal at 3 m

Frequency (MHz)	Emission Level (dBuV/m)	Read Level (dBuV)	Limit (dBuV/m)	Margin (dB)	Antenna Factor (dB/m)	Cable Loss (dB)	Preamp Factor (dB)	Antenna Height (cm)	Table Angle (Degree)	Remark
127	33.48	52.75	43.5	-10.02	11.48	1.14	31.89	132	123	Peak
175.5	33.21	52.65	43.5	-10.29	11.19	1.16	31.79	135	349	Peak
279.29	38.14	56.06	46	-7.86	12.34	1.58	31.84	129	96	Peak
583.87	27.15	37.82	46	-18.85	19.23	2.23	32.13	122	305	Peak
718.7	28.53	36.64	46	-17.47	21.08	2.48	31.67	131	185	Peak
939.86	30.97	36.35	46	-15.03	23.73	2.82	31.93	124	110	Peak

Antenna Polarity & Test Distance: Vertical at 3 m

Frequency (MHz)	Emission Level (dBuV/m)	Read Level (dBuV)	Limit (dBuV/m)	Margin (dB)	Antenna Factor (dB/m)	Cable Loss (dB)	Preamp Factor (dB)	Antenna Height (cm)	Table Angle (Degree)	Remark
72.68	34.82	55.66	40	-5.18	10.05	0.85	31.74	132	288	Peak
139.61	32.03	50.17	43.5	-11.47	12.34	1.16	31.64	114	122	Peak
268.62	31.39	49.83	46	-14.61	12.02	1.55	32.01	135	244	Peak
667.29	26.92	35.96	46	-19.08	20.42	2.39	31.85	101	150	Peak
828.31	30.7	37.16	46	-15.3	22.59	2.65	31.7	118	264	Peak
956.35	31.47	36.68	46	-14.53	23.83	2.85	31.89	115	98	Peak

Remarks:

- Emission Level = Read Level + Antenna Factor + Cable Loss - Preamp Factor
Margin value = Emission level – Limit value

802.11a

EUT Test Condition		Measurement Detail	
Channel	Channel 149	Frequency Range	30 MHz ~ 1 GHz
Input Power	120 Vac, 60 Hz	Detector Function	Peak (PK) Quasi-peak (QP)
Environmental Conditions	25 deg. C, 65 % RH	Tested By	Getaz Yang

Antenna Polarity & Test Distance: Horizontal at 3 m										
Frequency (MHz)	Emission Level (dBuV/m)	Read Level (dBuV)	Limit (dBuV/m)	Margin (dB)	Antenna Factor (dB/m)	Cable Loss (dB)	Preamp Factor (dB)	Antenna Height (cm)	Table Angle (Degree)	Remark
73.65	28.39	49.44	40	-11.61	9.81	0.85	31.71	129	145	Peak
127	28.48	47.75	43.5	-15.02	11.48	1.14	31.89	124	67	Peak
247.28	40.46	59.52	46	-5.54	11.36	1.48	31.9	137	24	Peak
532.46	21.91	33.4	46	-24.09	18.06	2.15	31.7	106	334	Peak
718.7	26.53	34.64	46	-19.47	21.08	2.48	31.67	140	207	Peak
917.55	27.92	33.54	46	-18.08	23.61	2.78	32.01	125	290	Peak
Antenna Polarity & Test Distance: Vertical at 3 m										
Frequency (MHz)	Emission Level (dBuV/m)	Read Level (dBuV)	Limit (dBuV/m)	Margin (dB)	Antenna Factor (dB/m)	Cable Loss (dB)	Preamp Factor (dB)	Antenna Height (cm)	Table Angle (Degree)	Remark
72.68	29.82	50.66	40	-10.18	10.05	0.85	31.74	137	143	Peak
176.47	27.58	47.11	43.5	-15.92	11.1	1.17	31.8	112	358	Peak
268.62	28.39	46.83	46	-17.61	12.02	1.55	32.01	101	205	Peak
582.9	24.23	34.92	46	-21.77	19.21	2.23	32.13	104	160	Peak
828.31	29.7	36.16	46	-16.3	22.59	2.65	31.7	101	188	Peak
923.37	30.96	36.53	46	-15.04	23.64	2.79	32	100	311	Peak

Remarks:

- Emission Level = Read Level + Antenna Factor + Cable Loss - Preamp Factor
Margin value = Emission level – Limit value

4.2 Conducted Emission Measurement

4.2.1 Limits of Conducted Emission Measurement

Frequency (MHz)	Conducted Limit (dBuV)	
	Quasi-peak	Average
0.15 - 0.5	66 - 56	56 - 46
0.50 - 5.0	56	46
5.0 - 30.0	60	50

Note: 1. The lower limit shall apply at the transition frequencies.

2. The limit decreases in line with the logarithm of the frequency in the range of 0.15 to 0.50 MHz.

4.2.2 Test Instruments

Description & Manufacturer	Model No.	Serial No.	Date Of Calibration	Due Date Of Calibration
Test Receiver ROHDE & SCHWARZ	ESCI	100613	Nov. 21, 2016	Nov. 20, 2017
RF signal cable (with 10dB PAD) Woken	5D-FB	Cable-cond1-01	Dec. 26, 2015	Dec. 25, 2016
LISN ROHDE & SCHWARZ (EUT)	ESH3-Z5	835239/001	Feb. 26, 2016	Feb. 25, 2017
LISN ROHDE & SCHWARZ (Peripheral)	ESH3-Z5	100311	Jul. 28, 2016	Jul. 27, 2017
Software ADT	BV ADT_Cond_ V7.3.7.3	NA	NA	NA

- Note:**
1. The calibration interval of the above test instruments is 12 months and the calibrations are traceable to NML/ROC and NIST/USA.
 2. The test was performed in HwaYa Shielded Room 1.
 3. The VCCI Site Registration No. is C-2040.

4.2.3 Test Procedures

- a. The EUT was placed 0.4 meters from the conducting wall of the shielded room with EUT being connected to the power mains through a line impedance stabilization network (LISN). Other support units were connected to the power mains through another LISN. The two LISNs provide 50 ohm/ 50uH of coupling impedance for the measuring instrument.
- b. Both lines of the power mains connected to the EUT were checked for maximum conducted interference.
- c. The frequency range from 150 kHz to 30 MHz was searched. Emission levels under (Limit -20 dB) was not recorded.

Note: All modes of operation were investigated and the worst-case emissions are reported.

4.2.4 Deviation from Test Standard

No deviation.

4.2.5 Test Setup

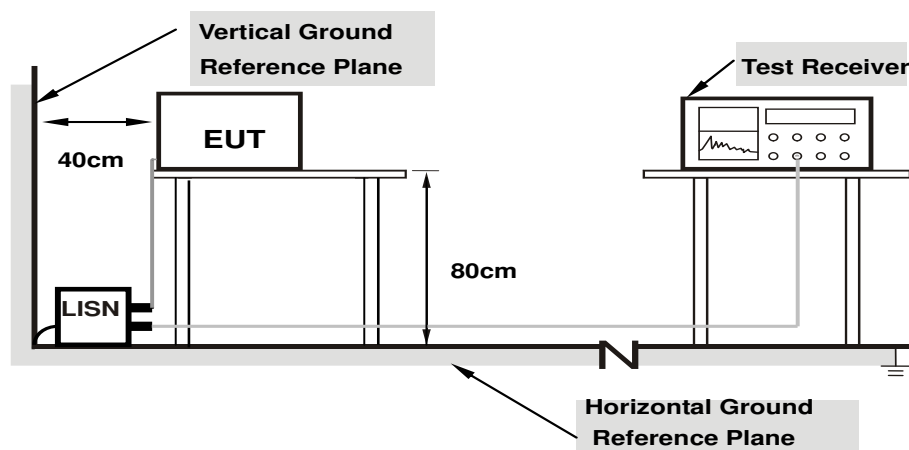

- Note:**
- 1.Support units were connected to second LISN.
 - 2.Both of LISNs (AMN) are 80 cm from EUT and at least 80 from other units and other metal planes

For the actual test configuration, please refer to the attached file (Test Setup Photo).

4.2.6 EUT Operating Conditions

- a. Placed the EUT on a testing table.
- b. Use the software to control the EUT under transmission condition continuously at specific channel frequency.

4.2.7 Test Results

Frequency Range	150kHz ~ 30MHz	Detector Function & Resolution Bandwidth	Quasi-Peak (QP) / Average (AV), 9kHz
Input Power	120Vac, 60Hz	Environmental Conditions	25°C, 65%RH
Tested by	Toby Tian	Test Date	2016/11/23

Phase Of Power : Line (L)										
No	Frequency (MHz)	Correction Factor (dB)	Reading Value (dBuV)		Emission Level (dBuV)		Limit (dBuV)		Margin (dB)	
			Q.P.	AV.	Q.P.	AV.	Q.P.	AV.	Q.P.	AV.
1	0.15400	10.02	20.51	13.42	30.53	23.44	65.78	55.78	-35.25	-32.34
2	0.34577	10.10	21.62	16.40	31.72	26.50	59.06	49.06	-27.34	-22.56
3	0.48444	10.13	33.97	28.49	44.10	38.62	56.26	46.26	-12.16	-7.64
4	0.90600	10.19	21.93	16.79	32.12	26.98	56.00	46.00	-23.88	-19.02
5	1.43054	10.23	21.82	16.47	32.05	26.70	56.00	46.00	-23.95	-19.30
6	3.77400	10.39	18.64	12.26	29.03	22.65	56.00	46.00	-26.97	-23.35

Remarks:

1. Q.P. and AV. are abbreviations of quasi-peak and average individually.
2. The emission levels of other frequencies were very low against the limit.
3. Margin value = Emission level – Limit value
4. Correction factor = Insertion loss + Cable loss
5. Emission Level = Correction Factor + Reading Value

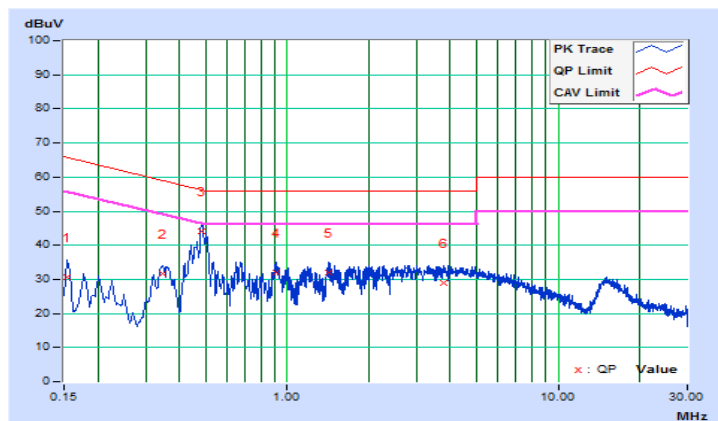

Frequency Range	150kHz ~ 30MHz	Detector Function & Resolution Bandwidth	Quasi-Peak (QP) / Average (AV), 9kHz
Input Power	120Vac, 60Hz	Environmental Conditions	25°C, 65%RH
Tested by	Toby Tian	Test Date	2016/11/23

Phase Of Power : Neutral (N)										
No	Frequency (MHz)	Correction Factor (dB)	Reading Value (dBuV)		Emission Level (dBuV)		Limit (dBuV)		Margin (dB)	
			Q.P.	AV.	Q.P.	AV.	Q.P.	AV.	Q.P.	AV.
1	0.17801	10.03	21.69	12.56	31.72	22.59	64.58	54.58	-32.86	-31.99
2	0.48600	10.14	35.01	29.93	45.15	40.07	56.24	46.24	-11.09	-6.17
3	0.67339	10.17	20.25	14.37	30.42	24.54	56.00	46.00	-25.58	-21.46
4	0.93000	10.20	20.05	14.16	30.25	24.36	56.00	46.00	-25.75	-21.64
5	1.44951	10.24	18.59	12.31	28.83	22.55	56.00	46.00	-27.17	-23.45
6	3.89000	10.42	14.77	7.34	25.19	17.76	56.00	46.00	-30.81	-28.24

Remarks:

1. Q.P. and AV. are abbreviations of quasi-peak and average individually.
2. The emission levels of other frequencies were very low against the limit.
3. Margin value = Emission level – Limit value
4. Correction factor = Insertion loss + Cable loss
5. Emission Level = Correction Factor + Reading Value

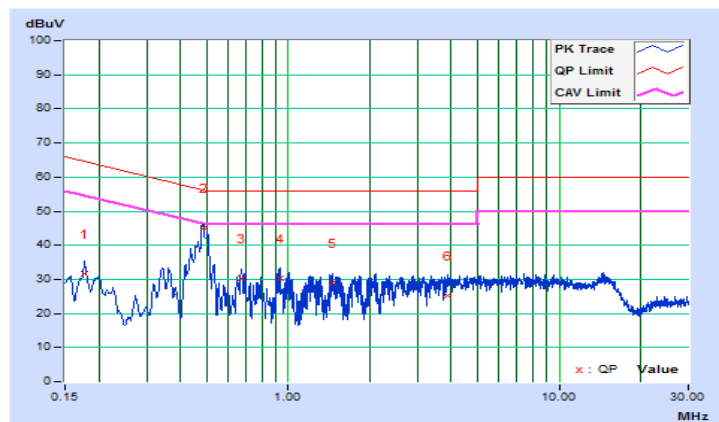

4.3 Transmit Power Measurement

4.3.1 Limits of Transmit Power Measurement

Operation Band	EUT Category	Limit
U-NII-1	Outdoor Access Point	1 Watt (30 dBm) (Max. e.i.r.p \leq 125 mW (21 dBm) at any elevation angle above 30 degrees as measured from the horizon)
	Fixed point-to-point Access Point	1 Watt (30 dBm)
	Indoor Access Point	1 Watt (30 dBm)
	√ Mobile and Portable client device	250 mW (24 dBm)
U-NII-2A	√	250 mW (24 dBm) or 11 dBm+10 log B*
U-NII-2C	√	250 mW (24 dBm) or 11 dBm+10 log B*
U-NII-3	√	1 Watt (30 dBm)

*B is the 26 dB emission bandwidth in megahertz

4.3.2 Test Setup

<Power Output Measurement>

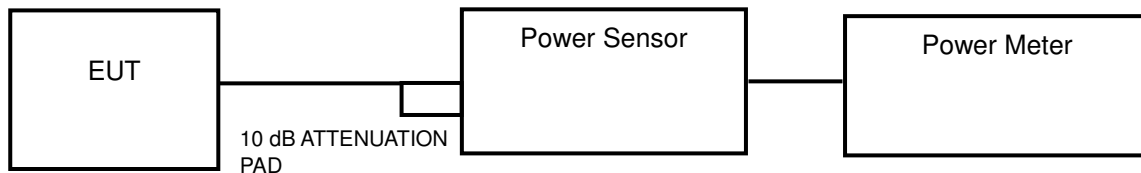

or

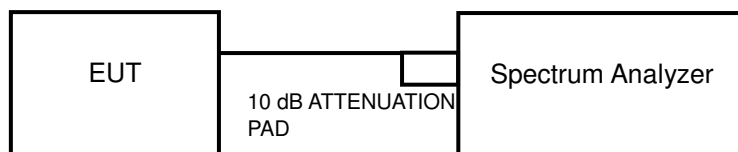

<26 dB Bandwidth>

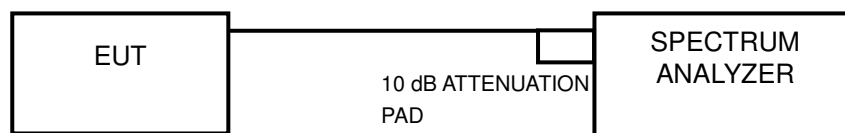

4.3.3 Test Instruments

Refer to section 4.1.2 to get information of above instrument.

4.3.4 Test Procedure

Average Power Measurement

<802.11a, 802.11n (HT20), 802.11n (HT40)>

Method PM is used to perform output power measurement, trigger and gating function of wide band power meter is enabled to measure max output power of TX on burst. Duty factor is not added to measured value.

26 dB Bandwidth

- 1) Set RBW = approximately 1 % of the emission bandwidth.
- 2) Set the VBW > RBW.
- 3) Detector = Peak.
- 4) Trace mode = max hold.
- 5) Measure the maximum width of the emission that is 26 dB down from the peak of the emission. Compare this with the RBW setting of the analyzer. Readjust RBW and repeat measurement as needed until the RBW/EBW ratio is approximately 1 %.

4.3.5 Deviation from Test Standard

No deviation.

4.3.6 EUT Operating Conditions

The software provided by client to enable the EUT under transmission condition continuously at lowest, middle and highest channel frequencies individually.

4.3.7 Test Result

Power Output:

802.11a

Channel	Frequency (MHz)	Maximum Conducted Power (mW)	Maximum Conducted Power (dBm)	Power Limit (dBm)	Pass / Fail
36	5180	13.397	11.27	24	Pass
44	5220	14.322	11.56	24	Pass
48	5240	14.158	11.51	24	Pass
52	5260	14.093	11.49	24	Pass
60	5300	13.804	11.40	24	Pass
64	5320	15.959	12.03	24	Pass
100	5500	16.331	12.13	24	Pass
116	5580	13.772	11.39	24	Pass
140	5700	11.376	10.56	24	Pass
149	5745	12.359	10.92	30	Pass
157	5785	11.885	10.75	30	Pass
165	5825	11.858	10.74	30	Pass

Note:

For U-NII-2A, U-NII-2C Band:

1. $11 \text{ dBm} + 10\log(22.10) = 24.44 \text{ dBm} > 24 \text{ dBm}$.
2. $11 \text{ dBm} + 10\log(21.66) = 24.35 \text{ dBm} > 24 \text{ dBm}$.
3. $11 \text{ dBm} + 10\log(21.62) = 24.34 \text{ dBm} > 24 \text{ dBm}$.
4. $11 \text{ dBm} + 10\log(21.48) = 24.32 \text{ dBm} > 24 \text{ dBm}$.
5. $11 \text{ dBm} + 10\log(21.48) = 24.32 \text{ dBm} > 24 \text{ dBm}$.
6. $11 \text{ dBm} + 10\log(21.57) = 24.33 \text{ dBm} > 24 \text{ dBm}$.

802.11n (HT20)

Channel	Frequency (MHz)	Maximum Conducted Power (mW)	Maximum Conducted Power (dBm)	Power Limit (dBm)	Pass / Fail
36	5180	12.417	10.94	24	Pass
44	5220	12.274	10.89	24	Pass
48	5240	13.002	11.14	24	Pass
52	5260	12.05	10.81	24	Pass
60	5300	12.794	11.07	24	Pass
64	5320	13.646	11.35	24	Pass
100	5500	13.9	11.43	24	Pass
116	5580	12.078	10.82	24	Pass
140	5700	10.495	10.21	24	Pass
149	5745	11.066	10.44	30	Pass
157	5785	11.324	10.54	30	Pass
165	5825	10.666	10.28	30	Pass

Note:

For U-NII-2A, U-NII-2C Band:

1. $11 \text{ dBm} + 10\log(21.78) = 24.38 \text{ dBm} > 24 \text{ dBm}$.
2. $11 \text{ dBm} + 10\log(22.08) = 24.43 \text{ dBm} > 24 \text{ dBm}$.
3. $11 \text{ dBm} + 10\log(21.83) = 24.39 \text{ dBm} > 24 \text{ dBm}$.
4. $11 \text{ dBm} + 10\log(21.90) = 24.40 \text{ dBm} > 24 \text{ dBm}$.
5. $11 \text{ dBm} + 10\log(21.78) = 24.38 \text{ dBm} > 24 \text{ dBm}$.
6. $11 \text{ dBm} + 10\log(21.97) = 24.41 \text{ dBm} > 24 \text{ dBm}$.

802.11n (HT40)

Channel	Frequency (MHz)	Maximum Conducted Power (mW)	Maximum Conducted Power (dBm)	Power Limit (dBm)	Pass / Fail
38	5190	11.885	10.75	24	Pass
46	5230	13.122	11.18	24	Pass
54	5270	11.94	10.77	24	Pass
62	5310	13.868	11.42	24	Pass
102	5510	14.421	11.59	24	Pass
110	5550	12.794	11.07	24	Pass
134	5670	10.889	10.37	24	Pass
151	5755	10.544	10.23	30	Pass
159	5795	10.839	10.35	30	Pass

Note:

For U-NII-2A, U-NII-2C Band:

- $11 \text{ dBm} + 10\log(56.95) = 28.55 \text{ dBm} > 24 \text{ dBm}$.
- $11 \text{ dBm} + 10\log(41.33) = 27.16 \text{ dBm} > 24 \text{ dBm}$.
- $11 \text{ dBm} + 10\log(41.43) = 27.17 \text{ dBm} > 24 \text{ dBm}$.
- $11 \text{ dBm} + 10\log(41.38) = 27.16 \text{ dBm} > 24 \text{ dBm}$.
- $11 \text{ dBm} + 10\log(41.46) = 27.17 \text{ dBm} > 24 \text{ dBm}$.

802.11ac (VHT80)

Channel	Frequency (MHz)	Maximum Conducted Power (mW)	Maximum Conducted Power (dBm)	Power Limit (dBm)	Pass / Fail
42	5210	5.433	7.35	24	Pass
58	5290	6.761	8.30	24	Pass
106	5530	7.834	8.94	24	Pass
122	5610	5.888	7.70	24	Pass
155	5775	5.200	7.16	30	Pass

Note:

For U-NII-2A, U-NII-2C Band:

- $11 \text{ dBm} + 10\log(81.85) = 30.13 \text{ dBm} > 24 \text{ dBm}$.
- $11 \text{ dBm} + 10\log(81.45) = 30.10 \text{ dBm} > 24 \text{ dBm}$.
- $11 \text{ dBm} + 10\log(81.52) = 30.11 \text{ dBm} > 24 \text{ dBm}$.

26 dB Bandwidth:
802.11a

Channel	Frequency (MHz)	26 dBc Bandwidth (MHz)
36	5180	21.73
44	5220	21.66
48	5240	21.54
52	5260	22.10
60	5300	21.66
64	5320	21.62
100	5500	21.48
116	5580	21.48
140	5700	21.57

802.11n (HT20)

Channel	Frequency (MHz)	26 dBc Bandwidth (MHz)
36	5180	21.84
44	5220	21.86
48	5240	21.93
52	5260	21.78
60	5300	22.08
64	5320	21.83
100	5500	21.90
116	5580	21.78
140	5700	21.97

802.11n (HT40)

Channel	Frequency (MHz)	26 dBc Bandwidth (MHz)
38	5190	42.00
46	5230	57.73
54	5270	56.95
62	5310	41.33
102	5510	41.43
110	5550	41.38
134	5670	41.46

802.11ac (VHT80)

Channel	Frequency (MHz)	26 dBc Bandwidth (MHz)
42	5210	81.78
58	5290	81.85
106	5530	81.45
122	5610	81.52

Spectrum Plot of Worst Value

802.11a

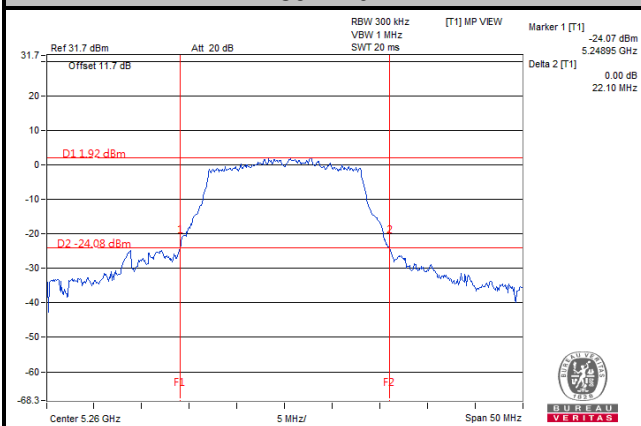

802.11n (HT20)

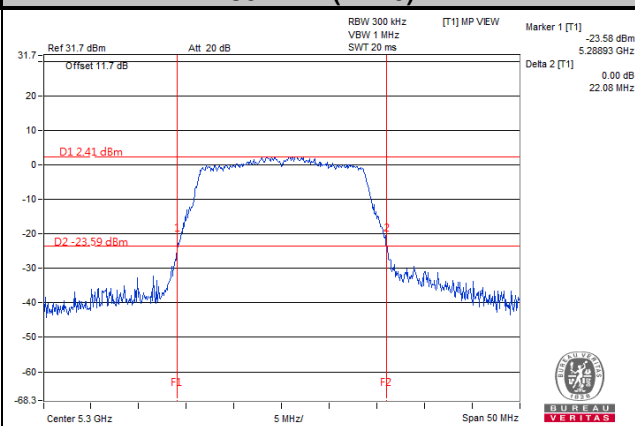

802.11n (HT40)

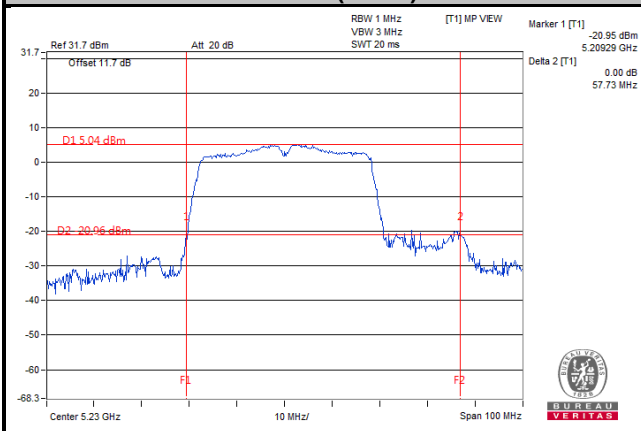

802.11ac (VHT80)

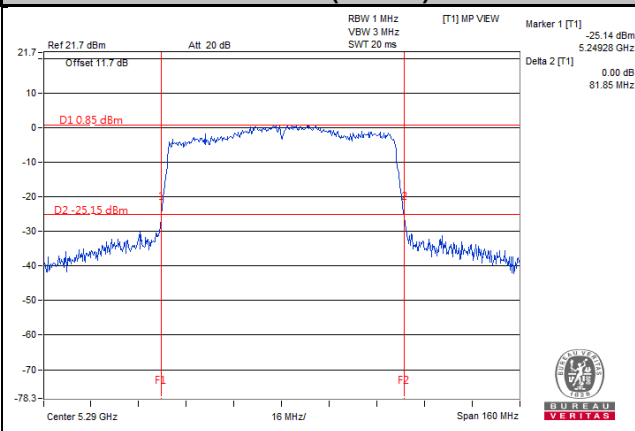

4.4 Peak Power Spectral Density Measurement

4.4.1 Limits of Peak Power Spectral Density Measurement

Operation Band	EUT Category		Limit
U-NII-1		Outdoor Access Point	17 dBm/MHz
		Fixed point-to-point Access Point	
		Indoor Access Point	
	√	Mobile and Portable client device	11 dBm/MHz
U-NII-2A		√	11 dBm/MHz
U-NII-2C		√	11 dBm/MHz
U-NII-3		√	30 dBm/500 kHz

4.4.2 Test Setup

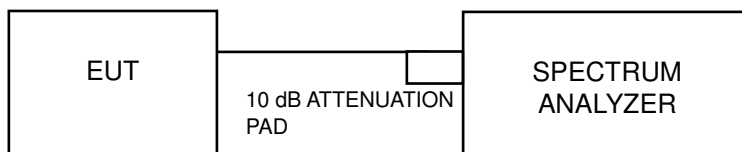

4.4.3 Test Instruments

Refer to section 4.1.3 to get information of above instrument.

4.4.4 Test Procedures

For U-NII-1, U-NII-2A, U-NII-2C band:

Using method SA-1

1. Set span to encompass the entire emission bandwidth (EBW) of the signal.
2. Set RBW = 1 MHz, Set VBW \geq 3 RBW, Detector = RMS
3. Sweep time = auto, trigger set to "free run".
4. Trace average at least 100 traces in power averaging mode.
5. Record the max value

Using method SA-2

1. Set span to encompass the entire emission bandwidth (EBW) of the signal.
2. Set RBW = 1 MHz, Set VBW \geq 3 RBW, Detector = RMS
3. Sweep time = auto, trigger set to "free run".
4. Trace average at least 100 traces in power averaging mode.
5. Record the max value and add $10 \log (1/\text{duty cycle})$

※For U-NII-3:

1. Set span to encompass the entire emission bandwidth (EBW) of the signal.
2. Set RBW = 500 kHz, Set VBW \geq 3 RBW, Detector = RMS
3. Use the peak marker function to determine the maximum power level in any 500 kHz band segment within the fundamental EBW.
4. Sweep time = auto, trigger set to "free run".
5. Trace average at least 100 traces in power averaging mode.
6. Record the max value and add 10 log (1/duty cycle)

4.4.5 Deviation from Test Standard

No deviation.

4.4.6 EUT Operating Conditions

The software provided by client to enable the EUT under transmission condition continuously at lowest, middle and highest channel frequencies individually.

4.4.7 Test Results

For U-NII-1, U-NII-2A, U-NII-2C Band

802.11a

Channel	Frequency (MHz)	PSD w/o Duty Factor (dBm)	Duty Factor	PSD with Duty Factor (dBm)	Maximum Limit (dBm)	Pass / Fail
36	5180	-0.75	0.09	-0.66	11	Pass
44	5220	-0.46	0.09	-0.37	11	Pass
48	5240	-0.43	0.09	-0.34	11	Pass
52	5260	-0.69	0.09	-0.60	11	Pass
60	5300	0.30	0.09	0.39	11	Pass
64	5320	0.52	0.09	0.61	11	Pass
100	5500	2.00	0.09	2.09	11	Pass
116	5580	0.75	0.09	0.84	11	Pass
140	5700	-1.11	0.09	-1.02	11	Pass

Note: Refer to section 3.3 for duty cycle spectrum plot.

802.11n (HT20)

Channel	Frequency (MHz)	PSD (dBm)	Maximum Limit (dBm)	Pass / Fail
36	5180	-1.25	11	Pass
44	5220	-1.34	11	Pass
48	5240	-1.06	11	Pass
52	5260	-1.13	11	Pass
60	5300	-0.53	11	Pass
64	5320	0.01	11	Pass
100	5500	1.48	11	Pass
116	5580	0.07	11	Pass
140	5700	-1.86	11	Pass

802.11n (HT40)

Channel	Frequency (MHz)	PSD w/o Duty Factor (dBm)	Duty Factor	PSD with Duty Factor (dBm)	Maximum Limit (dBm)	Pass / Fail
38	5190	-3.96	0.14	-3.82	11	Pass
46	5230	-3.54	0.14	-3.40	11	Pass
54	5270	-3.71	0.14	-3.57	11	Pass
62	5310	-2.68	0.14	-2.54	11	Pass
102	5510	-1.58	0.14	-1.44	11	Pass
110	5550	-1.72	0.14	-1.58	11	Pass
134	5670	-3.89	0.14	-3.75	11	Pass

Note: Refer to section 3.3 for duty cycle spectrum plot.

802.11ac (VHT80)

Channel	Frequency (MHz)	PSD w/o Duty Factor (dBm)	Duty Factor	PSD with Duty Factor (dBm)	Maximum Limit (dBm)	Pass / Fail
42	5210	-10.77	0.44	-10.32	11	Pass
58	5290	-9.85	0.44	-9.41	11	Pass
106	5530	-8.51	0.44	-8.07	11	Pass
122	5610	-10.14	0.44	-9.70	11	Pass

Note: Refer to section 3.3 for duty cycle spectrum plot.

Spectrum Plot of Worst Value

802.11a

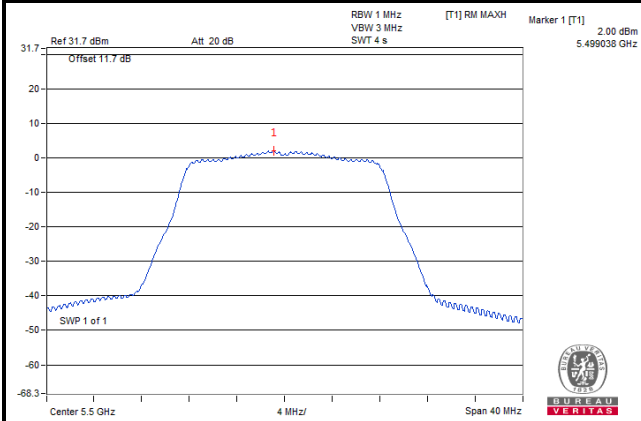

802.11n (HT20)

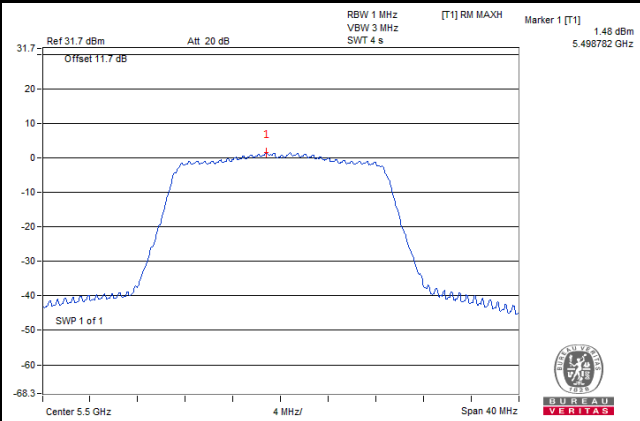

802.11n (HT40)

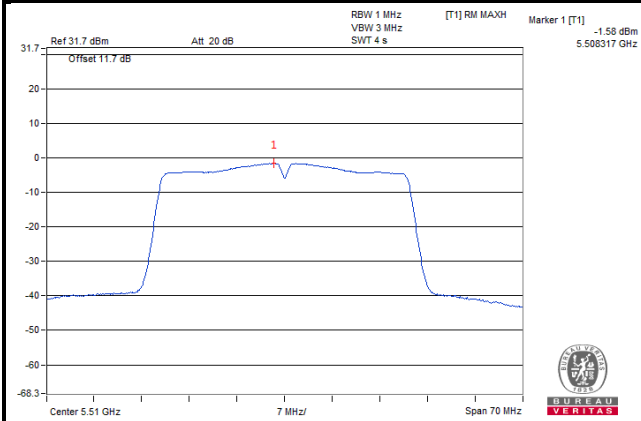

802.11ac (VHT80)

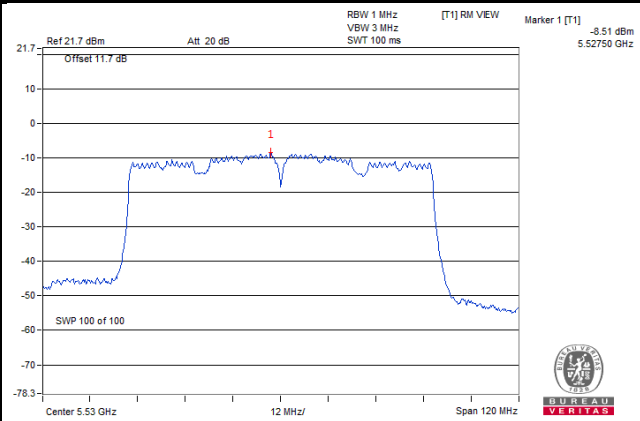

For U-NII-3 Band

802.11a

Channel	Frequency (MHz)	PSD w/o Duty Factor (dBm)	Duty Factor	PSD with Duty Factor (dBm)	Limit (dBm/500 kHz)	Pass / Fail
149	5745	-3.98	0.09	-3.89	30	Pass
157	5785	-3.99	0.09	-3.90	30	Pass
165	5825	-3.61	0.09	-3.52	30	Pass

Note: Refer to section 3.3 for duty cycle spectrum plot.

802.11n (HT20)

Channel	Freq. (MHz)	PSD (dBm/500 kHz)	Limit (dBm/500 kHz)	Pass / Fail
149	5745	-4.72	30	Pass
157	5785	-4.58	30	Pass
165	5825	-4.93	30	Pass

802.11n (HT40)

Channel	Frequency (MHz)	PSD w/o Duty Factor (dBm)	Duty Factor	PSD with Duty Factor (dBm)	Limit (dBm/500 kHz)	Pass / Fail
151	5755	-7.88	0.14	-7.74	30	Pass
159	5795	-7.36	0.14	-7.22	30	Pass

Note: Refer to section 3.3 for duty cycle spectrum plot.

802.11ac (VHT80)

Channel	Frequency (MHz)	PSD w/o Duty Factor (dBm)	Duty Factor	PSD with Duty Factor (dBm)	Limit (dBm/500 kHz)	Pass / Fail
155	5775	-12.84	0.44	-12.40	30	Pass

Note: Refer to section 3.3 for duty cycle spectrum plot.

Spectrum Plot of Worst Value

802.11a

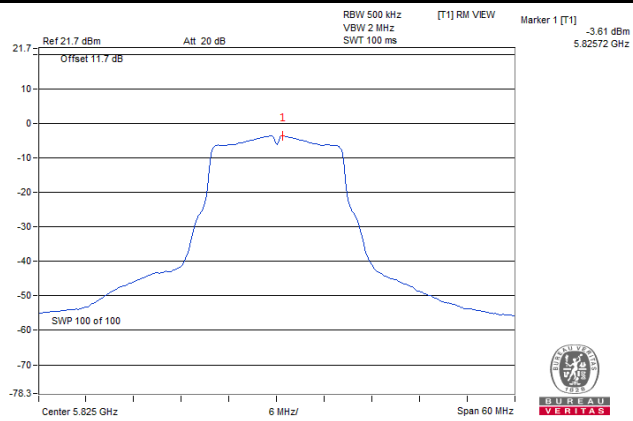

802.11n (HT20)

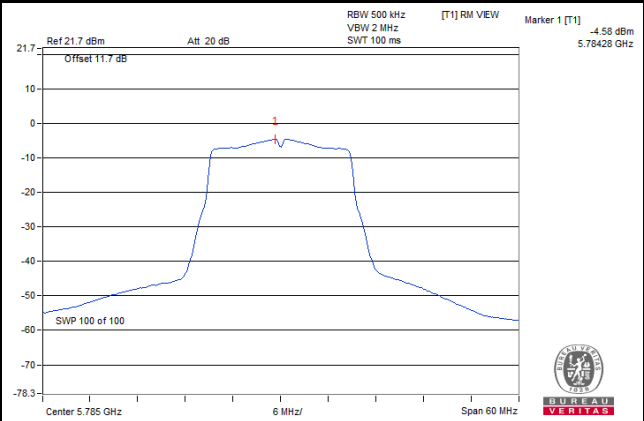

802.11n (HT40)

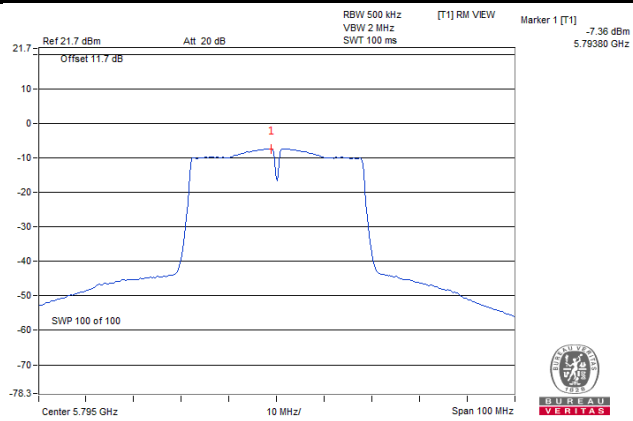

802.11ac (VHT80)

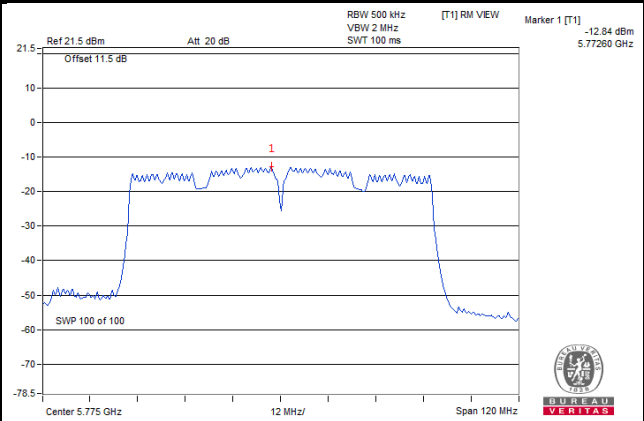

4.5 Frequency Stability

4.5.1 Limit of Frequency Stability Measurement

The frequency of the carrier signal shall be maintained within band of operation.

4.5.2 Test Setup

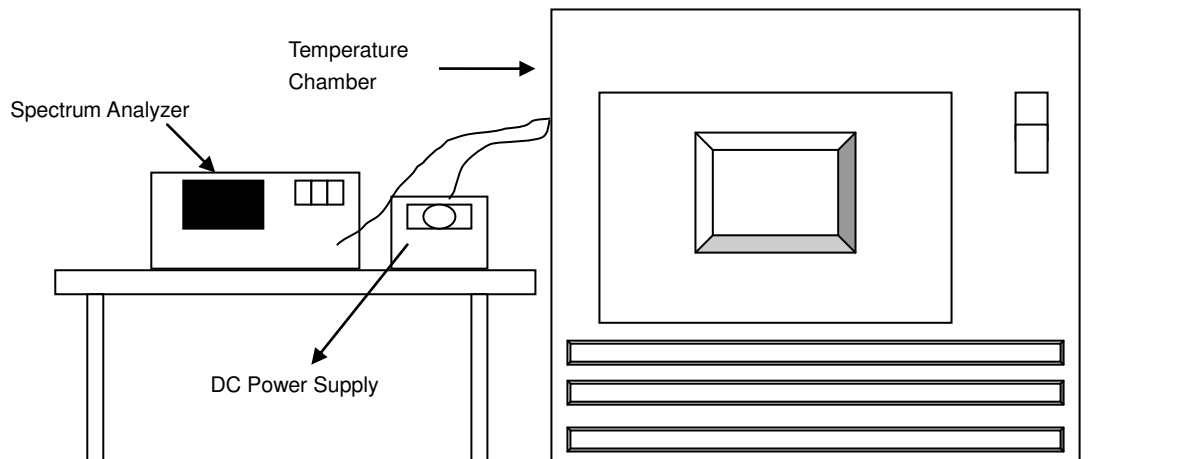

4.5.3 Test Instruments

Refer to section 4.1.3 to get information of above instrument.

4.5.4 Test Procedure

- To ensure emission at the band edge is maintained within the authorized band, those values shall be measured by radiation emissions at upper and lower frequency points, and finally compensated by frequency deviation as procedures below.
- The EUT was operated at the maximum output power, and connected to the spectrum analyzer, which is set to maximum hold function and peak detector. The peak value of the power envelope was measured and noted. The upper and lower frequency points were respectively measured relatively 10 dB lower than the measured peak value.
- The frequency deviation was calculated by adding the upper frequency point and the lower frequency point divided by two. Those detailed values of frequency deviation are provided in table below.

4.5.5 Deviation from Test Standard

No deviation.

4.5.6 EUT Operating Condition

Set the EUT transmit at un-modulation mode to test frequency stability.

4.5.7 Test Results

Frequency Stability Versus Temp.									
Operating Frequency: 5180 MHz									
Temp. (°C)	Power Supply (Vdc)	0 Minute		2 Minute		5 Minute		10 Minute	
		Measured Frequency (MHz)	Frequency Drift (ppm)	Measured Frequency (MHz)	Frequency Drift (ppm)	Measured Frequency (MHz)	Frequency Drift (ppm)	Measured Frequency (MHz)	Frequency Drift (ppm)
50	3.85	5180.0268	0.00052	5180.0265	0.00051	5180.0259	0.00050	5180.025	0.00048
40	3.85	5180.0049	0.00009	5180.0019	0.00004	5180.0054	0.00010	5180.0057	0.00011
30	3.85	5180.0064	0.00012	5180.0081	0.00016	5180.0037	0.00007	5180.0053	0.00010
20	3.85	5180.0038	0.00007	5180.0084	0.00016	5180.0051	0.00010	5180.0066	0.00013
10	3.85	5179.9847	-0.00030	5179.9857	-0.00028	5179.9877	-0.00024	5179.986	-0.00027
0	3.85	5180.0096	0.00019	5180.0127	0.00025	5180.009	0.00017	5180.0079	0.00015
-10	3.85	5180.017	0.00033	5180.0203	0.00039	5180.0159	0.00031	5180.0181	0.00035
-20	3.85	5179.9793	-0.00040	5179.9823	-0.00034	5179.9776	-0.00043	5179.9815	-0.00036
-30	3.85	5179.9786	-0.00041	5179.974	-0.00050	5179.974	-0.00050	5179.9775	-0.00043

Frequency Stability Versus Temp.									
Operating Frequency: 5320 MHz									
Temp. (°C)	Power Supply (Vdc)	0 Minute		2 Minute		5 Minute		10 Minute	
		Measured Frequency (MHz)	Frequency Drift (ppm)	Measured Frequency (MHz)	Frequency Drift (ppm)	Measured Frequency (MHz)	Frequency Drift (ppm)	Measured Frequency (MHz)	Frequency Drift (ppm)
20	4.2	5180.004	0.00008	5180.0093	0.00018	5180.0041	0.00008	5180.006	0.00012
	3.85	5180.0038	0.00007	5180.0084	0.00016	5180.0051	0.00010	5180.0066	0.00013
	3.3	5180.0031	0.00006	5180.0077	0.00015	5180.006	0.00012	5180.0074	0.00014

4.6 6 dB Bandwidth Measurement

4.6.1 Limits of 6 dB Bandwidth Measurement

The minimum of 6 dB Bandwidth Measurement is 0.5 MHz.

4.6.2 Test Setup

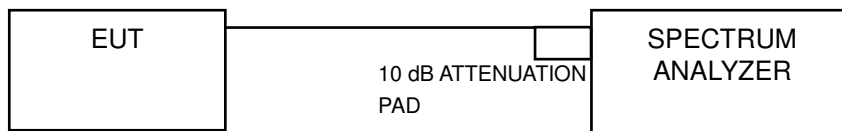

4.6.3 Test Instruments

Refer to section 4.1.3 to get information of above instrument.

4.6.4 Test Procedure

MEASUREMENT PROCEDURE REF

- Set resolution bandwidth (RBW) = 100 kHz
- Set the video bandwidth (VBW) $\geq 3 \times$ RBW, Detector = Peak.
- Trace mode = max hold.
- Sweep = auto couple.
- Measure the maximum width of the emission that is constrained by the frequencies associated with the two amplitude points (upper and lower) that are attenuated by 6 dB relative to the maximum level measured in the fundamental emission

4.6.5 Deviation from Test Standard

No deviation.

4.6.6 EUT Operating Condition

The software provided by client to enable the EUT under transmission condition continuously at lowest, middle and highest channel frequencies individually.

4.6.7 Test Results

802.11a

Channel	Frequency (MHz)	6 dB Bandwidth (MHz)	Minimum Limit (MHz)	Pass / Fail
149	5745	16.36	0.5	Pass
157	5785	16.37	0.5	Pass
165	5825	16.36	0.5	Pass

802.11n (HT20)

Channel	Frequency (MHz)	6 dB Bandwidth (MHz)	Minimum Limit (MHz)	Pass / Fail
149	5745	17.60	0.5	Pass
157	5785	17.55	0.5	Pass
165	5825	17.61	0.5	Pass

802.11n (HT40)

Channel	Frequency (MHz)	6 dB Bandwidth (MHz)	Minimum Limit (MHz)	Pass / Fail
151	5755	36.15	0.5	Pass
159	5795	35.88	0.5	Pass

802.11ac (VHT80)

Channel	Frequency (MHz)	6 dB Bandwidth (MHz)	Minimum Limit (MHz)	Pass / Fail
155	5775	75.83	0.5	Pass

Spectrum Plot of Worst Value

802.11a

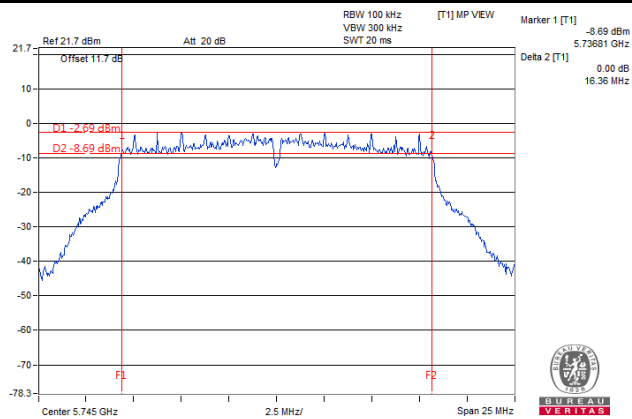

802.11n (HT20)

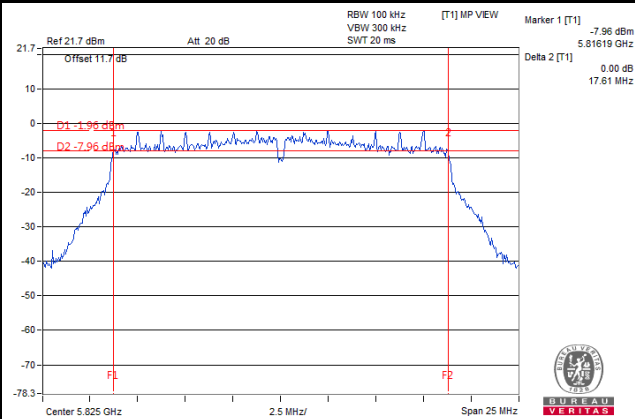

802.11n (HT40)

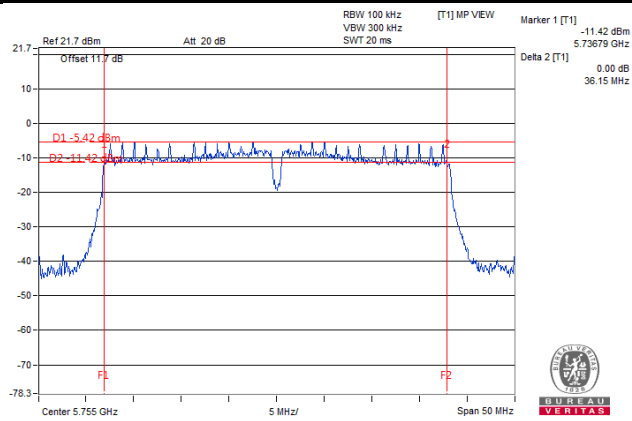

802.11ac (VHT80)

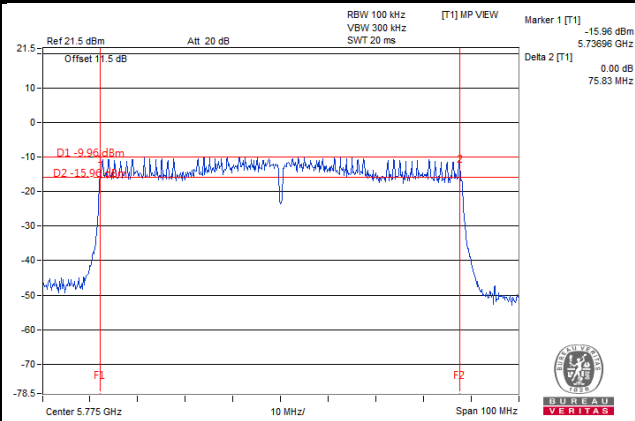

5 Pictures of Test Arrangements

Please refer to the attached file (Test Setup Photo).

Annex A- Radiated Out of Band Emisison (OOBE) Measurement (For U-NII-3 band)

802.11a

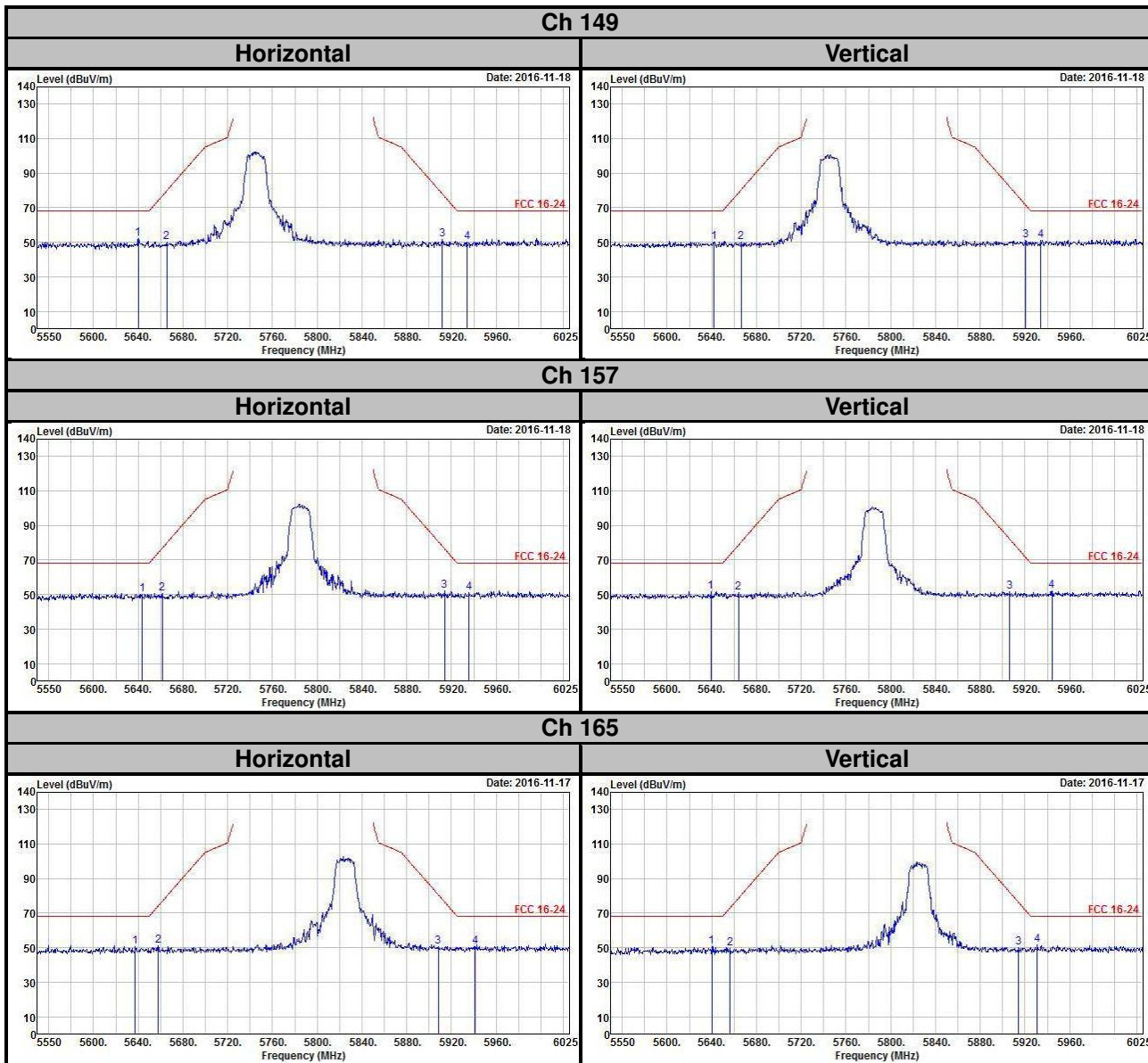

802.11n (HT20)

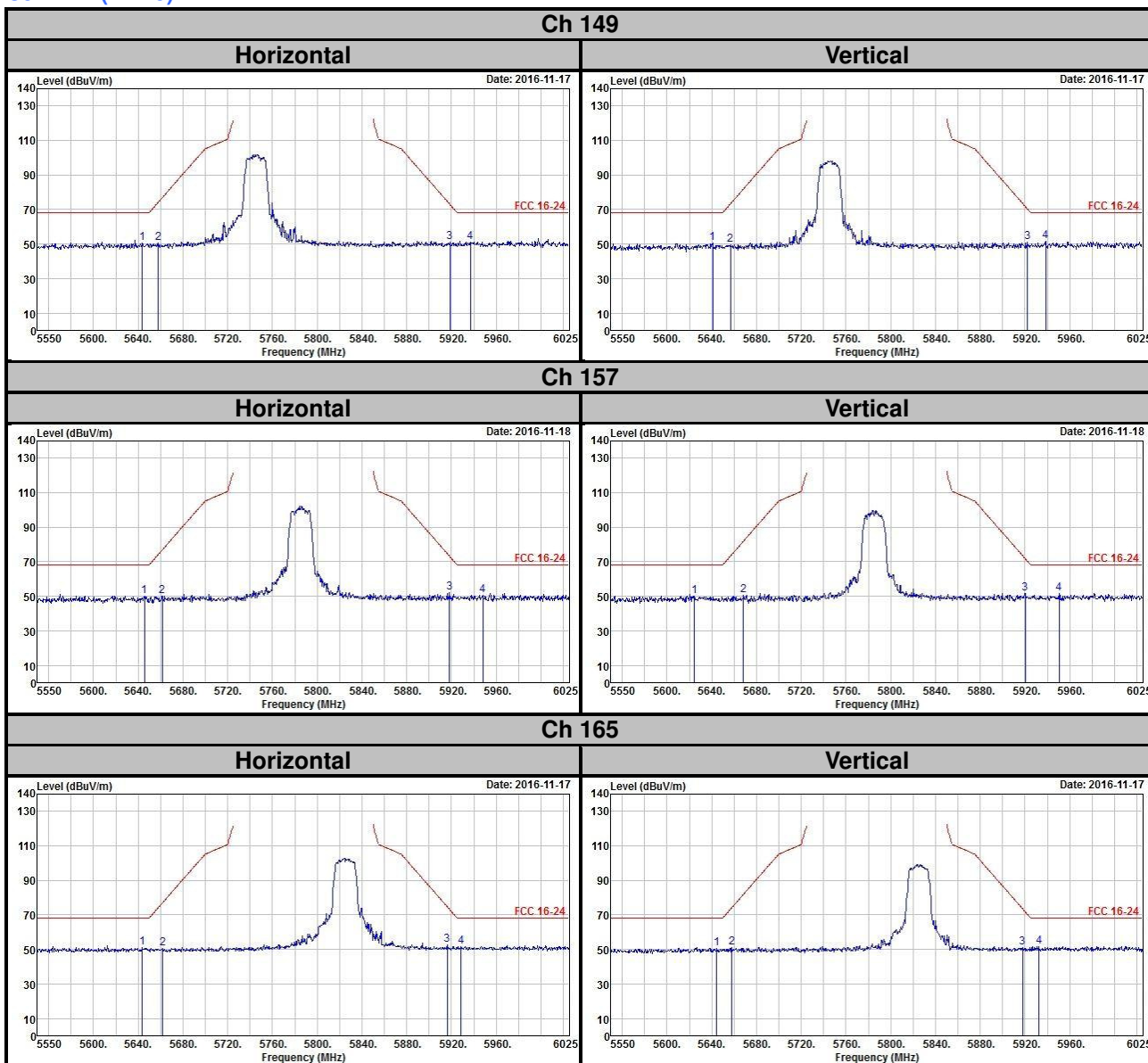

802.11n (HT40)

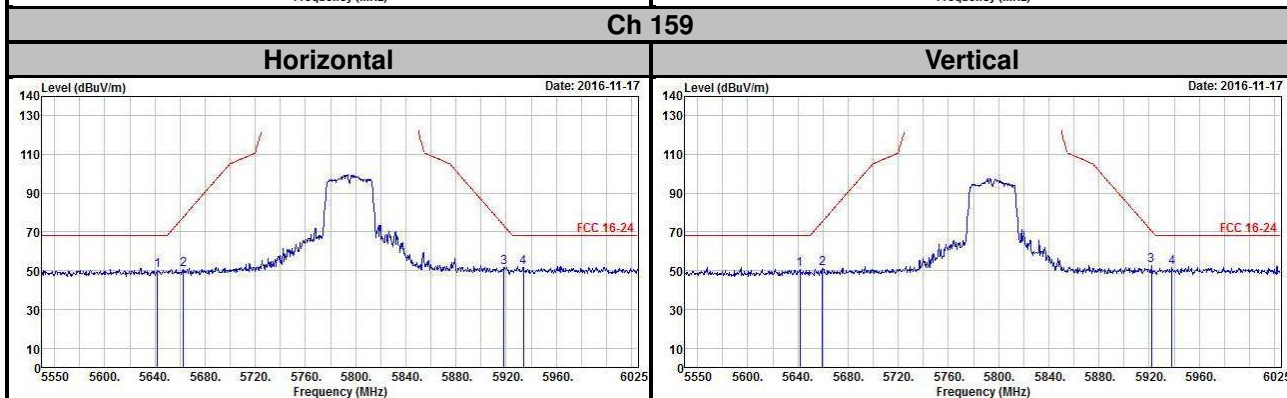
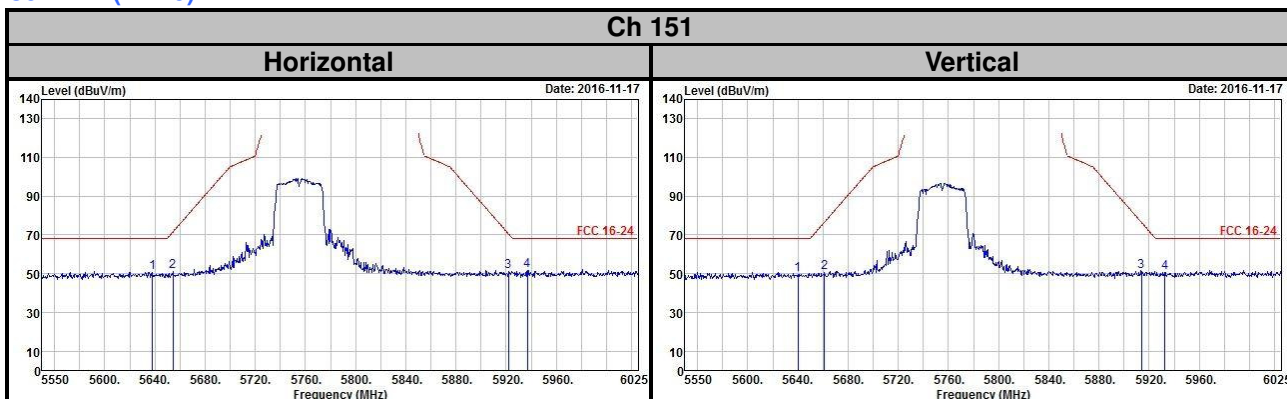

802.11ac (VHT80)

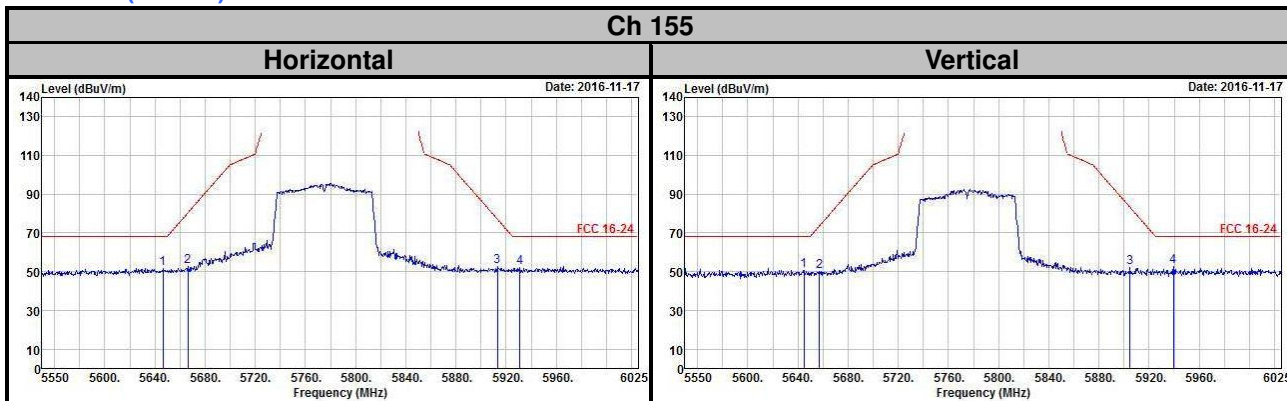

Appendix – Information on the Testing Laboratories

We, Bureau Veritas Consumer Products Services (H.K.) Ltd., Taoyuan Branch, were founded in 1988 to provide our best service in EMC, Radio, Telecom and Safety consultation. Our laboratories are accredited and approved according to ISO/IEC 17025.

If you have any comments, please feel free to contact us at the following:

Linko EMC/RF Lab

Tel: 886-2-26052180

Fax: 886-2-26051924

Hsin Chu EMC/RF/Telecom Lab

Tel: 886-3-6668565

Fax: 886-3-6668323

Hwa Ya EMC/RF/Safety

Tel: 886-3-3183232

Fax: 886-3-3270892

Email: service.adt@tw.bureauveritas.com

Web Site: www.bureauveritas-adt.com

The address and road map of all our labs can be found in our web site also.

--- END ---