



# FCC RADIO TEST REPORT

**FCC ID** : B32V400M2  
**Equipment** : Point of Sale Terminal  
**Brand Name** : Verifone  
**Model Name** : V400m-2  
V400m Plus 4G WW2  
**Applicant** : VeriFone, Inc.  
1400 West Stanford Ranch Road Suite 150  
Rocklin CA 95765 USA  
**Manufacturer** : VeriFone, Inc.  
**Standard** : FCC 47 CFR Part 2, 22(H), 24(E), 27(L)

The product was received on Jul. 25, 2023 and testing was performed from Aug. 08, 2023 to Aug. 25, 2023. We, Sporton International Inc. EMC & Wireless Communications Laboratory, would like to declare that the tested sample has been evaluated in accordance with the test procedures given in ANSI / TIA-603-E and has been in compliance with the applicable technical standards.

The test results in this report apply exclusively to the tested model / sample. Without written approval from Sporton International Inc. EMC & Wireless Communications Laboratory, the test report shall not be reproduced except in full.

*Louis Wu*

---

**Approved by: Louis Wu**  
**Sporton International Inc. EMC & Wireless Communications Laboratory**  
No. 52, Huaya 1st Rd., Guishan Dist., Taoyuan City 333, Taiwan (R.O.C.)



## Table of Contents

History of this test report.....	3
Summary of Test Result.....	4
<b>1 General Description .....</b>	<b>5</b>
1.1 Product Feature of Equipment Under Test .....	5
1.2 Modification of EUT .....	5
1.3 Testing Location .....	5
1.4 Applicable Standards .....	6
<b>2 Test Configuration of Equipment Under Test .....</b>	<b>7</b>
2.1 Test Mode.....	7
2.2 Connection Diagram of Test System .....	8
2.3 Support Unit used in test configuration .....	8
2.4 Measurement Results Explanation Example .....	8
2.5 Frequency List of Low/Middle/High Channels.....	9
<b>3 Conducted Test Result .....</b>	<b>10</b>
3.1 Measuring Instruments.....	10
3.2 Conducted Output Power and ERP/EIRP .....	11
3.3 Peak-to-Average Ratio .....	12
3.4 99% Occupied Bandwidth and 26dB Bandwidth Measurement.....	13
3.5 Conducted Band Edge .....	14
3.6 Conducted Spurious Emission .....	15
3.7 Frequency Stability.....	16
<b>4 Radiated Test Items .....</b>	<b>17</b>
4.1 Measuring Instruments.....	17
4.2 Test Setup .....	17
4.3 Test Result of Radiated Test.....	18
4.4 Field Strength of Spurious Radiation Measurement .....	19
<b>5 List of Measuring Equipment.....</b>	<b>20</b>
<b>6 Measurement Uncertainty .....</b>	<b>21</b>
<b>Appendix A. Test Results of Conducted Test</b>	
<b>Appendix B. Test Results of Radiated Test</b>	
<b>Appendix C. Test Setup Photographs</b>	





### Summary of Test Result

Report Clause	Ref Std. Clause	Test Items	Result (PASS/FAIL)	Remark
3.2	§2.1046	Conducted Output Power	Pass	-
	§22.913 (a)(5)	Effective Radiated Power (GSM850) (WCDMA Band V)		
	§24.232 (c)	Equivalent Isotropic Radiated Power (GSM1900) (WCDMA Band II)		
	§27.50 (d)(4)	Equivalent Isotropic Radiated Power (WCDMA Band IV)		
3.3	§24.232 (d)	Peak-to-Average Ratio	Pass	-
3.4	§2.1049 §22.917 (b) §24.238 (b) §27.53 (g)	Occupied Bandwidth (GSM850) (WCDMA Band V) (GSM1900) (WCDMA Band II) (WCDMA Band IV)	Pass	-
3.5	§2.1051 §22.917 (a) §24.238 (a) §27.53 (g)	Band Edge Measurement (GSM850) (WCDMA Band V) (GSM1900) (WCDMA Band II) (WCDMA Band IV)	Pass	-
3.6	§2.1051 §22.917 (a) §24.238 (a) §27.53 (g)	Conducted Emission (GSM850) (WCDMA Band V) (GSM1900) (WCDMA Band II) (WCDMA Band IV)	Pass	-
3.7	§2.1055 §22.355 §24.235 §27.54	Frequency Stability Temperature & Voltage	Pass	-
4.4	§2.1053 §22.917 (a) §24.238 (a) §27.53 (h)	Field Strength of Spurious Radiation (GSM850) (WCDMA Band V) (GSM1900) (WCDMA Band II) (WCDMA Band IV)	Pass	20.11 dB under the limit at 2474.00 MHz

**Conformity Assessment Condition:**

- The test results (PASS/FAIL) with all measurement uncertainty excluded are presented against the regulation limits or in accordance with the requirements stipulated by the applicant/manufacturer who shall bear all the risks of non-compliance that may potentially occur if measurement uncertainty is taken into account.
- The measurement uncertainty please refer to each test result in the section "Measurement Uncertainty".

**Disclaimer:**

- The product specifications of the EUT presented in the test report that may affect the test assessments are declared by the manufacturer who shall take full responsibility for the authenticity.
- The purpose of different model name is for marketing segmentation.

**Reviewed by: Yun Huang**

**Report Producer: Michelle Chen**



# 1 General Description

## 1.1 Product Feature of Equipment Under Test

Product Feature	
<b>General Specs</b> GSM/WCDMA/LTE, Bluetooth, Wi-Fi 2.4GHz 802.11b/g/n, Wi-Fi 5GHz 802.11a/n/ac and NFC.	
<b>Antenna Type</b> WWAN: Fixed Internal Antenna WLAN: PCB Antenna Bluetooth: PCB Antenna NFC: Loop Antenna	
<b>Antenna Gain</b>	Cellular Band: 0.43 dBi PCS Band: 2.03 dBi AWS Band: 2.21 dBi

**Remark:** The EUT's information above is declared by manufacturer. Please refer to Disclaimer in report summary.

## 1.2 Modification of EUT

No modifications made to the EUT during the testing.

## 1.3 Testing Location

<b>Test Site</b>	Sporton International Inc. EMC & Wireless Communications Laboratory	
<b>Test Site Location</b>	No.52, Huaya 1st Rd., Guishan Dist., Taoyuan City 333, Taiwan (R.O.C.) TEL: +886-3-327-3456 FAX: +886-3-328-4978	
<b>Test Site No.</b>	<b>Sporton Site No.</b>	
	TH03-HY	03CH07-HY
<b>Test Engineer</b>	Eric Wu	Jesse Wang, Stan Hsieh and Ken Wu
<b>Temperature (°C)</b>	20.0~25.0	20.2~28.1
<b>Relative Humidity (%)</b>	50.0~53.5	51.2~68.6

**Note:** The test site complies with ANSI C63.4 2014 requirement.

FCC Designation No.: TW1190



## **1.4 Applicable Standards**

According to the specifications declared by the manufacturer, the EUT must comply with the requirements of the following standards:

- ♦ ANSI C63.26-2015
- ♦ ANSI / TIA-603-E
- ♦ FCC 47 CFR Part 2, 22(H), 24(E), 27(L)
- ♦ FCC KDB 971168 D01 Power Meas. License Digital Systems v03r01
- ♦ FCC KDB 412172 D01 Determining ERP and EIRP v01r01
- ♦ FCC KDB 414788 D01 Radiated Test Site v01r01

**Remark:**

1. All the test items were validated and recorded in accordance with the standards without any modification during the testing.
2. This EUT has also been tested and complied with the requirements of FCC Part 15, Subpart B, recorded in a separate test report.
3. The TAF code is not including all the FCC KDB listed without accreditation.



## 2 Test Configuration of Equipment Under Test

### 2.1 Test Mode

Antenna port conducted and radiated test items were performed according to KDB 971168 D01 Power Meas. License Digital Systems v03r01 with maximum output power.

For radiated measurement, the measured emission level of the EUT was maximized by rotating the EUT on a turntable, adjusting the orientation of the EUT and EUT antenna in three orthogonal axis (X: flat, Y: portrait, Z: landscape), and adjusting the measurement antenna orientation, following C63.26 exploratory test procedures and only the worst case emissions were reported in this report.

Radiated emissions were investigated as following frequency range:

1. 30 MHz to 9000 MHz for GSM850 and WCDMA Band V
2. 30 MHz to 18000 MHz for WCDMA Band IV
3. 30 MHz to 19100 MHz for GSM1900 and WCDMA Band II

All modes, data rates and positions were investigated.

Test modes are chosen to be reported as the worst case configuration below:

Test Modes		
Band	Radiated TCs	Conducted TCs
GSM850	<ul style="list-style-type: none"> <li>■ GPRS Class 8 Link</li> <li>■ EDGE Class 8 Link</li> </ul>	<ul style="list-style-type: none"> <li>■ GPRS Class 8 Link</li> <li>■ EDGE Class 8 Link</li> </ul>
GSM1900	<ul style="list-style-type: none"> <li>■ GPRS Class 8 Link</li> <li>■ EDGE Class 8 Link</li> </ul>	<ul style="list-style-type: none"> <li>■ GPRS Class 8 Link</li> <li>■ EDGE Class 8 Link</li> </ul>
WCDMA Band V	<ul style="list-style-type: none"> <li>■ RMC 12.2Kbps Link</li> </ul>	<ul style="list-style-type: none"> <li>■ RMC 12.2Kbps Link</li> </ul>
WCDMA Band II	<ul style="list-style-type: none"> <li>■ RMC 12.2Kbps Link</li> </ul>	<ul style="list-style-type: none"> <li>■ RMC 12.2Kbps Link</li> </ul>
WCDMA Band IV	<ul style="list-style-type: none"> <li>■ RMC 12.2Kbps Link</li> </ul>	<ul style="list-style-type: none"> <li>■ RMC 12.2Kbps Link</li> </ul>

**Remark:** All the radiated test cases were performed with AC Adapter.

## 2.2 Connection Diagram of Test System

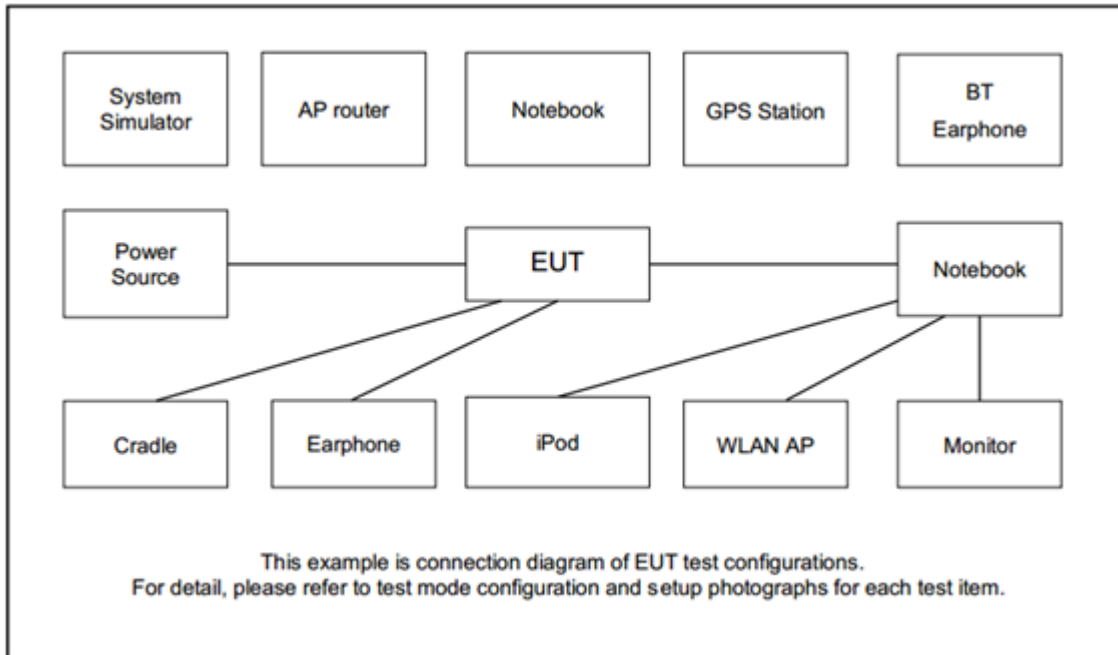

## 2.3 Support Unit used in test configuration

Item	Equipment	Brand Name	Model No.	FCC ID	Data Cable	Power Cord
1.	System Simulator	R&S	CMU 200	N/A	N/A	Unshielded, 1.8 m

## 2.4 Measurement Results Explanation Example

### For all conducted test items:

The offset level is set in the spectrum analyzer to compensate the RF cable loss and attenuator factor between RF conducted output port and spectrum analyzer. With the offset compensation, the spectrum analyzer reading level will be exactly the RF output level.

The spectrum analyzer offset is derived from RF cable loss and attenuator factor.

Offset = RF cable loss + attenuator factor.

The following shows an offset computation example with RF cable loss 4.2 dB and a 10 dB attenuator.

Example:

$$\begin{aligned} \text{Offset}(dB) &= \text{RF cable loss}(dB) + \text{attenuator factor}(dB). \\ &= 4.2 + 10 = 14.2 \text{ (dB)} \end{aligned}$$





## 2.5 Frequency List of Low/Middle/High Channels

Frequency List				
Band	Channel/Frequency(MHz)	Lowest	Middle	Highest
GSM850	Channel	128	189	251
	Frequency	824.2	836.4	848.8
WCDMA Band V	Channel	4132	4182	4233
	Frequency	826.4	836.4	846.6
GSM1900	Channel	512	661	810
	Frequency	1850.2	1880.0	1909.8
WCDMA Band II	Channel	9262	9400	9538
	Frequency	1852.4	1880.0	1907.6
WCDMA Band IV	Channel	1312	1413	1513
	Frequency	1712.4	1732.6	1752.6

### 3 Conducted Test Result

#### 3.1 Measuring Instruments

Please refer to the measuring equipment list in this test report.

##### 3.1.1 Test Setup

##### 3.1.2 Conducted Output Power

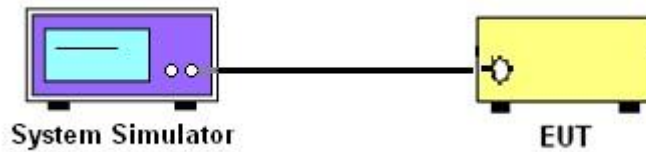

##### 3.1.3 Peak-to-Average Ratio, Occupied Bandwidth, Conducted Band-Edge and Conducted Spurious Emission

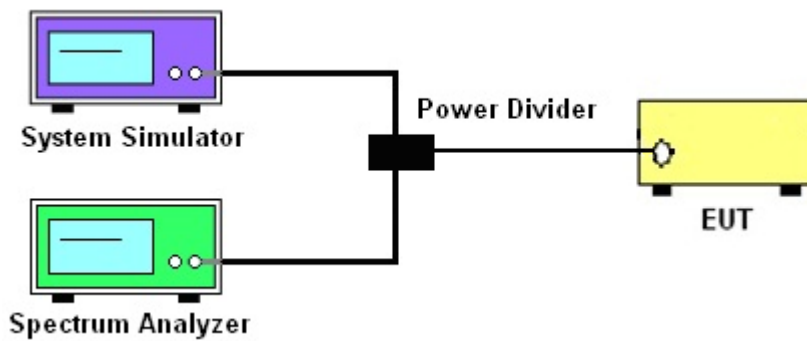

##### 3.1.4 Frequency Stability

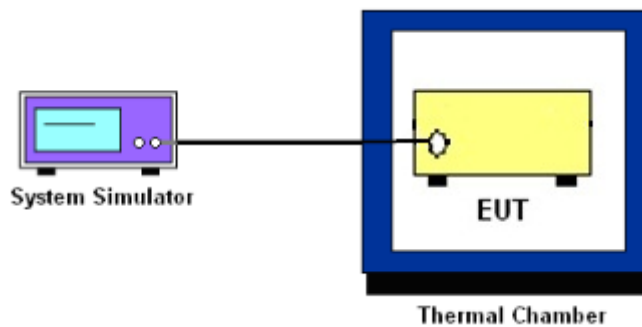

##### 3.1.5 Test Result of Conducted Test

Please refer to Appendix A.



## 3.2 Conducted Output Power and ERP/EIRP

### 3.2.1 Description of the Conducted Output Power and ERP/EIRP

A system simulator was used to establish communication with the EUT. Its parameters were set to enforce EUT transmitting at the maximum power. The measured power in the radio frequency on the transmitter output terminals shall be reported.

The ERP of mobile transmitters must not exceed 7 Watts for GSM850 and WCDMA Band V

The EIRP of mobile transmitters must not exceed 2 Watts for GSM1900 and WCDMA Band II

The EIRP of mobile transmitters must not exceed 1 Watts for WCDMA Band IV

According to KDB 412172 D01 Power Approach,

$EIRP = P_T + G_T - L_C$ ,  $ERP = EIRP - 2.15$ , where

$P_T$  = transmitter output power in dBm

$G_T$  = gain of the transmitting antenna in dBi

$L_C$  = signal attenuation in the connecting cable between the transmitter and antenna in dB

### 3.2.2 Test Procedures

1. The transmitter output port is connected to the system simulator.
2. Set EUT at maximum power through system simulator.
3. Select the lowest, middle, and the highest channels for each band and different modulation.
4. Measure the maximum burst average power for GSM and maximum average power for other modulation signal.



### **3.3 Peak-to-Average Ratio**

#### **3.3.1 Description of the PAR Measurement**

The peak-to-average ratio (PAR) of the transmission may not exceed 13 dB.

#### **3.3.2 Test Procedures**

The testing follows ANSI C63.26-2015 Section 5.2.6

1. The EUT is connected to spectrum analyzer and system simulator via a power divider.
2. Set EUT to transmit at maximum output power.
3. When the duty cycle is less than 98%, then signal gating will be implemented on the spectrum analyzer by triggering from the system simulator.
4. Set the CCDF (Complementary Cumulative Distribution Function) option of the spectrum analyzer.
5. Record the maximum PAPR level associated with a probability of 0.1%.



### 3.4 99% Occupied Bandwidth and 26dB Bandwidth Measurement

#### 3.4.1 Description of 99% Occupied Bandwidth and 26dB Bandwidth Measurement

The occupied bandwidth is the width of a frequency band such that, below the lower and above the upper frequency limits, the mean powers emitted are each equal to a specified percentage 0.5% of the total mean transmitted power.

The 26 dB emission bandwidth is defined as the frequency range between two points, one above and one below the carrier frequency, at which the spectral density of the emission is attenuated 26 dB below the maximum in-band spectral density of the modulated signal. Spectral density (power per unit bandwidth) is to be measured with a detector of resolution bandwidth equal to approximately 1.0% of the emission bandwidth.

#### 3.4.2 Test Procedures

The testing follows ANSI C63.26-2015 Section 5.4.3 (26dB) and Section 5.4.4 (99OB)

1. The EUT is connected to spectrum analyzer and system simulator via a power divider.
2. The spectrum analyzer center frequency is set to the nominal EUT channel center frequency. The span range for the spectrum analyzer shall be between two and five times the anticipated OBW.
3. The nominal resolution bandwidth (RBW) shall be in the range of 1 to 5 % of the anticipated OBW, and the VBW shall be at least 3 times the RBW.
4. Set the detection mode to peak, and the trace mode to max hold.
5. Determine the reference value: Set the EUT to transmit a modulated signal. Allow the trace to stabilize. Set the spectrum analyzer marker to the highest level of the displayed trace.  
(This is the reference value)
6. Determine the “-26 dB down amplitude” as equal to (Reference Value – X).
7. Place two markers, one at the lowest and the other at the highest frequency of the envelope of the spectral display such that each marker is at or slightly below the “-X dB down amplitude” determined in step 6. If a marker is below this “-X dB down amplitude” value it shall be placed as close as possible to this value. The OBW is the positive frequency difference between the two markers.
8. Use the 99 % power bandwidth function of the spectrum analyzer and report the measured bandwidth.



## **3.5 Conducted Band Edge**

### **3.5.1 Description of Conducted Band Edge Measurement**

The power of any emission outside of the authorized operating frequency ranges must be lower than the transmitter power (P) by a factor of at least  $43 + 10 \log (P)$  dB.

### **3.5.2 Test Procedures**

The testing follows FCC KDB 971168 D01 v03r01 Section 6.1.

1. The EUT is connected to the spectrum analyzer and system simulator via a power divider.
2. The RF output of EUT is connected to the spectrum analyzer by an RF cable and attenuator. The path loss is compensated to the results for each measurement.
3. The band edges of low and high channels for the highest RF powers are measured.
4. The RF fundamental frequency shall be excluded against the limit line in the operating frequency band.
5. The limit line is derived from  $43 + 10\log(P)$  dB below the transmitter power P(Watts)



## **3.6 Conducted Spurious Emission**

### **3.6.1 Description of Conducted Spurious Emission Measurement**

The power of any emission outside of the authorized operating frequency ranges must be lower than the transmitter power (P) by a factor of at least  $43 + 10 \log (P)$  dB.

It is measured by means of a calibrated spectrum analyzer and scanned from 30 MHz up to a frequency including its 10<sup>th</sup> harmonic.

### **3.6.2 Test Procedures**

The testing follows FCC KDB 971168 D01 v03r01 Section 6.1.

1. The EUT is connected to the spectrum analyzer and system simulator via a power divider.
2. The RF output of EUT is connected to the spectrum analyzer by an RF cable and attenuator. The path loss is compensated to the results for each measurement.
3. The middle channel for the highest RF power within the transmitting frequency is measured.
4. The conducted spurious emission for the whole frequency range is taken.
5. The RF fundamental frequency shall be excluded against the limit line in the operating frequency band.
6. The limit line is derived from  $43 + 10\log(P)$  dB below the transmitter power P(Watts)



### 3.7 Frequency Stability

#### 3.7.1 Description of Frequency Stability Measurement

22.355

The frequency stability shall be measured by variation of ambient temperature and variation of primary supply voltage to ensure that the fundamental emission stays within the authorized frequency block. The frequency stability of the transmitter shall be maintained within  $\pm 0.00025\%$  ( $\pm 2.5\text{ppm}$ ) of the center frequency.

24.235 & 27.54

The frequency stability shall be sufficient to ensure that the fundamental emission stays within the authorized frequency block.

#### 3.7.2 Test Procedures for Temperature Variation

The testing follows FCC KDB 971168 D01 v03r01 Section 9.0.

1. The EUT is set up in the thermal chamber and connected with the system simulator.
2. With power OFF, the temperature is decreased to  $-30^{\circ}\text{C}$  and the EUT is stabilized before testing. Power is applied and the maximum change in frequency is recorded within one minute.
3. With power OFF, the temperature is raised in  $10^{\circ}\text{C}$  steps up to  $50^{\circ}\text{C}$ . The EUT is stabilized at each step for at least half an hour. Power is applied and the maximum frequency change is recorded within one minute.

#### 3.7.3 Test Procedures for Voltage Variation

The testing follows FCC KDB 971168 D01 v03r01 Section 9.0.

1. The EUT is placed in a temperature chamber at  $20\pm 5^{\circ}\text{C}$  and connected with the system simulator.
2. The power supply voltage to the EUT is varied from 85% to 115% of the nominal value measured at the input to the EUT.
3. The variation in frequency is measured for the worst case.



## 4 Radiated Test Items

### 4.1 Measuring Instruments

Please refer to the measuring equipment list in this test report.

### 4.2 Test Setup

For radiated test below 30MHz

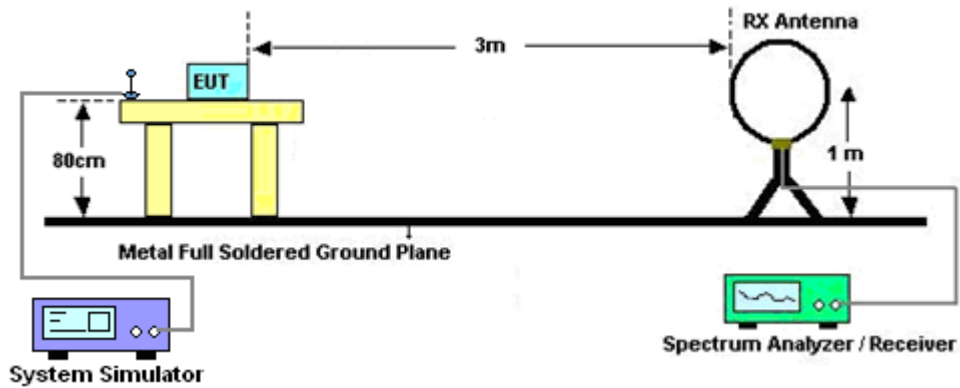

For radiated test from 30MHz to 1GHz

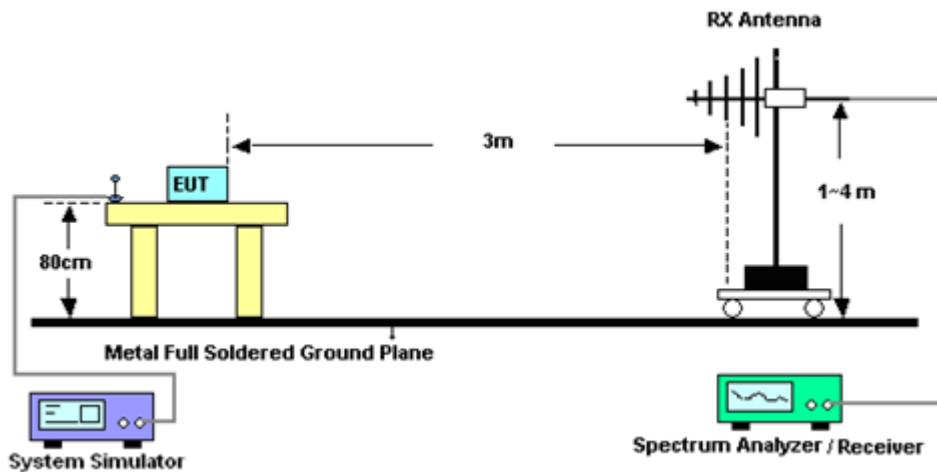

For radiated test from 1GHz to 18GHz

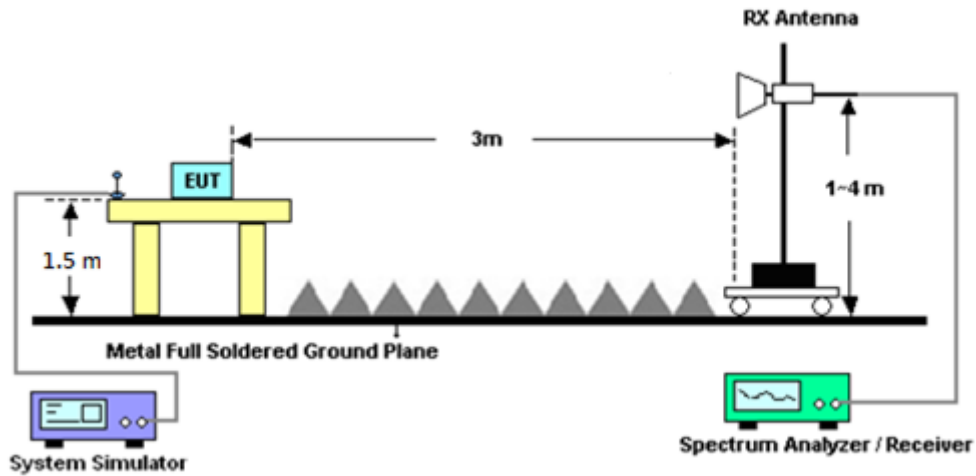

For radiated test above 18GHz

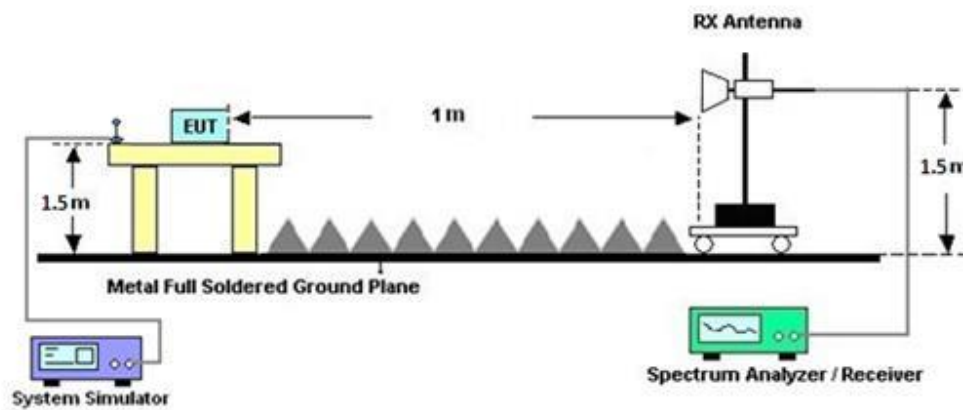

### 4.3 Test Result of Radiated Test

Please refer to Appendix B.

**Note:**

The low frequency, which starts from 9 kHz to 30 MHz, is pre-scanned and the result which is 20 dB lower than the limit line is not reported.

There is adequate comparison measurement of both open-field test site and alternative test site - semi-Anechoic chamber according to 414788 D01 Radiated Test Site v01r01, and the result came out very similar.



## 4.4 Field Strength of Spurious Radiation Measurement

### 4.4.1 Description of Field Strength of Spurious Radiated Measurement

The power of any emission outside of the authorized operating frequency ranges must be attenuated below the transmitter power (P) by a factor of at least  $43 + 10 \log (P)$  dB. The spectrum is scanned from 30 MHz up to a frequency including its 10th harmonic.

### 4.4.2 Test Procedures

The testing follows FCC KDB 971168 D01 v03r01 Section 7 and ANSI / TIA-603-E Section 2.2.12.

1. The EUT is placed on a rotatable wooden table 0.8 meters for frequency below 1 GHz and 1.5 meter for frequency above 1 GHz above the ground.
2. The EUT is set 3 meters away from the receiving antenna, which is mounted on the antenna tower.
3. The table is rotated 360 degrees to determine the position of the highest spurious emission.
4. The height of the receiving antenna is varied between one meter and four meters to search for the maximum spurious emission for both horizontal and vertical polarizations.
5. Make the measurement with the spectrum analyzer's RBW = 1 MHz, VBW = 3 MHz, taking record of maximum spurious emission.
6. A horn antenna is substituted in place of the EUT and is driven by a signal generator.
7. Tune the output power of signal generator to the same emission level with EUT maximum spurious emission.
8. Take the record of output power at antenna port.
9. Repeat step 7 to step 8 for another polarization.
10.  $EIRP \text{ (dBm)} = S.G. \text{ Power} - Tx \text{ Cable Loss} + Tx \text{ Antenna Gain}$
11.  $ERP \text{ (dBm)} = EIRP - 2.15$
12. The RF fundamental frequency shall be excluded against the limit line in the operating frequency band.
13. The limit line is derived from  $43 + 10\log(P)$  dB below the transmitter power P(Watts)



## 5 List of Measuring Equipment

Instrument	Brand Name	Model No.	Serial No.	Characteristics	Calibration Date	Test Date	Due Date	Remark
Bilog Antenna	TESEQ	CBL 6111D & 00800N1D01N-06	35419 & 03	30MHz~1GHz	Apr. 23, 2023	Aug. 08, 2023~ Aug. 12, 2023	Apr. 22, 2024	Radiation (03CH07-HY)
Double Ridge Horn Antenna	ESCO	3117	00075962	1GHz ~ 18GHz	Dec. 01, 2022	Aug. 08, 2023~ Aug. 12, 2023	Nov. 30, 2023	Radiation (03CH07-HY)
Preamplifier	MITEQ	AMF-7D-0010 1800-30-10P	1590075	1GHz~18GHz	Apr. 20, 2023	Aug. 08, 2023~ Aug. 12, 2023	Apr. 19, 2024	Radiation (03CH07-HY)
Preamplifier	COM-POWER	PA-103A	161241	10MHz~1GHz	Oct. 03, 2022	Aug. 08, 2023~ Aug. 12, 2023	Oct. 02, 2023	Radiation (03CH07-HY)
Preamplifier	Agilent	8449B	3008A02362	1GHz~26.5GHz	Mar. 24, 2023	Aug. 08, 2023~ Aug. 12, 2023	Mar. 23, 2024	Radiation (03CH07-HY)
Preamplifier	EMEC	EM18G40G	0600789	18-40GHz	Jul. 25, 2023	Aug. 08, 2023~ Aug. 12, 2023	Jul. 24, 2024	Radiation (03CH07-HY)
Spectrum Analyzer	Agilent	N9030A	MY52350276	3Hz~44GHz	Mar. 28, 2023	Aug. 08, 2023~ Aug. 12, 2023	Mar. 27, 2024	Radiation (03CH07-HY)
RF Cable	HUBER + SUHNER	SUCOFLEX 104	MY15682/4	30MHz to 18GHz	Feb. 22, 2023	Aug. 08, 2023~ Aug. 12, 2023	Feb. 21, 2024	Radiation (03CH07-HY)
RF Cable	HUBER + SUHNER	SUCOFLEX 104	MY24971/4	9kHz to 18GHz	Feb. 22, 2023	Aug. 08, 2023~ Aug. 12, 2023	Feb. 21, 2024	Radiation (03CH07-HY)
RF Cable	HUBER + SUHNER	SUCOFLEX 104	MY28655/4	9kHz to 18GHz	Feb. 22, 2023	Aug. 08, 2023~ Aug. 12, 2023	Feb. 21, 2024	Radiation (03CH07-HY)
RF Cable	HUBER + SUHNER	SUCOFLEX 102	MY2858/2	18GHz~40GHz	Feb. 22, 2023	Aug. 08, 2023~ Aug. 12, 2023	Feb. 21, 2024	Radiation (03CH07-HY)
RF Cable	HUBER + SUHNER	SUCOFLEX 102	801606/2	9KHz ~ 40GHz	Apr. 20, 2023	Aug. 08, 2023~ Aug. 12, 2023	Apr. 19, 2024	Radiation (03CH07-HY)
Controller	EMEC	EM1000	N/A	Control Ant Mast	N/A	Aug. 08, 2023~ Aug. 12, 2023	N/A	Radiation (03CH07-HY)
Controller	MF	MF-7802	N/A	Control Turn table	N/A	Aug. 08, 2023~ Aug. 12, 2023	N/A	Radiation (03CH07-HY)
Antenna Mast	EMEC	AM-BS-4500E	N/A	Boresight mast 1M~4M	N/A	Aug. 08, 2023~ Aug. 12, 2023	N/A	Radiation (03CH07-HY)
Turn Table	ChainTek	Chaintek 3000	N/A	0~360 Degree	N/A	Aug. 08, 2023~ Aug. 12, 2023	N/A	Radiation (03CH07-HY)
Software	Audix	E3	N/A	N/A	N/A	Aug. 08, 2023~ Aug. 12, 2023	N/A	Radiation (03CH07-HY)
USB Data Logger	TECPEL	TR-32	HE17XB2495	N/A	Mar. 14, 2023	Aug. 08, 2023~ Aug. 12, 2023	Mar. 13, 2024	Radiation (03CH07-HY)
Horn Antenna	ETS-Lindgren	3117	00143261	1GHz~18GHz	Feb. 24, 2023	Aug. 08, 2023~ Aug. 12, 2023	Feb. 23, 2024	Radiation (03CH07-HY)
SHF-EHF Horn Antenna	SCHWARZBECK	BBHA 9170	BBHA9170251	18GHz~40GHz	Nov. 24, 2022	Aug. 08, 2023~ Aug. 12, 2023	Nov. 23, 2023	Radiation (03CH07-HY)
Signal Generator	Rohde & Schwarz	SMF100A	101107	100kHz~40GHz	Jan. 11, 2023	Aug. 08, 2023~ Aug. 12, 2023	Jan. 10, 2024	Radiation (03CH07-HY)
Spectrum Analyzer	Rohde & Schwarz	FSP30	101329	9kHz~30GHz	Sep. 27, 2022	Aug. 23, 2023~ Aug. 25, 2023	Sep. 26, 2023	Conducted (TH03-HY)
Programmable Power Supply	GW Instek	PSS-2005	EL890001	1V~20V 0.5A~4A	Sep. 29, 2022	Aug. 23, 2023~ Aug. 25, 2023	Sep. 28, 2023	Conducted (TH03-HY)
Base Station (Measure)	Rohde & Schwarz	CMU200	117995	GSM / GPRS / WCDMA / CDMA	Aug. 06, 2023	Aug. 23, 2023~ Aug. 25, 2023	Aug. 05, 2024	Conducted (TH03-HY)
Temperature & Humidity Cabinet Chamber	ESPEC	LHU-113	1012005860	-20°C~85°C	Dec. 05, 2022	Aug. 23, 2023~ Aug. 25, 2023	Dec. 04, 2023	Conducted (TH03-HY)
Hygrometer	TECPEL	DTM-303A	TP201996	N/A	Nov. 17, 2022	Aug. 23, 2023~ Aug. 25, 2023	Nov. 16, 2023	Conducted (TH03-HY)



## 6 Measurement Uncertainty

### Uncertainty of Radiated Emission Measurement (30 MHz ~ 1000 MHz)

Measuring Uncertainty for a Level of Confidence of 95% ( $U = 2Uc(y)$ )	3.46 dB
---	---------

### Uncertainty of Radiated Emission Measurement (1 GHz ~ 18 GHz)

Measuring Uncertainty for a Level of Confidence of 95% ( $U = 2Uc(y)$ )	3.33 dB
---	---------

### Uncertainty of Radiated Emission Measurement (18 GHz ~ 40 GHz)

Measuring Uncertainty for a Level of Confidence of 95% ( $U = 2Uc(y)$ )	3.91 dB
---	---------



## Appendix A. Test Results of Conducted Test

### Conducted Output Power(Average power) & ERP / EIRP

GSM850 Maximum Average Power [dBm] (GT - LC = 0.43 dB)					
Channel	128	189	251	ERP (dBm)	ERP (W)
Frequency	824.2	836.4	848.8		
GSM	32.81	32.65	32.75	31.20	1.3183
GPRS class 8	32.92	32.70	32.89		
GPRS class 10	30.10	29.59	29.42		
GPRS class 11	27.94	27.03	27.21		
GPRS class 12	26.35	25.64	25.77		
EGPRS class 8	25.73	25.58	25.87	24.15	0.2600
EGPRS class 10	23.10	23.02	23.01		
EGPRS class 11	21.02	21.15	21.08		
EGPRS class 12	19.63	19.77	19.70		
Limit	ERP < 7W			Result	Pass

GSM1900 Maximum Average Power [dBm] (GT - LC = 2.03 dB)					
Channel	512	661	810	EIRP (dBm)	EIRP (W)
Frequency	1850.2	1880	1909.8		
GSM	30.97	30.97	30.62	33.00	1.9953
GPRS class 8	30.73	30.97	30.60		
GPRS class 10	27.94	27.98	27.96		
GPRS class 11	26.37	26.50	26.19		
GPRS class 12	25.00	24.98	24.75		
EGPRS class 8	26.15	26.25	25.78	28.28	0.6730
EGPRS class 10	23.40	23.34	22.82		
EGPRS class 11	20.99	20.70	20.31		
EGPRS class 12	19.99	19.60	19.08		
Limit	EIRP < 2W			Result	Pass



WCDMA Band V Maximum Average Power [dBm] (GT - LC = 0.43 dB)							
Channel	4132	4182	4233	ERP (dBm)	ERP (W)		
Frequency	826.4	836.4	846.6				
RMC 12.2K	23.45	23.42	<b>23.49</b>	21.77	0.1503		
HSDPA Subtest-1	22.68	22.63	22.66				
HSDPA Subtest-2	22.77	22.77	22.81				
HSDPA Subtest-3	22.28	22.27	22.30				
HSDPA Subtest-4	22.29	22.28	22.32				
HSUPA Subtest-1	21.99	22.05	22.48				
HSUPA Subtest-2	21.49	21.41	21.10				
HSUPA Subtest-3	21.16	21.09	21.20				
HSUPA Subtest-4	21.34	21.38	21.37				
HSUPA Subtest-5	22.50	22.50	22.70				
Limit	ERP < 7W					Result	Pass

WCDMA Band II Maximum Average Power [dBm] (GT - LC = 2.03 dB)							
Channel	9262	9400	9538	EIRP (dBm)	EIRP (W)		
Frequency	1852.4	1880	1907.6				
RMC 12.2K	22.36	<b>22.45</b>	21.96	24.48	0.2805		
HSDPA Subtest-1	21.54	21.50	21.01				
HSDPA Subtest-2	21.43	21.51	21.04				
HSDPA Subtest-3	21.03	21.09	20.51				
HSDPA Subtest-4	21.02	21.08	20.63				
HSUPA Subtest-1	21.19	21.31	21.03				
HSUPA Subtest-2	20.49	20.44	19.99				
HSUPA Subtest-3	20.28	20.38	20.10				
HSUPA Subtest-4	20.49	20.49	20.19				
HSUPA Subtest-5	21.40	21.50	21.10				
Limit	EIRP < 2W					Result	Pass

WCDMA Band IV Maximum Average Power [dBm] (GT - LC = 2.21 dB)							
Channel	1312	1413	1513	EIRP (dBm)	EIRP (W)		
Frequency	1712.4	1732.6	1752.6				
RMC 12.2K	23.01	23.40	<b>23.48</b>	25.69	0.3707		
HSDPA Subtest-1	22.11	22.28	22.44				
HSDPA Subtest-2	22.10	22.25	22.46				
HSDPA Subtest-3	21.59	21.76	21.94				
HSDPA Subtest-4	21.58	21.76	21.93				
HSUPA Subtest-1	22.12	21.58	21.53				
HSUPA Subtest-2	21.39	21.42	21.25				
HSUPA Subtest-3	20.70	20.90	20.93				
HSUPA Subtest-4	20.39	20.63	21.00				
HSUPA Subtest-5	21.57	21.52	21.59				
Limit	EIRP < 1W					Result	Pass



## A2. GSM

### Peak-to-Average Ratio

Mode	GSM850	Limit: 13dB
Mod.	GPRS class 8	Result
Lowest CH	0.68	PASS
Middle CH	0.72	
Highest CH	0.68	

Mode	GSM1900	Limit: 13dB
Mod.	GPRS class 8	Result
Lowest CH	0.44	PASS
Middle CH	0.44	
Highest CH	0.44	



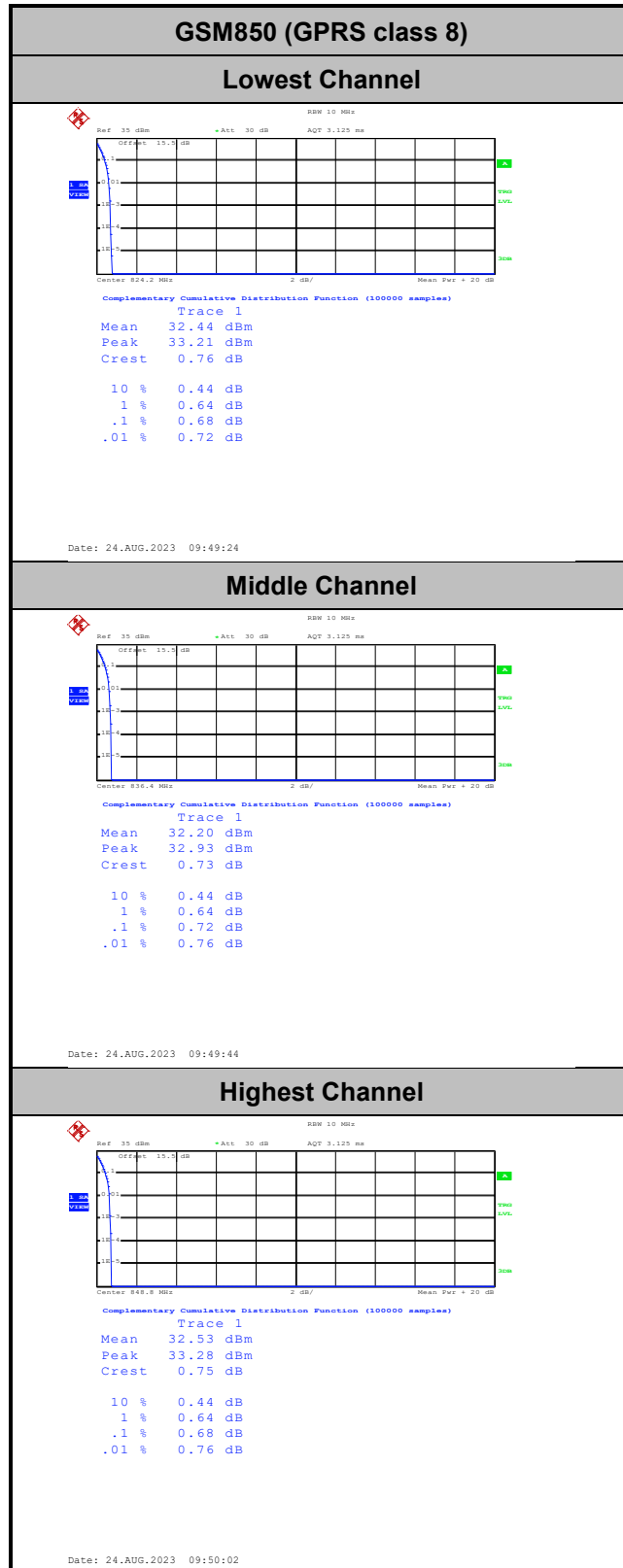



GSM1900 (GPRS class 8)

Lowest Channel

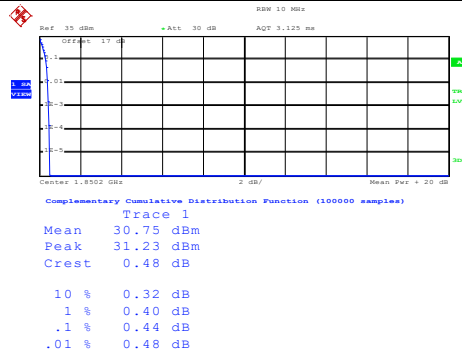

Date: 24.AUG.2023 10:34:09

Middle Channel

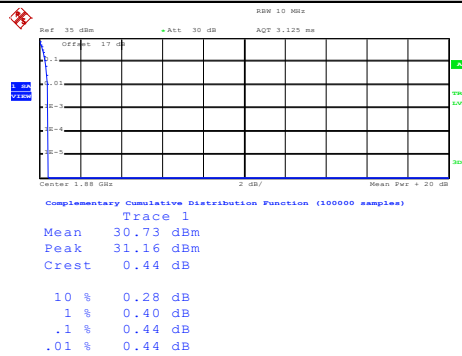

Date: 24.AUG.2023 10:34:28

Highest Channel

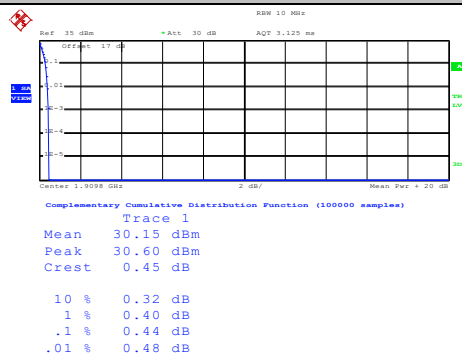

Date: 24.AUG.2023 10:34:48



**26dB Bandwidth**

Mode	GSM850 : 26dB BW(MHz)
Mod.	GPRS class 8
Lowest CH	0.314
Middle CH	0.310
Highest CH	0.304

Mode	GSM1900 : 26dB BW(MHz)
Mod.	GPRS class 8
Lowest CH	0.311
Middle CH	0.316
Highest CH	0.310

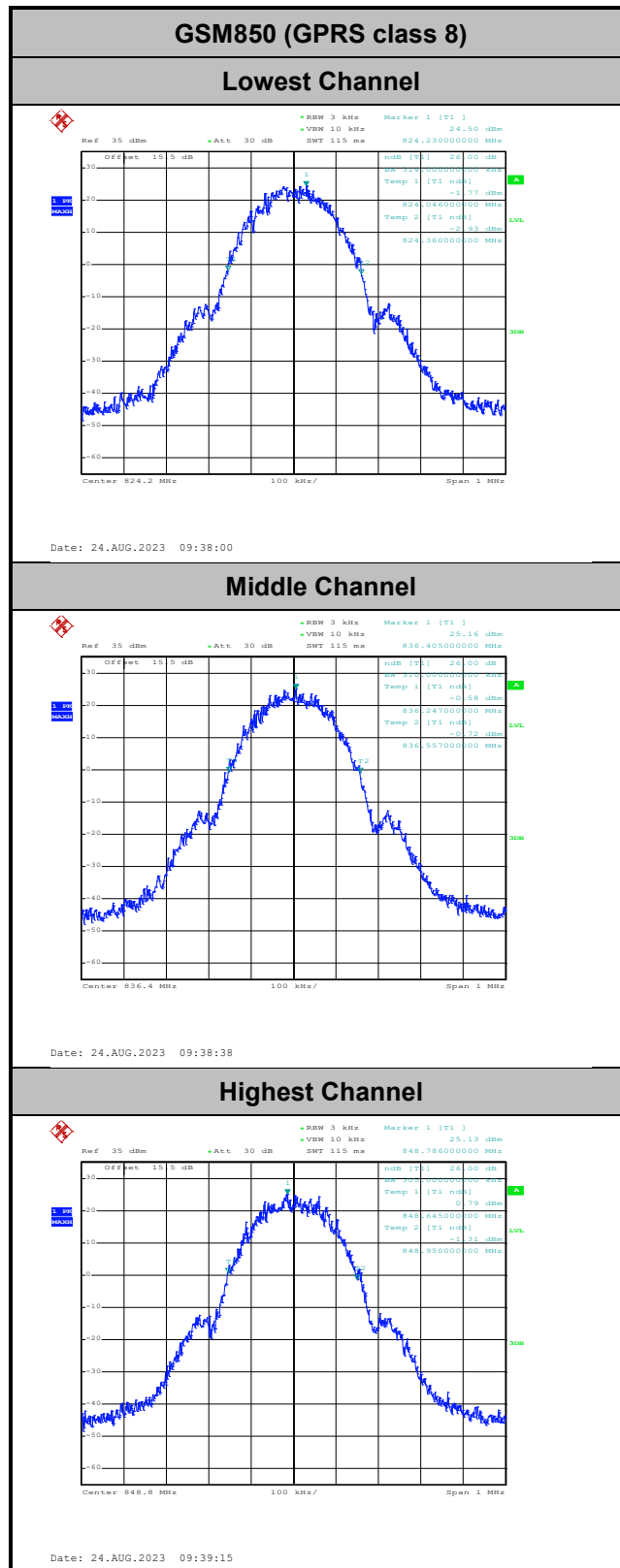



### GSM1900 (GPRS class 8)

#### Lowest Channel

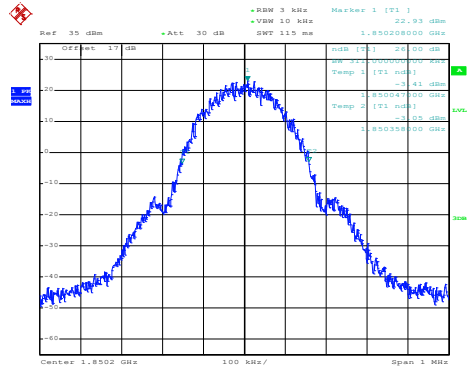

Date: 24.AUG.2023 10:20:02

#### Middle Channel

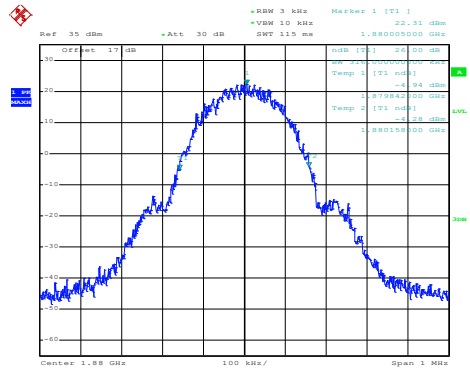

Date: 24.AUG.2023 10:20:40

#### Highest Channel

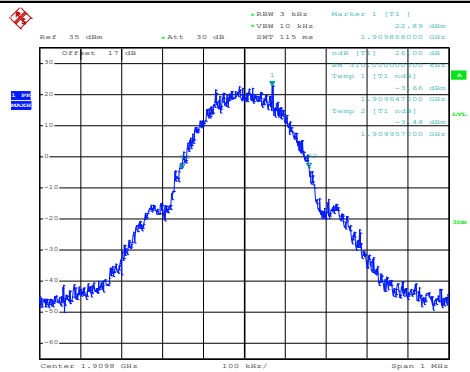

Date: 24.AUG.2023 10:21:26



### Occupied Bandwidth

Mode	GSM850 : 99%OBW(MHz)
Mod.	GPRS class 8
Lowest CH	0.245
Middle CH	0.241
Highest CH	0.249

Mode	GSM1900 : 99%OBW(MHz)
Mod.	GPRS class 8
Lowest CH	0.244
Middle CH	0.245
Highest CH	0.243

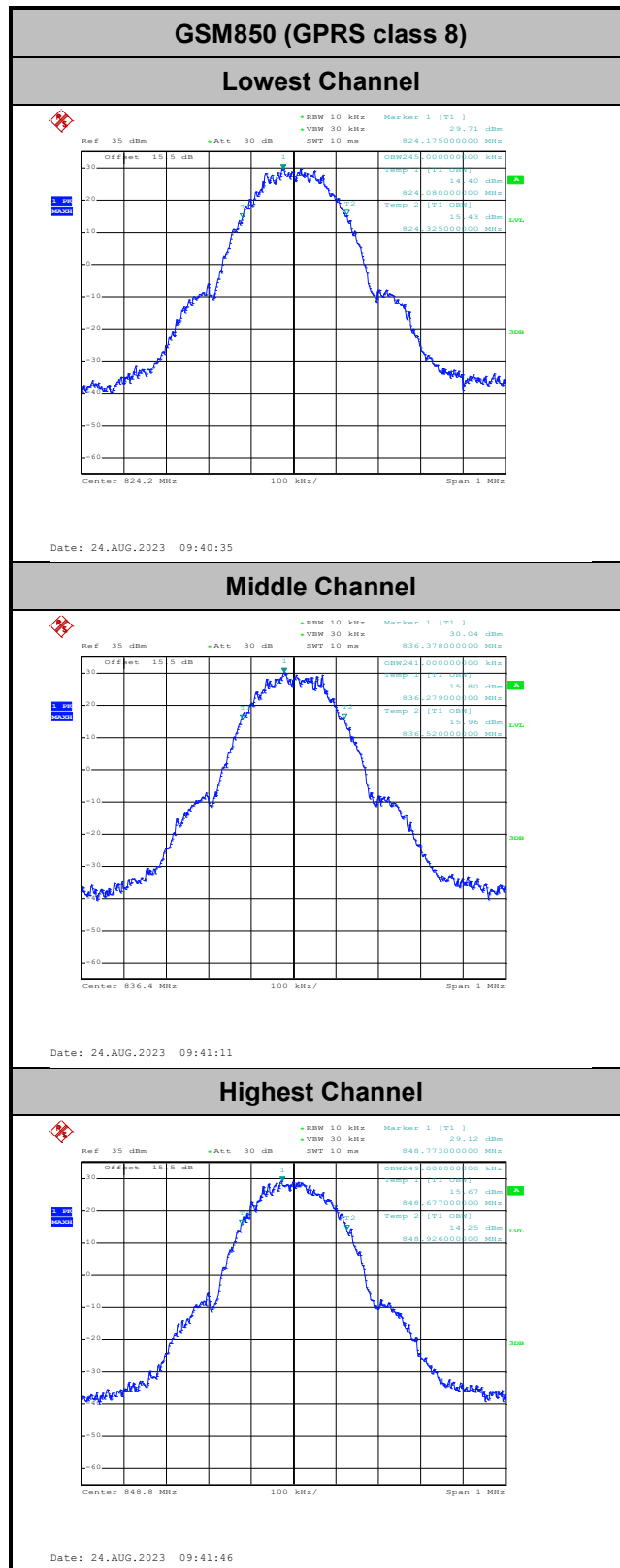



### GSM1900 (GPRS class 8)

#### Lowest Channel

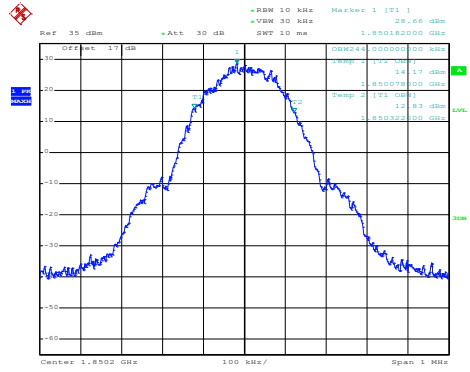

#### Middle Channel

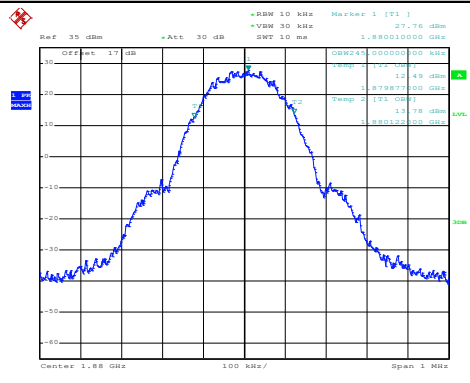

#### Highest Channel

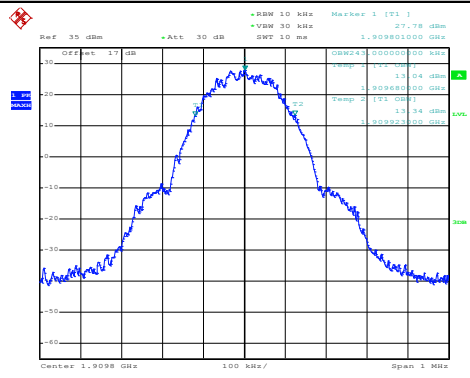





# Conducted Band Edge

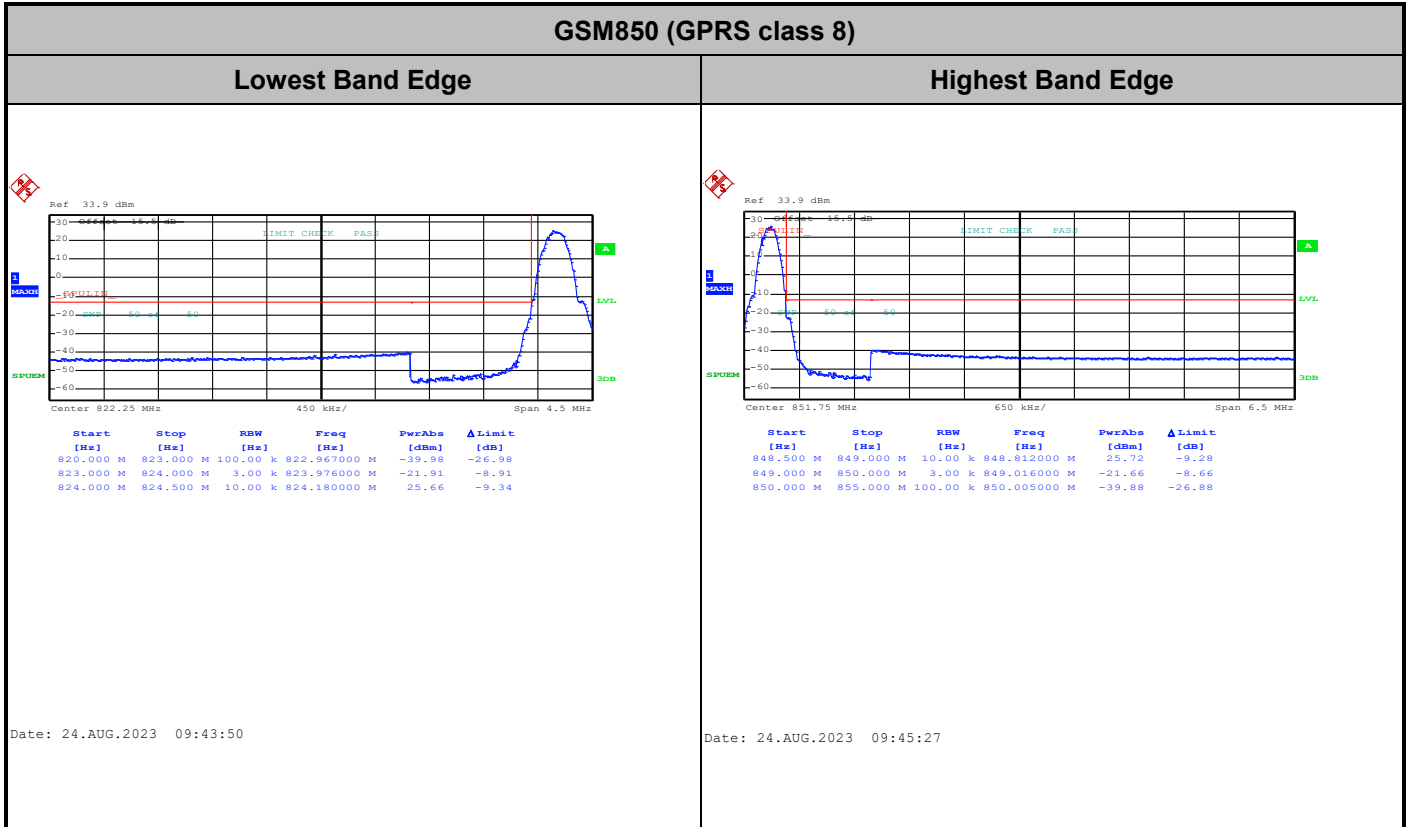



GSM1900 (GPRS class 8)

Lowest Band Edge

Highest Band Edge

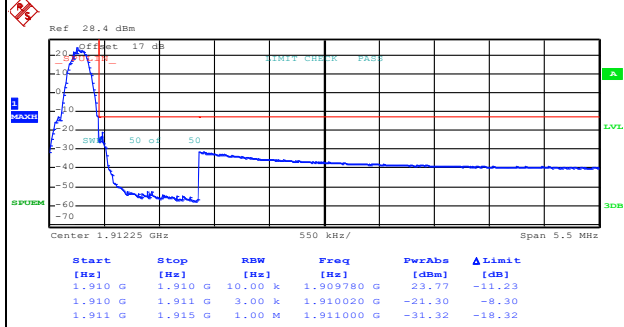
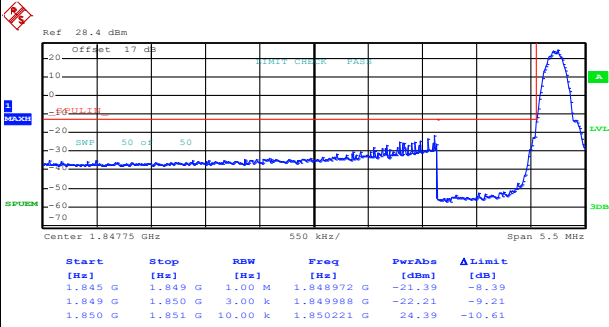

Date: 24.AUG.2023 10:27:51

Date: 24.AUG.2023 10:29:30



# Conducted Spurious Emission

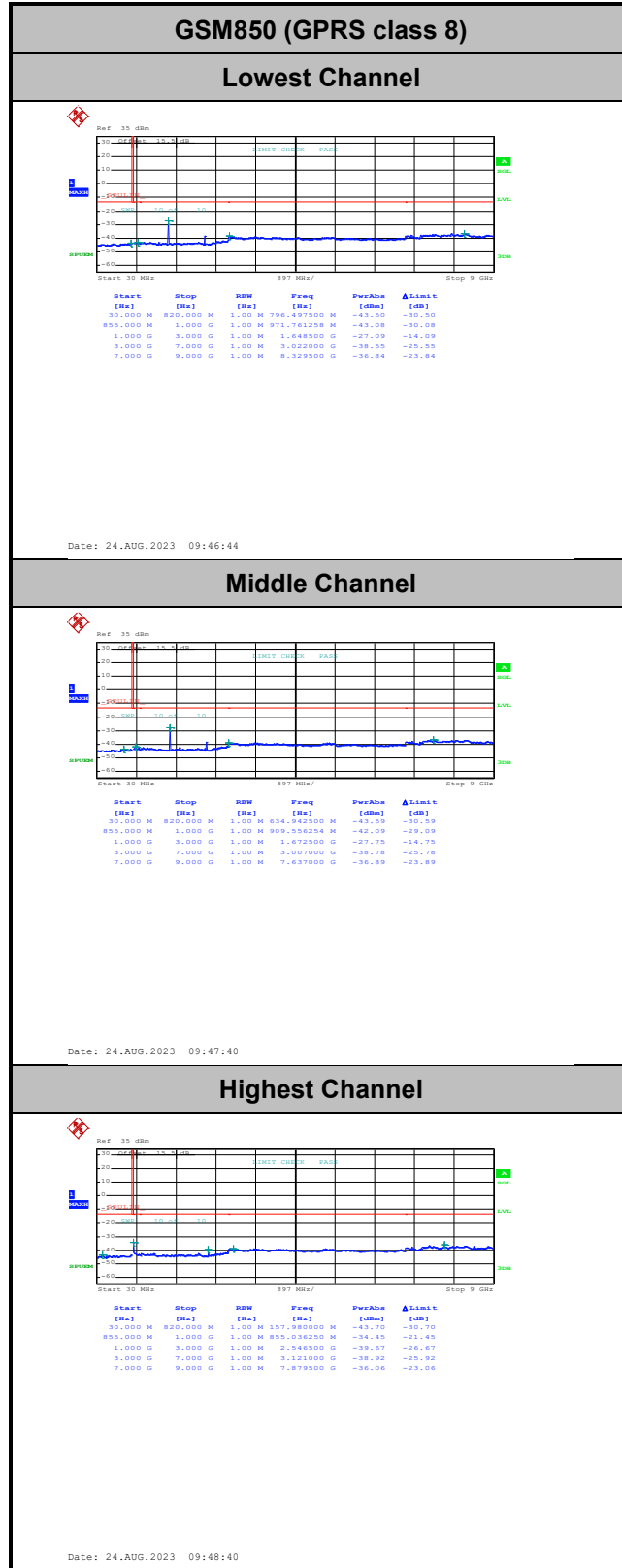



GSM1900 (GPRS class 8)

Lowest Channel

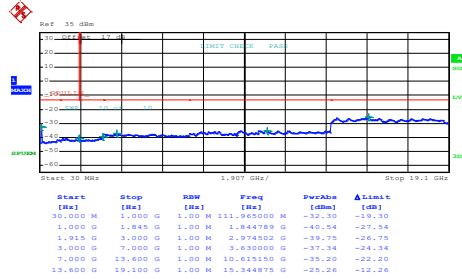

Date: 24.AUG.2023 10:31:00

Middle Channel

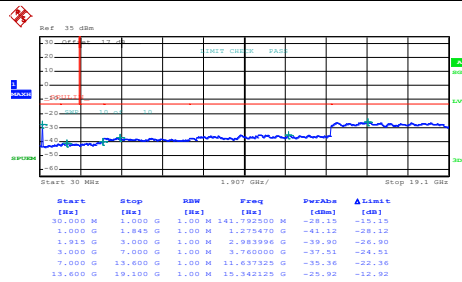

Date: 24.AUG.2023 10:32:04

Highest Channel

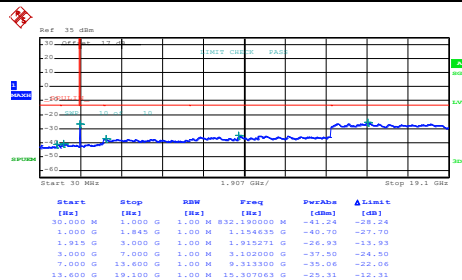

Date: 24.AUG.2023 10:33:01



### Frequency Stability

Test Conditions	Middle Channel	GSM850 (GPRS class 8)	Limit
			2.5ppm
Temperature (°C)	Voltage (Volt)	Deviation (ppm)	Result
50	Normal Voltage	0.0036	PASS
40	Normal Voltage	0.0060	
30	Normal Voltage	0.0012	
20(Ref.)	Normal Voltage	0.0000	
10	Normal Voltage	0.0060	
0	Normal Voltage	0.0012	
-10	Normal Voltage	0.0072	
20	Maximum Voltage	0.0036	
20	Normal Voltage	0.0012	
20	Battery End Point	0.0024	

Test Conditions	Middle Channel	GSM1900 (GPRS class 8)	Limit
			Note 2.
Temperature (°C)	Voltage (Volt)	Deviation (ppm)	Result
50	Normal Voltage	0.0011	PASS
40	Normal Voltage	0.0016	
30	Normal Voltage	0.0016	
20(Ref.)	Normal Voltage	0.0000	
10	Normal Voltage	0.0048	
0	Normal Voltage	0.0069	
-10	Normal Voltage	0.0064	
20	Maximum Voltage	0.0000	
20	Normal Voltage	0.0005	
20	Battery End Point	0.0011	

**Note:**

1. Normal Voltage = 3.8V. ; Battery End Point (BEP) = 3.3 V. ; Maximum Voltage =4.2 V
2. The frequency fundamental emissions stay within the authorized frequency block.



### A3. WCDMA

#### Peak-to-Average Ratio

Mode	WCDMA Band V	WCDMA Band II	WCDMA Band IV	Limit: 13dB
Mod.	RMC 12.2Kbps	RMC 12.2Kbps	RMC 12.2Kbps	Result
Lowest CH	3.88	3.36	3.56	<b>PASS</b>
Middle CH	3.72	3.48	3.32	
Highest CH	4.00	3.72	3.64	

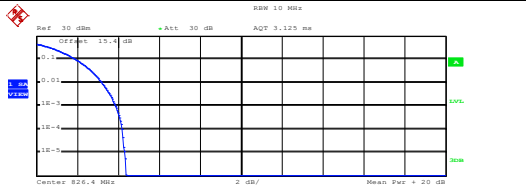
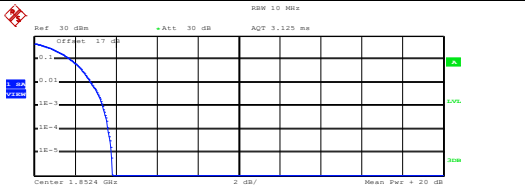
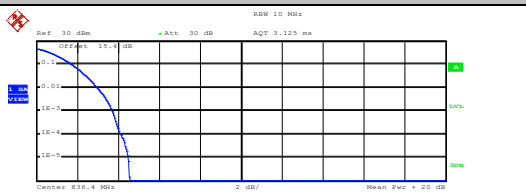
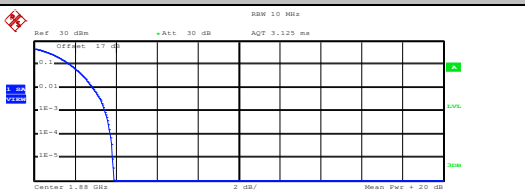
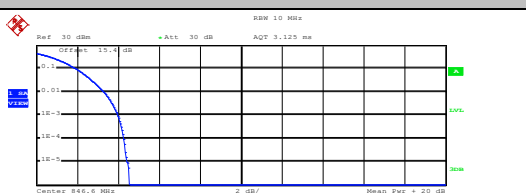
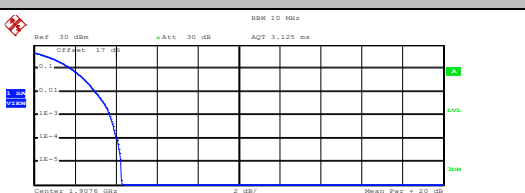

WCDMA Band V (RMC 12.2Kbps)	WCDMA Band II (RMC 12.2Kbps)
<p align="center"><b>Lowest Channel</b></p>  <p>Center 826.4 MHz      2 dB/      Mean Pwr + 20 dB</p> <p>Complementary Cumulative Distribution Function (100000 samples)</p> <p>Trace 1</p> <p>Mean 23.04 dBm Peak 27.43 dBm Crest 4.39 dB</p> <p>10 % 1.96 dB 1 % 3.20 dB .1 % 3.88 dB .01 % 4.20 dB</p> <p>Date: 23.AUG.2023 16:42:57</p>	<p align="center"><b>Lowest Channel</b></p>  <p>Center 1.8524 GHz      2 dB/      Mean Pwr + 20 dB</p> <p>Complementary Cumulative Distribution Function (100000 samples)</p> <p>Trace 1</p> <p>Mean 23.05 dBm Peak 26.87 dBm Crest 3.81 dB</p> <p>10 % 1.80 dB 1 % 2.80 dB .1 % 3.36 dB .01 % 3.64 dB</p> <p>Date: 23.AUG.2023 15:09:07</p>
<p align="center"><b>Middle Channel</b></p>  <p>Center 826.4 MHz      2 dB/      Mean Pwr + 20 dB</p> <p>Complementary Cumulative Distribution Function (100000 samples)</p> <p>Trace 1</p> <p>Mean 23.08 dBm Peak 27.64 dBm Crest 4.56 dB</p> <p>10 % 1.76 dB 1 % 2.96 dB .1 % 3.72 dB .01 % 4.12 dB</p> <p>Date: 23.AUG.2023 16:43:15</p>	<p align="center"><b>Middle Channel</b></p>  <p>Center 1.85 GHz      2 dB/      Mean Pwr + 20 dB</p> <p>Complementary Cumulative Distribution Function (100000 samples)</p> <p>Trace 1</p> <p>Mean 23.04 dBm Peak 26.94 dBm Crest 3.90 dB</p> <p>10 % 1.76 dB 1 % 2.88 dB .1 % 3.48 dB .01 % 3.72 dB</p> <p>Date: 23.AUG.2023 15:09:29</p>
<p align="center"><b>Highest Channel</b></p>  <p>Center 846.6 MHz      2 dB/      Mean Pwr + 20 dB</p> <p>Complementary Cumulative Distribution Function (100000 samples)</p> <p>Trace 1</p> <p>Mean 23.16 dBm Peak 27.71 dBm Crest 4.55 dB</p> <p>10 % 1.96 dB 1 % 3.28 dB .1 % 4.00 dB .01 % 4.28 dB</p> <p>Date: 23.AUG.2023 16:43:34</p>	<p align="center"><b>Highest Channel</b></p>  <p>Center 1.9076 GHz      2 dB/      Mean Pwr + 20 dB</p> <p>Complementary Cumulative Distribution Function (100000 samples)</p> <p>Trace 1</p> <p>Mean 22.45 dBm Peak 26.73 dBm Crest 4.28 dB</p> <p>10 % 1.80 dB 1 % 3.00 dB .1 % 3.72 dB .01 % 4.04 dB</p> <p>Date: 23.AUG.2023 15:09:49</p>

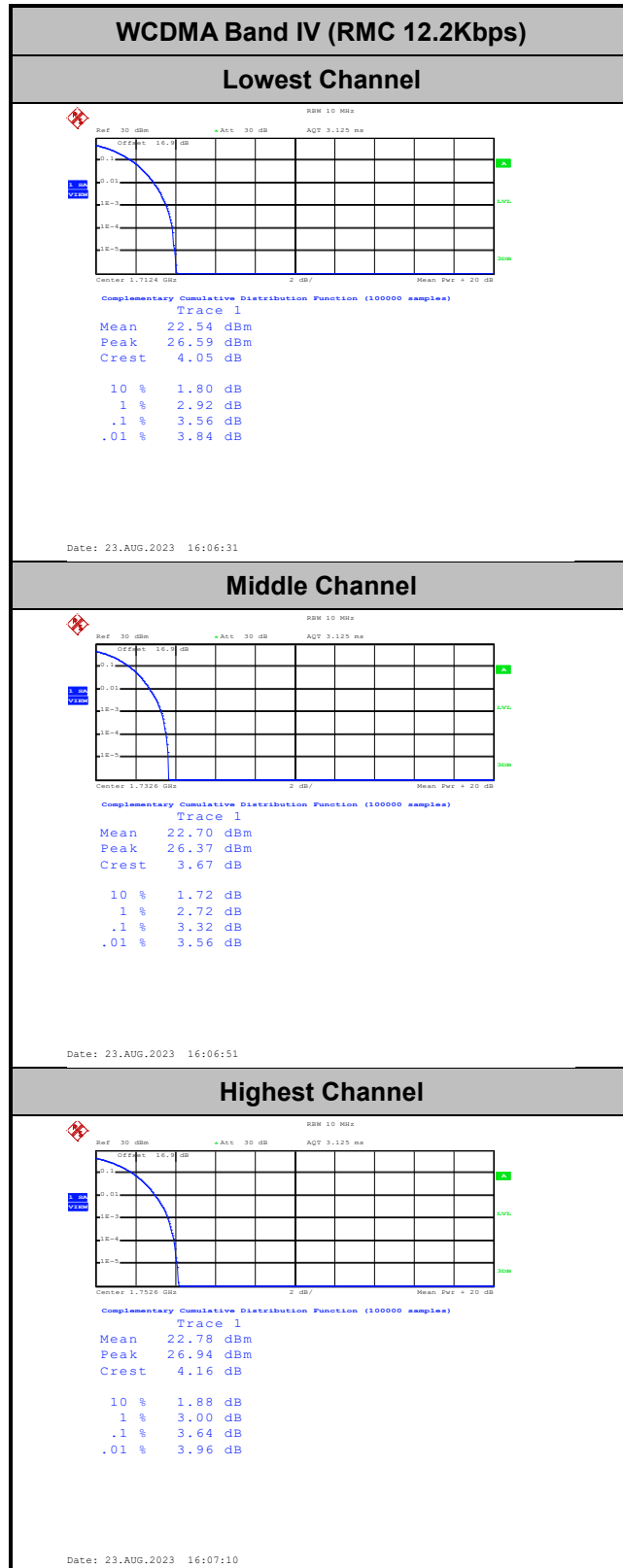





**26dB Bandwidth**

Mode	WCDMA Band V 26dB BW(MHz)	WCDMA Band II 26dB BW(MHz)	WCDMA Band IV 26dB BW(MHz)
Mod.	RMC 12.2Kbps	RMC 12.2Kbps	RMC 12.2Kbps
Lowest CH	4.68	4.73	4.70
Middle CH	4.70	4.71	4.71
Highest CH	4.69	4.69	4.72

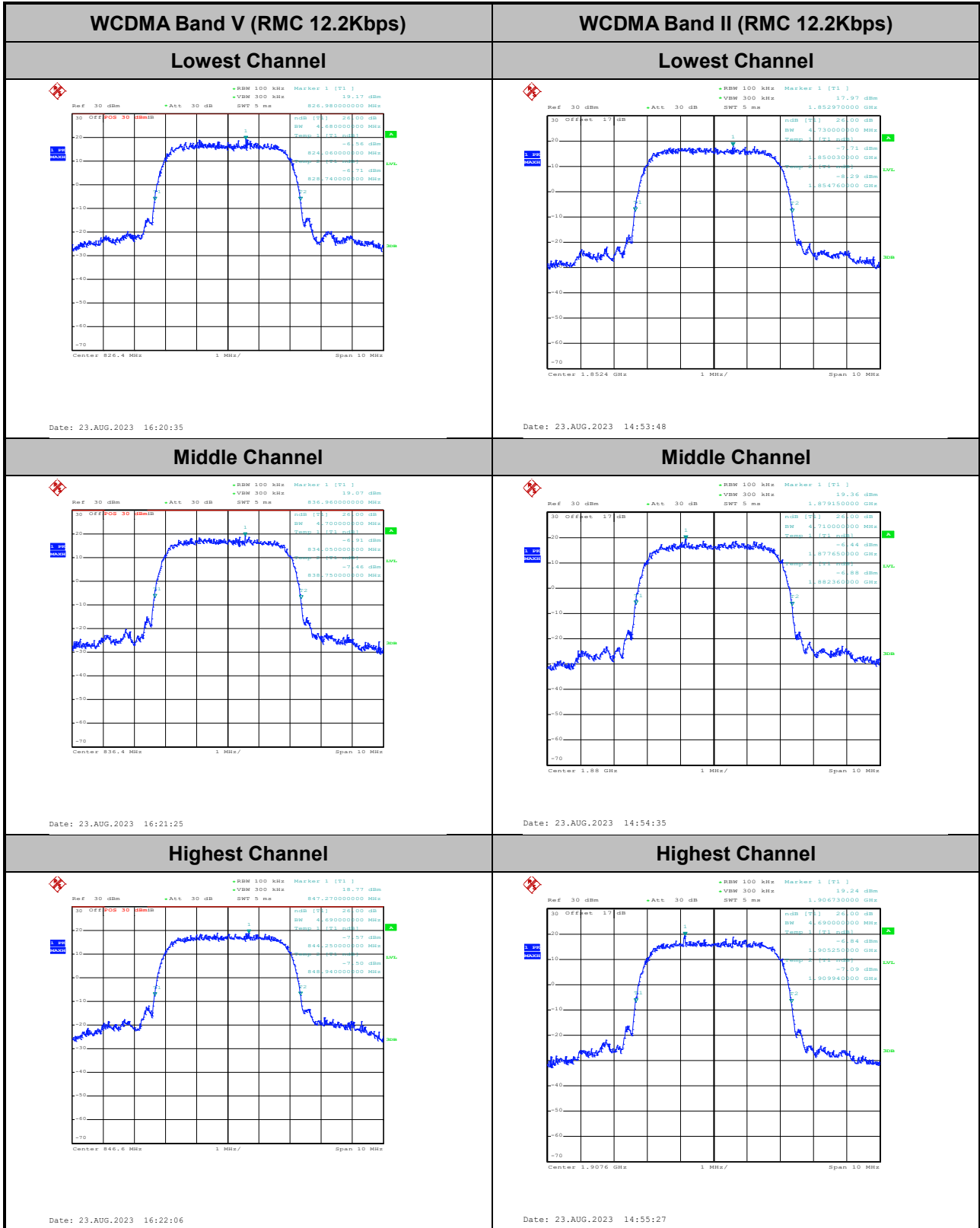



### WCDMA Band IV (RMC 12.2Kbps)

#### Lowest Channel

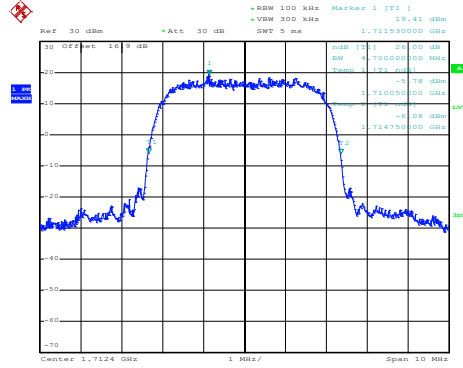

Date: 23.AUG.2023 15:51:27

#### Middle Channel

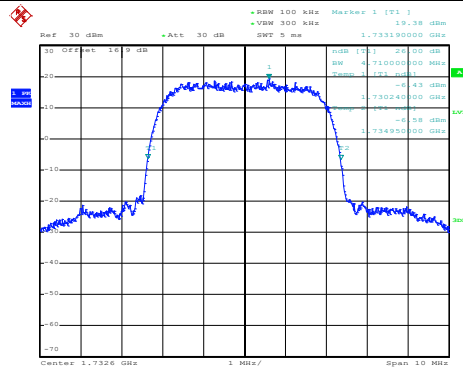

Date: 23.AUG.2023 15:52:20

#### Highest Channel

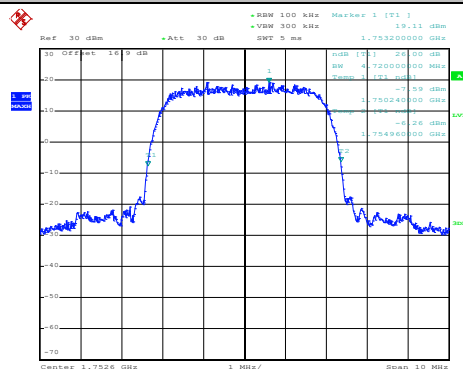

Date: 23.AUG.2023 15:53:00



### Occupied Bandwidth

Mode	WCDMA Band V 99%OBW(MHz)	WCDMA Band II 99%OBW(MHz)	WCDMA Band IV 99%OBW(MHz)
Mod.	RMC 12.2Kbps	RMC 12.2Kbps	RMC 12.2Kbps
Lowest CH	4.13	4.14	4.13
Middle CH	4.13	4.13	4.13
Highest CH	4.11	4.11	4.13

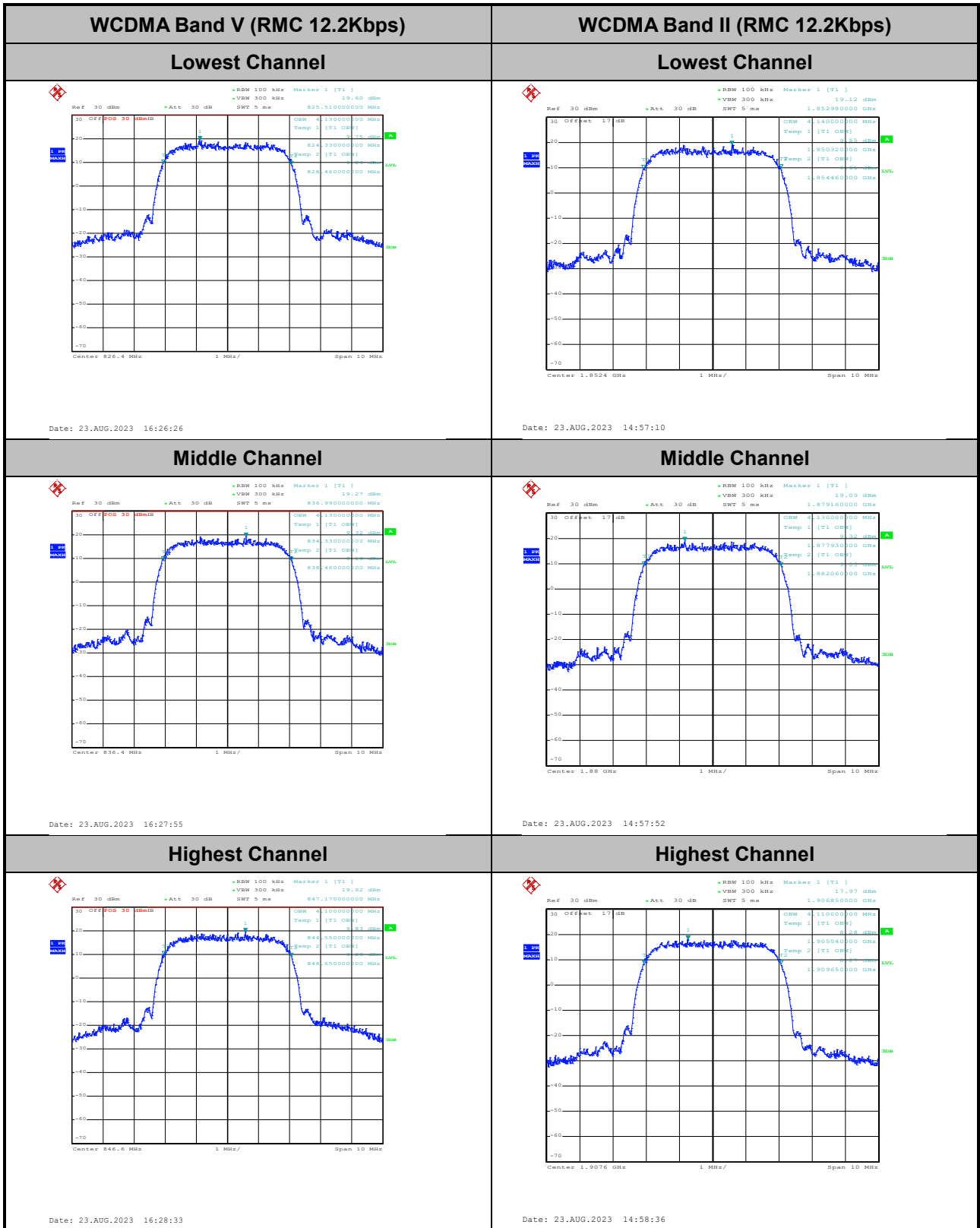

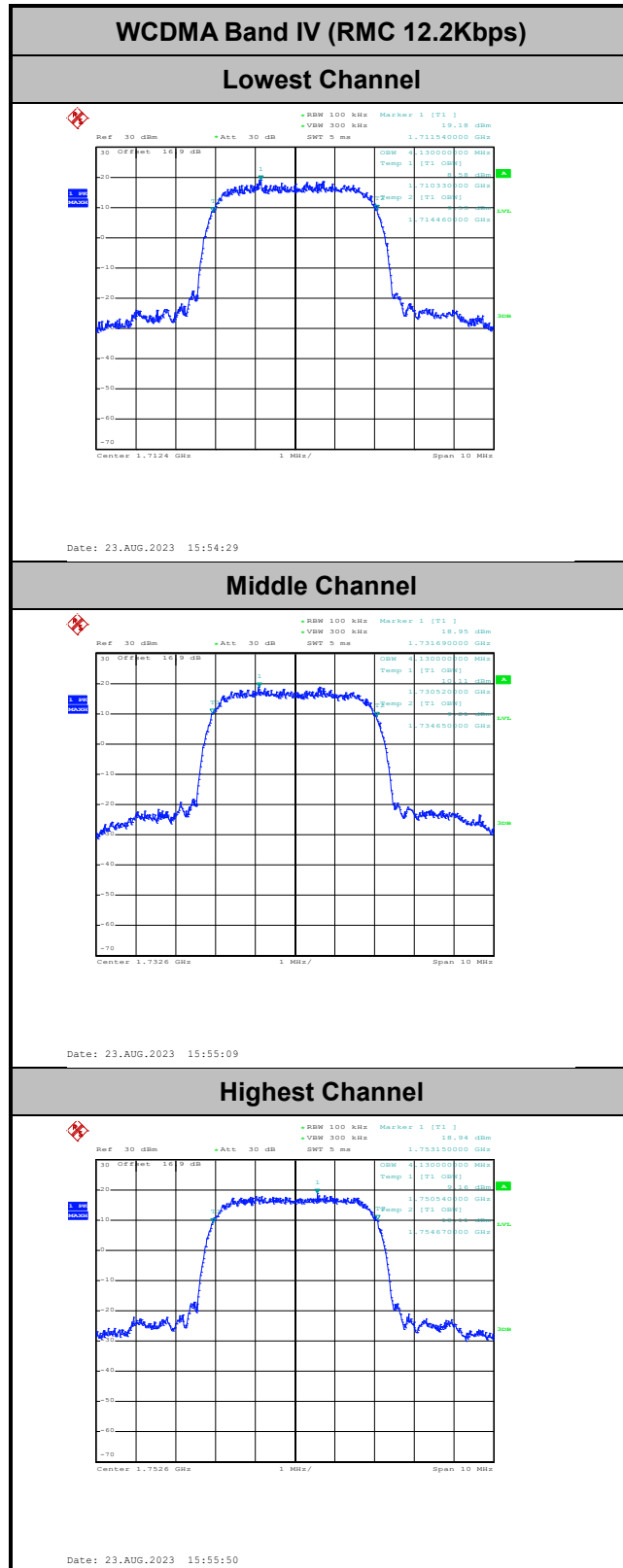



# Conducted Band Edge

## WCDMA Band V (RMC 12.2Kbps)

### Lowest Band Edge

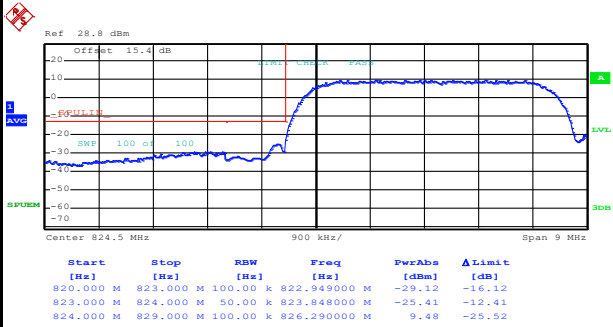

Date: 23.AUG.2023 16:33:12

### Highest Band Edge

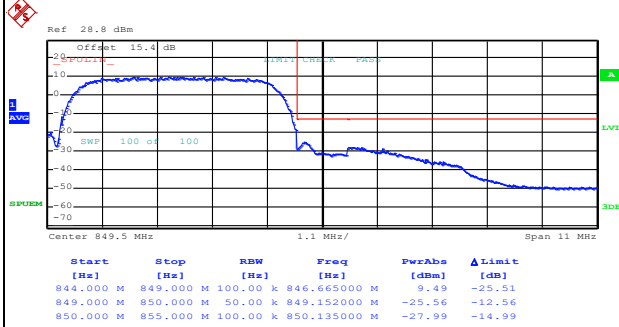

Date: 23.AUG.2023 16:37:04



WCDMA Band II (RMC 12.2Kbps)

Lowest Band Edge

Highest Band Edge

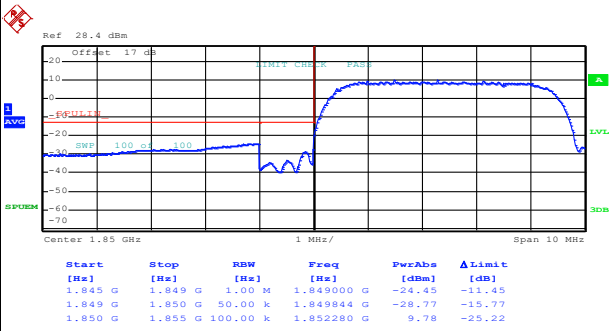

Date: 23.AUG.2023 15:02:10

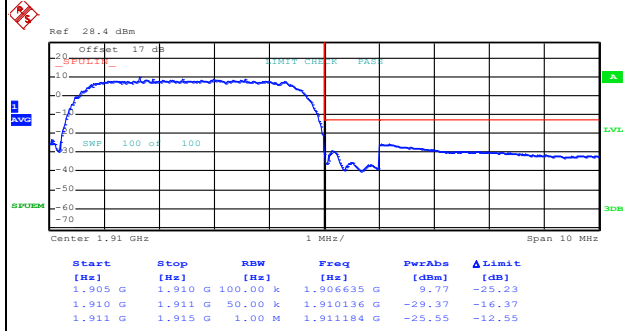

Date: 23.AUG.2023 15:05:07





WCDMA Band IV (RMC 12.2Kbps)

Lowest Band Edge

Highest Band Edge

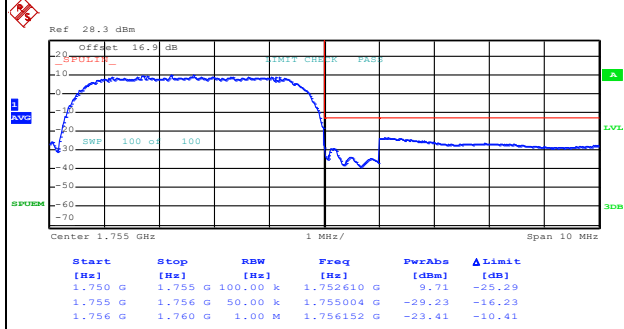
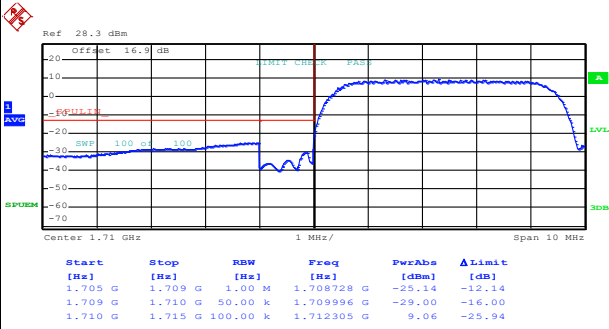

Date: 23.AUG.2023 15:59:16

Date: 23.AUG.2023 16:02:12



# Conducted Spurious Emission

WCDMA Band V (RMC 12.2Kbps)	WCDMA Band II (RMC 12.2Kbps)																																																																																										
<p><b>Lowest Channel</b></p> <table border="1"> <thead> <tr> <th>Start</th> <th>Stop</th> <th>RBW</th> <th>Freq</th> <th>PwrAve</th> <th>ΔLimit</th> </tr> <tr> <th>[MHz]</th> <th>[MHz]</th> <th>[MHz]</th> <th>[MHz]</th> <th>[dBm]</th> <th>[dB]</th> </tr> </thead> <tbody> <tr> <td>30.000 M</td> <td>820.000 M</td> <td>1.00 M</td> <td>819.802500 M</td> <td>-22.78</td> <td>-9.78</td> </tr> <tr> <td>855.000 M</td> <td>1.000 G</td> <td>1.00 M</td> <td>858.987500 M</td> <td>-43.31</td> <td>-30.31</td> </tr> <tr> <td>1.000 G</td> <td>3.000 G</td> <td>1.00 M</td> <td>2.872500 G</td> <td>-81.60</td> <td>-28.60</td> </tr> <tr> <td>3.000 G</td> <td>7.000 G</td> <td>1.00 M</td> <td>3.113000 G</td> <td>-38.82</td> <td>-25.82</td> </tr> <tr> <td>7.000 G</td> <td>9.000 G</td> <td>1.00 M</td> <td>8.374500 G</td> <td>-36.98</td> <td>-23.98</td> </tr> </tbody> </table> <p>Date: 23.AUG.2023 16:39:22</p>	Start	Stop	RBW	Freq	PwrAve	ΔLimit	[MHz]	[MHz]	[MHz]	[MHz]	[dBm]	[dB]	30.000 M	820.000 M	1.00 M	819.802500 M	-22.78	-9.78	855.000 M	1.000 G	1.00 M	858.987500 M	-43.31	-30.31	1.000 G	3.000 G	1.00 M	2.872500 G	-81.60	-28.60	3.000 G	7.000 G	1.00 M	3.113000 G	-38.82	-25.82	7.000 G	9.000 G	1.00 M	8.374500 G	-36.98	-23.98	<p><b>Lowest Channel</b></p> <table border="1"> <thead> <tr> <th>Start</th> <th>Stop</th> <th>RBW</th> <th>Freq</th> <th>PwrAve</th> <th>ΔLimit</th> </tr> <tr> <th>[MHz]</th> <th>[MHz]</th> <th>[MHz]</th> <th>[MHz]</th> <th>[dBm]</th> <th>[dB]</th> </tr> </thead> <tbody> <tr> <td>30.000 M</td> <td>1.000 G</td> <td>1.00 M</td> <td>821.277000 M</td> <td>-42.34</td> <td>-29.34</td> </tr> <tr> <td>1.000 G</td> <td>1.845 G</td> <td>1.00 M</td> <td>1.840364 G</td> <td>-26.20</td> <td>-13.20</td> </tr> <tr> <td>1.915 G</td> <td>3.000 G</td> <td>1.00 M</td> <td>2.388000 G</td> <td>-60.40</td> <td>-27.40</td> </tr> <tr> <td>3.000 G</td> <td>7.000 G</td> <td>1.00 M</td> <td>3.619000 G</td> <td>-37.65</td> <td>-24.65</td> </tr> <tr> <td>7.000 G</td> <td>13.600 G</td> <td>1.00 M</td> <td>10.221625 G</td> <td>-35.23</td> <td>-22.23</td> </tr> <tr> <td>13.600 G</td> <td>19.100 G</td> <td>1.00 M</td> <td>15.327650 G</td> <td>-25.39</td> <td>-12.39</td> </tr> </tbody> </table> <p>Date: 23.AUG.2023 15:06:25</p>	Start	Stop	RBW	Freq	PwrAve	ΔLimit	[MHz]	[MHz]	[MHz]	[MHz]	[dBm]	[dB]	30.000 M	1.000 G	1.00 M	821.277000 M	-42.34	-29.34	1.000 G	1.845 G	1.00 M	1.840364 G	-26.20	-13.20	1.915 G	3.000 G	1.00 M	2.388000 G	-60.40	-27.40	3.000 G	7.000 G	1.00 M	3.619000 G	-37.65	-24.65	7.000 G	13.600 G	1.00 M	10.221625 G	-35.23	-22.23	13.600 G	19.100 G	1.00 M	15.327650 G	-25.39	-12.39
Start	Stop	RBW	Freq	PwrAve	ΔLimit																																																																																						
[MHz]	[MHz]	[MHz]	[MHz]	[dBm]	[dB]																																																																																						
30.000 M	820.000 M	1.00 M	819.802500 M	-22.78	-9.78																																																																																						
855.000 M	1.000 G	1.00 M	858.987500 M	-43.31	-30.31																																																																																						
1.000 G	3.000 G	1.00 M	2.872500 G	-81.60	-28.60																																																																																						
3.000 G	7.000 G	1.00 M	3.113000 G	-38.82	-25.82																																																																																						
7.000 G	9.000 G	1.00 M	8.374500 G	-36.98	-23.98																																																																																						
Start	Stop	RBW	Freq	PwrAve	ΔLimit																																																																																						
[MHz]	[MHz]	[MHz]	[MHz]	[dBm]	[dB]																																																																																						
30.000 M	1.000 G	1.00 M	821.277000 M	-42.34	-29.34																																																																																						
1.000 G	1.845 G	1.00 M	1.840364 G	-26.20	-13.20																																																																																						
1.915 G	3.000 G	1.00 M	2.388000 G	-60.40	-27.40																																																																																						
3.000 G	7.000 G	1.00 M	3.619000 G	-37.65	-24.65																																																																																						
7.000 G	13.600 G	1.00 M	10.221625 G	-35.23	-22.23																																																																																						
13.600 G	19.100 G	1.00 M	15.327650 G	-25.39	-12.39																																																																																						
<p><b>Middle Channel</b></p> <table border="1"> <thead> <tr> <th>Start</th> <th>Stop</th> <th>RBW</th> <th>Freq</th> <th>PwrAve</th> <th>ΔLimit</th> </tr> <tr> <th>[MHz]</th> <th>[MHz]</th> <th>[MHz]</th> <th>[MHz]</th> <th>[dBm]</th> <th>[dB]</th> </tr> </thead> <tbody> <tr> <td>30.000 M</td> <td>820.000 M</td> <td>1.00 M</td> <td>814.470000 M</td> <td>-37.80</td> <td>-24.80</td> </tr> <tr> <td>855.000 M</td> <td>1.000 G</td> <td>1.00 M</td> <td>948.208750 M</td> <td>-42.73</td> <td>-29.73</td> </tr> <tr> <td>1.000 G</td> <td>3.000 G</td> <td>1.00 M</td> <td>2.399500 G</td> <td>-42.42</td> <td>-29.42</td> </tr> <tr> <td>3.000 G</td> <td>7.000 G</td> <td>1.00 M</td> <td>3.678000 G</td> <td>-38.94</td> <td>-25.94</td> </tr> <tr> <td>7.000 G</td> <td>9.000 G</td> <td>1.00 M</td> <td>8.344000 G</td> <td>-36.66</td> <td>-23.66</td> </tr> </tbody> </table> <p>Date: 23.AUG.2023 16:40:29</p>	Start	Stop	RBW	Freq	PwrAve	ΔLimit	[MHz]	[MHz]	[MHz]	[MHz]	[dBm]	[dB]	30.000 M	820.000 M	1.00 M	814.470000 M	-37.80	-24.80	855.000 M	1.000 G	1.00 M	948.208750 M	-42.73	-29.73	1.000 G	3.000 G	1.00 M	2.399500 G	-42.42	-29.42	3.000 G	7.000 G	1.00 M	3.678000 G	-38.94	-25.94	7.000 G	9.000 G	1.00 M	8.344000 G	-36.66	-23.66	<p><b>Middle Channel</b></p> <table border="1"> <thead> <tr> <th>Start</th> <th>Stop</th> <th>RBW</th> <th>Freq</th> <th>PwrAve</th> <th>ΔLimit</th> </tr> <tr> <th>[MHz]</th> <th>[MHz]</th> <th>[MHz]</th> <th>[MHz]</th> <th>[dBm]</th> <th>[dB]</th> </tr> </thead> <tbody> <tr> <td>30.000 M</td> <td>1.000 G</td> <td>1.00 M</td> <td>142.742500 M</td> <td>-41.38</td> <td>-28.38</td> </tr> <tr> <td>1.000 G</td> <td>1.845 G</td> <td>1.00 M</td> <td>1.285821 G</td> <td>-41.30</td> <td>-28.30</td> </tr> <tr> <td>1.915 G</td> <td>3.000 G</td> <td>1.00 M</td> <td>2.915641 G</td> <td>-40.04</td> <td>-27.04</td> </tr> <tr> <td>3.000 G</td> <td>7.000 G</td> <td>1.00 M</td> <td>3.620071 G</td> <td>-37.35</td> <td>-24.35</td> </tr> <tr> <td>7.000 G</td> <td>13.600 G</td> <td>1.00 M</td> <td>10.210075 G</td> <td>-34.92</td> <td>-21.92</td> </tr> <tr> <td>13.600 G</td> <td>19.100 G</td> <td>1.00 M</td> <td>15.340750 G</td> <td>-25.95</td> <td>-12.95</td> </tr> </tbody> </table> <p>Date: 23.AUG.2023 15:07:24</p>	Start	Stop	RBW	Freq	PwrAve	ΔLimit	[MHz]	[MHz]	[MHz]	[MHz]	[dBm]	[dB]	30.000 M	1.000 G	1.00 M	142.742500 M	-41.38	-28.38	1.000 G	1.845 G	1.00 M	1.285821 G	-41.30	-28.30	1.915 G	3.000 G	1.00 M	2.915641 G	-40.04	-27.04	3.000 G	7.000 G	1.00 M	3.620071 G	-37.35	-24.35	7.000 G	13.600 G	1.00 M	10.210075 G	-34.92	-21.92	13.600 G	19.100 G	1.00 M	15.340750 G	-25.95	-12.95
Start	Stop	RBW	Freq	PwrAve	ΔLimit																																																																																						
[MHz]	[MHz]	[MHz]	[MHz]	[dBm]	[dB]																																																																																						
30.000 M	820.000 M	1.00 M	814.470000 M	-37.80	-24.80																																																																																						
855.000 M	1.000 G	1.00 M	948.208750 M	-42.73	-29.73																																																																																						
1.000 G	3.000 G	1.00 M	2.399500 G	-42.42	-29.42																																																																																						
3.000 G	7.000 G	1.00 M	3.678000 G	-38.94	-25.94																																																																																						
7.000 G	9.000 G	1.00 M	8.344000 G	-36.66	-23.66																																																																																						
Start	Stop	RBW	Freq	PwrAve	ΔLimit																																																																																						
[MHz]	[MHz]	[MHz]	[MHz]	[dBm]	[dB]																																																																																						
30.000 M	1.000 G	1.00 M	142.742500 M	-41.38	-28.38																																																																																						
1.000 G	1.845 G	1.00 M	1.285821 G	-41.30	-28.30																																																																																						
1.915 G	3.000 G	1.00 M	2.915641 G	-40.04	-27.04																																																																																						
3.000 G	7.000 G	1.00 M	3.620071 G	-37.35	-24.35																																																																																						
7.000 G	13.600 G	1.00 M	10.210075 G	-34.92	-21.92																																																																																						
13.600 G	19.100 G	1.00 M	15.340750 G	-25.95	-12.95																																																																																						
<p><b>Highest Channel</b></p> <table border="1"> <thead> <tr> <th>Start</th> <th>Stop</th> <th>RBW</th> <th>Freq</th> <th>PwrAve</th> <th>ΔLimit</th> </tr> <tr> <th>[MHz]</th> <th>[MHz]</th> <th>[MHz]</th> <th>[MHz]</th> <th>[dBm]</th> <th>[dB]</th> </tr> </thead> <tbody> <tr> <td>30.000 M</td> <td>820.000 M</td> <td>1.00 M</td> <td>795.312500 M</td> <td>-43.87</td> <td>-30.87</td> </tr> <tr> <td>855.000 M</td> <td>1.000 G</td> <td>1.00 M</td> <td>888.337500 M</td> <td>-43.64</td> <td>-30.64</td> </tr> <tr> <td>1.000 G</td> <td>3.000 G</td> <td>1.00 M</td> <td>3.694000 G</td> <td>-62.05</td> <td>-29.05</td> </tr> <tr> <td>3.000 G</td> <td>7.000 G</td> <td>1.00 M</td> <td>3.106000 G</td> <td>-39.04</td> <td>-26.04</td> </tr> <tr> <td>7.000 G</td> <td>9.000 G</td> <td>1.00 M</td> <td>8.345000 G</td> <td>-36.75</td> <td>-23.75</td> </tr> </tbody> </table> <p>Date: 23.AUG.2023 16:42:11</p>	Start	Stop	RBW	Freq	PwrAve	ΔLimit	[MHz]	[MHz]	[MHz]	[MHz]	[dBm]	[dB]	30.000 M	820.000 M	1.00 M	795.312500 M	-43.87	-30.87	855.000 M	1.000 G	1.00 M	888.337500 M	-43.64	-30.64	1.000 G	3.000 G	1.00 M	3.694000 G	-62.05	-29.05	3.000 G	7.000 G	1.00 M	3.106000 G	-39.04	-26.04	7.000 G	9.000 G	1.00 M	8.345000 G	-36.75	-23.75	<p><b>Highest Channel</b></p> <table border="1"> <thead> <tr> <th>Start</th> <th>Stop</th> <th>RBW</th> <th>Freq</th> <th>PwrAve</th> <th>ΔLimit</th> </tr> <tr> <th>[MHz]</th> <th>[MHz]</th> <th>[MHz]</th> <th>[MHz]</th> <th>[dBm]</th> <th>[dB]</th> </tr> </thead> <tbody> <tr> <td>30.000 M</td> <td>1.000 G</td> <td>1.00 M</td> <td>981.055000 M</td> <td>-42.62</td> <td>-29.62</td> </tr> <tr> <td>1.000 G</td> <td>1.845 G</td> <td>1.00 M</td> <td>1.843321 G</td> <td>-31.51</td> <td>-18.51</td> </tr> <tr> <td>1.915 G</td> <td>3.000 G</td> <td>1.00 M</td> <td>3.633271 G</td> <td>-29.88</td> <td>-16.88</td> </tr> <tr> <td>3.000 G</td> <td>7.000 G</td> <td>1.00 M</td> <td>3.096000 G</td> <td>-37.64</td> <td>-24.64</td> </tr> <tr> <td>7.000 G</td> <td>13.600 G</td> <td>1.00 M</td> <td>11.639800 G</td> <td>-35.42</td> <td>-22.42</td> </tr> <tr> <td>13.600 G</td> <td>19.100 G</td> <td>1.00 M</td> <td>15.375375 G</td> <td>-26.01</td> <td>-13.01</td> </tr> </tbody> </table> <p>Date: 23.AUG.2023 15:08:23</p>	Start	Stop	RBW	Freq	PwrAve	ΔLimit	[MHz]	[MHz]	[MHz]	[MHz]	[dBm]	[dB]	30.000 M	1.000 G	1.00 M	981.055000 M	-42.62	-29.62	1.000 G	1.845 G	1.00 M	1.843321 G	-31.51	-18.51	1.915 G	3.000 G	1.00 M	3.633271 G	-29.88	-16.88	3.000 G	7.000 G	1.00 M	3.096000 G	-37.64	-24.64	7.000 G	13.600 G	1.00 M	11.639800 G	-35.42	-22.42	13.600 G	19.100 G	1.00 M	15.375375 G	-26.01	-13.01
Start	Stop	RBW	Freq	PwrAve	ΔLimit																																																																																						
[MHz]	[MHz]	[MHz]	[MHz]	[dBm]	[dB]																																																																																						
30.000 M	820.000 M	1.00 M	795.312500 M	-43.87	-30.87																																																																																						
855.000 M	1.000 G	1.00 M	888.337500 M	-43.64	-30.64																																																																																						
1.000 G	3.000 G	1.00 M	3.694000 G	-62.05	-29.05																																																																																						
3.000 G	7.000 G	1.00 M	3.106000 G	-39.04	-26.04																																																																																						
7.000 G	9.000 G	1.00 M	8.345000 G	-36.75	-23.75																																																																																						
Start	Stop	RBW	Freq	PwrAve	ΔLimit																																																																																						
[MHz]	[MHz]	[MHz]	[MHz]	[dBm]	[dB]																																																																																						
30.000 M	1.000 G	1.00 M	981.055000 M	-42.62	-29.62																																																																																						
1.000 G	1.845 G	1.00 M	1.843321 G	-31.51	-18.51																																																																																						
1.915 G	3.000 G	1.00 M	3.633271 G	-29.88	-16.88																																																																																						
3.000 G	7.000 G	1.00 M	3.096000 G	-37.64	-24.64																																																																																						
7.000 G	13.600 G	1.00 M	11.639800 G	-35.42	-22.42																																																																																						
13.600 G	19.100 G	1.00 M	15.375375 G	-26.01	-13.01																																																																																						



WCDMA Band IV (RMC 12.2Kbps)

Lowest Channel

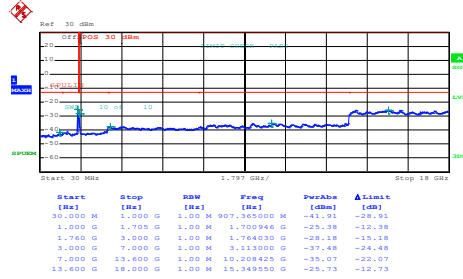

Date: 23.AUG.2023 16:03:36

Middle Channel

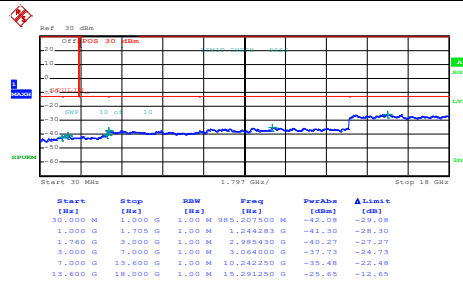

Date: 23.AUG.2023 16:04:35

Highest Channel

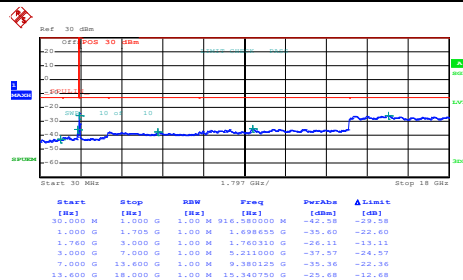

Date: 23.AUG.2023 16:05:32



**Frequency Stability**

Test Conditions	Middle Channel	WCDMA Band V (RMC 12.2Kbps)	Limit
			2.5ppm
Temperature (°C)	Voltage (Volt)	Deviation (ppm)	Result
50	Normal Voltage	0.0024	PASS
40	Normal Voltage	0.0024	
30	Normal Voltage	0.0179	
20(Ref.)	Normal Voltage	0.0000	
10	Normal Voltage	0.0024	
0	Normal Voltage	0.0048	
-10	Normal Voltage	0.0191	
20	Maximum Voltage	0.0012	
20	Normal Voltage	0.0012	
20	Battery End Point	0.0048	

Test Conditions	Middle Channel	WCDMA Band II (RMC 12.2Kbps)	Limit
			Note 2.
Temperature (°C)	Voltage (Volt)	Deviation (ppm)	Result
50	Normal Voltage	0.0037	PASS
40	Normal Voltage	0.0011	
30	Normal Voltage	0.0048	
20(Ref.)	Normal Voltage	0.0000	
10	Normal Voltage	0.0016	
0	Normal Voltage	0.0011	
-10	Normal Voltage	0.0090	
20	Maximum Voltage	0.0016	
20	Normal Voltage	0.0021	
20	Battery End Point	0.0005	



Test Conditions	Middle Channel	WCDMA Band IV (RMC 12.2Kbps)	Limit
			Note 2.
Temperature (°C)	Voltage (Volt)	Deviation (ppm)	Result
50	Normal Voltage	0.0242	PASS
40	Normal Voltage	0.0185	
30	Normal Voltage	0.0127	
20(Ref.)	Normal Voltage	0.0000	
10	Normal Voltage	0.0017	
0	Normal Voltage	0.0023	
-10	Normal Voltage	0.0219	
20	Maximum Voltage	0.0133	
20	Normal Voltage	0.0410	

**Note:**

1. Normal Voltage = 3.8V. ; Battery End Point (BEP) = 3.3 V. ; Maximum Voltage =4.2 V
2. The frequency fundamental emissions stay within the authorized frequency block.



## Appendix B. Test Results of Radiated Test

### GSM850

GSM 850										
Channel	Frequency ( MHz )	ERP ( dBm )	Limit ( dBm )	Over Limit ( dB )	SPA Reading (dBm)	S.G. Power ( dBm )	TX Cable loss ( dB )	TX Antenna Gain (dBi)	Polarization (H/V)	
Lowest	1648	-43.74	-13	-30.74	-56.64	-45.5	0.98	4.89	H	
	2474	-38.61	-13	-25.61	-56.94	-40.5	1.28	5.32	H	
	3298	-57.68	-13	-44.68	-77.84	-61.1	1.54	7.11	H	
	4120	-57.26	-13	-44.26	-78.98	-61.9	1.83	8.62	H	
										H
										H
										H
	1648	-38.14	-13	-25.14	-51.31	-39.9	0.98	4.89	V	
	2474	-33.11	-13	-20.11	-51.67	-35	1.28	5.32	V	
	3298	-53.78	-13	-40.78	-74.21	-57.2	1.54	7.11	V	
	4120	-53.06	-13	-40.06	-75.16	-57.7	1.83	8.62	V	
										V
										V
										V
Middle	1672	-46.22	-13	-33.22	-59.57	-47.9	0.99	4.82	H	
	2512	-36.83	-13	-23.83	-55.15	-38.8	1.29	5.41	H	
	3345	-57.29	-13	-44.29	-78	-60.9	1.56	7.32	H	
	4184	-55.18	-13	-42.18	-77.33	-59.8	1.87	8.64	H	
										H
										H
										H
	1672	-41.22	-13	-28.22	-54.72	-42.9	0.99	4.82	V	
	2512	-33.93	-13	-20.93	-52.68	-35.9	1.29	5.41	V	
	3345	-57.39	-13	-44.39	-78.25	-61	1.56	7.32	V	
	4184	-56.18	-13	-43.18	-78.5	-60.8	1.87	8.64	V	
										V
										V
										V



Highest	1696	-49.90	-13	-36.90	-63.01	-51.5	1.00	4.75	H
	2544	-33.62	-13	-20.62	-51.94	-35.6	1.30	5.44	H
	3393	-57.29	-13	-44.29	-78.3	-61.1	1.57	7.53	H
	4240	-56.50	-13	-43.50	-78.72	-61.1	1.90	8.65	H
									H
									H
									H
	1696	-51.00	-13	-38.00	-64.7	-52.6	1.00	4.75	V
	2544	-35.42	-13	-22.42	-54.2	-37.4	1.30	5.44	V
	3393	-57.29	-13	-44.29	-78.49	-61.1	1.57	7.53	V
	4240	-55.60	-13	-42.60	-77.94	-60.2	1.90	8.65	V
									V
									V
									V

Remark: Spurious emissions within 30-1000MHz were found more than 20dB below limit line.



**GSM1900**

GSM 1900									
Channel	Frequency ( MHz )	EIRP ( dBm )	Limit ( dBm )	Over Limit ( dB )	SPA Reading (dBm)	S.G. Power ( dBm )	TX Cable loss ( dB )	TX Antenna Gain (dBi)	Polarization (H/V)
Lowest	3702	-50.63	-13	-37.63	-72.62	-57.2	1.67	8.24	H
	5550	-51.03	-13	-38.03	-77.25	-58.1	2.65	9.72	H
	7400	-53.96	-13	-40.96	-81.88	-63.1	2.46	11.60	H
									H
									H
									H
									H
	3702	-38.53	-13	-25.53	-60.28	-45.1	1.67	8.24	V
	5550	-51.23	-13	-38.23	-77.77	-58.3	2.65	9.72	V
	7400	-53.86	-13	-40.86	-82.11	-63	2.46	11.60	V
									V
									V
									V
									V
Middle	3762	-45.87	-13	-32.87	-67.74	-52.5	1.69	8.31	H
	5640	-50.95	-13	-37.95	-77.25	-58	2.71	9.76	H
	7520	-53.11	-13	-40.11	-81.89	-62.5	2.42	11.81	H
									H
									H
									H
									H
	3762	-35.47	-13	-22.47	-57.37	-42.1	1.69	8.31	V
	5640	-52.45	-13	-39.45	-79.17	-59.5	2.71	9.76	V
	7520	-53.11	-13	-40.11	-81.86	-62.5	2.42	11.81	V
									V
									V
									V
									V





Highest	3822	-40.82	-13	-27.82	-62.45	-47.5	1.71	8.39	H
	5730	-43.07	-13	-30.07	-69.49	-50.1	2.76	9.79	H
	7640	-53.00	-13	-40.00	-82.03	-62.5	2.38	11.88	H
									H
									H
									H
									H
	3822	-34.42	-13	-21.42	-56.29	-41.1	1.71	8.39	V
	5730	-38.77	-13	-25.77	-65.41	-45.8	2.76	9.79	V
	7640	-52.80	-13	-39.80	-82.09	-62.3	2.38	11.88	V
									V
									V
									V
									V

Remark: Spurious emissions within 30-1000MHz were found more than 20dB below limit line.



**WCDMA 850**

WCDMA 850									
Channel	Frequency ( MHz )	ERP ( dBm )	Limit ( dBm )	Over Limit ( dB )	SPA Reading (dBm)	S.G. Power ( dBm )	TX Cable loss ( dB )	TX Antenna Gain (dBi)	Polarization (H/V)
Lowest	1648	-61.54	-13	-48.54	-74.8	-63.3	0.98	4.89	H
	2480	-42.79	-13	-29.79	-61.32	-44.7	1.28	5.34	H
	3288	-57.42	-13	-44.42	-77.69	-60.8	1.54	7.07	H
									H
									H
									H
									H
	1648	-62.34	-13	-49.34	-75.26	-64.1	0.98	4.89	V
	2480	-51.39	-13	-38.39	-69.54	-53.3	1.28	5.34	V
	3288	-57.72	-13	-44.72	-78.11	-61.1	1.54	7.07	V
									V
									V
									V
									V
Middle	1672	-60.62	-13	-47.62	-73.93	-62.3	0.99	4.82	H
	2512	-53.93	-13	-40.93	-72.76	-55.9	1.29	5.41	H
	3352	-58.16	-13	-45.16	-79.03	-61.8	1.56	7.35	H
									H
									H
									H
									H
	1672	-61.12	-13	-48.12	-74.31	-62.8	0.99	4.82	V
	2512	-52.13	-13	-39.13	-70.2	-54.1	1.29	5.41	V
	3352	-58.26	-13	-45.26	-78.83	-61.9	1.56	7.35	V
									V
									V
									V
									V



Highest	1696	-60.50	-13	-47.50	-74.35	-62.1	1.00	4.75	H
	2544	-46.52	-13	-33.52	-65.15	-48.5	1.30	5.44	H
	3392	-57.80	-13	-44.80	-78.81	-61.6	1.57	7.52	H
	4232	-57.50	-13	-44.50	-79.75	-62.1	1.89	8.65	H
									H
									H
									H
	1696	-59.50	-13	-46.50	-72.78	-61.1	1.00	4.75	V
	2544	-43.42	-13	-30.42	-61.61	-45.4	1.30	5.44	V
	3392	-58.00	-13	-45.00	-79.1	-61.8	1.57	7.52	V
	4232	-56.10	-13	-43.10	-78.39	-60.7	1.89	8.65	V
									V
									V
									V

Remark: Spurious emissions within 30-1000MHz were found more than 20dB below limit line.



**WCDMA 1700**

WCDMA 1700									
Channel	Frequency ( MHz )	EIRP ( dBm )	Limit ( dBm )	Over Limit ( dB )	SPA Reading (dBm)	S.G. Power ( dBm )	TX Cable loss ( dB )	TX Antenna Gain (dBi)	Polarization (H/V)
Lowest	3426	-56.15	-13	-43.15	-78.14	-62.24	1.58	7.67	H
	5136	-55.93	-13	-42.93	-81.3	-63.21	2.42	9.70	H
	6852	-54.05	-13	-41.05	-82.4	-62.03	2.64	10.62	H
									H
									H
									H
									H
	3426	-55.05	-13	-42.05	-77.01	-61.14	1.58	7.67	V
	5136	-55.59	-13	-42.59	-81.15	-62.87	2.42	9.70	V
	6852	-53.23	-13	-40.23	-81.8	-61.21	2.64	10.62	V
									V
									V
									V
									V
Middle	3462	-53.88	-13	-40.88	-75.93	-60.12	1.59	7.83	H
	5196	-56.38	-13	-43.38	-81.74	-63.63	2.45	9.70	H
	6930	-54.19	-13	-41.19	-82.47	-62.29	2.61	10.72	H
									H
									H
									H
									H
	3462	-52.38	-13	-39.38	-74.47	-58.62	1.59	7.83	V
	5196	-56.08	-13	-43.08	-81.66	-63.33	2.45	9.70	V
	6930	-54.16	-13	-41.16	-82.39	-62.26	2.61	10.72	V
									V
									V
									V
									V



Highest	3504	-55.92	-13	-42.92	-78.08	-62.32	1.61	8.00	H
	5256	-55.92	-13	-42.92	-81.49	-63.14	2.48	9.70	H
	7008	-52.54	-13	-39.54	-80.64	-60.77	2.59	10.82	H
									H
									H
									H
									H
	3504	-55.22	-13	-42.22	-77.43	-61.62	1.61	8.00	V
	5256	-55.45	-13	-42.45	-81.2	-62.67	2.48	9.70	V
	7008	-52.78	-13	-39.78	-80.8	-61.01	2.59	10.82	V
									V
									V
									V
									V

Remark: Spurious emissions within 30-1000MHz were found more than 20dB below limit line.



**WCDMA 1900**

WCDMA 1900									
Channel	Frequency ( MHz )	EIRP ( dBm )	Limit ( dBm )	Over Limit ( dB )	SPA Reading (dBm)	S.G. Power ( dBm )	TX Cable loss ( dB )	TX Antenna Gain (dBi)	Polarization (H/V)
Lowest	3702	-55.25	-13	-42.25	-77.44	-61.82	1.67	8.24	H
	5556	-55.02	-13	-42.02	-81.75	-62.09	2.66	9.72	H
	7410	-52.47	-13	-39.47	-81.01	-61.63	2.46	11.62	H
									H
									H
									H
									H
	3702	-53.76	-13	-40.76	-75.94	-60.33	1.67	8.24	V
	5556	-55.18	-13	-42.18	-81.91	-62.25	2.66	9.72	V
	7410	-52.68	-13	-39.68	-81.13	-61.84	2.46	11.62	V
									V
									V
									V
									V
Middle	3756	-53.28	-13	-40.28	-75.04	-59.9	1.68	8.31	H
	5640	-53.25	-13	-40.25	-79.58	-60.3	2.71	9.76	H
	7518	-48.71	-13	-35.71	-76.72	-58.1	2.42	11.81	H
									H
									H
									H
									H
	3756	-48.38	-13	-35.38	-70.46	-55	1.68	8.31	V
	5640	-52.65	-13	-39.65	-79.21	-59.7	2.71	9.76	V
	7518	-47.71	-13	-34.71	-76.26	-57.1	2.42	11.81	V
									V
									V
									V
									V



Highest	3816	-55.15	-13	-42.15	-77.18	-61.83	1.70	8.38	H
	5724	-55.11	-13	-42.11	-82	-62.15	2.75	9.79	H
	7632	-48.73	-13	-35.73	-78.01	-58.22	2.39	11.88	H
									H
									H
									H
									H
	3816	-50.34	-13	-37.34	-72.39	-57.02	1.70	8.38	V
	5724	-54.85	-13	-41.85	-81.71	-61.89	2.75	9.79	V
	7632	-48.28	-13	-35.28	-77.31	-57.77	2.39	11.88	V
									V
									V
									V
									V

Remark: Spurious emissions within 30-1000MHz were found more than 20dB below limit line.