



# FCC RADIO TEST REPORT

**FCC ID** : B32V400M2  
**Equipment** : Point of Sale Terminal  
**Brand Name** : Verifone  
**Model Name** : V400m-2  
**Applicant** : Verifone, Inc.  
1400 West Stanford Ranch Road Suite  
150 Rocklin CA 95765 USA  
**Manufacturer** : Verifone, Inc.  
**Standard** : FCC 47 CFR Part 2, 22(H), 24(E), 27

The product was received on Jul. 25, 2023 and testing was performed from Aug. 08, 2023 to Sep. 05, 2023. We, Sporton International Inc. EMC & Wireless Communications Laboratory, would like to declare that the tested sample has been evaluated in accordance with the test procedures given in ANSI / TIA-603-E and has been in compliance with the applicable technical standards.

The test results in this report apply exclusively to the tested model / sample. Without written approval from Sporton International Inc. EMC & Wireless Communications Laboratory, the test report shall not be reproduced except in full.

*Louis Wu*

Approved by: Louis Wu

**Sporton International Inc. EMC & Wireless Communications Laboratory**

No. 52, Huaya 1st Rd., Guishan Dist., Taoyuan City 333, Taiwan (R.O.C.)



# Table of Contents

**History of this test report..... 3**

**Summary of Test Result..... 4**

**1 General Description ..... 6**

    1.1 Product Feature of Equipment Under Test..... 6

    1.2 Modification of EUT ..... 6

    1.3 Testing Location ..... 6

    1.4 Applicable Standards..... 7

**2 Test Configuration of Equipment Under Test ..... 8**

    2.1 Test Mode..... 8

    2.2 Connection Diagram of Test System..... 12

    2.3 Support Unit used in test configuration and system ..... 12

    2.4 Measurement Results Explanation Example..... 12

    2.5 Frequency List of Low/Middle/High Channels ..... 13

**3 Conducted Test Items..... 17**

    3.1 Measuring Instruments ..... 17

    3.2 Conducted Output Power and ERP/EIRP ..... 18

    3.3 Peak-to-Average Ratio ..... 19

    3.4 Occupied Bandwidth..... 20

    3.5 Conducted Band Edge ..... 21

    3.6 Conducted Spurious Emission ..... 23

    3.7 Frequency Stability ..... 24

**4 Radiated Test Items ..... 25**

    4.1 Measuring Instruments ..... 25

    4.2 Radiated Spurious Emission Measurement ..... 27

**5 List of Measuring Equipment..... 28**

**6 Measurement Uncertainty ..... 29**

**Appendix A. Test Results of Conducted Test**

**Appendix B. Test Results of Radiated Test**

**Appendix C. Test Setup Photographs**





## Summary of Test Result

Report Clause	Ref Std. Clause	Test Items	Result (PASS/FAIL)	Remark
3.2	§2.1046	Conducted Output Power	Reporting only	-
	§22.913 (a)(5)	Effective Radiated Power (Band 5) (Band 26)	Pass	
	§27.50 (b)(10) §27.50 (c)(10)	Effective Radiated Power (Band 12) (Band 13)		
	§24.232 (c) §27.50 (h)(2)	Equivalent Isotropic Radiated Power (Band 2) (Band 7) (Band 38) (Band 41)		
	§27.50 (d)(4)	Equivalent Isotropic Radiated Power (Band 4) (Band 66)		
3.3	§24.232 (d) §27.50 (d)(5)	Peak-to-Average Ratio	Pass	-
3.4	§2.1049	Occupied Bandwidth	Reporting only	-
3.5	§2.1051 §22.917 (a) §24.238 (a) §27.53 (c)(2)(4) §27.53 (g) §27.53 (h)	Conducted Band Edge Measurement (Band 2) (Band 4) (Band 5) (Band 12) (Band 13) (Band 26) (Band 66)	Pass	-
	§2.1051 §27.53 (m)(4)	Conducted Band Edge Measurement (Band 7) (Band 38) (Band 41)		
3.6	§2.1051 §22.917 (a) §24.238 (a) §27.53 (c)(2) §27.53 (g) §27.53 (h)	Conducted Spurious Emission (Band 2) (Band 4) (Band 5) (Band 12) (Band 13) (Band 26) (Band 66)	Pass	-
	§2.1051 §27.53 (m)(4)	Conducted Spurious Emission (Band 7) (Band 38) (Band 41)		
3.7	§2.1055 §22.355 §24.235 §27.54	Frequency Stability Temperature & Voltage	Pass	-



Report Clause	Ref Std. Clause	Test Items	Result (PASS/FAIL)	Remark
4.2	§2.1053 §22.917 (a) §24.238 (a) §27.53 (c)(2) §27.53 (f) §27.53 (g) §27.53 (h)	Radiated Spurious Emission (Band 2) (Band 4) (Band 5) (Band 12) (Band 13) (Band 26) (Band 66)	Pass	11.01 dB under the limit at 1560.00 MHz
	§2.1051 §27.53 (m)(4)	Radiated Spurious Emission (Band 7) (Band 38) (Band 41)		

**Conformity Assessment Condition:**

1. The test results (PASS/FAIL) with all measurement uncertainty excluded are presented against the regulation limits or in accordance with the requirements stipulated by the applicant/manufacture who shall bear all the risks of non-compliance that may potentially occur if measurement uncertainty is taken into account.
2. The measurement uncertainty please refer to each test result in the section "Measurement Uncertainty".

**Disclaimer:**

The product specifications of the EUT presented in the test report that may affect the test assessments are declared by the manufacturer who shall take full responsibility for the authenticity.

**Reviewed by: Yun Huang**

**Report Producer: Michelle Chen**



# 1 General Description

## 1.1 Product Feature of Equipment Under Test

Product Feature	
<b>General Specs</b> GSM/WCDMA/LTE, Bluetooth, Wi-Fi 2.4GHz 802.11b/g/n, Wi-Fi 5GHz 802.11a/n/ac and NFC.	
<b>Antenna Type</b> WWAN: Fixed Internal Antenna WLAN: PCB Antenna Bluetooth: PCB Antenna NFC: Loop Antenna	
<b>Antenna Gain</b>	LTE Band 2: 2.03 dBi LTE Band 4: 2.21 dBi LTE Band 5: 0.43 dBi LTE Band 7: -0.64 dBi LTE Band 12: -1.28 dBi LTE Band 13: -1.23 dBi LTE Band 26: 0.41 dBi LTE Band 38: -0.64 dBi LTE Band 41: -0.74 dBi LTE Band 66: 2.38 dBi

**Remark:** The EUT's information above is declared by manufacturer. Please refer to Disclaimer in report summary.

## 1.2 Modification of EUT

No modifications made to the EUT during the testing.

## 1.3 Testing Location

<b>Test Site</b>	Sporton International Inc. EMC & Wireless Communications Laboratory	
<b>Test Site Location</b>	No.52, Huaya 1st Rd., Guishan Dist., Taoyuan City 333, Taiwan (R.O.C.) TEL: +886-3-327-3456 FAX: +886-3-328-4978	
<b>Test Site No.</b>	<b>Sporton Site No.</b>	
	TH03-HY	03CH07-HY
<b>Test Engineer</b>	HaoEn Zhang	Jesse Wang, Stan Hsieh and Ken Wu
<b>Temperature (°C)</b>	21.5~23.6	20.2~28.1
<b>Relative Humidity (%)</b>	52.3~54.1	51.2~68.6

**Note:** The test site complies with ANSI C63.4 2014 requirement.

FCC Designation No.: TW1190



## **1.4 Applicable Standards**

According to the specifications of the manufacturer, the EUT must comply with the requirements of the following standards:

- ♦ ANSI C63.26-2015
- ♦ ANSI / TIA-603-E
- ♦ FCC 47 CFR Part 2, 22(H), 24(E), 27
- ♦ FCC KDB 971168 D01 Power Meas. License Digital Systems v03r01
- ♦ FCC KDB 412172 D01 Determining ERP and EIRP v01r01
- ♦ FCC KDB 414788 D01 Radiated Test Site v01r01.

**Remark:**

1. All the test items were validated and recorded in accordance with the standards without any modification during the testing.
2. This EUT has also been tested and complied with the requirements of FCC Part 15, Subpart B, recorded in a separate test report.
3. The TAF code is not including all the FCC KDB listed without accreditation.



## 2 Test Configuration of Equipment Under Test

### 2.1 Test Mode

Antenna port conducted and radiated test items listed below are performed according to KDB 971168 D01 Power Meas. License Digital Systems v03r01 with maximum output power.

For radiated measurement, the measured emission level of the EUT was maximized by rotating the EUT on a turntable, adjusting the orientation of the EUT and EUT antenna in three orthogonal axis (X: flat, Y: portrait, Z: landscape), and adjusting the measurement antenna orientation, following C63.26 exploratory test procedures and only the worst case emissions were reported in this report.

Test Items	Band	Bandwidth (MHz)						Modulation		RB #			Test Channel		
		1.4	3	5	10	15	20	QPSK	16QAM	1	Half	Full	L	M	H
Max. Output Power	2	v	v	v	v	v	v	v	v	v	v	v	v	v	v
	4	v	v	v	v	v	v	v	v	v	v	v	v	v	v
	5	v	v	v	v	-	-	v	v	v	v	v	v	v	v
	7	-	-	v	v	v	v	v	v	v	v	v	v	v	v
	12	v	v	v	v	-	-	v	v	v	v	v	v	v	v
	13	-	-	v	v	-	-	v	v	v	v	v	v	v	v
	26	v	v	v	v	v	-	v	v	v	v	v	v	v	v
	38	-	-	v	v	v	v	v	v	v	v	v	v	v	v
	41	-	-	v	v	v	v	v	v	v	v	v	v	v	v
	66	v	v	v	v	v	v	v	v	v	v	v	v	v	v
Peak-to-Average Ratio	2						v	v	v			v		v	
	4						v	v	v			v		v	
	5				v	-	-	v	v			v		v	
	7	-	-				v	v	v			v		v	
	12				v	-	-	v	v			v		v	
	13	-	-		v	-	-	v	v			v		v	
	26					v	-	v	v			v		v	
	38	-	-				v	v	v			v		v	
	41	-	-				v	v	v			v		v	
	66						v	v	v			v		v	





Test Items	Band	Bandwidth (MHz)						Modulation		RB #			Test Channel		
		1.4	3	5	10	15	20	QPSK	16QAM	1	Half	Full	L	M	H
26dB and 99% Bandwidth	2	v	v	v	v	v	v	v	v			v		v	
	4	v	v	v	v	v	v	v	v			v		v	
	5	v	v	v	v	-	-	v	v			v		v	
	7	-	-	v	v	v	v	v	v			v		v	
	12	v	v	v	v	-	-	v	v			v		v	
	13	-	-	v	v	-	-	v	v			v		v	
	26	v	v	v	v	v	-	v	v			v		v	
	38	-	-	v	v	v	v	v	v			v		v	
	41	-	-	v	v	v	v	v	v			v		v	
	66	v	v	v	v	v	v	v	v			v		v	
Conducted Band Edge	2	v	v	v	v	v	v	v	v	v		v	v		v
	4	v	v	v	v	v	v	v	v	v		v	v		v
	5	v	v	v	v	-	-	v	v	v		v	v		v
	7	-	-	v	v	v	v	v	v	v		v	v		v
	12	v	v	v	v	-	-	v	v	v		v	v		v
	13	-	-	v	v	-	-	v	v	v		v	v		v
	26	v	v	v	v	v	-	v	v	v		v	v		v
	38	-	-	v	v	v	v	v	v	v		v	v		v
	41	-	-	v	v	v	v	v	v	v		v	v		v
	66	v	v	v	v	v	v	v	v	v		v	v		v



Test Items	Band	Bandwidth (MHz)						Modulation		RB #			Test Channel		
		1.4	3	5	10	15	20	QPSK	16QAM	1	Half	Full	L	M	H
Conducted Spurious Emission	2	v	v	v	v	v	v	v	v	v			v	v	v
	4	v	v	v	v	v	v	v	v	v			v	v	v
	5	v	v	v	v	-	-	v	v	v			v	v	v
	7	-	-	v	v	v	v	v	v	v			v	v	v
	12	v	v	v	v	-	-	v	v	v			v	v	v
	13	-	-	v	v	-	-	v	v	v			v	v	v
	26	v	v	v	v	v	-	v	v	v			v	v	v
	38	-	-	v	v	v	v	v	v	v			v	v	v
	41	-	-	v	v	v	v	v	v	v			v	v	v
	66	v	v	v	v	v	v	v	v	v			v	v	v
Frequency Stability	2				v			v				v		v	
	4				v			v				v		v	
	5				v	-	-	v				v		v	
	7	-	-		v			v				v		v	
	12				v	-	-	v				v		v	
	13	-	-		v	-	-	v				v		v	
	26				v		-	v				v		v	
	38	-	-		v			v				v		v	
	41	-	-		v			v				v		v	
	66				v			v				v		v	



Test Items	Band	Bandwidth (MHz)						Modulation		RB #			Test Channel		
		1.4	3	5	10	15	20	QPSK	16QAM	1	Half	Full	L	M	H
E.R.P / E.I.R.P	2	v	v	v	v	v	v	v	v	Max. Power					
	4	v	v	v	v	v	v	v	v						
	5	v	v	v	v	-	-	v	v						
	7	-	-	v	v	v	v	v	v						
	12	v	v	v	v	-	-	v	v						
	13	-	-	v	v	-	-	v	v						
	26	v	v	v	v	v	-	v	v						
	38	-	-	v	v	v	v	v	v						
	41	-	-	v	v	v	v	v	v						
	66	v	v	v	v	v	v	v	v						
Radiated Spurious Emission	2	Worst Case										v	v	v	
	4	Covered by Band 66										v	v	v	
	5	Covered by Band 26										v	v	v	
	7	Worst Case										v	v	v	
	12	Worst Case										v	v	v	
	13	Worst Case										v	v	v	
	26	Worst Case										v	v	v	
	38	Worst Case										v	v	v	
	41	Worst Case										v	v	v	
	66	Worst Case										v	v	v	
Remark	<ol style="list-style-type: none"> <li>The mark "v " means that this configuration is chosen for testing</li> <li>The mark "- " means that this bandwidth is not supported.</li> <li>The device is investigated from 30MHz to 10 times of fundamental signal for radiated spurious emission test under different RB size/offset and modulations in exploratory test. Subsequently, only the worst case emissions are reported.</li> <li>LTE Band 4/Band 5 radiated spurious emission test were covered by Band 66/Band 26, respectively as LTE Band 66/Band 26 have same tune up/antenna gain but wider operating frequency range than LTE Band 4/Band 5.</li> <li>For Emission masks – In-band emission test, the single RB with the smallest BW will be the closest to the band edge limit, so only the smallest bandwidth of single RB is tested.</li> <li>All the radiated test cases were performed with AC Adapter.</li> <li>Wider operating range bandwidth covers narrower one when the power is higher or the same.</li> <li>One representative bandwidth is selected to perform PAR and frequency stability.</li> </ol>														

## 2.2 Connection Diagram of Test System

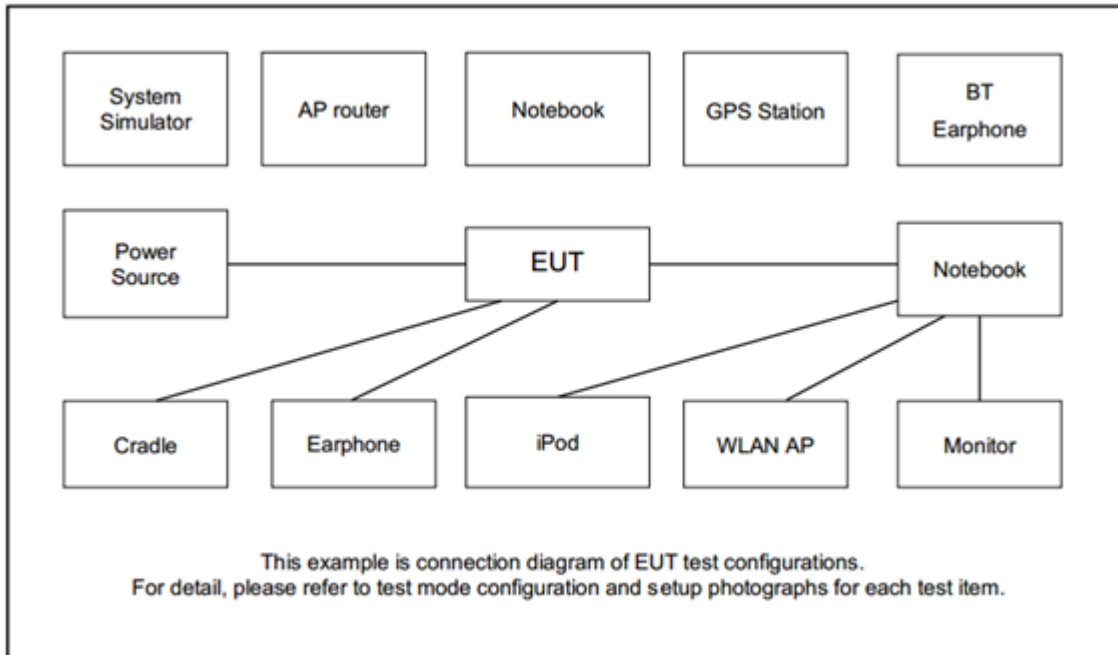

## 2.3 Support Unit used in test configuration and system

Item	Equipment	Brand Name	Model No.	FCC ID	Data Cable	Power Cord
1.	System Simulator	Anritsu	MT8821	N/A	N/A	Unshielded, 1.8 m

## 2.4 Measurement Results Explanation Example

### For all conducted test items:

The offset level is set in the spectrum analyzer to compensate the RF cable loss and attenuator factor between EUT conducted output port and spectrum analyzer. With the offset compensation, the spectrum analyzer reading level is exactly the EUT RF output level.

The spectrum analyzer offset is derived from RF cable loss and attenuator factor.

*Offset = RF cable loss + attenuator factor.*

Following shows an offset computation example with cable loss 4.2 dB and 10dB attenuator.

Example :

*Offset(dB) = RF cable loss(dB) + attenuator factor(dB).*

$$= 4.2 + 10 = 14.2 \text{ (dB)}$$



### 2.5 Frequency List of Low/Middle/High Channels

LTE Band 2 Channel and Frequency List				
BW [MHz]	Channel/Frequency(MHz)	Lowest	Middle	Highest
20	Channel	18700	18900	19100
	Frequency	1860	1880	1900
15	Channel	18675	18900	19125
	Frequency	1857.5	1880	1902.5
10	Channel	18650	18900	19150
	Frequency	1855	1880	1905
5	Channel	18625	18900	19175
	Frequency	1852.5	1880	1907.5
3	Channel	18615	18900	19185
	Frequency	1851.5	1880	1908.5
1.4	Channel	18607	18900	19193
	Frequency	1850.7	1880	1909.3

LTE Band 4 Channel and Frequency List				
BW [MHz]	Channel/Frequency(MHz)	Lowest	Middle	Highest
20	Channel	20050	20175	20300
	Frequency	1720	1732.5	1745
15	Channel	20025	20175	20325
	Frequency	1717.5	1732.5	1747.5
10	Channel	20000	20175	20350
	Frequency	1715	1732.5	1750
5	Channel	19975	20175	20375
	Frequency	1712.5	1732.5	1752.5
3	Channel	19965	20175	20385
	Frequency	1711.5	1732.5	1753.5
1.4	Channel	19957	20175	20393
	Frequency	1710.7	1732.5	1754.3



LTE Band 5 Channel and Frequency List				
BW [MHz]	Channel/Frequency(MHz)	Lowest	Middle	Highest
10	Channel	20450	20525	20600
	Frequency	829	836.5	844
5	Channel	20425	20525	20625
	Frequency	826.5	836.5	846.5
3	Channel	20415	20525	20635
	Frequency	825.5	836.5	847.5
1.4	Channel	20407	20525	20643
	Frequency	824.7	836.5	848.3

LTE Band 7 Channel and Frequency List				
BW [MHz]	Channel/Frequency(MHz)	Lowest	Middle	Highest
20	Channel	20850	21100	21350
	Frequency	2510	2535	2560
15	Channel	20825	21100	21375
	Frequency	2507.5	2535	2562.5
10	Channel	20800	21100	21400
	Frequency	2505	2535	2565
5	Channel	20775	21100	21425
	Frequency	2502.5	2535	2567.5

LTE Band 12 Channel and Frequency List				
BW [MHz]	Channel/Frequency(MHz)	Lowest	Middle	Highest
10	Channel	23060	23095	23130
	Frequency	704	707.5	711
5	Channel	23035	23095	23155
	Frequency	701.5	707.5	713.5
3	Channel	23025	23095	23165
	Frequency	700.5	707.5	714.5
1.4	Channel	23017	23095	23173
	Frequency	699.7	707.5	715.3



LTE Band 13 Channel and Frequency List				
BW [MHz]	Channel/Frequency(MHz)	Lowest	Middle	Highest
10	Channel	-	23230	-
	Frequency	-	782	-
5	Channel	23205	23230	23255
	Frequency	779.5	782	784.5

LTE Band 26 Channel and Frequency List				
BW [MHz]	Channel/Frequency(MHz)	Lowest	Middle	Highest
15	Channel	26865	26915	26965
	Frequency	831.5	836.5	841.5
10	Channel	26840	26915	26990
	Frequency	829.0	836.5	844.0
5	Channel	26815	26915	27015
	Frequency	826.5	836.5	846.5
3	Channel	26805	26915	27025
	Frequency	825.5	836.5	847.5
1.4	Channel	26797	26915	27033
	Frequency	824.7	836.5	848.3

LTE Band 38 Channel and Frequency List				
BW [MHz]	Channel/Frequency(MHz)	Lowest	Middle	Highest
20	Channel	37850	38000	38150
	Frequency	2580.0	2595.0	2610.0
15	Channel	37825	38000	38175
	Frequency	2577.5	2595.0	2612.5
10	Channel	37800	38000	38200
	Frequency	2575.0	2595.0	2615.0
5	Channel	37775	38000	38225
	Frequency	2572.5	2595.0	2617.5



LTE Band 41 Channel and Frequency List				
BW [MHz]	Channel/Frequency(MHz)	Lowest	Middle	Highest
20	Channel	39750	40620	41490
	Frequency	2506.0	2593.0	2680.0
15	Channel	39725	40620	41515
	Frequency	2503.5	2593.0	2682.5
10	Channel	39700	40620	41540
	Frequency	2501.0	2593.0	2685.0
5	Channel	39675	40620	41565
	Frequency	2498.5	2593.0	2687.5

LTE Band 66 Channel and Frequency List				
BW [MHz]	Channel/Frequency(MHz)	Lowest	Middle	Highest
20	Channel	132072	132322	132572
	Frequency	1720	1745	1770
15	Channel	132047	132322	132597
	Frequency	1717.5	1745	1772.5
10	Channel	132022	132322	132622
	Frequency	1715	1745	1775
5	Channel	131997	132322	132647
	Frequency	1712.5	1745	1777.5
3	Channel	131987	132322	132657
	Frequency	1711.5	1745	1778.5
1.4	Channel	131979	132322	132665
	Frequency	1710.7	1745	1779.3



### 3 Conducted Test Items

#### 3.1 Measuring Instruments

See list of measuring instruments of this test report.

##### 3.1.1 Test Setup

##### 3.1.2 Conducted Output Power

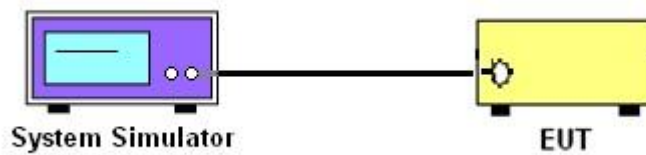

##### 3.1.3 Peak-to-Average Ratio, Occupied Bandwidth ,Conducted Band-Edge and Conducted Spurious Emission

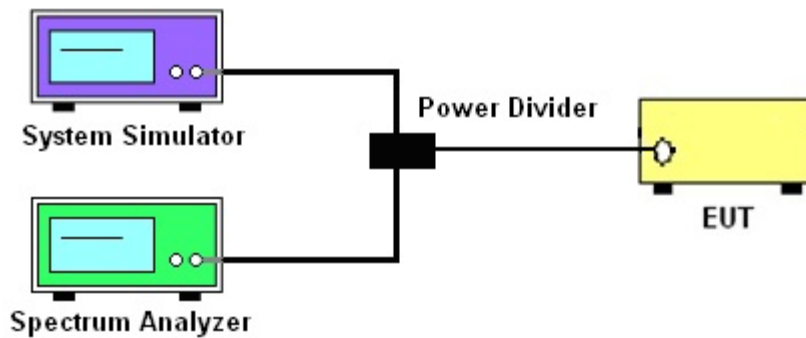

##### 3.1.4 Frequency Stability

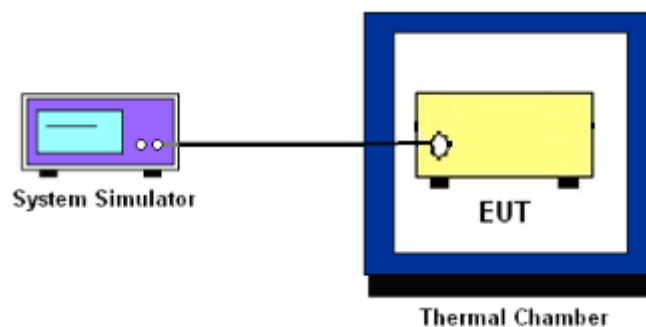

##### 3.1.5 Test Result of Conducted Test

Please refer to Appendix A.



## 3.2 Conducted Output Power and ERP/EIRP

### 3.2.1 Description of the Conducted Output Power Measurement and ERP/EIRP Measurement

A system simulator was used to establish communication with the EUT. Its parameters were set to force the EUT transmitting at maximum output power. The measured power in the radio frequency on the transmitter output terminals shall be reported.

The ERP of mobile transmitters must not exceed 7 Watts for LTE Band 5 and Band 26

The ERP of mobile transmitters must not exceed 3 Watts for LTE Band 12 and Band 13

The EIRP of mobile transmitters must not exceed 2 Watts for LTE Band 2 and Band 7 and Band 38 and Band 41

The EIRP of mobile transmitters must not exceed 1 Watts for LTE Band 4 and Band 66

According to KDB 412172 D01 Power Approach,

$EIRP = P_T + G_T - L_C$ ,  $ERP = EIRP - 2.15$ , where

$P_T$  = transmitter output power in dBm

$G_T$  = gain of the transmitting antenna in dBi

$L_C$  = signal attenuation in the connecting cable between the transmitter and antenna in dB

### 3.2.2 Test Procedures

1. The transmitter output port was connected to the system simulator.
2. Set EUT at maximum power through the system simulator.
3. Select lowest, middle, and highest channels for each band and different modulation.
4. Measure and record the power level from the system simulator.



## **3.3 Peak-to-Average Ratio**

### **3.3.1 Description of the PAR Measurement**

Power Complementary Cumulative Distribution Function (CCDF) curves provide a means for characterizing the power peaks of a digitally modulated signal on a statistical basis. A CCDF curve depicts the probability of the peak signal amplitude exceeding the average power level. Most contemporary measurement instrumentation include the capability to produce CCDF curves for an input signal provided that the instrument's resolution bandwidth can be set wide enough to accommodate the entire input signal bandwidth. In measuring transmissions in this band using an average power technique, the peak-to-average ratio (PAR) of the transmission may not exceed 13 dB.

### **3.3.2 Test Procedures**

The testing follows ANSI C63.26-2015 Section 5.2.6

1. The EUT was connected to spectrum and system simulator via a power divider.
2. Set the CCDF (Complementary Cumulative Distribution Function) option in spectrum analyzer.
3. The highest RF powers were measured and recorded the maximum PAPR level associated with a probability of 0.1 %.
4. Record the deviation as Peak to Average Ratio.



## 3.4 Occupied Bandwidth

### 3.4.1 Description of Occupied Bandwidth Measurement

The occupied bandwidth is the width of a frequency band such that, below the lower and above the upper frequency limits, the mean powers emitted are each equal to a specified percentage 0.5% of the total mean transmitted power.

The 26 dB emission bandwidth is defined as the frequency range between two points, one above and one below the carrier frequency, at which the spectral density of the emission is attenuated 26 dB below the maximum in-band spectral density of the modulated signal. Spectral density (power per unit bandwidth) is to be measured with a detector of resolution bandwidth equal to approximately 1.0% of the emission bandwidth.

### 3.4.2 Test Procedures

The testing follows ANSI C63.26-2015 Section 5.4.3 (26dB) and Section 5.4.4 (99OB)

1. The EUT was connected to spectrum analyzer and system simulator via a power divider.
2. The spectrum analyzer center frequency is set to the nominal EUT channel center frequency. The span range for the spectrum analyzer shall be between two and five times the anticipated OBW.
3. The nominal resolution bandwidth (RBW) shall be in the range of 1 to 5 % of the anticipated OBW, and the VBW shall be at least 3 times the RBW.
4. Set the detection mode to peak, and the trace mode to max hold.
5. Determine the reference value: Set the EUT to transmit a modulated signal. Allow the trace to stabilize. Set the spectrum analyzer marker to the highest level of the displayed trace.  
(this is the reference value)
6. Determine the “-26 dB down amplitude” as equal to (Reference Value – X).
7. Place two markers, one at the lowest and the other at the highest frequency of the envelope of the spectral display such that each marker is at or slightly below the “-X dB down amplitude” determined in step 6. If a marker is below this “-X dB down amplitude” value it shall be placed as close as possible to this value. The OBW is the positive frequency difference between the two markers.
8. Use the 99 % power bandwidth function of the spectrum analyzer and report the measured bandwidth.



## 3.5 Conducted Band Edge

### 3.5.1 Description of Conducted Band Edge Measurement

#### 22.917(a)

For operations in the 824 – 849 MHz band, the FCC limit is  $43 + 10\log_{10}(P[\text{Watts}])$  dB below the transmitter power  $P(\text{Watts})$  in a 100kHz bandwidth. However, in the 1MHz bands immediately outside and adjacent to the licensee's frequency block, a resolution bandwidth of at least one percent of the emission bandwidth of the fundamental emission of the transmitter may be employed.

#### 24.238 (a)

For operations in the 1850-1910 and 1930-1990 MHz band, the FCC limit is  $43 + 10\log_{10}(P[\text{Watts}])$  dB below the transmitter power  $P(\text{Watts})$  in a 1MHz bandwidth. However, in the 1 MHz bands immediately outside and adjacent to the frequency block a resolution bandwidth of at least one percent of the emission bandwidth of the fundamental emission of the transmitter may be employed.

#### 27.53 (c)

For operations in the 776-788 MHz band, the FCC limit is  $43 + 10\log_{10}(P[\text{Watts}])$  dB below the transmitter power  $P(\text{Watts})$  in a 100 kHz bandwidth. However, in the 100 kHz bands immediately outside and adjacent to the frequency block, a resolution bandwidth of at least 30 kHz may be employed. In addition, the power of any unwanted emissions in any 6.25 kHz bandwidth for all frequencies between 763-775 MHz and 793-806 MHz shall be attenuated below the transmitter power,  $P$  (dBW), by at least  $65 + 10 \log_{10} p(\text{watts})$ , dB, for mobile and portable equipment.

#### 27.53 (g)

For operations in the 600MHz band and 698-746 MHz band, the FCC limit is  $43 + 10\log_{10}(P[\text{Watts}])$  dB below the transmitter power  $P(\text{Watts})$  in a 100 kHz bandwidth. However, in the 100 kilohertz bands immediately outside and adjacent to a licensee's frequency block, a resolution bandwidth of at least 30 kHz may be employed.

#### 27.53 (h)

For operations in the 1710 – 1755 MHz band, 1755-1780 MHz, the FCC limit is  $43 + 10\log_{10}(P[\text{Watts}])$  dB below the transmitter power  $P(\text{Watts})$  in a 1 MHz bandwidth. However, in the 1MHz bands immediately outside and adjacent to the licensee's frequency block, a resolution bandwidth of at least one percent of the emission bandwidth of the fundamental emission of the transmitter may be employed.

**27.53(m)(4)**

For mobile digital stations, the attenuation factor shall be not less than  $40 + 10 \log (P)$  dB on all frequencies between the channel edge and 5 megahertz from the channel edge,  $43 + 10 \log (P)$  dB on all frequencies between 5 megahertz and X megahertz from the channel edge, and  $55 + 10 \log (P)$  dB on all frequencies more than X megahertz from the channel edge, where X is the greater of 6 megahertz or the actual emission bandwidth as defined in paragraph (m)(6) of this section. In addition, the attenuation factor shall not be less that  $43 + 10 \log (P)$  dB on all frequencies between 2490.5 MHz and 2496 MHz and  $55 + 10 \log (P)$  dB at or below 2490.5 MHz. Mobile Satellite Service licensees operating on frequencies below 2495 MHz may also submit a documented interference complaint against BRS licensees operating on channel BRS Channel 1 on the same terms and conditions as adjacent channel BRS or EBS licensees.

**3.5.2 Test Procedures**

The testing follows FCC KDB 971168 D01 v03r01 Section 6.1.

1. The EUT was connected to spectrum analyzer and system simulator via a power divider.
2. The band edges of low and high channels for the highest RF powers were measured.
3. Set RBW  $\geq$  1% EBW in the 1MHz band immediately outside and adjacent to the band edge.
4. Beyond the 1 MHz band from the band edge, RBW=1MHz was used.
5. Set spectrum analyzer with RMS detector.
6. The RF fundamental frequency should be excluded against the limit line in the operating frequency band.
7. Checked that all the results comply with the emission limit line.

The limit line is derived from  $43 + 10\log(P)$ dB below the transmitter power P(Watts)

For LTE Band 7, 38, 41

The other 40 dB, and 55 dB have additionally applied same calculation above.



## 3.6 Conducted Spurious Emission

### 3.6.1 Description of Conducted Spurious Emission Measurement

The power of any emission outside of the authorized operating frequency ranges must be lower than the transmitter power (P) by a factor of at least  $43 + 10 \log (P)$  dB.

For LTE Band 7, 38, 41

The power of any emission outside of the authorized operating frequency ranges must be lower than the transmitter power (P) by a factor of at least  $55 + 10 \log (P)$  dB.

It is measured by means of a calibrated spectrum analyzer and scanned from 30 MHz up to a frequency including its 10<sup>th</sup> harmonic.

### 3.6.2 Test Procedures

The testing follows FCC KDB 971168 D01 v03r01 Section 6.1.

1. The EUT was connected to spectrum analyzer and system simulator via a power divider.
2. The RF output of EUT was connected to the spectrum analyzer by RF cable and attenuator.  
The path loss was compensated to the results for each measurement.
3. The middle channel for the highest RF power within the transmitting frequency was measured.
4. The conducted spurious emission for the whole frequency range was taken.
5. Make the measurement with the spectrum analyzer's RBW = 1MHz, VBW = 3MHz.
6. Set spectrum analyzer with RMS detector.
7. Taking the record of maximum spurious emission.
8. The RF fundamental frequency should be excluded against the limit line in the operating frequency band.
9. The limit line is derived from  $43 + 10\log(P)$ dB below the transmitter power P(Watts)  
For LTE Band 7, 38, 41  
The limit line is derived from  $55 + 10\log(P)$ dB below the transmitter power P(Watts)



## **3.7 Frequency Stability**

### **3.7.1 Description of Frequency Stability Measurement**

22.355

The frequency stability shall be measured by variation of ambient temperature and variation of primary supply voltage to ensure that the fundamental emission stays within the authorized frequency block. The frequency stability of the transmitter shall be maintained within  $\pm 0.00025\%$  ( $\pm 2.5\text{ppm}$ ) of the center frequency.

24.235 & 27.54

The frequency stability shall be sufficient to ensure that the fundamental emission stays within the authorized frequency block.

### **3.7.2 Test Procedures for Temperature Variation**

The testing follows FCC KDB 971168 D01 v03r01 Section 9.0.

1. The EUT was set up in the thermal chamber and connected with the system simulator.
2. With power OFF, the temperature was decreased to  $-30^{\circ}\text{C}$  and the EUT was stabilized before testing. Power was applied and the maximum change in frequency was recorded within one minute.
3. With power OFF, the temperature was raised in  $10^{\circ}\text{C}$  step up to  $50^{\circ}\text{C}$ . The EUT was stabilized at each step for at least half an hour. Power was applied and the maximum frequency change was recorded within one minute.

### **3.7.3 Test Procedures for Voltage Variation**

The testing follows FCC KDB 971168 D01 v03r01 Section 9.0.

1. The EUT was placed in a temperature chamber at  $20\pm 5^{\circ}\text{C}$  and connected with the system simulator.
2. The power supply voltage to the EUT was varied from 85% to 115% of the nominal value measured at the input to the EUT.
3. The variation in frequency was measured for the worst case.



## 4 Radiated Test Items

### 4.1 Measuring Instruments

See list of measuring instruments of this test report.

#### 4.1.1 Test Setup

For radiated test below 30MHz

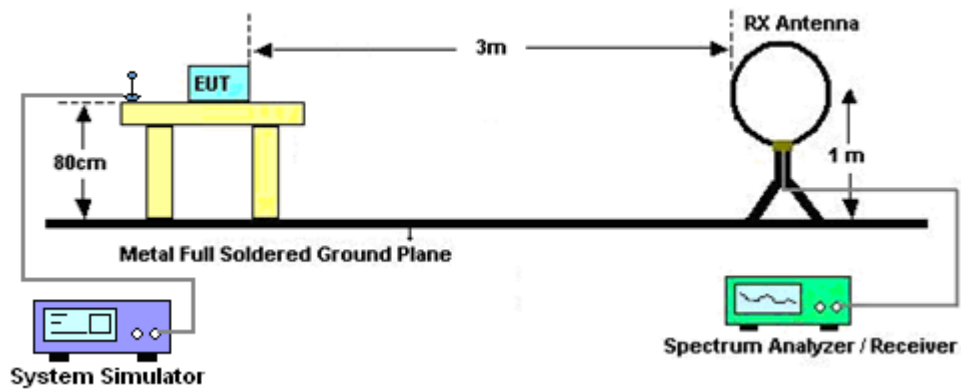

For radiated test from 30MHz to 1GHz

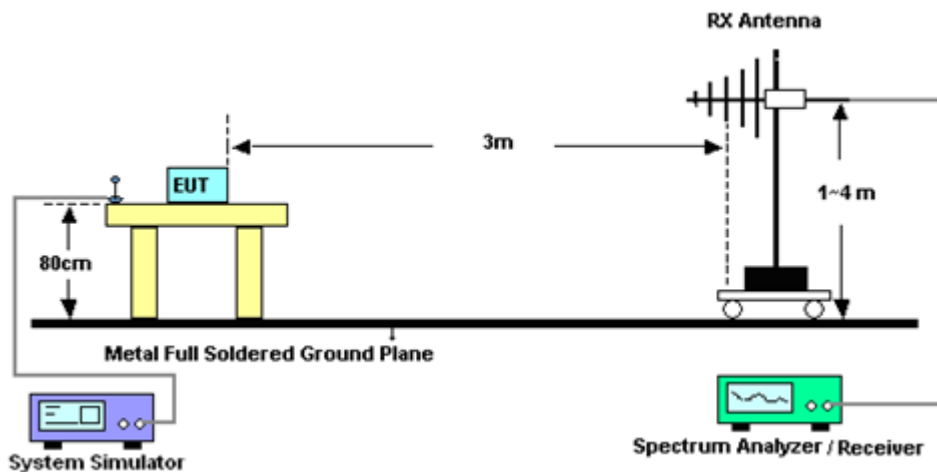

For radiated test from 1GHz to 18GHz

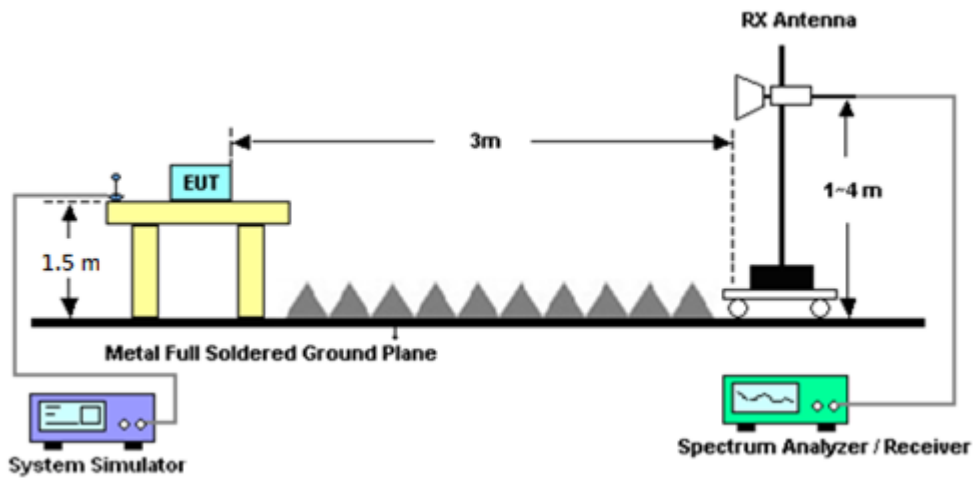

For radiated test above 18GHz

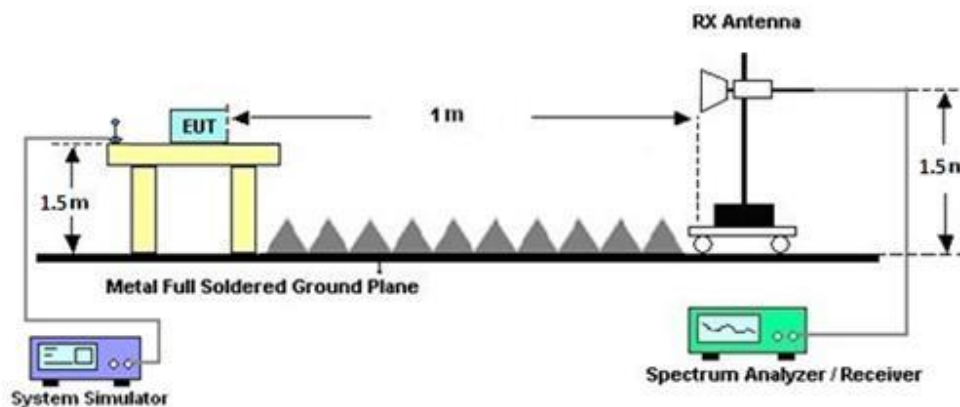

#### 4.1.2 Test Result of Radiated Test

Please refer to Appendix B.

**Note:**

The low frequency, which started from 9 kHz to 30MHz, was pre-scanned and the result which was 20dB lower than the limit line was not reported.

There is adequate comparison measurement of both open-field test site and alternative test site - semi-Anechoic chamber according to 414788 D01 Radiated Test Site v01r01, and the result came out very similar.



## **4.2 Radiated Spurious Emission Measurement**

### **4.2.1 Description of Radiated Spurious Emission Measurement**

The radiated spurious emission was measured by substitution method according to ANSI / TIA-603-E. The power of any emission outside of the authorized operating frequency ranges must be attenuated below the transmitter power (P) by a factor of at least  $43 + 10 \log (P)$  dB.

For LTE Band 7, 38, 41

The power of any emission outside of the authorized operating frequency ranges must be attenuated below the transmitter power (P) by a factor of at least  $55 + 10 \log (P)$  dB.

For LTE Band 13

For operations in the 746-758 MHz, 775-788 MHz, and 805-806 MHz bands, emissions in the band 1559-1610 MHz shall be limited to  $-70$  dBW/MHz equivalent isotropically radiated power (EIRP) for wideband signals, and  $-80$  dBW EIRP for discrete emissions of less than 700 Hz bandwidth.

The spectrum is scanned from 30 MHz up to a frequency including its 10th harmonic.

### **4.2.2 Test Procedures**

The testing follows FCC KDB 971168 D01 v03r01 Section 7 and ANSI / TIA-603-E Section 2.2.12.

1. The EUT was placed on a turntable with 0.8 meter for frequency below 1GHz and 1.5 meter for frequency above 1GHz respectively above ground.
2. The EUT was set 3 meters from the receiving antenna, which was mounted on the antenna tower.
3. The table was rotated 360 degrees to determine the position of the highest spurious emission.
4. The height of the receiving antenna is varied between one meter and four meters to search the maximum spurious emission for both horizontal and vertical polarizations.
5. Make the measurement with the spectrum analyzer's RBW = 1MHz, VBW = 3MHz, taking the record of maximum spurious emission.
6. A horn antenna was substituted in place of the EUT and was driven by a signal generator.
7. Tune the output power of signal generator to the same emission level with EUT maximum spurious emission.
8. Taking the record of output power at antenna port.
9. Repeat step 7 to step 8 for another polarization.
10. The RF fundamental frequency should be excluded against the limit line in the operating frequency band.

The limit line is derived from  $43 + 10\log(P)$ dB below the transmitter power P(Watts)

For LTE Band 7, 38, 41

The limit line is derived from  $55 + 10\log(P)$ dB below the transmitter power P(Watts)

$EIRP \text{ (dBm)} = S.G. \text{ Power} - Tx \text{ Cable Loss} + Tx \text{ Antenna Gain}$

$ERP \text{ (dBm)} = EIRP - 2.15$



## 5 List of Measuring Equipment

Instrument	Brand Name	Model No.	Serial No.	Characteristics	Calibration Date	Test Date	Due Date	Remark
Bilog Antenna	TESEQ	CBL 6111D & 00800N1D01N-06	35419 & 03	30MHz~1GHz	Apr. 23, 2023	Aug. 08, 2023~ Aug. 12, 2023	Apr. 22, 2024	Radiation (03CH07-HY)
Double Ridge Horn Antenna	ESCO	3117	00075962	1GHz ~ 18GHz	Dec. 01, 2022	Aug. 08, 2023~ Aug. 12, 2023	Nov. 30, 2023	Radiation (03CH07-HY)
Preamplifier	MITEQ	AMF-7D-0010 1800-30-10P	1590075	1GHz~18GHz	Apr. 20, 2023	Aug. 08, 2023~ Aug. 12, 2023	Apr. 19, 2024	Radiation (03CH07-HY)
Preamplifier	COM-POWER	PA-103A	161241	10MHz~1GHz	Oct. 03, 2022	Aug. 08, 2023~ Aug. 12, 2023	Oct. 02, 2023	Radiation (03CH07-HY)
Preamplifier	Agilent	8449B	3008A02362	1GHz~26.5GHz	Mar. 24, 2023	Aug. 08, 2023~ Aug. 12, 2023	Mar. 23, 2024	Radiation (03CH07-HY)
Preamplifier	EMEC	EM18G40G	0600789	18-40GHz	Jul. 25, 2023	Aug. 08, 2023~ Aug. 12, 2023	Jul. 24, 2024	Radiation (03CH07-HY)
Spectrum Analyzer	Agilent	N9030A	MY52350276	3Hz~44GHz	Mar. 28, 2023	Aug. 08, 2023~ Aug. 12, 2023	Mar. 27, 2024	Radiation (03CH07-HY)
RF Cable	HUBER + SUHNER	SUCOFLEX 104	MY15682/4	30MHz to 18GHz	Feb. 22, 2023	Aug. 08, 2023~ Aug. 12, 2023	Feb. 21, 2024	Radiation (03CH07-HY)
RF Cable	HUBER + SUHNER	SUCOFLEX 104	MY24971/4	9kHz to 18GHz	Feb. 22, 2023	Aug. 08, 2023~ Aug. 12, 2023	Feb. 21, 2024	Radiation (03CH07-HY)
RF Cable	HUBER + SUHNER	SUCOFLEX 104	MY28655/4	9kHz to 18GHz	Feb. 22, 2023	Aug. 08, 2023~ Aug. 12, 2023	Feb. 21, 2024	Radiation (03CH07-HY)
RF Cable	HUBER + SUHNER	SUCOFLEX 102	MY2858/2	18GHz~40GHz	Feb. 22, 2023	Aug. 08, 2023~ Aug. 12, 2023	Feb. 21, 2024	Radiation (03CH07-HY)
RF Cable	HUBER + SUHNER	SUCOFLEX 102	801606/2	9KHz ~ 40GHz	Apr. 20, 2023	Aug. 08, 2023~ Aug. 12, 2023	Apr. 19, 2024	Radiation (03CH07-HY)
Controller	EMEC	EM1000	N/A	Control Ant Mast	N/A	Aug. 08, 2023~ Aug. 12, 2023	N/A	Radiation (03CH07-HY)
Controller	MF	MF-7802	N/A	Control Turn table	N/A	Aug. 08, 2023~ Aug. 12, 2023	N/A	Radiation (03CH07-HY)
Antenna Mast	EMEC	AM-BS-4500E	N/A	Boresight mast 1M~4M	N/A	Aug. 08, 2023~ Aug. 12, 2023	N/A	Radiation (03CH07-HY)
Turn Table	ChainTek	Chaintek 3000	N/A	0~360 Degree	N/A	Aug. 08, 2023~ Aug. 12, 2023	N/A	Radiation (03CH07-HY)
Software	Audix	E3	N/A	N/A	N/A	Aug. 08, 2023~ Aug. 12, 2023	N/A	Radiation (03CH07-HY)
USB Data Logger	TECPEL	TR-32	HE17XB2495	N/A	Mar. 14, 2023	Aug. 08, 2023~ Aug. 12, 2023	Mar. 13, 2024	Radiation (03CH07-HY)
Horn Antenna	ETS-Lindgren	3117	00143261	1GHz~18GHz	Feb. 24, 2023	Aug. 08, 2023~ Aug. 12, 2023	Feb. 23, 2024	Radiation (03CH07-HY)
SHF-EHF Horn Antenna	SCHWARZBECK	BBHA 9170	BBHA9170251	18GHz~40GHz	Nov. 24, 2022	Aug. 08, 2023~ Aug. 12, 2023	Nov. 23, 2023	Radiation (03CH07-HY)
Signal Generator	Rohde & Schwarz	SMF100A	101107	100kHz~40GHz	Jan. 11, 2023	Aug. 08, 2023~ Aug. 12, 2023	Jan. 10, 2024	Radiation (03CH07-HY)
Radio Communication Analyzer	Anritsu	MT8821C	6262025353	LTE FDD/TDD LTE-2CC DLCA/ULCA	Oct. 13, 2022	Aug. 24, 2023~ Sep. 05, 2023	Oct. 12, 2023	Conducted (TH03-HY)
Spectrum Analyzer	Rohde & Schwarz	FSV40	101908	10Hz~40GHz	Sep. 27, 2022	Aug. 24, 2023~ Sep. 05, 2023	Sep. 26, 2023	Conducted (TH03-HY)
Thermal Chamber	ESPEC	SH-641	92013720	-40℃ ~90℃	Sep. 07, 2022	Aug. 24, 2023~ Sep. 05, 2023	Sep. 06, 2023	Conducted (TH03-HY)
DC Power Supply	GW Instek	GPP-2323	GES906037	0V~64V ; 0A~6A	Dec. 29, 2022	Aug. 24, 2023~ Sep. 05, 2023	Dec. 28, 2023	Conducted (TH03-HY)
Coupler	Warison	20dB 25W SMA Directional Coupler	#B	1-18GHz	Jan. 06, 2023	Aug. 24, 2023~ Sep. 05, 2023	Jan. 05, 2024	Conducted (TH03-HY)



## 6 Measurement Uncertainty

### Uncertainty of Radiated Emission Measurement (30 MHz ~ 1000 MHz)

Measuring Uncertainty for a Level of Confidence of 95% ( $U = 2Uc(y)$ )	3.46 dB
---	---------

### Uncertainty of Radiated Emission Measurement (1 GHz ~ 18 GHz)

Measuring Uncertainty for a Level of Confidence of 95% ( $U = 2Uc(y)$ )	3.33 dB
---	---------

### Uncertainty of Radiated Emission Measurement (18 GHz ~ 40 GHz)

Measuring Uncertainty for a Level of Confidence of 95% ( $U = 2Uc(y)$ )	3.91 dB
---	---------



## Appendix A. Test Results of Conducted Test

### Conducted Output Power(Average power & ERP/EIRP)

LTE Band 2 Maximum Average Power [dBm] (GT - LC = 2.03 dB)								
BW [MHz]	RB Size	RB Offset	Mod	Lowest	Middle	Highest	EIRP (dBm)	EIRP (W)
20	1	0	QPSK	22.69	22.70	22.43	24.99	0.3155
20	1	49		22.83	22.96	22.83		
20	1	99		22.50	22.50	22.60		
20	50	0		21.87	21.97	21.67		
20	50	24		21.76	21.90	21.58		
20	50	50		21.82	21.89	21.67		
20	100	0		21.73	21.84	21.61		
20	1	0	16-QAM	21.80	21.96	21.54	24.43	0.2773
20	1	13		21.93	21.94	22.01		
20	1	26		22.11	22.15	22.31		
20	12	0		22.36	22.20	22.35		
20	12	7		22.37	22.33	22.22		
20	12	15		22.39	22.27	22.40		
20	27	0		21.21	21.22	21.21		
Limit	EIRP < 2W			Result			Pass	

LTE Band 2 Maximum Average Power [dBm] (GT - LC = 2.03 dB)								
BW [MHz]	RB Size	RB Offset	Mod	Lowest	Middle	Highest	EIRP (dBm)	EIRP (W)
15	1	0	QPSK	22.81	22.77	22.68	24.98	0.3148
15	1	37		22.68	22.95	22.91		
15	1	74		22.65	22.79	22.61		
15	36	0		21.86	21.89	21.57		
15	36	20		21.80	21.95	21.64		
15	36	39		21.85	21.88	21.59		
15	75	0		21.88	21.83	21.49		
15	1	0	16-QAM	21.99	22.00	21.53	24.56	0.2858
15	1	13		21.74	21.77	21.88		
15	1	26		22.31	22.09	22.13		
15	12	0		22.45	22.19	22.53		
15	12	7		22.48	22.24	22.34		
15	12	15		22.49	22.36	22.27		
15	27	0		21.02	21.32	21.04		
Limit	EIRP < 2W			Result			Pass	



LTE Band 2 Maximum Average Power [dBm] (GT - LC = 2.03 dB)								
BW [MHz]	RB Size	RB Offset	Mod	Lowest	Middle	Highest	EIRP (dBm)	EIRP (W)
10	1	0	QPSK	22.56	22.70	22.60	24.75	0.2985
10	1	25		22.52	22.72	22.61		
10	1	49		22.42	22.60	22.48		
10	25	0		21.39	21.54	21.42		
10	25	12		21.40	21.57	21.47		
10	25	25		21.38	21.55	21.43		
10	50	0		21.40	21.50	21.38		
10	1	0	16-QAM	21.78	21.94	21.44	24.38	0.2742
10	1	13		21.87	21.84	21.97		
10	1	26		22.09	22.09	22.23		
10	12	0		22.35	22.19	22.25		
10	12	7		22.34	22.24	22.17		
10	12	15		22.32	22.21	22.32		
10	27	0		21.16	21.18	21.17		
Limit	EIRP < 2W			Result			Pass	

LTE Band 2 Maximum Average Power [dBm] (GT - LC = 2.03 dB)								
BW [MHz]	RB Size	RB Offset	Mod	Lowest	Middle	Highest	EIRP (dBm)	EIRP (W)
5	1	0	QPSK	22.85	22.70	22.70	24.94	0.3119
5	1	12		22.83	22.91	22.61		
5	1	24		22.42	22.63	22.29		
5	12	0		21.85	21.76	21.44		
5	12	7		21.75	21.79	21.51		
5	12	13		21.66	21.75	21.41		
5	25	0		21.70	21.75	21.50		
5	1	0	16-QAM	21.70	21.95	21.46	24.38	0.2742
5	1	12		21.91	21.88	22.00		
5	1	24		22.11	22.10	22.24		
5	12	0		22.31	22.15	22.29		
5	12	7		22.33	22.30	22.16		
5	12	13		22.35	22.18	22.30		
5	25	0		21.19	21.18	21.11		
Limit	EIRP < 2W			Result			Pass	



LTE Band 2 Maximum Average Power [dBm] (GT - LC = 2.03 dB)								
BW [MHz]	RB Size	RB Offset	Mod	Lowest	Middle	Highest	EIRP (dBm)	EIRP (W)
3	1	0	QPSK	22.91	22.85	22.47	24.94	0.3119
3	1	8		22.59	22.68	22.24		
3	1	14		22.60	22.64	22.36		
3	8	0		21.84	21.89	21.57		
3	8	4		21.76	21.90	21.51		
3	8	7		21.74	21.98	21.56		
3	15	0		21.82	21.83	21.53		
3	1	0	16-QAM	21.75	21.95	21.49	24.39	0.2748
3	1	8		21.85	21.87	21.96		
3	1	14		22.06	22.07	22.25		
3	8	0		22.35	22.16	22.34		
3	8	4		22.35	22.32	22.14		
3	8	7		22.32	22.19	22.36		
3	15	0		21.14	21.17	21.16		
Limit	EIRP < 2W			Result			Pass	

LTE Band 2 Maximum Average Power [dBm] (GT - LC = 2.03 dB)								
BW [MHz]	RB Size	RB Offset	Mod	Lowest	Middle	Highest	EIRP (dBm)	EIRP (W)
1.4	1	0	QPSK	22.76	22.86	22.54	24.94	0.3119
1.4	1	3		22.81	22.90	22.64		
1.4	1	5		22.68	22.70	22.41		
1.4	3	0		22.90	22.79	22.62		
1.4	3	1		22.91	22.87	22.67		
1.4	3	3		22.71	22.89	22.63		
1.4	6	0		21.85	21.92	21.55		
1.4	1	0	16-QAM	21.78	21.93	21.50	24.41	0.2761
1.4	1	3		21.91	21.93	21.98		
1.4	1	5		22.10	22.07	22.26		
1.4	3	0		22.35	22.10	22.35		
1.4	3	1		22.37	22.24	22.14		
1.4	3	3		22.29	22.23	22.38		
1.4	6	0		21.18	21.16	21.19		
Limit	EIRP < 2W			Result			Pass	





LTE Band 4 Maximum Average Power [dBm] (GT - LC = 2.21 dB)								
BW [MHz]	RB Size	RB Offset	Mod	Lowest	Middle	Highest	EIRP (dBm)	EIRP (W)
20	1	0	QPSK	23.04	23.45	23.37	25.66	0.3681
20	1	49		22.98	23.44	23.36		
20	1	99		22.76	23.11	23.36		
20	50	0		22.11	22.44	22.40		
20	50	24		22.02	22.10	22.31		
20	50	50		22.07	22.18	22.39		
20	100	0		22.07	22.48	22.42		
20	1	0	16-QAM	22.03	22.01	22.38	24.59	0.2877
20	1	13		21.46	21.50	21.41		
20	1	26		21.50	21.56	21.46		
20	12	0		21.23	21.27	21.18		
20	12	7		21.61	21.66	21.56		
20	12	15		21.66	21.73	21.67		
20	27	0		20.53	20.52	20.54		
Limit	EIRP < 1W			Result			Pass	

LTE Band 4 Maximum Average Power [dBm] (GT - LC = 2.21 dB)								
BW [MHz]	RB Size	RB Offset	Mod	Lowest	Middle	Highest	EIRP (dBm)	EIRP (W)
15	1	0	QPSK	22.74	23.01	23.42	25.63	0.3656
15	1	37		22.84	23.25	23.36		
15	1	74		22.94	23.10	23.40		
15	36	0		21.77	22.03	22.36		
15	36	20		21.79	22.09	22.47		
15	36	39		21.87	22.15	22.53		
15	75	0		21.77	22.06	22.24		
15	1	0	16-QAM	21.95	21.98	22.36	24.57	0.2864
15	1	13		21.36	21.40	21.40		
15	1	26		21.47	21.47	21.36		
15	12	0		21.21	21.27	21.12		
15	12	7		21.60	21.59	21.46		
15	12	15		21.61	21.67	21.64		
15	27	0		20.55	20.51	20.58		
Limit	EIRP < 1W			Result			Pass	



LTE Band 4 Maximum Average Power [dBm] (GT - LC = 2.21 dB)								
BW [MHz]	RB Size	RB Offset	Mod	Lowest	Middle	Highest	EIRP (dBm)	EIRP (W)
10	1	0	QPSK	23.07	22.78	23.29	25.50	0.3548
10	1	25		22.87	23.10	23.28		
10	1	49		22.57	22.85	23.24		
10	25	0		21.68	22.01	22.40		
10	25	12		21.75	21.93	22.41		
10	25	25		21.67	22.07	22.36		
10	50	0		21.75	22.07	22.40		
10	1	0	16-QAM	22.01	21.99	22.35	24.56	0.2858
10	1	13		21.41	21.49	21.41		
10	1	26		21.47	21.52	21.42		
10	12	0		21.14	21.19	21.16		
10	12	7		21.51	21.64	21.53		
10	12	15		21.63	21.67	21.62		
10	27	0		20.50	20.52	20.54		
Limit	EIRP < 1W			Result			Pass	

LTE Band 4 Maximum Average Power [dBm] (GT - LC = 2.21 dB)								
BW [MHz]	RB Size	RB Offset	Mod	Lowest	Middle	Highest	EIRP (dBm)	EIRP (W)
5	1	0	QPSK	22.55	22.75	23.24	25.57	0.3606
5	1	12		22.71	22.99	23.36		
5	1	24		22.61	22.67	23.26		
5	12	0		21.53	21.73	22.34		
5	12	7		21.54	21.93	22.29		
5	12	13		21.55	21.85	22.28		
5	25	0		21.50	21.83	22.34		
5	1	0	16-QAM	21.93	21.94	22.30	24.51	0.2825
5	1	12		21.38	21.44	21.37		
5	1	24		21.49	21.49	21.44		
5	12	0		21.23	21.25	21.17		
5	12	7		21.59	21.58	21.54		
5	12	13		21.64	21.67	21.60		
5	25	0		20.56	20.53	20.50		
Limit	EIRP < 1W			Result			Pass	



LTE Band 4 Maximum Average Power [dBm] (GT - LC = 2.21 dB)								
BW [MHz]	RB Size	RB Offset	Mod	Lowest	Middle	Highest	EIRP (dBm)	EIRP (W)
3	1	0	QPSK	23.03	23.37	23.26	25.60	0.3631
3	1	8		22.89	23.20	23.39		
3	1	14		22.99	23.00	23.22		
3	8	0		21.87	22.23	22.38		
3	8	4		21.77	22.30	22.38		
3	8	7		21.72	22.25	22.40		
3	15	0		21.73	22.27	22.30		
3	1	0	16-QAM	21.97	21.99	22.35	24.56	0.2858
3	1	8		21.39	21.48	21.34		
3	1	14		21.41	21.52	21.39		
3	8	0		21.21	21.22	21.15		
3	8	4		21.58	21.59	21.47		
3	8	7		21.59	21.72	21.62		
3	15	0		20.51	20.55	20.53		
Limit	EIRP < 1W			Result			Pass	

LTE Band 4 Maximum Average Power [dBm] (GT - LC = 2.21 dB)								
BW [MHz]	RB Size	RB Offset	Mod	Lowest	Middle	Highest	EIRP (dBm)	EIRP (W)
1.4	1	0	QPSK	22.51	22.89	23.15	25.49	0.3540
1.4	1	3		22.59	23.01	23.06		
1.4	1	5		22.53	22.94	23.03		
1.4	3	0		22.52	23.03	23.21		
1.4	3	1		22.61	23.12	23.27		
1.4	3	3		22.61	23.09	23.28		
1.4	6	0		21.67	22.08	22.08		
1.4	1	0	16-QAM	21.98	21.92	22.33	24.54	0.2844
1.4	1	3		21.44	21.45	21.38		
1.4	1	5		21.45	21.47	21.36		
1.4	3	0		21.19	21.20	21.18		
1.4	3	1		21.58	21.58	21.49		
1.4	3	3		21.57	21.68	21.60		
1.4	6	0		20.53	20.53	20.54		
Limit	EIRP < 1W			Result			Pass	



LTE Band 5 Maximum Average Power [dBm] (GT - LC = 0.43 dB)								
BW [MHz]	RB Size	RB Offset	Mod	Lowest	Middle	Highest	ERP (dBm)	ERP (W)
10	1	0	QPSK	22.44	22.97	22.81	21.25	0.1334
10	1	25		22.87	22.87	22.88		
10	1	49		22.61	22.48	22.56		
10	25	0		21.90	21.95	21.86		
10	25	12		21.86	21.91	21.83		
10	25	25		21.89	21.83	21.85		
10	50	0		21.79	21.85	21.72		
10	1	0	16-QAM	21.52	21.65	21.45	20.20	0.1047
10	1	13		21.60	21.80	21.65		
10	1	26		21.47	21.67	21.49		
10	12	0		21.57	21.69	21.55		
10	12	7		21.71	21.91	21.71		
10	12	15		21.75	21.92	21.78		
10	27	0		20.88	21.07	20.92		
Limit	ERP < 7W			Result			Pass	

LTE Band 5 Maximum Average Power [dBm] (GT - LC = 0.43 dB)								
BW [MHz]	RB Size	RB Offset	Mod	Lowest	Middle	Highest	ERP (dBm)	ERP (W)
5	1	0	QPSK	22.13	22.54	22.38	21.01	0.1262
5	1	12		22.51	22.69	22.73		
5	1	24		22.44	22.48	22.09		
5	12	0		21.30	21.53	21.52		
5	12	7		21.45	21.42	21.54		
5	12	13		21.44	21.42	21.45		
5	25	0		21.33	21.49	21.49		
5	1	0	16-QAM	21.42	21.53	21.37	19.81	0.0957
5	1	12		21.17	21.37	21.21		
5	1	24		21.16	21.35	21.24		
5	12	0		20.67	20.82	20.68		
5	12	7		20.78	20.90	20.70		
5	12	13		20.61	20.79	20.68		
5	25	0		20.56	20.73	20.55		
Limit	ERP < 7W			Result			Pass	



LTE Band 5 Maximum Average Power [dBm] (GT - LC = 0.43 dB)								
BW [MHz]	RB Size	RB Offset	Mod	Lowest	Middle	Highest	ERP (dBm)	ERP (W)
3	1	0	QPSK	22.91	22.89	22.84	21.21	0.1321
3	1	8		22.93	22.86	22.82		
3	1	14		22.90	22.85	22.67		
3	8	0		21.96	21.95	21.95		
3	8	4		21.96	21.94	21.96		
3	8	7		21.99	22.00	21.93		
3	15	0		21.94	21.99	21.88		
3	1	0	16-QAM	21.78	21.94	21.81	20.22	0.1052
3	1	8		21.59	21.75	21.60		
3	1	14		21.68	21.88	21.76		
3	8	0		20.89	21.07	20.94		
3	8	4		21.04	21.14	21.02		
3	8	7		20.86	20.99	20.80		
3	15	0		20.57	20.74	20.58		
Limit	ERP < 7W			Result			Pass	

LTE Band 5 Maximum Average Power [dBm] (GT - LC = 0.43 dB)								
BW [MHz]	RB Size	RB Offset	Mod	Lowest	Middle	Highest	ERP (dBm)	ERP (W)
1.4	1	0	QPSK	22.28	22.53	22.44	20.93	0.1239
1.4	1	3		22.34	22.47	22.34		
1.4	1	5		22.15	22.38	22.44		
1.4	3	0		22.33	22.51	22.65		
1.4	3	1		22.37	22.56	22.55		
1.4	3	3		22.31	22.52	22.53		
1.4	6	0		21.47	21.57	21.56		
1.4	1	0	16-QAM	21.75	21.92	21.75	20.27	0.1064
1.4	1	3		21.83	21.95	21.83		
1.4	1	5		21.70	21.81	21.65		
1.4	3	0		21.66	21.85	21.66		
1.4	3	1		21.86	21.99	21.86		
1.4	3	3		21.65	21.85	21.65		
1.4	6	0		20.77	20.95	20.77		
Limit	ERP < 7W			Result			Pass	



LTE Band 7 Maximum Average Power [dBm] (GT - LC = -0.64 dB)								
BW [MHz]	RB Size	RB Offset	Mod	Lowest	Middle	Highest	EIRP (dBm)	EIRP (W)
20	1	0	QPSK	23.56	23.62	23.69	23.71	0.2350
20	1	49		23.94	24.10	24.35		
20	1	99		23.62	23.66	23.97		
20	50	0		22.81	23.07	23.12		
20	50	24		22.78	23.04	23.11		
20	50	50		22.79	23.06	23.06		
20	100	0		22.95	23.10	23.16		
20	1	0	16-QAM	22.13	22.13	22.30	22.19	0.1656
20	1	13		22.52	22.52	22.67		
20	1	26		22.54	22.51	22.70		
20	12	0		22.45	22.41	22.57		
20	12	7		22.62	22.66	22.82		
20	12	15		22.69	22.69	22.83		
20	27	0		21.57	21.58	21.61		
Limit	EIRP < 2W			Result			Pass	

LTE Band 7 Maximum Average Power [dBm] (GT - LC = -0.64 dB)								
BW [MHz]	RB Size	RB Offset	Mod	Lowest	Middle	Highest	EIRP (dBm)	EIRP (W)
15	1	0	QPSK	23.85	23.89	23.82	23.45	0.2213
15	1	37		24.09	23.95	23.96		
15	1	74		23.84	23.96	23.75		
15	36	0		22.82	22.99	22.87		
15	36	20		22.90	23.07	22.93		
15	36	39		22.92	23.06	22.92		
15	75	0		22.80	23.04	22.93		
15	1	0	16-QAM	21.97	21.99	22.11	22.06	0.1607
15	1	13		22.32	22.38	22.55		
15	1	26		22.37	22.41	22.60		
15	12	0		22.31	22.30	22.46		
15	12	7		22.42	22.50	22.70		
15	12	15		22.50	22.53	22.64		
15	27	0		21.61	21.64	21.58		
Limit	EIRP < 2W			Result			Pass	



LTE Band 7 Maximum Average Power [dBm] (GT - LC = -0.64 dB)								
BW [MHz]	RB Size	RB Offset	Mod	Lowest	Middle	Highest	EIRP (dBm)	EIRP (W)
10	1	0	QPSK	23.45	23.67	23.58	23.42	0.2198
10	1	25		23.95	24.06	23.99		
10	1	49		23.56	23.61	23.63		
10	25	0		22.65	22.97	22.97		
10	25	12		22.70	23.01	22.94		
10	25	25		22.80	22.88	22.87		
10	50	0		22.72	22.92	22.92		
10	1	0	16-QAM	21.95	21.94	22.13	22.02	0.1592
10	1	13		22.38	22.38	22.50		
10	1	26		22.42	22.34	22.57		
10	12	0		22.28	22.24	22.41		
10	12	7		22.48	22.51	22.62		
10	12	15		22.54	22.55	22.66		
10	27	0		21.57	21.54	21.53		
Limit	EIRP < 2W			Result			Pass	

LTE Band 7 Maximum Average Power [dBm] (GT - LC = -0.64 dB)								
BW [MHz]	RB Size	RB Offset	Mod	Lowest	Middle	Highest	EIRP (dBm)	EIRP (W)
5	1	0	QPSK	23.31	23.60	23.40	23.14	0.2061
5	1	12		23.47	23.78	23.64		
5	1	24		23.42	23.56	23.27		
5	12	0		22.57	22.72	22.62		
5	12	7		22.62	22.71	22.67		
5	12	13		22.53	22.66	22.52		
5	25	0		22.49	22.69	22.54		
5	1	0	16-QAM	22.02	21.98	22.19	22.04	0.1600
5	1	12		22.32	22.40	22.49		
5	1	24		22.34	22.38	22.57		
5	12	0		22.33	22.23	22.47		
5	12	7		22.45	22.52	22.62		
5	12	13		22.55	22.58	22.68		
5	25	0		21.59	21.62	21.56		
Limit	EIRP < 2W			Result			Pass	



LTE Band 12 Maximum Average Power [dBm] (GT - LC = -1.28 dB)								
BW [MHz]	RB Size	RB Offset	Mod	Lowest	Middle	Highest	ERP (dBm)	ERP (W)
10	1	0	QPSK	23.34	23.02	23.14	20.08	0.1019
10	1	25		23.45	23.51	23.20		
10	1	49		23.39	23.07	23.16		
10	25	0		22.30	22.41	22.46		
10	25	12		22.38	22.51	22.47		
10	25	25		22.57	22.49	22.44		
10	50	0		22.43	22.48	22.47		
10	1	0	16-QAM	22.01	22.08	21.95	18.73	0.0746
10	1	13		21.96	22.16	21.93		
10	1	26		21.72	21.83	21.92		
10	12	0		21.88	21.97	21.77		
10	12	7		21.76	21.98	21.81		
10	12	15		21.57	21.63	21.81		
10	27	0		21.10	21.29	21.09		
Limit	ERP < 3W			Result			Pass	

LTE Band 12 Maximum Average Power [dBm] (GT - LC = -1.28 dB)								
BW [MHz]	RB Size	RB Offset	Mod	Lowest	Middle	Highest	ERP (dBm)	ERP (W)
5	1	0	QPSK	23.21	23.09	23.10	19.87	0.0971
5	1	12		23.27	23.26	23.21		
5	1	24		22.99	23.30	23.16		
5	12	0		22.17	22.24	22.20		
5	12	7		22.11	22.32	22.23		
5	12	13		22.00	22.35	22.22		
5	25	0		22.14	22.32	22.16		
5	1	0	16-QAM	22.13	22.24	22.10	18.85	0.0767
5	1	12		22.15	22.28	22.13		
5	1	24		21.48	21.65	21.45		
5	12	0		21.23	21.38	21.23		
5	12	7		21.20	21.37	21.21		
5	12	13		21.20	21.39	21.26		
5	25	0		21.26	21.37	21.25		
Limit	ERP < 3W			Result			Pass	





LTE Band 12 Maximum Average Power [dBm] (GT - LC = -1.28 dB)								
BW [MHz]	RB Size	RB Offset	Mod	Lowest	Middle	Highest	ERP (dBm)	ERP (W)
3	1	0	QPSK	23.29	23.41	23.33	20.07	0.1016
3	1	8		23.05	23.42	23.47		
3	1	14		23.06	23.43	23.50		
3	8	0		22.37	22.42	22.48		
3	8	4		22.35	22.45	22.53		
3	8	7		22.33	22.46	22.49		
3	15	0		22.35	22.48	22.54		
3	1	0	16-QAM	21.98	22.11	21.93	18.68	0.0738
3	1	8		22.03	22.09	21.96		
3	1	14		21.36	21.55	21.29		
3	8	0		21.04	21.24	21.04		
3	8	4		21.04	21.17	21.07		
3	8	7		21.00	21.23	21.11		
3	15	0		21.15	21.23	21.13		
Limit	ERP < 3W			Result			Pass	

LTE Band 12 Maximum Average Power [dBm] (GT - LC = -1.28 dB)								
BW [MHz]	RB Size	RB Offset	Mod	Lowest	Middle	Highest	ERP (dBm)	ERP (W)
1.4	1	0	QPSK	23.28	23.32	23.08	19.97	0.0993
1.4	1	3		23.36	23.40	23.35		
1.4	1	5		23.24	23.34	23.35		
1.4	3	0		23.27	23.26	23.20		
1.4	3	1		23.24	23.26	23.34		
1.4	3	3		23.23	23.30	23.37		
1.4	6	0		22.26	22.34	22.39		
1.4	1	0	16-QAM	21.90	21.96	21.79	18.58	0.0721
1.4	1	3		21.76	22.01	21.82		
1.4	1	5		21.72	21.77	21.75		
1.4	3	0		21.84	21.88	21.83		
1.4	3	1		21.81	21.98	21.74		
1.4	3	3		21.68	21.63	21.69		
1.4	6	0		20.93	20.95	20.88		
Limit	ERP < 3W			Result			Pass	



LTE Band 13 Maximum Average Power [dBm] (GT - LC = -1.23 dB)								
BW [MHz]	RB Size	RB Offset	Mod	Lowest	Middle	Highest	ERP (dBm)	ERP (W)
10	1	0	QPSK		23.60		20.22	0.1052
10	1	25			23.38			
10	1	49			23.39			
10	25	0			22.52			
10	25	12			22.52			
10	25	25			22.54			
10	50	0			22.45			
10	1	0	16-QAM		22.06		19.10	0.0813
10	1	13			22.36			
10	1	26			22.35			
10	12	0			22.05			
10	12	7			22.35			
10	12	15			22.48			
10	27	0			21.33			
Limit	ERP < 3W			Result			Pass	

LTE Band 13 Maximum Average Power [dBm] (GT - LC = -1.23 dB)									
BW [MHz]	RB Size	RB Offset	Mod	Lowest	Middle	Highest	ERP (dBm)	ERP (W)	
5	1	0	QPSK		23.48	23.40	23.21	20.14	0.1033
5	1	12			23.52	23.43	23.27		
5	1	24			23.19	23.41	23.44		
5	12	0			22.32	22.27	22.34		
5	12	7			22.47	22.40	22.48		
5	12	13			22.38	22.48	22.43		
5	25	0			22.44	22.35	22.37		
5	1	0	16-QAM		21.96	22.15	21.95	18.92	0.0780
5	1	12			22.12	22.30	22.15		
5	1	24			21.94	22.10	21.90		
5	12	0			21.25	21.39	21.25		
5	12	7			21.20	21.40	21.26		
5	12	13			21.09	21.24	21.14		
5	25	0			21.26	21.32	21.30		
Limit	ERP < 3W			Result			Pass		



LTE Band 26 Maximum Average Power [dBm] (GT - LC = 0.41 dB)								
BW [MHz]	RB Size	RB Offset	Mod	Lowest	Middle	Highest	ERP (dBm)	ERP (W)
15	1	0	QPSK	23.37	23.55	23.41	21.81	0.1517
15	1	37		23.53	23.54	23.28		
15	1	74		23.53	23.44	23.35		
15	36	0		22.61	22.38	22.43		
15	36	20		22.46	22.45	22.41		
15	36	39		22.50	22.58	22.43		
15	75	0		22.12	22.32	22.06		
15	1	0	16-QAM	21.61	21.72	21.62	20.16	0.1038
15	1	13		21.41	21.55	21.40		
15	1	26		21.50	21.61	21.49		
15	12	0		21.16	21.15	21.20		
15	12	7		21.50	21.69	21.59		
15	12	15		21.71	21.90	21.73		
15	27	0		20.41	20.58	20.44		
Limit	ERP < 7W			Result			Pass	

LTE Band 26 Maximum Average Power [dBm] (GT - LC = 0.41 dB)								
BW [MHz]	RB Size	RB Offset	Mod	Lowest	Middle	Highest	ERP (dBm)	ERP (W)
10	1	0	QPSK	22.73	22.37	22.78	21.23	0.1327
10	1	25		22.97	22.97	22.82		
10	1	49		22.39	22.97	22.44		
10	25	0		21.82	21.67	21.73		
10	25	12		21.82	21.73	21.75		
10	25	25		21.86	21.87	21.81		
10	50	0		21.85	21.79	21.70		
10	1	0	16-QAM	21.20	21.32	21.14	19.97	0.0993
10	1	13		21.20	21.31	21.17		
10	1	26		21.42	21.59	21.47		
10	12	0		21.25	21.40	21.25		
10	12	7		21.43	21.60	21.49		
10	12	15		21.60	21.71	21.56		
10	27	0		20.46	20.62	20.43		
Limit	ERP < 7W			Result			Pass	



LTE Band 26 Maximum Average Power [dBm] (GT - LC = 0.41 dB)								
BW [MHz]	RB Size	RB Offset	Mod	Lowest	Middle	Highest	ERP (dBm)	ERP (W)
5	1	0	QPSK	22.15	22.32	22.24	21.12	0.1294
5	1	12		22.82	22.79	22.86		
5	1	24		22.60	22.50	22.05		
5	12	0		21.62	21.41	21.54		
5	12	7		21.63	21.56	21.66		
5	12	13		21.62	21.53	21.50		
5	25	0		21.59	21.61	21.55		
5	1	0	16-QAM	21.56	21.75	21.59	20.36	0.1086
5	1	12		21.89	22.05	21.94		
5	1	24		21.99	22.10	21.90		
5	12	0		20.71	20.89	20.72		
5	12	7		20.78	20.89	20.77		
5	12	13		20.58	20.78	20.68		
5	25	0		20.47	20.57	20.38		
Limit	ERP < 7W			Result			Pass	

LTE Band 26 Maximum Average Power [dBm] (GT - LC = 0.41 dB)								
BW [MHz]	RB Size	RB Offset	Mod	Lowest	Middle	Highest	ERP (dBm)	ERP (W)
3	1	0	QPSK	22.98	22.77	23.10	21.36	0.1368
3	1	8		22.86	22.85	22.87		
3	1	14		23.07	22.93	22.59		
3	8	0		21.98	21.89	22.04		
3	8	4		22.15	21.94	21.89		
3	8	7		22.03	21.94	21.90		
3	15	0		22.15	21.88	21.92		
3	1	0	16-QAM	21.41	21.55	21.48	20.23	0.1054
3	1	8		21.71	21.90	21.79		
3	1	14		21.84	21.97	21.70		
3	8	0		20.42	20.56	20.36		
3	8	4		20.38	20.55	20.42		
3	8	7		20.54	20.65	20.47		
3	15	0		20.61	20.72	20.60		
Limit	ERP < 7W			Result			Pass	



LTE Band 26 Maximum Average Power [dBm] (GT - LC = 0.41 dB)								
BW [MHz]	RB Size	RB Offset	Mod	Lowest	Middle	Highest	ERP (dBm)	ERP (W)
1.4	1	0	QPSK	22.51	22.38	22.49	20.97	0.1250
1.4	1	3		22.68	22.69	22.30		
1.4	1	5		22.54	22.71	22.33		
1.4	3	0		22.52	22.44	22.53		
1.4	3	1		22.60	22.42	22.43		
1.4	3	3		22.61	22.48	22.42		
1.4	6	0		21.48	21.53	21.50		
1.4	1	0	16-QAM	21.43	21.60	21.46	20.22	0.1052
1.4	1	3		21.77	21.91	21.83		
1.4	1	5		21.79	21.93	21.72		
1.4	3	0		21.39	21.63	21.45		
1.4	3	1		21.73	21.92	21.80		
1.4	3	3		21.80	21.96	21.73		
1.4	6	0		20.63	20.73	20.65		
Limit	ERP < 7W			Result			Pass	

LTE Band 38 Maximum Average Power [dBm] (GT - LC = -0.64 dB)								
BW [MHz]	RB Size	RB Offset	Mod	Lowest	Middle	Highest	EIRP (dBm)	EIRP (W)
20	1	0	QPSK	24.40	24.43	24.38	24.09	0.2564
20	1	49		24.55	24.40	24.73		
20	1	99		24.39	24.53	24.61		
20	50	0		23.57	23.70	23.70		
20	50	24		23.49	23.65	23.68		
20	50	50		23.42	23.55	23.58		
20	100	0		23.45	23.47	23.49		
20	1	0	16-QAM	22.82	23.00	22.80	22.36	0.1722
20	1	13		22.71	22.84	22.64		
20	1	26		22.79	22.99	22.81		
20	12	0		22.80	22.96	22.78		
20	12	7		22.67	22.86	22.67		
20	12	15		22.76	22.87	22.70		
20	27	0		21.71	21.89	21.78		
Limit	EIRP < 2W			Result			Pass	



LTE Band 38 Maximum Average Power [dBm] (GT - LC = -0.64 dB)								
BW [MHz]	RB Size	RB Offset	Mod	Lowest	Middle	Highest	EIRP (dBm)	EIRP (W)
15	1	0	QPSK	24.58	24.61	24.56	24.06	0.2547
15	1	37		24.65	24.51	24.56		
15	1	74		24.63	24.56	24.70		
15	36	0		23.58	23.68	23.74		
15	36	20		23.49	23.56	23.68		
15	36	39		23.48	23.62	23.74		
15	75	0		23.50	23.43	23.66		
15	1	0	16-QAM	22.62	22.80	22.60	22.16	0.1644
15	1	13		22.59	22.67	22.44		
15	1	26		22.69	22.79	22.68		
15	12	0		22.62	22.78	22.59		
15	12	7		22.55	22.72	22.56		
15	12	15		22.63	22.71	22.55		
15	27	0		21.56	21.71	21.60		
Limit	EIRP < 2W			Result			Pass	

LTE Band 38 Maximum Average Power [dBm] (GT - LC = -0.64 dB)								
BW [MHz]	RB Size	RB Offset	Mod	Lowest	Middle	Highest	EIRP (dBm)	EIRP (W)
10	1	0	QPSK	24.47	24.68	24.60	24.07	0.2553
10	1	25		24.71	24.68	24.70		
10	1	49		24.46	24.47	24.51		
10	25	0		23.62	23.79	23.58		
10	25	12		23.54	23.71	23.60		
10	25	25		23.56	23.72	23.74		
10	50	0		23.45	23.81	23.64		
10	1	0	16-QAM	22.66	22.90	22.62	22.26	0.1683
10	1	13		22.58	22.72	22.49		
10	1	26		22.59	22.89	22.62		
10	12	0		22.64	22.82	22.63		
10	12	7		22.49	22.70	22.47		
10	12	15		22.65	22.74	22.53		
10	27	0		21.58	21.69	21.63		
Limit	EIRP < 2W			Result			Pass	



LTE Band 38 Maximum Average Power [dBm] (GT - LC = -0.64 dB)								
BW [MHz]	RB Size	RB Offset	Mod	Lowest	Middle	Highest	EIRP (dBm)	EIRP (W)
5	1	0	QPSK	24.46	24.53	24.42	24.03	0.2529
5	1	12		24.60	24.67	24.53		
5	1	24		24.49	24.41	24.48		
5	12	0		23.45	23.49	23.54		
5	12	7		23.45	23.42	23.59		
5	12	13		23.50	23.60	23.71		
5	25	0		23.58	23.54	23.74		
5	1	0	16-QAM	22.25	22.45	22.32	22.12	0.1629
5	1	12		22.45	22.60	22.48		
5	1	24		22.59	22.76	22.62		
5	12	0		22.31	22.10	22.41		
5	12	7		22.30	22.38	22.40		
5	12	13		22.46	22.37	22.42		
5	25	0		22.69	22.38	22.68		
Limit	EIRP < 2W			Result			Pass	

LTE Band 41 Maximum Average Power [dBm] (GT - LC = -0.74 dB)								
BW [MHz]	RB Size	RB Offset	Mod	Lowest	Middle	Highest	EIRP (dBm)	EIRP (W)
20	1	0	QPSK	23.97	23.86	23.63	23.29	0.2133
20	1	49		24.03	23.91	23.70		
20	1	99		23.93	23.76	23.53		
20	50	0		22.94	22.89	22.73		
20	50	24		23.04	22.98	22.76		
20	50	50		22.92	22.89	22.72		
20	100	0		22.82	22.86	22.59		
20	1	0	16-QAM	22.70	22.62	22.60	22.05	0.1603
20	1	13		22.32	22.42	22.41		
20	1	26		22.39	22.45	22.40		
20	12	0		22.76	22.76	22.79		
20	12	7		22.59	22.66	22.61		
20	12	15		22.65	22.71	22.73		
20	27	0		21.74	21.77	21.68		
Limit	EIRP < 2W			Result			Pass	



LTE Band 41 Maximum Average Power [dBm] (GT - LC = -0.74 dB)								
BW [MHz]	RB Size	RB Offset	Mod	Lowest	Middle	Highest	EIRP (dBm)	EIRP (W)
15	1	0	QPSK	24.04	24.11	23.62	23.50	0.2239
15	1	37		24.24	24.00	24.08		
15	1	74		24.18	23.99	23.78		
15	36	0		23.05	23.09	23.02		
15	36	20		23.04	23.07	22.89		
15	36	39		23.04	23.03	22.82		
15	75	0		22.80	22.88	22.65		
15	1	0	16-QAM	22.52	22.43	22.48	21.93	0.1560
15	1	13		22.21	22.25	22.31		
15	1	26		22.22	22.27	22.21		
15	12	0		22.64	22.64	22.67		
15	12	7		22.39	22.49	22.42		
15	12	15		22.55	22.56	22.63		
15	27	0		21.58	21.63	21.58		
Limit	EIRP < 2W			Result			Pass	

LTE Band 41 Maximum Average Power [dBm] (GT - LC = -0.74 dB)								
BW [MHz]	RB Size	RB Offset	Mod	Lowest	Middle	Highest	EIRP (dBm)	EIRP (W)
10	1	0	QPSK	24.09	23.98	23.75	23.45	0.2213
10	1	25		24.10	24.05	23.74		
10	1	49		24.19	23.88	23.70		
10	25	0		22.99	23.02	22.77		
10	25	12		22.96	23.04	22.69		
10	25	25		22.96	23.06	22.63		
10	50	0		23.05	23.15	22.76		
10	1	0	16-QAM	22.54	22.45	22.50	21.91	0.1552
10	1	13		22.16	22.32	22.31		
10	1	26		22.21	22.34	22.26		
10	12	0		22.64	22.56	22.65		
10	12	7		22.46	22.51	22.47		
10	12	15		22.54	22.53	22.56		
10	27	0		21.56	21.58	21.52		
Limit	EIRP < 2W			Result			Pass	





LTE Band 41 Maximum Average Power [dBm] (GT - LC = -0.74 dB)								
BW [MHz]	RB Size	RB Offset	Mod	Lowest	Middle	Highest	EIRP (dBm)	EIRP (W)
5	1	0	QPSK	23.79	23.63	23.35	23.34	0.2158
5	1	12		24.08	23.83	23.51		
5	1	24		23.72	23.55	23.13		
5	12	0		22.65	22.71	22.56		
5	12	7		22.74	22.73	22.64		
5	12	13		22.83	22.73	22.39		
5	25	0		22.73	22.76	22.42		
5	1	0	16-QAM	22.56	22.30	22.18	21.84	0.1528
5	1	12		22.39	22.48	22.58		
5	1	24		22.34	22.27	22.07		
5	12	0		21.59	21.69	21.44		
5	12	7		21.50	21.79	21.58		
5	12	13		21.71	21.80	21.57		
5	25	0		21.90	21.98	21.76		
Limit	EIRP < 2W			Result			Pass	

LTE Band 66 Maximum Average Power [dBm] (GT - LC = 2.38 dB)								
BW [MHz]	RB Size	RB Offset	Mod	Lowest	Middle	Highest	EIRP (dBm)	EIRP (W)
20	1	0	QPSK	23.15	23.55	23.51	25.93	0.3917
20	1	49		23.01	23.51	23.43		
20	1	99		23.14	23.37	23.13		
20	50	0		22.26	22.60	22.59		
20	50	24		22.12	22.56	22.51		
20	50	50		22.19	22.59	22.55		
20	100	0		21.82	22.28	22.22		
20	1	0	16-QAM	21.16	21.32	21.24	23.99	0.2506
20	1	13		21.18	21.30	21.20		
20	1	26		21.16	21.28	21.12		
20	12	0		21.40	21.52	21.36		
20	12	7		21.47	21.61	21.41		
20	12	15		21.41	21.55	21.39		
20	27	0		20.26	20.55	20.93		
Limit	EIRP < 1W			Result			Pass	



LTE Band 66 Maximum Average Power [dBm] (GT - LC = 2.38 dB)								
BW [MHz]	RB Size	RB Offset	Mod	Lowest	Middle	Highest	EIRP (dBm)	EIRP (W)
15	1	0	QPSK	22.87	23.48	23.52	25.90	0.3890
15	1	37		23.19	23.50	23.43		
15	1	74		23.13	23.50	23.45		
15	36	0		21.90	22.61	22.62		
15	36	20		22.06	22.51	22.48		
15	36	39		22.04	22.60	22.52		
15	75	0		21.68	22.21	22.32		
15	1	0	16-QAM	21.04	21.22	21.14	23.79	0.2393
15	1	13		21.12	21.13	21.05		
15	1	26		21.02	21.08	21.00		
15	12	0		21.26	21.33	21.22		
15	12	7		21.31	21.41	21.25		
15	12	15		21.31	21.41	21.20		
15	27	0		20.07	20.40	20.83		
Limit	EIRP < 1W			Result			Pass	

LTE Band 66 Maximum Average Power [dBm] (GT - LC = 2.38 dB)								
BW [MHz]	RB Size	RB Offset	Mod	Lowest	Middle	Highest	EIRP (dBm)	EIRP (W)
10	1	0	QPSK	22.49	23.11	23.36	25.77	0.3776
10	1	25		23.03	23.39	23.03		
10	1	49		22.86	23.16	22.83		
10	25	0		21.68	22.23	22.27		
10	25	12		21.79	22.23	22.10		
10	25	25		21.79	22.13	22.06		
10	50	0		21.74	22.17	22.11		
10	1	0	16-QAM	21.11	21.15	21.07	23.81	0.2404
10	1	13		21.08	21.12	21.02		
10	1	26		21.06	21.11	21.10		
10	12	0		21.25	21.40	21.22		
10	12	7		21.27	21.43	21.30		
10	12	15		21.27	21.36	21.20		
10	27	0		20.10	20.39	20.73		
Limit	EIRP < 1W			Result			Pass	



LTE Band 66 Maximum Average Power [dBm] (GT - LC = 2.38 dB)								
BW [MHz]	RB Size	RB Offset	Mod	Lowest	Middle	Highest	EIRP (dBm)	EIRP (W)
5	1	0	QPSK	22.54	23.02	22.79	25.53	0.3573
5	1	12		22.51	23.15	23.00		
5	1	24		22.64	23.02	22.63		
5	12	0		21.46	22.04	21.96		
5	12	7		21.51	22.07	21.91		
5	12	13		21.44	22.04	21.97		
5	25	0		21.39	22.04	21.99		
5	1	0	16-QAM	21.11	21.21	21.13	23.80	0.2399
5	1	12		21.08	21.15	21.03		
5	1	24		21.13	21.16	21.02		
5	12	0		21.27	21.42	21.19		
5	12	7		21.34	21.41	21.24		
5	12	13		21.30	21.36	21.21		
5	25	0		21.20	21.10	21.18		
Limit	EIRP < 1W			Result			Pass	

LTE Band 66 Maximum Average Power [dBm] (GT - LC = 2.38 dB)								
BW [MHz]	RB Size	RB Offset	Mod	Lowest	Middle	Highest	EIRP (dBm)	EIRP (W)
3	1	0	QPSK	22.73	23.46	23.40	25.85	0.3846
3	1	8		22.75	23.47	23.32		
3	1	14		22.79	23.47	23.29		
3	8	0		21.71	22.19	22.27		
3	8	4		21.72	22.24	22.19		
3	8	7		21.78	22.25	22.16		
3	15	0		21.69	22.31	22.17		
3	1	0	16-QAM	21.16	21.20	21.09	23.87	0.2438
3	1	8		21.08	21.13	21.01		
3	1	14		21.12	21.09	21.10		
3	8	0		21.22	21.36	21.17		
3	8	4		21.27	21.49	21.21		
3	8	7		21.31	21.35	21.27		
3	15	0		21.26	21.18	21.13		
Limit	EIRP < 1W			Result			Pass	



LTE Band 66 Maximum Average Power [dBm] (GT - LC = 2.38 dB)								
BW [MHz]	RB Size	RB Offset	Mod	Lowest	Middle	Highest	EIRP (dBm)	EIRP (W)
1.4	1	0	QPSK	22.58	22.88	23.17	25.71	0.3724
1.4	1	3		22.57	23.06	23.23		
1.4	1	5		22.54	23.05	23.11		
1.4	3	0		22.55	23.04	23.11		
1.4	3	1		22.81	23.33	23.31		
1.4	3	3		22.64	23.07	23.26		
1.4	6	0		21.58	22.06	22.08		
1.4	1	0	16-QAM	21.05	21.15	21.14	23.79	0.2393
1.4	1	3		21.02	21.19	21.07		
1.4	1	5		21.02	21.08	21.00		
1.4	3	0		21.29	21.34	21.21		
1.4	3	1		21.33	21.41	21.22		
1.4	3	3		21.22	21.36	21.27		
1.4	6	0		20.06	20.41	20.75		
Limit	EIRP < 1W			Result			Pass	



# LTE Band 2

## Peak-to-Average Ratio

Mode	LTE Band 2 / 20MHz		
Mod.	QPSK	16QAM	Limit: 13dB
RB Size	Full RB	27 RB	Result
Middle CH	4.06	4.61	PASS

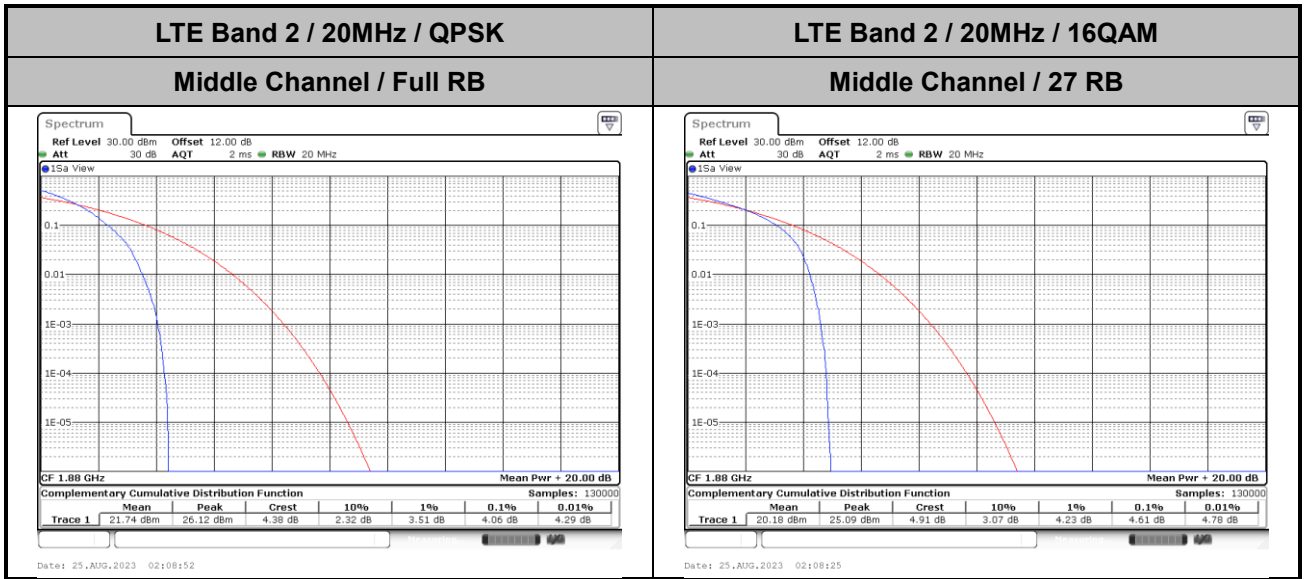



**26dB Bandwidth**

Mode	LTE Band 2 : 26dB BW(MHz)											
	1.4MHz		3MHz		5MHz		10MHz		15MHz		20MHz	
BW												
Mod.	QPSK	16QAM	QPSK	16QAM	QPSK	16QAM	QPSK	16QAM	QPSK	16QAM	QPSK	16QAM
Middle CH	1.27	1.31	3.02	3.02	4.89	4.94	9.83	5.32	14.30	5.37	18.74	5.51



LTE Band 2

Middle Channel / 1.4MHz / QPSK

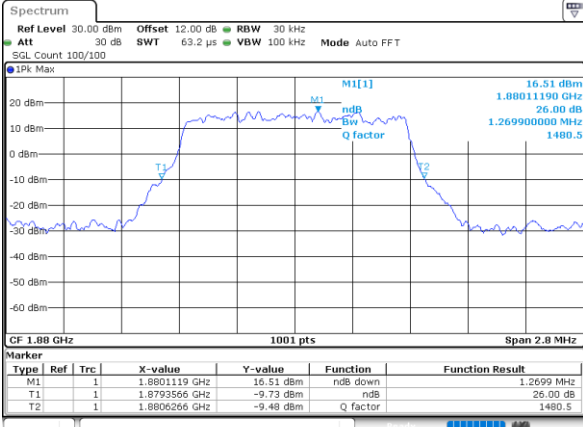

Date: 25\_AUG.2023 00:139:27

Middle Channel / 1.4MHz / 16QAM

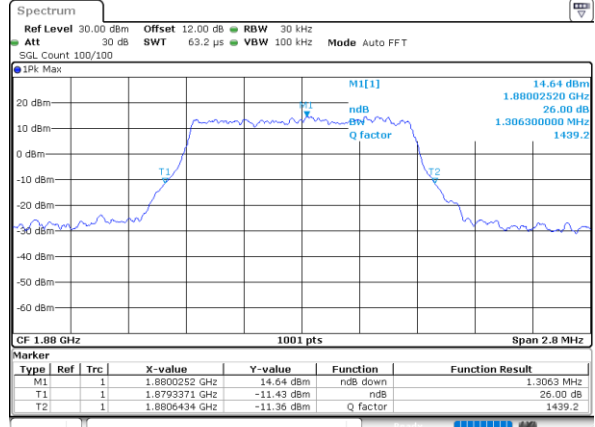

Date: 25\_AUG.2023 00:139:50

Middle Channel / 3MHz / QPSK

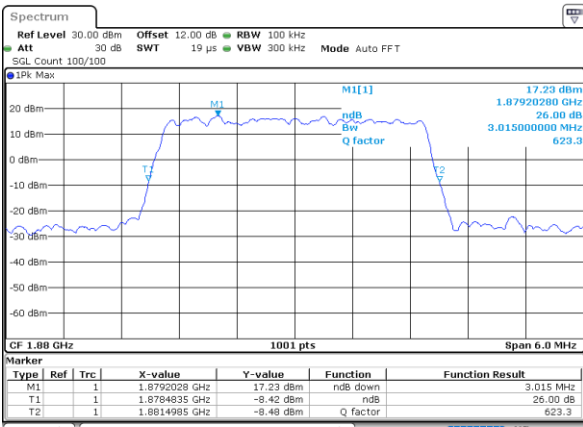

Date: 25\_AUG.2023 00:148:32

Middle Channel / 3MHz / 16QAM

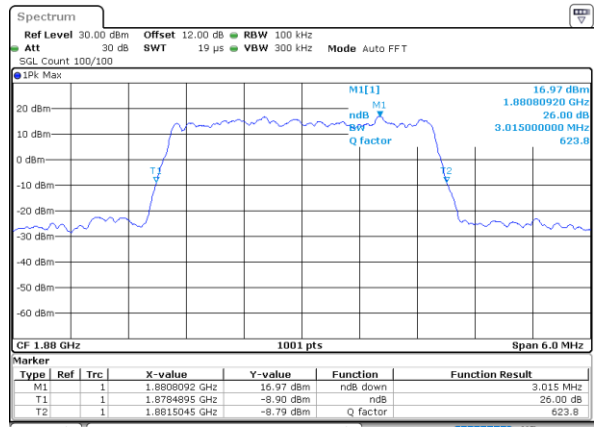

Date: 25\_AUG.2023 00:148:56

Middle Channel / 5MHz / QPSK

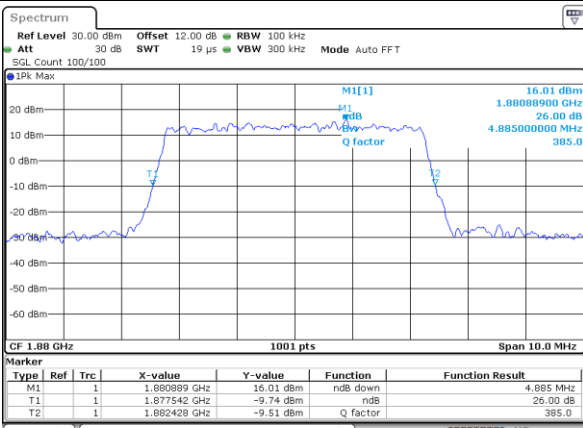

Date: 25\_AUG.2023 00:156:53

Middle Channel / 5MHz / 16QAM

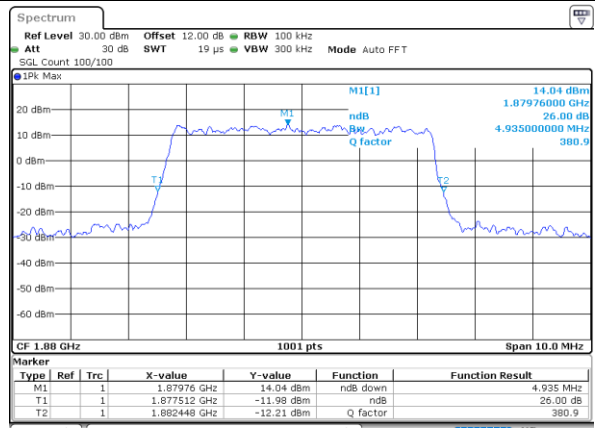

Date: 25\_AUG.2023 00:157:16



LTE Band 2

Middle Channel / 10MHz / QPSK

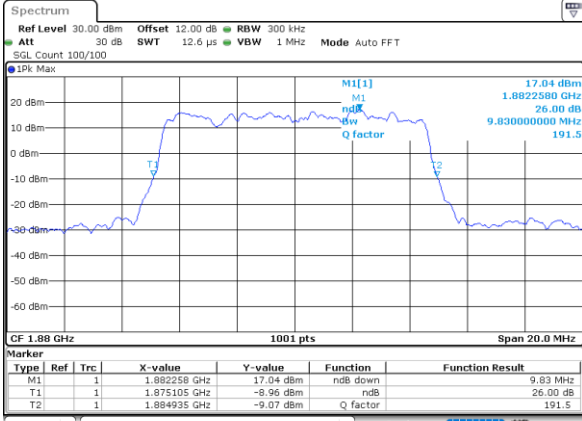

Date: 5.SEP.2023 20:24:15

Middle Channel / 10MHz / 16QAM

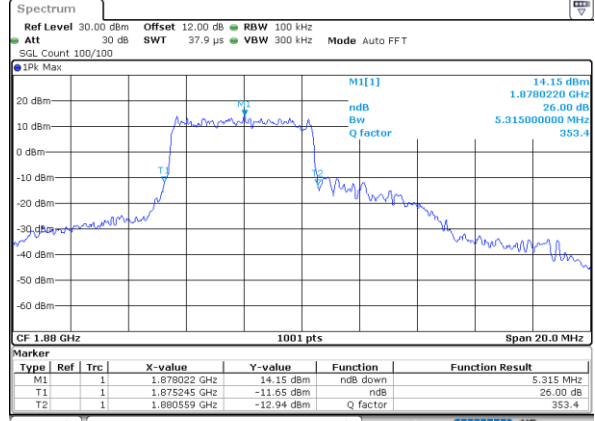

Date: 25.AUG.2023 01:05:37

Middle Channel / 15MHz / QPSK

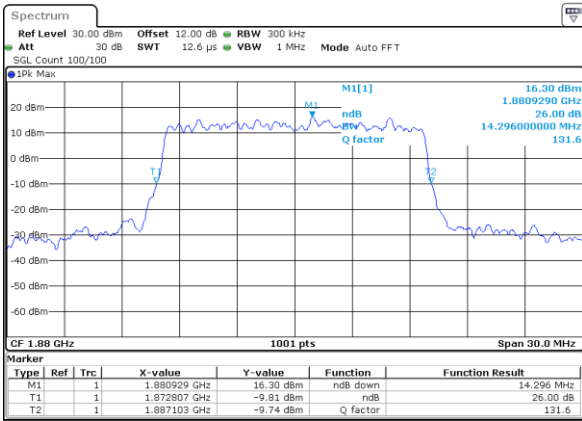

Date: 5.SEP.2023 20:24:47

Middle Channel / 15MHz / 16QAM

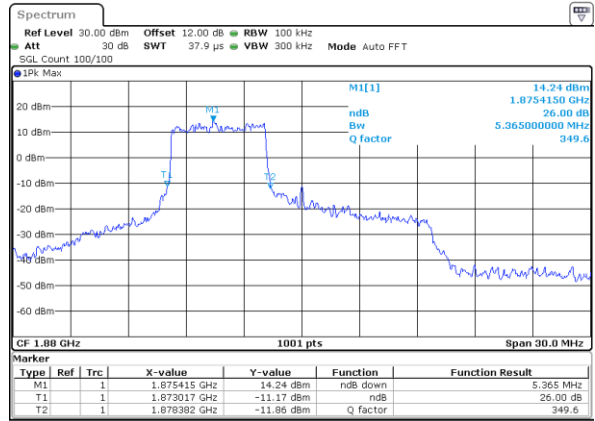

Date: 25.AUG.2023 01:13:59

Middle Channel / 20MHz / QPSK

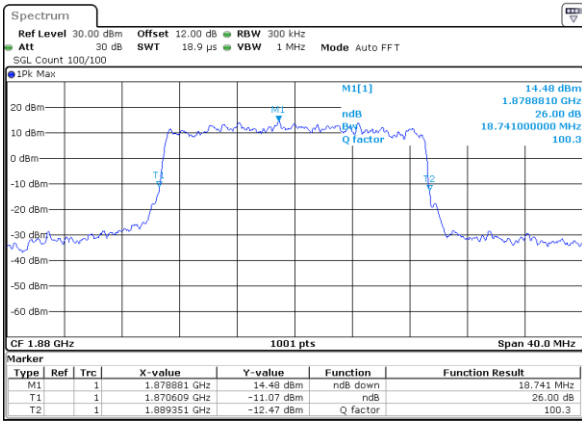

Date: 5.SEP.2023 20:38:17

Middle Channel / 20MHz / 16QAM

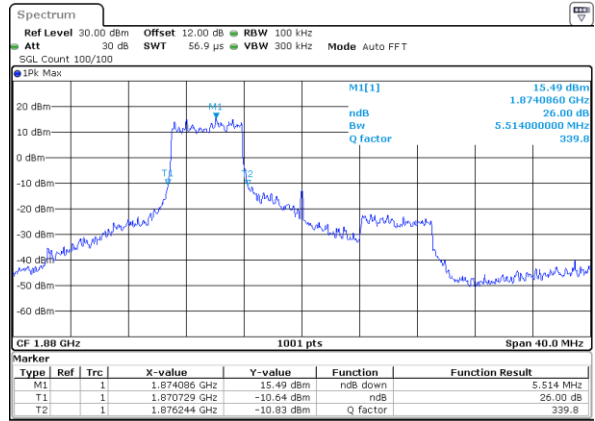

Date: 25.AUG.2023 02:11:40





### Occupied Bandwidth

Mode	LTE Band 2 : 99%OBW(MHz)											
	1.4MHz		3MHz		5MHz		10MHz		15MHz		20MHz	
Mod.	QPSK	16QAM	QPSK	16QAM	QPSK	16QAM	QPSK	16QAM	QPSK	16QAM	QPSK	16QAM
Middle CH	1.09	1.10	2.72	2.73	4.52	4.49	8.97	4.90	13.31	4.89	17.70	4.96



LTE Band 2

Middle Channel / 1.4MHz / QPSK

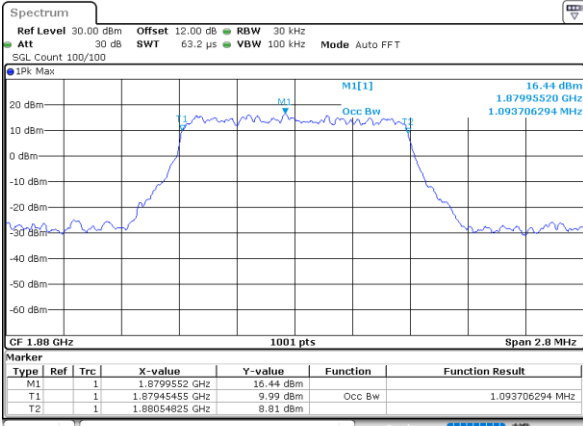

Date: 25.AUG.2023 00:38:40

Middle Channel / 1.4MHz / 16QAM

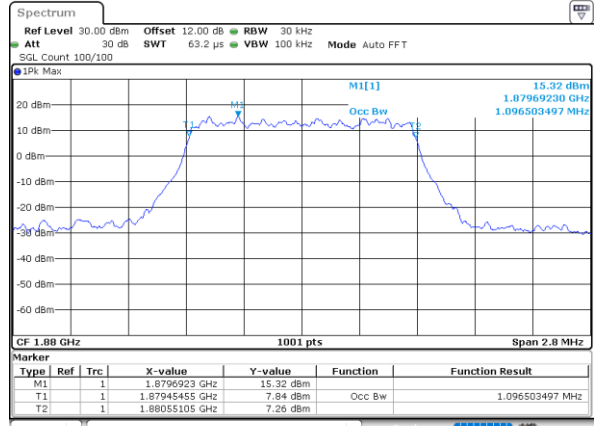

Date: 25.AUG.2023 00:39:03

Middle Channel / 3MHz / QPSK

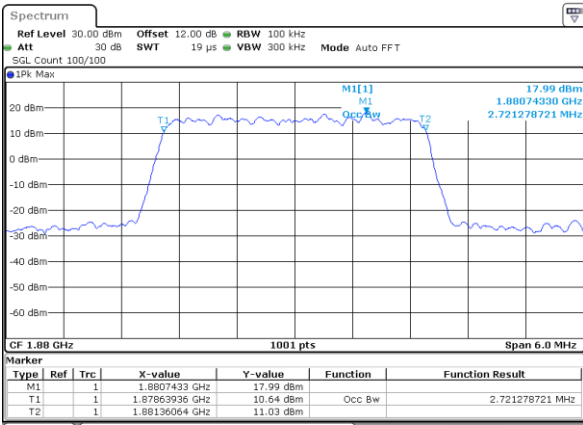

Date: 25.AUG.2023 00:47:46

Middle Channel / 3MHz / 16QAM

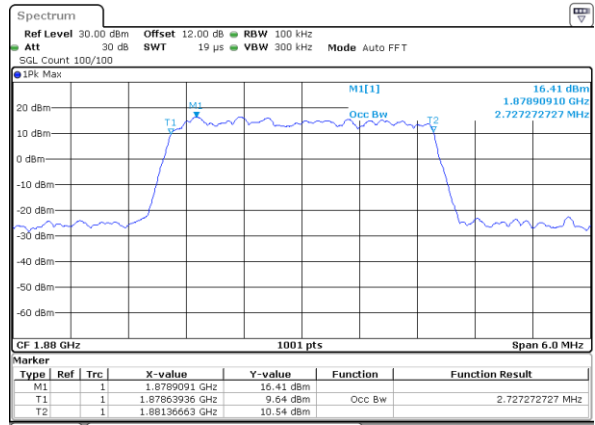

Date: 25.AUG.2023 00:48:09

Middle Channel / 5MHz / QPSK

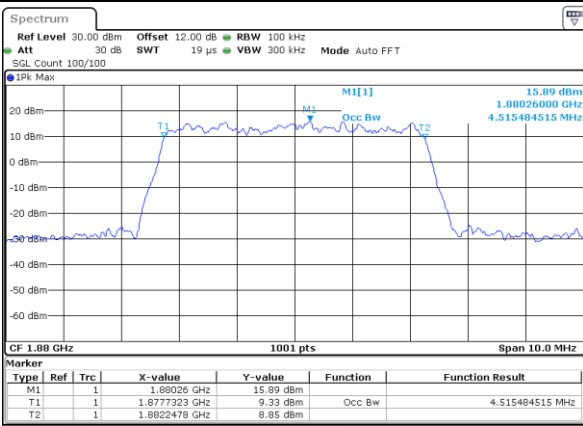

Date: 25.AUG.2023 00:56:06

Middle Channel / 5MHz / 16QAM

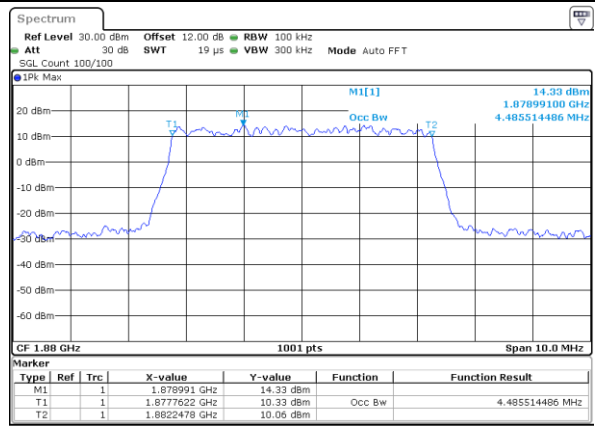

Date: 25.AUG.2023 00:56:29



LTE Band 2

Middle Channel / 10MHz / QPSK

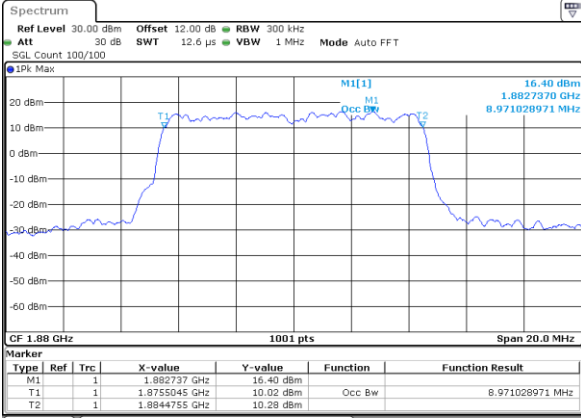

Date: 5.SEP.2023 20:23:51

Middle Channel / 10MHz / 16QAM

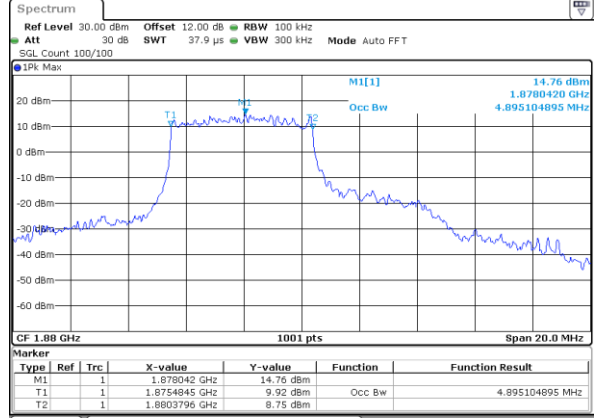

Date: 25.AUG.2023 01:04:50

Middle Channel / 15MHz / QPSK

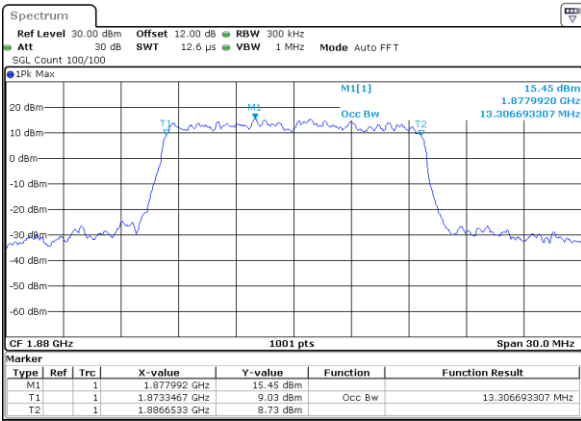

Date: 5.SEP.2023 20:24:23

Middle Channel / 15MHz / 16QAM

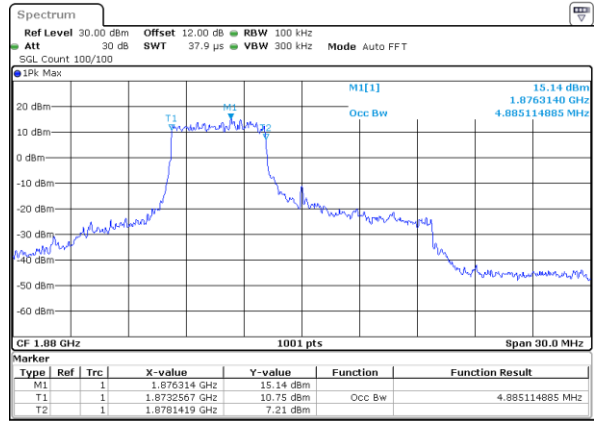

Date: 25.AUG.2023 01:13:11

Middle Channel / 20MHz / QPSK

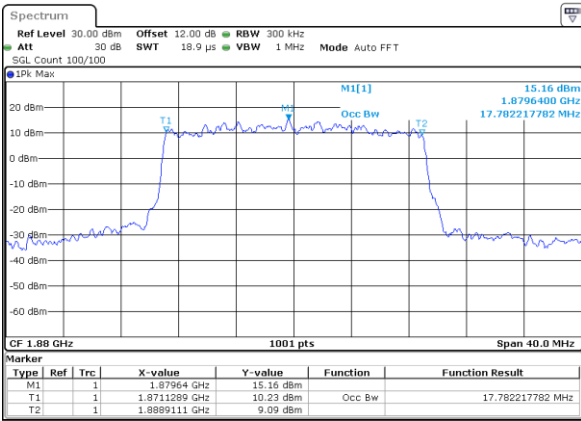

Date: 5.SEP.2023 20:27:53

Middle Channel / 20MHz / 16QAM

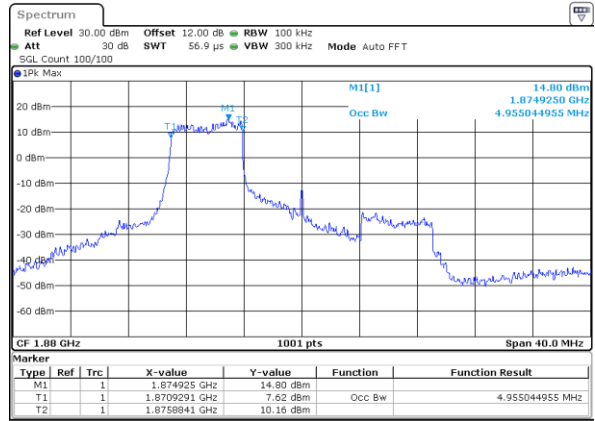

Date: 25.AUG.2023 01:21:32



# Conducted Band Edge

## LTE Band 2 / 1.4MHz / QPSK

### Lowest Band Edge / 1RB

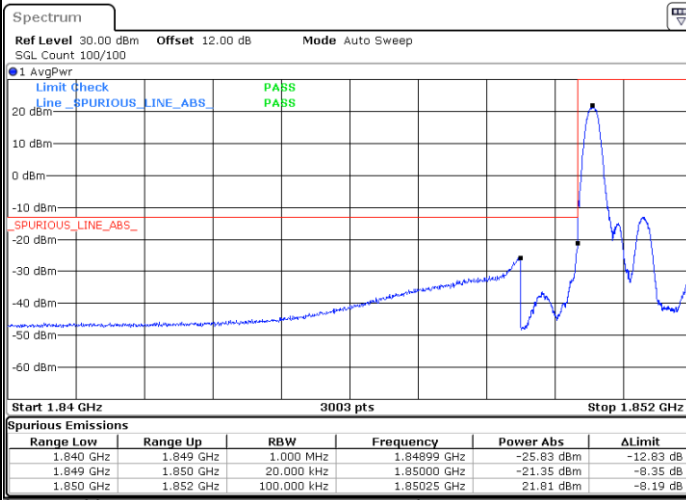

Date: 25.AUG.2023 00:34:28

### Highest Band Edge / 1RB

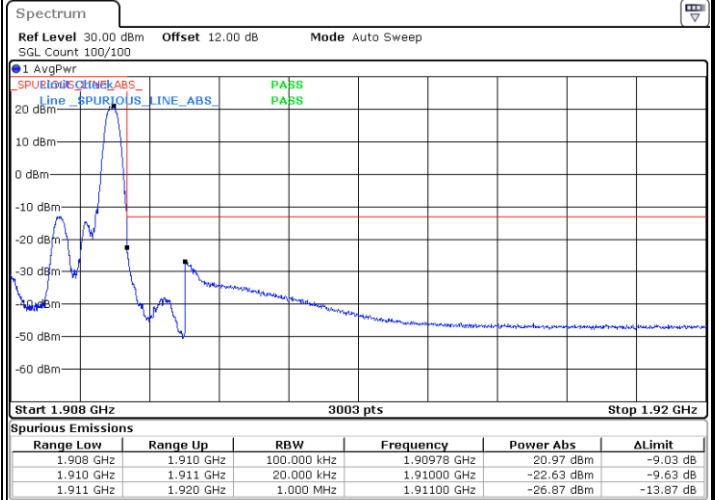

Date: 25.AUG.2023 00:41:45

### Lowest Band Edge / Full RB

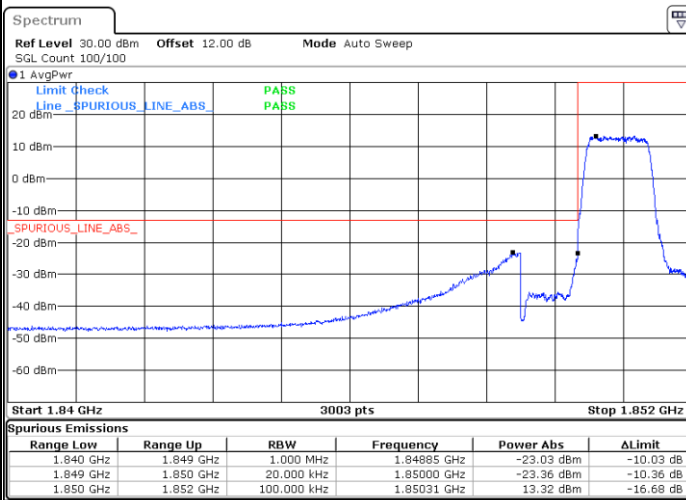

Date: 25.AUG.2023 00:36:17

### Highest Band Edge / Full RB



Date: 25.AUG.2023 00:43:34



LTE Band 2 / 1.4MHz / 16QAM

Lowest Band Edge / 1 RB

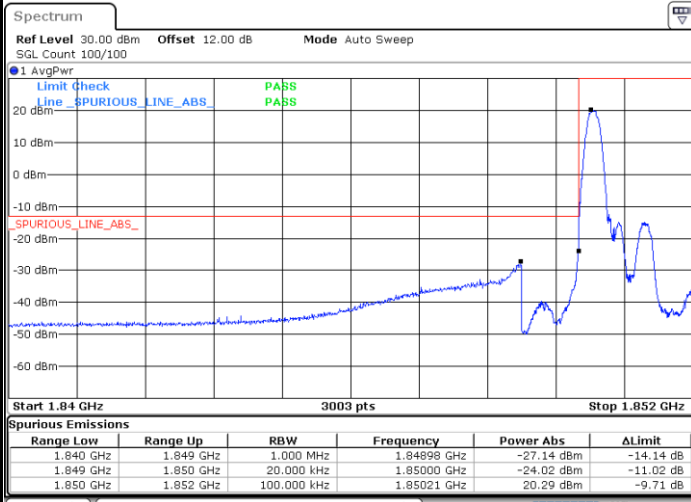

Date: 25.AUG.2023 00:35:23

Highest Band Edge / 1 RB

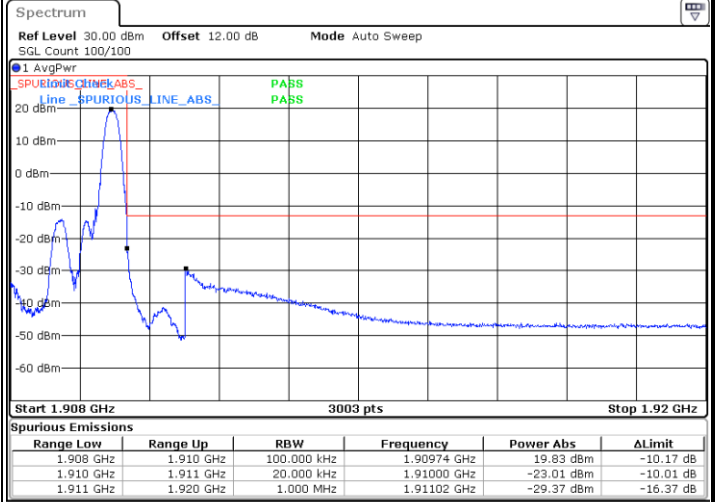

Date: 25.AUG.2023 00:42:40

Lowest Band Edge / Full RB

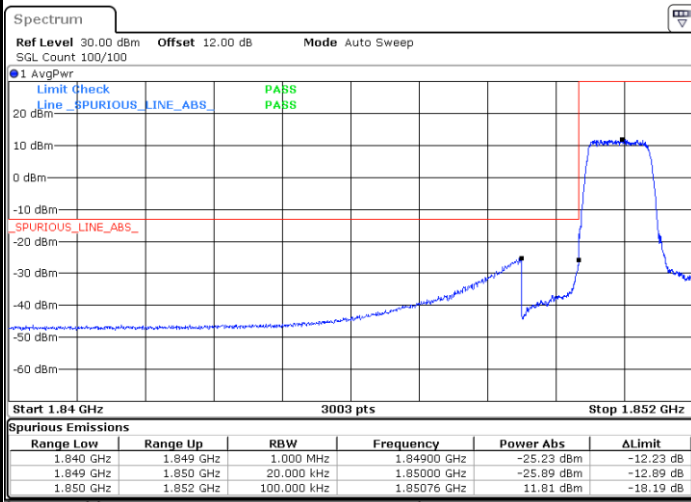

Date: 25.AUG.2023 00:37:11

Highest Band Edge / Full RB

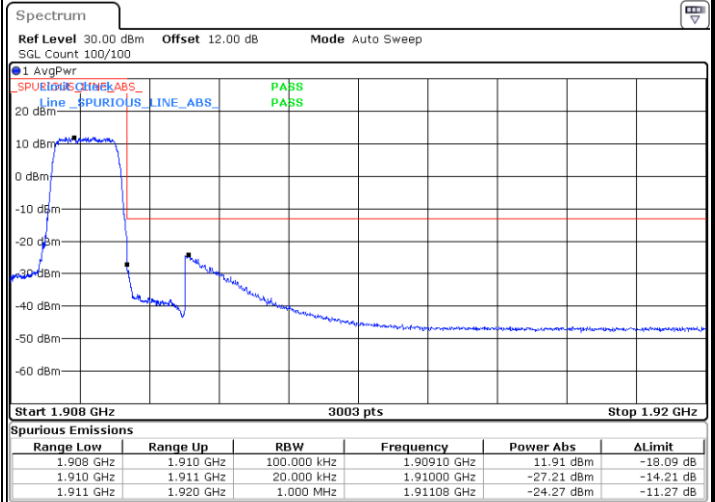

Date: 25.AUG.2023 00:44:29



LTE Band 2 / 3MHz / QPSK

Lowest Band Edge / Full RB

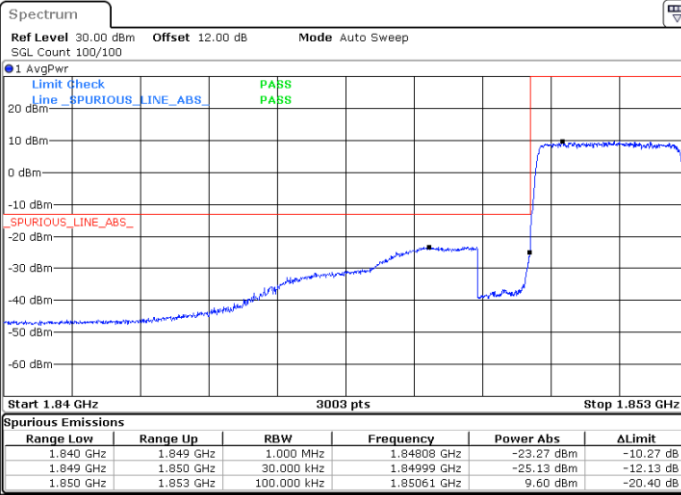

Date: 25.AUG.2023 00:46:26

Highest Band Edge / Full RB

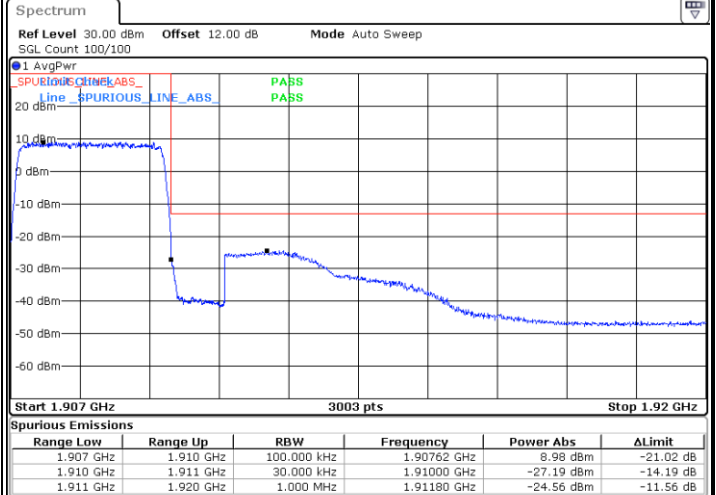

Date: 25.AUG.2023 00:52:57

LTE Band 2 / 3MHz / 16QAM

Lowest Band Edge / Full RB

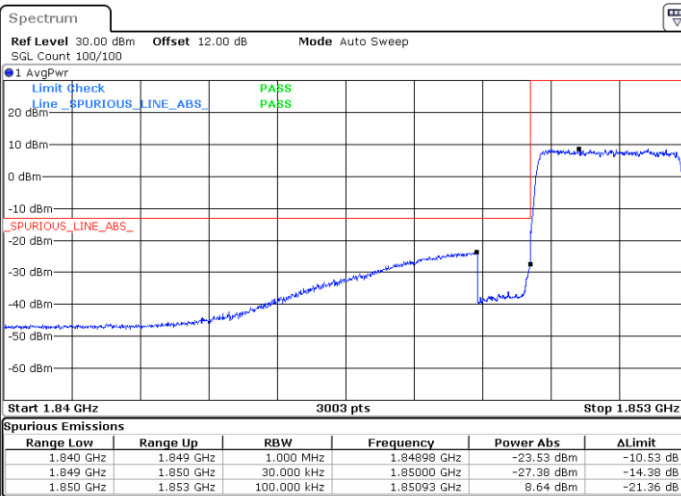

Date: 25.AUG.2023 00:47:21

Highest Band Edge / Full RB

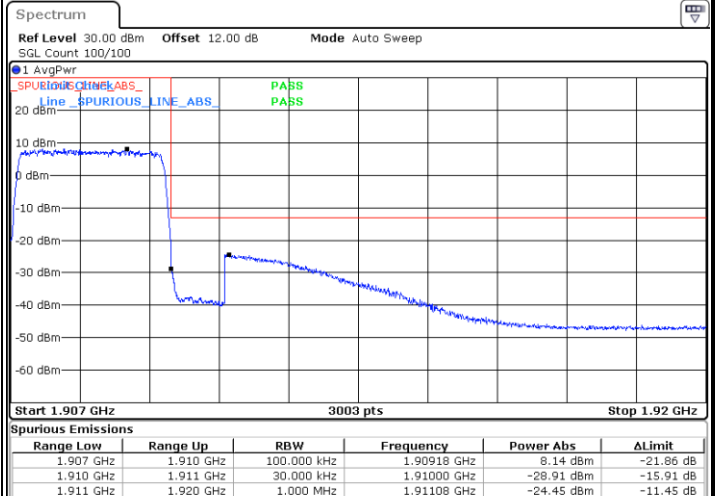

Date: 25.AUG.2023 00:53:51



LTE Band 2 / 5MHz / QPSK

Lowest Band Edge / Full RB

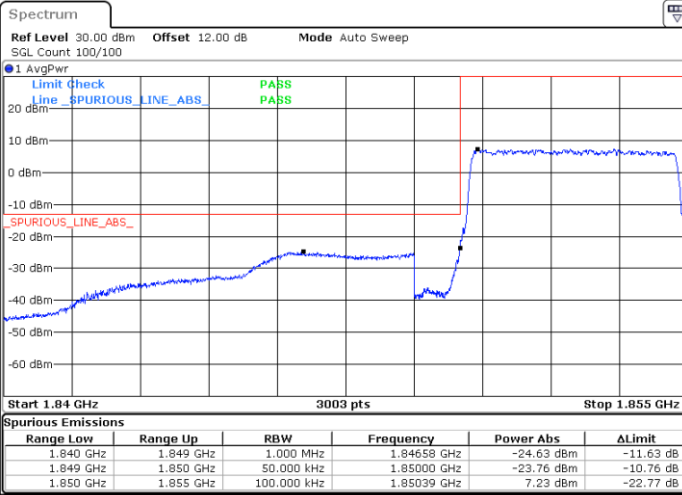

Date: 25.AUG.2023 00:54:46

Highest Band Edge / Full RB

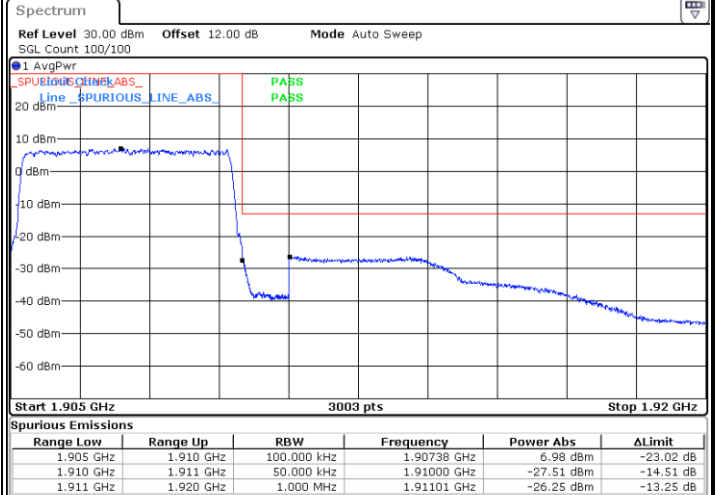

Date: 25.AUG.2023 00:58:09

LTE Band 2 / 5MHz / 16QAM

Lowest Band Edge / Full RB

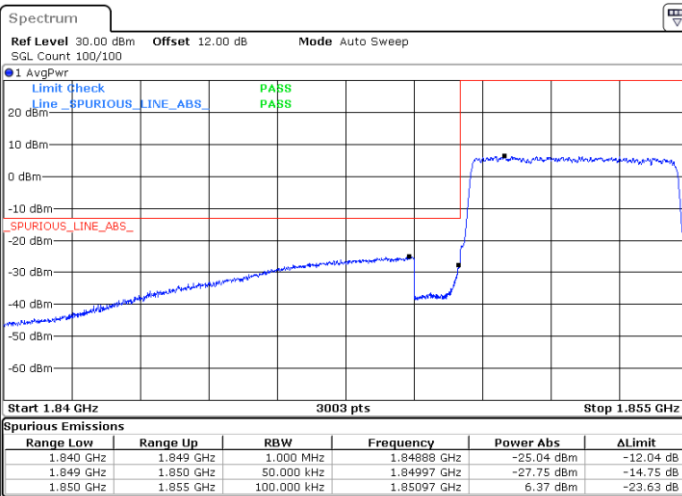

Date: 25.AUG.2023 00:55:41

Highest Band Edge / Full RB

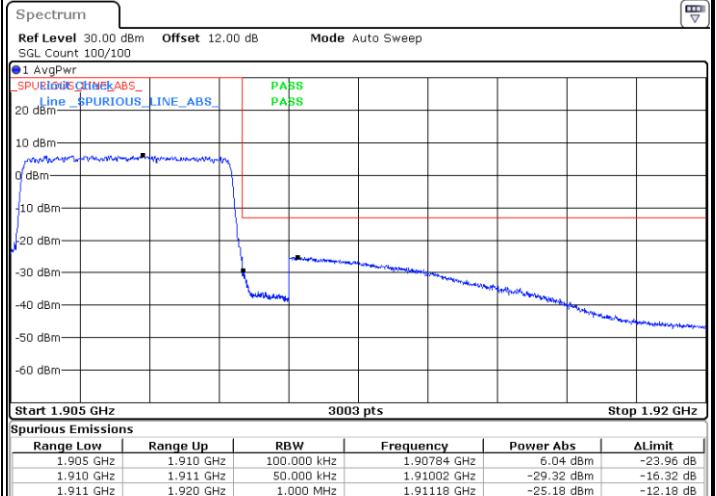

Date: 25.AUG.2023 00:59:03



LTE Band 2 / 10MHz / QPSK

Lowest Band Edge / Full RB

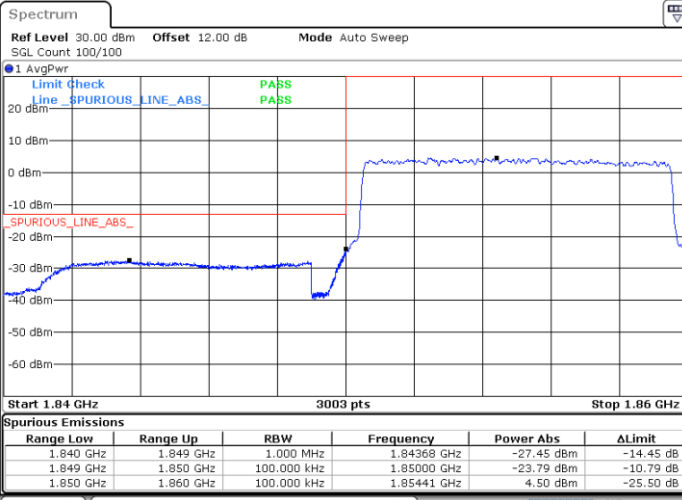

Date: 25.AUG.2023 01:03:06

Highest Band Edge / Full RB

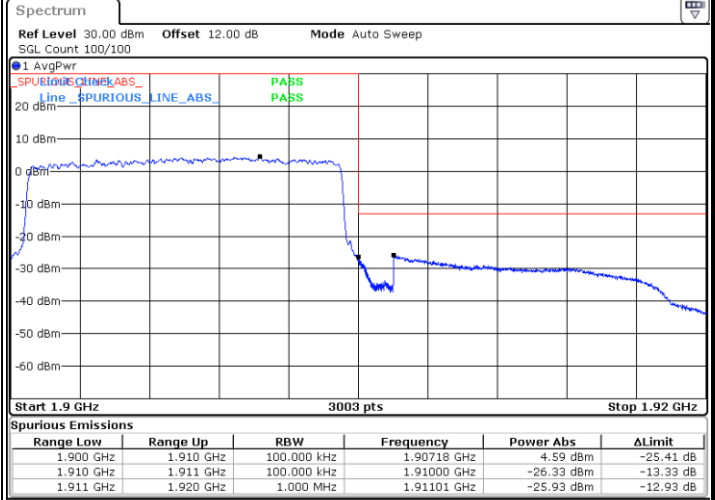

Date: 25.AUG.2023 01:09:39

LTE Band 2 / 10MHz / 16QAM

Lowest Band Edge / 27 RB

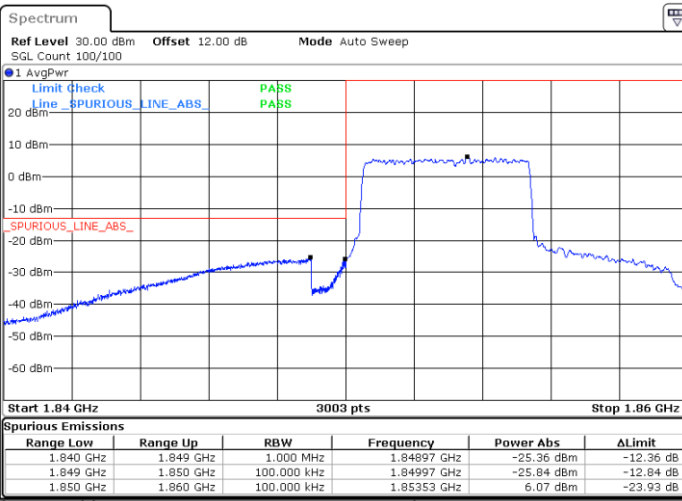

Date: 25.AUG.2023 01:04:00

Highest Band Edge / 27 RB

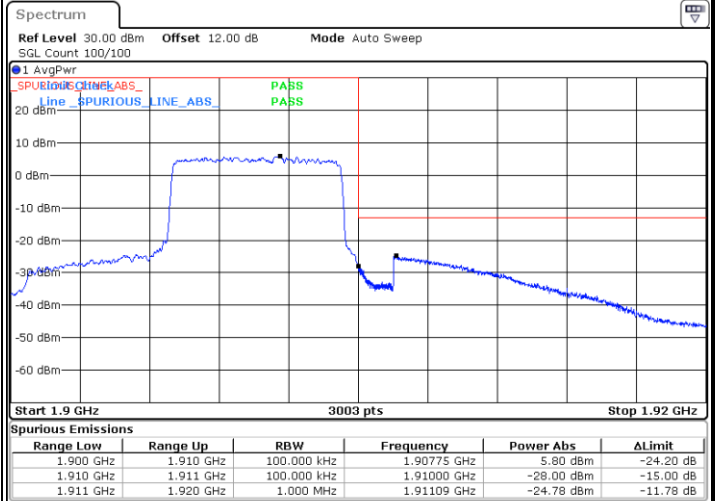

Date: 25.AUG.2023 19:52:16





LTE Band 2 / 15MHz / QPSK

Lowest Band Edge / Full RB

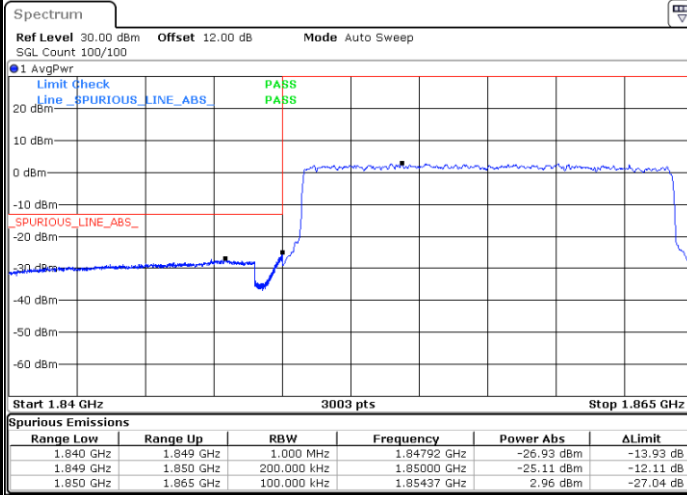

Date: 25.AUG.2023 01:11:28

Highest Band Edge / Full RB

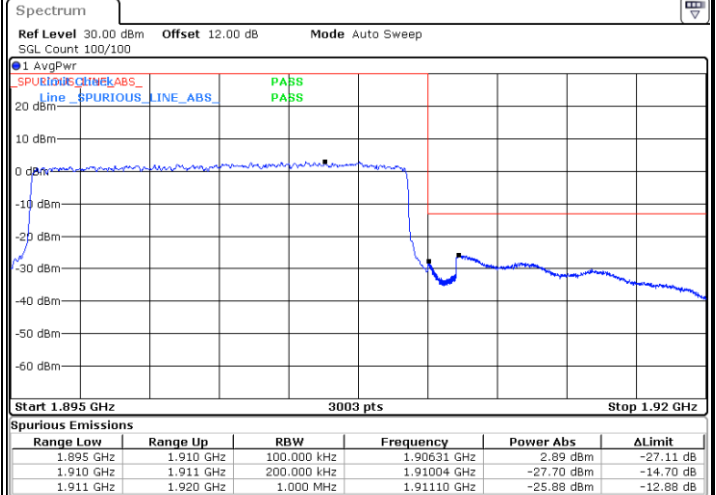

Date: 25.AUG.2023 01:14:52

LTE Band 2 / 15MHz / 16QAM

Lowest Band Edge / 27 RB

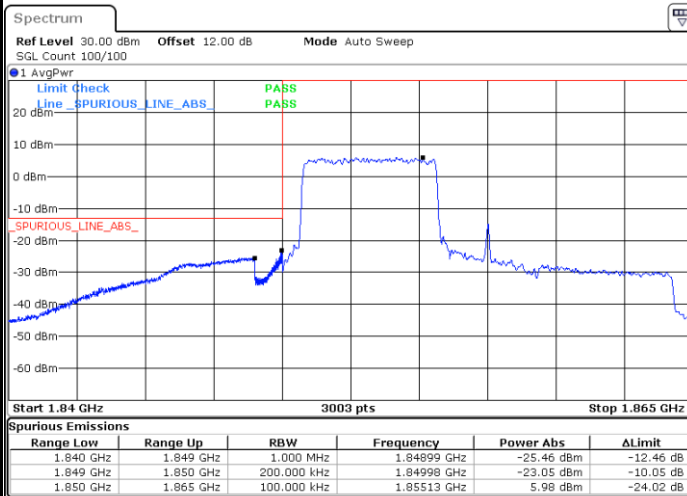

Date: 25.AUG.2023 01:12:22

Highest Band Edge / 27 RB

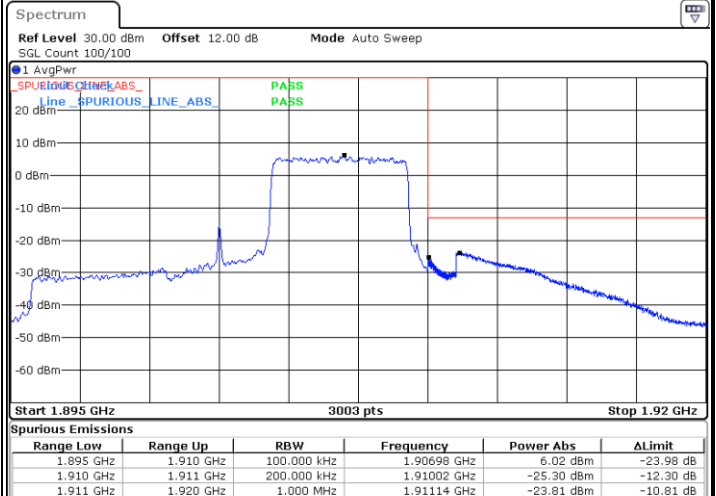

Date: 25.AUG.2023 20:01:31



LTE Band 2 / 20MHz / QPSK

Lowest Band Edge / Full RB

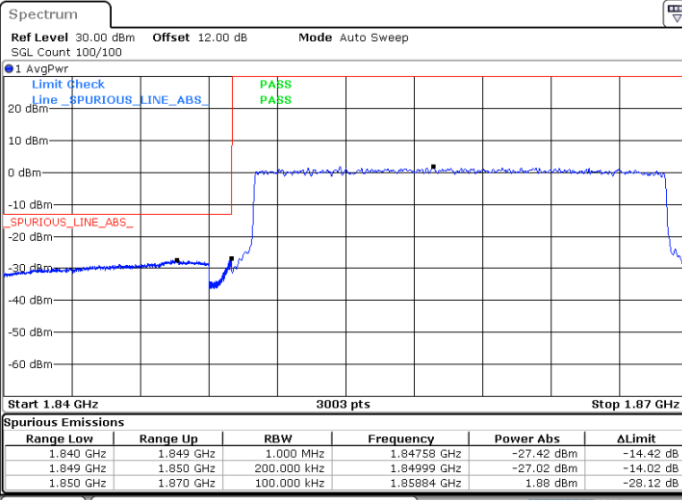

Date: 25.AUG.2023 01:19:49

Highest Band Edge / Full RB

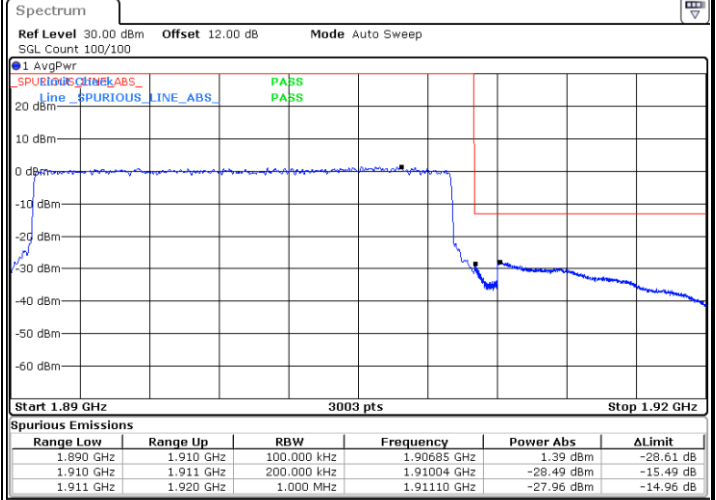

Date: 25.AUG.2023 02:07:00

LTE Band 2 / 20MHz / 16QAM

Lowest Band Edge / 27 RB

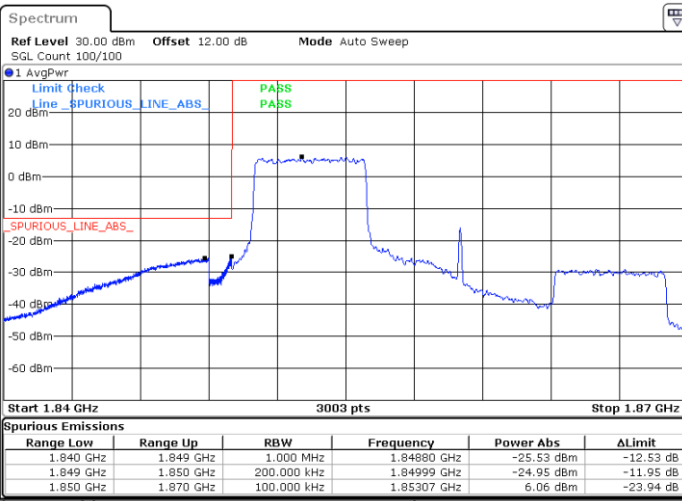

Date: 25.AUG.2023 01:20:43

Highest Band Edge / 27 RB

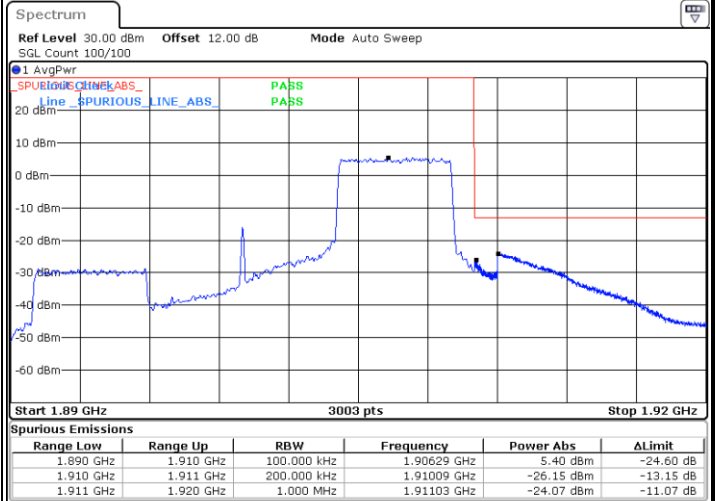

Date: 25.AUG.2023 20:09:37



# Conducted Spurious Emission

## LTE Band 2 / 1.4MHz

### Lowest Channel / QPSK

### Middle Channel / QPSK

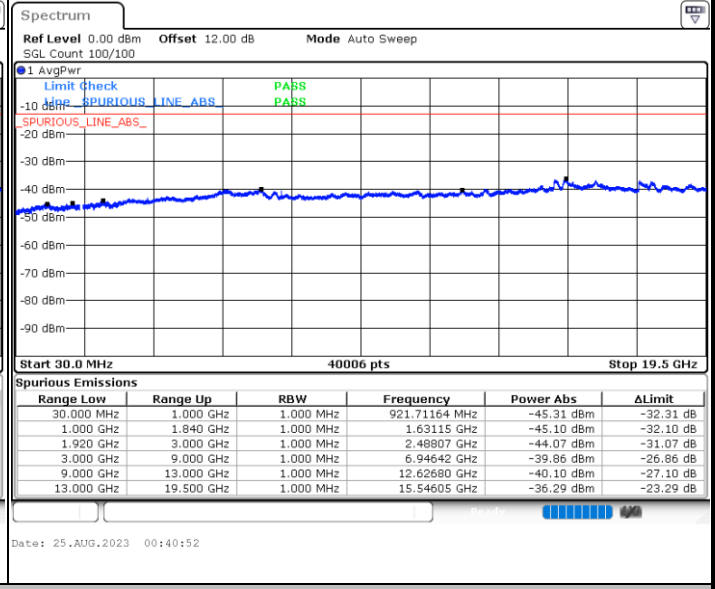
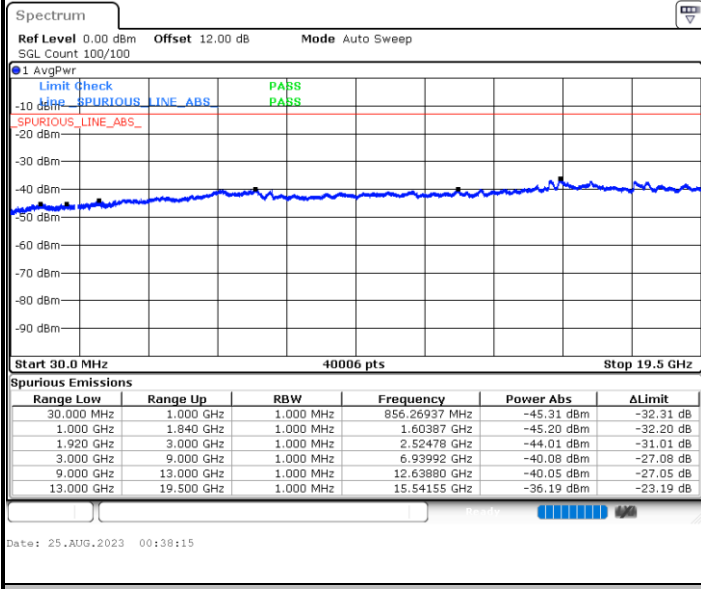

### Highest Channel / QPSK

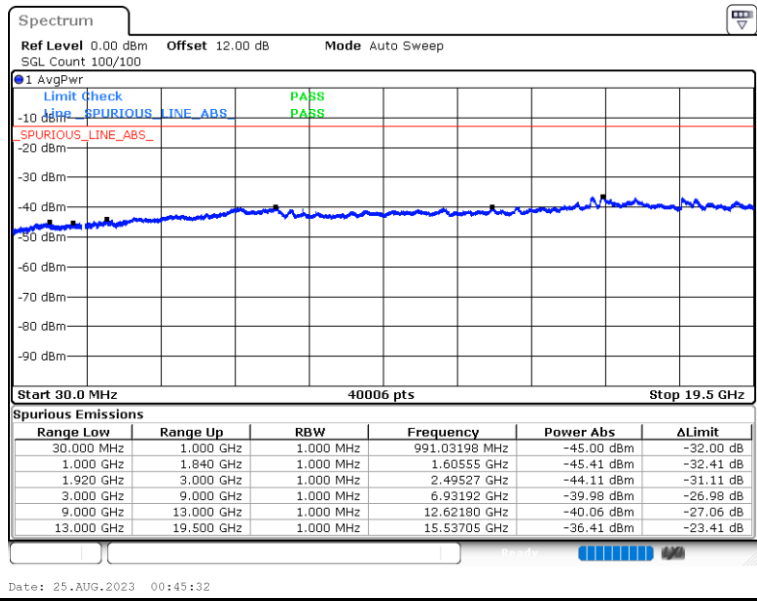



LTE Band 2 / 3MHz

Lowest Channel / QPSK

Middle Channel / QPSK

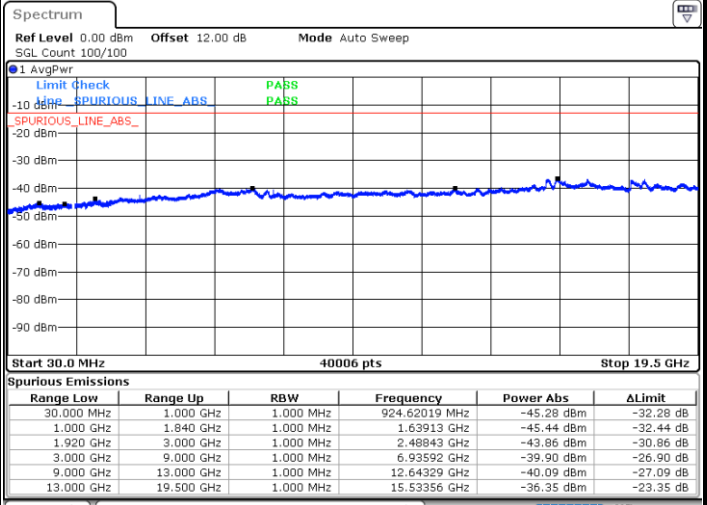
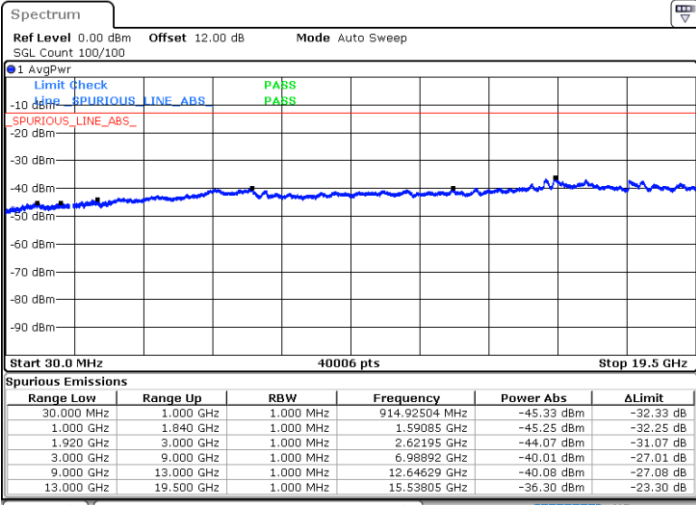

Date: 25.AUG.2023 00:49:58

Date: 25.AUG.2023 00:51:01

Highest Channel / QPSK

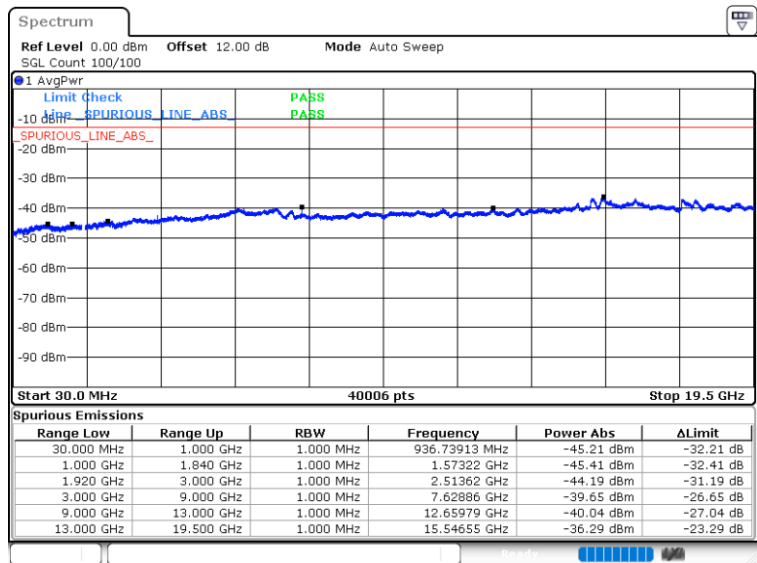

Date: 25.AUG.2023 00:52:03



LTE Band 2 / 5MHz

Lowest Channel / QPSK

Middle Channel / QPSK

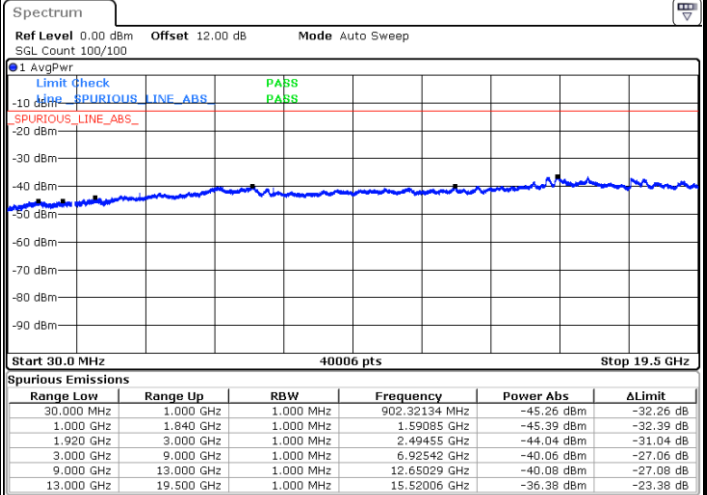
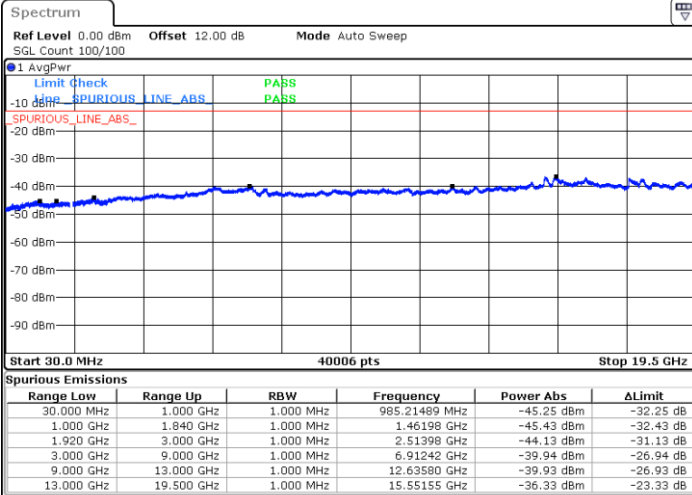

Date: 25.AUG.2023 01:00:07

Date: 25.AUG.2023 01:01:09

Highest Channel / QPSK

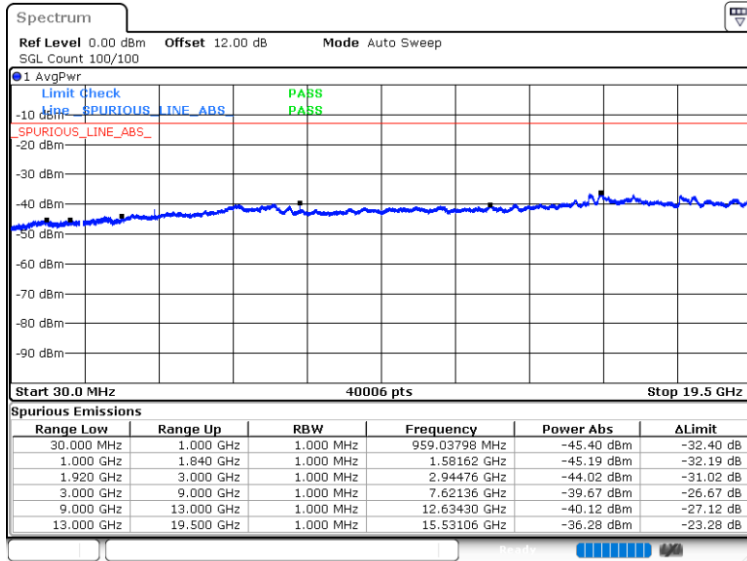

Date: 25.AUG.2023 01:02:12



LTE Band 2 / 10MHz

Lowest Channel / QPSK

Middle Channel / QPSK

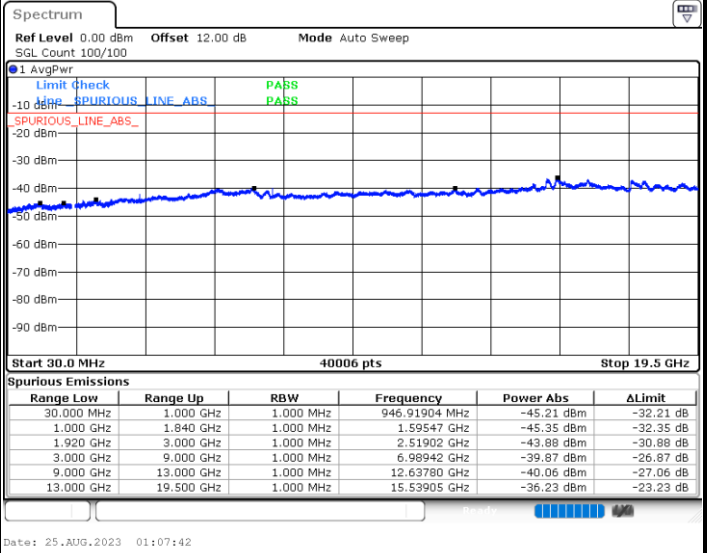
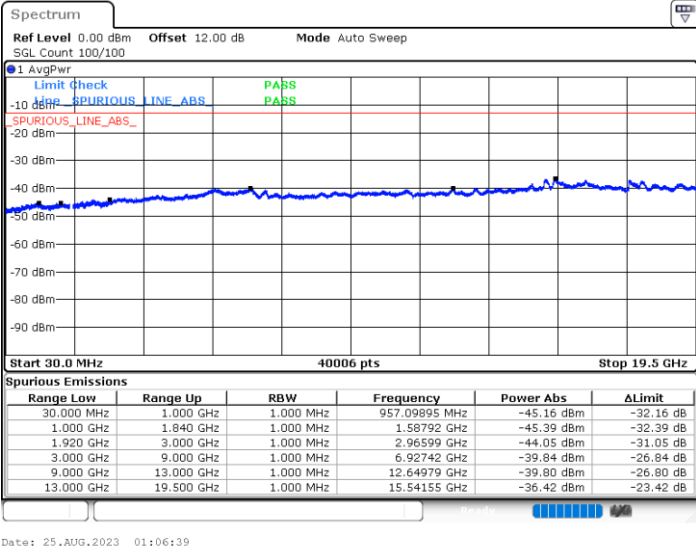

Highest Channel / QPSK

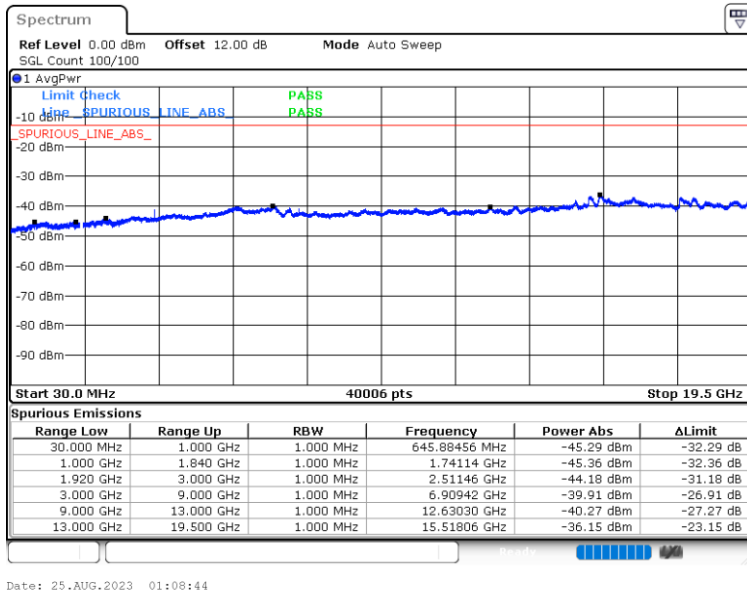



LTE Band 2 / 15MHz

Lowest Channel / QPSK

Middle Channel / QPSK

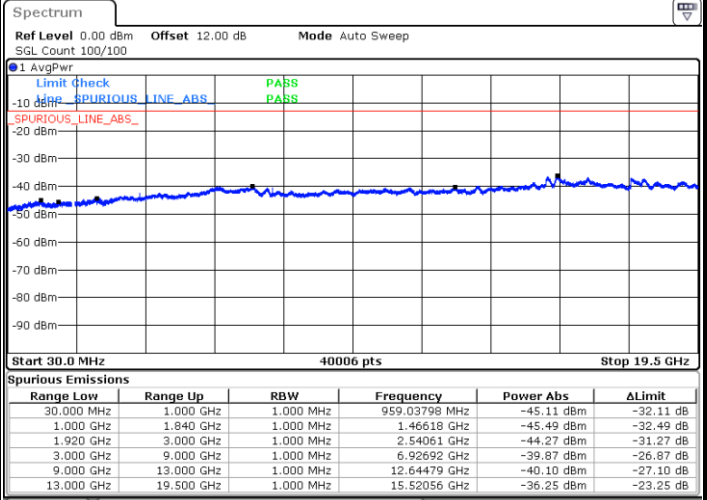
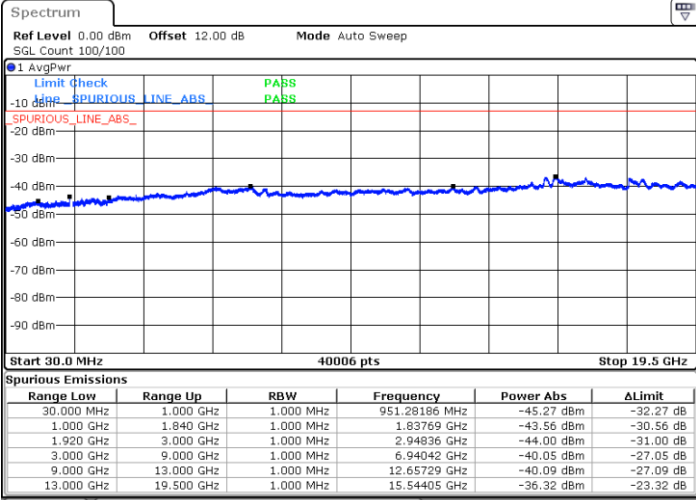

Date: 25.AUG.2023 01:16:50

Date: 25.AUG.2023 01:17:52

Highest Channel / QPSK

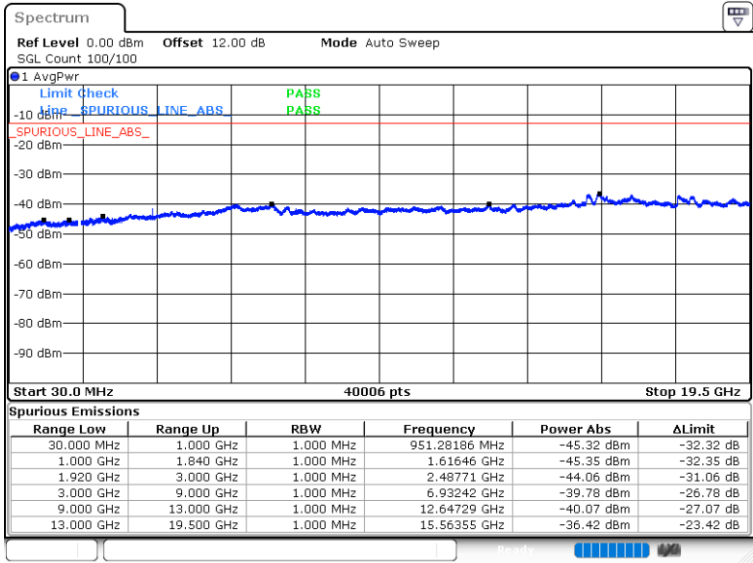

Date: 25.AUG.2023 01:18:55



LTE Band 2 / 20MHz

Lowest Channel / QPSK

Middle Channel / QPSK

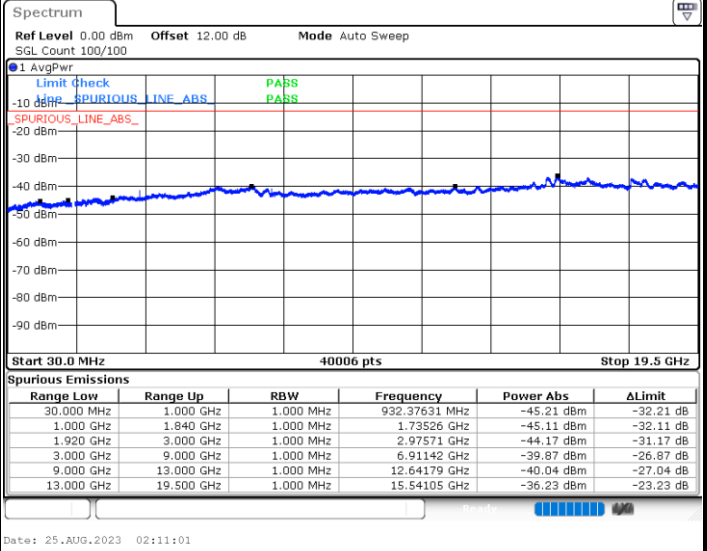
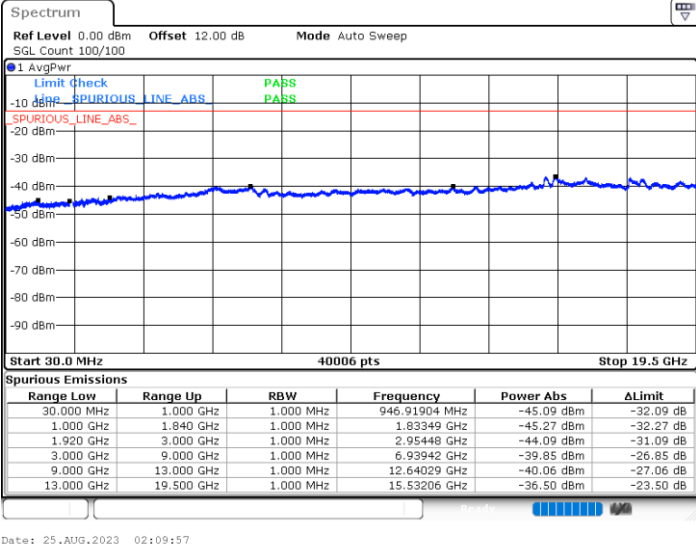

Highest Channel / QPSK

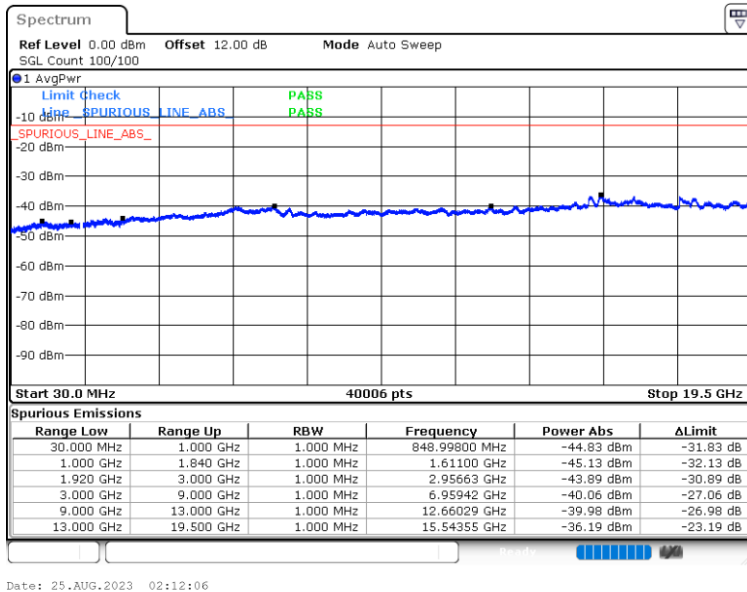





**Frequency Stability**

Test Conditions		LTE Band 2 (QPSK) / Middle Channel	Limit
Temperature (°C)	Voltage (Volt)	BW 10MHz	Note 2.
		Deviation (ppm)	Result
50	Normal Voltage	0.0064	PASS
40	Normal Voltage	0.0045	
30	Normal Voltage	0.0017	
20(Ref.)	Normal Voltage	0.0000	
10	Normal Voltage	0.0070	
0	Normal Voltage	0.0055	
-10	Normal Voltage	0.0017	
20	Maximum Voltage	0.0055	
20	Normal Voltage	0.0000	
20	Battery End Point	0.0085	

**Note:**

- 1. Normal Voltage = 3.8 V. ; Battery End Point (BEP) = 3.3 V. ; Maximum Voltage = 4.2 V.
- 2. The frequency fundamental emissions stay within the authorized frequency block.



# LTE Band 4

## Peak-to-Average Ratio

Mode	LTE Band 4 / 20MHz		
Mod.	QPSK	16QAM	Limit: 13dB
RB Size	Full RB	27 RB	Result
Middle CH	3.97	4.46	PASS

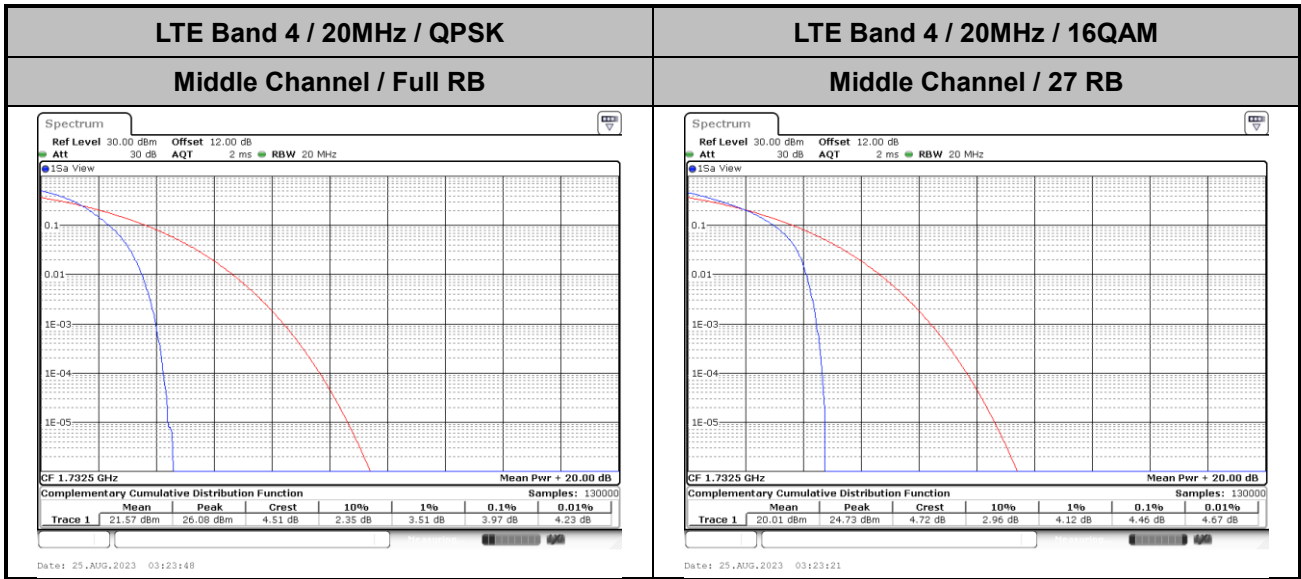



**26dB Bandwidth**

Mode	LTE Band 4 : 26dB BW(MHz)											
	1.4MHz		3MHz		5MHz		10MHz		15MHz		20MHz	
BW												
Mod.	QPSK	16QAM	QPSK	16QAM	QPSK	16QAM	QPSK	16QAM	QPSK	16QAM	QPSK	16QAM
Middle CH	1.25	1.29	3.02	3.01	4.83	4.91	9.67	5.42	14.24	5.54	18.82	5.75



LTE Band 4

Middle Channel / 1.4MHz / QPSK

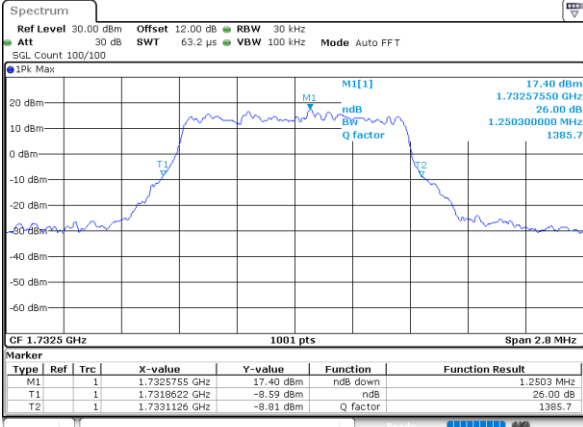

Date: 25\_AUG.2023 02:27:45

Middle Channel / 1.4MHz / 16QAM

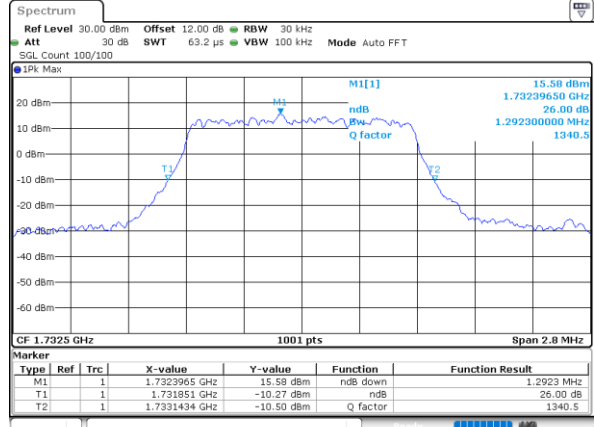

Date: 25\_AUG.2023 02:12:10

Middle Channel / 3MHz / QPSK

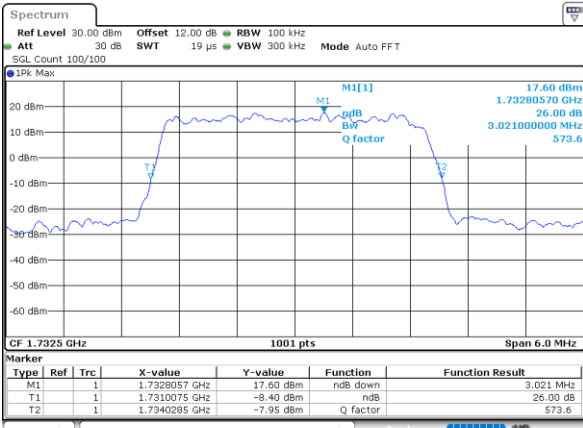

Date: 25\_AUG.2023 02:41:14

Middle Channel / 3MHz / 16QAM

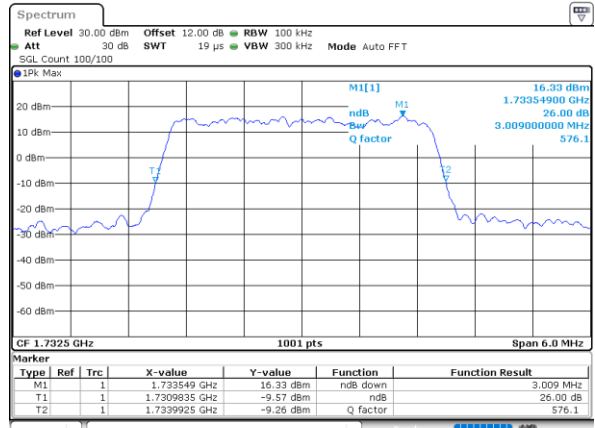

Date: 25\_AUG.2023 02:14:10

Middle Channel / 5MHz / QPSK

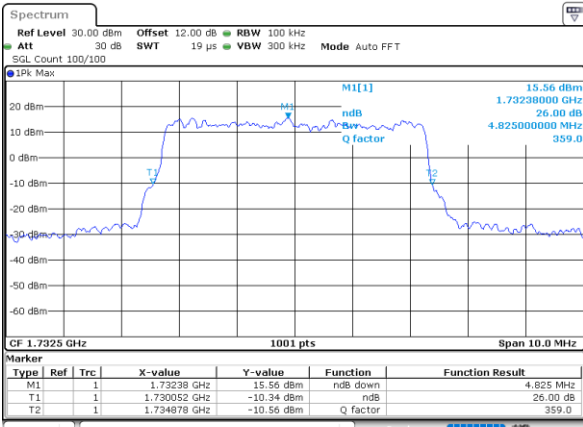

Date: 25\_AUG.2023 02:50:40

Middle Channel / 5MHz / 16QAM

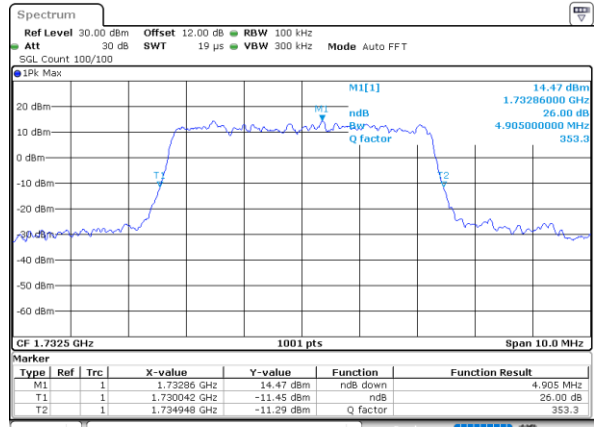

Date: 25\_AUG.2023 02:15:40



LTE Band 4

Middle Channel / 10MHz / QPSK

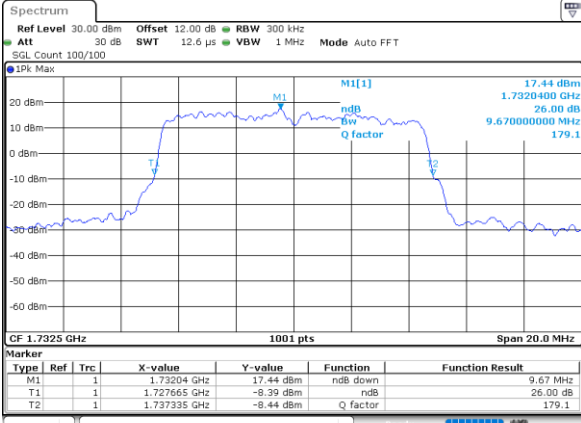

Date: 5.SEP.2023 20:48:54

Middle Channel / 10MHz / 16QAM

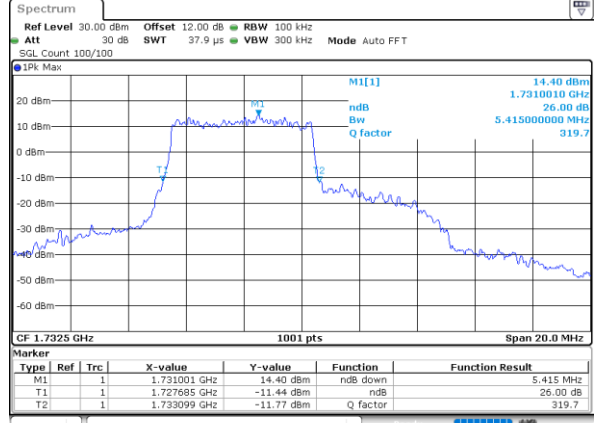

Date: 25.AUG.2023 02:58:53

Middle Channel / 15MHz / QPSK

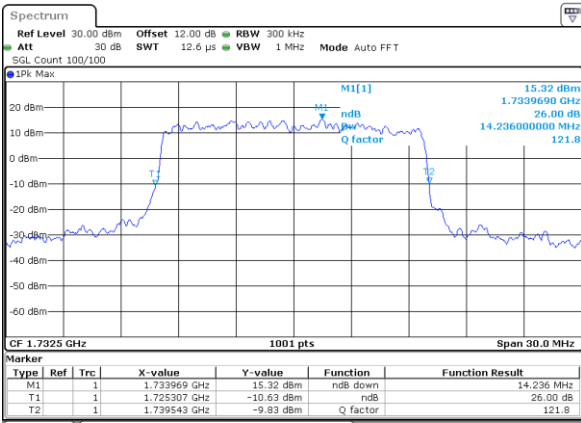

Date: 5.SEP.2023 20:48:23

Middle Channel / 15MHz / 16QAM

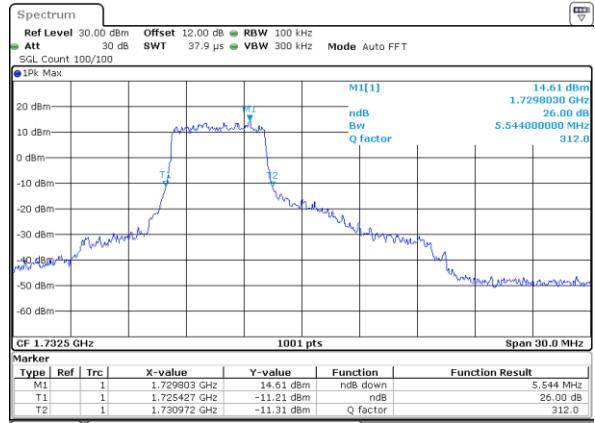

Date: 25.AUG.2023 03:08:21

Middle Channel / 20MHz / QPSK

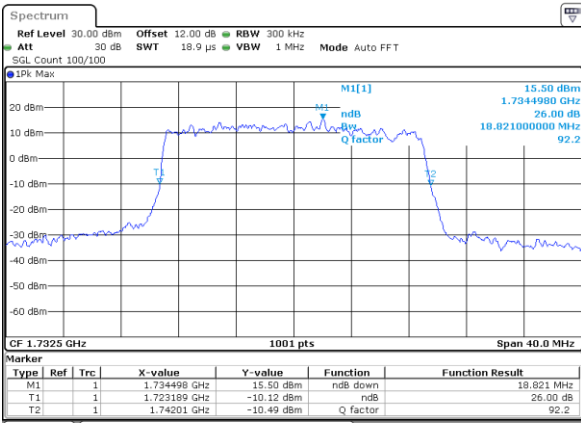

Date: 5.SEP.2023 20:45:11

Middle Channel / 20MHz / 16QAM

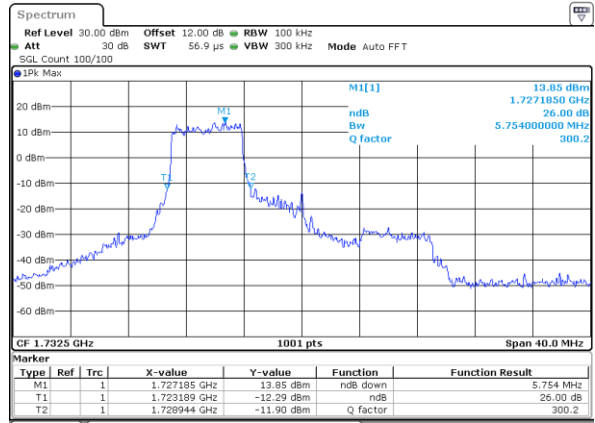

Date: 25.AUG.2023 03:17:47



### Occupied Bandwidth

Mode	LTE Band 4 : 99%OBW(MHz)											
	1.4MHz		3MHz		5MHz		10MHz		15MHz		20MHz	
Mod.	QPSK	16QAM	QPSK	16QAM	QPSK	16QAM	QPSK	16QAM	QPSK	16QAM	QPSK	16QAM
Middle CH	1.10	1.09	2.72	2.72	4.51	4.49	9.01	4.86	13.34	4.89	17.70	4.92



LTE Band 4

Middle Channel / 1.4MHz / QPSK

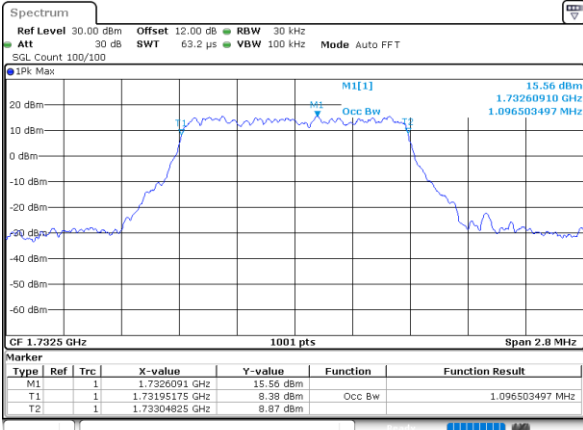

Date: 4,SEP,2023 22:16:44

Middle Channel / 1.4MHz / 16QAM

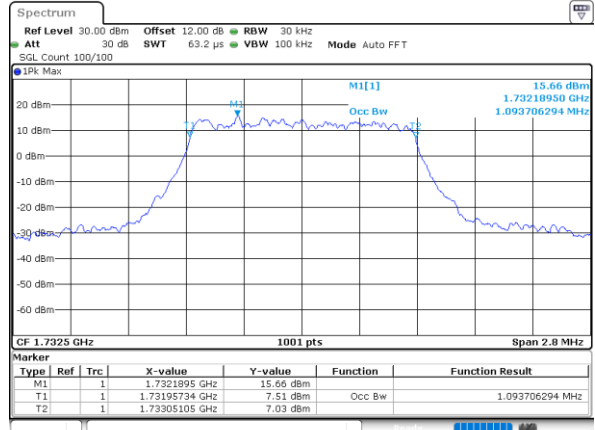

Date: 25,AUG,2023 02:12:15

Middle Channel / 3MHz / QPSK

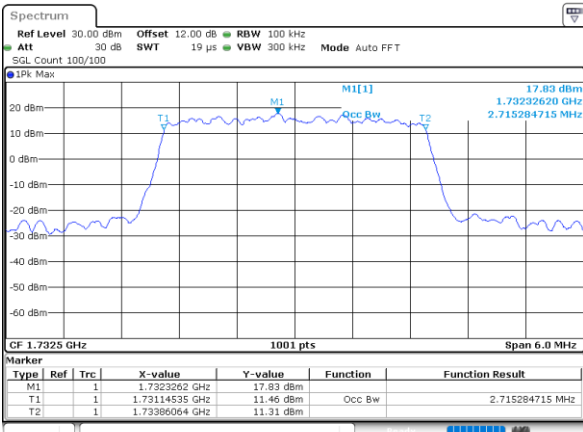

Date: 25,AUG,2023 02:18:09

Middle Channel / 3MHz / 16QAM

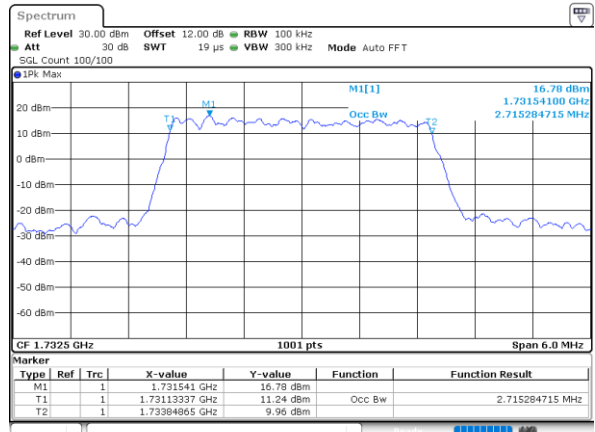

Date: 25,AUG,2023 02:18:14

Middle Channel / 5MHz / QPSK

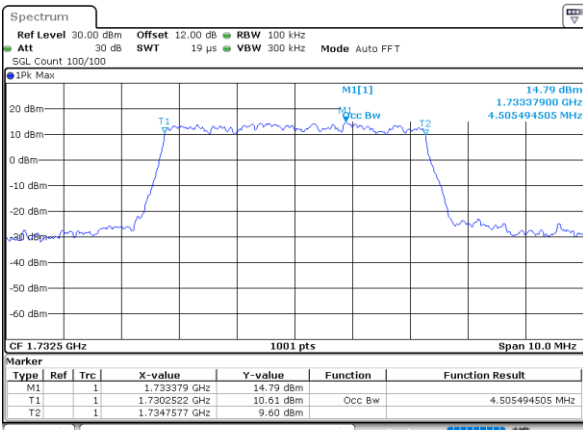

Date: 25,AUG,2023 02:19:49

Middle Channel / 5MHz / 16QAM

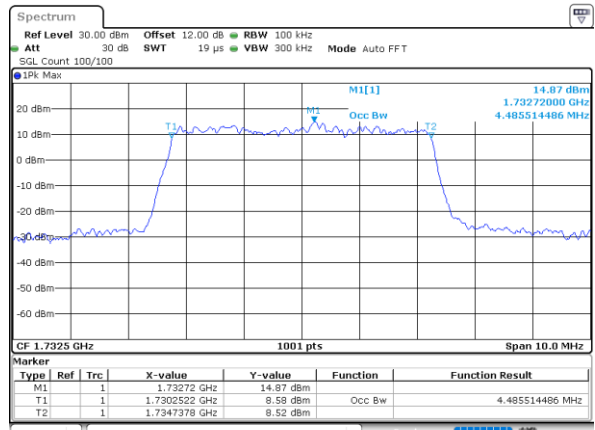

Date: 25,AUG,2023 02:15:15