



CERTIFICATION TEST REPORT

Report Number. : 11631998-E6V6

Applicant : Verifone, Inc.
1400 West Stanford Ranch Road
Rocklin, CA 95765, USA

FCC ID : B32V240MPLUS

IC ID : 787C- V240MPLUS

EUT Description : MOBILE POINT OF SALE TERMINAL

Test Standard(s) : FCC CFR47 PART 22 SUBPART H
FCC CFR47 PART 24 SUBPART E
INDUSTRY CANADA RSS-132 ISSUE 3
INDUSTRY CANADA RSS-133 ISSUE 6

Date Of Issue:

April 16, 2018

Prepared by:

UL Verification Services Inc.
47173 Benicia Street
Fremont, CA 94538, U.S.A.
TEL: (510) 771-1000
FAX: (510) 661-0888

Revision History

<u>Rev.</u>	<u>Issue Date</u>	<u>Revisions</u>	<u>Revised By</u>
V1	09/18/17	Initial Issue	Frank Ibrahim
V2	09/19/17	Updated sections 5.3 & 7.1	V. Tran
V3	10/04/17	Updated sections 5.2, 5.3 & 7.1	K. Kedida
V4	12/13/17	Updated section 7.1	Frank Ibrahim
V5	01/18/18	Added section 7.1 (Summary Table) and changed ERP to EIRP for ISED line item and revised some sections number for ISED Revised data for GSM850 for ISED	Frank Ibrahim
V6	04/16/18	Added HSUPA	Frank Ibrahim

TABLE OF CONTENTS

1.	ATTESTATION OF TEST RESULTS	5
2.	TEST METHODOLOGY	6
3.	FACILITIES AND ACCREDITATION	6
4.	CALIBRATION AND UNCERTAINTY	6
4.1.	MEASURING INSTRUMENT CALIBRATION	6
4.2.	SAMPLE CALCULATION	6
4.3.	MEASUREMENT UNCERTAINTY.....	7
5.	EQUIPMENT UNDER TEST	8
5.1.	DESCRIPTION OF EUT	8
5.2.	DESCRIPTION OF AVAILABLE ANTENNAS	8
5.3.	MAXIMUM OUTPUT POWER.....	9
5.3.1.	MAXIMUM OUTPUT POWER (GSM/EGPRS).....	9
5.3.2.	MAXIMUM OUTPUT POWER (WCDMA)	10
5.4.	DESCRIPTION OF TEST SETUP.....	11
6.	TEST AND MEASUREMENT EQUIPMENT	14
7.	ANTENNA PORT TEST RESULTS	15
7.1.	SUMMARY TABLE	15
7.2.	RF OUTPUT POWER.....	16
7.2.1.	GSM/GPRS/EDGE	17
7.2.2.	UMTS REL 99.....	21
7.2.3.	UMTS HSDPA and HSUPA	23
7.3.	PEAK TO AVERAGE RATIO	27
7.3.1.	GSM	28
7.3.2.	WCDMA.....	29
8.1.	OCCUPIED BANDWIDTH	30
8.1.1.	GSM	31
8.1.2.	WCDMA.....	33
8.2.	BAND EDGE EMISSIONS.....	35
8.2.1.	GSM	36
8.2.2.	WCDMA.....	38
8.3.	OUT OF BAND EMISSIONS.....	40
8.3.1.	GSM	41

8.3.2.	WCDMA.....	43
8.4	<i>FREQUENCY STABILITY</i>	45
8.4.1	GSM 850	46
8.4.2	GSM 1900	46
9.	RADIATED TEST RESULTS	47
9.1.	<i>FIELD STRENGTH OF SPURIOUS RADIATION</i>	47
9.1.1.	GSM	49
9.1.2.	WCDMA.....	50
10.	SETUP PHOTOS	51

1. ATTESTATION OF TEST RESULTS

COMPANY NAME: Verifone, Inc.
1400 West Stanford Ranch Road Suite 200
Rocklin, CA 95765, USA

EUT DESCRIPTION: Mobile Point of Sale Terminal

MODEL: V240m Plus 3GBW

SERIAL NUMBER: 313-855-587, 313-855-666

DATE TESTED: May 12 to September 12, 2017

APPLICABLE STANDARDS	
STANDARD	TEST RESULTS
FCC PART 22H, 24E	PASS
INDUSTRY CANADA RSS-132,133	PASS

UL Verification Services Inc. tested the above equipment in accordance with the requirements set forth in the above standards. All indications of Pass/Fail in this report are opinions expressed by UL Verification Services Inc. based on interpretations and/or observations of test results. Measurement Uncertainties were not taken into account and are published for informational purposes only. The test results show that the equipment tested is capable of demonstrating compliance with the requirements as documented in this report.

Note: The results documented in this report apply only to the tested sample, under the conditions and modes of operation as described herein. This document may not be altered or revised in any way unless done so by UL Verification Services Inc. and all revisions are duly noted in the revisions section. Any alteration of this document not carried out by UL Verification Services Inc. will constitute fraud and shall nullify the document. This report must not be used by the client to claim product certification, approval, or endorsement by NVLAP, NIST, any agency of the Federal Government, or any agency of any government.

Approved & Released For
UL Verification Services Inc. By:



FRANK IBRAHIM
CONSUMER TECHNOLOGY DIVISION
PROGRAM MANAGER
UL VERIFICATION SERVICES INC

Prepared By:



KIYA KEDIDA
CONSUMER TECHNOLOGY DIVISION
ENGINEER
UL VERIFICATION SERVICES INC

2. TEST METHODOLOGY

The tests documented in this report were performed in accordance with TIA-603-D, FCC CFR 47 Part 2, FCC KDB 971168 D01 v02r02, FCC Part 22 and Part 24, RSS-132, RSS-133, and RSS-GEN Issue 4.

3. FACILITIES AND ACCREDITATION

The test sites and measurement facilities used to collect data are located at 47173 and 47266 Benicia Street, Fremont, California, USA. Line conducted emissions are measured only at the 47173 address. The following table identifies which facilities were utilized for radiated emission measurements documented in this report. Specific facilities are also identified in the test results sections.

47173 Benicia Street	47266 Benicia Street
<input type="checkbox"/> Chamber A(IC: 2324B-1)	<input type="checkbox"/> Chamber D(IC: 22541-1)
<input type="checkbox"/> Chamber B(IC: 2324B-2)	<input type="checkbox"/> Chamber E(IC: 22541-2)
<input checked="" type="checkbox"/> Chamber C(IC: 2324B-3)	<input type="checkbox"/> Chamber F(IC: 22541-3)
	<input type="checkbox"/> Chamber G(IC: 22541-4)
	<input type="checkbox"/> Chamber H(IC: 22541-5)

The above test sites and facilities are covered under FCC Test Firm Registration # 208313.

UL Verification Services Inc. is accredited by NVLAP, Laboratory Code 200065-0.

Chambers A through C are covered under Industry Canada company address code 2324B with site numbers 2324B -1 through 2324B-3, respectively. Chambers D through H are covered under Industry Canada company address code 22541 with site numbers 22541 -1 through 22541-5, respectively.

4. CALIBRATION AND UNCERTAINTY

4.1. MEASURING INSTRUMENT CALIBRATION

The measuring equipment utilized to perform the tests documented in this report has been calibrated in accordance with the manufacturer's recommendations, and is traceable to recognized national standards

4.2. SAMPLE CALCULATION

Where relevant, the following sample calculation is provided:

EIRP = PSA reading with EUT worst orientation (dBm) + Path loss (dB) – cable loss(
between the SG and substitution antenna) + Substitution Antenna Factor (dBi)

ERP = PSA reading with EUT worst orientation (dBm) + Path loss (dB) – cable loss(
between the SG and substitution antenna)

(Path loss = Signal generator output – PSA reading with substitution antenna)

4.3. MEASUREMENT UNCERTAINTY

Where relevant, the following measurement uncertainty levels have been estimated for tests performed on the apparatus:

PARAMETER	UNCERTAINTY
Occupied Channel Bandwidth	±1.1 %
RF output power, conducted	±0.35 dB
Power Spectral Density, conducted	±0.39 dB
Unwanted Emissions, conducted	±2.9 dB
All emissions, radiated	±5.36 dB
Temperature	±0.9 °C
Humidity	±2.26% RH
Supply Voltages	±0.45 %
Time	±0.2 %

Uncertainty figures are valid to a confidence level of 95%.

5. EQUIPMENT UNDER TEST

5.1. DESCRIPTION OF EUT

The EUT is the Mobile Point of Sale Terminal which contains an 11a/b/g/n/ac W-LAN + Bluetooth 4.1 combo module, and GSM/WCDMA radio module.

5.2. DESCRIPTION OF AVAILABLE ANTENNAS

The radio utilizes a PIFA antenna for the [List the bands supported] with a maximum peak gain as follow:

Frequency (MHz)	Peak Gain (dBi)
GSM850, 824~849MHz	-2.0
GSM1900, 1850~1910MHz	-0.4
WCDMA Band 2, 1850~1910MHz	-0.4
WCDMA Band 5, 824~849	-2.0

5.3. MAXIMUM OUTPUT POWER

5.3.1. MAXIMUM OUTPUT POWER (GSM/EGPRS)

The transmitter has a maximum peak conducted and ERP / EIRP output powers as follows:

FCC Part 22/24						
Band	Frequency Range(MHz)	Modulation	Conducted (Average)		ERP/EIRP (Average)	
			AVG(dBm)	AVG(mW)	dBm	mW
850	824~849	GPRS	31.65	1462.18	27.50	562.34
	824~849	EGPRS	26.00	398.11	21.85	153.11
1900	1850~1910	GPRS	28.78	755.09	28.38	688.65
	1850~1910	EGPRS	24.80	302.00	24.40	275.42

RSS 132/133						
Band	Frequency Range(MHz)	Modulation	Conducted (Average)		EIRP (Average)	
			AVG(dBm)	AVG(mW)	dBm	mW
850	824~849	GPRS	31.65	1462.18	29.65	922.57
	824~849	EGPRS	26.00	398.11	24.00	251.19
1900	1850~1910	GPRS	28.78	755.09	28.38	688.65
	1850~1910	EGPRS	24.80	302.00	24.40	275.42

5.3.2. MAXIMUM OUTPUT POWER (WCDMA)

The transmitter has a maximum peak conducted and ERP / EIRP output powers as follows:

FCC Part 24 & RSS 133						
Band	Frequency Range(MHz)	Modulation	Conducted (Average)		ERP/EIRP (Average)	
			AVG(dBm)	AVG(mW)	dBm	mW
Band 2	1850~1910	REL99	22.30	169.8	21.90	154.9
	1850~1910	HSDPA	22.72	187.1	22.32	170.6
	1850~1910	HSUPA	21.53	142.2	21.13	129.7

FCC Part 22 & RSS 132						
Band	Frequency Range(MHz)	Modulation	Conducted (Average)		ERP/EIRP (Average)	
			AVG(dBm)	AVG(mW)	dBm	mW
Band 5	824~849	REL99	22.82	191.4	18.67	73.6
	824~849	HSDPA	21.46	140.0	17.31	53.8
	824~849	HSUPA	21.67	146.9	17.52	56.5

5.4. DESCRIPTION OF TEST SETUP

SUPPORT EQUIPMENT

Support Equipment List				
Description	Manufacturer	Model	Serial Number	FCC ID
AC Adapter	Verifone	SC1402	1708200053701	NA

I/O CABLES (CONDUCTED SETUP)

I/O Cable List						
Cable No	Port	# of Identical ports	Connector Type	Serial Type	Cable Length (m)	Remarks
1	RF Out	1	Spectrum Analyzer	Shielded	None	NA
2	Antenna Port	1	EUT	Shielded	0.1m	NA
3	RF In/Out	1	Communication Test Set	Shielded	1m	NA

I/O CABLES (RADIATED SETUP)

I/O Cable List						
Cable No	Port	# of Identical ports	Connector Type	Serial Type	Cable Length (m)	Remarks
1	DC	1	Round	Un-shielded	1.75m	No
2	RF In/out	1	Communication Test Set	Un-shielded	2m	Yes

TEST SETUP

The EUT is continuously communicated to the call box during the tests.

SETUP DIAGRAM FOR TESTS (CONDUCTED TEST SETUP)

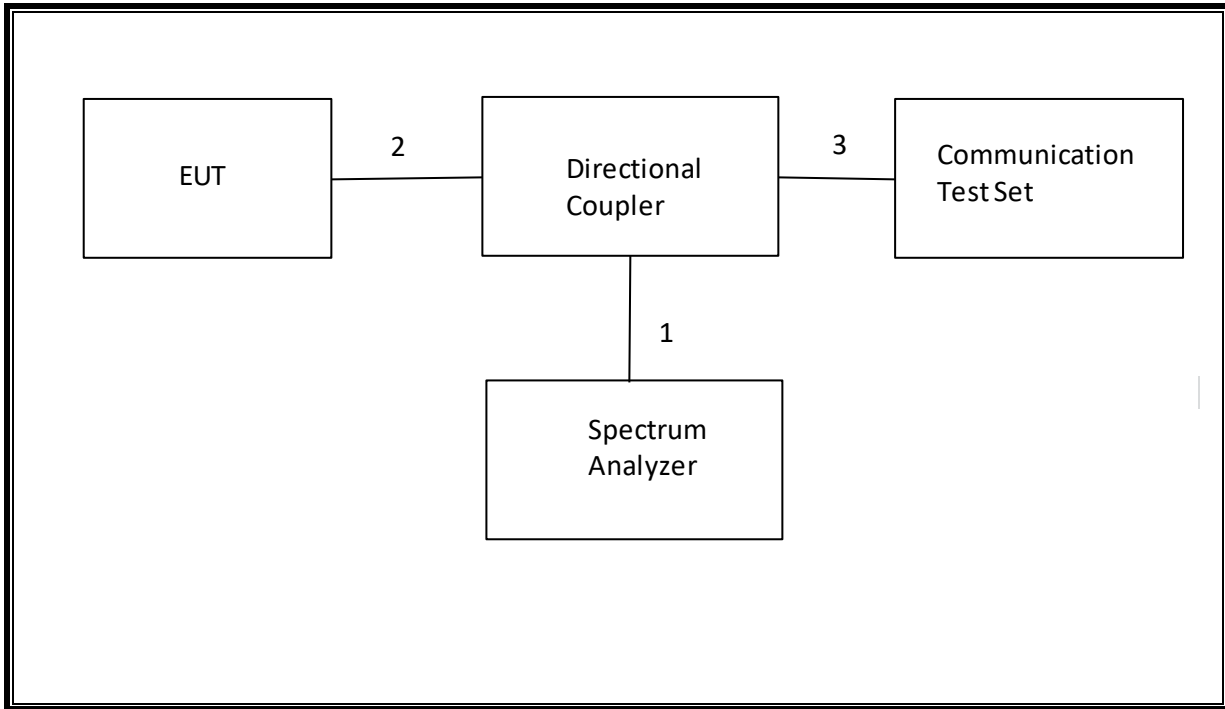

SETUP DIAGRAM FOR TESTS (RADIATED TEST SETUP)

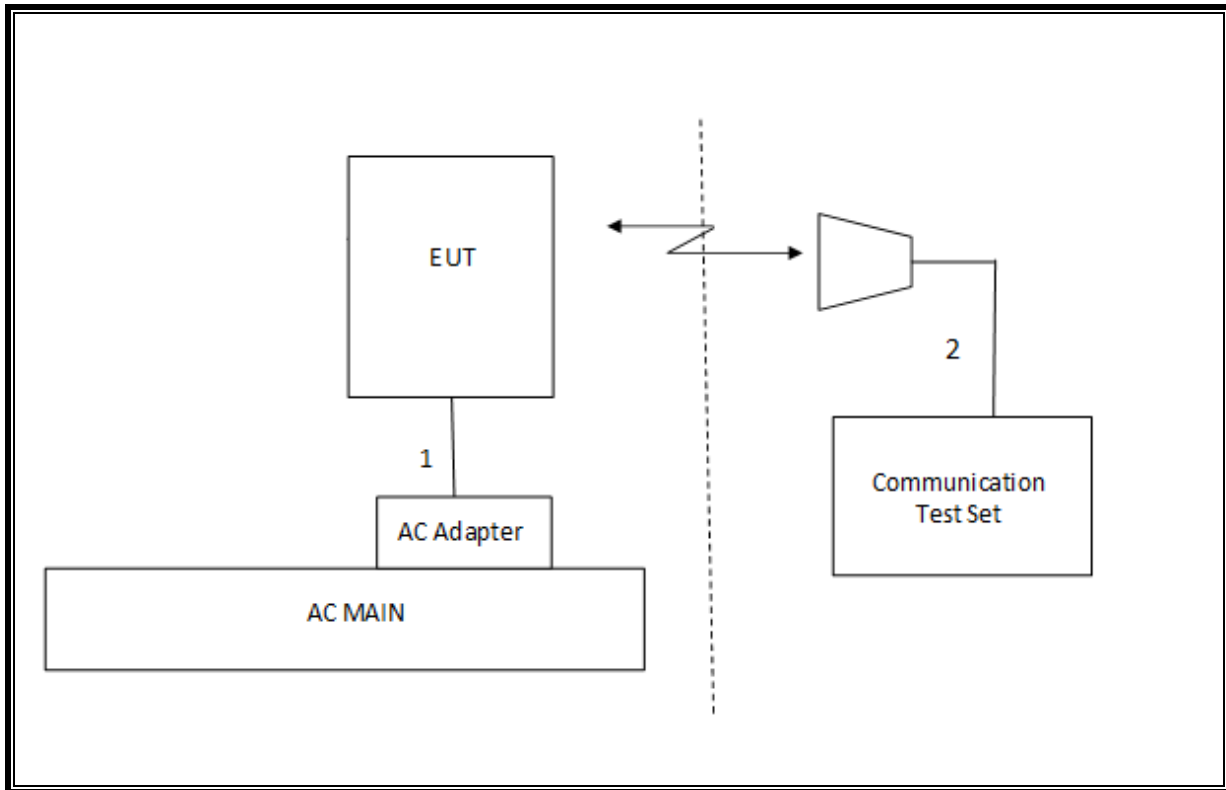

6. TEST AND MEASUREMENT EQUIPMENT

The following test and measurement equipment was utilized for the tests documented in this report:

Test Equipment List					
Description	Manufacturer	Model	T Number	Cal Date	Cal Due
Amplifier, 1 to 18 GHz	Miteq	AFS43-00101800-25-S-42	493	02/15/17	02/15/18
Amplifier, 1 to 8 GHz	Miteq	AMF-4D-01000800-30-29P	1156	02/15/17	02/15/18
Amplifier, 10KHz to 1GHz, 32dB	Keysight	8447D	10	02/15/17	02/15/18
Antenna, Broadband Hybrid, 30MHz to 2000MHz	Sunol Sciences	JB3	408	11/10/16	11/10/17
Horn Antenna	ETS-Lindgren	3117	T712	01/30/17	01/30/18
Spectrum Analyzer, PXA 3Hz to 44GHz	Keysight	N9030A	907	01/23/17	01/23/18
Highpass Filter, 2.7 GHz	Micro-Circuits	H2G518G6	T772	07/05/16	07/05/18
Highpass Filter, 1 GHz	Micro-Tronics	HPM18129	T889	02/21/17	02/21/18
Highpass Filter, 4GHz	Micro-Tronics	HPM13351	T1241	07/19/17	07/19/18
Wideband Radio Communication Tester	Rohde & Schwarz	CMW500	T956	None	None
PXA, Signal Analyzer	Agilent Technologies	N9030A	T1931	06/06/17	06/06/18
DC power supply, 8 V @ 3 A or 15 V @ 2 A	Agilent / HP	E3610A	None	CNR	None
Antenna, Tuned Dipole 400~1000 MHz	ETS	3121C DB4	T273	06/08/17	06/08/18
Directional Coupler	Mini-Circuits	ZUDC10-183+	T1136	06/18/17	06/18/18

Test Equipment List			
Description	Manufacturer	Model	T Number
Radiated Software	UL	UL EMC	Ver 9.5, June 24, 2015
Conducted Software	UL	UL EMC	Ver 9.5, May 26, 2015
CLT Software	UL	UL RF	Ver 1.0, Feb 2, 2015
Antenna Port Software	UL	UL RF	Ver 3.7, Nov 12, 2015

7. ANTENNA PORT TEST RESULTS

7.1. SUMMARY TABLE

FCC Part Section	RSS Section(s)	Test Description	Test Limit	Test Condition	Test Result
2.1049	N/A	Occupied Bandwidth (99%)	N/A	Conducted	Pass
22.917(a) 24.238(a)	RSS-132(5.5) RSS-133(6.5)	Band Edge / Conducted Spurious Emission	-13dBm		Pass
2.1046	N/A	Conducted output power	N/A		Pass
22.355 24.235	RSS-132(5.3) RSS-133(6.3)	Frequency Stability	2.5PPM		Pass
22.913(a)(2)	RSS-132 (5.4)	Effective Radiated Power (FCC) Equivalent Isotropic Radiated Power (ISED)	38dBm	Radiated	Pass
24.232(c)	RSS-133(6.4)	Equivalent Isotropic Radiated Power	33dBm		Pass
22.917(a) 24.238(a)	RSS-132(5.5) RSS-133(6.5)	Radiated Spurious Emission	-13dBm		Pass

7.2. RF OUTPUT POWER

TEST PROCEDURE

ANSI C63.26:2015/ TIA / EIA 603-D Clause 2.2.17
KDB 971168 Section 5.6

$$\text{ERP/EIRP} = \text{PMeas} + \text{GT} - \text{LC}$$

where: ERP/EIRP = effective or equivalent radiated power, respectively (expressed in the same units as PMeas, typically dBW or dBm);

PMeas = measured transmitter output power or PSD, in dBm or dBW;

GT = gain of the transmitting antenna, in dBd (ERP) or dBi (EIRP);

LC = signal attenuation in the connecting cable between the transmitter and antenna, in dB.

For devices utilizing multiple antennas, KDB 662911 provides guidance for determining the effective array transmit antenna gain term to be used in the above equation.

MODES TESTED

- GSM 850
- GSM 1900
- WCDMA Band 2
- WCDMA Band 5

7.2.1. GSM/GPRS/EDGE

Using CMW500 Communication Test Set

Function: Menu select > GSM Mobile Station > GSM 850/900/1800/1900

Press Connection control to choose the different menus

Press RESET > choose all to reset all settings

Connection	Press Signal Off to turn off the signal and change settings Network Support > GSM+GPRS or GSM+EGPRS Main Service > Packet Data Service selection > Test Mode A – Auto Slot Config. off
MS Signal	Press Slot Config bottom on the right twice to select and change the number of time slots and power setting > Slot configuration > Uplink/Gamma > 33 dBm for GPRS 850/900 > 27 dBm for EGPRS 850/900 > 30 dBm for GPRS1800/1900 > 26 dBm for EGPRS1800/1900
BS Signal	Enter the same channel number for TCH channel (test channel) and BCCH channel Frequency Offset > + 0 Hz Mode > BCCH and TCH BCCH Level > -85 dBm (May need to adjust if link is not stable) BCCH Channel > choose desire test channel [Enter the same channel number for TCH channel (test channel) and BCCH channel] Channel Type > Off P0> 4 dB Slot Config > Unchanged (if already set under MS Signal) TCH > choose desired test channel Hopping > Off Main Timeslot > 3 (Default)
Network	Coding Scheme > CS 4 (GPRS) and MCS5-9 (EGPRS) Bit Stream > 2E9-1PSR Bit Pattern
AF/RF	Enter appropriate offsets for Ext. Att. Output and Ext. Att. Input
Connection	Press Signal On to turn on the signal and change settings

GSM OUTPUT POWER RESULT

Tested By	Vanessa Moestopo
Date	5/12/2017

GSM 850 (FCC)

Antenna gain (dBi)		-2.00					
Mode	Ch.	f (MHz)	Modulation	Conducted Average (dBm)	ERP Average (dBm)	ERP Limit (dBm)	Margin (dB)
GPRS	128	824.2	1 Time slot	31.65	27.50	38.5	-11.00
	190	836.6		31.22	27.07	38.5	-11.43
	251	848.8		30.40	26.25	38.5	-12.25
	128	824.2	2 Time slot	28.87	24.72	38.5	-13.78
	190	836.6		28.44	24.29	38.5	-14.21
	251	848.8		27.71	23.56	38.5	-14.94
	128	824.2	3 Time slot	27.10	22.95	38.5	-15.55
	190	836.6		26.67	22.52	38.5	-15.98
	251	848.8		25.95	21.80	38.5	-16.70
	128	824.2	4 Time slot	25.97	21.82	38.5	-16.68
	190	836.6		25.53	21.38	38.5	-17.12
	251	848.8		24.80	20.65	38.5	-17.85
EGPRS	128	824.2	1 Time slot	26.00	21.85	38.5	-16.65
	190	836.6		25.60	21.45	38.5	-17.05
	251	848.8		24.80	20.65	38.5	-17.85
	128	824.2	2 Time slot	23.00	18.85	38.5	-19.65
	190	836.6		22.60	18.45	38.5	-20.05
	251	848.8		21.90	17.75	38.5	-20.75
	128	824.2	3 Time slot	21.20	17.05	38.5	-21.45
	190	836.6		20.80	16.65	38.5	-21.85
	251	848.8		20.10	15.95	38.5	-22.55
	128	824.2	4 Time slot	20.10	15.95	38.5	-22.55
	190	836.6		19.60	15.45	38.5	-23.05
	251	848.8		18.90	14.75	38.5	-23.75

GSM 850 (ISED)

Antenna gain (dBi)		-2.00					
Mode	Ch.	f (MHz)	Modulation	Conducted Average (dBm)	EIRP Average (dBm)	EIRP Limit (dBm)	Margin (dB)
GPRS	128	824.2	1 Time slot	31.65	29.65	38.5	-8.85
	190	836.6		31.22	29.22	38.5	-9.28
	251	848.8		30.40	28.40	38.5	-10.10
	128	824.2	2 Time slot	28.87	26.87	38.5	-11.63
	190	836.6		28.44	26.44	38.5	-12.06
	251	848.8		27.71	25.71	38.5	-12.79
	128	824.2	3 Time slot	27.10	25.10	38.5	-13.40
	190	836.6		26.67	24.67	38.5	-13.83
	251	848.8		25.95	23.95	38.5	-14.55
	128	824.2	4 Time slot	25.97	23.97	38.5	-14.53
	190	836.6		25.53	23.53	38.5	-14.97
	251	848.8		24.80	22.80	38.5	-15.70
EGPRS	128	824.2	1 Time slot	26.00	24.00	38.5	-14.50
	190	836.6		25.60	23.60	38.5	-14.90
	251	848.8		24.80	22.80	38.5	-15.70
	128	824.2	2 Time slot	23.00	21.00	38.5	-17.50
	190	836.6		22.60	20.60	38.5	-17.90
	251	848.8		21.90	19.90	38.5	-18.60
	128	824.2	3 Time slot	21.20	19.20	38.5	-19.30
	190	836.6		20.80	18.80	38.5	-19.70
	251	848.8		20.10	18.10	38.5	-20.40
	128	824.2	4 Time slot	20.10	18.10	38.5	-20.40
	190	836.6		19.60	17.60	38.5	-20.90
	251	848.8		18.90	16.90	38.5	-21.60

GSM 1900

Antenna gain (dBi)		-0.40					
Mode	Ch.	f (MHz)	Modulation	Conducted Average (dBm)	EIRP Average (dBm)	EIRP Limit (dBm)	Margin (dB)
GPRS	512	1850.2	1 Time slot	28.78	28.38	33.0	-4.62
	661	1880		28.64	28.24	33.0	-4.76
	810	1909.8		28.37	27.97	33.0	-5.03
	512	1850.2	2 Time slot	25.93	25.53	33.0	-7.47
	661	1880		25.79	25.39	33.0	-7.61
	810	1909.8		25.51	25.11	33.0	-7.89
	512	1850.2	3 Time slot	24.17	23.77	33.0	-9.23
	661	1880		24.00	23.60	33.0	-9.40
	810	1909.8		23.24	22.84	33.0	-10.16
	512	1850.2	4 Time slot	22.97	22.57	33.0	-10.43
	661	1880		22.79	22.39	33.0	-10.61
	810	1909.8		22.53	22.13	33.0	-10.87
EGPRS	512	1850.2	1 Time slot	24.80	24.40	33.0	-8.60
	661	1880		24.60	24.20	33.0	-8.80
	810	1909.8		24.30	23.90	33.0	-9.10
	512	1850.2	2 Time slot	21.80	21.40	33.0	-11.60
	661	1880		21.60	21.20	33.0	-11.80
	810	1909.8		21.40	21.00	33.0	-12.00
	512	1850.2	3 Time slot	20.00	19.60	33.0	-13.40
	661	1880		19.80	19.40	33.0	-13.60
	810	1909.8		19.60	19.20	33.0	-13.80
	512	1850.2	4 Time slot	18.90	18.50	33.0	-14.50
	661	1880		18.70	18.30	33.0	-14.70
	810	1909.8		18.40	18.00	33.0	-15.00

7.2.2. UMTS REL 99

TEST PROCEDURE

Release 99 Setup Procedures used to establish the test signals

The following tests were completed according to the test requirements outlined in section 5.2 of the 3GPP TS34.121-1 specification. The DUT supports power Class 3, which has a nominal maximum output power of 24 dBm (+1.7/-3.7).

The following summary of these settings are illustrated below:

Mode	Subtest	Rel99
WCDMA General Settings	Loopback Mode	Test Mode 2
	Rel99 RMC	12.2kbps RMC
	Power Control Algorithm	Algorithm2
	β_c/β_d	8/15

RESULTS

UMTS REL 99 OUTPUT POWER RESULT

Tested By	Vanessa Moestopo
Date	6/27/2017

Antenna gain Band 5 (dBi)	-2.00
Antenna gain Band 2 (dBi)	-0.40

Part 22 / RSS 132 850MHz Band (5)

Band	UL Channel	DL Channel	Frequency (MHz)	Conducted Average (dBm)	ERP Average (dBm)	ERP Limit (dBm)	Margin (dB)
UMTS Rel. 99 850MHz	4132	4357	826.4	22.82	18.67	38.5	-19.8
	4183	4408	836.6	22.27	18.12	38.5	-20.4
	4233	4458	846.6	21.75	17.60	38.5	-20.9

Part 24 / RSS 133 1900MHz Band (2)

Band	UL Channel	DL Channel	Frequency (MHz)	Peak Power (dBm)	EIRP Average (dBm)	EIRP Limit (dBm)	Margin (dB)
UMTS Rel. 99 1900MHz	9262	9662	1852.4	22.30	21.90	33.0	-11.1
	9400	9800	1880.0	22.10	21.70	33.0	-11.3
	9538	9938	1907.6	21.23	20.83	33.0	-12.2

7.2.3. UMTS HSDPA and HSUPA

HSDPA Setup Procedures used to establish the test signals

The following 4 Sub-tests were completed according to Release 5 procedures in section 5.2 of 3GPP TS34.121.

Summary of settings are illustrated below:

	Mode	HSDPA	HSDPA	HSDPA	HSDPA
	Subtest	1	2	3	4
W-CDMA General Settings	Loopback Mode	Test Mode 1			
	Rel99 RMC	12.2kbps RMC			
	HSDPA FRC	H-Set 1			
	Power Control Algorithm	Algorithm 2			
	β_c	2/15	11/15	15/15	15/15
	β_d	15/15	15/15	8/15	4/15
	Bd (SF)	64			
	β_c/β_d	2/15	11/15	15/8	15/4
	β_{hs}	4/15	24/15	30/15	30/15
MPR (dB)	0	0	0.5	0.5	
HSDPA Specific Settings	D_{ACK}	8			
	D_{NAK}	8			
	DCQI	8			
	Ack-Nack repetition factor	3			
	CQI Feedback (Table 5.2B.4)	4ms			
	CQI Repetition Factor (Table 5.2B.4)	2			
	$A_{hs}=\beta_{hs}/\beta_c$	30/15			

HSPA (HSDPA & HSUPA) Setup Procedures used to establish the test signals

The following 5 Sub-tests were completed according to Release 6 procedures in table C, 11.1.3 of 3GPP TS 34.121-1 v13.

A summary of these settings are illustrated below:

	Mode	HSPA				
	Subtest	1	2	3	4	5
WCDMA General Settings	Loopback Mode	Test Mode 1				
	Rel99 RMC	12.2 kbps RMC				
	HSDPA FRC	H-Set 1				
	HSUPA Test	HSPA				
	Power Control Algorithm	Algorithm 2				Algorithm 1
	β_c	11/15	6/15	15/15	2/15	15/15
	β_d	15/15	15/15	9/15	15/15	0
	β_{ec}	209/225	12/15	30/15	2/15	5/15
	β_c/β_d	11/15	6/15	15/9	2/15	-
	β_{hs}	22/15	12/15	30/15	4/15	5/15
	β_{ed}	1309/225	94/75	47/15	56/75	47/15
CM (dB)	1	3	2	3	1	
MPR (dB)	0	2	1	2	0	
HSDPA Specific Settings	DACK	8				0
	DNAK	8				0
	DCQI	8				0
	Ack-Nack repetition factor	3				
	CQI Feedback (Table 5.2B.4)	4ms				
	CQI Repetition Factor (Table 5.2B.4)	2				
	$A_{hs} = \beta_{hs}/\beta_c$	30/15				
HSUPA Specific Settings	E-DPDCCH	6	8	8	5	0
	DHARQ	0	0	0	0	0
	AG Index	20	12	15	17	12
	ETFCl (from 34.121 Table C.11.1.3)	75	67	92	71	67
	Associated Max UL Data Rate kbps	242.1	174.9	482.8	205.8	308.9
	Reference E-TFCIs	5	5	2	5	1
	Reference E-TFCI	11	11	11	11	67
	Reference E-TFCI PO	4	4	4	4	18
	Reference E-TFCI	67	67	92	67	67
	Reference E-TFCI PO	18	18	18	18	18
	Reference E-TFCI	71	71	71	71	71
	Reference E-TFCI PO	23	23	23	23	23
	Reference E-TFCI	75	75	75	75	75
	Reference E-TFCI PO	26	26	26	26	26
	Reference E-TFCI	81	81	81	81	81
Reference E-TFCI PO	27	27	27	27	27	
Maximum Channelization Codes	2xSF2				SF4	

RESULTS

UMTS HSDPA OUTPUT POWER RESULT

Antenna gain Band 5 (dBi)	-2.00
Antenna gain Band 2 (dBi)	-0.40

Part 22 / RSS 132 850MHz Band (5)

Band	Subtest	UL Channel	DL Channel	Frequency (MHz)	Conducted Average (dBm)	ERP Average (dBm)	ERP Limit (dBm)	Margin (dB)
UMTS HSDPA 850MHz	1	4132	4357	826.4	21.46	17.31	38.5	-17.0
		4183	4408	836.6	20.93	16.78	38.5	-17.6
		4233	4458	846.6	20.42	16.27	38.5	-18.1
	2	4132	4357	826.4	21.43	17.28	38.5	-17.1
		4183	4408	836.6	20.89	16.74	38.5	-17.6
		4233	4458	846.6	20.35	16.20	38.5	-18.2
	3	4132	4357	826.4	21.45	17.30	38.5	-17.1
		4183	4408	836.6	20.88	16.73	38.5	-17.6
		4233	4458	846.6	20.64	16.49	38.5	-17.9
	4	4132	4357	826.4	21.45	17.30	38.5	-17.1
		4183	4408	836.6	20.90	16.75	38.5	-17.6
		4233	4458	846.6	20.36	16.21	38.5	-18.1

Part 24 / RSS 133 1900MHz Band (2)

Band	Subtest	UL Channel	DL Channel	Frequency (MHz)	Conducted Average (dBm)	EIRP Average (dBm)	EIRP Limit (dBm)	Margin (dB)
UMTS HSDPA 1900MHz	1	9262	9662	1852.4	22.72	22.32	33.0	-10.3
		9400	9800	1880.0	22.65	22.25	33.0	-10.4
		9538	9938	1907.6	21.88	21.48	33.0	-11.1
	2	9262	9662	1852.4	21.88	21.48	33.0	-11.1
		9400	9800	1880.0	21.72	21.32	33.0	-11.3
		9538	9938	1907.6	21.14	20.74	33.0	-11.9
	3	9262	9662	1852.4	21.54	21.14	33.0	-11.5
		9400	9800	1880.0	21.30	20.90	33.0	-11.7
		9538	9938	1907.6	20.80	20.40	33.0	-12.2
	4	9262	9662	1852.4	21.35	20.95	33.0	-11.7
		9400	9800	1880.0	21.10	20.70	33.0	-11.9
		9538	9938	1907.6	20.58	20.18	33.0	-12.4

UMTS HSUPA OUTPUT POWER RESULT

Antenna gain Band 5 (dBi)	-2.00
Antenna gain Band 2 (dBi)	-0.40

Part 22 / RSS 132 850MHz Band (5)

Band	Subtest	UL Channel	DL Channel	Frequency (MHz)	Conducted Average (dBm)	ERP Average (dBm)	ERP Limit (dBm)	Margin (dB)
UMTS HSUPA 850MHz	1	4132	4357	826.4	21.54	17.39	38.5	-17.0
		4183	4408	836.6	21.65	17.50	38.5	-16.9
		4233	4458	846.6	21.67	17.52	38.5	-16.8
	2	4132	4357	826.4	19.87	15.72	38.5	-18.6
		4183	4408	836.6	20.79	16.64	38.5	-17.7
		4233	4458	846.6	20.81	16.66	38.5	-17.7
	3	4132	4357	826.4	21.42	17.27	38.5	-17.1
		4183	4408	836.6	21.52	17.37	38.5	-17.0
		4233	4458	846.6	21.52	17.37	38.5	-17.0
	4	4132	4357	826.4	19.87	15.72	38.5	-18.6
		4183	4408	836.6	20.79	16.64	38.5	-17.7
		4233	4458	846.6	20.81	16.66	38.5	-17.7
	5	4132	4357	826.4	21.54	17.39	38.5	-17.0
		4183	4408	836.6	21.65	17.50	38.5	-16.9
		4233	4458	846.6	21.67	17.52	38.5	-16.8

Part 24 / RSS 133 1900MHz Band (2)

Band	Subtest	UL Channel	DL Channel	Frequency (MHz)	Conducted Average (dBm)	EIRP Average (dBm)	EIRP Limit (dBm)	Margin (dB)
UMTS HSUPA 1900MHz	1	9262	9662	1852.4	21.53	21.13	33.0	-11.5
		9400	9800	1880.0	21.28	20.88	33.0	-11.7
		9538	9938	1907.6	21.00	20.60	33.0	-12.0
	2	9262	9662	1852.4	20.68	20.28	33.0	-12.3
		9400	9800	1880.0	20.44	20.04	33.0	-12.6
		9538	9938	1907.6	19.87	19.47	33.0	-13.1
	3	9262	9662	1852.4	21.38	20.98	33.0	-11.6
		9400	9800	1880.0	21.17	20.77	33.0	-11.8
		9538	9938	1907.6	20.56	20.16	33.0	-12.4
	4	9262	9662	1852.4	20.68	20.28	33.0	-12.3
		9400	9800	1880.0	20.44	20.04	33.0	-12.6
		9538	9938	1907.6	19.87	19.47	33.0	-13.1
	5	9262	9662	1852.4	21.50	21.10	33.0	-11.5
		9400	9800	1880.0	21.28	20.88	33.0	-11.7
		9538	9938	1907.6	21.00	20.60	33.0	-12.0

7.3. PEAK TO AVERAGE RATIO

TEST PROCEDURE

Per KDB 971168 D01 Power Meas License Digital Systems v02r02

TEST SPEC

In addition, when the transmitter power is measured in terms of average value, the peak-to-average ratio of the power shall not exceed 13 dB.

CONDUCTED PEAK TO AVERAGE RESULT

7.3.1. GSM

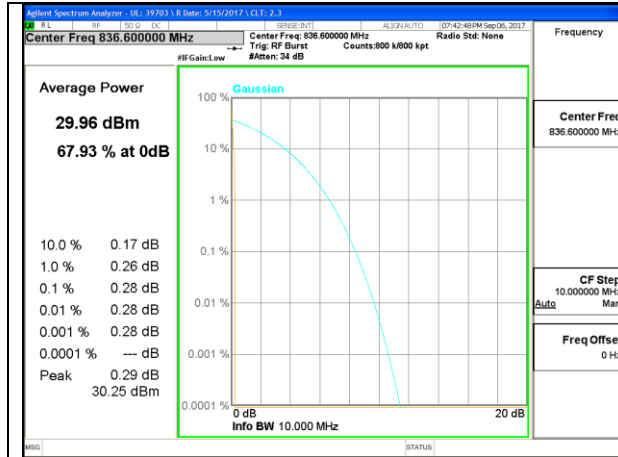

GSM850 GPRS Middle Channel

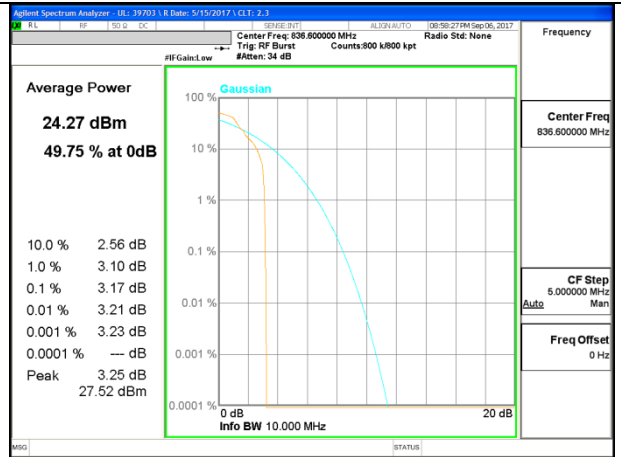

GSM850 EGPRS Middle Channel

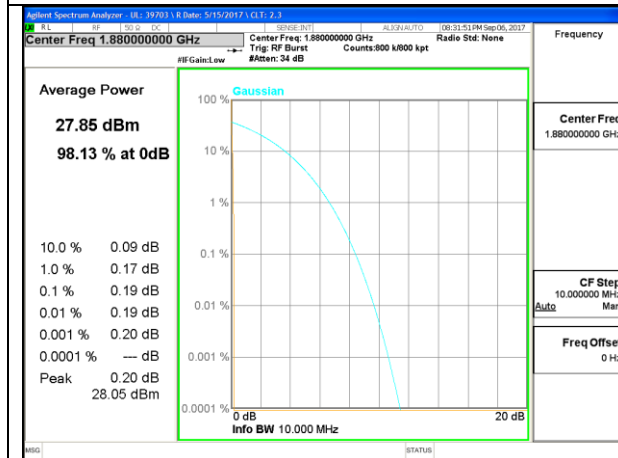

GSM1900 GPRS Middle Channel



GSM1900 EGPRS Middle Channel

7.3.2. WCDMA

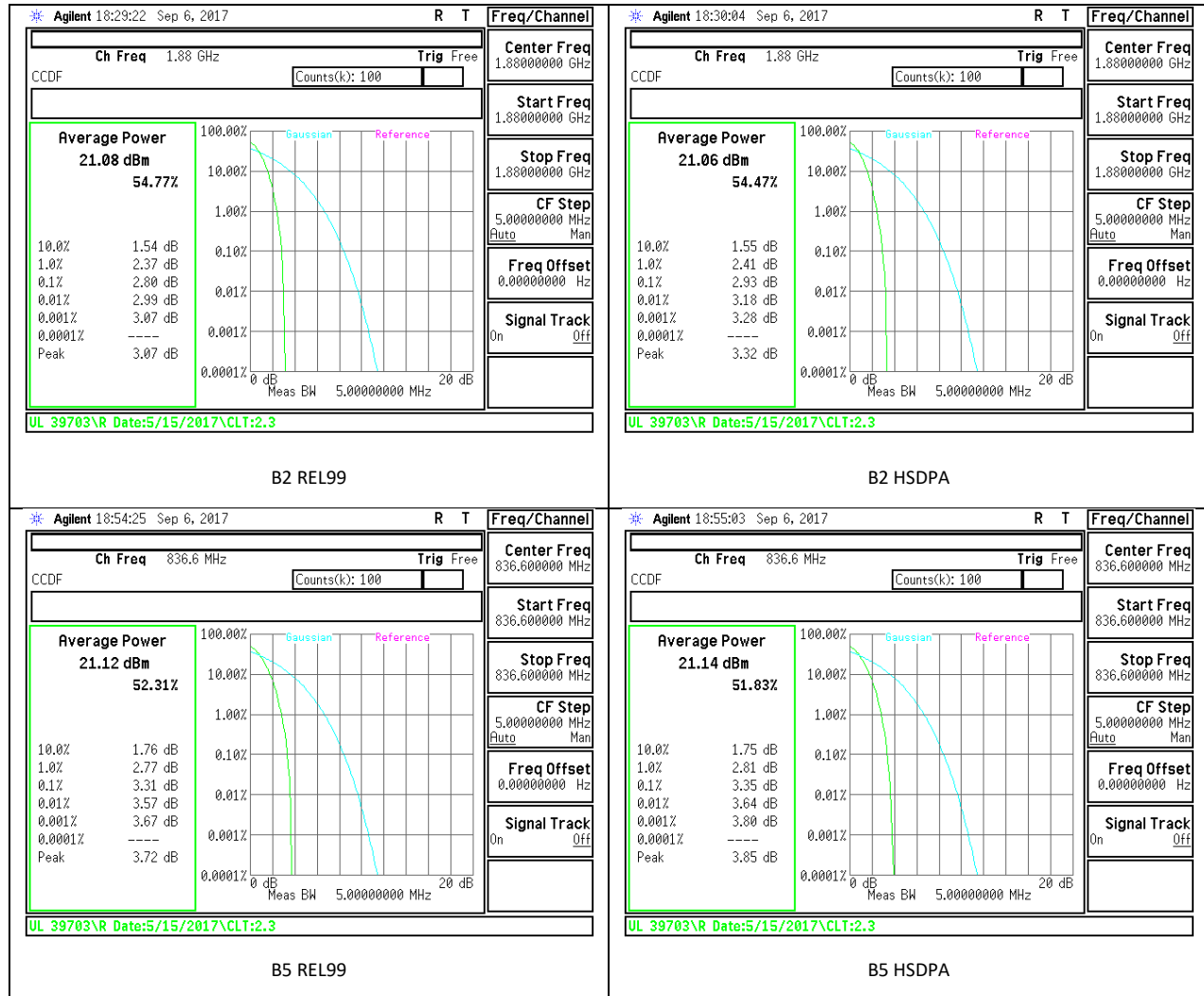

8.1. OCCUPIED BANDWIDTH

RULE PART(S)

FCC: §2.1049
IC: RSS132; RSS133

LIMITS

For reporting purposes only

TEST PROCEDURE

The transmitter output was connected to a calibrated coaxial cable and coupler, the other end of which was connected to a spectrum analyzer. The occupied bandwidth was measured with the spectrum analyzer at the low, middle and high channel in each band. The -26dB bandwidth was also measured and recorded.

(KDB 971168 D01 Power Meas License Digital Systems v02r02)

OCCUPIED BANDWIDTH RESULTS AND PLOTS

8.1.1. GSM

Band	Mode	Channel	f (MHz)	99% BW (kHz)	-26dB (kHz)
GSM 850	GPRS	128	824.2	244.8	316.2
		190	836.6	245.1	310.1
		251	848.8	238.5	321.5
	EGPRS	128	824.2	234.8	302.7
		190	836.6	245.1	317.9
		251	848.8	231.9	286.6
GSM 1900	GPRS	512	1850.2	246	314.5
		661	1880	245.1	315
		810	1909.8	243.1	320.7
	EGPRS	512	1850.2	246.1	305.2
		661	1880	246.9	317.3
		810	1909.8	240.3	301.3

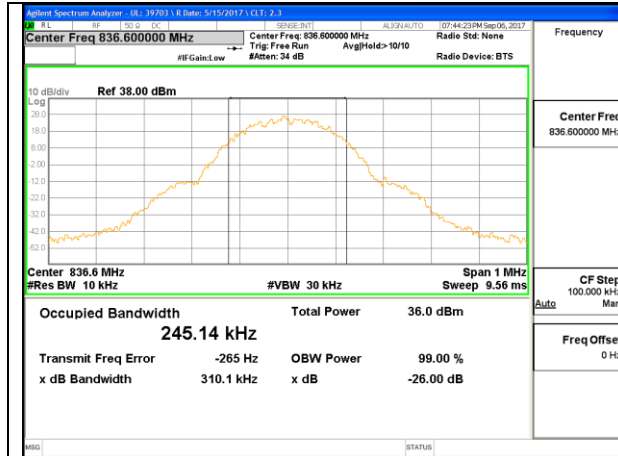

GSM850 GPRS Middle Channel

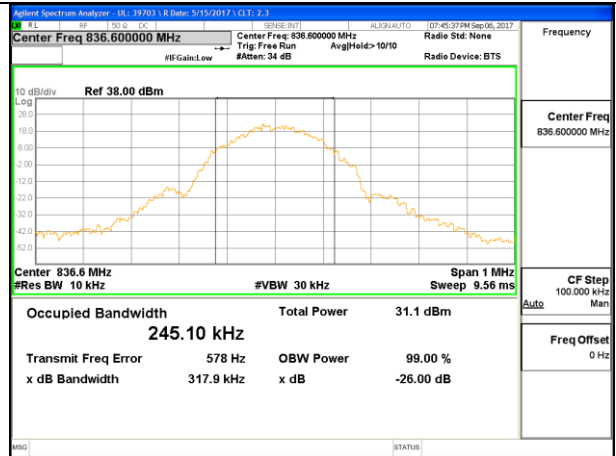

GSM850 EGPRS Middle Channel

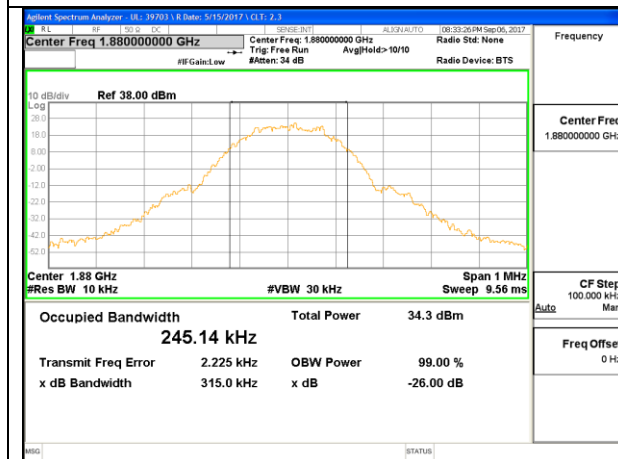

GSM1900 GPRS Middle Channel

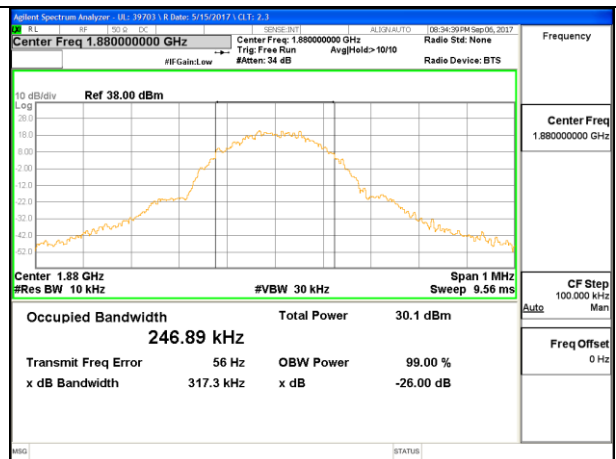

GSM1900 EGPRS Middle Channel

8.1.2. WCDMA

Band	Mode	Channel	f (MHz)	99% BW (MHz)	-26dB (MHz)
Band 2	REL99	9262	1852.4	4.07	4.64
		9400	1880	4.07	4.66
		9538	1907.6	4.07	4.62
	HSDPA	9262	1852.4	4.07	4.62
		9400	1880	4.08	4.6
		9538	1907.6	4.06	4.61
Band 5	REL99	4132	826.4	4.05	4.57
		4183	836.6	4.03	4.58
		4233	846.6	4.04	4.59
	HSDPA	4132	826.4	4.05	4.58
		4183	836.6	4.04	4.58
		4233	846.6	4.06	4.63

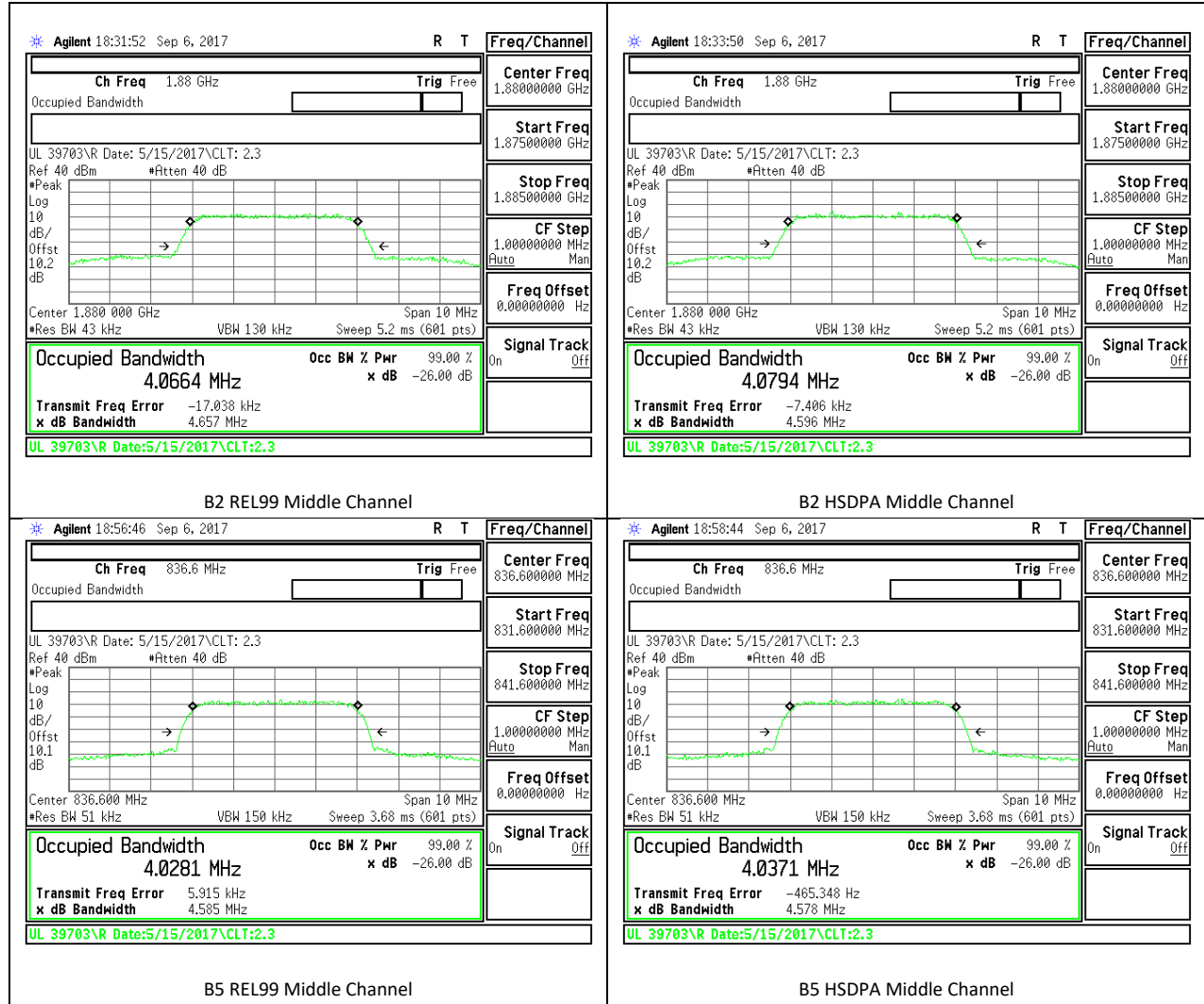

8.2. BAND EDGE EMISSIONS

RULE PART(S)

FCC: §22.359, §22.917, §24.238
IC: RSS132§5.5; RSS133§6.5

FCC LIMITS

FCC: §22.359, §22.917, §24.238

The power of any emission outside of the authorized operating frequency ranges must be attenuated below the transmitting power (P) by a factor of at least $43 + 10 \log (P)$ dB.

RSS132§5.5

Mobile and base station equipment shall comply with the limits in (i) and (ii) below.

In the first 1.0 MHz band immediately outside and adjacent to each of the sub-bands specified in Section 5.1, the power of emissions per any 1% of the occupied bandwidth shall be attenuated (in dB) below the transmitter output power P (dBW) by at least $43 + 10 \log_{10} p$ (watts).

After the first 1.0 MHz immediately outside and adjacent to each of the sub-bands, the power of emissions in any 100 kHz bandwidth shall be attenuated (in dB) below the transmitter output power P (dBW) by at least $43 + 10 \log_{10} p$ (watts). If the measurement is performed using 1% of the occupied bandwidth, power integration over 100 kHz is required.

RSS133§6.5

Equipment shall comply with the limits in (i) and (ii) below.

(i) In the 1.0 MHz bands immediately outside and adjacent to the equipment's operating frequency block, the emission power per any 1% of the emission bandwidth shall be attenuated (in dB) below the transmitter output power P (dBW) by at least $43 + 10 \log_{10} p$ (watts).

(ii) After the first 1.0 MHz, the emission power in any 1 MHz bandwidth shall be attenuated (in dB) below the transmitter output power P (dBW) by at least $43 + 10 \log_{10} p$ (watts). If the measurement is performed using 1% of the emission bandwidth, power integration over 1.0 MHz is required.

TEST PROCEDURE

Per KDB 971168 D01 Power Meas License Digital Systems v02r02

The transmitter output was connected to an Agilent 8960 or a CMW500 Test Set and configured to operate at maximum power. The band edge emissions were measured at the required operating frequencies in each band on the Spectrum Analyzer.

For each band edge measurement:

- Set the spectrum analyzer span to include the block edge frequency.
- Set a marker to point the corresponding band edge frequency in each test case.
- Set display line at -13 dBm
- Set resolution bandwidth to at least 1% of emission bandwidth.

BAND EDGE PLOTS

8.2.1. GSM

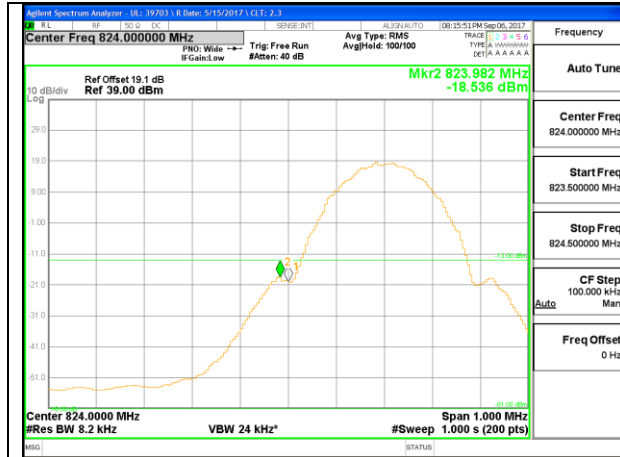

GSM850 GPRS Low Channel

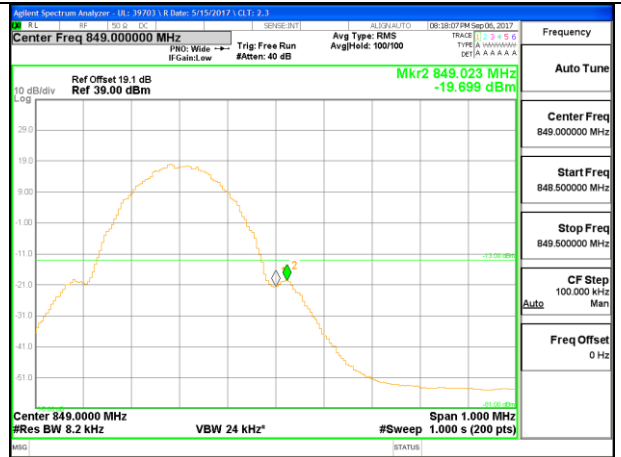

GSM850 GPRS High Channel

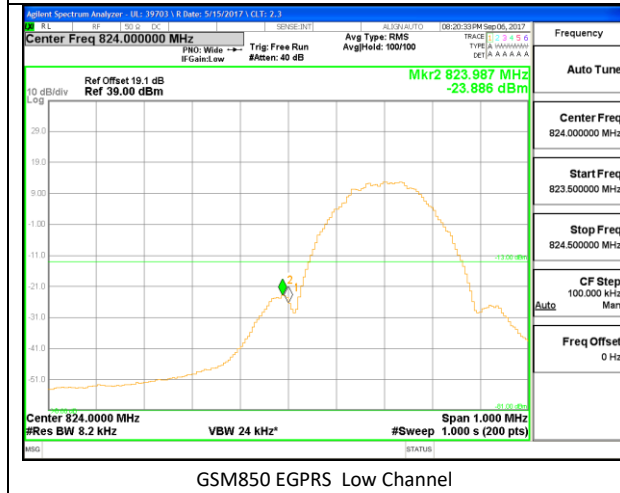

GSM850 EGPRS Low Channel

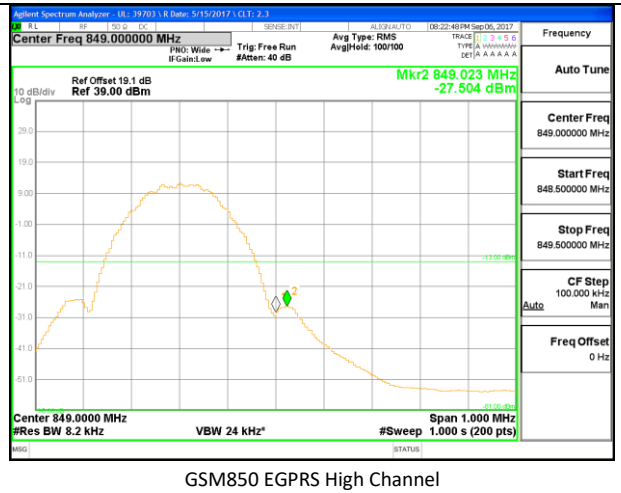

GSM850 EGPRS High Channel

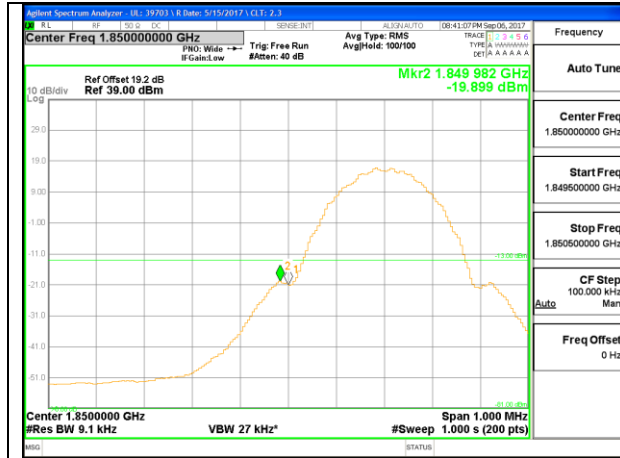

GSM1900 GPRS Low Channel

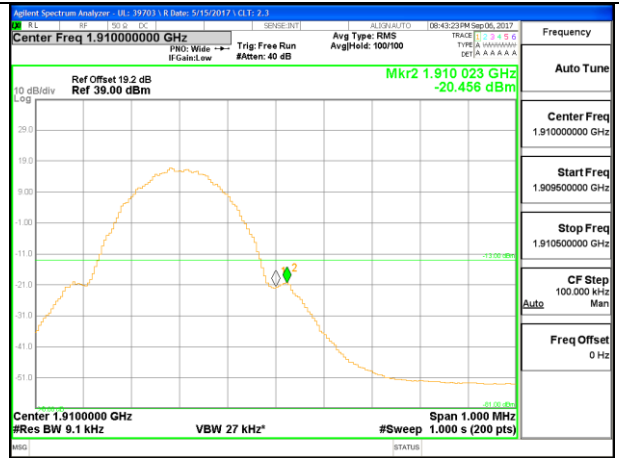

GSM1900 GPRS High Channel

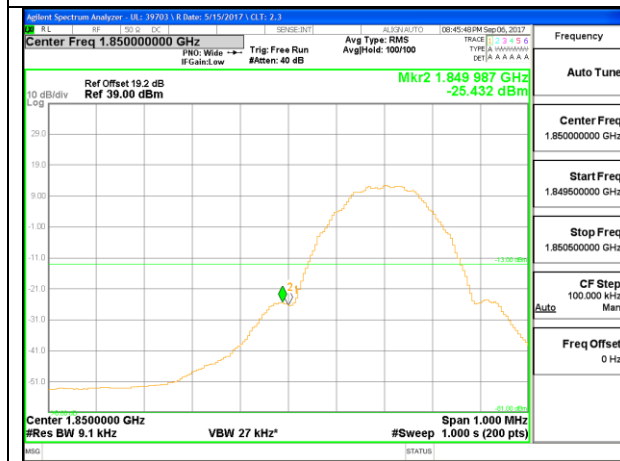

GSM1900 EGPRS Low Channel

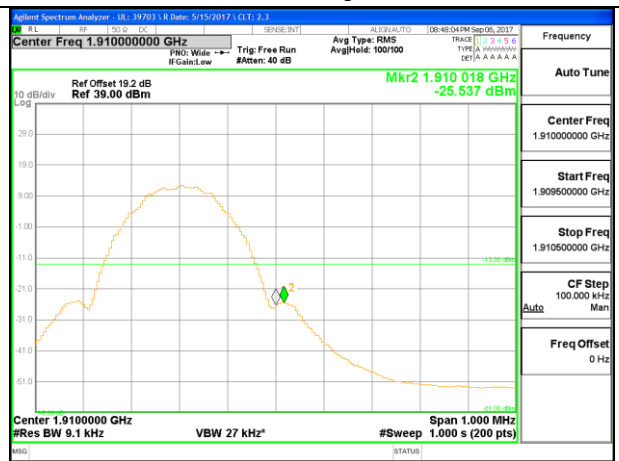

GSM1900 EGPRS High Channel

8.2.2. WCDMA

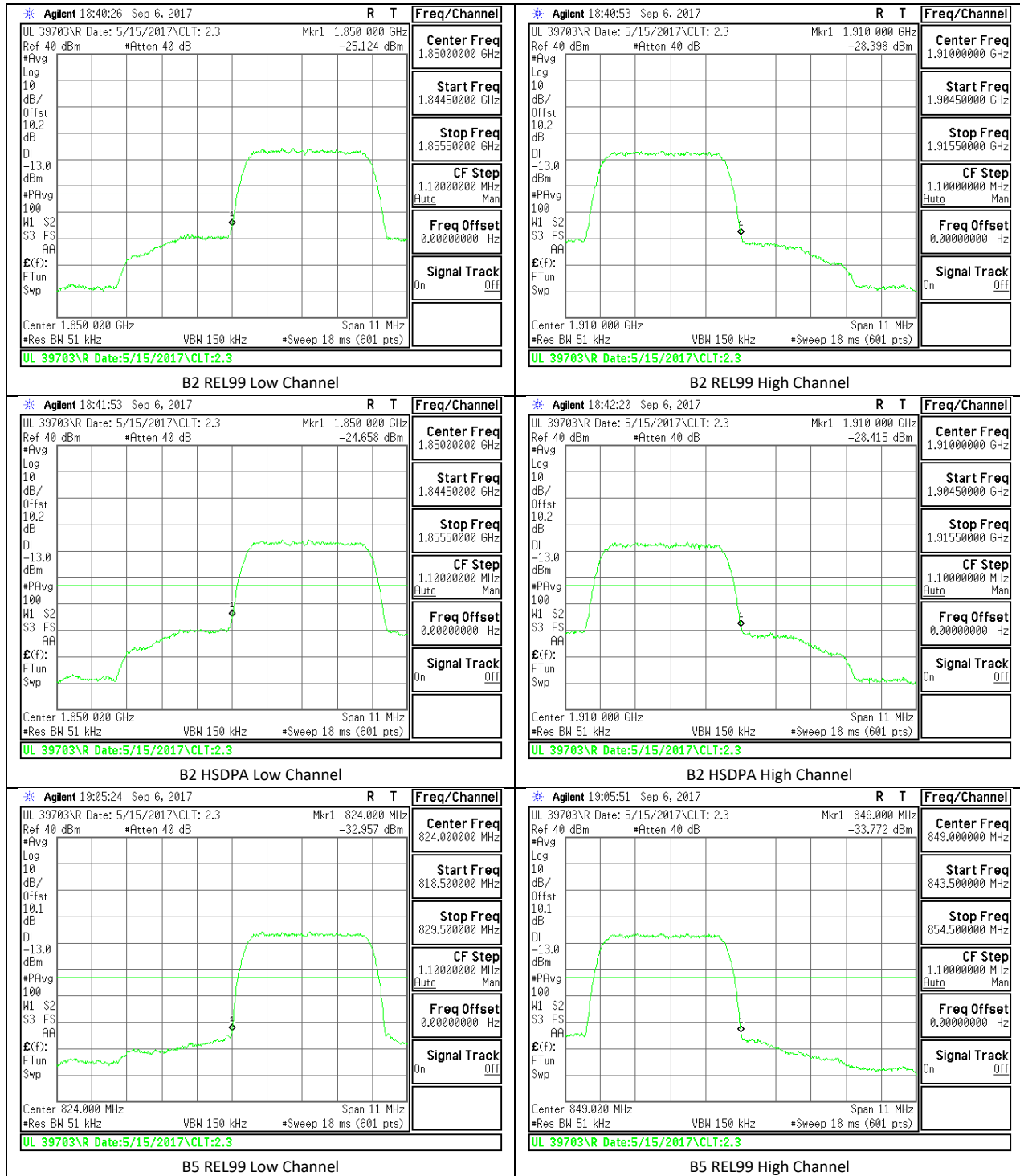

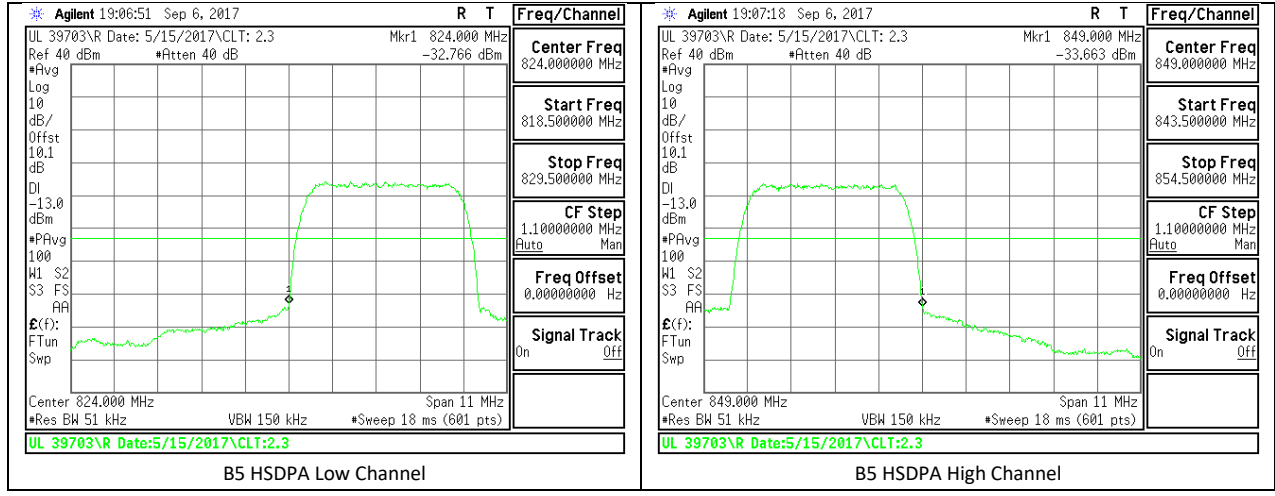

8.3. OUT OF BAND EMISSIONS

RULE PART(S)

FCC: §22.359, §22.917, §24.238

IC: RSS132§5.5; RSS133§6.5

FCC LIMITS

FCC: §22.359, §22.917, §24.238

The power of any emission outside of the authorized operating frequency ranges must be attenuated below the transmitting power (P) by a factor of at least $43 + 10 \log (P)$ dB.

RSS132§5.5

Mobile and base station equipment shall comply with the limits in (i) and (ii) below.

In the first 1.0 MHz band immediately outside and adjacent to each of the sub-bands specified in Section 5.1, the power of emissions per any 1% of the occupied bandwidth shall be attenuated (in dB) below the transmitter output power P (dBW) by at least $43 + 10 \log_{10} p$ (watts).

After the first 1.0 MHz immediately outside and adjacent to each of the sub-bands, the power of emissions in any 100 kHz bandwidth shall be attenuated (in dB) below the transmitter output power P (dBW) by at least $43 + 10 \log_{10} p$ (watts). If the measurement is performed using 1% of the occupied bandwidth, power integration over 100 kHz is required.

RSS133§6.5

Equipment shall comply with the limits in (i) and (ii) below.

(i) In the 1.0 MHz bands immediately outside and adjacent to the equipment's operating frequency block, the emission power per any 1% of the emission bandwidth shall be attenuated (in dB) below the transmitter output power P (dBW) by at least $43 + 10 \log_{10} p$ (watts).

(ii) After the first 1.0 MHz, the emission power in any 1 MHz bandwidth shall be attenuated (in dB) below the transmitter output power P (dBW) by at least $43 + 10 \log_{10} p$ (watts). If the measurement is performed using 1% of the emission bandwidth, power integration over 1.0 MHz is required.

TEST PROCEDURE

Per KDB 971168 D01 Power Meas License Digital Systems v02r02

The RF output of the transmitter was connected to a spectrum analyzer through a calibrated coaxial cable. Sufficient scans were taken to show the out-of-band Emissions, if any, up to 10th harmonic. Multiple sweeps were recorded in a maximum hold mode using a peak detector to ensure that the worst-case emissions were caught.

For each out of band emissions measurement:

- Set display line at -13 dBm
- Set RBW & VBW to 100 kHz for the measurement below 1 GHz, and 1 MHz for the measurement above 1 GHz.

RESULTS

OUT OF BAND EMISSIONS RESULT AND PLOTS

8.3.1. GSM

Band	Mode	f (MHz)	Spur (dBm)	Spec (dBm)	Delta (dB)
GSM 850	GPRS	824.2	-22.179	-13	-9.179
		836.6	-21.908	-13	-8.908
		848.8	-21.458	-13	-8.458
	EGPRS	824.2	-21.998	-13	-8.998
		836.6	-21.708	-13	-8.708
		848.8	-21.664	-13	-8.664
GSM 1900	GPRS	1850.2	-21.423	-13	-8.423
		1880	-21.958	-13	-8.958
		1909.8	-21.678	-13	-8.678
	EGPRS	1850.2	-21.578	-13	-8.578
		1880	-21.986	-13	-8.986
		1909.8	-21.656	-13	-8.656

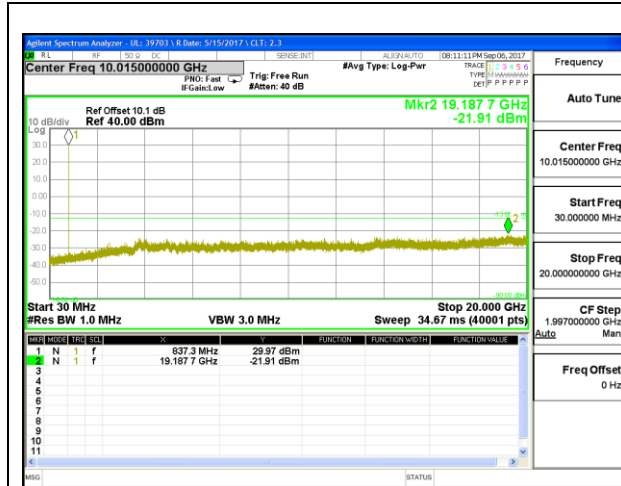

GSM850 GPRS Middle Channel

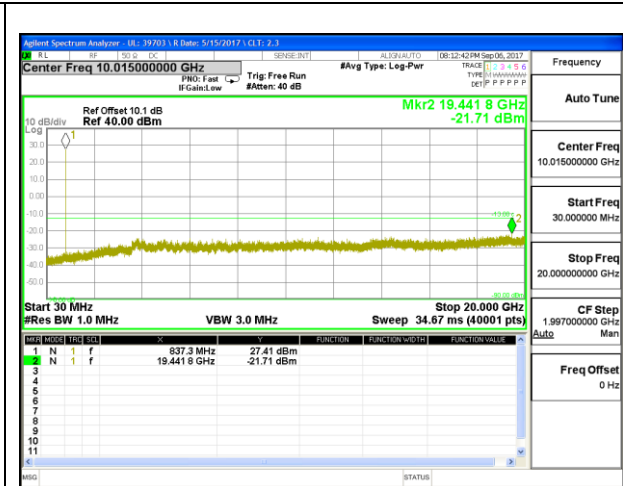

GSM850 EGPRS Middle Channel

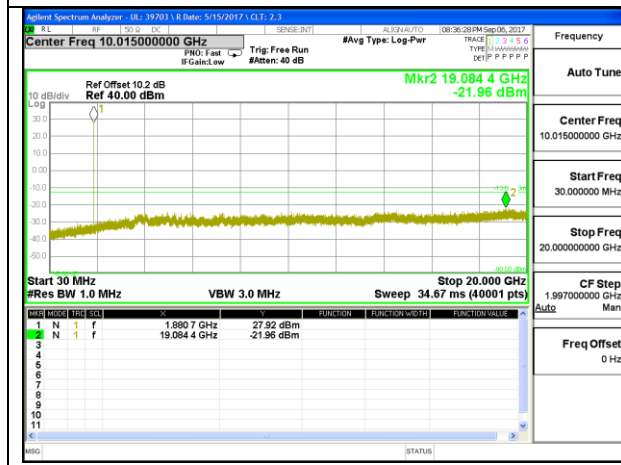

GSM1900 GPRS Middle Channel

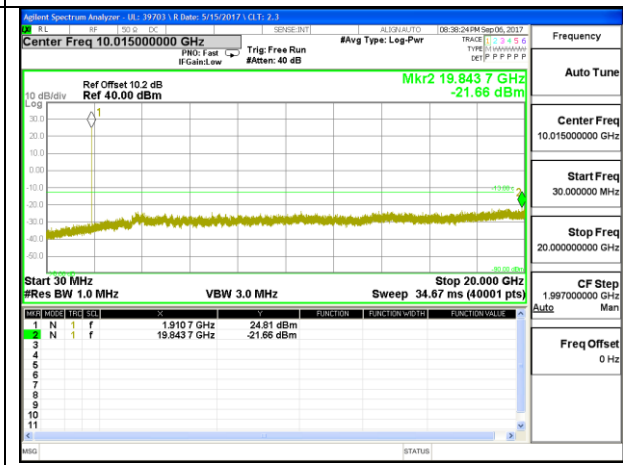

GSM1900 EGPRS Middle Channel

8.3.2. WCDMA

Band	Mode	f (MHz)	Spur (dBm)	99% BW (MHz)	Delta (dB)
Band 2	REL99	1852.4	-23.74	-13	-10.74
		1880	-24.09	-13	-11.09
		1907.6	-24.15	-13	-11.15
	HSDPA	1852.4	-23.98	-13	-10.98
		1880	-23.7	-13	-10.7
		1907.6	-23.24	-13	-10.24
Band 5	REL99	826.4	-24.07	-13	-11.07
		836.6	-24	-13	-11
		846.6	-22.9	-13	-9.9
	HSDPA	826.4	-24.1	-13	-11.1
		836.6	-24.1	-13	-11.1
		846.6	-24.2	-13	-11.2

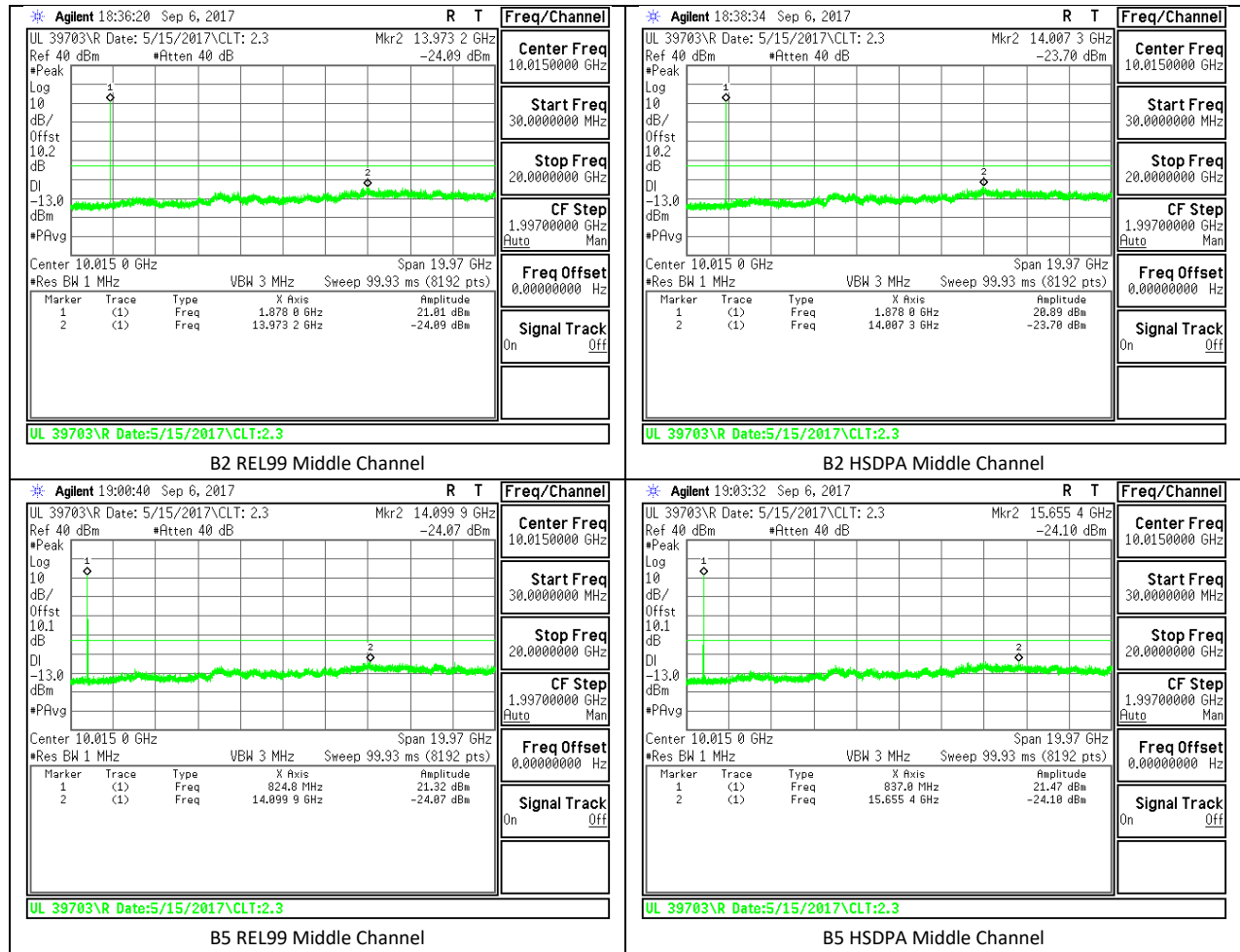

8.4 FREQUENCY STABILITY

RULE PART(S)

FCC: §2.1055, §22.355, §24.235

IC: RSS132§5.3; RSS133§6.3

FCC LIMITS

§22.355

The carrier frequency shall not depart from the reference frequency in excess of ± 2.5 ppm for mobile stations.

§24.235

The frequency stability shall be sufficient to ensure that the fundamental emission stays within the authorized frequency block.

RSS132§5.3

The carrier frequency shall not depart from the reference frequency in excess of ± 2.5 SRSP for mobile stations and ± 1.5 ppm for base stations.

In lieu of meeting the above stability values, the test report may show that the frequency stability is sufficient to ensure that the occupied bandwidth stays within each of the sub-bands (see Section 5.1) when tested to the temperature and supply voltage variations specified in RSS-Gen.

RSS133§6.3

The carrier frequency shall not depart from the reference frequency, in excess of ± 2.5 ppm for mobile stations and ± 1.0 ppm for base stations.

In lieu of meeting the above stability values, the test report may show that the frequency stability is sufficient to ensure that the emission bandwidth stays within the operating frequency block when tested to the temperature and supply voltage variations specified in RSS-Gen.

TEST PROCEDURE

Per KDB 971168 D01 Power Meas License Digital Systems v02r02

Results

Tested By	Kiya Kedida
Date	9/12/17

FREQUENCY STABILITY RESULTS

8.4.1 GSM 850

Reference Frequency: GSM 850 Mid Channel		836.6	MHz @ 20°C	
Limit: to stay +/- 2.5 ppm =		2091.500	Hz	
Power Supply (Vdc)	Environment Temperature (°C)	Frequency Deviation Measured with Time Elapse		
		(MHz)	Delta (ppm)	Limit (ppm)
3.30	75	836.599982	0.000	2.5
3.30	60	836.599978	0.005	2.5
3.30	40	836.599970	0.014	2.5
3.30	20	836.599982	0	2.5
3.30	10	836.599976	0.006	2.5
3.30	0	836.599980	0.002	2.5
3.30	-10	836.599983	-0.001	2.5
3.30	-20	836.599980	0.002	2.5

Reference Frequency: GSM 850 Mid Channel		836.6	MHz @ 20°C	
Limit: to stay +/- 2.5 ppm =		2091.500	Hz	
Power Supply (Vdc)	Environment Temperature (°C)	Frequency Deviation Measured with Time Elapse		
		(MHz)	Delta (ppm)	Limit (ppm)
3.30	20	836.599982	0	2.5
4.80	20	836.599983	-0.001	2.5
3.20	20	836.599976	0.006	2.5

8.4.2 GSM 1900

Reference Frequency: GSM 1900 Mid Channel		1880	MHz @ 20°C	
Limit: to stay +/- 2.5 ppm =		4700.000	Hz	
Power Supply (Vdc)	Environment Temperature (°C)	Frequency Deviation Measured with Time Elapse		
		(MHz)	Delta (ppm)	Limit (ppm)
3.30	50	1880.000028	0.003	2.5
3.30	40	1880.000025	0.005	2.5
3.30	30	1880.000032	0.001	2.5
3.30	20	1880.000034	0	2.5
3.30	10	1880.000026	0.004	2.5
3.30	0	1880.000025	0.005	2.5
3.30	-10	1880.000029	0.003	2.5
3.30	-20	1880.000027	0.004	2.5

Reference Frequency: GSM 1900 Mid Channel		1880	MHz @ 20°C	
Limit: to stay +/- 2.5 ppm =		4700.000	Hz	
Power Supply (Vdc)	Environment Temperature (°C)	Frequency Deviation Measured with Time Elapse		
		(MHz)	Delta (ppm)	Limit (ppm)
3.30	20	1880.000034	0	2.5
4.80	20	1880.000029	0.003	2.5
3.20	20	1880.000031	0.002	2.5

9. RADIATED TEST RESULTS

9.1. FIELD STRENGTH OF SPURIOUS RADIATION

RULE PART(S)

FCC: §2.1053, §22.917
IC: RSS132§5.5; RSS133§6.5

FCC LIMIT

§22.917 (e) and §24.238 (a):

The power of any emission outside of the authorized operating frequency ranges must be attenuated below the transmitting power (P) by a factor of at least $43 + 10 \log (P)$ dB.

RSS132§5.5

Mobile and base station equipment shall comply with the limits in (i) and (ii) below.

In the first 1.0 MHz band immediately outside and adjacent to each of the sub-bands specified in Section 5.1, the power of emissions per any 1% of the occupied bandwidth shall be attenuated (in dB) below the transmitter output power P (dBW) by at least $43 + 10 \log_{10} p$ (watts).

After the first 1.0 MHz immediately outside and adjacent to each of the sub-bands, the power of emissions in any 100 kHz bandwidth shall be attenuated (in dB) below the transmitter output power P (dBW) by at least $43 + 10 \log_{10} p$ (watts). If the measurement is performed using 1% of the occupied bandwidth, power integration over 100 kHz is required.

RSS133§6.5

Equipment shall comply with the limits in (i) and (ii) below.

(i) In the 1.0 MHz bands immediately outside and adjacent to the equipment's operating frequency block, the emission power per any 1% of the emission bandwidth shall be attenuated (in dB) below the transmitter output power P (dBW) by at least $43 + 10 \log_{10} p$ (watts).

(ii) After the first 1.0 MHz, the emission power in any 1 MHz bandwidth shall be attenuated (in dB) below the transmitter output power P (dBW) by at least $43 + 10 \log_{10} p$ (watts). If the measurement is performed using 1% of the emission bandwidth, power integration over 1.0 MHz is required.

TEST PROCEDURE

For Cellular equipment - Compliance with these rules is based on the use of measurement instrumentation employing a resolution bandwidth of 100 kHz or greater. In the 1 MHz bands immediately outside and adjacent to the frequency block a resolution bandwidth of at least one percent of the emission bandwidth of the fundamental emission of the transmitter may be employed. A narrower resolution bandwidth is permitted in all cases to improve measurement accuracy provided the measured power is integrated over the full required measurement bandwidth (i.e. 100 kHz or 1 percent of emission bandwidth, as specified). The emission bandwidth is defined as the width of the signal between two points, one below the carrier center frequency and one above the carrier center frequency, outside of which all emissions are attenuated at least 26 dB below the transmitter power.

For PCS equipment - Compliance with these rules is based on the use of measurement instrumentation employing a resolution bandwidth of 1 MHz or greater. However, in the 1 MHz bands immediately outside and adjacent to the frequency block a resolution bandwidth of at least one percent of the emission bandwidth of the fundamental emission of the transmitter may be employed. A narrower resolution bandwidth is permitted in all cases to improve measurement accuracy provided the measured power is integrated over the full required measurement bandwidth (i.e. 1 MHz or 1 percent of emission bandwidth, as specified). The emission bandwidth is defined as the width of the signal between two points, one below the carrier center frequency and one above the carrier center frequency, outside of which all emissions are attenuated at least 26 dB below the transmitter power.

SPURIOUS RADIATION PLOTS

9.1.1. GSM

UL Verification Services, Inc.
Above 1GHz High Frequency Substitution Measurement

Company: VERIFONE
 Project #: 11631998
 Date: 9/6/2017
 Test Engineer: GE43578
 Configuration: EUT + AC Adapter
 Location: Chamber C
 Mode: GPRS 850 MHz Harmonics

f MHz	SG reading (dBm)	Ant. Pol. (H/V)	Distance (m)	Preamp (dB)	Filter (dB)	ERP (dBm)	Limit (dBm)	Delta (dB)	Notes
Low Ch. 824.2MHz									
1648.40	-18.0	V	3.0	37.0	1.0	-54.1	-13.0	-41.1	
2472.60	-15.9	V	3.0	36.4	1.0	-51.3	-13.0	-38.3	
3296.80	-25.5	V	3.0	36.2	1.0	-60.7	-13.0	-47.7	
1648.40	-15.0	H	3.0	37.0	1.0	-51.0	-13.0	-38.0	
2472.60	-24.2	H	3.0	36.4	1.0	-59.7	-13.0	-46.7	
3296.80	-26.3	H	3.0	36.2	1.0	-61.4	-13.0	-48.4	
Mid Ch. 836.6MHz									
1673.20	-16.7	V	3.0	37.0	1.0	-52.7	-13.0	-39.7	
2509.80	-13.1	V	3.0	36.4	1.0	-48.5	-13.0	-35.5	
3346.40	-20.1	V	3.0	36.1	1.0	-55.2	-13.0	-42.2	
1673.20	-15.9	H	3.0	37.0	1.0	-51.9	-13.0	-38.9	
2509.80	-18.3	H	3.0	36.4	1.0	-53.7	-13.0	-40.7	
3346.40	-29.2	H	3.0	36.1	1.0	-55.3	-13.0	-42.3	
High Ch. 848.8MHz									
1697.60	-11.1	V	3.0	37.0	1.0	-47.1	-13.0	-34.1	
2546.40	-15.3	V	3.0	36.4	1.0	-51.7	-13.0	-38.7	
3395.20	-18.4	V	3.0	36.1	1.0	-53.5	-13.0	-40.5	
1697.60	-15.6	H	3.0	37.0	1.0	-51.6	-13.0	-38.6	
2546.40	-18.2	H	3.0	36.4	1.0	-53.6	-13.0	-40.6	
3395.20	-18.0	H	3.0	36.1	1.0	-53.1	-13.0	-40.1	

GSM850 GPRS

UL Verification Services, Inc.
Above 1GHz High Frequency Substitution Measurement

Company: VERIFONE
 Project #: 11631998
 Date: 9/6/2017
 Test Engineer: GE43578
 Configuration: EUT + AC Adapter
 Location: Chamber C
 Mode: EGPRS 850 MHz Harmonics

f MHz	SG reading (dBm)	Ant. Pol. (H/V)	Distance (m)	Preamp (dB)	Filter (dB)	ERP (dBm)	Limit (dBm)	Delta (dB)	Notes
Low Ch. 824.2MHz									
1648.40	-14.5	V	3.0	37.0	1.0	-50.5	-13.0	-37.5	
2472.60	-21.9	V	3.0	36.4	1.0	-57.4	-13.0	-44.4	
3296.80	-24.6	V	3.0	36.2	1.0	-59.8	-13.0	-46.8	
1648.40	-19.4	H	3.0	37.0	1.0	-55.4	-13.0	-42.4	
2472.60	-17.3	H	3.0	36.4	1.0	-52.7	-13.0	-39.7	
3296.80	-24.8	H	3.0	36.2	1.0	-59.9	-13.0	-46.9	
Mid Ch. 836.6MHz									
1673.20	-14.4	V	3.0	37.0	1.0	-50.4	-13.0	-37.4	
2509.80	-22.9	V	3.0	36.4	1.0	-58.3	-13.0	-45.3	
3346.40	-23.4	V	3.0	36.1	1.0	-58.6	-13.0	-45.6	
1673.20	-19.5	H	3.0	37.0	1.0	-55.5	-13.0	-42.5	
2509.80	-13.5	H	3.0	36.4	1.0	-48.9	-13.0	-35.9	
3346.40	-24.6	H	3.0	36.1	1.0	-59.7	-13.0	-46.7	
High Ch. 848.8MHz									
1697.60	-13.7	V	3.0	37.0	1.0	-49.7	-13.0	-36.7	
2546.40	-23.9	V	3.0	36.4	1.0	-59.3	-13.0	-46.3	
3395.20	-21.7	V	3.0	36.1	1.0	-56.8	-13.0	-43.8	
1697.60	-18.4	H	3.0	37.0	1.0	-54.4	-13.0	-41.4	
2546.40	-13.8	H	3.0	36.4	1.0	-49.2	-13.0	-36.2	
3395.20	-19.1	H	3.0	36.1	1.0	-54.2	-13.0	-41.2	

GSM850 EGPRS

UL Verification Services, Inc.
Above 1GHz High Frequency Substitution Measurement

Company: VERIFONE
 Project #: 11631998
 Date: 9/6/2017
 Test Engineer: GE43578
 Configuration: EUT + AC Adapter
 Location: Chamber C
 Mode: GPRS 1900 MHz Harmonics

f MHz	SG reading (dBm)	Ant. Pol. (H/V)	Distance (m)	Preamp (dB)	Filter (dB)	ERP (dBm)	Limit (dBm)	Delta (dB)	Notes
Low Ch. 1850.2MHz									
3700.40	-24.4	V	3.0	35.9	1.0	-59.3	-13.0	-46.3	
5550.60	-23.3	V	3.0	35.5	1.0	-57.8	-13.0	-44.8	
7400.80	-21.7	V	3.0	35.7	1.0	-56.5	-13.0	-43.5	
3700.40	-25.5	H	3.0	35.9	1.0	-60.4	-13.0	-47.4	
5550.60	-22.6	H	3.0	35.5	1.0	-57.1	-13.0	-44.1	
7400.80	-21.0	H	3.0	35.7	1.0	-55.8	-13.0	-42.8	
Mid Ch. 1880MHz									
3760.00	-25.7	V	3.0	35.8	1.0	-60.5	-13.0	-47.5	
5640.00	-22.2	V	3.0	35.5	1.0	-56.7	-13.0	-43.7	
7520.00	-21.8	V	3.0	35.7	1.0	-56.5	-13.0	-43.5	
3760.00	-25.7	H	3.0	35.8	1.0	-60.5	-13.0	-47.5	
5640.00	-22.1	H	3.0	35.5	1.0	-56.6	-13.0	-43.6	
7520.00	-20.2	H	3.0	35.7	1.0	-54.9	-13.0	-41.9	
High Ch. 1909.8MHz									
3819.60	-25.2	V	3.0	35.8	1.0	-60.0	-13.0	-47.0	
5729.40	-22.7	V	3.0	35.5	1.0	-57.2	-13.0	-44.2	
7639.20	-21.8	V	3.0	35.8	1.0	-56.5	-13.0	-43.5	
3819.60	-25.0	H	3.0	35.8	1.0	-59.8	-13.0	-46.8	
5729.40	-22.7	H	3.0	35.5	1.0	-57.2	-13.0	-44.2	
7639.20	-20.6	H	3.0	35.8	1.0	-55.3	-13.0	-42.3	

GSM1900 GPRS

UL Verification Services, Inc.
Above 1GHz High Frequency Substitution Measurement

Company: VERIFONE
 Project #: 11631998
 Date: 9/6/2017
 Test Engineer: GE43578
 Configuration: EUT + AC Adapter
 Location: Chamber C
 Mode: EGPRS 1900 MHz Harmonics

f MHz	SG reading (dBm)	Ant. Pol. (H/V)	Distance (m)	Preamp (dB)	Filter (dB)	ERP (dBm)	Limit (dBm)	Delta (dB)	Notes
Low Ch. 1850.2MHz									
3700.40	-24.6	V	3.0	35.9	1.0	-59.4	-13.0	-46.4	
5550.60	-23.0	V	3.0	35.5	1.0	-57.5	-13.0	-44.5	
7400.80	-21.6	V	3.0	35.7	1.0	-56.3	-13.0	-43.3	
3700.40	-24.4	H	3.0	35.9	1.0	-59.3	-13.0	-46.3	
5550.60	-22.4	H	3.0	35.5	1.0	-56.9	-13.0	-43.9	
7400.80	-20.7	H	3.0	35.7	1.0	-55.5	-13.0	-42.5	
Mid Ch. 1880MHz									
3760.00	-25.9	V	3.0	35.8	1.0	-60.7	-13.0	-47.7	
5640.00	-21.4	V	3.0	35.5	1.0	-55.9	-13.0	-42.9	
7520.00	-21.7	V	3.0	35.7	1.0	-56.5	-13.0	-43.5	
3760.00	-25.3	H	3.0	35.8	1.0	-60.1	-13.0	-47.1	
5640.00	-20.7	H	3.0	35.5	1.0	-55.2	-13.0	-42.2	
7520.00	-19.7	H	3.0	35.7	1.0	-54.4	-13.0	-41.4	
High Ch. 1909.8MHz									
3819.60	-25.4	V	3.0	35.8	1.0	-60.2	-13.0	-47.2	
5729.40	-22.4	V	3.0	35.5	1.0	-56.9	-13.0	-43.9	
7639.20	-21.4	V	3.0	35.8	1.0	-56.2	-13.0	-43.2	
3819.60	-25.5	H	3.0	35.8	1.0	-60.3	-13.0	-47.3	
5729.40	-22.4	H	3.0	35.5	1.0	-56.9	-13.0	-43.9	
7639.20	-20.8	H	3.0	35.8	1.0	-55.5	-13.0	-42.5	

GSM1900 EGPRS

9.1.2. WCDMA

UL Verification Services, Inc.
 Above 1GHz High Frequency Substitution Measurement

Company: VERIFONE
Project #: 11631998
Date: 9/6/2017
Test Engineer: GE43578
Configuration: EUT + AC Adapter
Location: Chamber C
Mode: Rel99 Band 2 Harmonics

f MHz	SG reading (dBm)	Ant. Pol. (H/V)	Distance (m)	Preamp (dB)	Filter (dB)	EIRP (dBm)	Limit (dBm)	Delta (dB)	Notes
Low Ch, 1852.4MHz									
3784.80	-15.4	V	3.0	35.9	1.0	50.3	-13.0	37.3	
5557.20	-21.3	V	3.0	35.5	1.0	55.7	-13.0	42.7	
7409.60	-20.5	V	3.0	35.7	1.0	55.2	-13.0	42.2	
3784.80	-12.0	H	3.0	35.9	1.0	46.9	-13.0	33.9	
5557.20	-20.6	H	3.0	35.5	1.0	55.1	-13.0	42.1	
7409.60	-19.1	H	3.0	35.7	1.0	53.8	-13.0	40.8	
Mid Ch, 1880MHz									
3780.00	-21.8	V	3.0	35.8	1.0	56.6	-13.0	43.6	
5640.00	-22.7	V	3.0	35.5	1.0	57.2	-13.0	44.2	
7520.00	-21.2	V	3.0	35.7	1.0	56.0	-13.0	43.0	
3780.00	-17.9	H	3.0	35.8	1.0	52.7	-13.0	39.7	
5640.00	-21.3	H	3.0	35.5	1.0	55.8	-13.0	42.8	
7520.00	-19.6	H	3.0	35.7	1.0	54.4	-13.0	41.4	
High Ch, 1907.6MHz									
3815.20	-19.5	V	3.0	35.8	1.0	54.3	-13.0	41.3	
5722.80	-20.8	V	3.0	35.5	1.0	55.3	-13.0	42.3	
7630.40	-20.6	V	3.0	35.8	1.0	55.3	-13.0	42.3	
3815.20	-16.2	H	3.0	35.8	1.0	51.0	-13.0	38.0	
5722.80	-22.0	H	3.0	35.5	1.0	56.5	-13.0	43.5	
7630.40	-19.2	H	3.0	35.8	1.0	53.9	-13.0	40.9	

B2 REL99

UL Verification Services, Inc.
 Above 1GHz High Frequency Substitution Measurement

Company: VERIFONE
Project #: 11631998
Date: 9/6/2017
Test Engineer: GE43578
Configuration: EUT + AC Adapter
Location: Chamber C
Mode: HSDPA Band 2 Harmonics

f MHz	SG reading (dBm)	Ant. Pol. (H/V)	Distance (m)	Preamp (dB)	Filter (dB)	EIRP (dBm)	Limit (dBm)	Delta (dB)	Notes
Low Ch, 1852.4MHz									
3784.80	-15.7	V	3.0	35.9	1.0	50.6	-13.0	37.6	
5557.20	-21.5	V	3.0	35.5	1.0	56.0	-13.0	43.0	
7409.60	-20.2	V	3.0	35.7	1.0	54.9	-13.0	41.9	
3784.80	-12.7	H	3.0	35.9	1.0	47.5	-13.0	34.5	
5557.20	-20.7	H	3.0	35.5	1.0	55.2	-13.0	42.2	
7409.60	-19.4	H	3.0	35.7	1.0	54.1	-13.0	41.1	
Mid Ch, 1880MHz									
3780.00	-21.3	V	3.0	35.8	1.0	56.1	-13.0	43.1	
5640.00	-23.4	V	3.0	35.5	1.0	57.8	-13.0	44.8	
7520.00	-24.1	V	3.0	35.7	1.0	58.8	-13.0	45.8	
3780.00	-18.3	H	3.0	35.8	1.0	53.1	-13.0	40.1	
5640.00	-21.8	H	3.0	35.5	1.0	56.3	-13.0	43.3	
7520.00	-19.4	H	3.0	35.7	1.0	54.2	-13.0	41.2	
High Ch, 1907.6MHz									
3815.20	-19.2	V	3.0	35.8	1.0	54.0	-13.0	41.0	
5722.80	-20.7	V	3.0	35.5	1.0	55.2	-13.0	42.2	
7630.40	-20.3	V	3.0	35.8	1.0	55.1	-13.0	42.1	
3815.20	-16.5	H	3.0	35.8	1.0	51.3	-13.0	38.3	
5722.80	-22.3	H	3.0	35.5	1.0	56.8	-13.0	43.8	
7630.40	-19.5	H	3.0	35.8	1.0	54.3	-13.0	41.3	

B2 HSDPA

UL Verification Services, Inc.
 Above 1GHz High Frequency Substitution Measurement

Company: VERIFONE
Project #: 11631998
Date: 9/6/2017
Test Engineer: GE43578
Configuration: EUT + AC Adapter
Location: Chamber C
Mode: Rel99 Band 5 Harmonics

f MHz	SG reading (dBm)	Ant. Pol. (H/V)	Distance (m)	Preamp (dB)	Filter (dB)	EIRP (dBm)	Limit (dBm)	Delta (dB)	Notes
Low Ch, 826.4MHz									
1652.80	-13.5	V	3.0	37.0	1.0	49.6	-13.0	36.6	
2479.20	-26.6	V	3.0	36.4	1.0	62.0	-13.0	49.0	
3305.60	-26.3	V	3.0	36.1	1.0	61.5	-13.0	48.5	
1652.80	-19.5	H	3.0	37.0	1.0	55.5	-13.0	42.5	
2479.20	-29.4	H	3.0	36.4	1.0	64.8	-13.0	51.8	
3305.60	-26.6	H	3.0	36.1	1.0	61.8	-13.0	48.8	
Mid Ch, 836.6MHz									
1673.20	-10.7	V	3.0	37.0	1.0	46.7	-13.0	33.7	
2509.80	-27.1	V	3.0	36.4	1.0	62.6	-13.0	49.6	
3346.40	-26.4	V	3.0	36.1	1.0	61.5	-13.0	48.5	
1673.20	-15.8	H	3.0	37.0	1.0	51.8	-13.0	38.8	
2509.80	-26.0	H	3.0	36.4	1.0	61.4	-13.0	48.4	
3346.40	-26.8	H	3.0	36.1	1.0	61.9	-13.0	48.9	
High Ch, 846.6MHz									
1693.20	-11.1	V	3.0	37.0	1.0	47.1	-13.0	34.1	
2539.80	-26.4	V	3.0	36.4	1.0	61.8	-13.0	48.8	
3386.40	-25.4	V	3.0	36.1	1.0	60.5	-13.0	47.5	
1693.20	-17.4	H	3.0	37.0	1.0	53.4	-13.0	40.4	
2539.80	-26.8	H	3.0	36.4	1.0	62.2	-13.0	49.2	
3386.40	-26.7	H	3.0	36.1	1.0	61.8	-13.0	48.8	

B5 REL99

UL Verification Services, Inc.
 Above 1GHz High Frequency Substitution Measurement

Company: VERIFONE
Project #: 11631998
Date: 9/6/2017
Test Engineer: GE43578
Configuration: EUT + AC Adapter
Location: Chamber C
Mode: HSDPA Band 5 Harmonics

f MHz	SG reading (dBm)	Ant. Pol. (H/V)	Distance (m)	Preamp (dB)	Filter (dB)	EIRP (dBm)	Limit (dBm)	Delta (dB)	Notes
Low Ch, 826.4MHz									
1652.80	-14.5	V	3.0	37.0	1.0	50.5	-13.0	37.5	
2479.20	-26.9	V	3.0	36.4	1.0	62.3	-13.0	49.3	
3305.60	-26.9	V	3.0	36.1	1.0	62.0	-13.0	49.0	
1652.80	-20.1	H	3.0	37.0	1.0	56.1	-13.0	43.1	
2479.20	-29.8	H	3.0	36.4	1.0	65.2	-13.0	52.2	
3305.60	-26.8	H	3.0	36.1	1.0	61.9	-13.0	48.9	
Mid Ch, 836.6MHz									
1673.20	-11.0	V	3.0	37.0	1.0	47.0	-13.0	34.0	
2509.80	-27.4	V	3.0	36.4	1.0	62.8	-13.0	49.8	
3346.40	-26.5	V	3.0	36.1	1.0	61.6	-13.0	48.6	
1673.20	-16.2	H	3.0	37.0	1.0	52.2	-13.0	39.2	
2509.80	-26.6	H	3.0	36.4	1.0	62.0	-13.0	49.0	
3346.40	-26.9	H	3.0	36.1	1.0	62.0	-13.0	49.0	
High Ch, 846.6MHz									
1693.20	-11.7	V	3.0	37.0	1.0	47.7	-13.0	34.7	
2539.80	-26.7	V	3.0	36.4	1.0	62.1	-13.0	49.1	
3386.40	-25.8	V	3.0	36.1	1.0	60.9	-13.0	47.9	
1693.20	-17.6	H	3.0	37.0	1.0	53.6	-13.0	40.6	
2539.80	-26.9	H	3.0	36.4	1.0	62.4	-13.0	49.4	
3386.40	-27.1	H	3.0	36.1	1.0	62.2	-13.0	49.2	

B5 HSDPA