



CERTIFICATION TEST REPORT

Report Number. : 11631998-E1V1

Applicant : Verifone, Inc.
1400 West Stanford Ranch Road
Rocklin, CA 95765, USA

Model : V240M Plus 3GBW

FCC ID : B32V240MPLUS

IC : 787C-V240MPLUS

EUT Description : Mobile Point of Sale Terminal

Test Standard(s) : FCC 47 CFR PART 15 SUBPART C
INDUSTRY CANADA RSS - 247 ISSUE 2
INDUSTRY CANADA RSS-GEN ISSUE 4

Date Of Issue:

August 16, 2017

Prepared by:

UL Verification Services Inc.
47173 Benicia Street
Fremont, CA 94538, U.S.A.
TEL: (510) 771-1000
FAX: (510) 661-0888



NVLAP LAB CODE 200065-0

Revision History

<u>Rev.</u>	<u>Issue Date</u>	<u>Revisions</u>	<u>Revised By</u>
V1	08/16/17	Initial Issue	D. Corona

TABLE OF CONTENTS

1. ATTESTATION OF TEST RESULTS	5
2. TEST METHODOLOGY	6
3. FACILITIES AND ACCREDITATION	6
4. CALIBRATION AND UNCERTAINTY	6
4.1. MEASURING INSTRUMENT CALIBRATION	6
4.2. SAMPLE CALCULATION	6
4.3. MEASUREMENT UNCERTAINTY	7
5. EQUIPMENT UNDER TEST	8
5.1. DESCRIPTION OF EUT	8
5.2. MAXIMUM OUTPUT POWER	8
5.3. DESCRIPTION OF AVAILABLE ANTENNAS	8
5.4. SOFTWARE AND FIRMWARE	8
5.5. WORST-CASE CONFIGURATION AND MODE	9
5.6. DESCRIPTION OF TEST SETUP	10
6. TEST AND MEASUREMENT EQUIPMENT	13
7. ANTENNA PORT TEST RESULTS	14
7.1. BASIC DATA RATE GFSK MODULATION	15
7.1.1. 20 dB AND 99% BANDWIDTH	15
7.1.2. HOPPING FREQUENCY SEPARATION	18
7.1.3. NUMBER OF HOPPING CHANNELS	19
7.1.4. AVERAGE TIME OF OCCUPANCY	22
7.1.5. OUTPUT POWER	26
7.1.6. AVERAGE POWER	28
7.1.7. CONDUCTED BANDEDGE AND SPURIOUS EMISSIONS	29
7.2. ENHANCED DATA RATE 8PSK MODULATION	33
7.2.1. 20 dB AND 99% BANDWIDTH	33
7.2.2. HOPPING FREQUENCY SEPARATION	36
7.2.3. NUMBER OF HOPPING CHANNELS	37
7.2.4. AVERAGE TIME OF OCCUPANCY	40
7.2.5. OUTPUT POWER	44
7.2.6. AVERAGE POWER	46
7.2.7. CONDUCTED BANDEDGE AND SPURIOUS EMISSIONS	47
8. RADIATED TEST RESULTS	51
8.1. LIMITS AND PROCEDURE	51

8.2.	WORST-CASE BELOW 30 MHz.....	52
8.3.	WORST-CASE BELOW 1 GHz.....	54
8.4.	TRANSMITTER ABOVE 1 GHz.....	56
8.4.1.	BASIC DATA RATE GFSK MODULATION.....	56
8.4.2.	ENHANCED DATA RATE 8PSK MODULATION.....	66
8.5.	WORST-CASE ABOVE 18 GHz.....	76
9.	AC POWER LINE CONDUCTED EMISSIONS.....	78
10.	SETUP PHOTOS.....	81

1. ATTESTATION OF TEST RESULTS

COMPANY NAME: Verifone, Inc.
1400 West Stanford Ranch Road Suite 200
Rocklin, CA 95765, USA

EUT DESCRIPTION: Mobile Point of Sale

MODEL: V240M Plus 3GBW

SERIAL NUMBER: 313-855-592, 313-855-662

DATE TESTED: April 28 to May 26, 2017

APPLICABLE STANDARDS	
STANDARD	TEST RESULTS
FCC 47 CFR 47 PART 15 SUBPART C	Pass
INDUSTRY CANADA RSS-247 ISSUE 2	Pass
INDUSTRY CANADA RSS-GEN ISSUE 4	Pass

UL Verification Services Inc. tested the above equipment in accordance with the requirements set forth in the above standards. All indications of Pass/Fail in this report are opinions expressed by UL Verification Services Inc. based on interpretations and/or observations of test results. Measurement Uncertainties were not taken into account and are published for informational purposes only. The test results show that the equipment tested is capable of demonstrating compliance with the requirements as documented in this report.

Note: The results documented in this report apply only to the tested sample, under the conditions and modes of operation as described herein. This document may not be altered or revised in any way unless done so by UL Verification Services Inc. and all revisions are duly noted in the revisions section. Any alteration of this document not carried out by UL Verification Services Inc. will constitute fraud and shall nullify the document. This report must not be used by the client to claim product certification, approval, or endorsement by NVLAP, NIST, any agency of the Federal Government, or any agency of any government.

Approved & Released For
UL Verification Services Inc. By:

Prepared By:

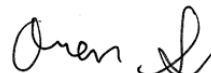

DAN CORONIA
WISE PROJECT LEAD
UL VERIFICATION SERVICES INC.

OREN STOELTING
WISE LAB TECHNICIAN
UL VERIFICATION SERVICES INC.

2. TEST METHODOLOGY

The tests documented in this report were performed in accordance with FCC CFR 47 Part 2, FCC CFR 47 Part 15, KDB 558074 D01 v03r05 and ANSI C63.10-2013, IC RSS-GEN Issue 4, and IC RSS-247 ISSUE 2.

3. FACILITIES AND ACCREDITATION

The test sites and measurement facilities used to collect data are located at 47173 and 47266 Benicia Street, Fremont, California, USA. Line conducted emissions are measured only at the 47173 address. The following table identifies which facilities were utilized for radiated emission measurements documented in this report. Specific facilities are also identified in the test results sections.

47173 Benicia Street		47266 Benicia Street	
<input type="checkbox"/>	Chamber A (IC:2324B-1)	<input type="checkbox"/>	Chamber D (IC:22541-1)
<input checked="" type="checkbox"/>	Chamber B (IC:2324B-2)	<input type="checkbox"/>	Chamber E (IC:22541-2)
<input checked="" type="checkbox"/>	Chamber C (IC:2324B-3)	<input type="checkbox"/>	Chamber F (IC:22541-3)
		<input type="checkbox"/>	Chamber G (IC:22541-4)
		<input type="checkbox"/>	Chamber H (IC:22541-5)

The above test sites and facilities are covered under FCC Test Firm Registration # 208313. UL Verification Services Inc. is accredited by NVLAP, Laboratory Code 200065-0.

Chambers A through C are covered under Industry Canada company address code 2324B with site numbers 2324B -1 through 2324B-3, respectively and Chambers D through H are covered under Industry Canada company address code 22541 with site numbers 22541 -1 through 22541-5, respectively.

4. CALIBRATION AND UNCERTAINTY

4.1. MEASURING INSTRUMENT CALIBRATION

The measuring equipment utilized to perform the tests documented in this report has been calibrated in accordance with the manufacturer's recommendations, and is traceable to recognized national standards.

4.2. SAMPLE CALCULATION

Where relevant, the following sample calculation is provided:

$$\begin{aligned} \text{Field Strength (dBuV/m)} &= \text{Measured Voltage (dBuV)} + \text{Antenna Factor (dB/m)} + \\ &\text{Cable Loss (dB)} - \text{Preamp Gain (dB)} \\ 36.5 \text{ dBuV} + 18.7 \text{ dB/m} + 0.6 \text{ dB} - 26.9 \text{ dB} &= 28.9 \text{ dBuV/m} \end{aligned}$$

4.3. MEASUREMENT UNCERTAINTY

Where relevant, the following measurement uncertainty levels have been estimated for tests performed on the apparatus:

Parameter	Uncertainty
Worst Case Conducted Disturbance, 9KHz to 0.15 MHz	3.84 dB
Worst Case Conducted Disturbance, 0.15 to 30 MHz	3.65 dB
Worst Case Radiated Disturbance, 9KHz to 30 MHz	3.15 dB
Worst Case Radiated Disturbance, 30 to 1000 MHz	5.36 dB
Worst Case Radiated Disturbance, 1000 to 18000 MHz	4.32 dB
Worst Case Radiated Disturbance, 18000 to 26000 MHz	4.45 dB
Worst Case Radiated Disturbance, 26000 to 40000 MHz	5.24 dB

Uncertainty figures are valid to a confidence level of 95%.

5. EQUIPMENT UNDER TEST

5.1. DESCRIPTION OF EUT

The EUT is the Mobile Point of Sale Terminal which contains an 11a/b/g/n/ac WLAN + Bluetooth 4.1 combo module.

5.2. MAXIMUM OUTPUT POWER

The transmitter has a maximum peak conducted output power as follows:

Frequency Range (MHz)	Mode	Output Power (dBm)	Output Power (mW)
2402 - 2480	Basic GFSK	7.74	5.94
2402 - 2480	Enhanced 8PSK	6.61	4.58

5.3. DESCRIPTION OF AVAILABLE ANTENNAS

The radio utilizes a WiFi antenna with a maximum gain of 1.90 dBi across the frequencies in 2.4GHz band.

5.4. SOFTWARE AND FIRMWARE

The firmware installed in the EUT during testing was VOS2 – 30640xxx.

5.5. WORST-CASE CONFIGURATION AND MODE

Radiated band edge, harmonics, and spurious emissions from 1 GHz to 18GHz were performed with the EUT was set to transmit at the Low/Middle/High channels.

Radiated emission below 30MHz, below 1GHz, above 18GHz, and power line conducted emission were performed with the EUT was set to transmit at the channel with highest output power as worst-case scenario.

The fundamental of the EUT was investigated in three orthogonal orientations X, Y, & Z, and it was determined that X-Axis orientation was worst-case orientation; therefore, all final radiated testing was performed with the EUT in X-Axis orientation.

Worst-case data rates were:
GFSK mode: DH5
8PSK mode: 3-DH5

DQPSK mode has been verified to have the lowest power.

5.6. DESCRIPTION OF TEST SETUP

SUPPORT EQUIPMENT

Support Equipment List				
Description	Manufacturer	Model	Serial Number	FCC ID
Laptop	Lenovo	20B7S0A200	PC015REW	NA
AC Adapter	Verifone	SC1402	1708200053701	NA
AC Adapter	Verifone	AM11A-050A	1650A1P	NA

I/O CABLES (CONDUCTED TEST)

I/O Cable List						
Cable No	Port	# of identical ports	Connector Type	Cable Type	Cable Length (m)	Remarks
1	Antenna	1	SMA	Un-Shielded	0.1	To Spectrum Analyzer and Bluetooth Tester
2	DC	1	AC	Un-shielded	2	N/A
3	USB	1	USB	Shielded	2	N/A

I/O CABLES (RADIATED TEST)

I/O Cable List						
Cable No	Port	# of identical ports	Connector Type	Cable Type	Cable Length (m)	Remarks
1	DC	1	AC	Un-shielded	2	N/A

TEST SETUP- CONDUCTED PORT

The EUT was tested connected to a host Laptop via USB cable adapter and spectrum analyzer to antenna port coupled with the Bluetooth Tester.

SETUP DIAGRAM

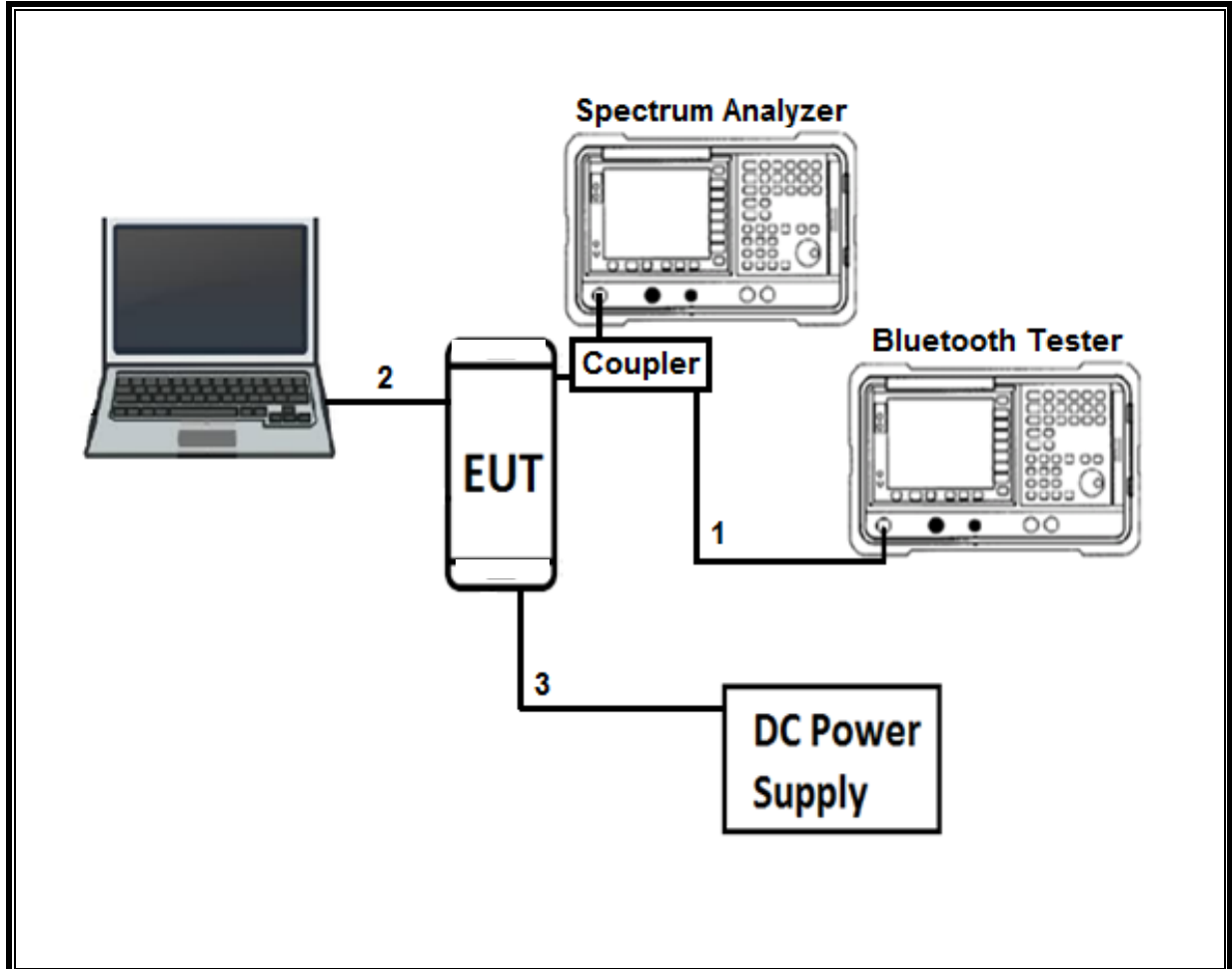

TEST SETUP- RADIATED-ABOVE 1 GHZ and AC LINE CONDUCTED TESTS

The EUT was powered by AC Adapter. Test software exercised the EUT.

SETUP DIAGRAM

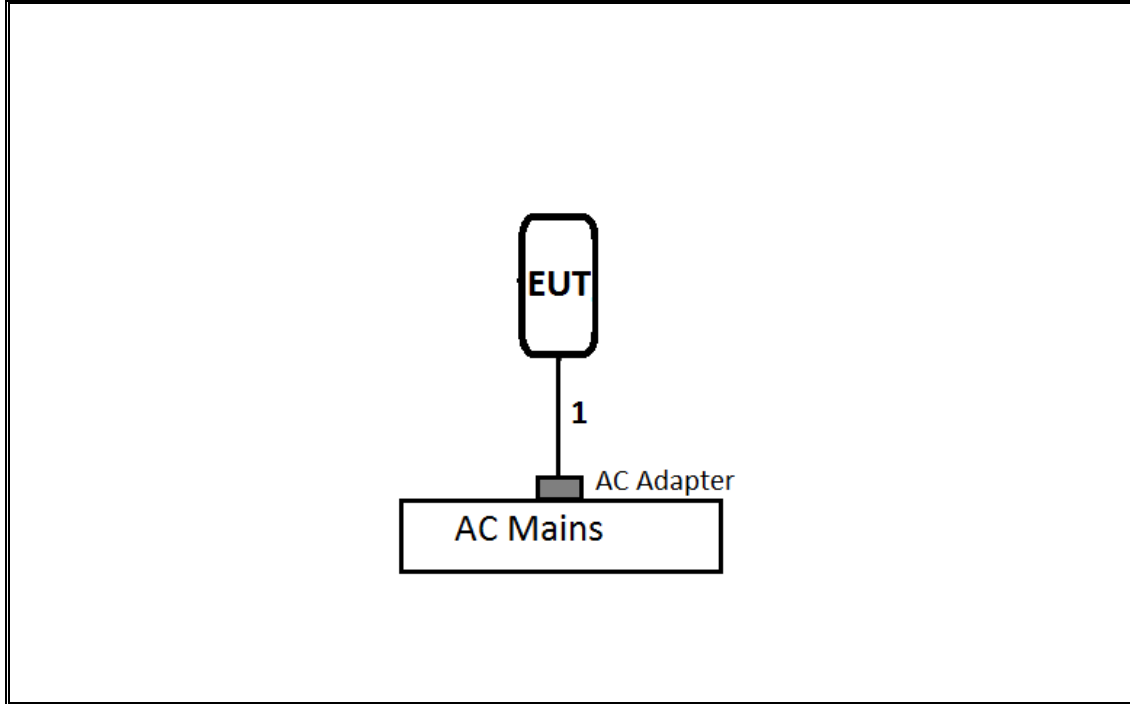

6. TEST AND MEASUREMENT EQUIPMENT

TEST EQUIPMENT LIST				
Description	Manufacturer	Model	Asset	Cal Due
Antenna, Broadband Hybrid, 30MHz to 2000MHz w/4dB Pad	Sunol Sciences Corp	JB3	T477	06/22/2017
Antenna, Active Loop 9kHz-30MHz	ETS-Lindgren	6502	T1683	02/17/2018
Antenna, Horn 1-18GHz	ETS-Lindgren	3117	T712	01/30/2018
Antenna, Horn 18-26.5GHz	ARA	MWH-1826/B	T449	05/26/2017
Power Meter, P-series single channel	Agilent (Keysight) Technologies	N1911A	T1264	07/08/2017
Power Sensor, P – series, 50MHz to 18GHz, Wideband	Agilent (Keysight) Technologies	N1921A	T413	06/20/2017
Amplifier, 1-26.5GHz	Agilent (Keysight) Technologies	8449B	T404	07/05/2017
Amplifier, 10kHz-1GHz	Agilent (Keysight) Technologies	8447D	T15	08/26/2017
Amplifier, 1-8 GHz	MITEQ	AFS42-00101800-25-S-42	T931	08/26/2017
Spectrum Analyzer, PSA, 3Hz to 26.5GHz	Agilent (Keysight) Technologies	E4440A	T199	07/22/2017
Spectrum Analyzer, PXA, 3Hz to 44GHz	Agilent (Keysight) Technologies	N9030A	T907	01/23/2018
Spectrum Analyzer, PSA, 3Hz to 26.5GHz	Agilent (Keysight) Technologies	E9030A	T905	01/11/2018
LISN	FISCHER	FCC-LISN-50/250-25-2-01	T1310	06/08/2017

Test Software List			
Description	Manufacturer	Model	Version
Radiated Software	UL	UL EMC	Ver 9.5, Apr 26, 2016
Antenna Port Software	UL	UL RF	Ver 5.1.1, July 15, 2016

7. ANTENNA PORT TEST RESULTS

ON TIME AND DUTY CYCLE

LIMITS

None; for reporting purposes only.

PROCEDURE

KDB 558074 Zero-Span Spectrum Analyzer Method.

ON TIME AND DUTY CYCLE RESULTS

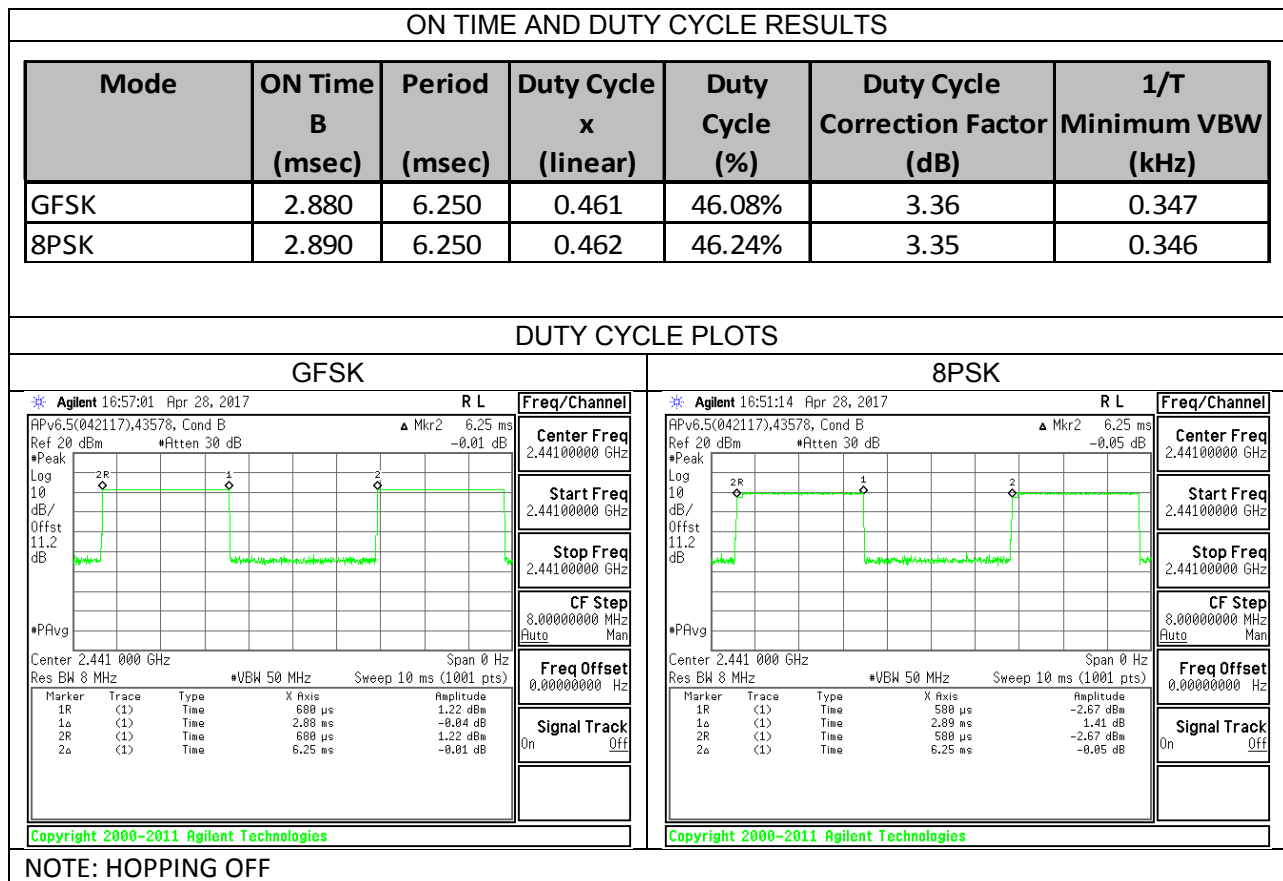

7.1. BASIC DATA RATE GFSK MODULATION

7.1.1. 20 dB AND 99% BANDWIDTH

LIMITS

None; for reporting purposes only.

TEST PROCEDURE

The transmitter output is connected to a spectrum analyzer. The RBW is set to $\geq 1\%$ of the 20 dB bandwidth. The VBW is set to \geq RBW. The sweep time is coupled.

RESULTS

Channel	Frequency (MHz)	20 dB Bandwidth (KHz)	99% Bandwidth (KHz)
Low	2402	917.04	909.41
Middle	2441	925.14	908.58
High	2480	923.55	902.22

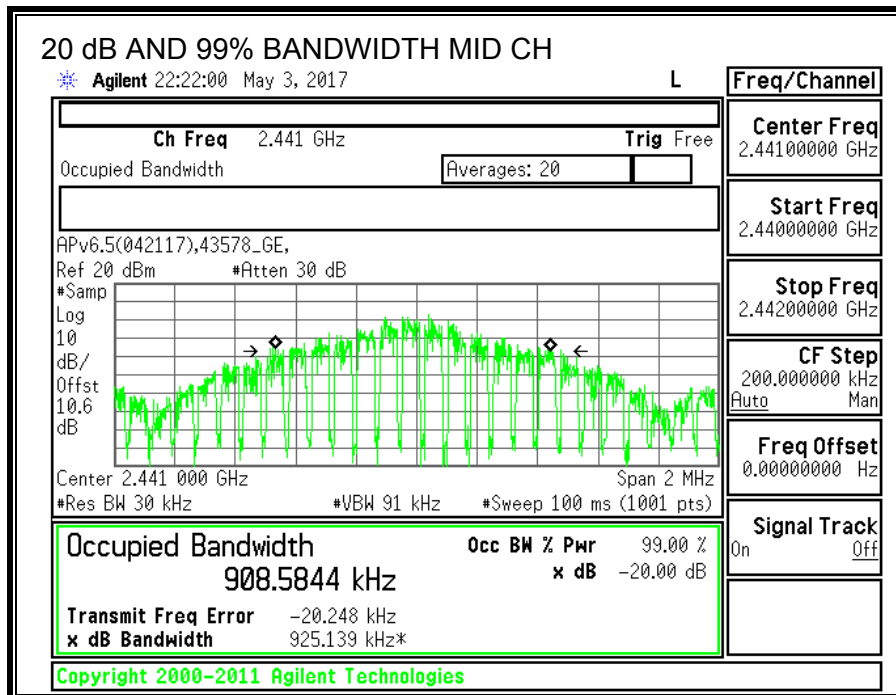
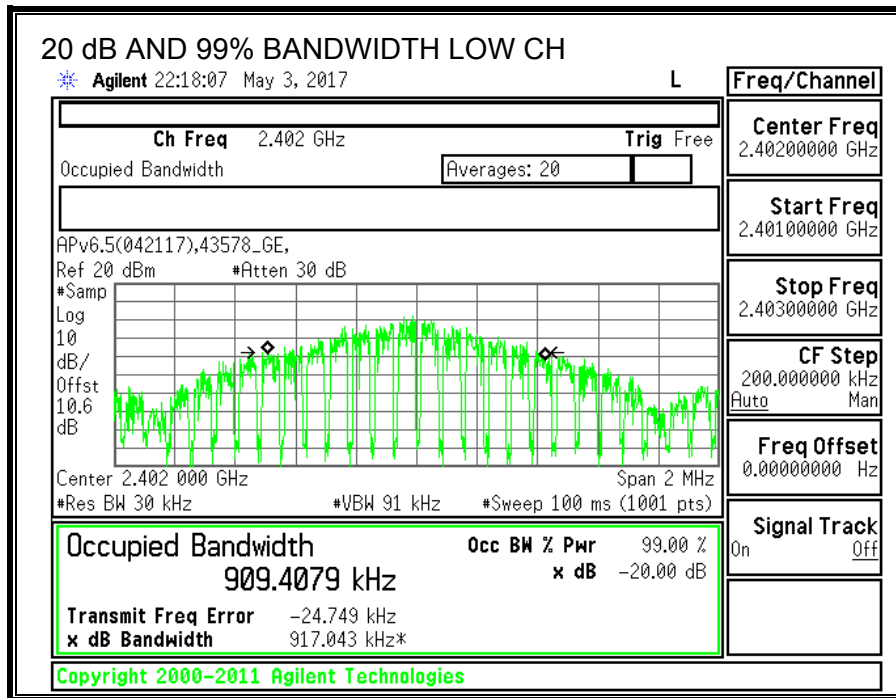

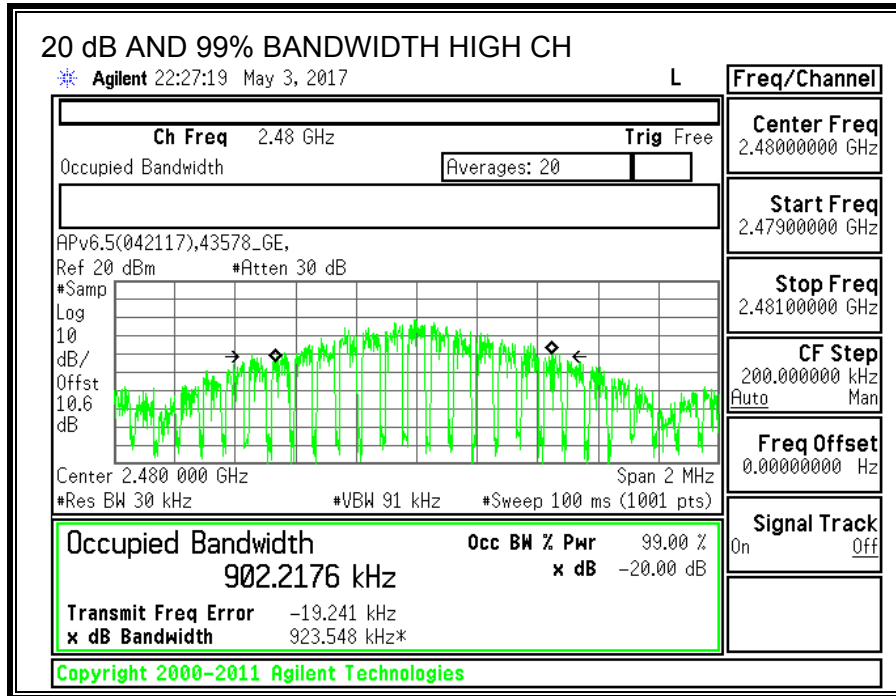

7.1.2. HOPPING FREQUENCY SEPARATION

LIMITS

FCC §15.247 (a) (1)
 IC RSS-247 (5.1) (b)

Frequency hopping systems shall have hopping channel carrier frequencies separated by a minimum of 25 kHz or the 20 dB bandwidth of the hopping channel, whichever is greater.

Alternatively, frequency hopping systems operating in the 2400-2483.5 MHz band may have hopping channel carrier frequencies that are separated by 25 kHz or two-thirds of the 20 dB bandwidth of the hopping channel, whichever is greater, provided the systems operate with an output power no greater than 125 mW.

TEST PROCEDURE

The transmitter output is connected to a spectrum analyzer. The RBW is set to 300 kHz and the VBW is set to 910 kHz. The sweep time is coupled.

RESULTS

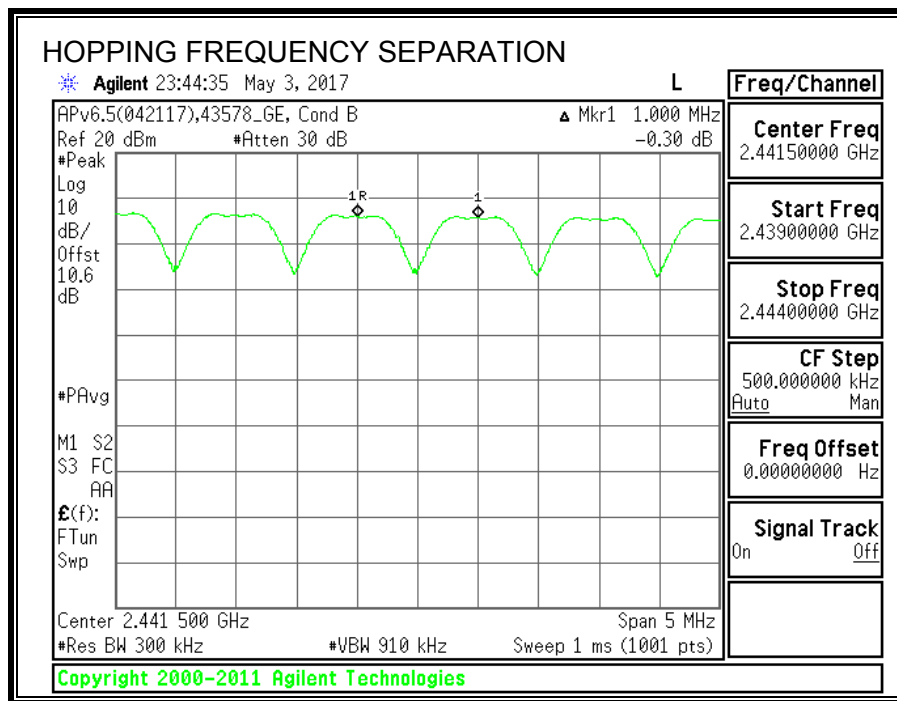

7.1.3. NUMBER OF HOPPING CHANNELS

LIMITS

FCC §15.247 (a) (1) (iii)
 IC RSS-247 (5.1) (d)

Frequency hopping systems in the 2400 – 2483.5 MHz band shall use at least 15 non-overlapping channels.

TEST PROCEDURE

The transmitter output is connected to a spectrum analyzer. The span is set to cover the entire authorized band, in either a single sweep or in multiple contiguous sweeps. The RBW is set to a maximum of 1 % of the span. The analyzer is set to Max Hold.

RESULTS

Normal Mode: 79 Channels observed.

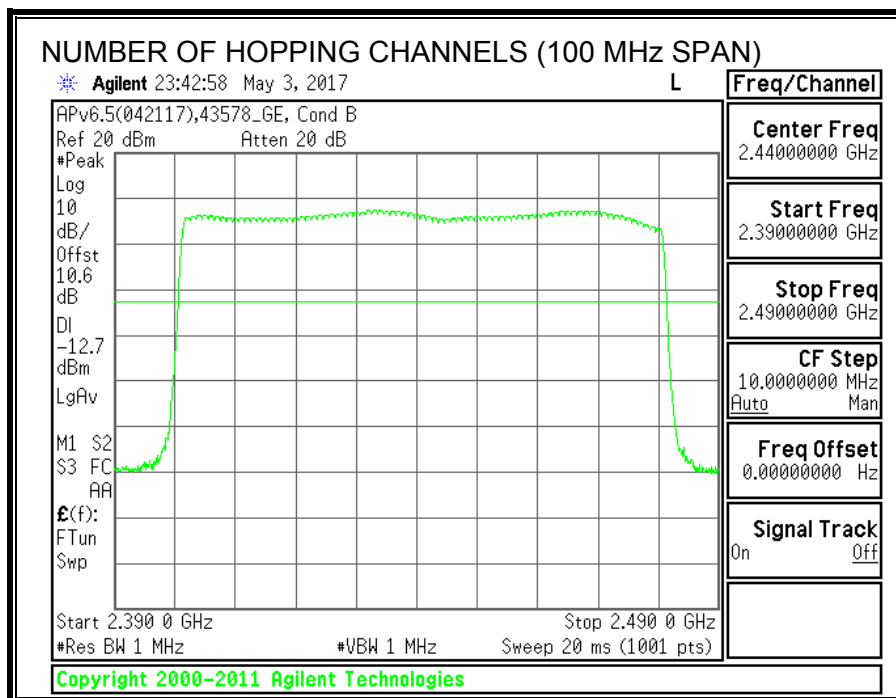

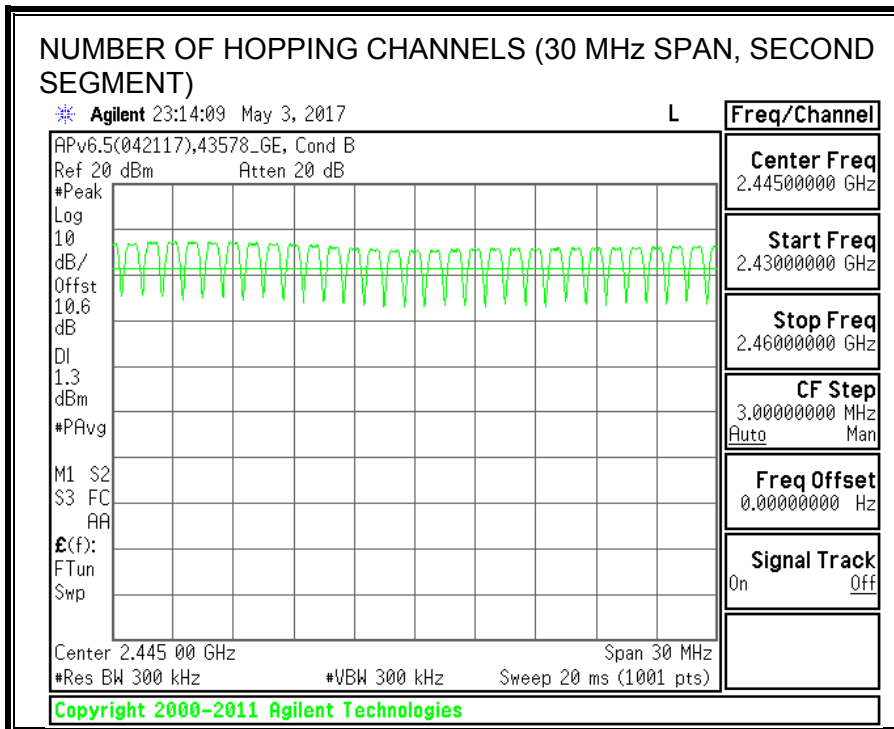
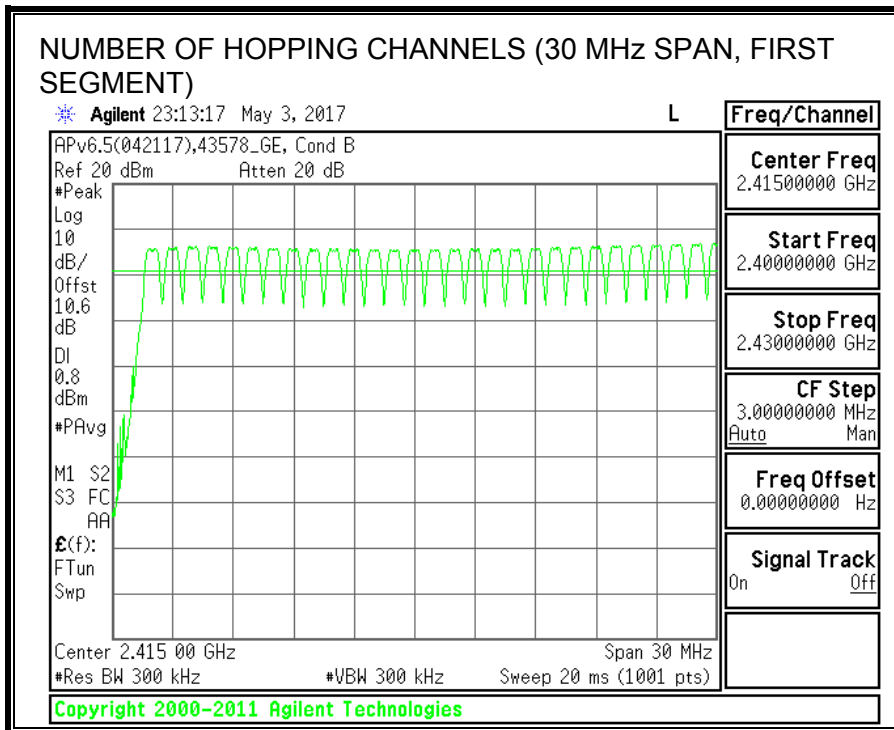

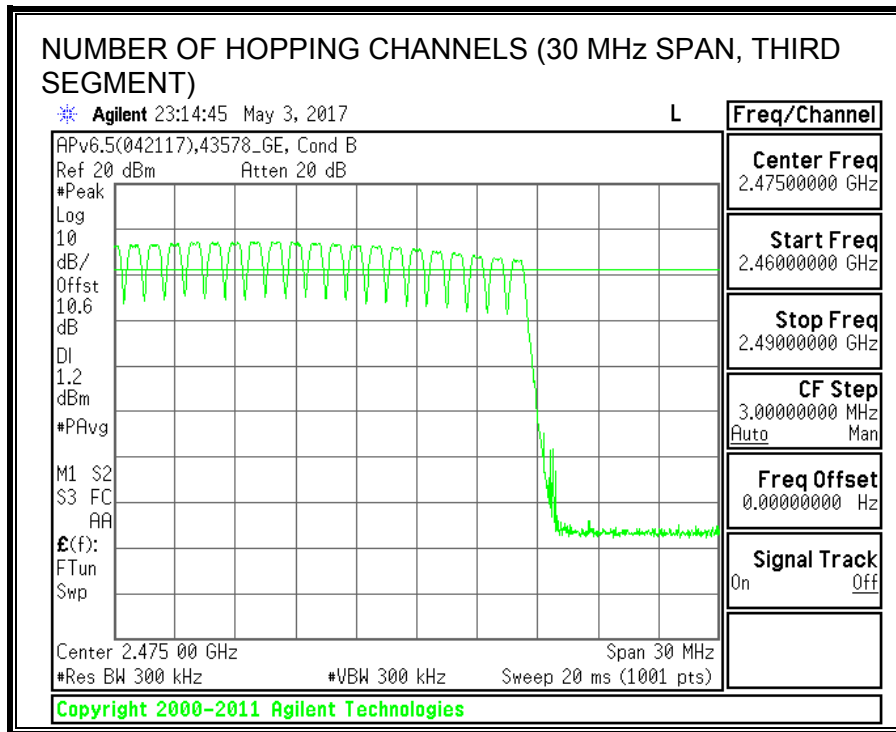

7.1.4. AVERAGE TIME OF OCCUPANCY

LIMITS

FCC §15.247 (a) (1) (iii)
 IC RSS-247 (5.1) (d)

The average time of occupancy on any channel shall not be greater than 0.4 seconds within a period of 0.4 seconds multiplied by the number of hopping channels employed.

TEST PROCEDURE

The transmitter output is connected to a spectrum analyzer. The span is set to 0 Hz, centered on a single, selected hopping channel. The width of a single pulse is measured in a fast scan. The number of pulses is measured in a 3.16 second scan, to enable resolution of each occurrence.

The average time of occupancy in the specified 31.6 second period (79 channels * 0.4 s) is equal to $10 * (\# \text{ of pulses in } 3.16 \text{ s}) * \text{ pulse width}$.

For AFH mode, the average time of occupancy in the specified 8 second period (20 channels * 0.4 seconds) is equal to $10 * (\# \text{ of pulses in } 0.8 \text{ s}) * \text{ pulse width}$.

RESULTS

AVERAGE TIME OF OCCUPANCY					
DH Packet	Pulse Width (msec)	Number of Pulses in 3.16 seconds	Average Time of Occupancy (sec)	Limit (sec)	Margin (sec)
GFSK Normal Mode					
DH1	0.384	32	0.1229	0.4	-0.2771
DH3	1.640	16	0.2624	0.4	-0.1376
DH5	2.889	12	0.3467	0.4	-0.0533
DH Packet	Pulse Width (sec)	Number of Pulses in 0.8 seconds	Average Time of Occupancy (sec)	Limit (sec)	Margin (sec)
GFSK AFH Mode					
DH1	0.384	8	0.03073	0.4	-0.3693
DH3	1.640	4	0.06560	0.4	-0.3344
DH5	2.889	3	0.08667	0.4	-0.3133
NOTE: --					

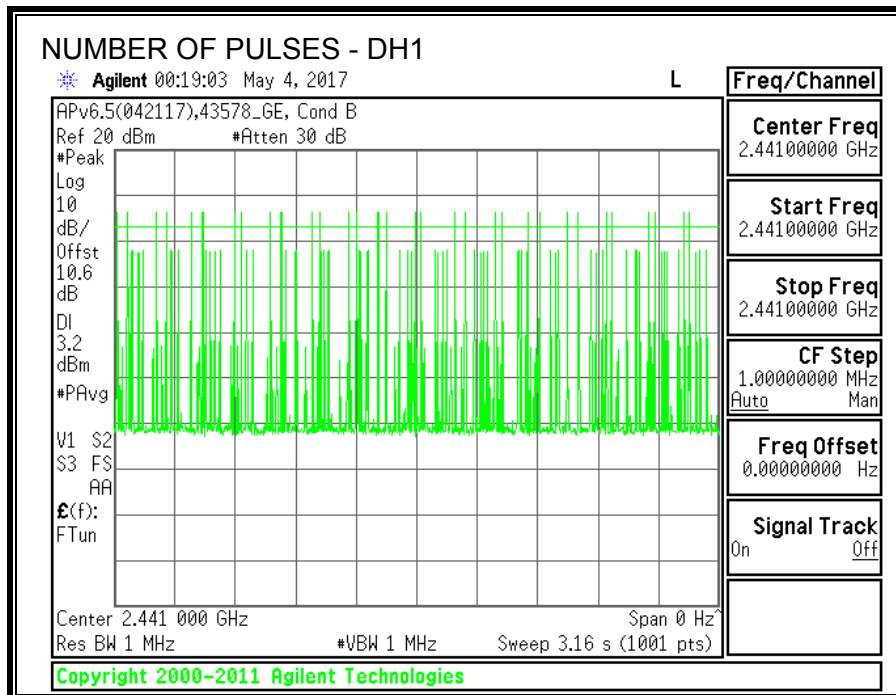
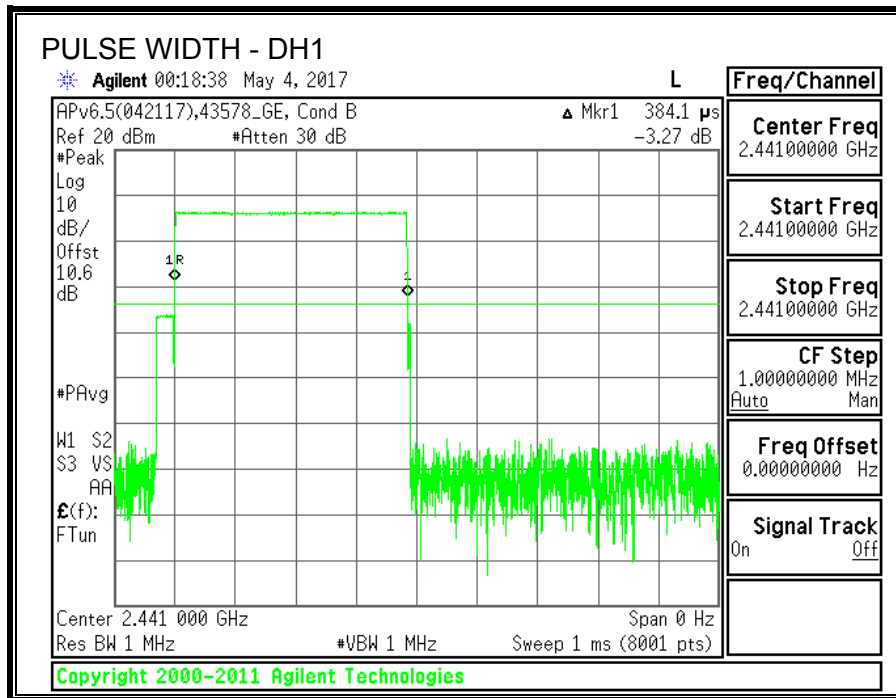

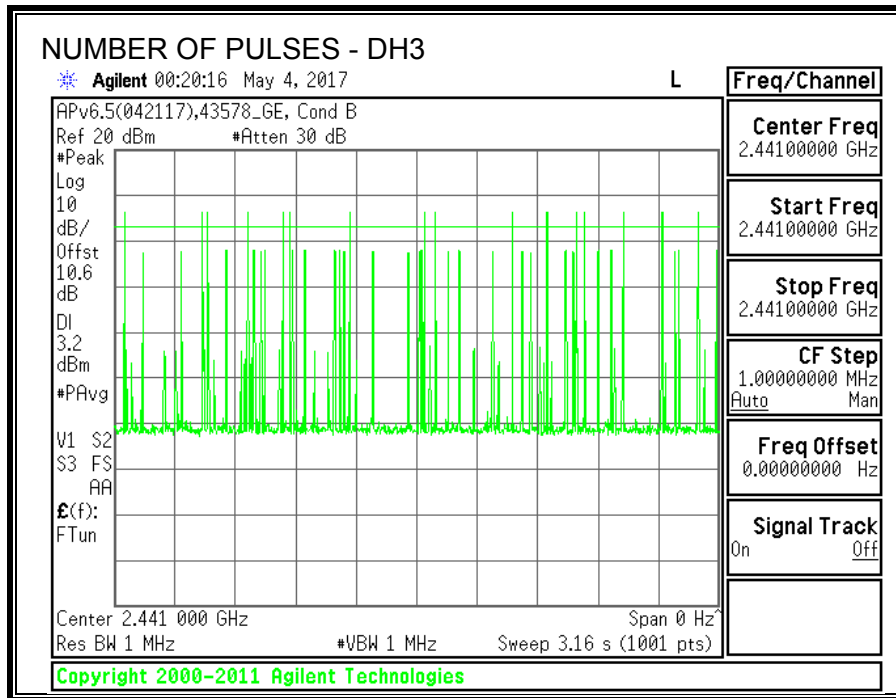
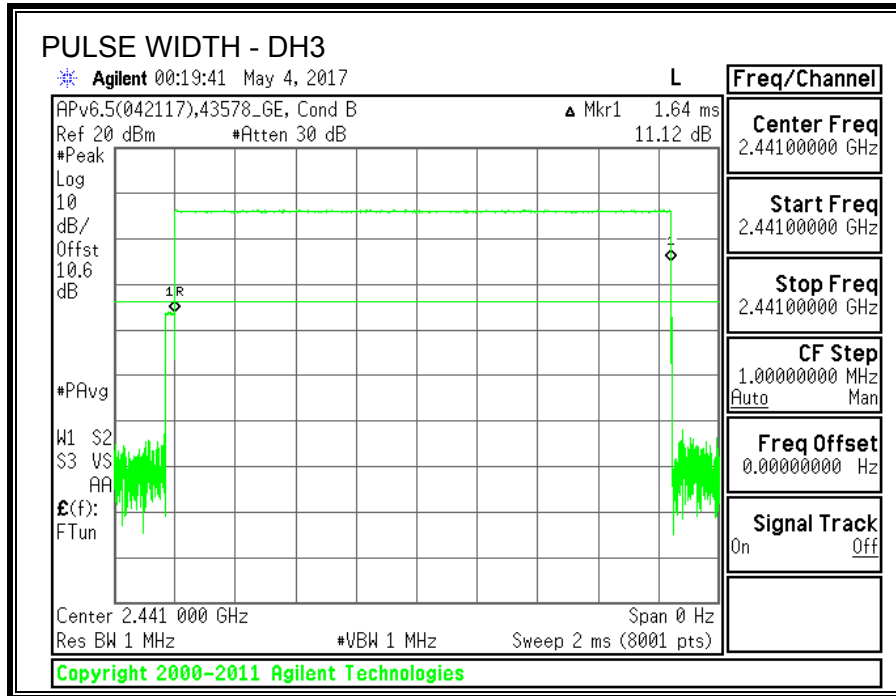

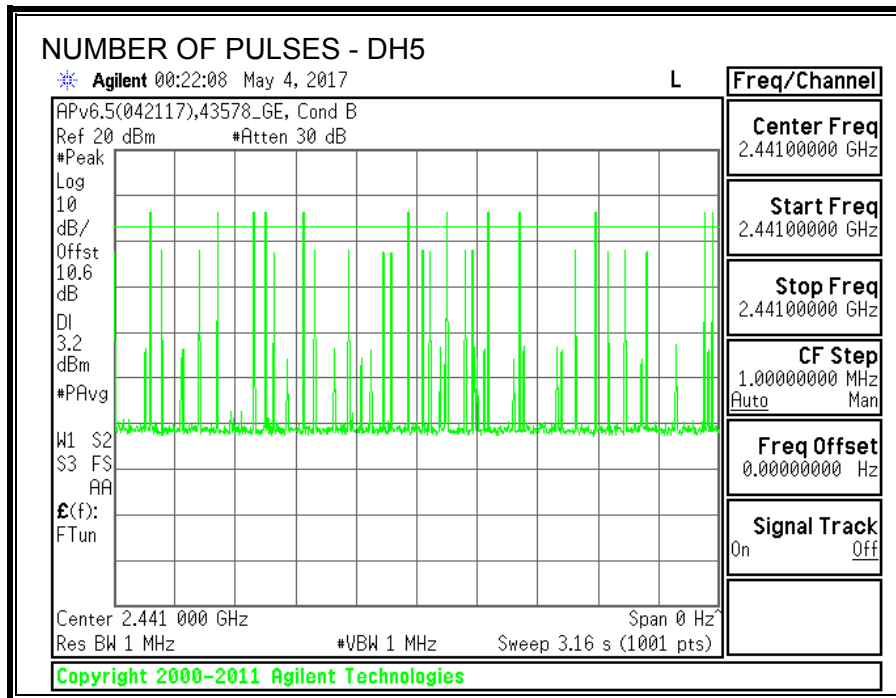
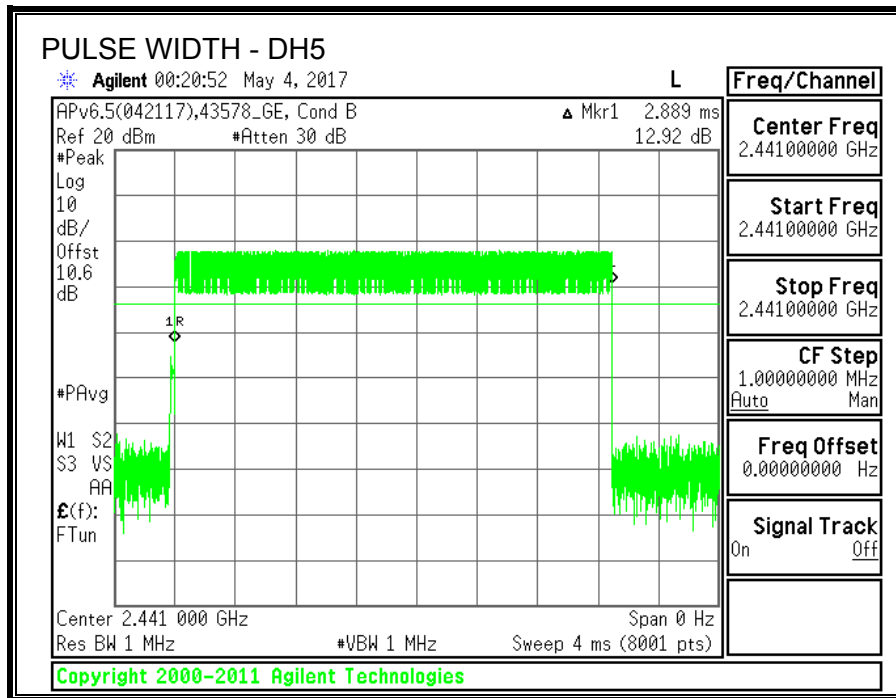

7.1.5. OUTPUT POWER

LIMITS

§15.247 (b) (1)
RSS-247 (5.4) (b)

The maximum antenna gain is less than 6 dBi, therefore the limit is 30 dBm.

TEST PROCEDURE

The transmitter output is connected to a spectrum analyzer.

RESULTS

TEST ENGINEER:	43578	Date:	5/3/2017
-----------------------	-------	--------------	----------

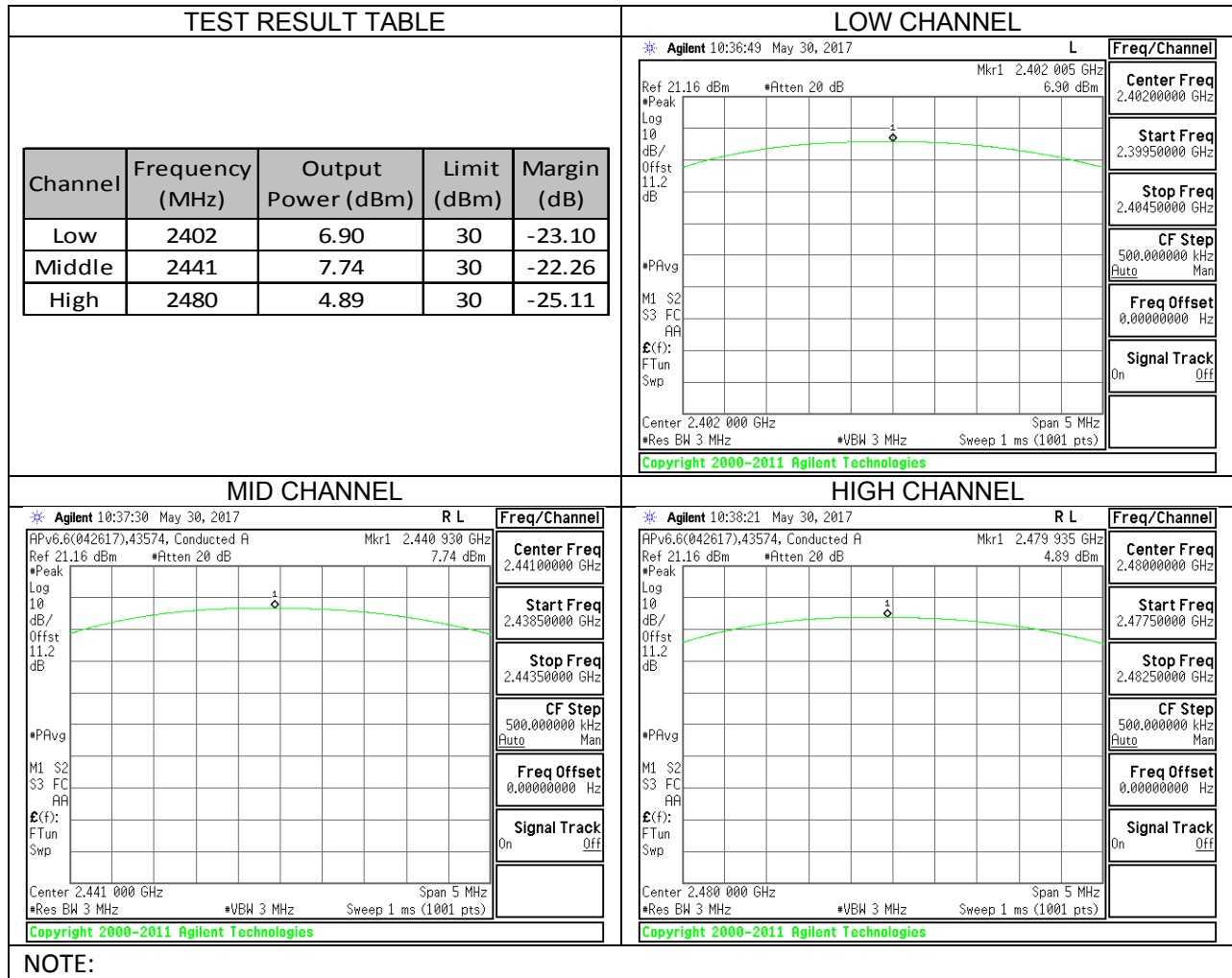

7.1.6. AVERAGE POWER

LIMITS

None; for reporting purposes only.

TEST PROCEDURE

The transmitter output is connected to a power meter.

RESULTS

The cable assembly insertion loss of 11 dB (including 10 dB pad and 0.6 dB cable) was entered as an offset in the power meter to allow for direct reading of power.

TEST ENGINEER:	43574	Date:	5/24/17
-----------------------	-------	--------------	---------

Channel	Frequency (MHz)	Average Power (dBm)
Low	2402	6.50
Middle	2441	7.40
High	2480	4.50

7.1.7. CONDUCTED BANDEDGE AND SPURIOUS EMISSIONS

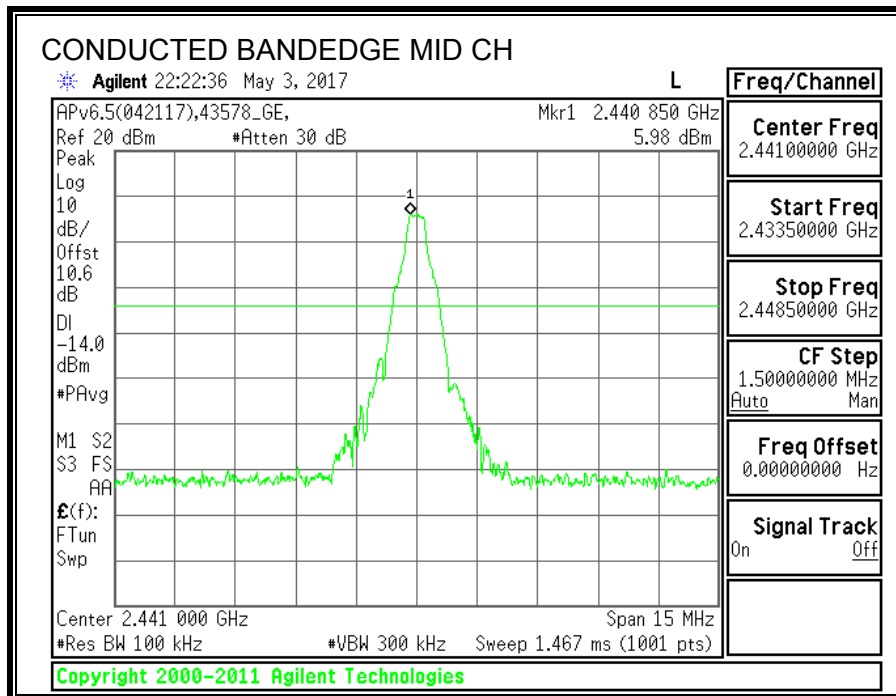
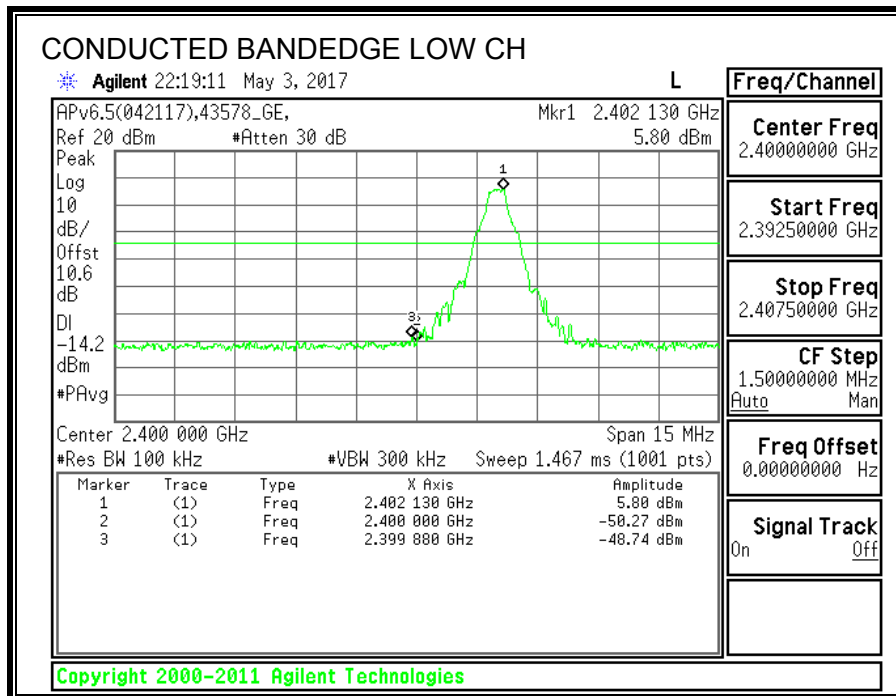

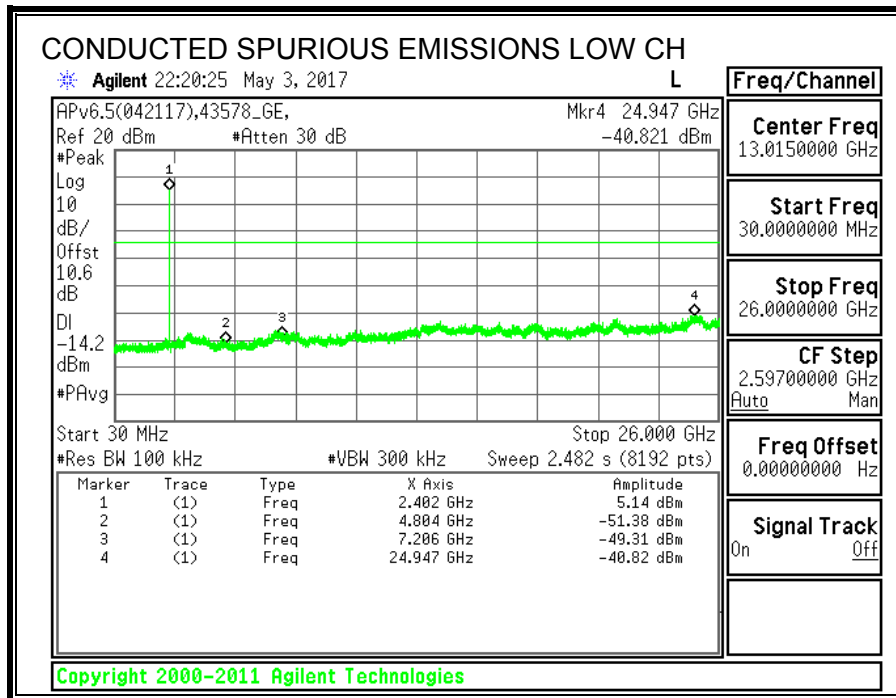
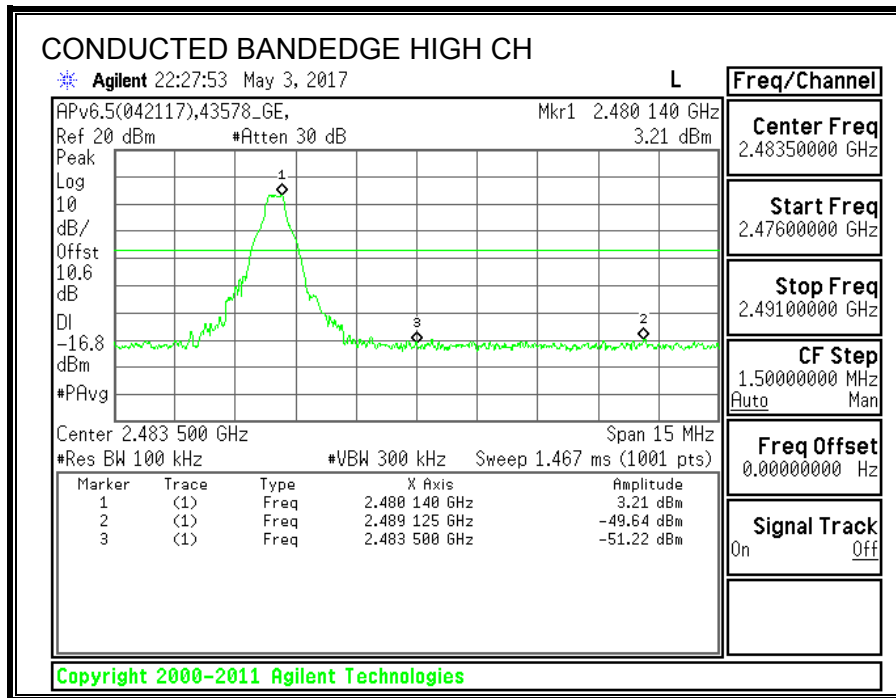

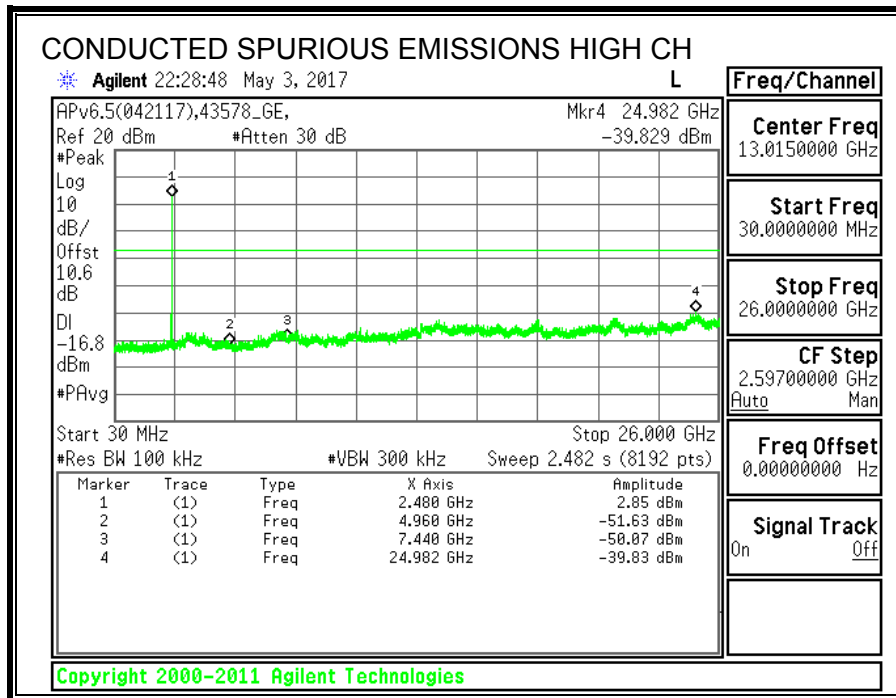
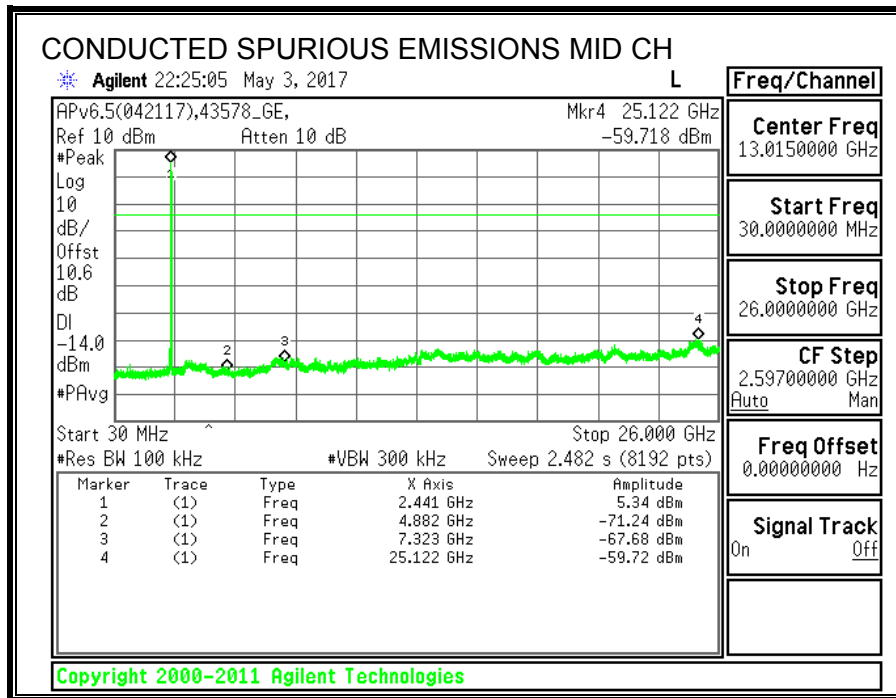

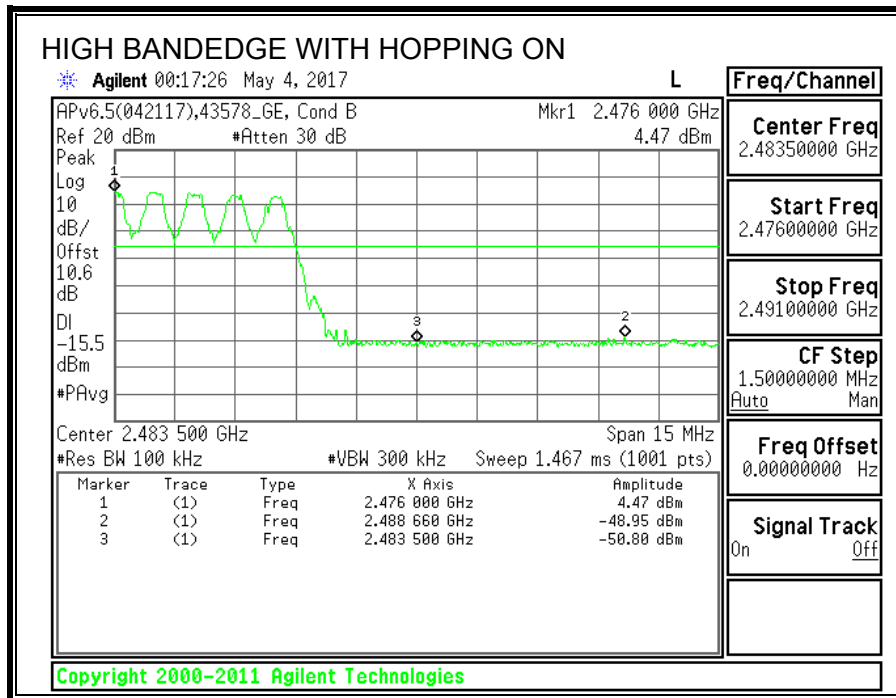
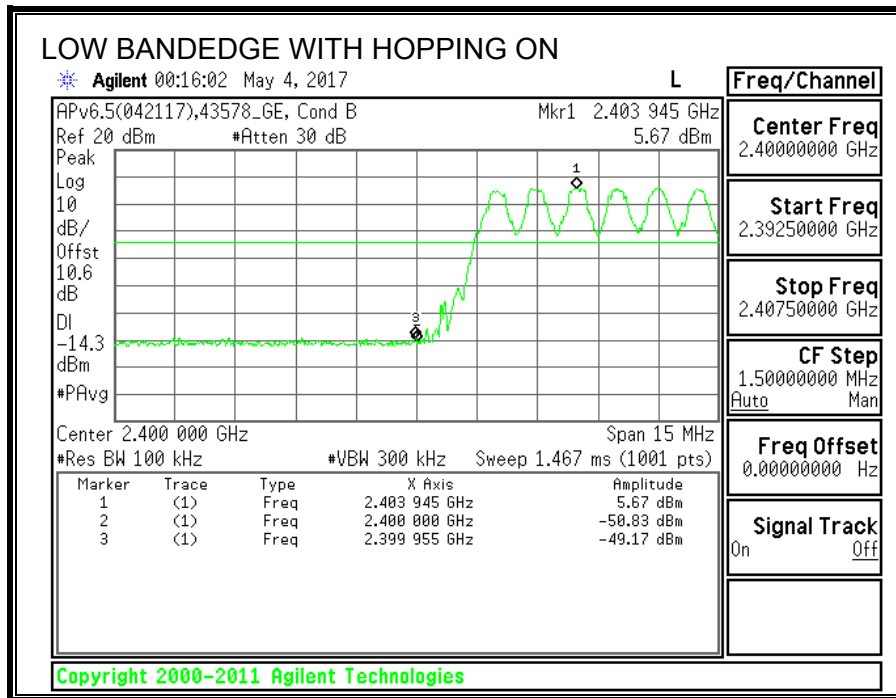

7.2. ENHANCED DATA RATE 8PSK MODULATION

7.2.1. 20 dB AND 99% BANDWIDTH

LIMITS

None; for reporting purposes only.

TEST PROCEDURE

The transmitter output is connected to a spectrum analyzer. The RBW is set to $\geq 1\%$ of the 20 dB bandwidth. The VBW is set to \geq RBW. The sweep time is coupled.

RESULTS

Channel	Frequency (MHz)	20 dB Bandwidth (MHz)	99% Bandwidth (MHz)
Low	2402	1.327	1.233
Middle	2441	1.326	1.253
High	2480	1.340	1.257

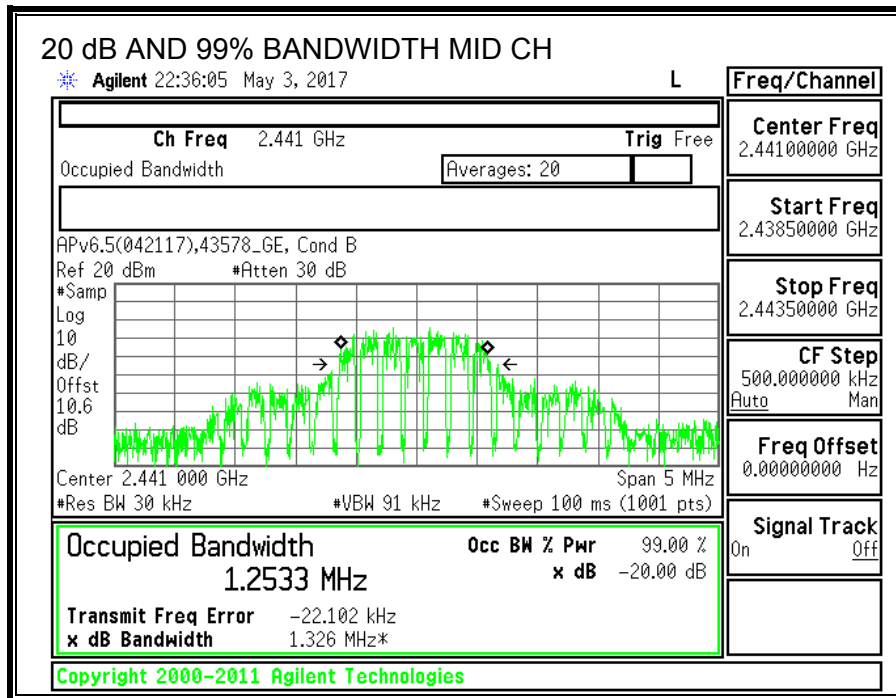
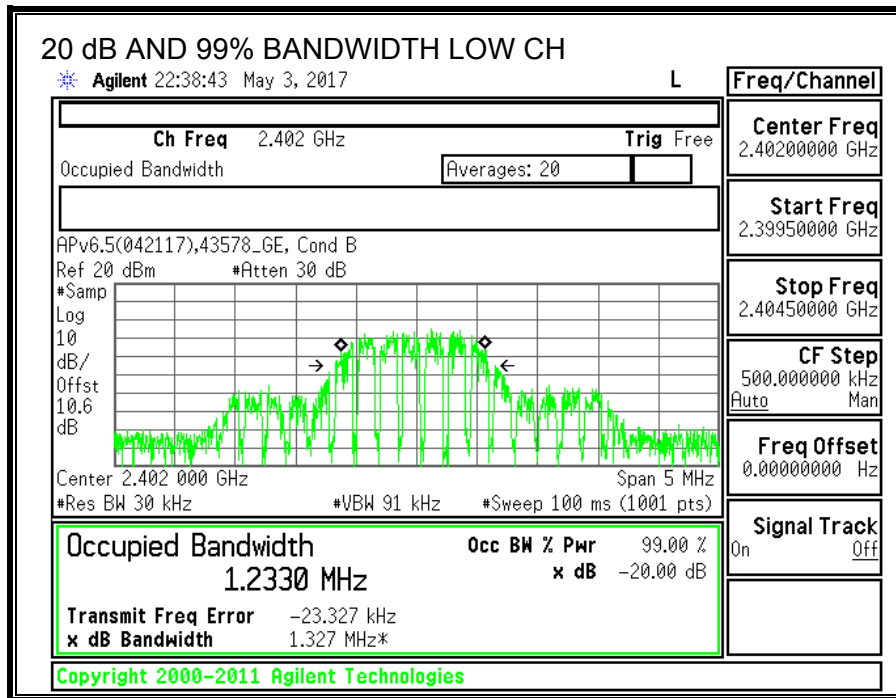

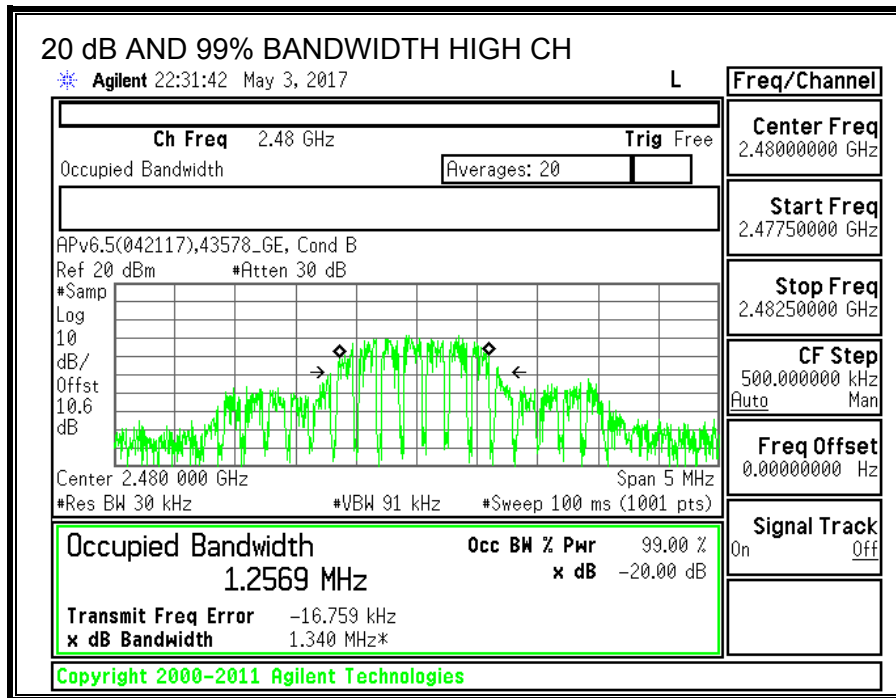

7.2.2. HOPPING FREQUENCY SEPARATION

LIMITS

FCC §15.247 (a) (1)
 IC RSS-247 (5.1) (b)

Frequency hopping systems shall have hopping channel carrier frequencies separated by a minimum of 25 kHz or the 20 dB bandwidth of the hopping channel, whichever is greater.

Alternatively, frequency hopping systems operating in the 2400-2483.5 MHz band may have hopping channel carrier frequencies that are separated by 25 kHz or two-thirds of the 20 dB bandwidth of the hopping channel, whichever is greater, provided the systems operate with an output power no greater than 125 mW.

TEST PROCEDURE

The transmitter output is connected to a spectrum analyzer. The RBW is set to 300 kHz and the VBW is set to 910 kHz. The sweep time is coupled.

RESULTS

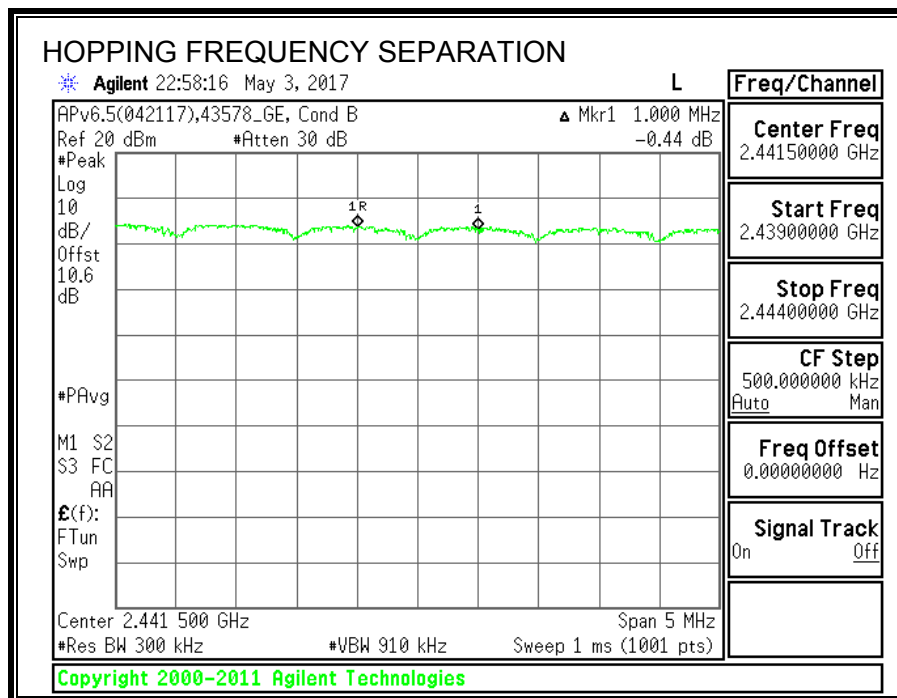

7.2.3. NUMBER OF HOPPING CHANNELS

LIMITS

FCC §15.247 (a) (1) (iii)
 IC RSS-247 (5.1) (d)

Frequency hopping systems in the 2400 – 2483.5 MHz band shall use at least 15 non-overlapping channels.

TEST PROCEDURE

The transmitter output is connected to a spectrum analyzer. The span is set to cover the entire authorized band, in either a single sweep or in multiple contiguous sweeps. The RBW is set to a maximum of 1 % of the span. The analyzer is set to Max Hold.

RESULTS

Normal Mode: 79 Channels observed.

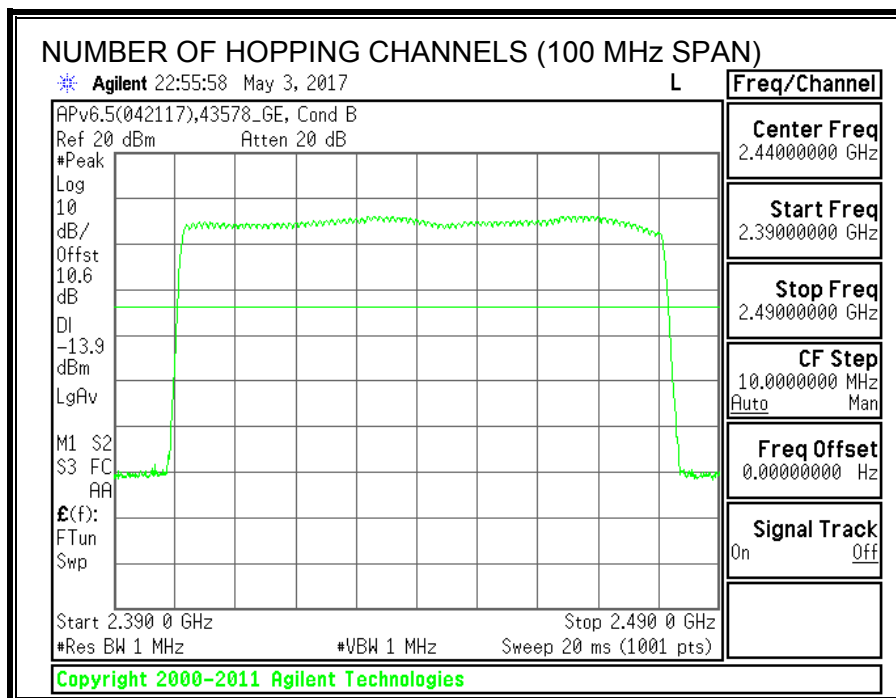

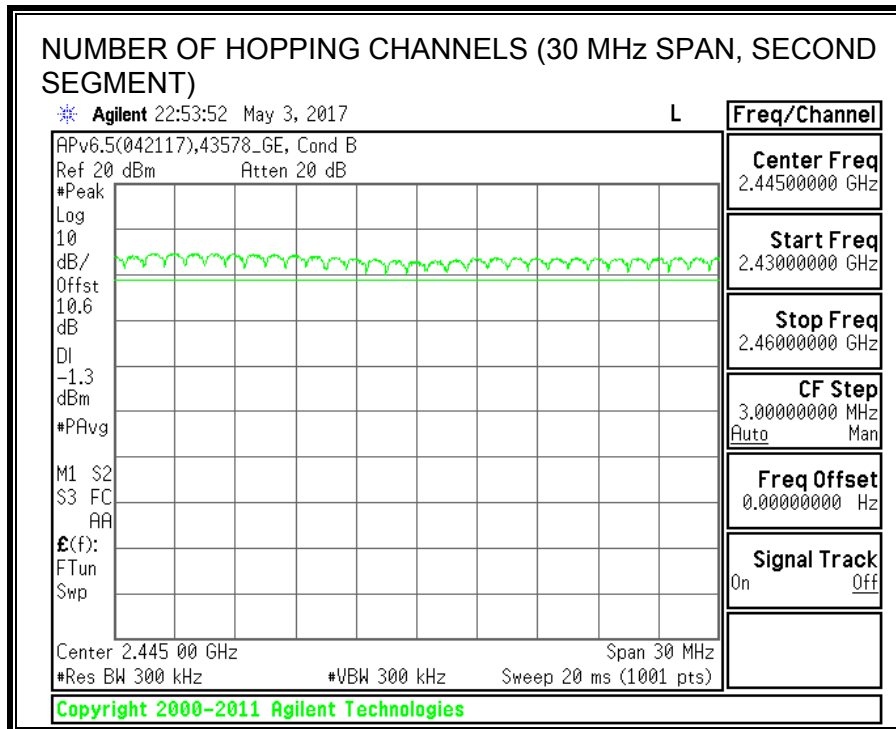
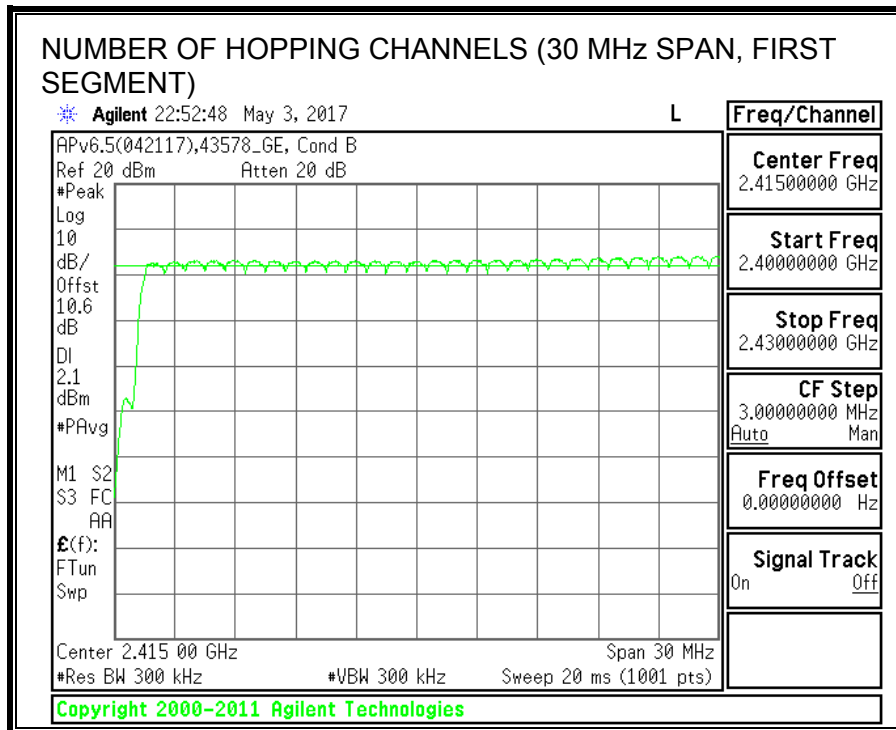

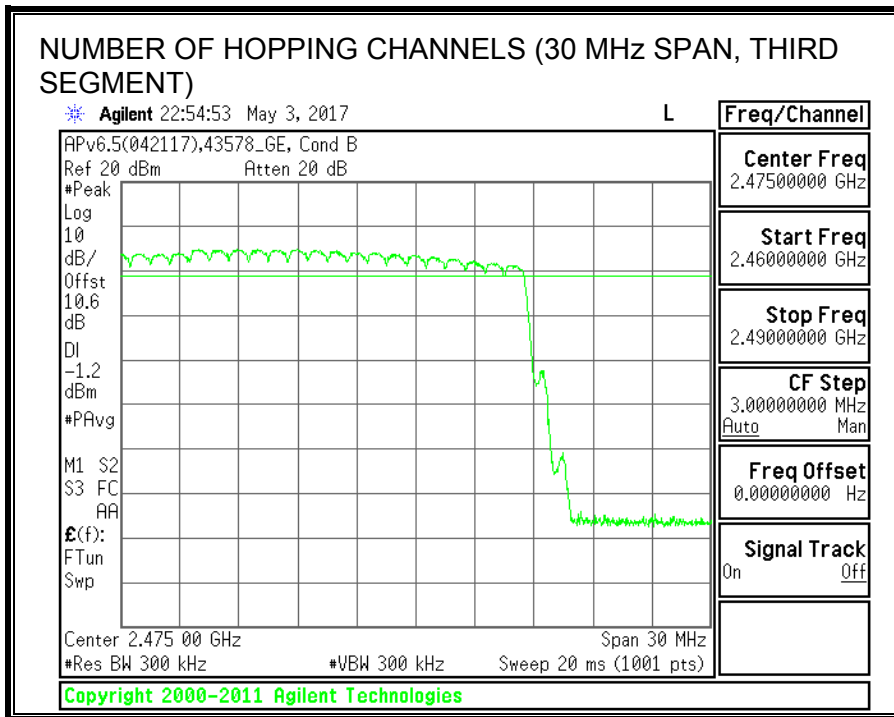

7.2.4. AVERAGE TIME OF OCCUPANCY

LIMITS

FCC §15.247 (a) (1) (iii)
 IC RSS-247 (5.1) (d)

The average time of occupancy on any channel shall not be greater than 0.4 seconds within a period of 0.4 seconds multiplied by the number of hopping channels employed.

TEST PROCEDURE

The transmitter output is connected to a spectrum analyzer. The span is set to 0 Hz, centered on a single, selected hopping channel. The width of a single pulse is measured in a fast scan. The number of pulses is measured in a 3.16 second scan, to enable resolution of each occurrence.

The average time of occupancy in the specified 31.6 second period (79 channels * 0.4 s) is equal to $10 * (\# \text{ of pulses in } 3.16 \text{ s}) * \text{ pulse width}$.

For AFH mode, the average time of occupancy in the specified 8 second period (20 channels * 0.4 seconds) is equal to $10 * (\# \text{ of pulses in } 0.8 \text{ s}) * \text{ pulse width}$.

RESULTS

AVERAGE TIME OF OCCUPANCY					
DH Packet	Pulse Width (msec)	Number of Pulses in 3.16 seconds	Average Time of Occupancy (sec)	Limit (sec)	Margin (sec)
8PSK Normal Mode					
DH1	0.390	32	0.1248	0.4	-0.2752
DH3	1.642	16	0.2627	0.4	-0.1373
DH5	2.893	14	0.4050	0.4	0.0050
DH Packet	Pulse Width (sec)	Number of Pulses in 0.8 seconds	Average Time of Occupancy (sec)	Limit (sec)	Margin (sec)
8PSK AFH Mode					
DH1	0.390	8	0.03120	0.4	-0.3688
DH3	1.642	4	0.06568	0.4	-0.3343
DH5	2.893	3.5	0.10126	0.4	-0.2987

NOTE: --

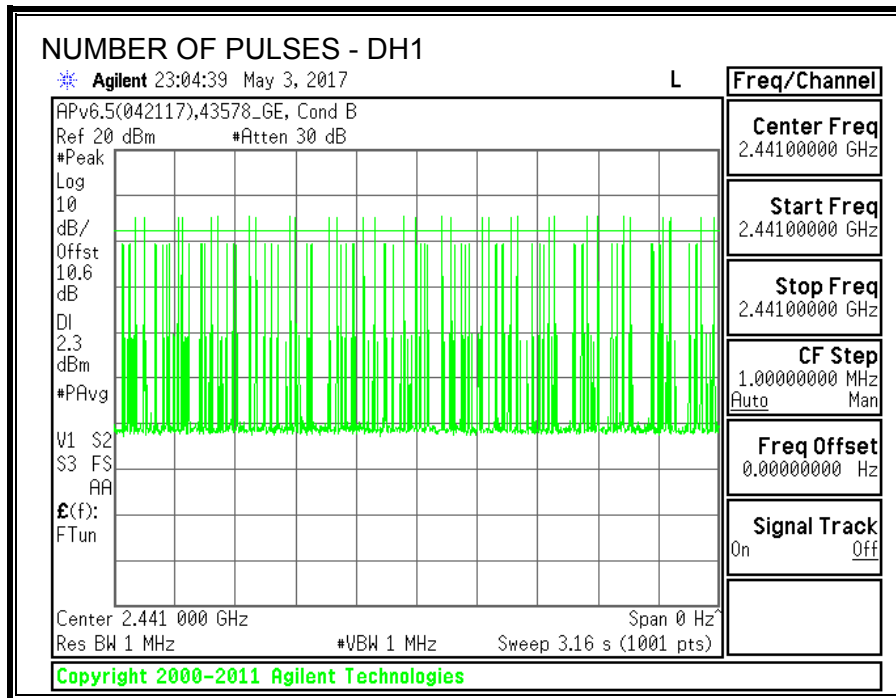
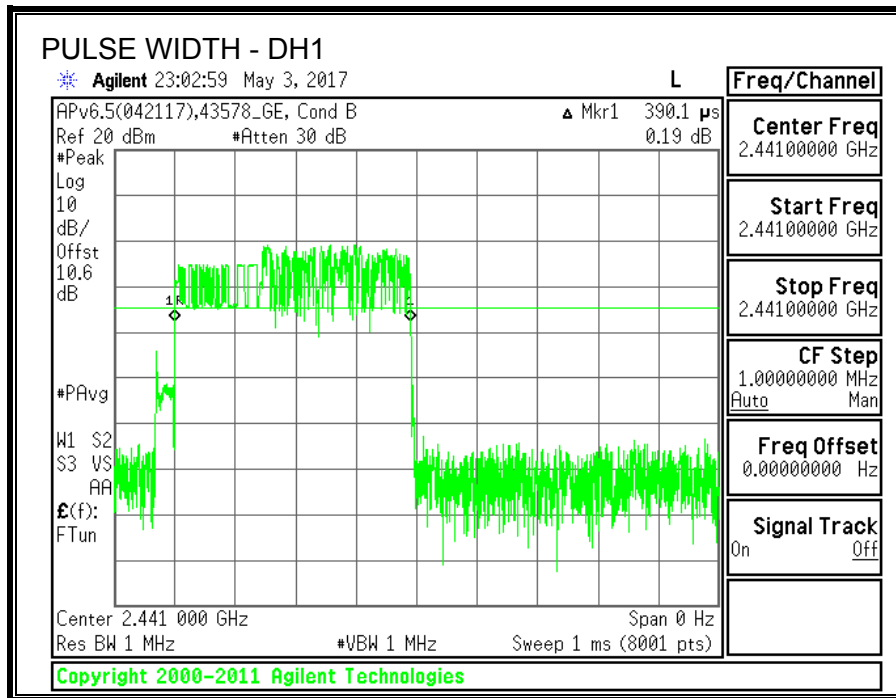

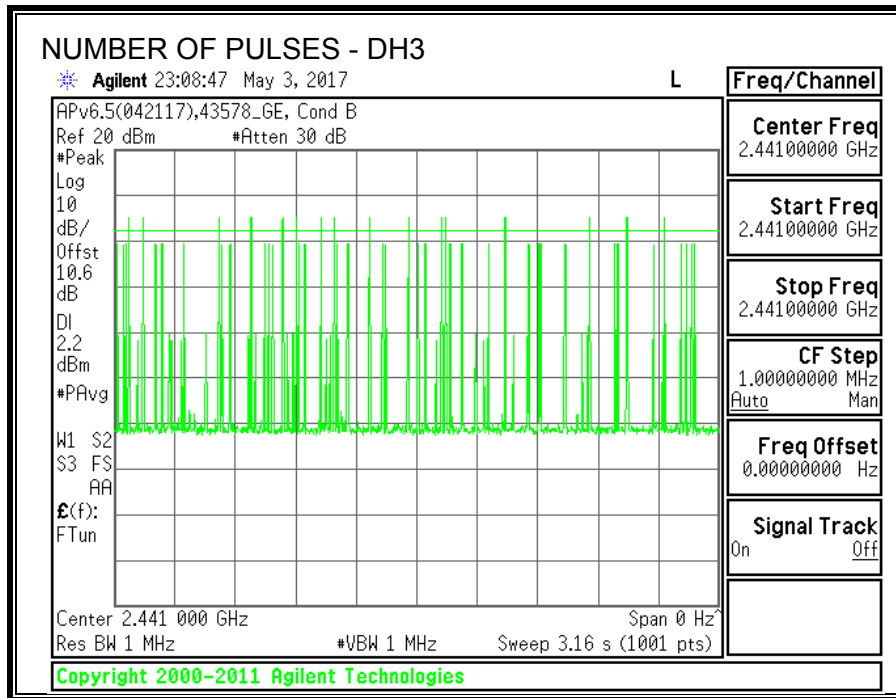
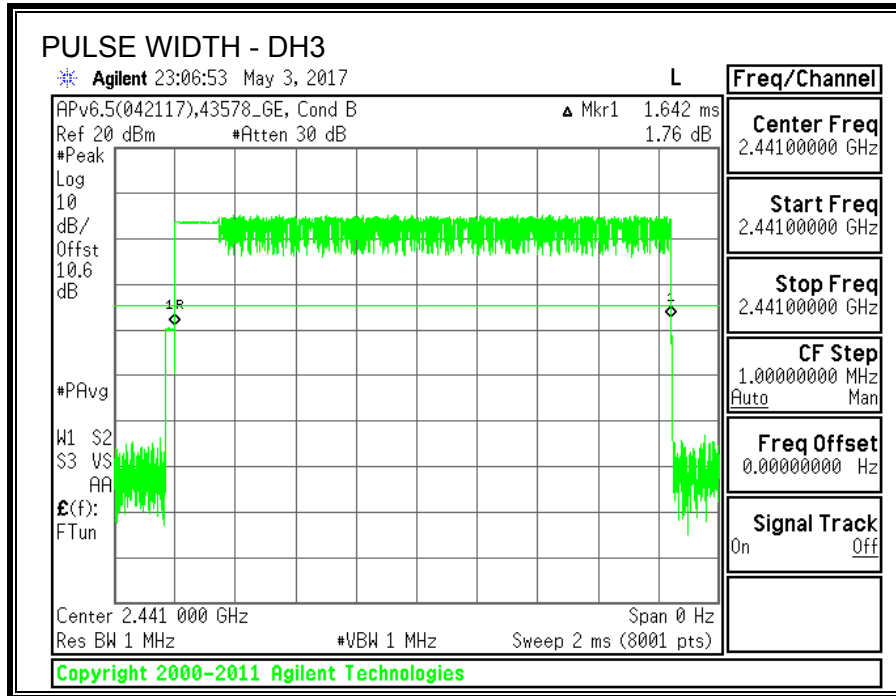

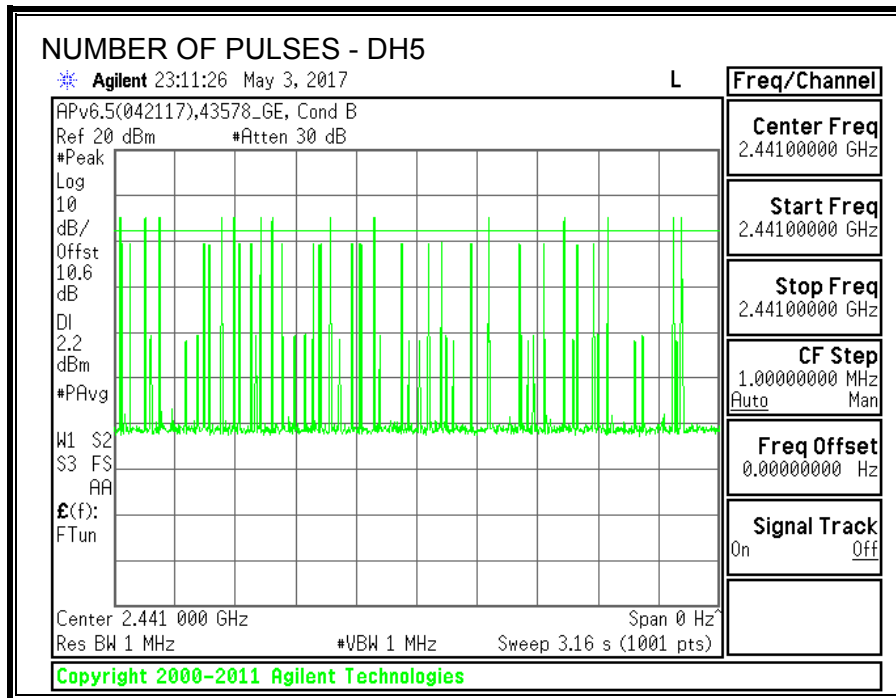
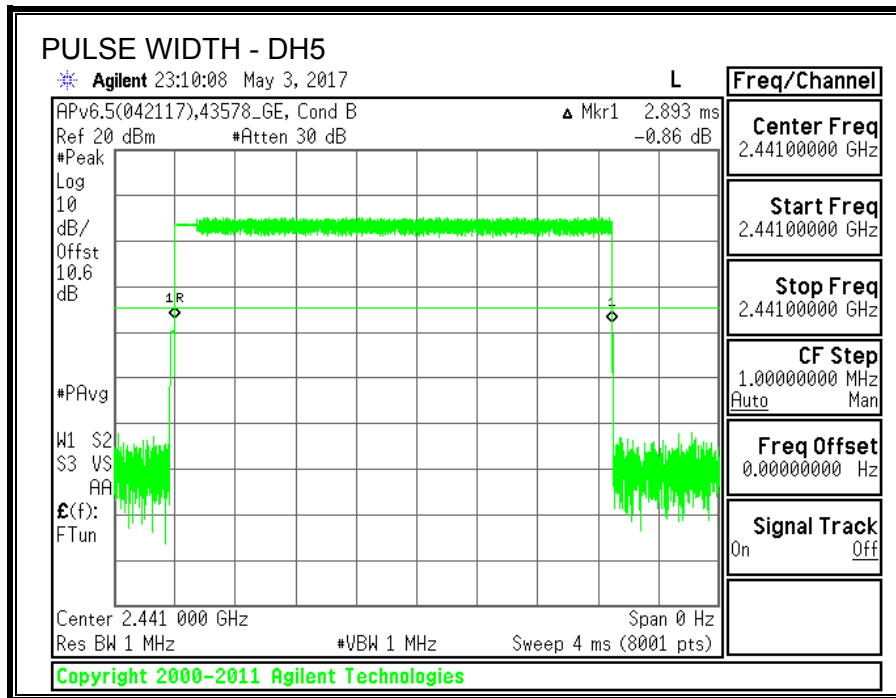

7.2.5. OUTPUT POWER

LIMITS

§15.247 (b) (1)
RSS-247 (5.4) (b)

The maximum antenna gain is less than 6 dBi, therefore the limit is 30 dBm.

TEST PROCEDURE

The transmitter output is connected to a spectrum analyzer.

RESULTS

TEST ENGINEER:	43578	Date:	5/3/2017
-----------------------	-------	--------------	----------

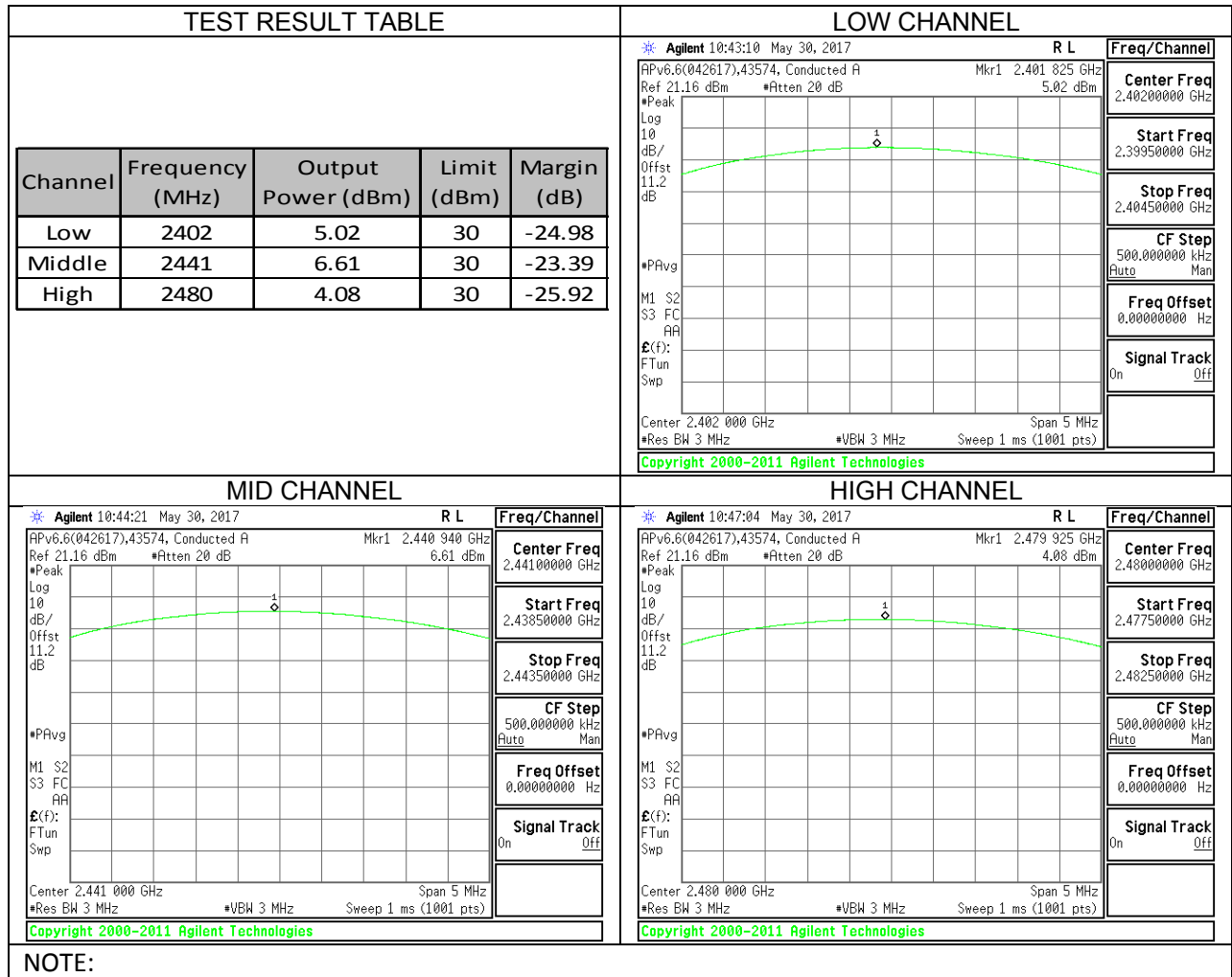

NOTE:

7.2.6. AVERAGE POWER

LIMITS

None; for reporting purposes only.

TEST PROCEDURE

The transmitter output is connected to a power meter.

RESULTS

The cable assembly insertion loss of 11 dB (including 10 dB pad and 0.6 dB cable) was entered as an offset in the power meter to allow for direct reading of power.

TEST ENGINEER:	43574	Date:	5/24/2017
-----------------------	-------	--------------	-----------

Channel	Frequency (MHz)	Average Power (dBm)
Low	2402	2.50
Middle	2441	3.70
High	2480	2.60

7.2.7. CONDUCTED BANDEDGE AND SPURIOUS EMISSIONS

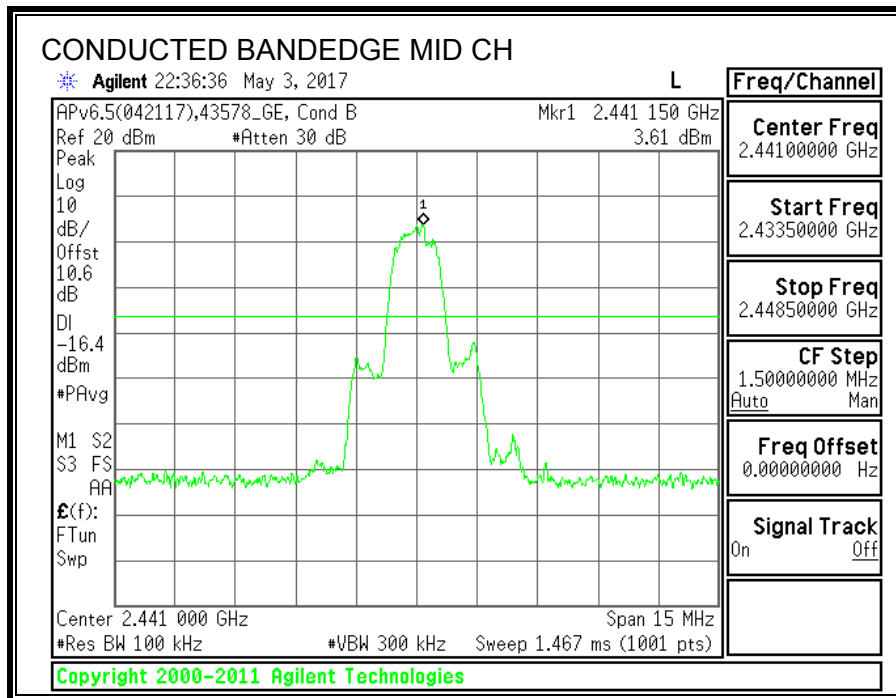
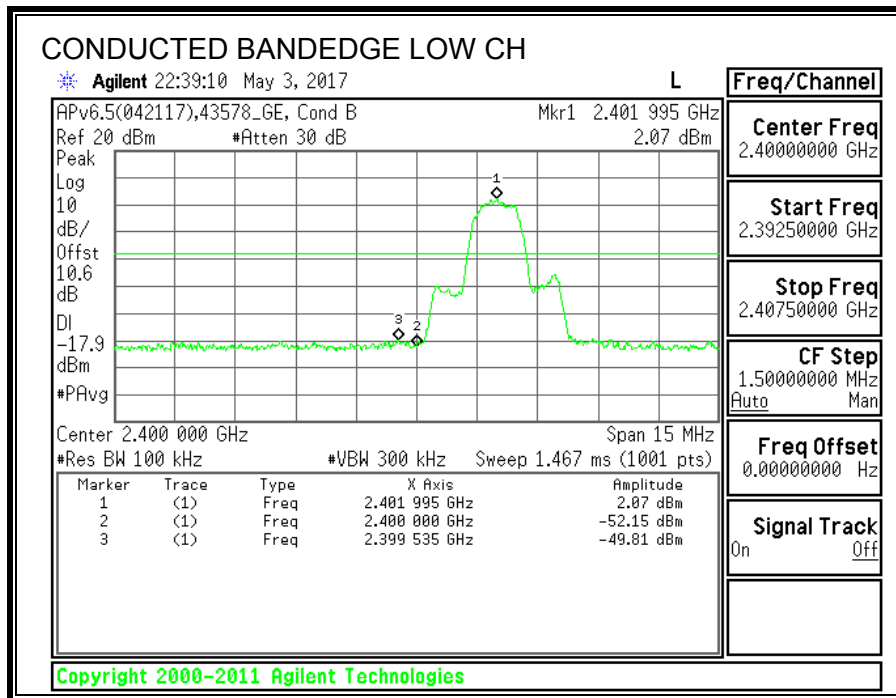

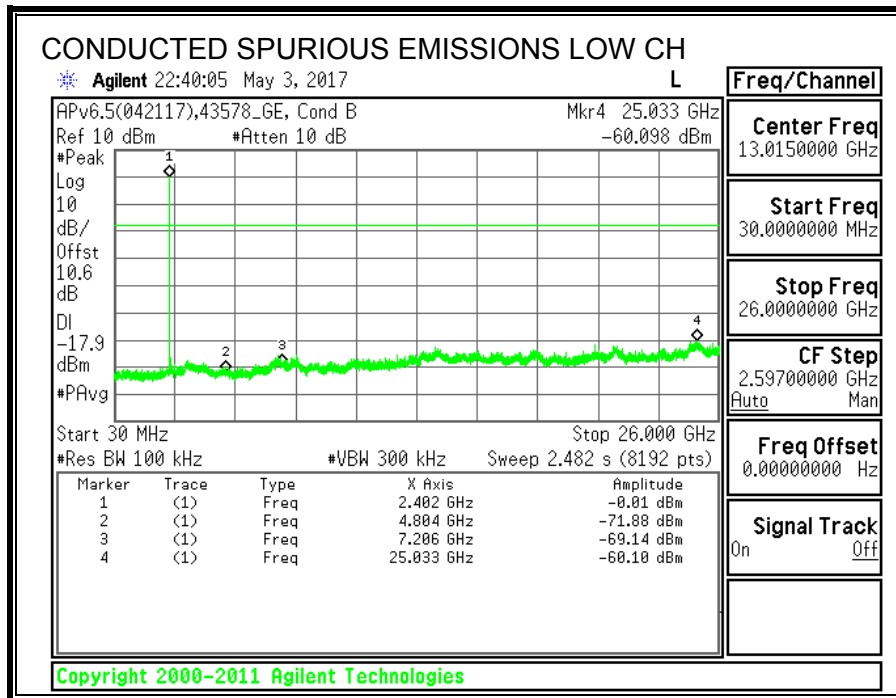
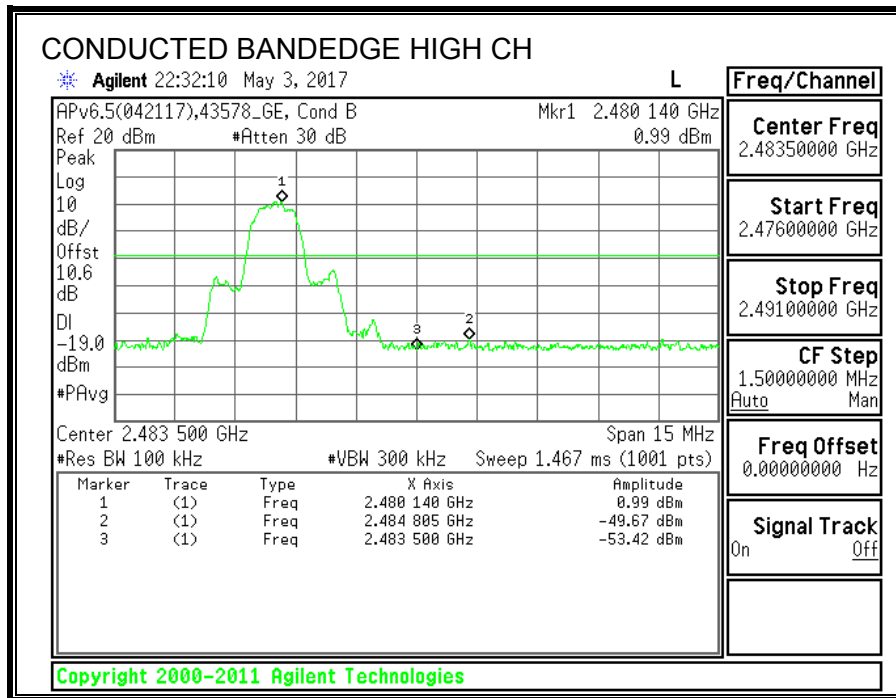

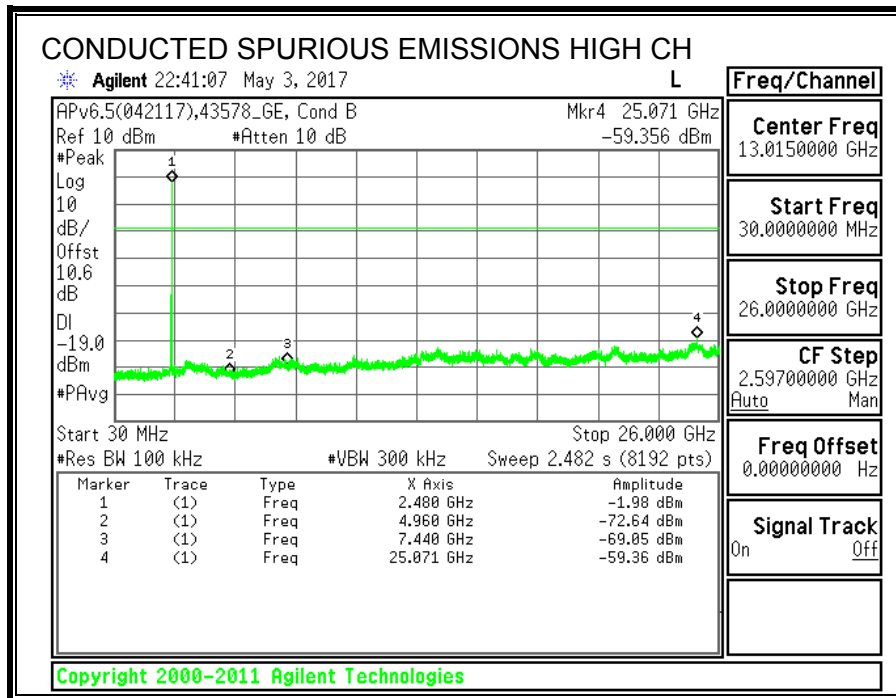
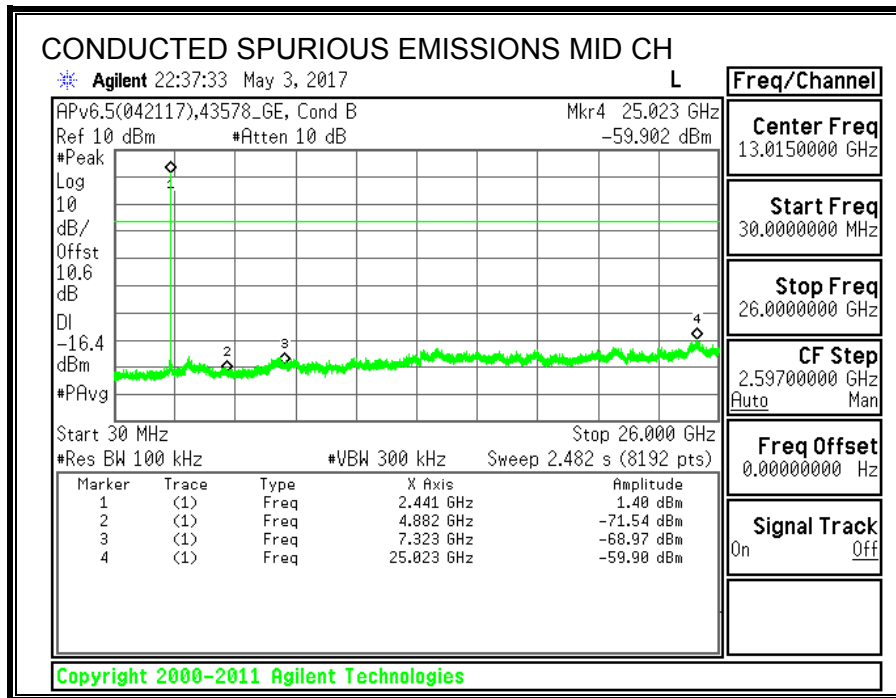

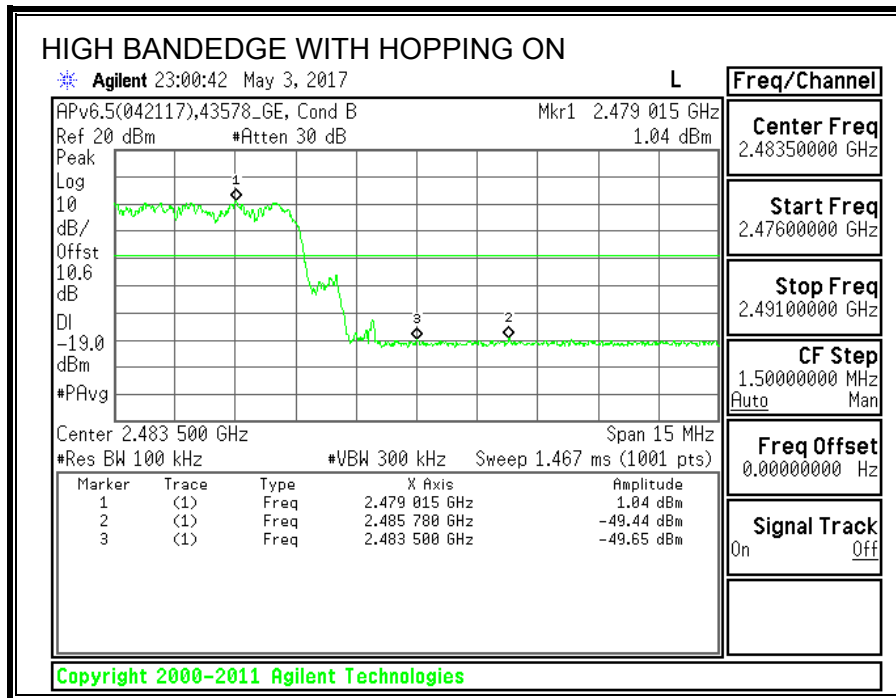
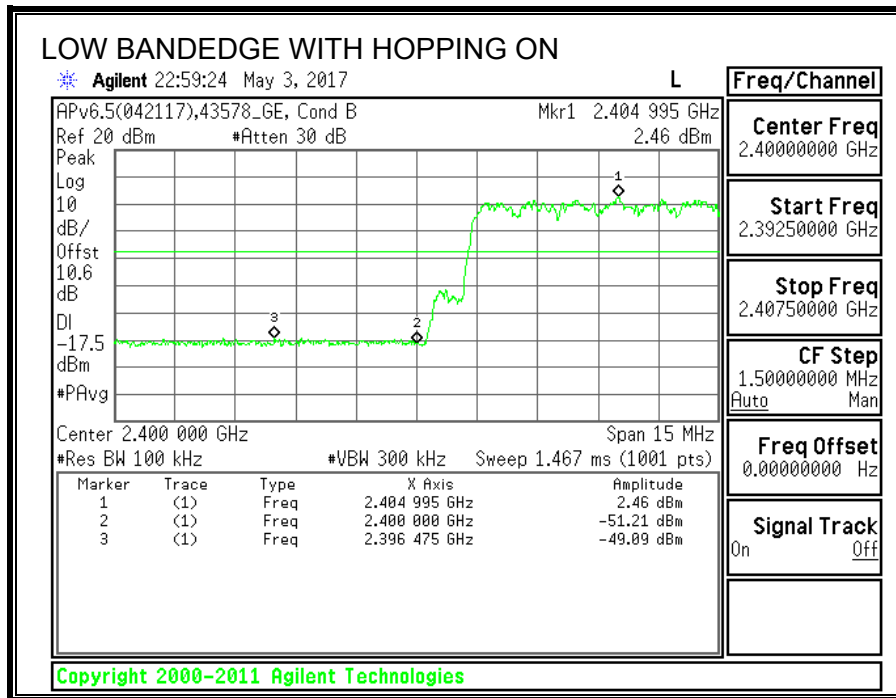

8. RADIATED TEST RESULTS

8.1. LIMITS AND PROCEDURE

LIMITS

FCC §15.205 and §15.209
IC RSS-GEN, Section 8.9 and 8.10.

Frequency Range (MHz)	Field Strength Limit (uV/m) at 3 m	Field Strength Limit (dBuV/m) at 3 m
0.009-0.490	2400/F(kHz) @ 300m	2400/F(kHz) @ 300m
0.490-1.705	24000/F(kHz) @ 30m	24000/F(kHz) @ 30m
1.705-30.0	30 @ 30m	30 @ 30m
30 - 88	100	40
88 - 216	150	43.5
216 - 960	200	46
Above 960	500	54

NOTE: KDB 414788 D01 OATS and Chamber Correlation Justification

- Based on FCC 15.31 (f) (2): measurements may be performed at a distance closer than that specified in the regulations; however, an attempt should be made to avoid making measurements in the near field.
- OATs and chamber correlation testing had been performed and chamber measured test result is the worst case test result.

TEST PROCEDURE

The EUT is placed on a non-conducting table 80 cm above the ground plane for measurement below 1GHz; 1.5 m above the ground plane for measurement above 1GHz. The antenna to EUT distance is 3 meters. The EUT is configured in accordance with ANSI C63.10. The EUT is set to transmit in a continuous mode.

For measurements below 1 GHz the resolution bandwidth is set to 120 kHz for peak detection measurements or 120 kHz for quasi-peak detection measurements for the 30-1000 MHz range, kHz for peak detection measurements or 9 kHz for quasi-peak detection measurements for the 0.15-30 MHz range and 200 Hz for peak detection measurements or 200 Hz for quasi-peak detection measurements for the 9 to 150 kHz range. Peak detection is used unless otherwise noted as quasi-peak.

For pre-scans above 1 GHz the resolution bandwidth is set to 1 MHz; the video bandwidth is set to 30 KHz for peak measurements.

For final measurements above 1 GHz the resolution bandwidth is set to 1 MHz; the video bandwidth is set to 3 MHz for peak measurements and as applicable for average measurements.

The spectrum from 1 GHz to 18 GHz is investigated with the transmitter set to the lowest, middle, and highest channels in each applicable band. Below 1GHz and above 18GHz emissions, the channel with the highest output power was tested.

The frequency range of interest is monitored at a fixed antenna height and EUT azimuth. The EUT is rotated through 360 degrees to maximize emissions received. The antenna is scanned from 1 to 4 meters above the ground plane to further maximize the emission. Measurements are made with the antenna polarized in both the vertical and the horizontal positions.

RESULTS

8.2. WORST-CASE BELOW 30 MHz

SPURIOUS EMISSIONS BELOW 30 MHz (WORST-CASE CONFIGURATION)

HORIZONTAL AND VERTICAL PLOTS

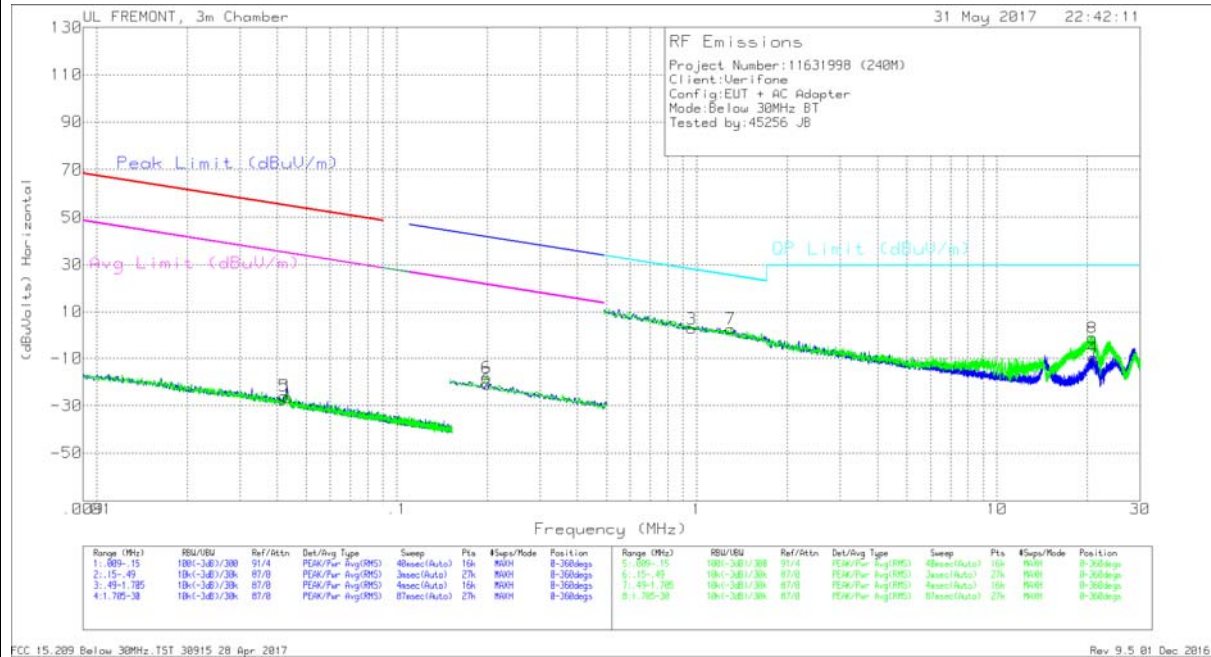

NOTE: KDB 414788 D01 OATS and Chamber Correlation Justification

- Based on FCC 15.31 (f) (2): measurements may be performed at a distance closer than that specified in the regulations; however, an attempt should be made to avoid making measurements in the near field.
- OATs and chamber correlation testing had been performed and chamber measured test result is the worst case test result.

Trace Markers

Marker	Frequency (MHz)	Meter Reading (dBuV)	Det	Loop Antenna (dB/m)	Cbl (dB)	Dist Corr 300m	Corrected Reading (dBuVolts)	Peak Limit (dBuV/m)	Margin (dB)	Avg Limit (dBuV/m)	Margin (dB)	QP Limit (dBuV/m)	Margin (dB)	QP Limit (dBuV/m)	Margin (dB)	Peak Limit (dBuV/m)	Margin (dB)	Avg Limit (dBuV/m)	Margin (dB)	Azimuth (Degs)
5	0.04218	39.53	Pk	13.2	1.4	-80	-25.87	55.08	-80.95	35.08	-60.95	-	-	-	-	-	-	-	-	0-360
1	0.0434	39.01	Pk	13	1.4	-80	-26.59	54.84	-81.43	34.84	-61.43	-	-	-	-	-	-	-	-	0-360
6	0.19921	48.79	Pk	11.6	1.5	-80	-18.11	-	-	-	-	-	-	-	-	41.63	-59.74	21.63	-39.74	0-360
2	0.19929	45.92	Pk	11.6	1.5	-80	-20.98	-	-	-	-	-	-	-	-	41.63	-62.61	21.63	-42.61	0-360

Pk - Peak detector

Marker	Frequency (MHz)	Meter Reading (dBuV)	Det	Loop Antenna (dB/m)	Cbl (dB)	Dist Corr 30m	Corrected Reading (dBuVolts)	Peak Limit (dBuV/m)	Margin (dB)	Avg Limit (dBuV/m)	Margin (dB)	QP Limit (dBuV/m)	Margin (dB)	QP Limit (dBuV/m)	Margin (dB)	Peak Limit (dBuV/m)	Margin (dB)	Avg Limit (dBuV/m)	Margin (dB)	Azimuth (Degs)
3	0.9604	29.76	Pk	11.5	1.5	-40	2.76	-	-	-	-	-	-	-	27.97	-25.21	-	-	-	0-360
7	1.29659	29.88	Pk	11.5	1.5	-40	2.88	-	-	-	-	-	-	-	25.37	-22.49	-	-	-	0-360
8	20.7776	27.52	Pk	9.6	1.7	-40	-1.18	-	-	-	-	-	-	-	29.5	-30.68	-	-	-	0-360
4	20.9693	19.2	Pk	9.5	1.7	-40	-9.6	-	-	-	-	-	-	-	29.5	-39.1	-	-	-	0-360

Pk - Peak detector

8.3. WORST-CASE BELOW 1 GHz

SPURIOUS EMISSIONS 30 TO 1000 MHz (WORST-CASE CONFIGURATION)

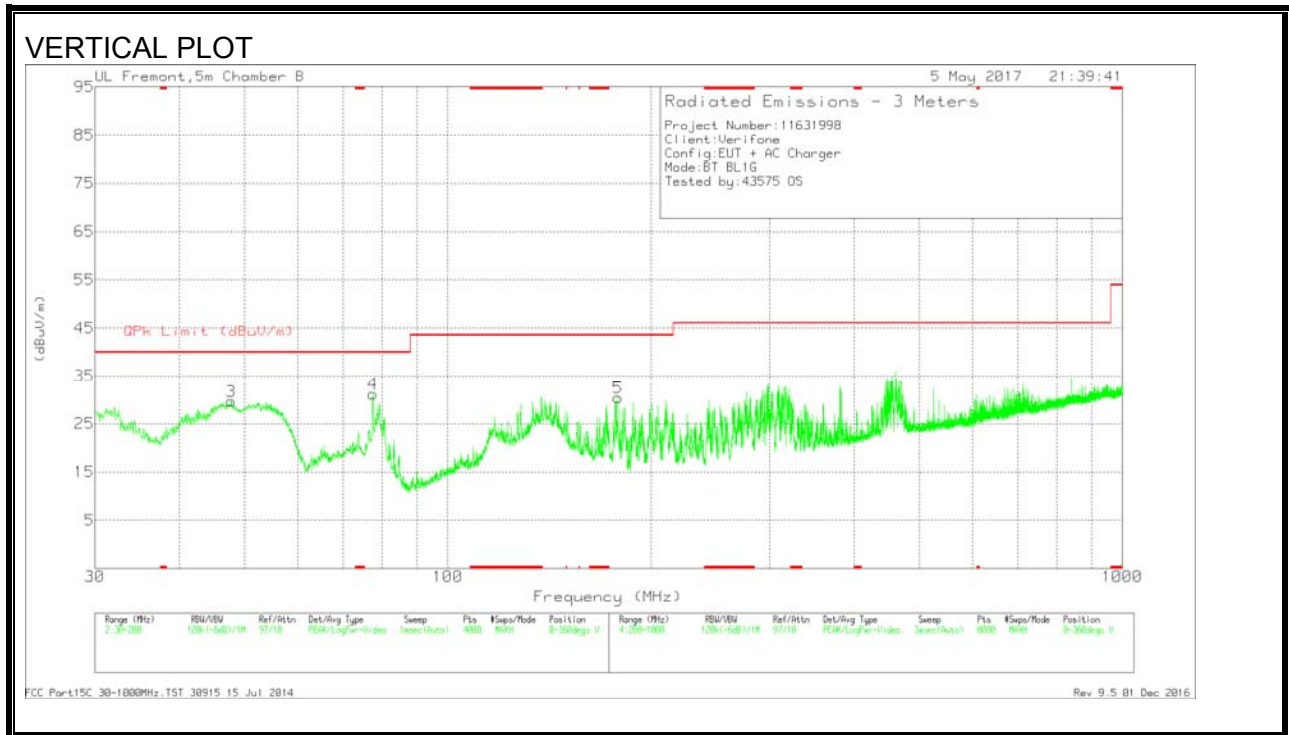
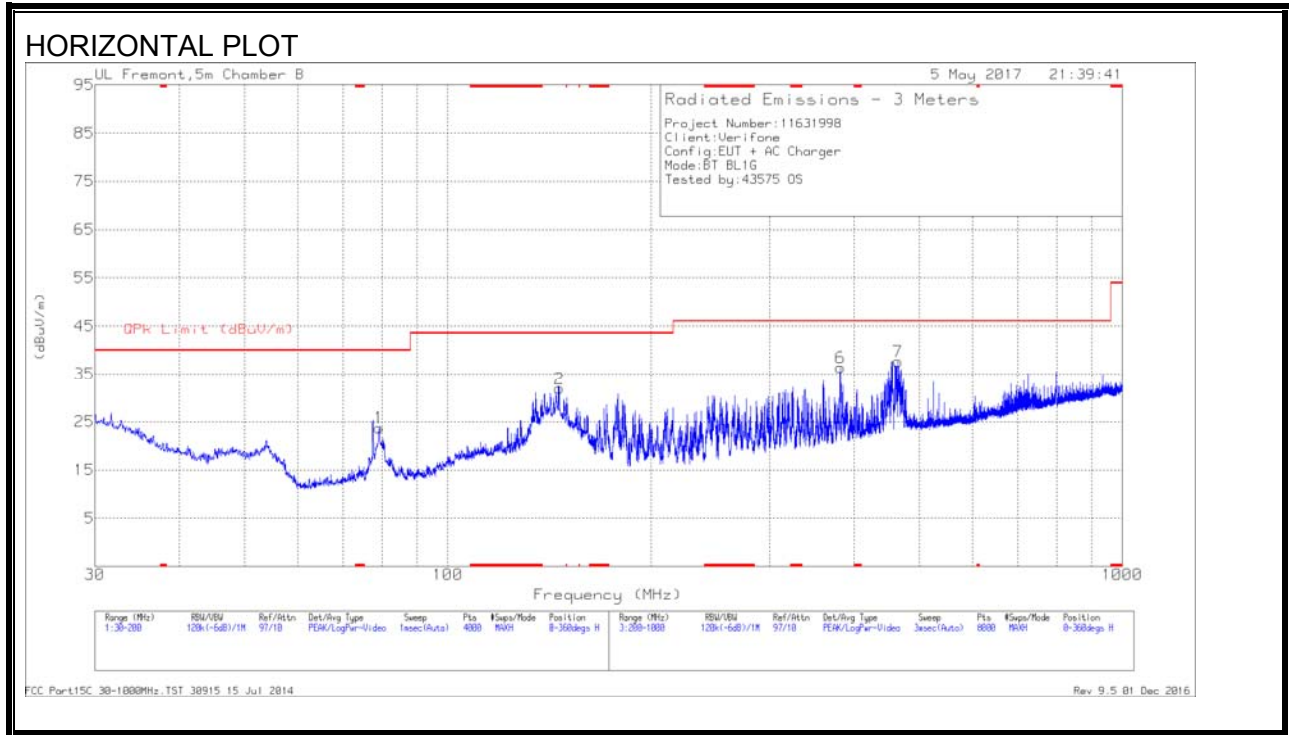

DATA

Marker	Frequency (MHz)	Meter Reading (dBuV)	Det	AF T477 (dB/m)	Amp/Cbl (dB)	Corrected Reading (dBuV/m)	QPk Limit (dBuV/m)	Margin (dB)	Azimuth (Degs)	Height (cm)	Polarity
3	47.7696	45.34	Pk	12.9	-28.6	29.64	40	-10.36	0-360	100	V
4	77.4423	47.75	Pk	11.7	-28.2	31.25	40	-8.75	0-360	100	V
1	79.1852	40.46	Pk	11.5	-28.2	23.76	40	-16.24	0-360	400	H
2	146.3101	42.78	Pk	16.6	-27.4	31.98	43.52	-11.54	0-360	200	H
5	178.831	42.27	Pk	15.2	-27	30.47	43.52	-13.05	0-360	100	V
6	382.5237	43.44	Pk	19	-26	36.44	46.02	-9.58	0-360	100	H
7	464.6344	42.59	Pk	21.1	-26	37.69	46.02	-8.33	0-360	200	H

Pk - Peak detector

8.4. TRANSMITTER ABOVE 1 GHz

8.4.1. BASIC DATA RATE GFSK MODULATION

BANDEDGE (LOW CHANNEL)

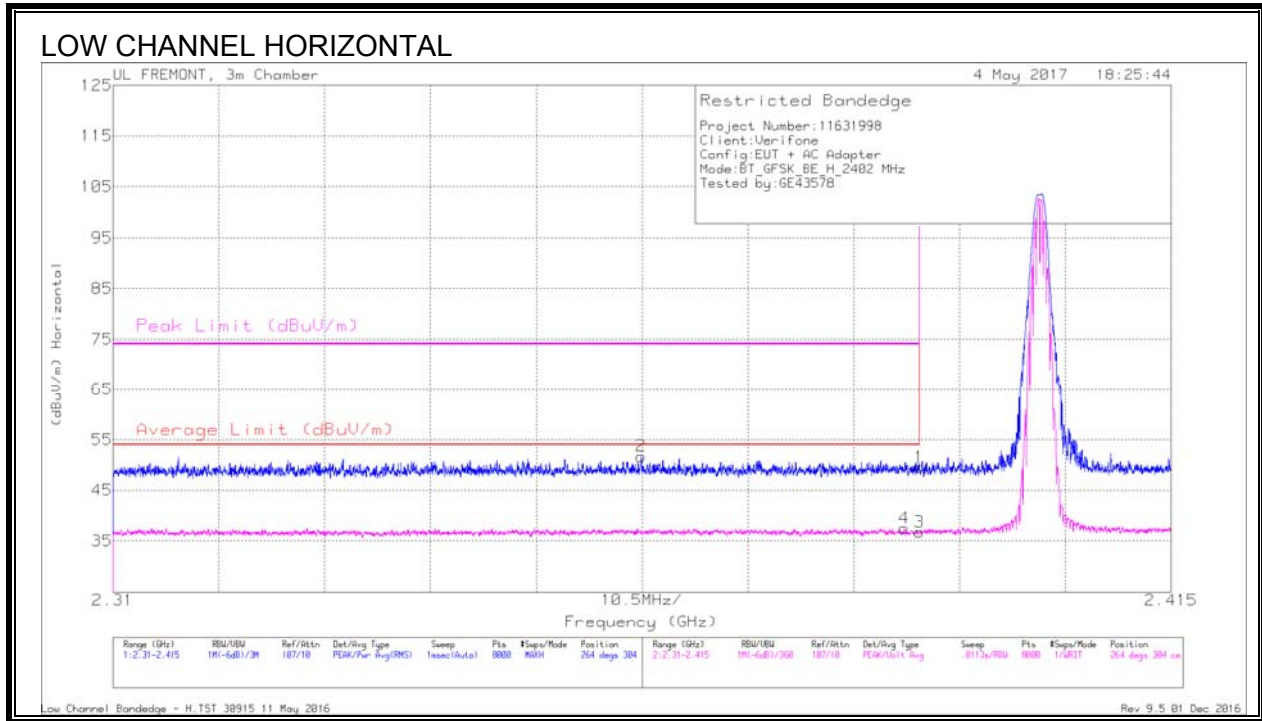

Marker	Frequency (GHz)	Meter Reading (dBuV)	Det	AF T712 (dB/m)	Amp/Cb1/Fitr/ Pad (dB)	Ant Gain (dBi)	Corrected Reading (dBuV/m)	Average Limit (dBuV/m)	Margin (dB)	Peak Limit (dBuV/m)	PK Margin (dB)	Azimuth (Degs)	Height (cm)	Polarity
2	2.362	40.62	Pk	31.9	-20.8	0	51.72	-	-	74	-22.28	264	304	H
4	2.389	26.39	VA1T	31.9	-20.8	0	37.49	54	-16.51	-	-	264	304	H
1	2.39	38.43	Pk	31.9	-20.8	0	49.53	-	-	74	-24.47	264	304	H
3	2.39	25.62	VA1T	31.9	-20.8	0	36.72	54	-17.28	-	-	264	304	H

* - indicates frequency in CFR15.205/RSS-GEN 8.10 -Restricted Band

Pk - Peak detector

VA1T - FHSS: Linear Voltage Average $V_B=1/T_{on}$ where: T_{on} is transmit duration

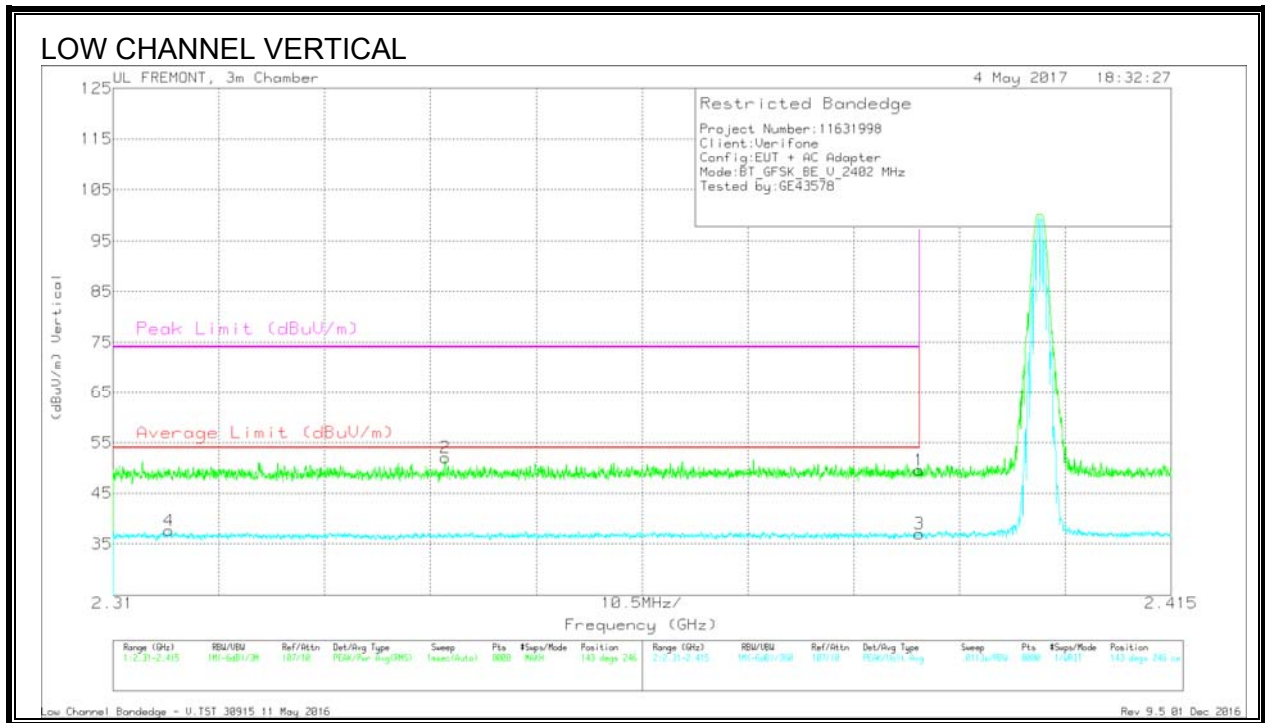

Marker	Frequency (GHz)	Meter Reading (dBuV)	Det	AF T712 (dB/m)	Amp/Cb/Filtr/Pad (dB)	Corrected Reading (dBuV/m)	Average Limit (dBuV/m)	Margin (dB)	Peak Limit (dBuV/m)	PK Margin (dB)	Azimuth (Degs)	Height (cm)	Polarity
4	2.316	26.68	VA1T	31.8	-20.9	37.58	54	-16.42	-	-	143	246	V
2	2.343	41.09	Pk	31.8	-20.9	51.99	-	-	74	-22.01	143	246	V
1	2.39	38.47	Pk	31.9	-20.8	49.57	-	-	74	-24.43	143	246	V
3	2.39	25.9	VA1T	31.9	-20.8	37	54	-17	-	-	143	246	V

* - indicates frequency in CFR15.205/RSS-GEN 8.10 -Restricted Band

Pk - Peak detector

VA1T - FHSS: Linear Voltage Average $V_B=1/T_{on}$ where: T_{on} is transmit duration

BANDEDGE (HIGH CHANNEL)

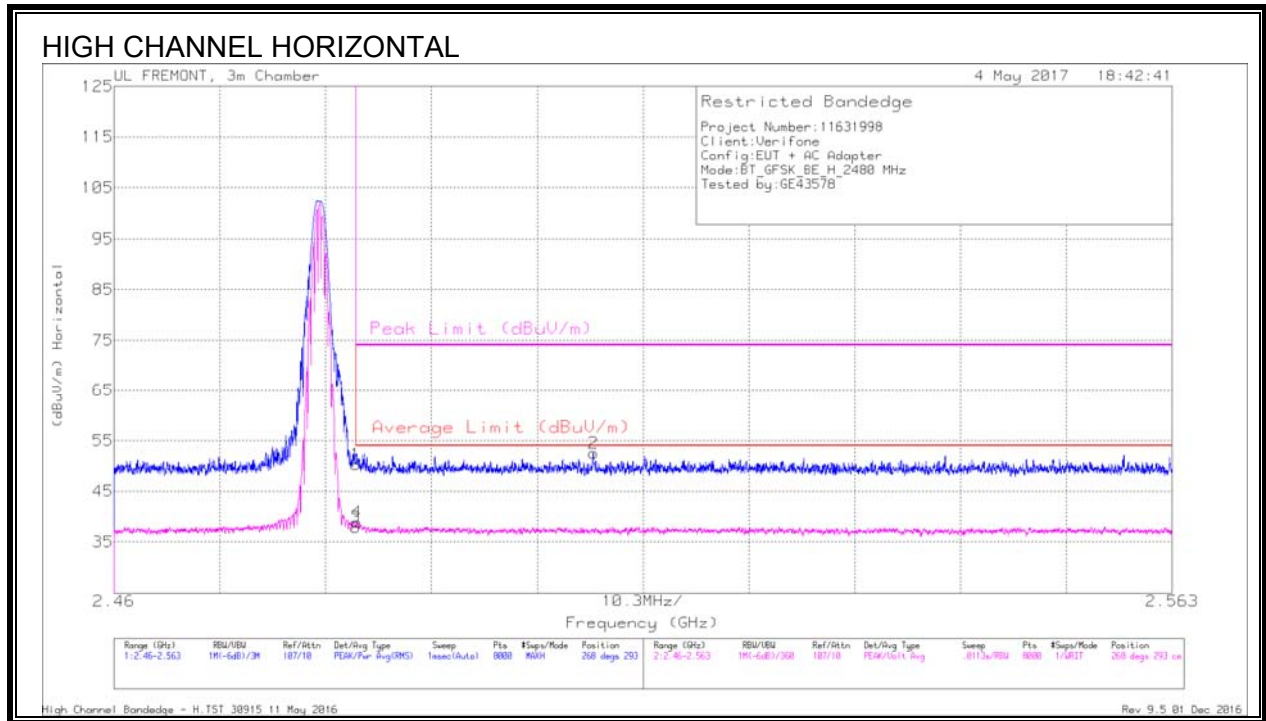

Marker	Frequency (GHz)	Meter Reading (dBuV)	Det	AF T712 (dB/m)	Amp/Cb/Filtr/ Pad (dB)	Corrected Reading (dBuV/m)	Average Limit (dBuV/m)	Margin (dB)	Peak Limit (dBuV/m)	PK Margin (dB)	Azimuth (Degs)	Height (cm)	Polarity
1	2.484	38.73	Pk	32.4	-20.8	50.33	-	-	74	-23.67	268	293	H
3	2.484	26.31	VA1T	32.4	-20.8	37.91	54	-16.09	-	-	268	293	H
4	2.484	27.29	VA1T	32.4	-20.8	38.89	54	-15.11	-	-	268	293	H
2	2.507	40.87	Pk	32.5	-20.8	52.57	-	-	74	-21.43	268	293	H

* - indicates frequency in CFR15.205/RSS-GEN 8.10 -Restricted Band

Pk - Peak detector

VA1T - FHSS: Linear Voltage Average VB=1/Ton where: Ton is transmit duration

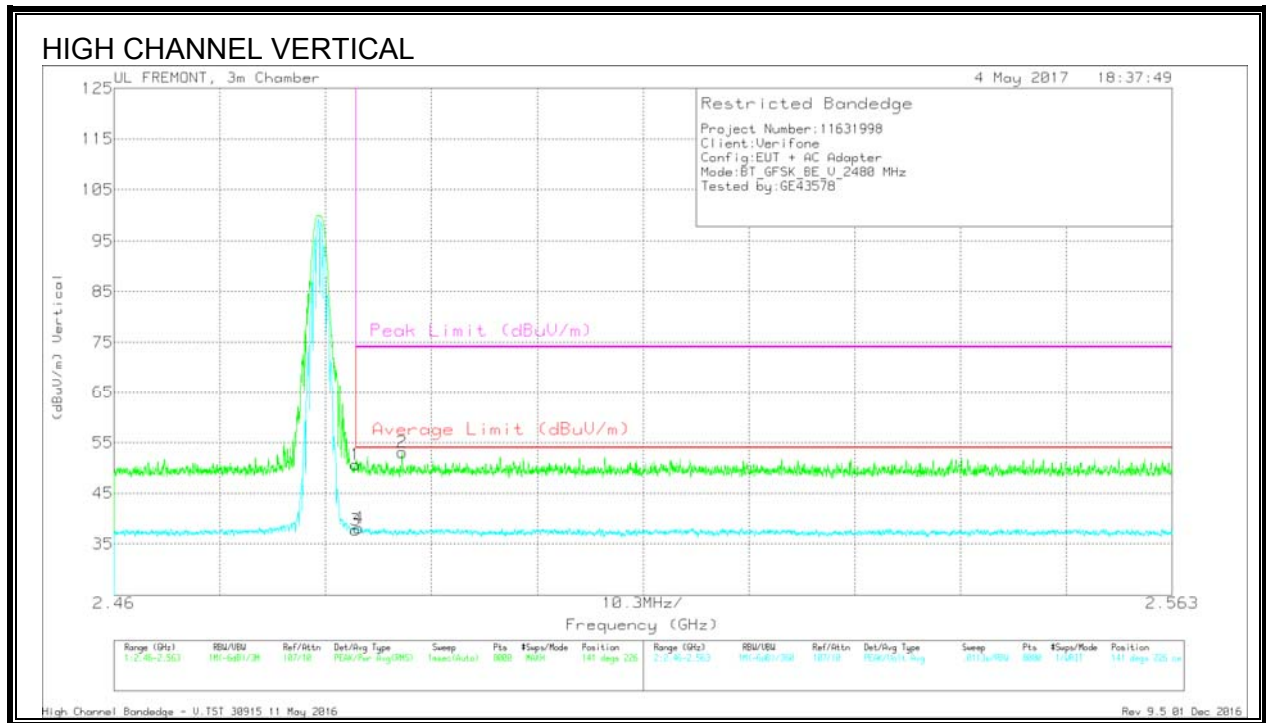

Marker	Frequency (GHz)	Meter Reading (dBuV)	Det	AF T712 (dB/m)	Amp/Cbl/Filtr/Pad (dB)	Corrected Reading (dBuV/m)	Average Limit (dBuV/m)	Margin (dB)	Peak Limit (dBuV/m)	PK Margin (dB)	Azimuth (Degs)	Height (cm)	Polarity
1	2.484	39.06	Pk	32.4	-20.8	50.66	-	-	74	-23.34	141	226	V
3	2.484	26.2	VA1T	32.4	-20.8	37.8	54	-16.2	-	-	141	226	V
4	2.484	26.56	VA1T	32.4	-20.8	38.16	54	-15.84	-	-	141	226	V
2	2.488	41.59	Pk	32.4	-20.9	53.09	-	-	74	-20.91	141	226	V

* - indicates frequency in CFR15.205/RSS-GEN 8.10 -Restricted Band

Pk - Peak detector

VA1T - FHSS: Linear Voltage Average VB=1/Ton where: Ton is transmit duration

HARMONICS AND SPURIOUS EMISSIONS

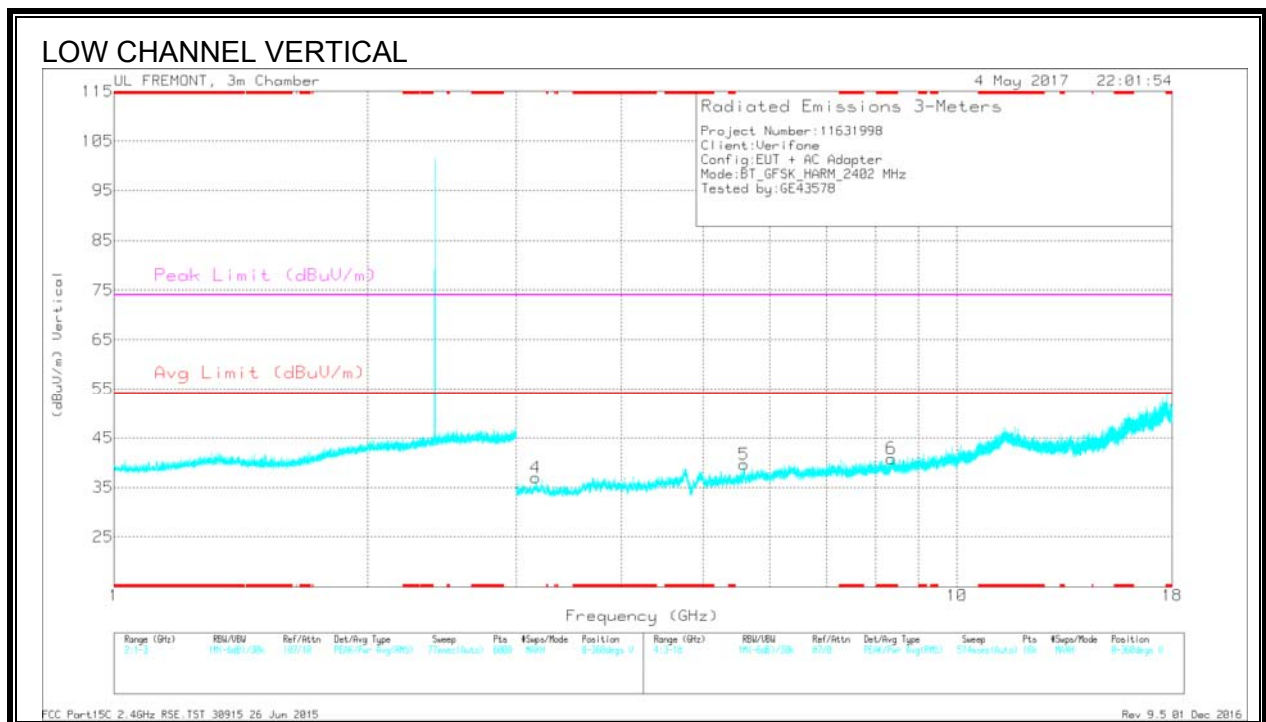
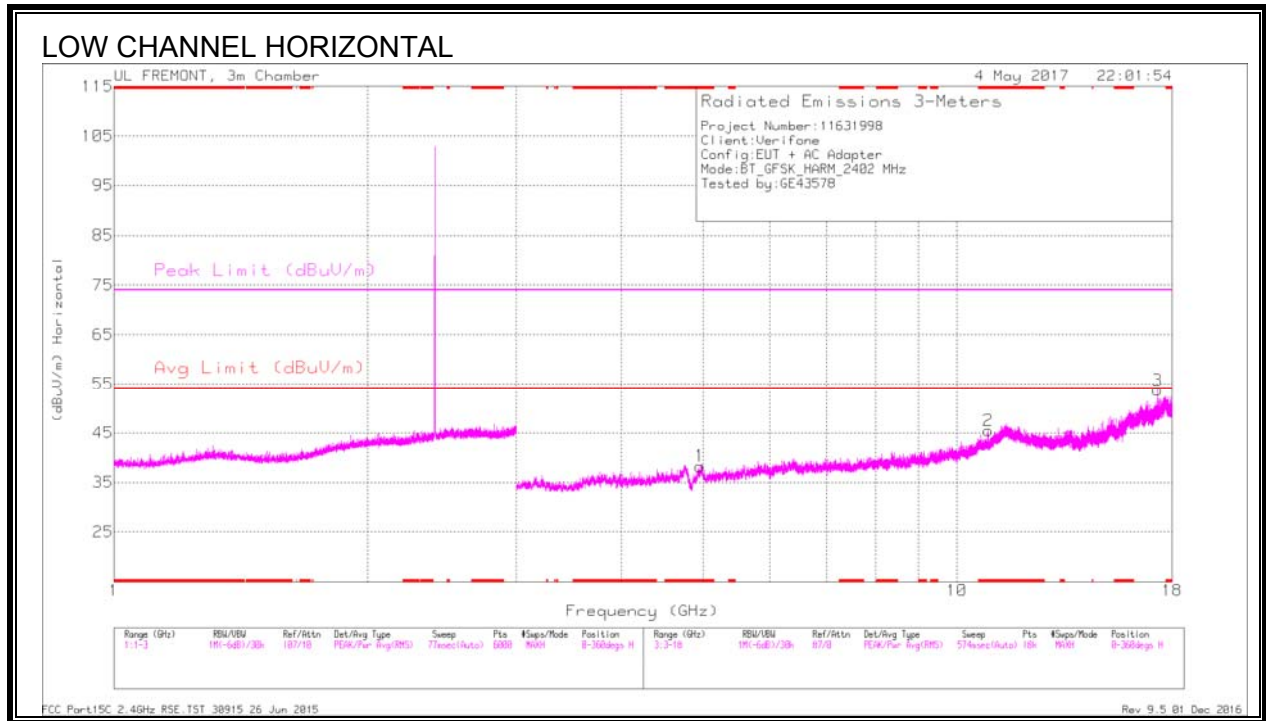

Frequency (GHz)	Meter Reading (dBuV)	Det	AF T712 (dB/m)	Amp/Cbl/Filtr/ Pad (dB)	Corrected Reading (dBuV/m)	Avg Limit (dBuV/m)	Margin (dB)	Peak Limit (dBuV/m)	PK Margin (dB)	Azimuth (Degs)	Height (cm)	Polarity
* 4.958	37.93	PKFH	34.1	-28.6	43.43	-	-	74	-30.57	10	200	H
* 4.96	26.29	VA1T	34.1	-28.5	31.89	54	-22.11	-	-	10	200	H
* 10.891	29.07	PKFH	37.8	-18.8	48.07	-	-	74	-25.93	66	100	H
* 10.89	16.57	VA1T	37.8	-18.9	35.47	54	-18.53	-	-	66	100	H
* 8.36	34.17	PKFH	35.8	-23.7	46.27	-	-	74	-27.73	226	249	V
* 8.361	21.22	VA1T	35.8	-23.7	33.32	54	-20.68	-	-	226	249	V
3.165	25.68	VA1T	33.3	-29.3	29.68	-	-	-	-	150	100	V
3.166	36.84	PKFH	33.3	-29.3	40.84	-	-	-	-	150	100	V
5.589	24.38	VA1T	34.6	-27.3	31.68	-	-	-	-	211	100	V
5.592	36.41	PKFH	34.6	-27.3	43.71	-	-	-	-	211	100	V
17.293	26.17	PKFH	41.2	-12.7	54.67	-	-	-	-	300	100	H
17.294	8.49	VA1T	41.2	-12.7	36.99	-	-	-	-	300	100	H

* - indicates frequency in CFR15.205/RSS-GEN 8.10 -Restricted Band
 PKFH - FHSS: RB=100k/1MHz VB=3 x RB, Peak
 VA1T - FHSS: Linear Voltage Average VB=1/Ton where: Ton is transmit duration

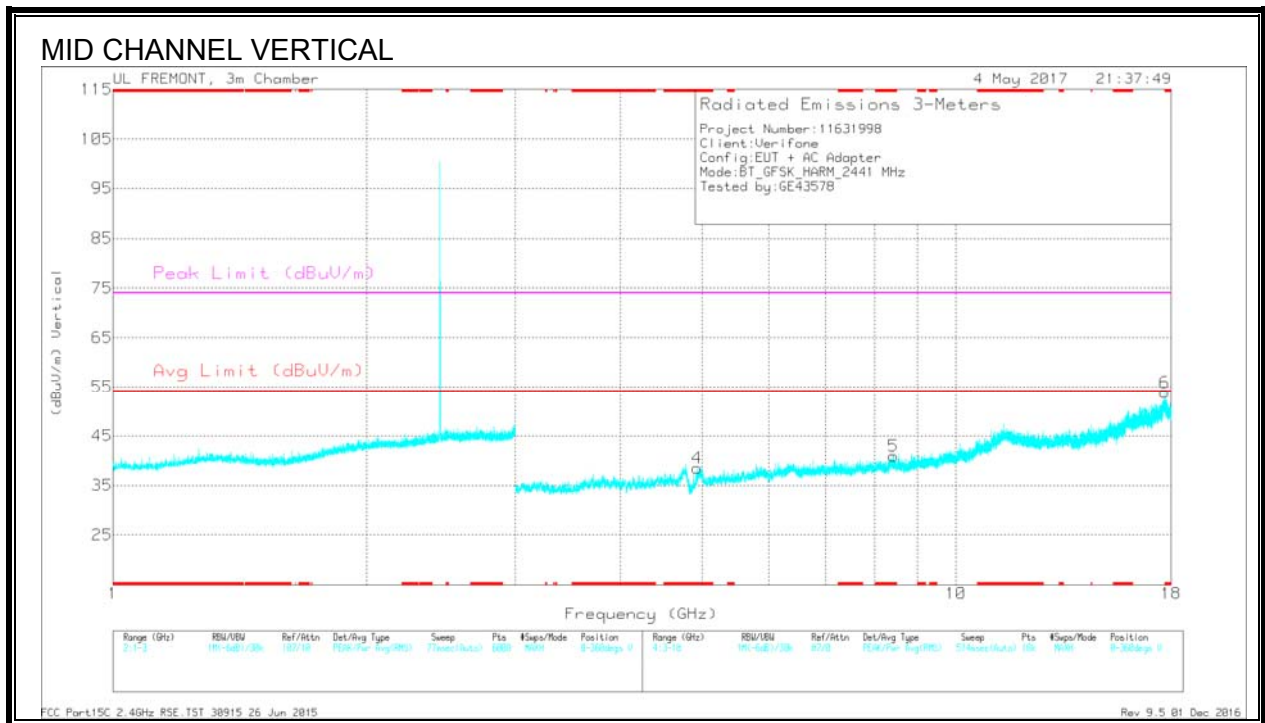
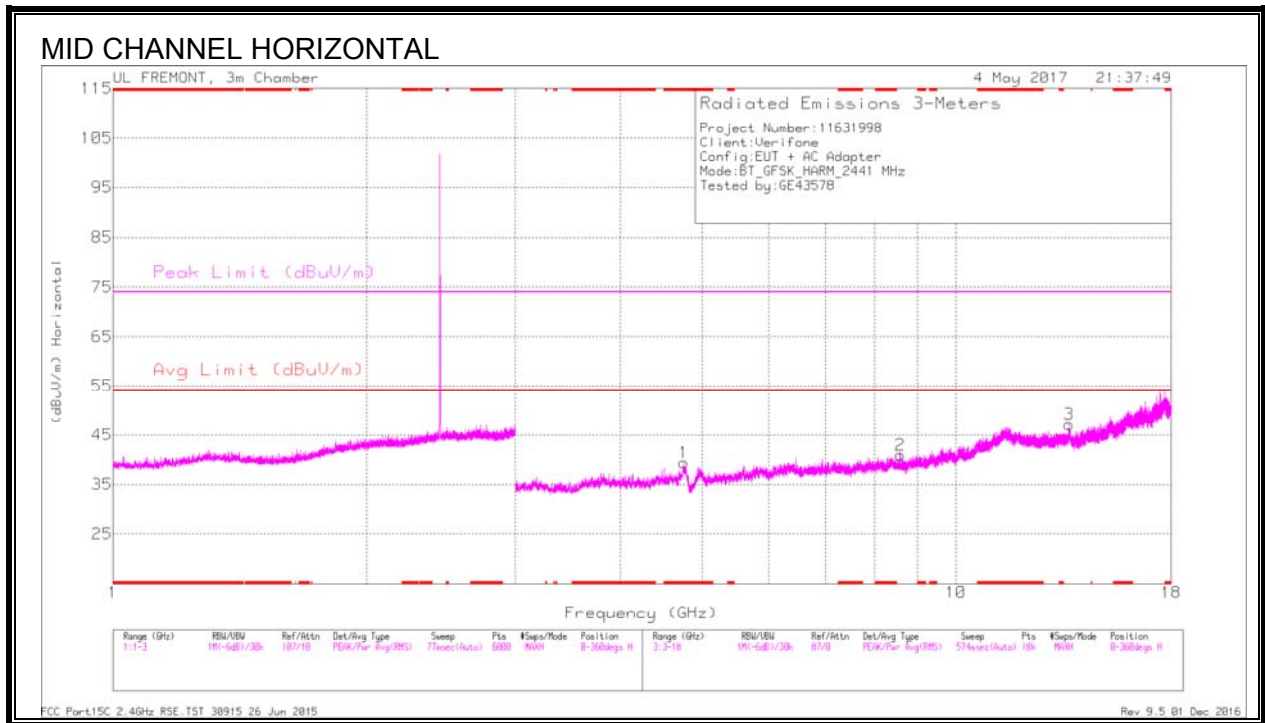

Frequency (GHz)	Meter Reading (dBuV)	Det	AF T712 (dB/m)	Amp/Cbl/Filtr/ Pad (dB)	Corrected Reading (dBuV/m)	Avg Limit (dBuV/m)	Margin (dB)	Peak Limit (dBuV/m)	PK Margin (dB)	Azimuth (Degs)	Height (cm)	Polarity
* 4.754	39.03	PKFH	34	-28.4	44.63	-	-	74	-29.37	82	100	H
* 4.752	27.13	VA1T	34	-28.4	32.73	54	-21.27	-	-	82	100	H
* 4.935	37.21	PKFH	34.1	-28.3	43.01	-	-	74	-30.99	354	200	V
* 4.932	24.84	VA1T	34.1	-28.2	30.74	54	-23.26	-	-	354	200	V
* 8.425	32.14	PKFH	35.8	-23.1	44.84	-	-	74	-29.16	97	200	V
* 8.423	20.12	VA1T	35.8	-23.1	32.82	54	-21.18	-	-	97	200	V
8.594	20.06	VA1T	35.9	-23.6	32.36	-	-	-	-	336	200	H
8.597	32.4	PKFH	35.9	-23.5	44.8	-	-	-	-	336	200	H
13.625	16.1	VA1T	38.7	-17.9	36.9	-	-	-	-	156	200	H
13.626	29.6	PKFH	38.7	-17.9	50.4	-	-	-	-	156	200	H
17.683	26.12	PKFH	41.4	-11.1	56.42	-	-	-	-	19	100	V
17.686	9.29	VA1T	41.4	-11.1	39.59	-	-	-	-	19	100	V

* - indicates frequency in CFR15.205/RSS-GEN 8.10 -Restricted Band
 PKFH - FHSS: RB=100k/1MHz VB=3 x RB, Peak
 VA1T - FHSS: Linear Voltage Average VB=1/Ton where: Ton is transmit duration

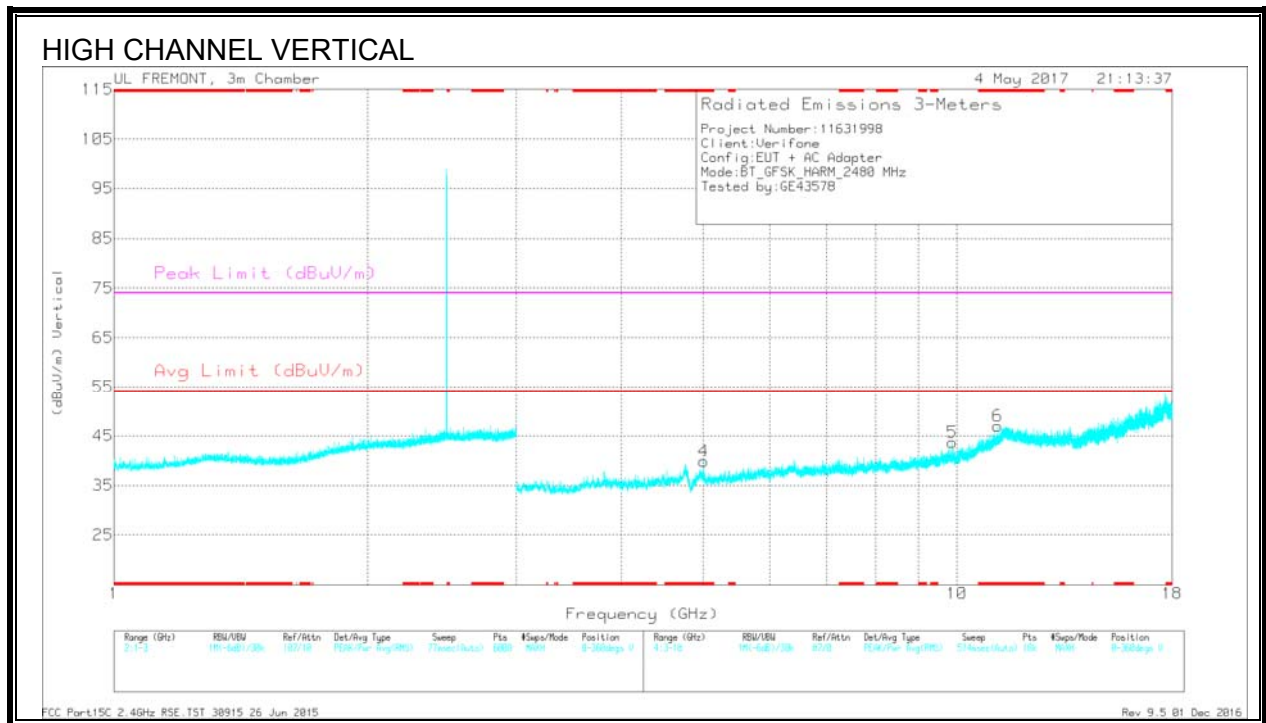
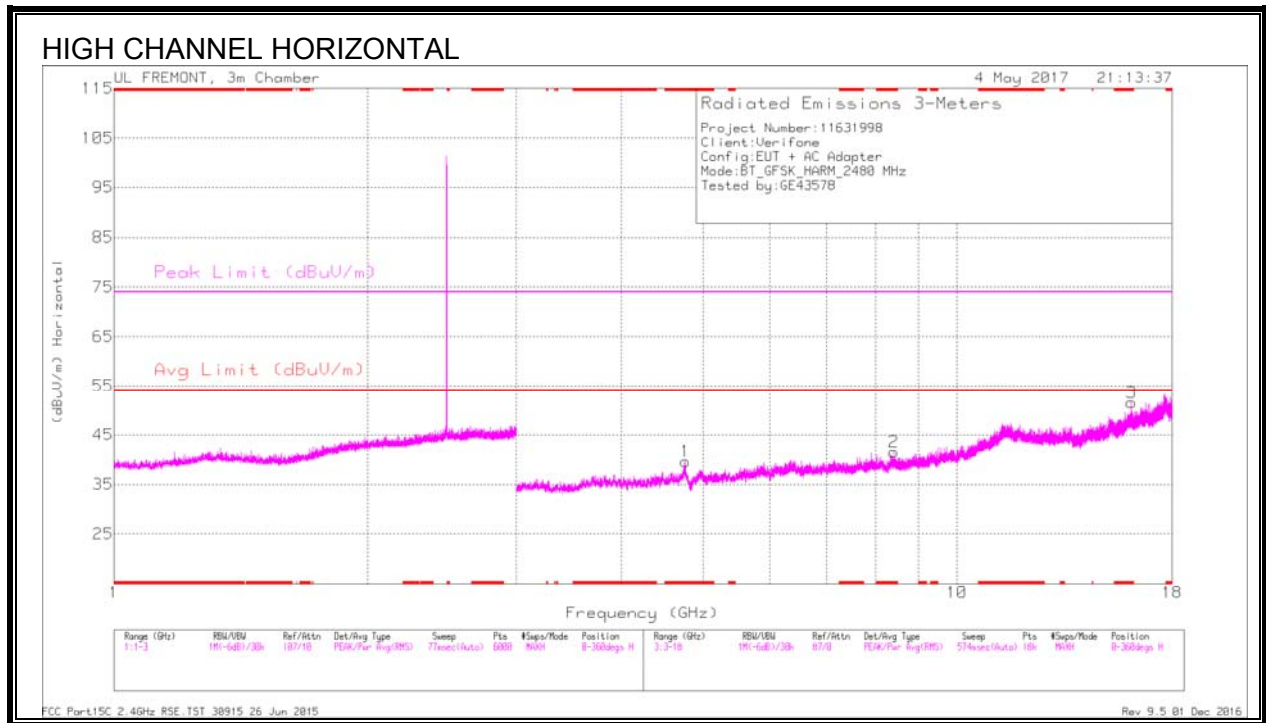

Frequency (GHz)	Meter Reading (dBuV)	Det	AF T712 (dB/m)	Amp/Cbl/Filtr/ Pad (dB)	Corrected Reading (dBuV/m)	Avg Limit (dBuV/m)	Margin (dB)	Peak Limit (dBuV/m)	PK Margin (dB)	Azimuth (Degs)	Height (cm)	Polarity
* 4.762	37.93	PKFH	34	-28.5	43.43	-	-	74	-30.57	182	100	H
* 4.763	26.94	VA1T	34	-28.4	32.54	54	-21.46	-	-	182	100	H
* 8.418	33.03	PKFH	35.8	-23.1	45.73	-	-	74	-28.27	91	200	H
* 8.418	20.37	VA1T	35.8	-23.1	33.07	54	-20.93	-	-	91	200	H
* 16.106	26.8	PKFH	40.8	-15.1	52.5	-	-	74	-21.5	291	336	H
* 16.104	11.39	VA1T	40.8	-15.2	36.99	54	-17.01	-	-	291	336	H
* 5.009	37.13	PKFH	34.1	-28	43.23	-	-	74	-30.77	150	100	V
* 5.011	25.28	VA1T	34.1	-28	31.38	54	-22.62	-	-	150	100	V
* 11.171	30.27	PKFH	37.8	-18.3	49.77	-	-	74	-24.23	290	200	V
* 11.172	17.55	VA1T	37.8	-18.3	37.05	54	-16.95	-	-	290	200	V
9.877	30.63	PKFH	36.9	-21.1	46.43	-	-	-	-	274	200	V
9.877	17.42	VA1T	36.9	-21.1	33.22	-	-	-	-	274	200	V

* - indicates frequency in CFR15.205/RSS-GEN 8.10 -Restricted Band
 PKFH - FHSS: RB=100k/1MHz VB=3 x RB, Peak
 VA1T - FHSS: Linear Voltage Average VB=1/Ton where: Ton is transmit duration

8.4.2. ENHANCED DATA RATE 8PSK MODULATION

BANDEDGE (LOW CHANNEL)

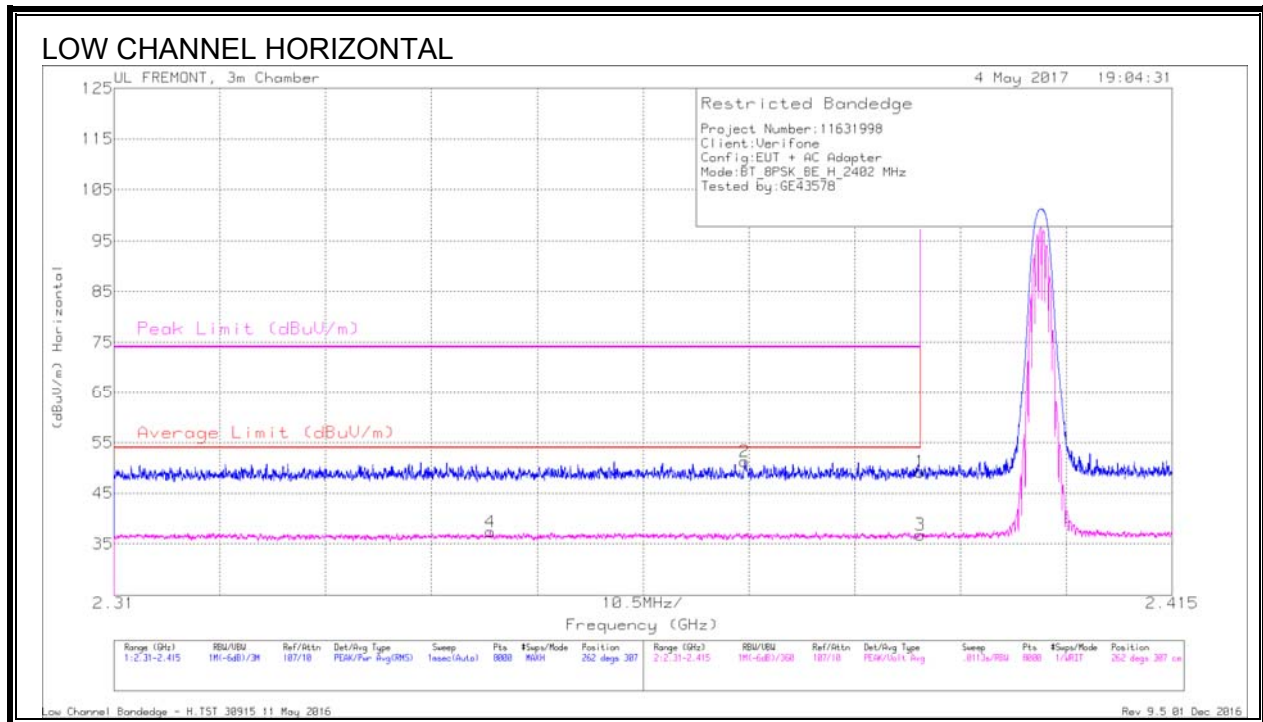

Marker	Frequency (GHz)	Meter Reading (dBuV)	Det	AF T712 (dB/m)	Amp/Cbl/Filtr/Pad (dB)	Corrected Reading (dBuV/m)	Average Limit (dBuV/m)	Margin (dB)	Peak Limit (dBuV/m)	PK Margin (dB)	Azimuth (Degs)	Height (cm)	Polarity
4	2.347	26.42	VA1T	31.8	-20.8	37.42	54	-16.58	-	-	262	307	H
2	2.373	40.31	Pk	31.9	-20.9	51.31	-	-	74	-22.69	262	307	H
1	2.39	38.14	Pk	31.9	-20.8	49.24	-	-	74	-24.76	262	307	H
3	2.39	25.72	VA1T	31.9	-20.8	36.82	54	-17.18	-	-	262	307	H

* - indicates frequency in CFR15.205/RSS-GEN 8.10 -Restricted Band

Pk - Peak detector

VA1T - FHSS: Linear Voltage Average $V_B=1/T_{on}$ where: T_{on} is transmit duration

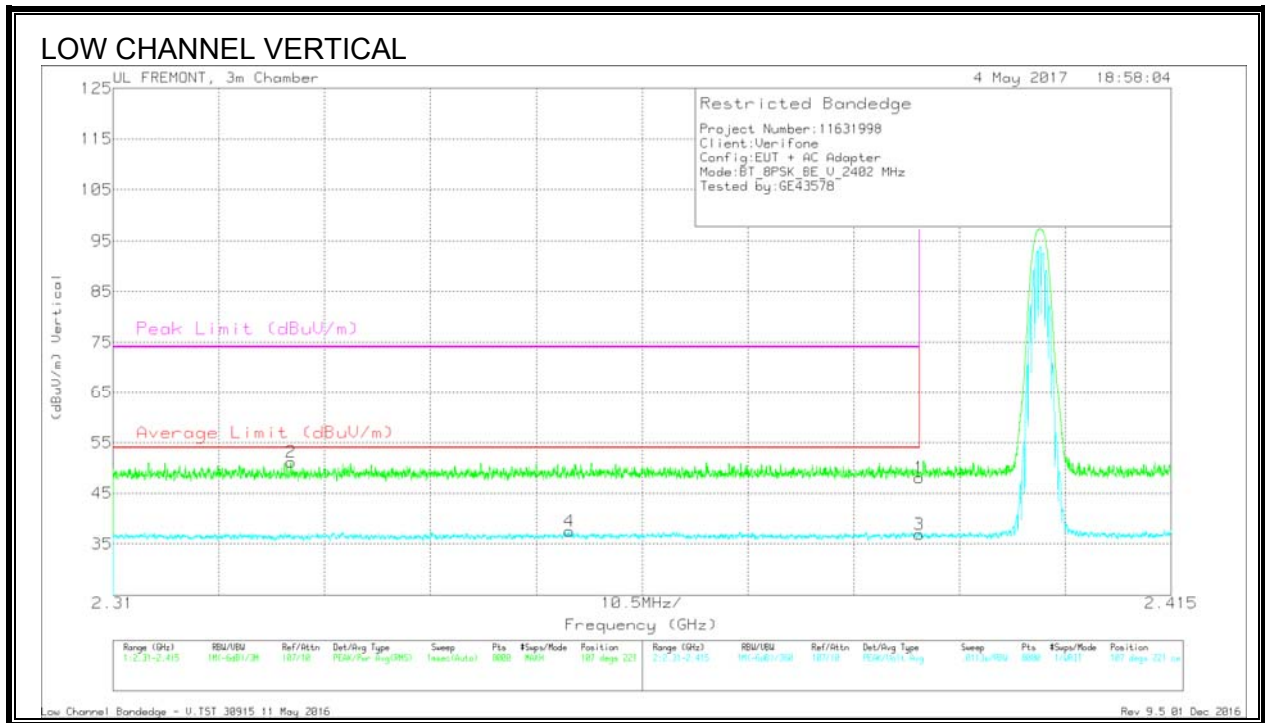

Marker	Frequency (GHz)	Meter Reading (dBuV)	Det	AF T712 (dB/m)	Amp/Cbl/Filtr/Pad (dB)	Corrected Reading (dBuV/m)	Average Limit (dBuV/m)	Margin (dB)	Peak Limit (dBuV/m)	PK Margin (dB)	Azimuth (Degs)	Height (cm)	Polarity
2	2.328	40.23	Pk	31.8	-20.9	51.13	-	-	74	-22.87	107	221	V
4	2.355	26.36	VA1T	31.9	-20.8	37.46	54	-16.54	-	-	107	221	V
1	2.39	37	Pk	31.9	-20.8	48.1	-	-	74	-25.9	107	221	V
3	2.39	25.79	VA1T	31.9	-20.8	36.89	54	-17.11	-	-	107	221	V

* - indicates frequency in CFR15.205/RSS-GEN 8.10 -Restricted Band

Pk - Peak detector

VA1T - FHSS: Linear Voltage Average VB=1/Ton where: Ton is transmit duration

BANDEDGE (HIGH CHANNEL)

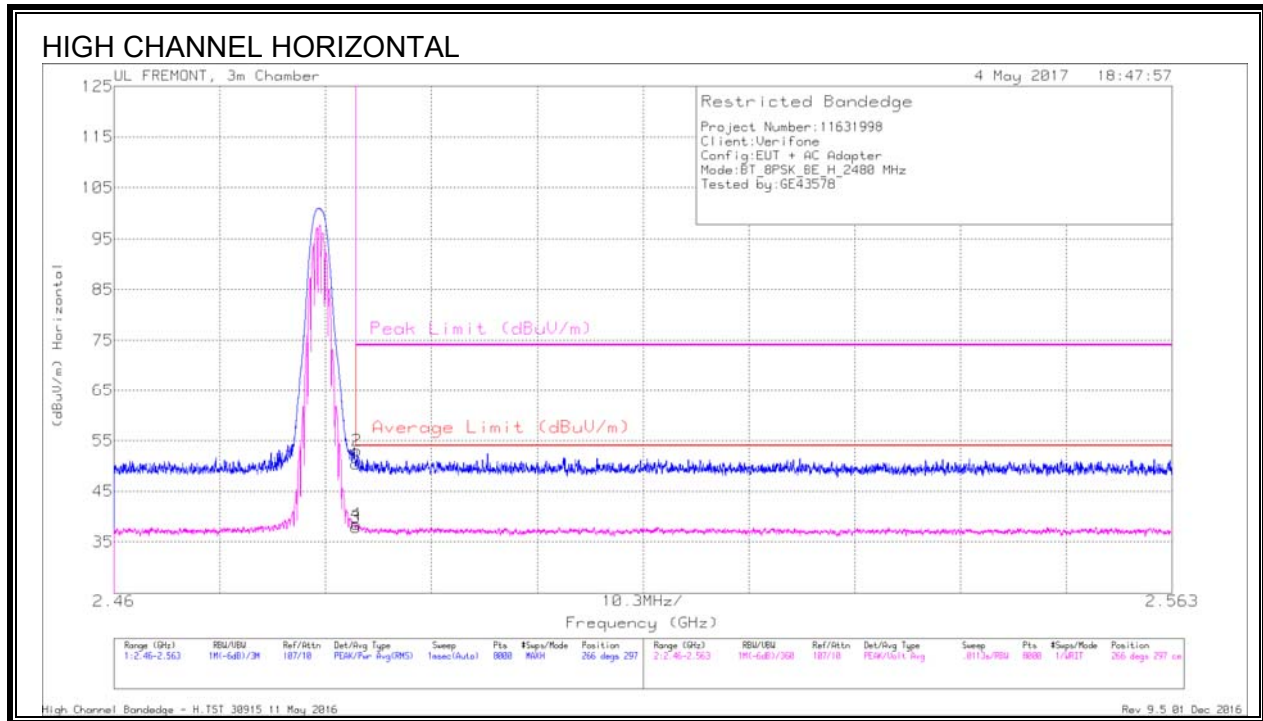

Marker	Frequency (GHz)	Meter Reading (dBuV)	Det	AF T712 (dB/m)	Amp/Cbi/Filtr/ Pad (dB)	Corrected Reading (dBuV/m)	Average Limit (dBuV/m)	Margin (dB)	Peak Limit (dBuV/m)	PK Margin (dB)	Azimuth (Degs)	Height (cm)	Polarity
1	2.484	38.79	Pk	32.4	-20.8	50.39	-	-	74	-23.61	266	297	H
2	2.484	41.39	Pk	32.4	-20.8	52.99	-	-	74	-21.01	266	297	H
3	2.484	26.27	VA1T	32.4	-20.8	37.87	54	-16.13	-	-	266	297	H
4	2.484	26.88	VA1T	32.4	-20.8	38.48	54	-15.52	-	-	266	297	H

* - indicates frequency in CFR15.205/RSS-GEN 8.10 -Restricted Band

Pk - Peak detector

VA1T - FHSS: Linear Voltage Average $V_B = 1/T_{on}$ where: T_{on} is transmit duration

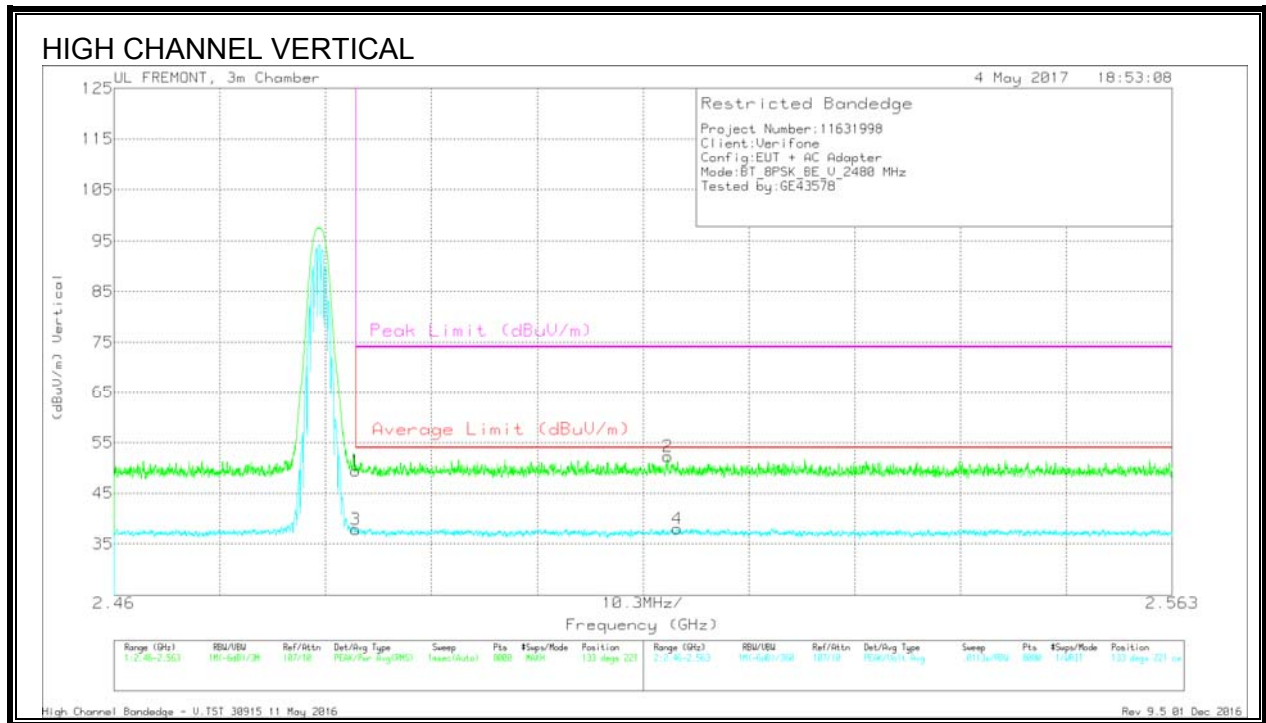

Marker	Frequency (GHz)	Meter Reading (dBuV)	Det	AF T712 (dB/m)	Amp/Cbl/Filtr/ Pad (dB)	Corrected Reading (dBuV/m)	Average Limit (dBuV/m)	Margin (dB)	Peak Limit (dBuV/m)	PK Margin (dB)	Azimuth (Degs)	Height (cm)	Polarity
1	2.484	37.86	Pk	32.4	-20.8	49.46	-	-	74	-24.54	133	221	V
3	2.484	26.29	VA1T	32.4	-20.8	37.89	54	-16.11	-	-	133	221	V
2	2.514	40.49	Pk	32.5	-20.7	52.29	-	-	74	-21.71	133	221	V
4	2.515	26.25	VA1T	32.5	-20.7	38.05	54	-15.95	-	-	133	221	V

* - indicates frequency in CFR15.205/RSS-GEN 8.10 -Restricted Band
 Pk - Peak detector
 VA1T - FHSS: Linear Voltage Average $V_B=1/T_{on}$ where: T_{on} is transmit duration

HARMONICS AND SPURIOUS EMISSIONS

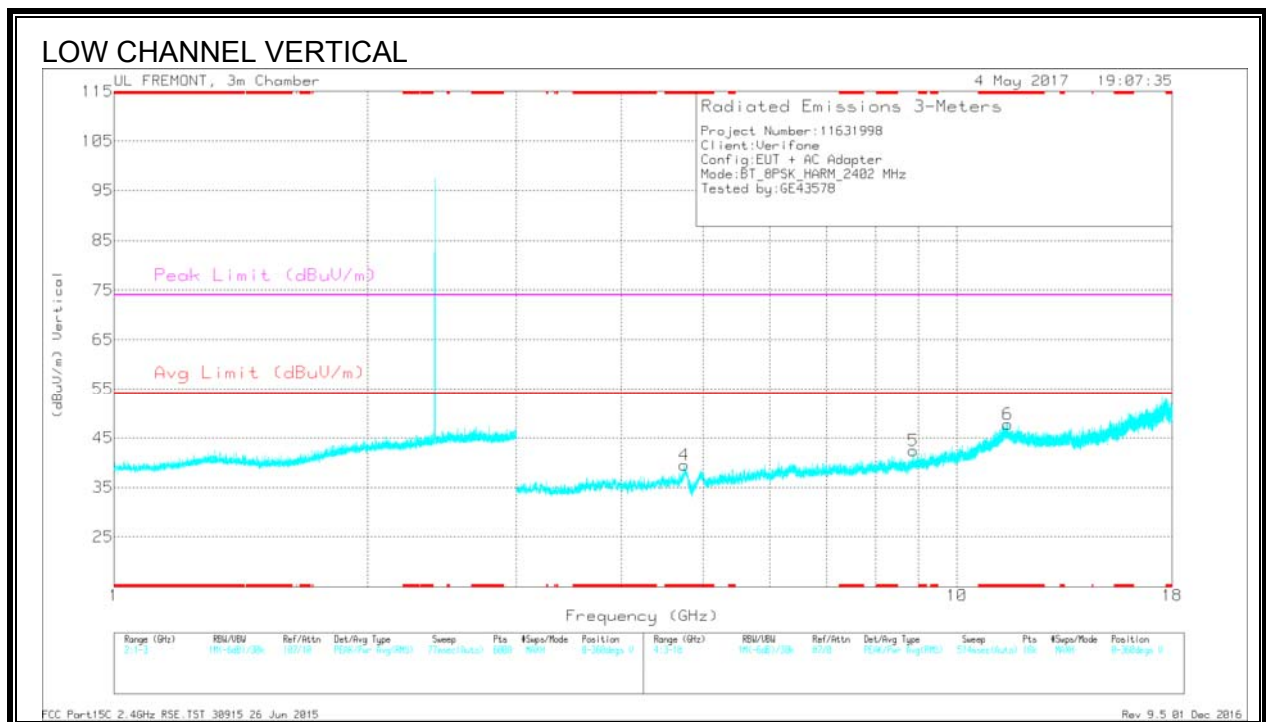
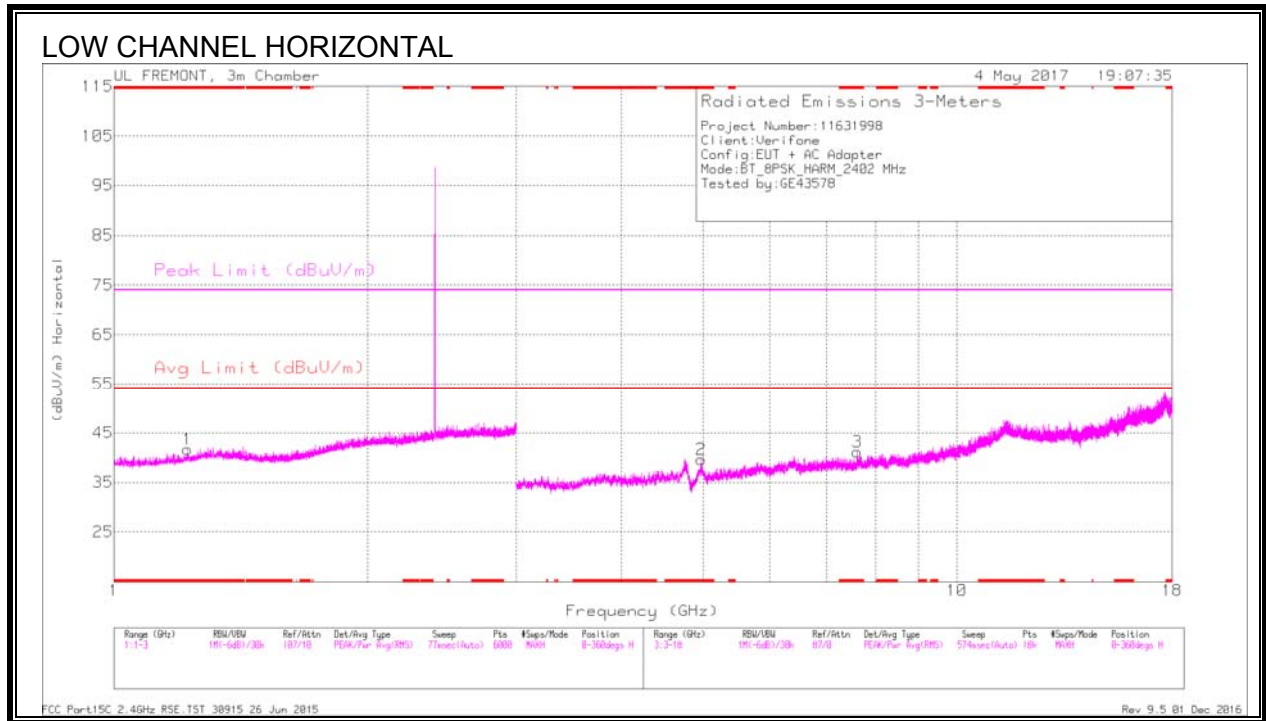

Frequency (GHz)	Meter Reading (dBuV)	Det	AF T712 (dB/m)	Amp/Cbl/Filtr/ Pad (dB)	Corrected Reading (dBuV/m)	Avg Limit (dBuV/m)	Margin (dB)	Peak Limit (dBuV/m)	PK Margin (dB)	Azimuth (Degs)	Height (cm)	Polarity
* 1.223	39.14	PKFH	28.4	-22.2	45.34	-	-	74	-28.66	29	200	H
* 1.22	27.59	VA1T	28.3	-22.2	33.69	54	-20.31	-	-	29	200	H
* 4.971	38.05	PKFH	34.1	-28.5	43.65	-	-	74	-30.35	272	100	H
* 4.972	26.34	VA1T	34.1	-28.5	31.94	54	-22.06	-	-	272	100	H
* 7.609	34.12	PKFH	35.7	-25.3	44.52	-	-	74	-29.48	136	200	H
* 7.609	22.26	VA1T	35.7	-25.3	32.66	54	-21.34	-	-	136	200	H
* 4.752	38.91	PKFH	34	-28.4	44.51	-	-	74	-29.49	198	200	V
* 4.752	27.3	VA1T	34	-28.4	32.9	54	-21.1	-	-	198	200	V
* 11.489	30.82	PKFH	38.1	-17.6	51.32	-	-	74	-22.68	138	200	V
* 11.489	18.09	VA1T	38.1	-17.6	38.59	54	-15.41	-	-	138	200	V
8.873	32.02	PKFH	36	-23	45.02	-	-	-	-	313	200	V
8.873	19.57	VA1T	36	-23	32.57	-	-	-	-	313	200	V

* - indicates frequency in CFR15.205/RSS-GEN 8.10 -Restricted Band
 PKFH - FHSS: RB=100k/1MHz VB=3 x RB, Peak
 VA1T - FHSS: Linear Voltage Average VB=1/Ton where: Ton is transmit duration

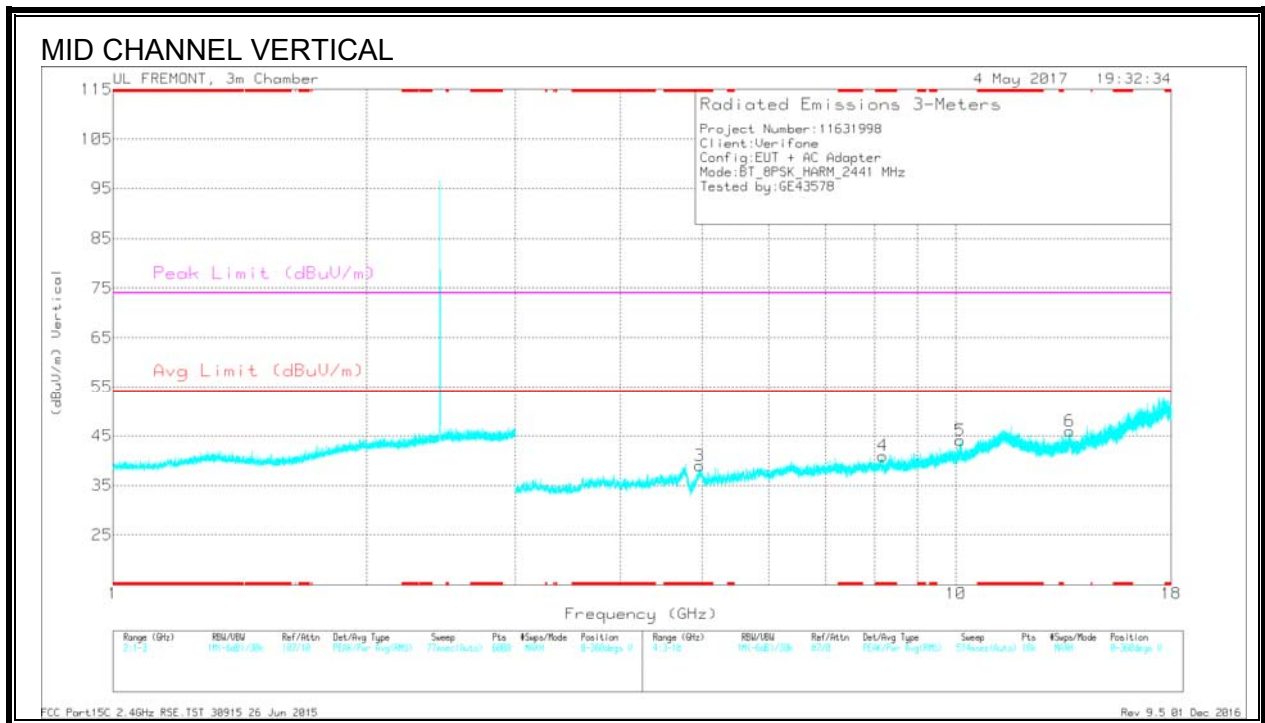
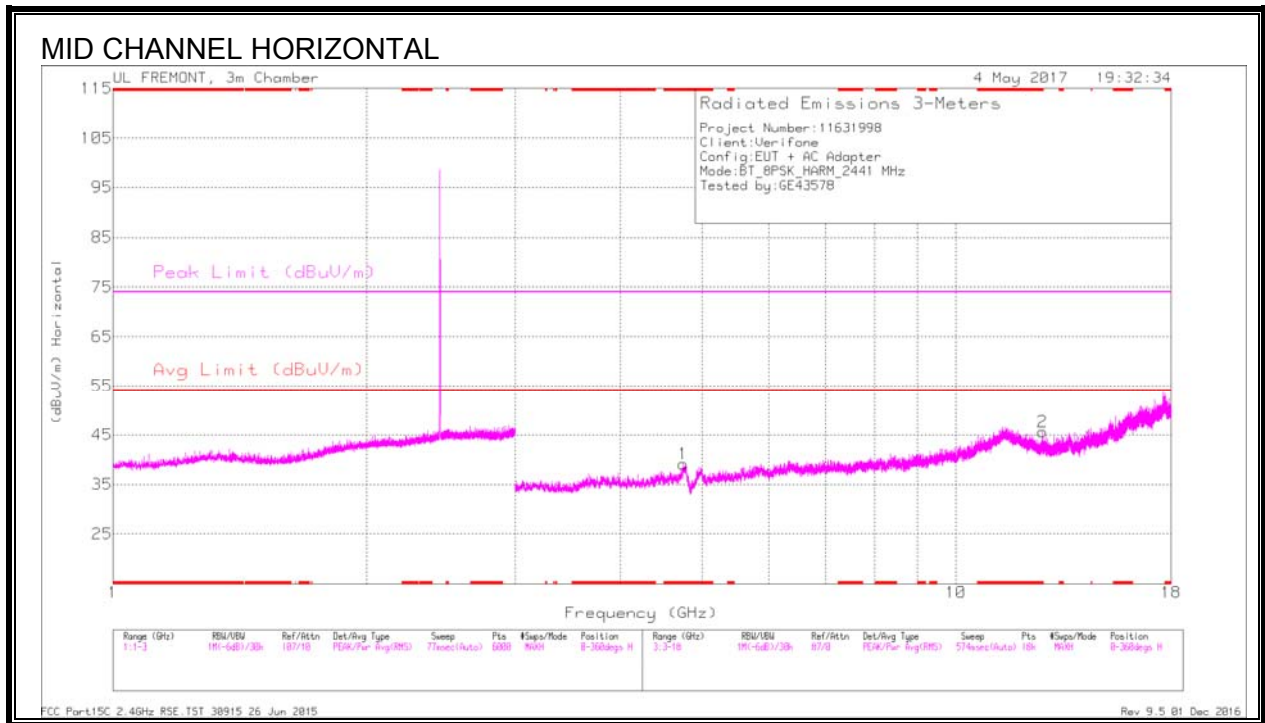

Frequency (GHz)	Meter Reading (dBuV)	Det	AF T712 (dB/m)	Amp/Cbl/Fitr/ Pad (dB)	Corrected Reading (dBuV/m)	Avg Limit (dBuV/m)	Margin (dB)	Peak Limit (dBuV/m)	PK Margin (dB)	Azimuth (Degs)	Height (cm)	Polarity
* 4.748	37.91	PKFH	34	-28.4	43.51	-	-	74	-30.49	279	200	H
* 4.75	27.36	VA1T	34	-28.3	33.06	54	-20.94	-	-	279	200	H
* 12.672	28.72	PKFH	39.1	-19.1	48.72	-	-	74	-25.28	69	200	H
* 12.674	15.28	VA1T	39.1	-19.1	35.28	54	-18.72	-	-	69	200	H
* 4.963	38.27	PKFH	34.1	-28.4	43.97	-	-	74	-30.03	79	200	V
* 4.962	26.35	VA1T	34.1	-28.5	31.95	54	-22.05	-	-	79	200	V
* 8.193	33.22	PKFH	35.8	-24	45.02	-	-	74	-28.98	278	200	V
* 8.196	21.16	VA1T	35.8	-23.9	33.06	54	-20.94	-	-	278	200	V
10.117	17.09	VA1T	37	-19.9	34.19	-	-	-	-	229	100	V
10.118	31.13	PKFH	37	-20	48.13	-	-	-	-	229	100	V
13.644	28.81	PKFH	38.6	-18.3	49.11	-	-	-	-	123	100	V
13.644	14.56	VA1T	38.6	-18.3	34.86	-	-	-	-	123	100	V

* - indicates frequency in CFR15.205/RSS-GEN 8.10 -Restricted Band
 PKFH - FHSS: RB=100k/1MHz VB=3 x RB, Peak
 VA1T - FHSS: Linear Voltage Average VB=1/Ton where: Ton is transmit duration

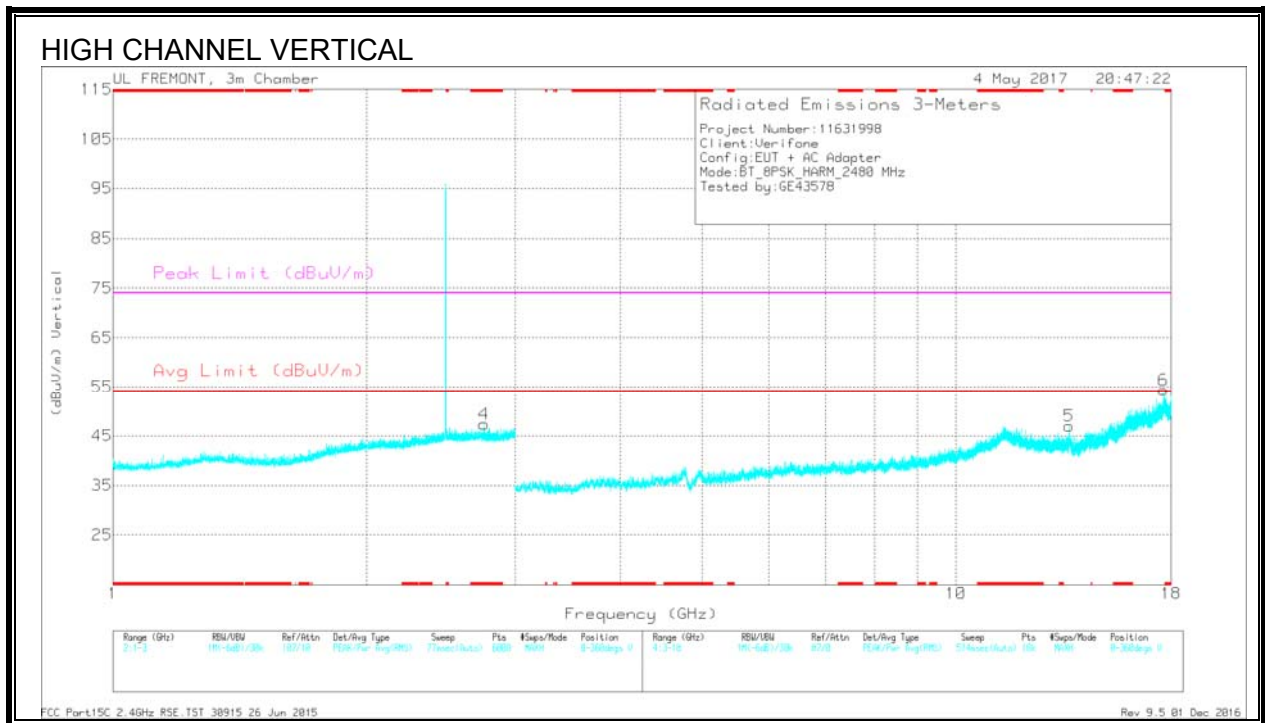
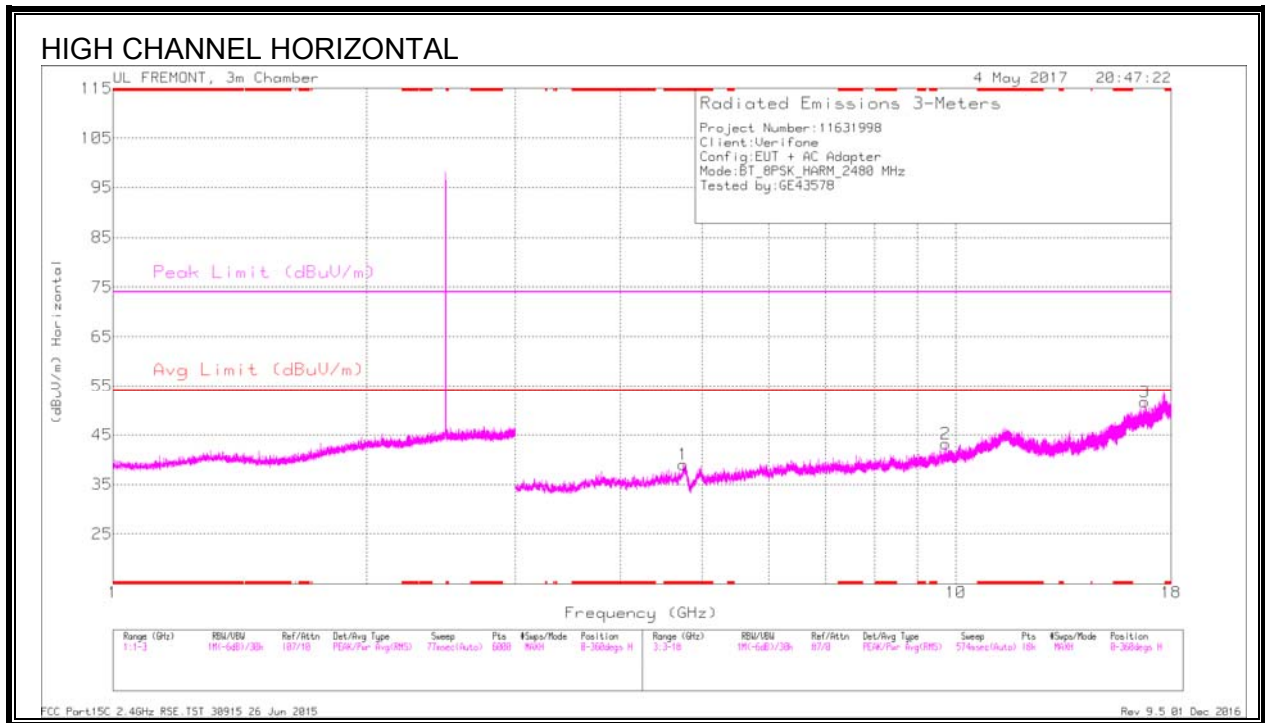

Frequency (GHz)	Meter Reading (dBuV)	Det	AF T712 (dB/m)	Amp/Cbl/Filtr/ Pad (dB)	Corrected Reading (dBuV/m)	Avg Limit (dBuV/m)	Margin (dB)	Peak Limit (dBuV/m)	PK Margin (dB)	Azimuth (Degs)	Height (cm)	Polarity
* 2.754	38.25	PKFH	32.4	-20.4	50.25	-	-	74	-23.75	211	200	V
* 2.755	25.77	VA1T	32.4	-20.4	37.77	54	-16.23	-	-	211	200	V
* 4.747	39.11	PKFH	34	-28.4	44.71	-	-	74	-29.29	24	200	H
* 4.749	26.93	VA1T	34	-28.3	32.63	54	-21.37	-	-	24	200	H
9.72	32.15	PKFH	36.8	-21.9	47.05	-	-	-	-	59	200	H
9.72	19.01	VA1T	36.8	-21.9	33.91	-	-	-	-	59	200	H
13.621	32.25	PKFH	38.7	-18.1	52.85	-	-	-	-	299	200	V
13.621	19.41	VA1T	38.7	-18.1	40.01	-	-	-	-	299	200	V
16.743	8.97	VA1T	41.4	-13.1	37.27	-	-	-	-	321	332	H
16.744	26.92	PKFH	41.4	-13.1	55.22	-	-	-	-	321	332	H
17.634	9.32	VA1T	41.4	-11.4	39.32	-	-	-	-	0	344	V
17.637	28.01	PKFH	41.4	-11.3	58.11	-	-	-	-	0	344	V

* - indicates frequency in CFR15.205/RSS-GEN 8.10 -Restricted Band
 PKFH - FHSS: RB=100K/1MHz VB=3 x RB, Peak
 VA1T - FHSS: Linear Voltage Average VB=1/Ton where: Ton is transmit duration

8.5. WORST-CASE ABOVE 18 GHz

SPURIOUS EMISSIONS 18 TO 26 GHz (WORST-CASE CONFIGURATION)

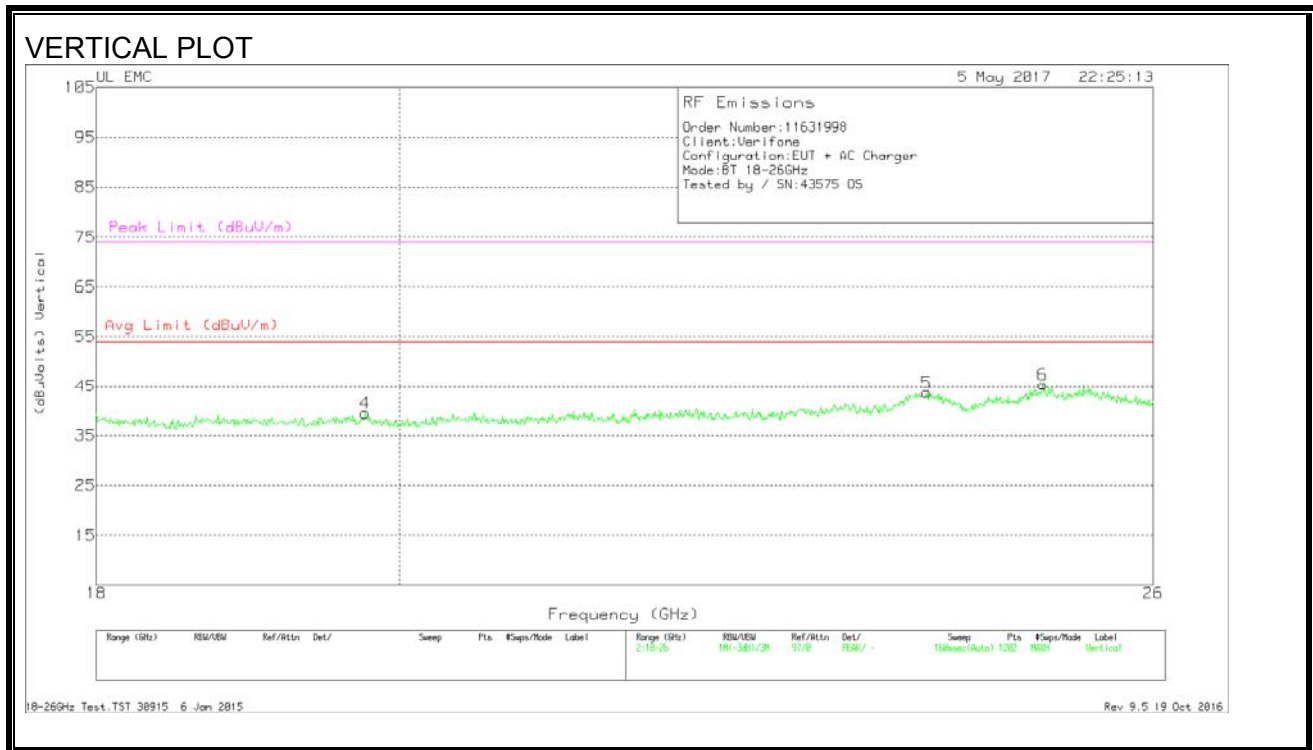
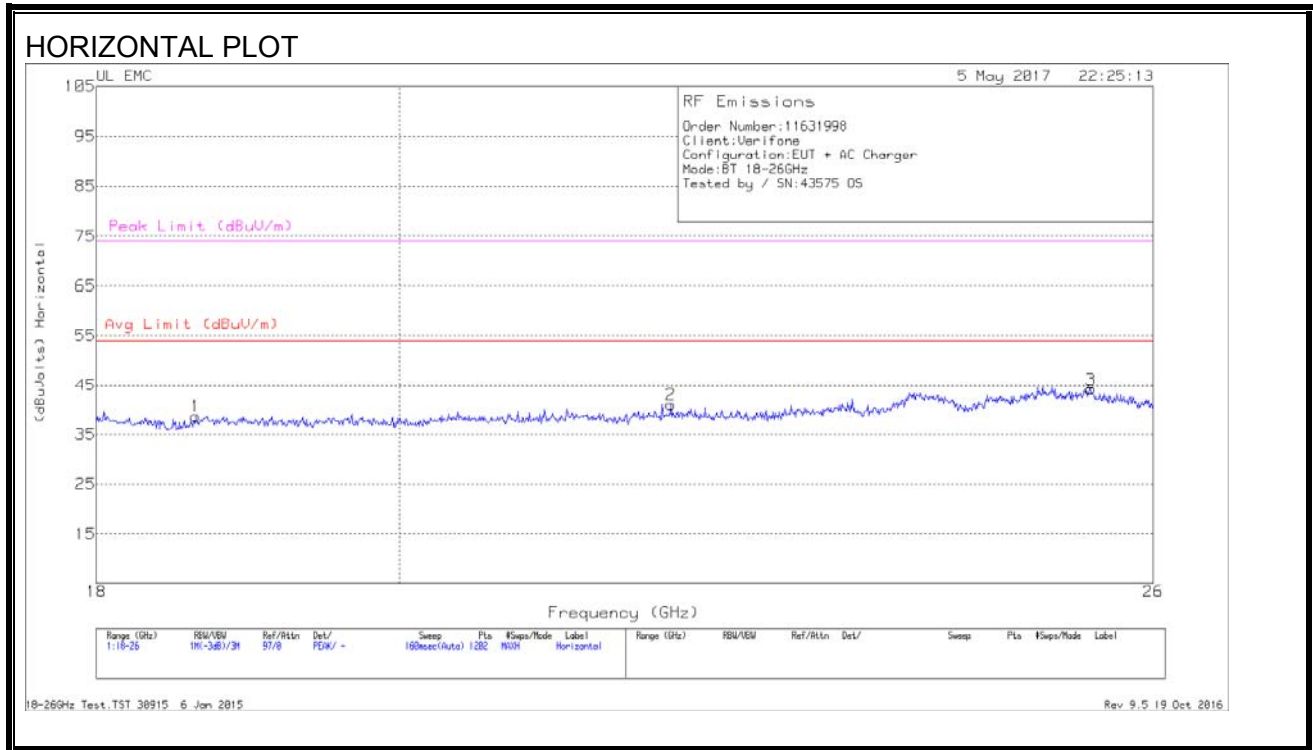

Data

Marker	Frequency (GHz)	Meter Reading (dBuV)	Det	AF T449 (dB/m)	Amp/Cbl (dB)	Dist Corr (dB)	Corrected Reading (dBuVolts)	Avg Limit (dBuV/m)	Margin (dB)	Peak Limit (dBuV/m)	PK Margin (dB)
1	18.633	40.47	Pk	32.5	-24.8	-9.5	38.667	54	-15.333	74	-35.333
2	21.983	42	Pk	33.5	-25	-9.5	41	54	-13	74	-33
3	25.44	43.57	Pk	34.4	-24.3	-9.5	44.167	54	-9.833	74	-29.833
4	19.765	41.1	Pk	32.7	-24.8	-9.5	39.5	54	-14.5	74	-34.5
5	24.028	43.27	Pk	34	-24.1	-9.5	43.667	54	-10.333	74	-30.333
6	25.021	45.03	Pk	34.2	-24.4	-9.5	45.333	54	-8.667	74	-28.667

Pk - Peak detector

9. AC POWER LINE CONDUCTED EMISSIONS

LIMITS

FCC §15.207 (a)
RSS-Gen 8.8

Frequency of Emission (MHz)	Conducted Limit (dB μ V)	
	Quasi-peak	Average
0.15-0.5	66 to 56 *	56 to 46 *
0.5-5	56	46
5-30	60	50

*Decreases with the logarithm of the frequency.

TEST PROCEDURE

The EUT is placed on a non-conducting table 40 cm from the vertical ground plane and 80 cm above the horizontal ground plane. The EUT is configured in accordance with ANSI C63.10.

The receiver is set to a resolution bandwidth of 9 kHz. Peak detection is used unless otherwise noted as quasi-peak or average.

Line conducted data is recorded for both NEUTRAL and HOT lines.

RESULTS

LINE 1 RESULTS

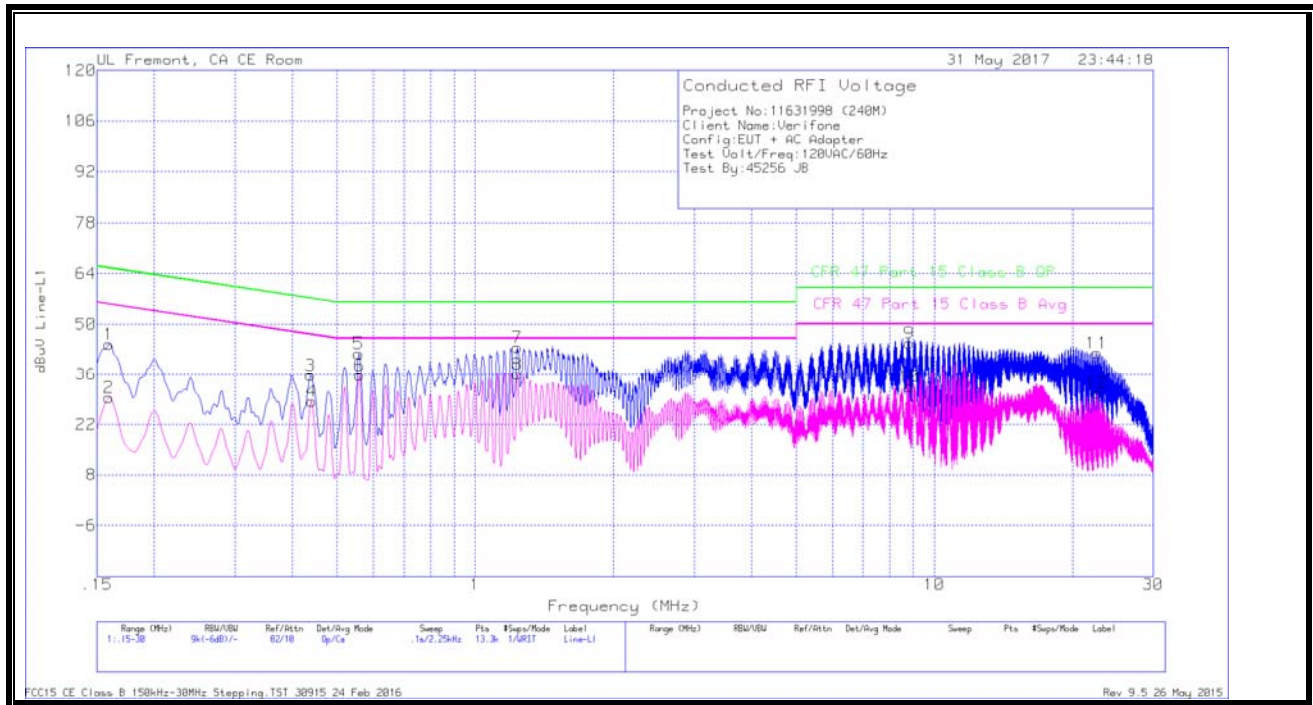

WORST EMISSIONS

Range 1: Line-L1 .15 - 30MHz

Marker	Frequency (MHz)	Meter Reading (dBuV)	Det	LISN L1	LC Cables C1&C3	Limiter (dB)	Corrected Reading dBuV	CFR 47 Part 15 Class B QP	QP Margin (dB)	CFR 47 Part 15 Class B Avg	Av(CISPR) Margin (dB)
1	.159	34.26	Qp	0	.1	10.1	44.46	65.52	-21.06	-	-
2	.159	19.25	Ca	0	.1	10.1	29.45	-	-	55.52	-26.07
3	.438	25.62	Qp	0	.1	10.1	35.82	57.1	-21.28	-	-
4	.44025	18.18	Ca	0	.1	10.1	28.38	-	-	47.06	-18.68
5	.55725	31.71	Qp	0	.1	10.1	41.91	56	-14.09	-	-
6	.5595	25.5	Ca	0	.1	10.1	35.7	-	-	46	-10.3
7	1.2345	33.34	Qp	0	.1	10.1	43.54	56	-12.46	-	-
8	1.23675	25.94	Ca	0	.1	10.1	36.14	-	-	46	-9.86
9	8.83725	34.32	Qp	0	.2	10.2	44.72	60	-15.28	-	-
10	8.835	22.17	Ca	0	.2	10.2	32.57	-	-	50	-17.43
11	22.614	31.2	Qp	.1	.3	10.4	42	60	-18	-	-
12	22.6545	19.96	Ca	.1	.3	10.4	30.76	-	-	50	-19.24

Qp - Quasi-Peak detector

Ca - CISPR average detection

LINE 2 RESULTS

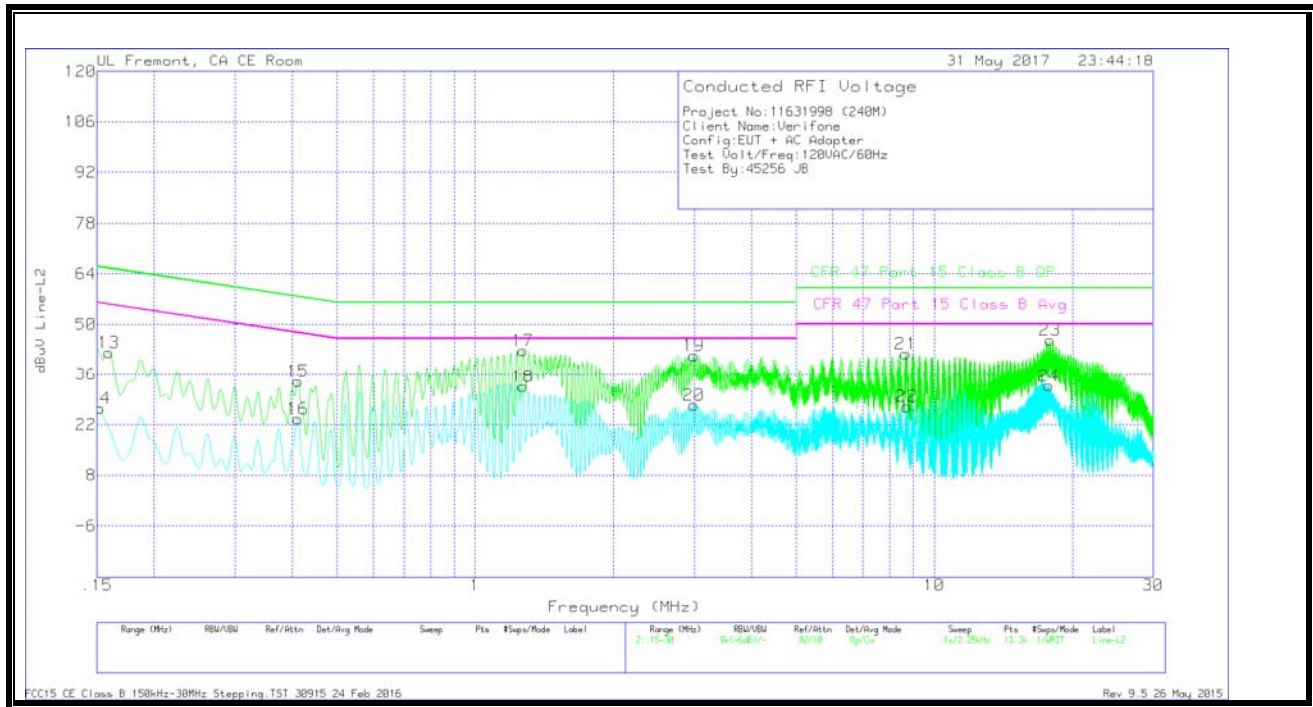

WORST EMISSIONS

Range 2: Line-L2 .15 - 30MHz

Marker	Frequency (MHz)	Meter Reading (dBuV)	Det	LISN L2	LC Cables C2&C3	Limiter (dB)	Corrected Reading dBuV	CFR 47 Part 15 Class B QP	QP Margin (dB)	CFR 47 Part 15 Class B Avg	Av(CISPR) Margin (dB)
13	.159	31.94	Qp	0	.1	10.1	42.14	65.52	-23.38	-	-
14	.15225	16.41	Ca	0	0	10.1	26.51	-	-	55.88	-29.37
15	.411	23.89	Qp	0	.1	10.1	34.09	57.63	-23.54	-	-
16	.411	13.33	Ca	0	.1	10.1	23.53	-	-	47.63	-24.1
17	1.2705	32.46	Qp	0	.1	10.1	42.66	56	-13.34	-	-
18	1.2705	22.34	Ca	0	.1	10.1	32.54	-	-	46	-13.46
19	2.99175	31.19	Qp	0	.1	10.1	41.39	56	-14.61	-	-
20	2.99175	17.28	Ca	0	.1	10.1	27.48	-	-	46	-18.52
21	8.67525	31.38	Qp	0	.2	10.2	41.78	60	-18.22	-	-
22	8.7135	16.57	Ca	0	.2	10.2	26.97	-	-	50	-23.03
23	17.86425	35.09	Qp	0	.3	10.3	45.69	60	-14.31	-	-
24	17.7945	22.18	Ca	0	.3	10.3	32.78	-	-	50	-17.22

Qp - Quasi-Peak detector

Ca - CISPR average detection