



# **CERTIFICATION TEST REPORT**

**Report Number. :** 11631998-E5V1

**Applicant :** Verifone, Inc.  
1400 West Stanford Ranch Road  
Rocklin, CA 95765, USA

**Model :** V240m Plus 3GBW

**FCC ID :** B32V240MPLUS

**IC :** 787C-V240MPLUS

**EUT Description :** Mobile Point of Sale Terminal

**Test Standard(s) :** FCC 47 CFR PART 15 SUBPART C  
INDUSTRY CANADA RSS - 210 ISSUE 9  
INDUSTRY CANADA RSS-GEN Issue 4

**Date Of Issue:**

August 16, 2017

**Prepared by:**

UL Verification Services Inc.  
47173 Benicia Street  
Fremont, CA 94538, U.S.A.  
TEL: (510) 771-1000  
FAX: (510) 661-0888



NVLAP Lab code: 200246-0

**Revision History**

<u>Ver.</u>	<u>Issue Date</u>	<u>Revisions</u>	<u>Revised By</u>
V1	08/16/17	Initial Issue	D. Corona

## TABLE OF CONTENTS

<b>1. ATTESTATION OF TEST RESULTS .....</b>	<b>4</b>
<b>2. TEST METHODOLOGY .....</b>	<b>5</b>
<b>3. FACILITIES AND ACCREDITATION .....</b>	<b>5</b>
<b>4. CALIBRATION AND UNCERTAINTY .....</b>	<b>6</b>
4.1. <i>MEASURING INSTRUMENT CALIBRATION .....</i>	6
4.2. <i>SAMPLE CALCULATION .....</i>	6
4.3. <i>MEASUREMENT UNCERTAINTY.....</i>	6
<b>5. EQUIPMENT UNDER TEST.....</b>	<b>7</b>
5.1. <i>DESCRIPTION OF EUT .....</i>	7
5.2. <i>MAXIMUM FIELD STRENGTH.....</i>	7
5.3. <i>DESCRIPTION OF AVAILABLE ANTENNAS .....</i>	7
5.4. <i>SOFTWARE AND FIRMWARE.....</i>	7
5.5. <i>WORST-CASE CONFIGURATION AND MODE.....</i>	7
5.6. <i>MODIFICATIONS .....</i>	7
5.7. <i>DESCRIPTION OF TEST SETUP.....</i>	8
<b>6. TEST AND MEASUREMENT EQUIPMENT .....</b>	<b>11</b>
<b>7. OCCUPIED BANDWIDTH .....</b>	<b>12</b>
<b>8. RADIATED EMISSION TEST RESULTS.....</b>	<b>13</b>
8.1. <i>LIMITS AND PROCEDURE .....</i>	13
8.1.1. <i>FUNDAMENTAL EMISSION MASK (11.56 – 15.56MHz).....</i>	15
8.1.2. <i>SPURIOUS EMISSIONS (0.09 – 30MHz) .....</i>	17
8.1.3. <i>TX SPURIOUS EMISSIONS (30 – 1000MHz) .....</i>	18
<b>9. AC MAINS LINE CONDUCTED EMISSIONS.....</b>	<b>20</b>
<b>10. FREQUENCY STABILITY.....</b>	<b>29</b>
<b>11. SETUP PHOTOS .....</b>	<b>30</b>

# 1. ATTESTATION OF TEST RESULTS

**COMPANY NAME:** Verifone, Inc.  
1400 West Stanford Ranch Road Suite 200  
Rocklin, CA 95765, USA

**EUT DESCRIPTION:** Mobile Point of Sale Terminal

**MODEL:** V240m Plus 3GBW

**SERIAL NUMBER:** 313-855-592

**DATE TESTED:** April 27 to June 08, 2017

APPLICABLE STANDARDS	
STANDARD	TEST RESULTS
FCC PART 15 SUBPART C	Pass
INDUSTRY CANADA RSS-210 Issue 9, Annex B	Pass
INDUSTRY CANADA RSS-GEN Issue 4	Pass

UL Verification Services Inc. tested the above equipment in accordance with the requirements set forth in the above standards. All indications of Pass/Fail in this report are opinions expressed by UL Verification Services Inc. based on interpretations and/or observations of test results. Measurement Uncertainties were not taken into account and are published for informational purposes only. The test results show that the equipment tested is capable of demonstrating compliance with the requirements as documented in this report.

**Note:** The results documented in this report apply only to the tested sample, under the conditions and modes of operation as described herein. This document may not be altered or revised in any way unless done so by UL Verification Services Inc. and all revisions are duly noted in the revisions section. Any alteration of this document not carried out by UL Verification Services Inc. will constitute fraud and shall nullify the document. This report must not be used by the client to claim product certification, approval, or endorsement by NVLAP, NIST, any agency of the Federal Government, or any agency of any government.

Approved & Released For  
UL Verification Services Inc. By:



DAN CORONIA  
CONSUMER TECHNOLOGY DIVISION  
WiSE PROJECT LEAD  
UL VERIFICATION SERVICES INC

Prepared By:



GLENN ESCANO  
CONSUMER TECHNOLOGY DIVISION  
WiSE LAB ENGINEER  
UL VERIFICATION SERVICES INC

## 2. TEST METHODOLOGY

The tests documented in this report were performed in accordance with ANSI C63.10-2013, FCC CFR 47 Part 2, and FCC CFR 47 Part 15, RSS-GEN Issue 4, and RSS-210 Issue 9.

## 3. FACILITIES AND ACCREDITATION

The test sites and measurement facilities used to collect data are located at 47173 and 47266 Benicia Street, Fremont, California, USA. Line conducted emissions are measured only at the 47173 address. The following table identifies which facilities were utilized for radiated emission measurements documented in this report. Specific facilities are also identified in the test results sections.

47173 Benicia Street	47266 Benicia Street
<input checked="" type="checkbox"/> Chamber A (IC:2324B-1)	<input type="checkbox"/> Chamber D (IC:22541-1)
<input type="checkbox"/> Chamber B (IC:2324B-2)	<input type="checkbox"/> Chamber E (IC: 22541-2)
<input type="checkbox"/> Chamber C (IC:2324B-3)	<input type="checkbox"/> Chamber F (IC: 22541-3)
	<input type="checkbox"/> Chamber G (IC: 22541-4)
	<input type="checkbox"/> Chamber H (IC: 22541-5)

The above test sites and facilities are covered under FCC Test Firm Registration # 208313. UL Verification Services Inc. is accredited by NVLAP, Laboratory Code 200065-0.

Chambers A through C are covered under Industry Canada company address code 2324B with site numbers 2324B -1 through 2324B-3, respectively and Chambers D through H are covered under Industry Canada company address code 22541 with site numbers 22541 -1 through 22541-5, respectively.

## 4. CALIBRATION AND UNCERTAINTY

### 4.1. MEASURING INSTRUMENT CALIBRATION

The measuring equipment utilized to perform the tests documented in this report has been calibrated in accordance with the manufacturer's recommendations, and is traceable to recognized national standards.

### 4.2. SAMPLE CALCULATION

Where relevant, the following sample calculation is provided:

$$\begin{aligned} \text{Field Strength (dBuV/m)} &= \text{Measured Voltage (dBuV)} + \text{Antenna Factor (dB/m)} + \\ &\text{Cable Loss (dB)} - \text{Preamp Gain (dB)} \\ 36.5 \text{ dBuV} + 18.7 \text{ dB/m} + 0.6 \text{ dB} - 26.9 \text{ dB} &= 28.9 \text{ dBuV/m} \end{aligned}$$

### 4.3. MEASUREMENT UNCERTAINTY

Where relevant, the following measurement uncertainty levels have been estimated for tests performed on the apparatus:

Parameter	Uncertainty
Worst Case Conducted Disturbance, 9KHz to 0.15 MHz	3.84 dB
Worst Case Conducted Disturbance, 0.15 to 30 MHz	3.65 dB
Worst Case Radiated Disturbance, 9KHz to 30 MHz	3.15 dB
Worst Case Radiated Disturbance, 30 to 1000 MHz	5.36 dB
Worst Case Radiated Disturbance, 1000 to 18000 MHz	4.32 dB
Worst Case Radiated Disturbance, 18000 to 26000 MHz	4.45 dB
Worst Case Radiated Disturbance, 26000 to 40000 MHz	5.24 dB

Uncertainty figures are valid to a confidence level of 95%.

## **5. EQUIPMENT UNDER TEST**

### **5.1. DESCRIPTION OF EUT**

The EUT is the Mobile Point of Sale Terminal which contains an 11a/b/g/n/ac W-LAN + Bluetooth 4.1 combo module.

### **5.2. MAXIMUM FIELD STRENGTH**

The testing was performed at 3 meter. The transmitter maximum E-field at 30 meter distance is 42.92 dBuV/m which is converted from the 3 meter data.

### **5.3. DESCRIPTION OF AVAILABLE ANTENNAS**

The radio used a two turn, inductive loop antenna.

### **5.4. SOFTWARE AND FIRMWARE**

The firmware installed in the EUT during testing was VOS2 – 30640xxx.

### **5.5. WORST-CASE CONFIGURATION AND MODE**

Radiated emission was performed with the EUT set to transmit at the channel with highest output power as worst-case scenario.

The fundamental of the EUT was investigated in three orthogonal orientations X, Y, Z, it was determined that Z-Axis orientation was worst-case orientation; therefore, all final radiated testing was performed with the EUT in Z-Axis orientation.

### **5.6. MODIFICATIONS**

No modifications were made during testing.

## 5.7. DESCRIPTION OF TEST SETUP

### SUPPORT EQUIPMENT

Support Equipment List				
Description	Manufacturer	Model	Serial Number	FCC ID
Laptop	Lenovo	20B7S0A200	PC015REW	NA
AC Adapter	Verifone	SC1402	1708200053701	NA
AC Adapter	Verifone	AM11A-050A	1650A1P	NA

### I/O CABLES (CONDUCTED TEST)

I/O Cable List						
Cable No	Port	# of identical ports	Connector Type	Cable Type	Cable Length (m)	Remarks
1	Antenna	1	SMA	Un-Shielded	0.1	To spectrum Analyzer
2	DC	1	AC	Un-shielded	2	N/A
3	USB	1	USB	Shielded	2	N/A

### I/O CABLES (RADIATED AND CONDUCTED EMISSIONS)

I/O Cable List						
Cable No	Port	# of identical ports	Connector Type	Cable Type	Cable Length (m)	Remarks
1	DC	1	AC	Un-shielded	2	N/A



**CONDUCTED TEST SETUP DIAGRAM**

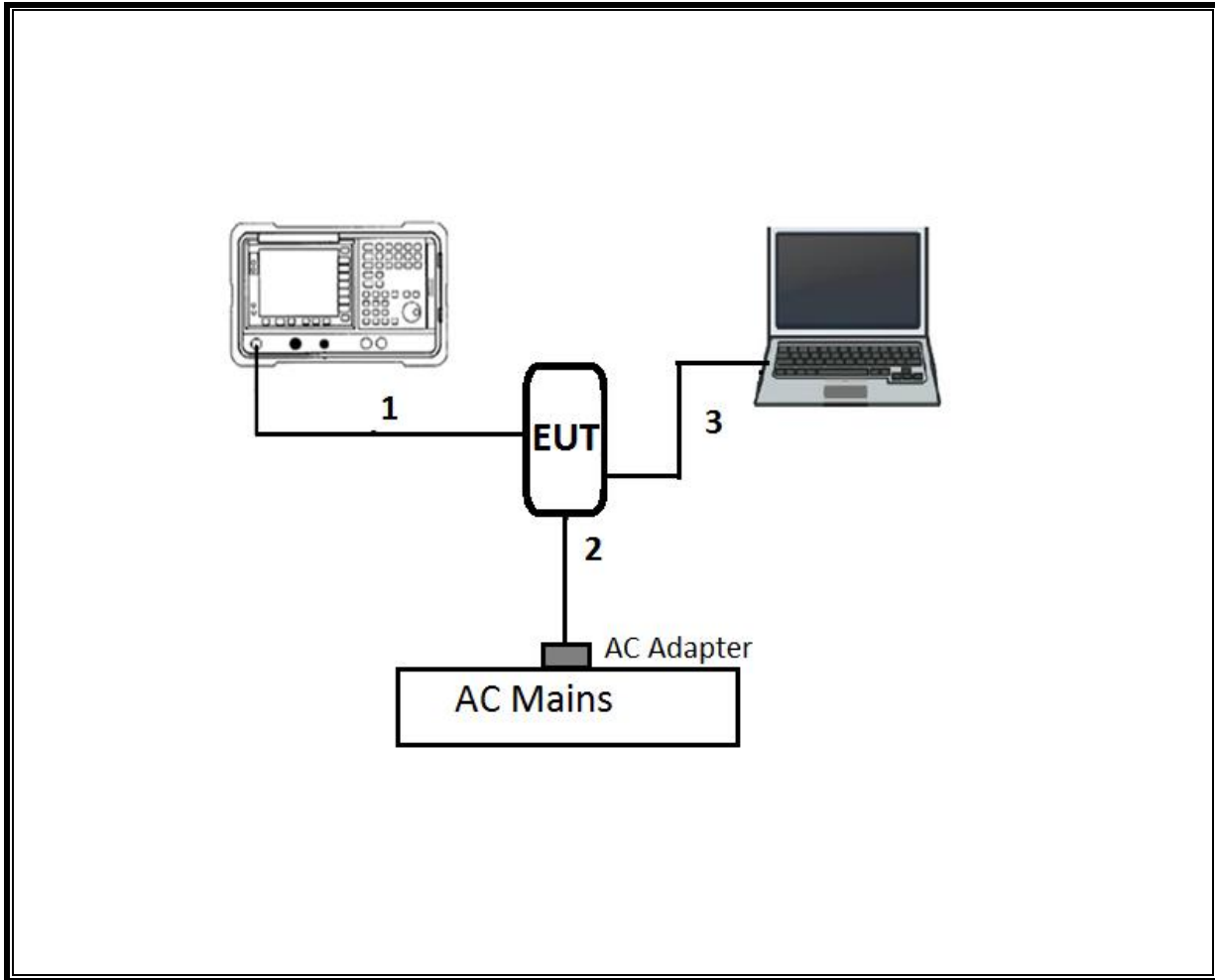

**RADIATED AND AC LINE CONDUCTED EMISSIONS SETUP DIAGRAM**

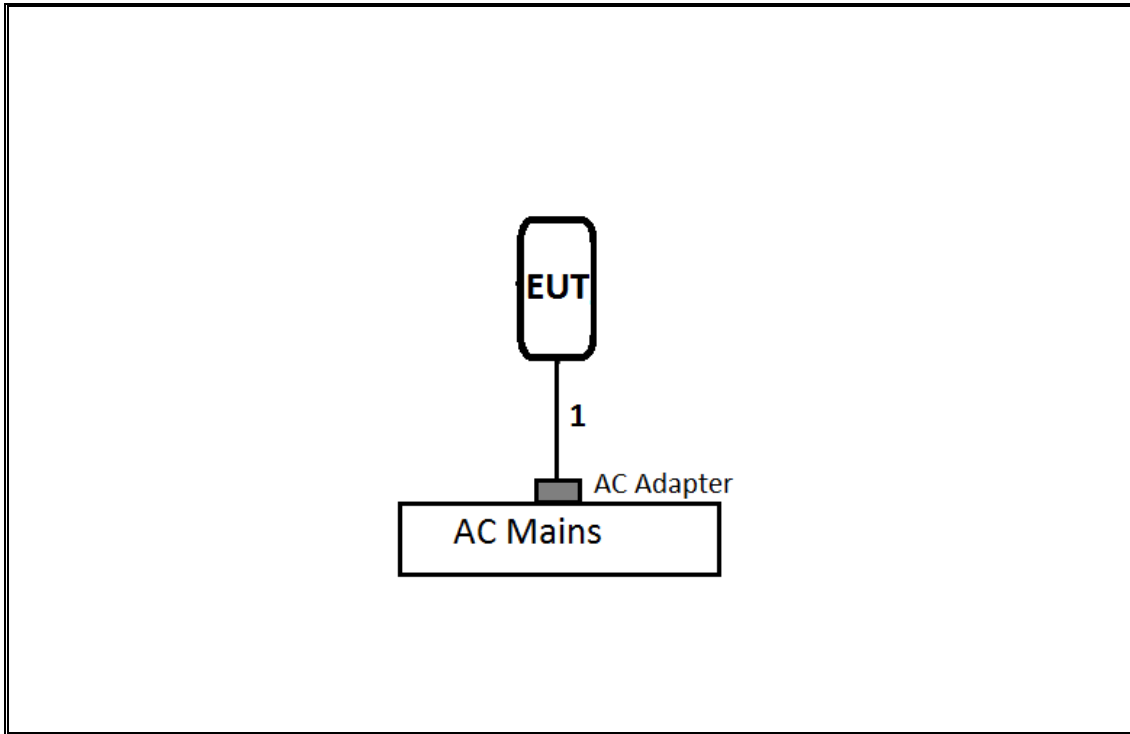

## 6. TEST AND MEASUREMENT EQUIPMENT

The following test and measurement equipment was utilized for the tests documented in this report:

TEST EQUIPMENT LIST				
Description	Manufacturer	Model	Asset	Cal Due
Antenna, Broadband Hybrid, 30MHz to 2000MHz w/4dB Pad	Sunol Sciences Corp.	JB3	T477	06/22/17
Antenna, Active Loop 9kHz-30MHz	ETS-Lindgren	6502	T1683	02/17/18
Amplifier, 10kHz-1GHz	Agilent (Keysight) Technologies	8447D	T15	08/26/17
Spectrum Analyzer, PXA, 3Hz to 44GHz	Agilent (Keysight) Technologies	N9030A	T907	01/23/18
Spectrum Analyzer, PXA, 3Hz to 44GHz	Agilent (Keysight) Technologies	N9030A	T1450	01/10/18
Temperature Chamber	Thermotron Industries	SE-600-10-10	T80	08/21/17
EMI Test Receiver	Rohde & Schwarz	ESR	T1436	01/18/18
LISN	Fischer Custom Communications	FCC-LISN-50/250-25-2-01	T1310	06/08/17
Transient Limiter	COM-POWER	LIT-930	T1457	02/24/18

NOTE: \*testing is completed before equipment calibration expiration date.

Test Software List			
Description	Manufacturer	Model	Version
Radiated Software	UL	UL EMC	Ver 9.5, Apr 26, 2016
Antenna Port Software	UL	UL RF	Ver 5.1.1, July 15, 2016

## 7. OCCUPIED BANDWIDTH

### LIMITS

For reporting purposes only. Tested per ANSI C63.10 (6.9.3)

### RESULTS

<b>ID:</b>	45250	<b>Date:</b>	4/28/17
------------	-------	--------------	---------

Frequency (MHz)	99% Bandwidth (kHz)	20dB Bandwidth (kHz)
13.56	211.87	250.00

### 99% Bandwidth

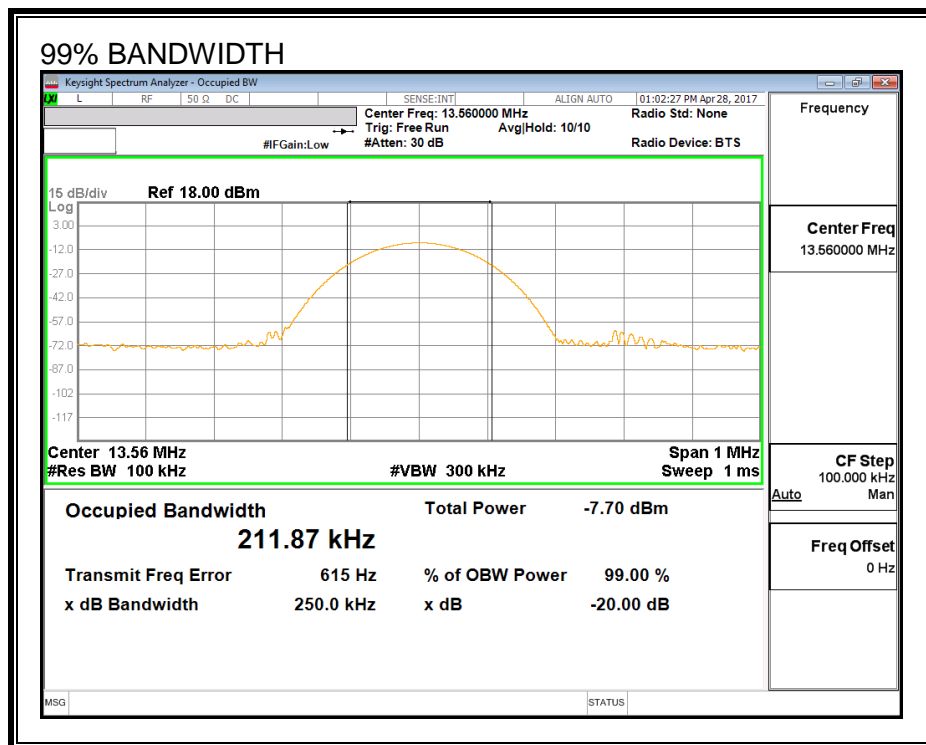

## 8. RADIATED EMISSION TEST RESULTS

### 8.1. LIMITS AND PROCEDURE

#### LIMIT

§15.225, 15.209

IC RSS-210, Annex B.6 (Transmitter)

IC RSS-GEN, Section 7.1.2 (Receiver)

(a) The field strength of any emissions within the band 13.553–13.567 MHz shall not exceed 15,848 microvolts/ meter at 30 meters.

(b) Within the bands 13.410–13.553 MHz and 13.567–13.710 MHz, the field strength of any emissions shall not exceed 334 microvolts/meter at 30 meters.

(c) Within the bands 13.110–13.410 MHz and 13.710–14.010 MHz the field strength of any emissions shall not exceed 106 microvolts/meter at 30 meters.

(d) The field strength of any emissions appearing outside of the 13.110– 14.010 MHz and shall not exceed the general radiated emission limits in § 15.209 as follows:

§15.209 (a) Except as provided elsewhere in this subpart, the emissions from an intentional radiator shall not exceed the field strength levels specified in the following table:

Limits for radiated disturbance of an intentional radiator		
Frequency range (MHz)	Limits (µV/m)	Measurement Distance (m)
0.009 – 0.490	2400 / F (kHz)	300
0.490 – 1.705	24000 / F (kHz)	30
1.705 – 30.0	30	30
30 – 88	100**	3
88 - 216	150**	3
216 – 960	200**	3
Above 960	500	3

\*\* Except as provided in paragraph (g), fundamental emissions from intentional radiators operating under this section shall not be located in the frequency bands 54-72 MHz, 76-88 MHz, 174-216 MHz or 470-806 MHz. However, operation within these frequency bands is permitted under other sections of this part, e.g. §§ 15.231 and 15.241.

§15.209 (b) In the emission table above, the tighter limit applies at the band edges.

Formula for converting the field strength from uV/m to dBuV/m is:

Limit (dBuV/m) = 20 log limit (uV/m)

§15.209 (d) The emission limits shown at the above table are based on measurements employing a CISPR quasi-peak detector except for the frequency bands 9-90 kHz, 110-490 kHz and above 1000 MHz. Radiated emissions limits in these three bands are based on measurements employing an average detector.

§15.209 (d) The provisions in §§ 15.225, measuring emissions at distances other than the distances specified in the above table, determining the frequency range over which radiated emissions are to be measured, and limiting peak emissions apply to all devices operated under this part.

## **TEST PROCEDURE**

ANSI C63.10-2013

The EUT is an intentional radiator that incorporates a digital device. The highest fundamental frequency generated or used in the device is 13.56 MHz. The frequency range was investigated from 0.15 MHz to the 10th harmonic of the highest fundamental frequency, or 1000 MHz, whichever is greater (1000MHz)

## **RESULTS**

No non-compliance noted:

## **KDB 414788 OATS and Chamber Correlation Justification**

Base on FCC 15.31 (f) (2): measurements may be performed at a distance closer than that specified in the regulations; however, an attempt should be made to avoid making measurements in the near field.

OATs and chamber correlation testing had been performed and chamber measured test result is the worst case test result.

### 8.1.1. FUNDAMENTAL EMISSION MASK (11.56 – 15.56MHz)

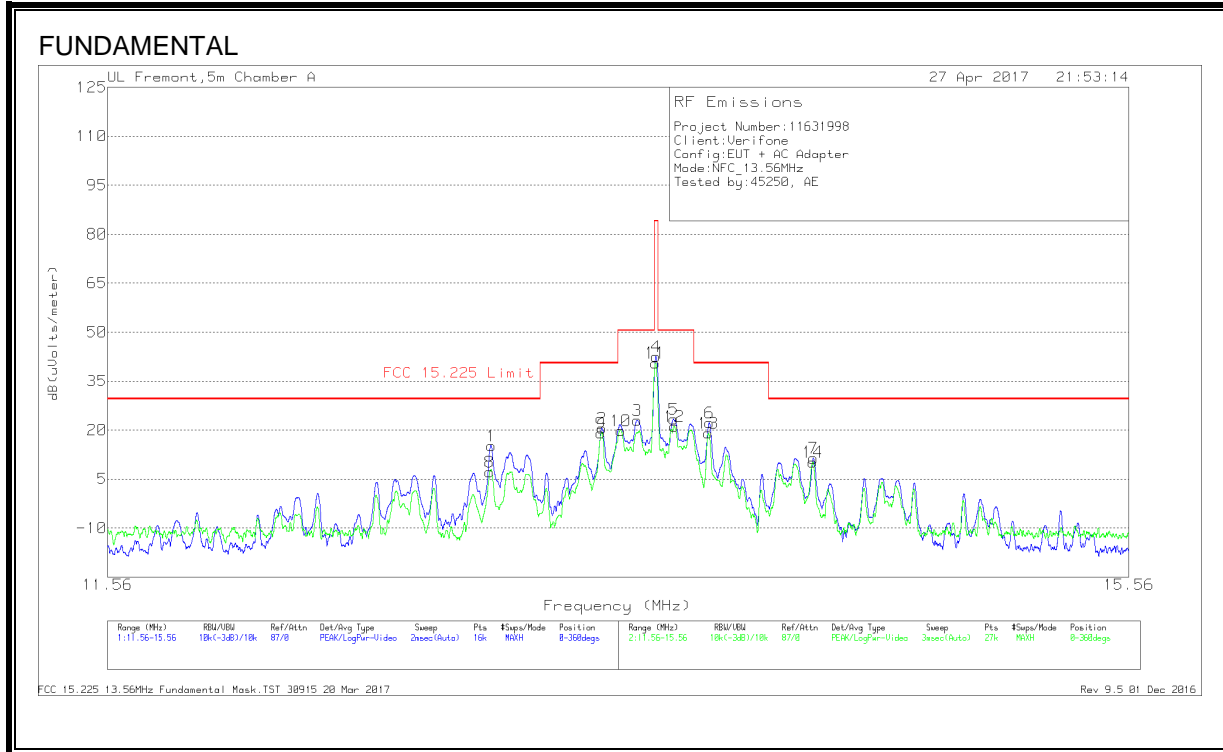

Trace Markers

Marker	Frequency (MHz)	Meter Reading (dBuV)	Det	Loop Antenna (dB/m)	Cbl (dB)	Dist Corr 30m	Corrected Reading dB(uVolts/meter)	FCC 15.225 Limit	PK Margin (dB)	Azimuth (Degs)
8	12.91997	36.18	Pk	10.4	.6	-40	7.18	29.54	-22.36	0-360
1	12.925	44.21	Pk	10.4	.6	-40	15.21	29.54	-14.33	0-360
9	13.34473	48.07	Pk	10.4	.6	-40	19.07	40.51	-21.44	0-360
2	13.34863	49.6	Pk	10.4	.6	-40	20.6	40.51	-19.91	0-360
10	13.42251	48.79	Pk	10.4	.6	-40	19.79	50.5	-30.71	0-360
3	13.48588	51.95	Pk	10.4	.6	-40	22.95	50.5	-27.55	0-360
11	13.55822	69.59	Pk	10.4	.6	-40	40.59	84	-43.41	0-360
4	13.56013	71.63	Pk	10.4	.6	-40	42.63	84	-41.37	0-360
5	13.62913	52.32	Pk	10.4	.6	-40	23.32	50.5	-27.18	0-360
12	13.63163	50.18	Pk	10.4	.6	-40	21.18	50.5	-29.32	0-360
13	13.76897	48.2	Pk	10.3	.5	-40	19	40.51	-21.51	0-360
6	13.77188	51.41	Pk	10.3	.5	-40	22.21	40.51	-18.3	0-360
14	14.19262	39.43	Pk	10.3	.5	-40	10.23	29.54	-19.31	0-360
7	14.19538	40.56	Pk	10.3	.5	-40	11.36	29.54	-18.18	0-360

Pk - Peak detector

Fundamental Frequency

Frequency (MHz)	Meter Reading (dBuV)	Det	Loop Antenna (dB/m)	Cbl (dB)	Dist Corr 30m	Corrected Reading dB(uVolts/meter)	FCC 15.225 Limit	PK Margin (dB)	Azimuth (Degs)	Antenna Position
13.56	71.92	Pk	10.4	.6	-40	42.92	84	-41.08	32	Face on
13.5601	69.63	Pk	10.4	.6	-40	40.63	84	-43.37	98	Face off

Pk - Peak detector



### 8.1.2. SPURIOUS EMISSIONS (0.09 – 30MHz)

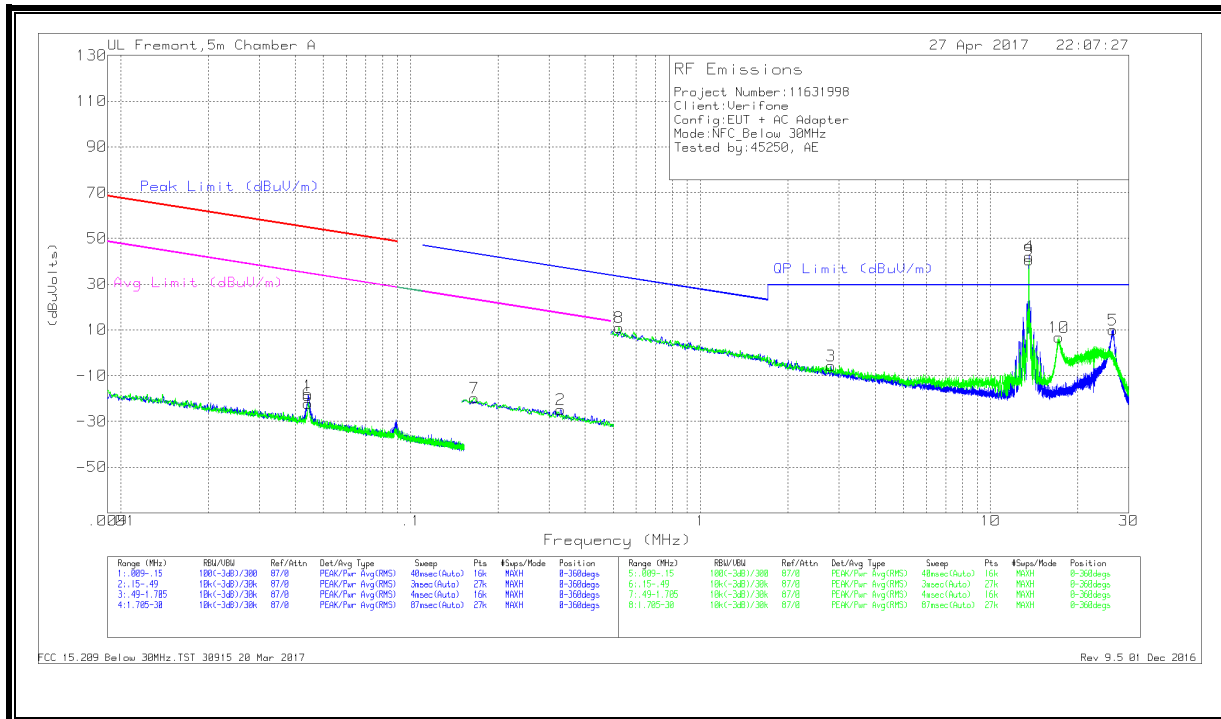

#### Trace Markers

Marker	Frequency (MHz)	Meter Reading (dBuV)	Det	Loop Antenna (dB/m)	Cbl (dB)	Dist Corr 300m	Corrected Reading (dBuVolts)	Peak Limit (dBuV/m)	Margin (dB)	Avg Limit (dBuV/m)	Margin (dB)	Peak Limit (dBuV/m)	Margin (dB)	Avg Limit (dBuV/m)	Margin (dB)	Azimuth (Degs)
1	.04417	48.26	Pk	13	.1	-80	-18.64	54.68	-73.32	34.68	-53.32	-	-	-	-	0-360
6	.04424	44.75	Pk	13	.1	-80	-22.15	54.67	-76.82	34.67	-56.82	-	-	-	-	0-360
7	.16558	48.39	Pk	11.6	.1	-80	-19.91	-	-	-	-	43.24	-63.15	23.24	-43.15	0-360
2	.32908	43.54	Pk	11.5	.1	-80	-24.86	-	-	-	-	37.26	-62.12	17.26	-42.12	0-360

#### Pk - Peak detector

Marker	Frequency (MHz)	Meter Reading (dBuV)	Det	Loop Antenna (dB/m)	Cbl (dB)	Dist Corr 30m	Corrected Reading (dBuVolts)	Peak Limit (dBuV/m)	Margin (dB)	Avg Limit (dBuV/m)	Margin (dB)	QP Limit (dBuV/m)	Margin (dB)	Azimuth (Degs)
8	.52317	39.5	Pk	11.5	.1	-40	11.1	-	-	-	-	33.23	-22.13	0-360
3	2.8206	22.15	Pk	11.7	.3	-40	-5.85	-	-	-	-	29.5	-35.35	0-360
9	*13.55998	69.6	Pk	10.4	.6	-40	40.6	-	-	-	-	-	-	0-360
4	*13.56207	71.04	Pk	10.4	.6	-40	42.04	-	-	-	-	-	-	0-360
10	17.19339	36.2	Pk	10	.6	-40	6.8	-	-	-	-	29.5	-22.7	0-360
5	26.46243	40.66	Pk	8.6	.8	-40	10.06	-	-	-	-	29.5	-19.44	0-360

\*Note: Fundamental Frequency

Pk - Peak detector

### 8.1.3. TX SPURIOUS EMISSIONS (30 – 1000MHz)

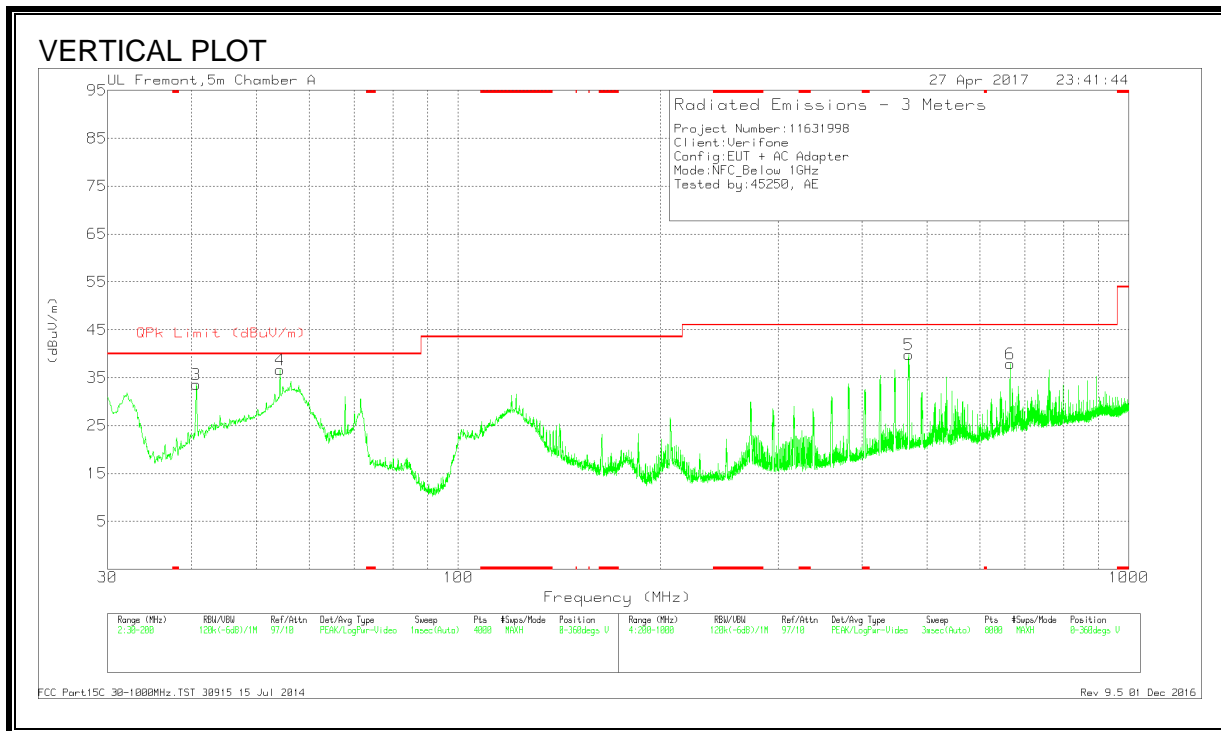
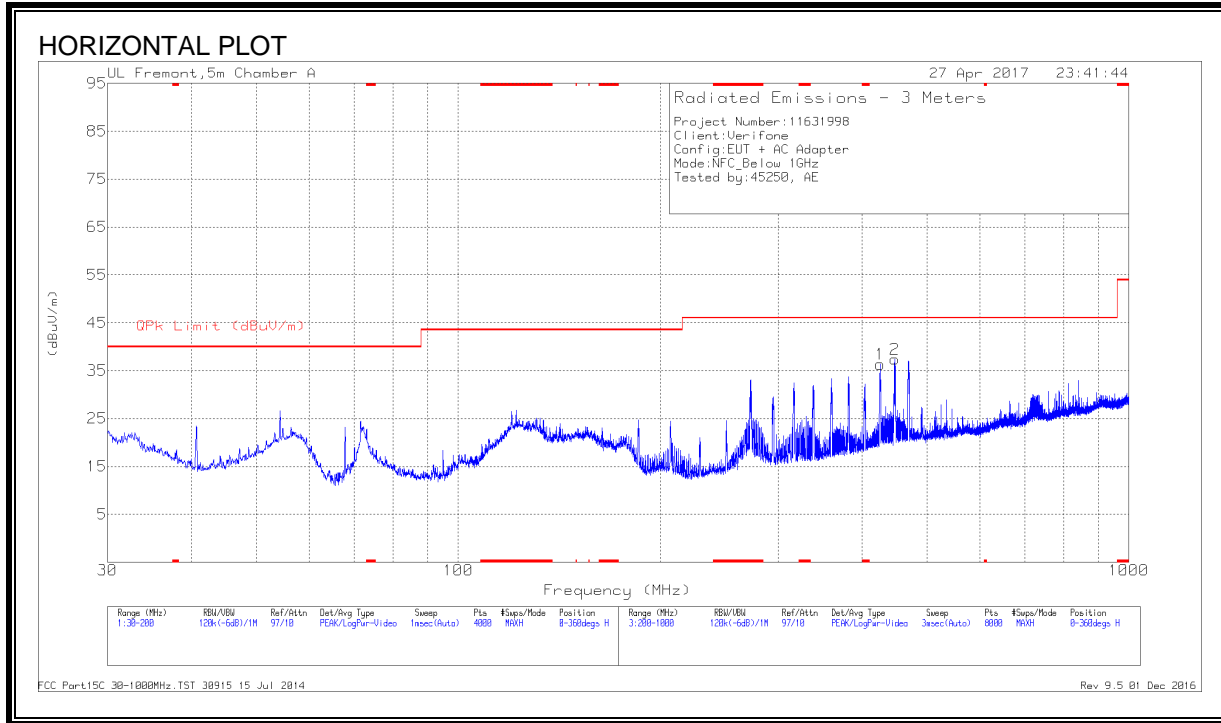

Trace Markers

Marker	Frequency (MHz)	Meter Reading (dBuV)	Det	AF T130 (dB/m)	Amp/Cbl (dB/m)	Corrected Reading (dBuV/m)	QPk Limit (dBuV/m)	Margin (dB)	Azimuth (Degs)	Height (cm)	Polarity
3	40.6703	47.12	Pk	17.6	-31.1	33.62	40	-6.38	0-360	100	V
4	54.2313	56.54	Pk	11.1	-31	36.64	40	-3.36	0-360	100	V
1	425.9294	44.73	Pk	20.5	-28.9	36.33	46.02	-9.69	0-360	101	H
2	447.8322	45.5	Pk	20.8	-28.9	37.4	46.02	-8.62	0-360	101	H
5	469.435	47.19	Pk	21.3	-28.7	39.79	46.02	-6.23	0-360	101	V
6	665.0605	42.65	Pk	23.7	-28.4	37.95	46.02	-8.07	0-360	101	V

Pk - Peak detector

Radiated Emissions

Frequency (MHz)	Meter Reading (dBuV)	Det	AF T130 (dB/m)	Amp/Cbl (dB/m)	Corrected Reading (dBuV/m)	QPk Limit (dBuV/m)	Margin (dB)	Azimuth (Degs)	Height (cm)	Polarity
54.2342	54.98	Qp	11.1	-31	35.08	40	-4.92	103	103	V

Qp - Quasi-Peak detector

## 9. AC MAINS LINE CONDUCTED EMISSIONS

### LIMITS

§15.207

IC RSS-GEN, Section 7.2.2

(a) Except as shown in paragraphs (b) and (c) of this section, for an intentional radiator that is designed to be connected to the public utility (AC) power line, the radio frequency voltage that is conducted back onto the AC power line on any frequency or frequencies, within the band 150 kHz to 30 MHz, shall not exceed the limits in the following table, as measured using a 50 $\mu$ H/50 ohms line impedance stabilization network (LISN). Compliance with the provisions of this paragraph shall be based on the measurement of the radio frequency voltage between each power line and ground at the power terminal. The lower limit applies at the band edges.

Frequency range (MHz)	Limits (dB $\mu$ V)	
	Quasi-peak	Average
0.15 to 0.50	66 to 56	56 to 46
0.50 to 5	56	46
5 to 30	60	50

Notes:  
1. The lower limit shall apply at the transition frequencies  
2. The limit decreases linearly with the logarithm of the frequency in the range 0.15 MHz to 0.50 MHz.

### TEST PROCEDURE

The EUT is placed on a non-conducting table 40 cm from the vertical ground plane and 80 cm above the horizontal ground plane. The EUT is configured in accordance with ANSI C63.10.

The receiver is set to a resolution bandwidth of 9 kHz. Peak detection is used unless otherwise noted as quasi-peak or average.

Line conducted data is recorded for both Line 1 (HOT) and Line 2 (NEUTRAL).

### RESULTS

No non-compliance noted.

**EUT WITH ANTENNA**

**LINE 1 RESULTS**

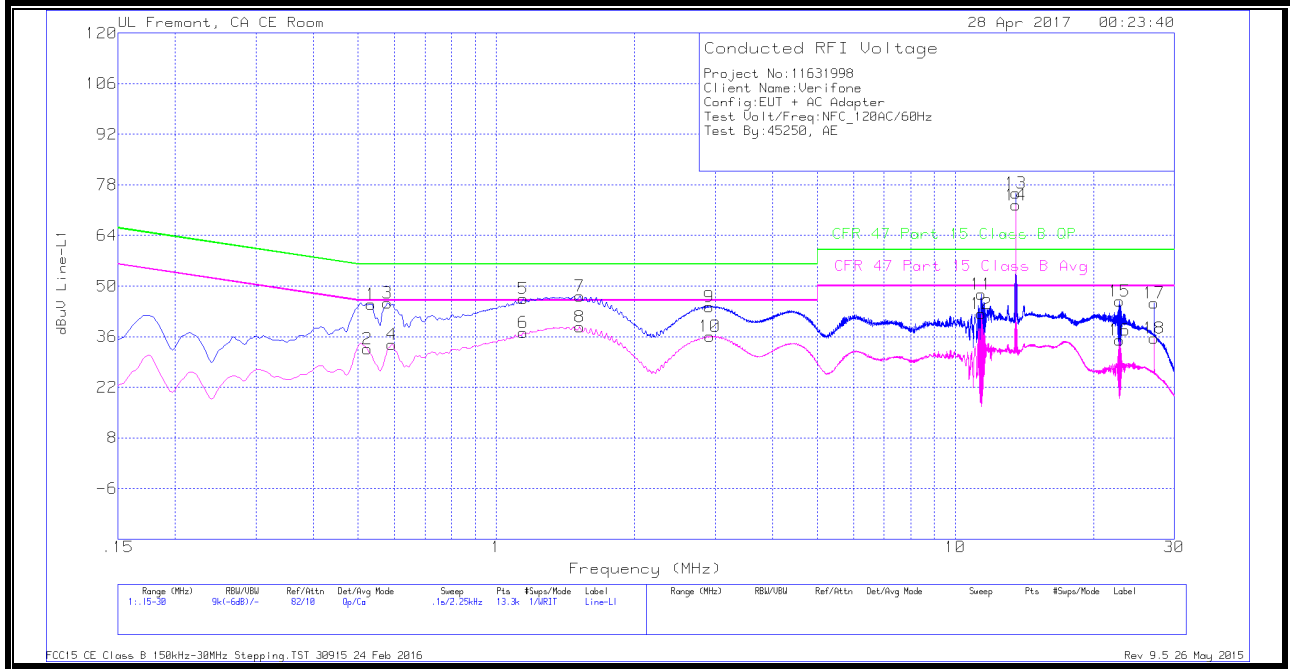

**WORST EMISSIONS**

Range 1: Line-L1 .15 - 30MHz												
Marker	Frequency (MHz)	Meter Reading (dBuV)	Det	LISN L1	LC Cables C1&C3	Limiter (dB)	Corrected Reading dBuV	CFR 47 Part 15 Class B QP	QP Margin (dB)	CFR 47 Part 15 Class B Avg	Av(CISPR) Margin (dB)	
1	.53475	34.82	Qp	0	.1	10.1	45.02	56	-10.98	-	-	
2	.5235	22.47	Ca	0	.1	10.1	32.67	-	-	46	-13.33	
3	.57975	35.11	Qp	0	.1	10.1	45.31	56	-10.69	-	-	
4	.59325	23.62	Ca	0	.1	10.1	33.82	-	-	46	-12.18	
5	1.14675	36.35	Qp	0	.1	10.1	46.55	56	-9.45	-	-	
6	1.1445	26.86	Ca	0	.1	10.1	37.06	-	-	46	-8.94	
7	1.5225	37.04	Qp	0	.1	10.1	47.24	56	-8.76	-	-	
8	1.52025	28.49	Ca	0	.1	10.1	38.69	-	-	46	-7.31	
9	2.90625	34.1	Qp	0	.1	10.1	44.3	56	-11.7	-	-	
10	2.9175	25.85	Ca	0	.1	10.1	36.05	-	-	46	-9.95	
11	11.40225	37.39	Qp	0	.2	10.2	47.79	60	-12.21	-	-	
12	11.40225	31.95	Ca	0	.2	10.2	42.35	-	-	50	-7.65	
13	*13.56	65.16	Qp	.1	.2	10.2	75.66	-	-	-	-	
14	*13.56	61.98	Ca	.1	.2	10.2	72.48	-	-	-	-	
15	22.76025	35.03	Qp	.1	.3	10.4	45.83	60	-14.17	-	-	
16	22.803	24.28	Ca	.1	.3	10.4	35.08	-	-	50	-14.92	
17	27.12075	34.33	Qp	.1	.3	10.5	45.23	60	-14.77	-	-	
18	27.12075	24.65	Ca	.1	.3	10.5	35.55	-	-	50	-14.45	

\* - *indicates fundamental frequency*

Qp - Quasi-Peak detector

Ca - CISPR average detection

Note: Markers 13 and 14 are the 13.56MHz NFC Fundamental

**LINE 2 RESULTS**

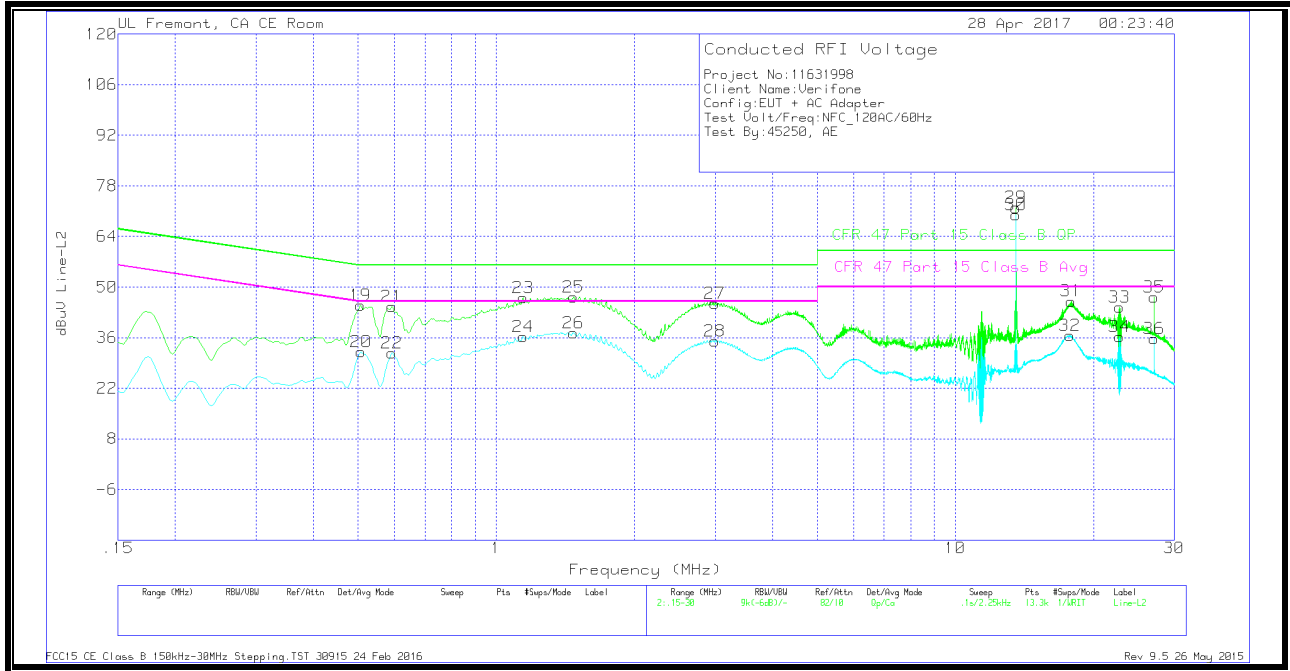

**WORST EMISSIONS**

Range 2: Line-L2 .15 - 30MHz												
Marker	Frequency (MHz)	Meter Reading (dBuV)	Det	LISN L2	LC Cables C2&C3	Limiter (dB)	Corrected Reading dBuV	CFR 47 Part 15 Class B QP	QP Margin (dB)	CFR 47 Part 15 Class B Avg	Av(CISPR) Margin (dB)	
19	.5055	34.73	Qp	0	.1	10.1	44.93	56	-11.07	-	-	
20	.50775	21.85	Ca	0	.1	10.1	32.05	-	-	46	-13.95	
21	.59325	34.46	Qp	0	.1	10.1	44.66	56	-11.34	-	-	
22	.59325	21.56	Ca	0	.1	10.1	31.76	-	-	46	-14.24	
23	1.1445	36.83	Qp	0	.1	10.1	47.03	56	-8.97	-	-	
24	1.1445	26.13	Ca	0	.1	10.1	36.33	-	-	46	-9.67	
25	1.47525	36.98	Qp	0	.1	10.1	47.18	56	-8.82	-	-	
26	1.47413	27.15	Ca	0	.1	10.1	37.35	-	-	46	-8.65	
27	2.99175	35.21	Qp	0	.1	10.1	45.41	56	-10.59	-	-	
28	2.994	24.86	Ca	0	.1	10.1	35.06	-	-	46	-10.94	
29	*13.56	61.49	Qp	.1	.2	10.2	71.99	-	-	-	-	
30	*13.56	59.51	Ca	.1	.2	10.2	70.01	-	-	-	-	
31	17.87775	35.49	Qp	0	.3	10.3	46.09	60	-13.91	-	-	
32	17.75175	26.06	Ca	0	.3	10.3	36.66	-	-	50	-13.34	
33	22.794	33.76	Qp	0	.3	10.4	44.46	60	-15.54	-	-	
34	22.794	25.62	Ca	0	.3	10.4	36.32	-	-	50	-13.68	
35	27.12075	36.27	Qp	.1	.3	10.5	47.17	60	-12.83	-	-	
36	27.12075	24.92	Ca	.1	.3	10.5	35.82	-	-	50	-14.18	

\* - indicates fundamental frequency

Qp - Quasi-Peak detector

Ca - CISPR average detection

Note: Markers 29 and 30 are the 13.56MHz NFC Fundamental



**EUT WITH TERMINATOR AT ANTENNA PORT**

**LINE 1 RESULTS**

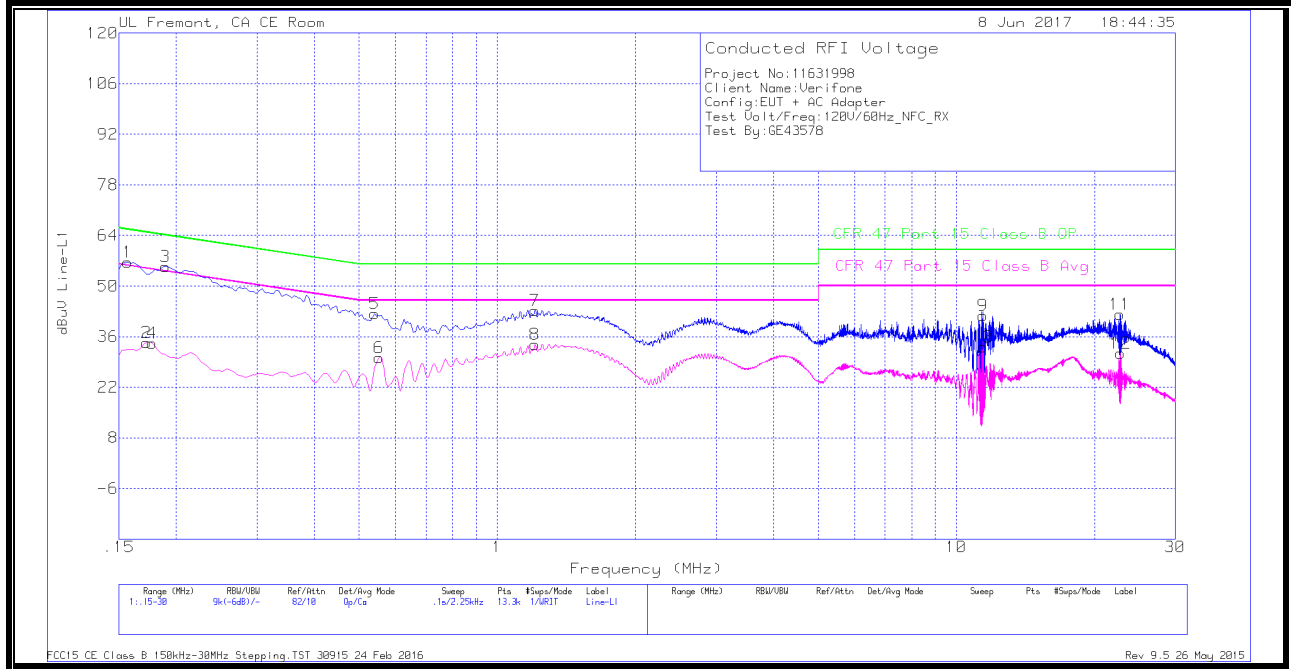

**WORST EMISSIONS**

Range 1: Line-L1 .15 - 30MHz												
Marker	Frequency (MHz)	Meter Reading (dBuV)	Det	LISN L1	LC Cables C1&C3	Limiter (dB)	Corrected Reading dBuV	CFR 47 Part 15 Class B QP	QP Margin (dB)	CFR 47 Part 15 Class B Avg	Av(CISPR) Margin (dB)	
1	.15675	46.42	Qp	0	.1	10.1	56.62	65.63	-9.01	-	-	
2	.1725	24.11	Ca	0	.1	10.1	34.31	-	-	54.84	-20.53	
3	.18938	45.24	Qp	0	.1	10.1	55.44	64.06	-8.62	-	-	
4	.177	23.97	Ca	0	.1	10.1	34.17	-	-	54.63	-20.46	
5	.5415	32.13	Qp	0	.1	10.1	42.33	56	-13.67	-	-	
6	.55275	20.04	Ca	0	.1	10.1	30.24	-	-	46	-15.76	
7	1.20975	33.06	Qp	0	.1	10.1	43.26	56	-12.74	-	-	
8	1.20975	23.61	Ca	0	.1	10.1	33.81	-	-	46	-12.19	
9	11.418	31.43	Qp	0	.2	10.2	41.83	60	-18.17	-	-	
10	11.418	22.72	Ca	0	.2	10.2	33.12	-	-	50	-16.88	
11	22.74225	31.41	Qp	.1	.3	10.4	42.21	60	-17.79	-	-	
12	22.78725	20.6	Ca	.1	.3	10.4	31.4	-	-	50	-18.6	

\* - *indicates fundamental frequency*

Qp - Quasi-Peak detector

Ca - CISPR average detection

Note: Markers 13 and 14 are the 13.56MHz NFC Fundamental

**LINE 2 RESULTS**

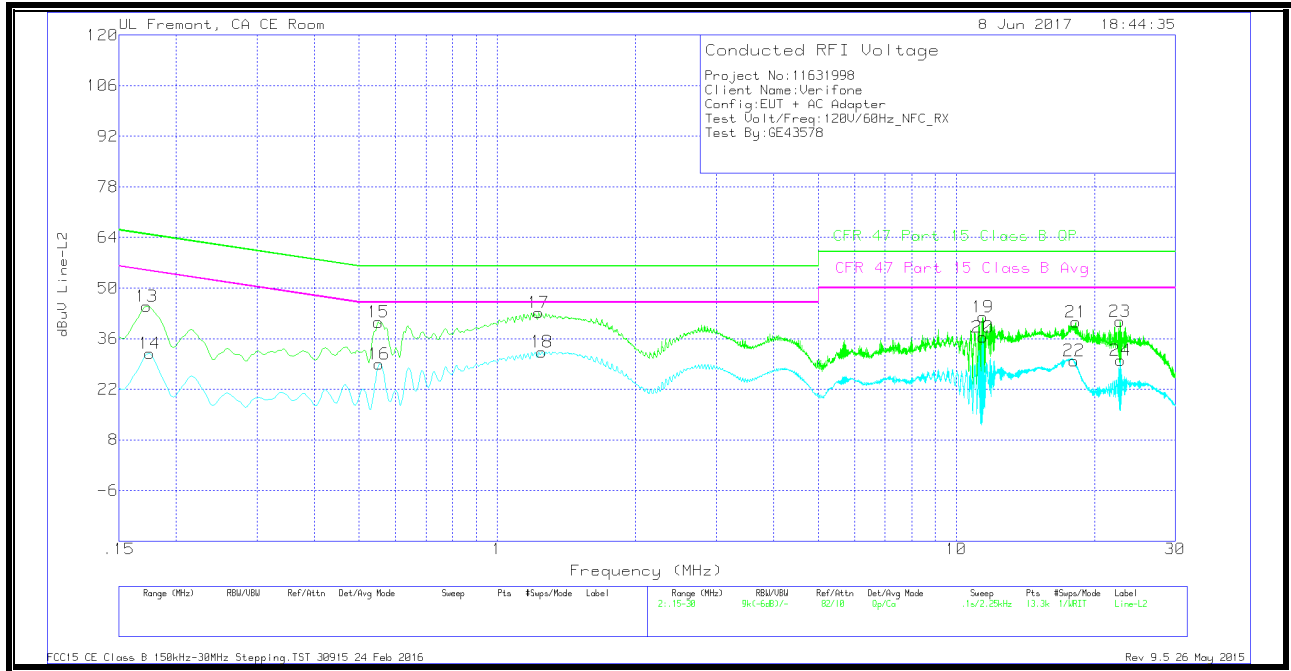

**WORST EMISSIONS**

Range 2: Line-L2 .15 - 30MHz												
Marker	Frequency (MHz)	Meter Reading (dBuV)	Det	LISN L2	LC Cables C2&C3	Limiter (dB)	Corrected Reading dBuV	CFR 47 Part 15 Class B QP	QP Margin (dB)	CFR 47 Part 15 Class B Avg	Av(CISPR) Margin (dB)	
13	.1725	34.74	Qp	0	.1	10.1	44.94	64.84	-19.9	-	-	
14	.17475	21.78	Ca	0	.1	10.1	31.98	-	-	54.73	-22.75	
15	.5505	30.33	Qp	0	.1	10.1	40.53	56	-15.47	-	-	
16	.55275	18.71	Ca	0	.1	10.1	28.91	-	-	46	-17.09	
17	1.23225	32.97	Qp	0	.1	10.1	43.17	56	-12.83	-	-	
18	1.2525	22.15	Ca	0	.1	10.1	32.35	-	-	46	-13.65	
19	11.4135	31.58	Qp	0	.2	10.2	41.98	60	-18.02	-	-	
20	11.4135	26.05	Ca	0	.2	10.2	36.45	-	-	50	-13.55	
21	18.1995	30.09	Qp	0	.3	10.3	40.69	60	-19.31	-	-	
22	18.03975	19.32	Ca	0	.3	10.3	29.92	-	-	50	-20.08	
23	22.73775	30.15	Qp	0	.3	10.4	40.85	60	-19.15	-	-	
24	22.78275	19.3	Ca	0	.3	10.4	30	-	-	50	-20	

\* - **indicates fundamental frequency**

Qp - Quasi-Peak detector

Ca - CISPR average detection

Note: Markers 29 and 30 are the 13.56MHz NFC Fundamental

## 10. FREQUENCY STABILITY

### LIMIT

§15.225 (e) The frequency tolerance of the carrier signal shall be maintained within  $\pm 0.01\%$  of the operating frequency, over a temperature variation of 0 degrees to +50 degrees C at normal supply voltage, and for a variation in the primary supply voltage from 85% to 115% of the rated supply voltage at a temperature of 20 degrees C. For battery operated equipment, the equipment tests shall be performed using a new battery.

### TEST PROCEDURE

ANSI C63.10

### RESULTS

<b>ID:</b>	43578	<b>Date:</b>	4/29/2017
------------	-------	--------------	-----------

Reference Frequency: EUT Channel 13.56 MHz @ 20°C Limit: $\pm 100$ ppm = 1.356 kHz										
Power Supply	Envir. Temp	Frequency Deviation Measured with Time Elapse								
(Vdc)	(°C)	Startup (MHz)	Delta (ppm)	@ 2 mins (MHz)	Delta (ppm)	@ 5 mins (MHz)	Delta (ppm)	@ 10 mins (MHz)	Delta (ppm)	Limit (ppm)
3.70	50	13.5600321	-0.391	13.5600331	-0.465	13.5600371	-0.760	13.5600394	-0.929	$\pm 100$
3.70	40	13.5600268	0.000	13.5600264	0.029	13.5600260	0.059	13.5600263	0.037	$\pm 100$
3.70	30	13.5600295	-0.199	13.5600291	-0.170	13.5600284	-0.118	13.5600279	-0.081	$\pm 100$
<b>3.70</b>	<b>20</b>	<b>13.5600268</b>	<b>0.000</b>	<b>13.5600262</b>	<b>0.044</b>	<b>13.5600285</b>	<b>-0.125</b>	<b>13.5600314</b>	<b>-0.339</b>	<b><math>\pm 100</math></b>
3.70	10	13.5600945	-4.993	13.5600926	-4.853	13.5600880	-4.513	13.5600821	-4.078	$\pm 100$
3.70	0	13.5601117	-6.261	13.5601111	-6.217	13.5601100	-6.136	13.5601089	-6.055	$\pm 100$
3.15	20	13.5600215	0.392	13.5600221	0.345	13.5600202	0.487	13.5600191	0.568	$\pm 100$
4.255	20	13.5600187	0.597	13.5600183	0.627	13.5600133	0.996	13.5600099	1.246	$\pm 100$