



# CERTIFICATION TEST REPORT

**Report Number. :** 11616858-E2V5

**Applicant :** Verifone, Inc.  
1400 West Stanford Ranch Road  
Rocklin, CA 95765, U.S.A.

**Model :** V200t Plus 3G/D/E

**FCC ID :** B32V200TPLUS

**IC :** 787C-V200TPLUS

**EUT Description :** Point of Sale Terminal

**Test Standard(s) :** FCC 47 CFR PART 15 SUBPART C  
INDUSTRY CANADA RSS - 247 ISSUE 2  
INDUSTRY CANADA RSS-GEN ISSUE 4

**Date Of Issue:**

April 03, 2018

**Prepared by:**

UL Verification Services Inc.  
47173 Benicia Street  
Fremont, CA 94538, U.S.A.  
TEL: (510) 771-1000  
FAX: (510) 661-0888



Revision History

<u>Rev.</u>	<u>Issue Date</u>	<u>Revisions</u>	<u>Revised By</u>
V1	12/07/17	Initial Issue	--
V2	01/30/18	Revised Test Methodology section. Revised Description of EUT section. Revised Scope of Testing section.	Frank Ibrahim
V3	02/26/18	Revised antenna gain section	Frank Ibrahim
V4	03/02/18	Revised Test Methodology section.	Frank Ibrahim
V5	04/03/18	Revised Scope of Testing section	Glenn Escano

## TABLE OF CONTENTS

<b>1. ATTESTATION OF TEST RESULTS .....</b>	<b>4</b>
<b>2. TEST METHODOLOGY .....</b>	<b>5</b>
<b>3. FACILITIES AND ACCREDITATION .....</b>	<b>5</b>
<b>4. CALIBRATION AND UNCERTAINTY .....</b>	<b>5</b>
4.1. <i>MEASURING INSTRUMENT CALIBRATION .....</i>	<i>5</i>
4.2. <i>SAMPLE CALCULATION .....</i>	<i>5</i>
4.3. <i>MEASUREMENT UNCERTAINTY.....</i>	<i>6</i>
<b>5. EQUIPMENT UNDER TEST .....</b>	<b>7</b>
5.1. <i>DESCRIPTION OF EUT .....</i>	<i>7</i>
5.2. <i>SCOPE OF TESTING.....</i>	<i>7</i>
5.3. <i>DESCRIPTION OF AVAILABLE ANTENNAS .....</i>	<i>7</i>
5.4. <i>SOFTWARE AND FIRMWARE.....</i>	<i>7</i>
5.5. <i>WORST-CASE CONFIGURATION AND MODE.....</i>	<i>7</i>
5.6. <i>DESCRIPTION OF TEST SETUP.....</i>	<i>9</i>
<b>6. TEST AND MEASUREMENT EQUIPMENT .....</b>	<b>11</b>
<b>7. RADIATED TEST RESULTS.....</b>	<b>12</b>
7.1. <i>ON TIME AND DUTY CYCLE.....</i>	<i>12</i>
7.2. <i>LIMITS AND PROCEDURE.....</i>	<i>13</i>
7.3. <i>WORST-CASE BELOW 30 MHz.....</i>	<i>14</i>
7.4. <i>WORST-CASE BELOW 1 GHz.....</i>	<i>16</i>
7.5. <i>TRANSMITTER ABOVE 1 GHz.....</i>	<i>18</i>
7.5.1. <i>BASIC DATA RATE GFSK MODULATION.....</i>	<i>18</i>
7.5.2. <i>ENHANCED DATA RATE 8PSK MODULATION .....</i>	<i>28</i>
7.6. <i>WORST-CASE ABOVE 18 GHz .....</i>	<i>38</i>
<b>8. SETUP PHOTOS.....</b>	<b>40</b>

## 1. ATTESTATION OF TEST RESULTS

**COMPANY NAME:** Verifone, Inc.  
1400 West Stanford Ranch Road Suite 200  
Rocklin, CA 95765, U.S.A.

**EUT DESCRIPTION:** Point of Sale Terminal

**MODEL:** V200t Plus 3G/D/E

**SERIAL NUMBER:** 401-431-539

**DATE TESTED:** November 27 – 28, 2017

APPLICABLE STANDARDS	
STANDARD	TEST RESULTS
FCC 47 CFR 47 PART 15 SUBPART C	Pass
INDUSTRY CANADA RSS-247 ISSUE 2	Pass
INDUSTRY CANADA RSS-GEN ISSUE 4	Pass

UL Verification Services Inc. tested the above equipment in accordance with the requirements set forth in the above standards. All indications of Pass/Fail in this report are opinions expressed by UL Verification Services Inc. based on interpretations and/or observations of test results. Measurement Uncertainties were not taken into account and are published for informational purposes only. The test results show that the equipment tested is capable of demonstrating compliance with the requirements as documented in this report.

**Note:** The results documented in this report apply only to the tested sample, under the conditions and modes of operation as described herein. This document may not be altered or revised in any way unless done so by UL Verification Services Inc. and all revisions are duly noted in the revisions section. Any alteration of this document not carried out by UL Verification Services Inc. will constitute fraud and shall nullify the document. This report must not be used by the client to claim product certification, approval, or endorsement by NVLAP, NIST, any agency of the Federal Government, or any agency of any government.

Approved & Released For  
UL Verification Services Inc. By:

Prepared By:



FRANK IBRAHIM  
CONSUMER TECHNOLOGY DIVISION  
OPERATIONS LEADER  
UL VERIFICATION SERVICES INC



GLENN ESCANO  
CONSUMER TECHNOLOGY DIVISION  
TEST ENGINEER  
UL VERIFICATION SERVICES INC

## 2. TEST METHODOLOGY

The tests documented in this report were performed in accordance with FCC CFR 47 Part 2, FCC CFR 47 Part 15, KDB 558074 D01 v04, ANSI C63.10-2013, IC RSS-GEN Issue 4, and IC RSS-247 ISSUE 2.

## 3. FACILITIES AND ACCREDITATION

The test sites and measurement facilities used to collect data are located at 47173 and 47266 Benicia Street, Fremont, California, USA. Line conducted emissions are measured only at the 47173 address. The following table identifies which facilities were utilized for radiated emission measurements documented in this report. Specific facilities are also identified in the test results sections.

47173 Benicia Street		47266 Benicia Street	
<input type="checkbox"/>	Chamber A (IC:2324B-1)	<input type="checkbox"/>	Chamber D (IC:22541-1)
<input checked="" type="checkbox"/>	Chamber B (IC:2324B-2)	<input type="checkbox"/>	Chamber E (IC:22541-2)
<input type="checkbox"/>	Chamber C (IC:2324B-3)	<input type="checkbox"/>	Chamber F (IC:22541-3)
		<input type="checkbox"/>	Chamber G (IC:22541-4)
		<input type="checkbox"/>	Chamber H (IC:22541-5)

The above test sites and facilities are covered under FCC Test Firm Registration # 208313. UL Verification Services Inc. is accredited by NVLAP, Laboratory Code 200065-0.

Chambers A through C are covered under Industry Canada company address code 2324B with site numbers 2324B -1 through 2324B-3, respectively and Chambers D through H are covered under Industry Canada company address code 22541 with site numbers 22541 -1 through 22541-5, respectively.

## 4. CALIBRATION AND UNCERTAINTY

### 4.1. MEASURING INSTRUMENT CALIBRATION

The measuring equipment utilized to perform the tests documented in this report has been calibrated in accordance with the manufacturer's recommendations, and is traceable to recognized national standards.

### 4.2. SAMPLE CALCULATION

Where relevant, the following sample calculation is provided:

$$\begin{aligned} \text{Field Strength (dBuV/m)} &= \text{Measured Voltage (dBuV)} + \text{Antenna Factor (dB/m)} + \\ &\text{Cable Loss (dB)} - \text{Preamp Gain (dB)} \\ 36.5 \text{ dBuV} + 18.7 \text{ dB/m} + 0.6 \text{ dB} - 26.9 \text{ dB} &= 28.9 \text{ dBuV/m} \end{aligned}$$

### 4.3. MEASUREMENT UNCERTAINTY

Where relevant, the following measurement uncertainty levels have been estimated for tests performed on the apparatus:

Parameter	Uncertainty
Worst Case Conducted Disturbance, 9KHz to 0.15 MHz	3.84 dB
Worst Case Conducted Disturbance, 0.15 to 30 MHz	3.65 dB
Worst Case Radiated Disturbance, 9KHz to 30 MHz	3.15 dB
Worst Case Radiated Disturbance, 30 to 1000 MHz	5.36 dB
Worst Case Radiated Disturbance, 1000 to 18000 MHz	4.32 dB
Worst Case Radiated Disturbance, 18000 to 26000 MHz	4.45 dB
Worst Case Radiated Disturbance, 26000 to 40000 MHz	5.24 dB

Uncertainty figures are valid to a confidence level of 95%.

## 5. EQUIPMENT UNDER TEST

### 5.1. DESCRIPTION OF EUT

The EUT is a Mobile Point of Sale Terminal which supports the following technologies WLAN 2.4 GHz and 5 GHz, Bluetooth, GSM 850 / GSM 1900, WCDMA Band II / WCDMA Band V, and NFC.

### 5.2. SCOPE OF TESTING

This report covers radiated emissions portion. For antenna port data refer to report number 11631998-E1V1 (FCC ID: B32V240MPLUS, IC 787C-V240MPLUS) that covered model V240m Plus 3GBW as the Bluetooth radio module covered by this report is identical to the Bluetooth radio module of model V240m Plus 3GBW with same output power values. Output power was confirmed prior to making radiated spurious measurements.

### 5.3. DESCRIPTION OF AVAILABLE ANTENNAS

The radio utilizes a Chip Multilayer Antenna with the following gains:

Frequency Band (GHz)	Antenna Gain (dBi)
2402-2480	1.90

### 5.4. SOFTWARE AND FIRMWARE

The firmware installed in the EUT during testing was VOS2 30640XXX.

### 5.5. WORST-CASE CONFIGURATION AND MODE

Radiated emission below 1GHz, above 18GHz, and power line conducted emission were performed with the EUT was set to transmit at the channel with highest output power as worst-case scenario.

The fundamental of the EUT was investigated in three orthogonal orientations X, Y, & Z, and it was determined that X-Axis orientation was worst-case orientation; therefore, all final radiated testing was performed with the EUT in X-Axis orientation.

Worst-case data rates as provided by the client were:

GFSK: 1Mbps (1-DH5)  
8PSK: 3Mbps (3-DH5)





## 5.6. DESCRIPTION OF TEST SETUP

### SUPPORT EQUIPMENT

Support Equipment List			
Description	Manufacturer	Model	Serial Number
AC Adapter	Verifone	PSA18A-082A	5A00170801207

### I/O CABLES (RADIATED EMISSIONS)

I/O Cable List						
Cable No	Port	# of identical ports	Connector Type	Cable Type	Cable Length (m)	Remarks
1	DC	1	AC	Un-shielded	2	N/A

**TEST SETUP**

**RADIATED EMISSIONS SETUP DIAGRAM**

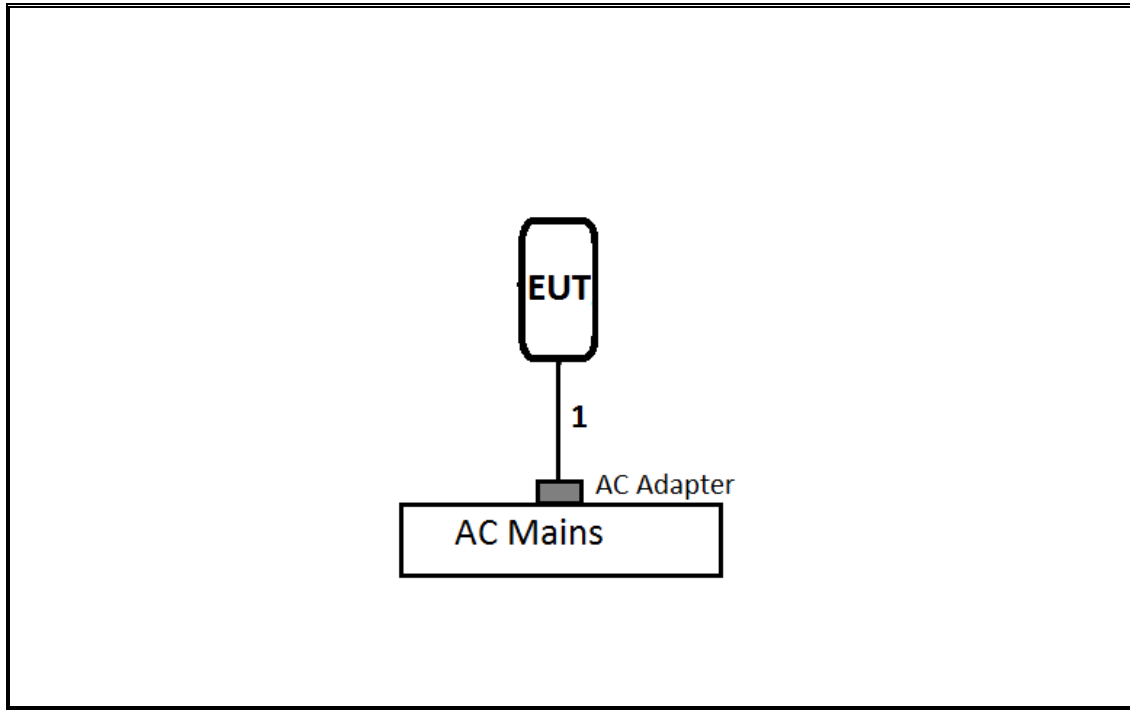

## 6. TEST AND MEASUREMENT EQUIPMENT

The following test and measurement equipment was utilized for the tests documented in this report.

TEST EQUIPMENT LIST				
Description	Manufacturer	Model	Asset	Cal Due
Antenna, Broadband Hybrid, 30MHz to 2000MHz w/4dB Pad	Sunol Sciences Corp.	JB3	T899	06/15/2018
Antenna, Active Loop 9kHz-30MHz	Com-Power Corp.	AL-130R	T1866	10/10/2018
Antenna, Horn 1-18GHz	ETS-Lindgren	3117	T863	06/09/2018
Antenna, Horn 18-26.5GHz	ARA	MWH-1826/B	T449	06/12/2018
Amplifier, 1-26.5GHz	MITEQ	AFS42-00101800-25-S-42	T1165	08/01/2018
Amplifier, 1-26.5GHz	Agilent (Keysight) Technologies	8449B	T404	06/12/2018
Amplifier, 10kHz-1GHz	HP	8447D	T10	02/15/2018
Amplifier, 1-8 GHz	MITEQ	AFS42-00101800-25-S-42	T931	08/26/2018
Spectrum Analyzer, PXA, 3Hz to 44GHz	Agilent (Keysight) Technologies	N9030A	T1454	12/15/2017
Spectrum Analyzer, PXA, 3Hz to 44GHz	Agilent (Keysight) Technologies	E9030A	T907	01/23/2018
Bluetooth Tester	Rohde & Schwarz	CBT	T258	07/25/2018

Test Software List			
Description	Manufacturer	Model	Version
Radiated Software	UL	UL EMC	Ver 9.5, Dec 01, 2016

## 7. RADIATED TEST RESULTS

### 7.1. ON TIME AND DUTY CYCLE

#### LIMITS

None; for reporting purposes only.

#### PROCEDURE

KDB 558074 Zero-Span Spectrum Analyzer Method.

#### ON TIME AND DUTY CYCLE RESULTS

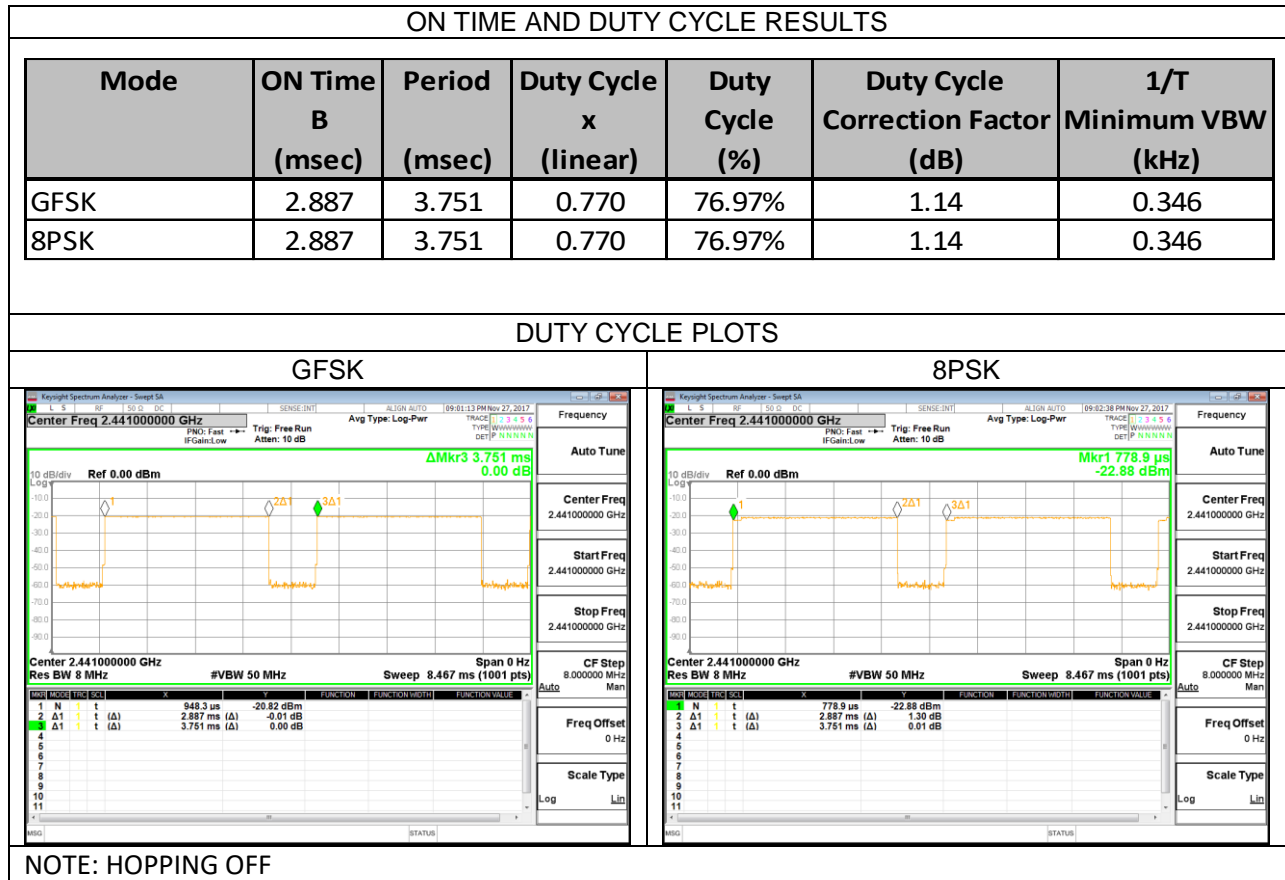

## 7.2. LIMITS AND PROCEDURE

### LIMITS

FCC §15.205 and §15.209  
 IC RSS-GEN, Section 8.9 and 8.10.

Frequency Range (MHz)	Field Strength Limit (uV/m) at 3 m	Field Strength Limit (dBuV/m) at 3 m
0.009-0.490	2400/F(kHz) @ 300m	2400/F(kHz) @ 300m
0.490-1.705	24000/F(kHz) @ 30m	24000/F(kHz) @ 30m
1.705-30.0	30 @ 30m	30 @ 30m
30 - 88	100	40
88 - 216	150	43.5
216 - 960	200	46
Above 960	500	54

**NOTE: KDB 414788 D01 OATS and Chamber Correlation Justification**

- Based on FCC 15.31 (f) (2): measurements may be performed at a distance closer than that specified in the regulations; however, an attempt should be made to avoid making measurements in the near field.
- OATs and chamber correlation testing had been performed and chamber measured test result is the worst case test result.

### TEST PROCEDURE

The EUT is placed on a non-conducting table 80 cm above the ground plane for measurement below 1GHz; 1.5 m above the ground plane for measurement above 1GHz. The antenna to EUT distance is 3 meters. The EUT is configured in accordance with ANSI C63.10. The EUT is set to transmit in a continuous mode.

For measurements below 1 GHz the resolution bandwidth is set to 120 kHz for peak detection measurements or 120 kHz for quasi-peak detection measurements for the 30-1000 MHz range, kHz for peak detection measurements or 9 kHz for quasi-peak detection measurements for the 0.15-30 MHz range and 200 Hz for peak detection measurements or 200 Hz for quasi-peak detection measurements for the 9 to 150 kHz range. Peak detection is used unless otherwise noted as quasi-peak.

For pre-scans above 1 GHz the resolution bandwidth is set to 1 MHz; the video bandwidth is set to 30 KHz for peak measurements.

For final measurements above 1 GHz the resolution bandwidth is set to 1 MHz; the video bandwidth is set to 3 MHz for peak measurements and as applicable for average measurements.

The spectrum from 1 GHz to 18 GHz is investigated with the transmitter set to the lowest, middle, and highest channels in each applicable band. Below 1GHz and above 18GHz emissions, the channel with the highest output power was tested.

The frequency range of interest is monitored at a fixed antenna height and EUT azimuth. The EUT is rotated through 360 degrees to maximize emissions received. The antenna is scanned from 1 to 4 meters above the ground plane to further maximize the emission. Measurements are made with the antenna polarized in both the vertical and the horizontal positions.

### RESULTS

### 7.3. WORST-CASE BELOW 30 MHz

#### SPURIOUS EMISSIONS BELOW 30 MHz (WORST-CASE CONFIGURATION)

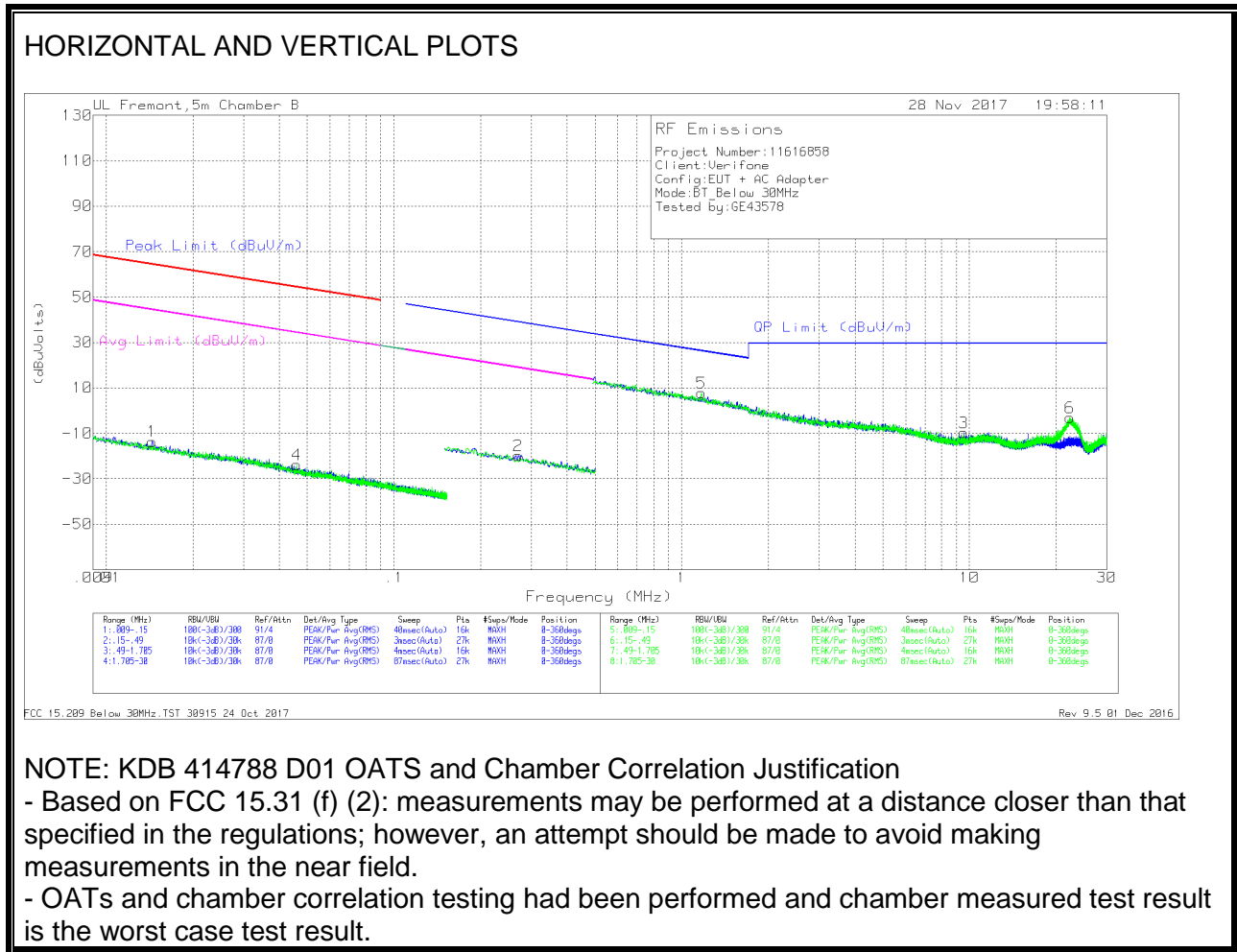

Trace Markers

Marker	Frequency (MHz)	Meter Reading (dBuV)	Det	Loop Antenna (dB/m)	Cbl (dB)	Dist Corr 300m	Corrected Reading (dBuVolts)	Peak Limit (dBuV/m)	Margin (dB)	Avg Limit (dBuV/m)	Margin (dB)	Peak Limit (dBuV/m)	Margin (dB)	Avg Limit (dBuV/m)	Margin (dB)	Azimuth (Degs)
1	.01446	49.73	Pk	15.3	1.4	-80	-13.57	64.38	-77.95	44.38	-57.95	-	-	-	-	0-360
4	.04588	40.36	Pk	14.5	1.4	-80	-23.74	54.35	-78.09	34.35	-58.09	-	-	-	-	0-360
2	.27013	44.76	Pk	13.8	1.5	-80	-19.94	-	-	-	-	38.98	-58.92	18.98	-38.92	0-360

Pk - Peak detector

Marker	Frequency (MHz)	Meter Reading (dBuV)	Det	Loop Antenna (dB/m)	Cbl (dB)	Dist Corr (dB) 40Log	Corrected Reading (dBuVolts)	QP Limit (dBuV/m)	Margin (dB)	Peak Limit (dBuV/m)	Margin (dB)	Avg Limit (dBuV/m)	Margin (dB)	Azimuth (Degs)
5	1.1713	31.97	Pk	14.3	1.5	-40	7.77	26.25	-18.48	-	-	-	-	0-360
3	9.56814	14.29	Pk	14.6	1.5	-40	-9.61	29.5	-39.11	-	-	-	-	0-360
6	22.33855	21.15	Pk	14	1.7	-40	-3.15	29.5	-32.65	-	-	-	-	0-360

Pk - Peak detector

### 7.4. WORST-CASE BELOW 1 GHz

#### SPURIOUS EMISSIONS 30 TO 1000 MHz (WORST-CASE CONFIGURATION)

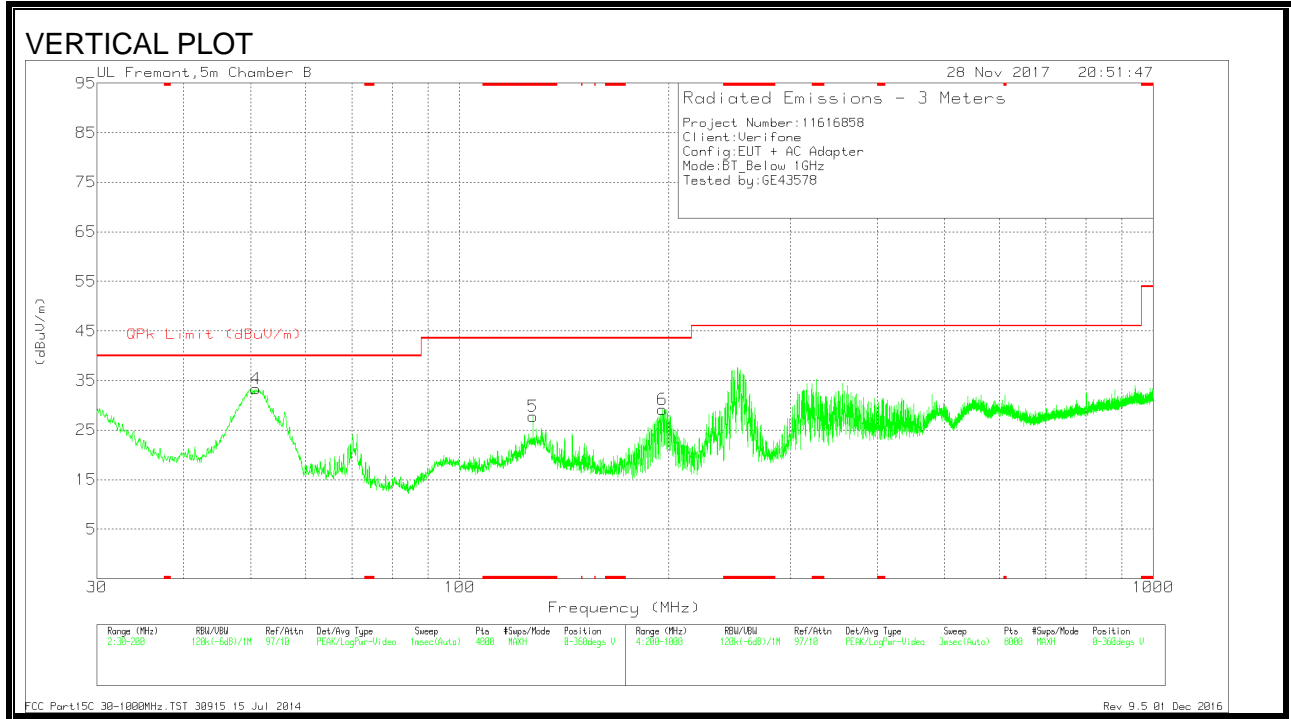
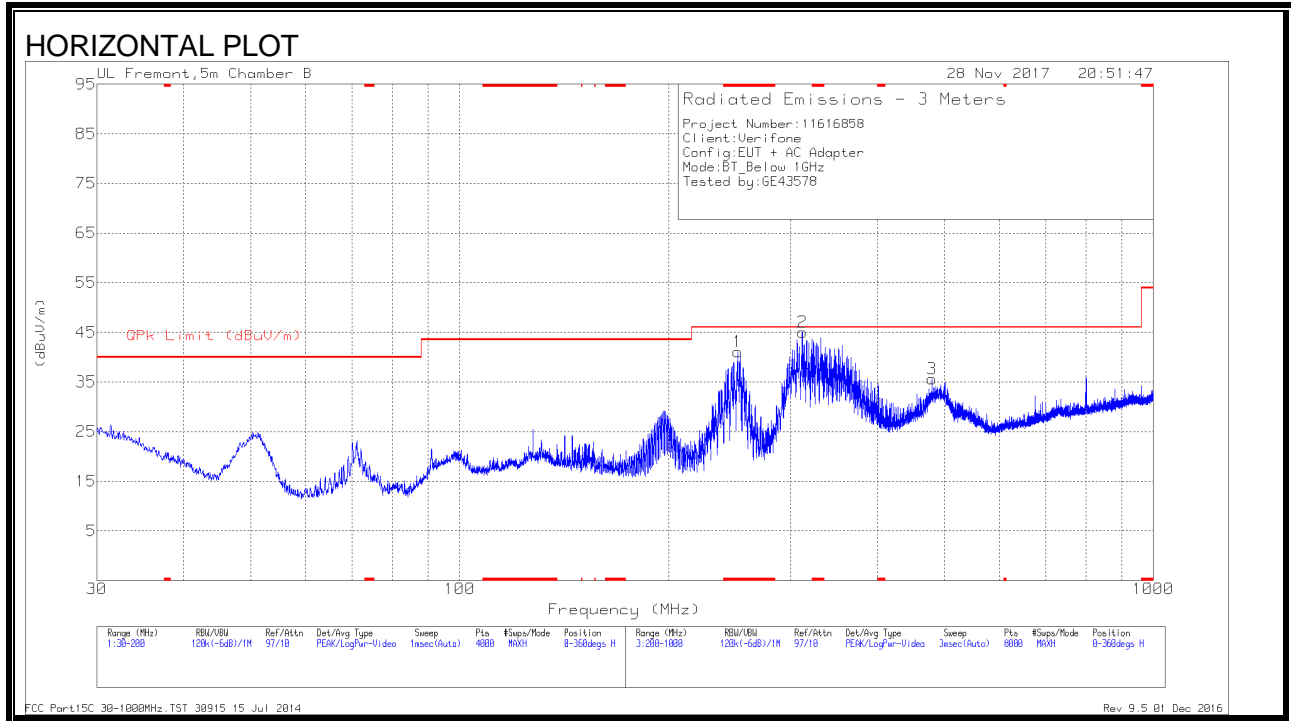



**DATA**

Marker	Frequency (MHz)	Meter Reading (dBuV)	Det	AF T899 (dB/m)	Amp/Cbl (dB)	Corrected Reading (dBuV/m)	QPk Limit (dBuV/m)	Margin (dB)	Azimuth (Degs)	Height (cm)	Polarity
5	* 127.5627	37.66	Pk	17.7	-27.6	27.76	43.52	-15.76	0-360	100	V
1	* 251.8691	49.04	Qp	15.5	-26.3	38.24	46.02	-7.78	243	136	H
4	50.8304	50.6	Pk	11.2	-28.5	33.3	40	-6.7	0-360	100	V
6	196.218	39.99	Pk	16	-26.8	29.19	43.52	-14.33	0-360	100	V
2	311.879	47.74	Qp	17.7	-25.8	39.64	46.02	-6.38	269	101	H
3	480.0364	40.07	Pk	21.5	-25.9	35.67	46.02	-10.35	0-360	200	H

\* - indicates frequency in CFR47 Pt 15 / IC RSS-Restricted Band

Pk - Peak detector

Qp - Quasi-Peak detector

## 7.5. TRANSMITTER ABOVE 1 GHz

### 7.5.1. BASIC DATA RATE GFSK MODULATION

#### BANDEDGE (LOW CHANNEL)

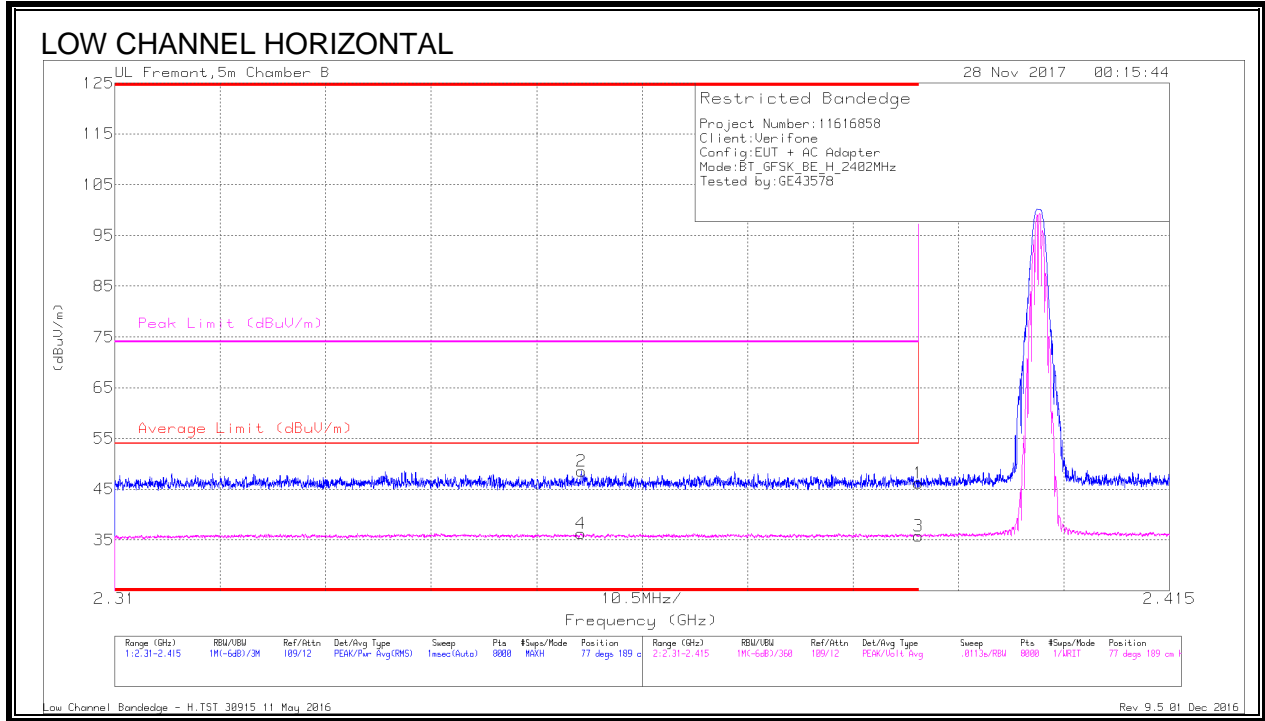

#### Trace Markers

Marker	Frequency (GHz)	Meter Reading (dBuV)	Det	AFT863 (dB/m)	Amp/Cbl/Fitr/Pad (dB)	Corrected Reading (dBuV/m)	Average Limit (dBuV/m)	Margin (dB)	Peak Limit (dBuV/m)	PK Margin (dB)	Azimuth (Degs)	Height (cm)	Polarity
1	* 2.39	35.41	Pk	32	-21.2	46.21	-	-	74	-27.79	77	189	H
2	* 2.356	37.64	Pk	31.9	-21	48.54	-	-	74	-25.46	77	189	H
3	* 2.39	24.99	VA1T	32	-21.2	35.79	54	-18.21	-	-	77	189	H
4	* 2.356	25.4	VA1T	31.9	-21	36.3	54	-17.7	-	-	77	189	H

\* - indicates frequency in CFR15.205/RSS-GEN 8.10 -Restricted Band

Pk - Peak detector

VA1T - FHSS: Linear Voltage Average  $VB=1/Ton$  where: Ton is transmit duration

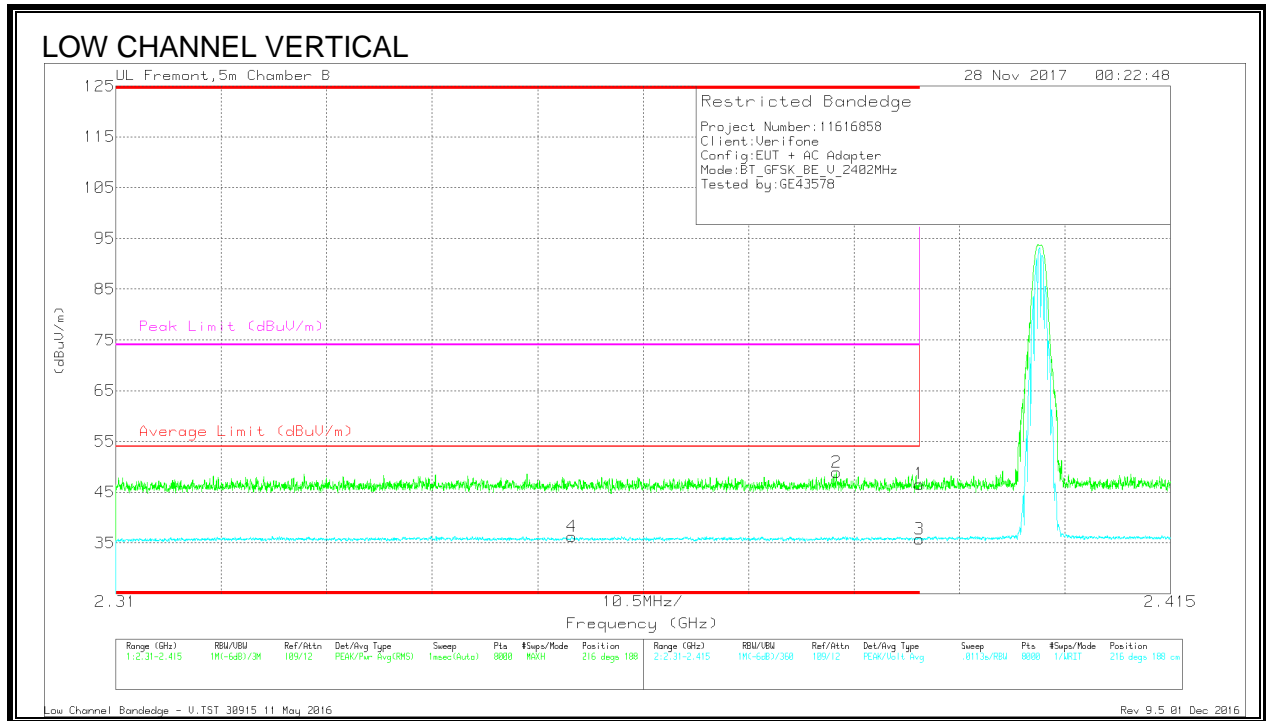

Trace Markers

Marker	Frequency (GHz)	Meter Reading (dBuV)	Det	AF T863 (dB/m)	Amp/Cb/Fltr/Pa d (dB)	Corrected Reading (dBuV/m)	Average Limit (dBuV/m)	Margin (dB)	Peak Limit (dBuV/m)	PK Margin (dB)	Azimuth (Degs)	Height (cm)	Polarity
1	* 2.39	35.83	Pk	32	-21.2	46.63	-	-	74	-27.37	216	188	V
2	* 2.382	37.97	Pk	32	-21.1	48.87	-	-	74	-25.13	216	188	V
3	* 2.39	24.91	VA1T	32	-21.2	35.71	54	-18.29	-	-	216	188	V
4	* 2.355	25.39	VA1T	31.9	-21	36.29	54	-17.71	-	-	216	188	V

\* - indicates frequency in CFR15.205/RSS-GEN 8.10 -Restricted Band  
 Pk - Peak detector  
 VA1T - FHSS: Linear Voltage Average VB=1/Ton where: Ton is transmit duration

**BANDEDGE (HIGH CHANNEL)**

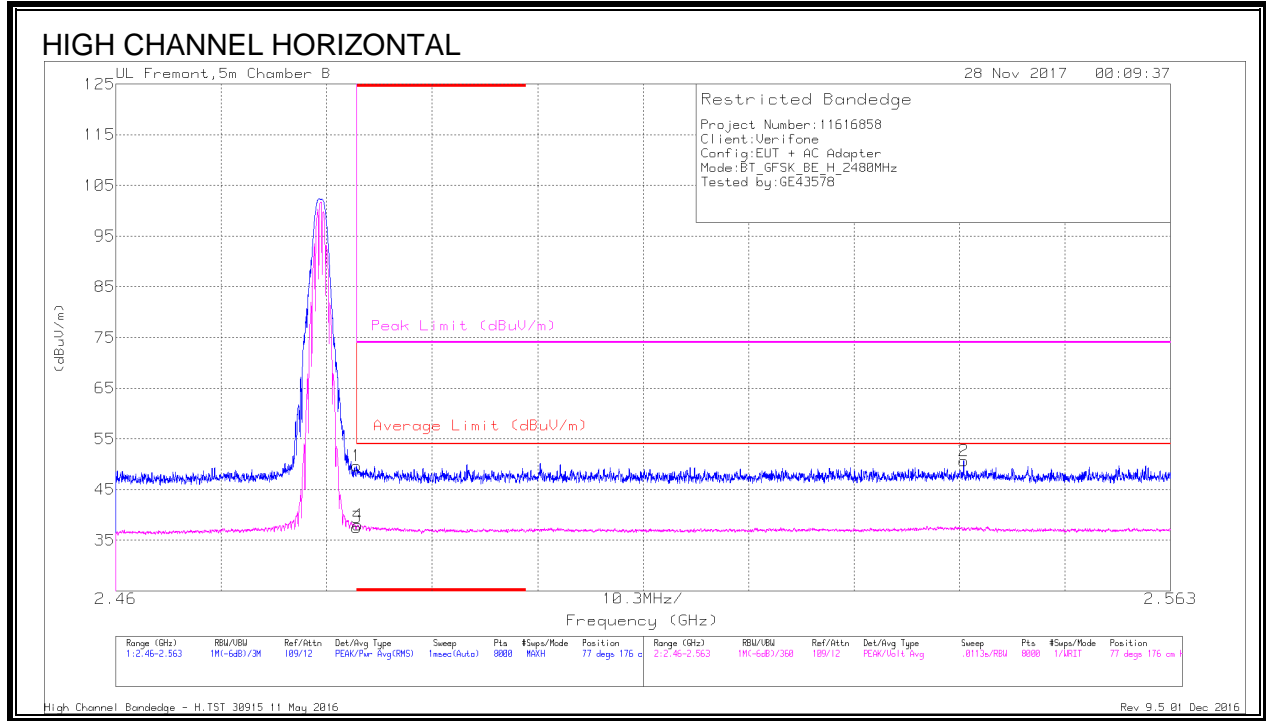

**Trace Markers**

Marker	Frequency (GHz)	Meter Reading (dBuV)	Det	AFT863 (dB/m)	Amp/Cbl/Fitr/Pad (dB)	Corrected Reading (dBuV/m)	Average Limit (dBuV/m)	Margin (dB)	Peak Limit (dBuV/m)	PK Margin (dB)	Azimuth (Degs)	Height (cm)	Polarity
1	* 2.484	38.09	Pk	32.5	-20.9	49.69	-	-	74	-24.31	77	176	H
3	* 2.484	25.89	VA1T	32.5	-20.9	37.49	54	-16.51	-	-	77	176	H
4	* 2.484	26.42	VA1T	32.5	-20.9	38.02	54	-15.98	-	-	77	176	H
2	2.543	38.8	Pk	32.5	-20.6	50.7	-	-	74	-23.3	77	176	H

\* - indicates frequency in CFR15.205/RSS-GEN 8.10 -Restricted Band  
 Pk - Peak detector  
 VA1T - FHSS: Linear Voltage Average VB=1/Ton where: Ton is transmit duration

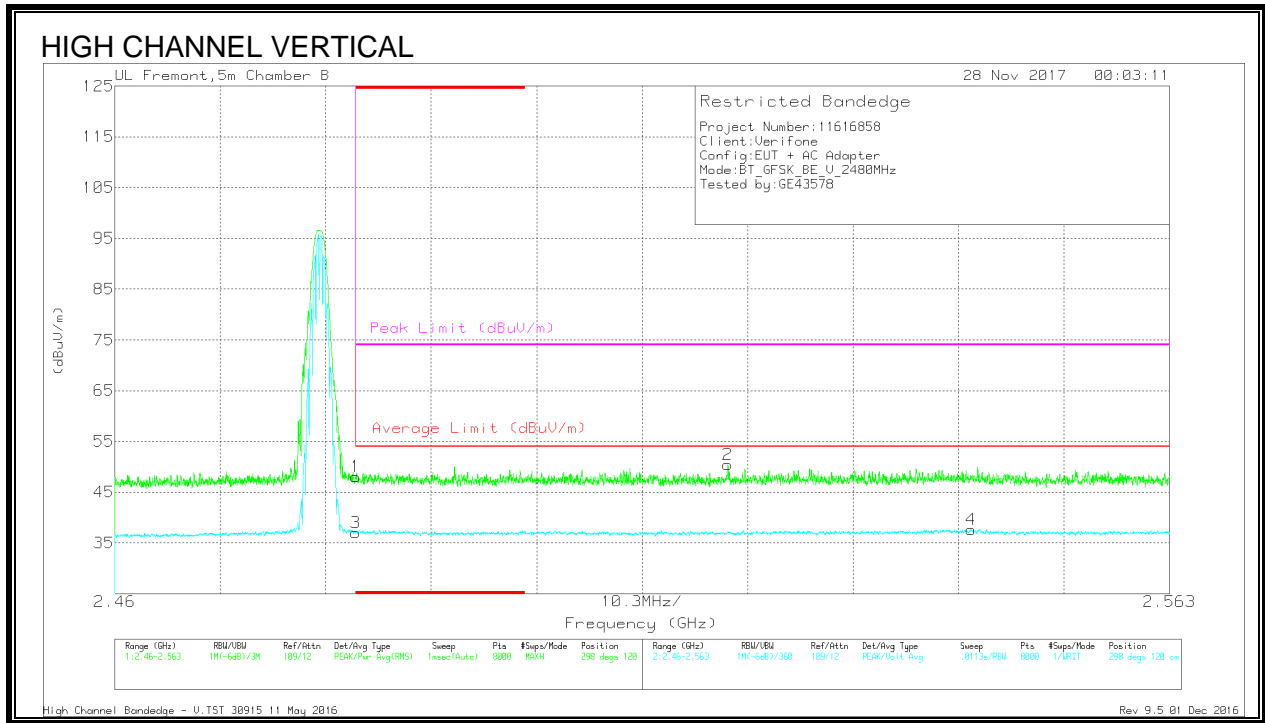

Trace Markers

Marker	Frequency (GHz)	Meter Reading (dBuV)	Det	AF T863 (dB/m)	Amp/Cb/Fltr/Par d (dB)	Corrected Reading (dBuV/m)	Average Limit (dBuV/m)	Margin (dB)	Peak Limit (dBuV/m)	PK Margin (dB)	Azimuth (Degs)	Height (cm)	Polarity
1	* 2.484	36.41	Pk	32.5	-20.9	48.01	-	-	74	-25.99	298	120	V
3	* 2.484	25.41	VA1T	32.5	-20.9	37.01	54	-16.99	-	-	298	120	V
2	2.52	38.81	Pk	32.6	-21	50.41	-	-	74	-23.59	298	120	V
4	2.544	25.78	VA1T	32.5	-20.6	37.68	54	-16.32	-	-	298	120	V

\* - indicates frequency in CFR15.205/RSS-GEN 8.10 -Restricted Band  
 Pk - Peak detector  
 VA1T - FHSS: Linear Voltage Average VB=1/Ton where: Ton is transmit duration

**HARMONICS AND SPURIOUS EMISSIONS**

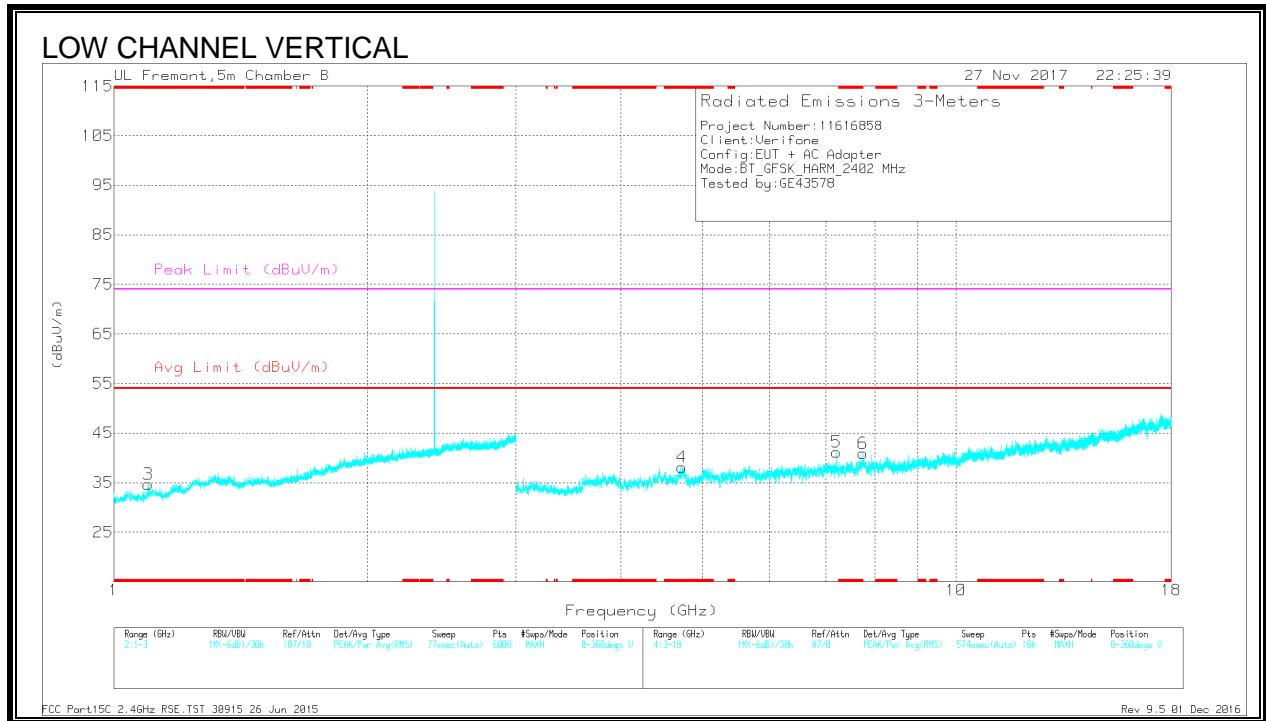
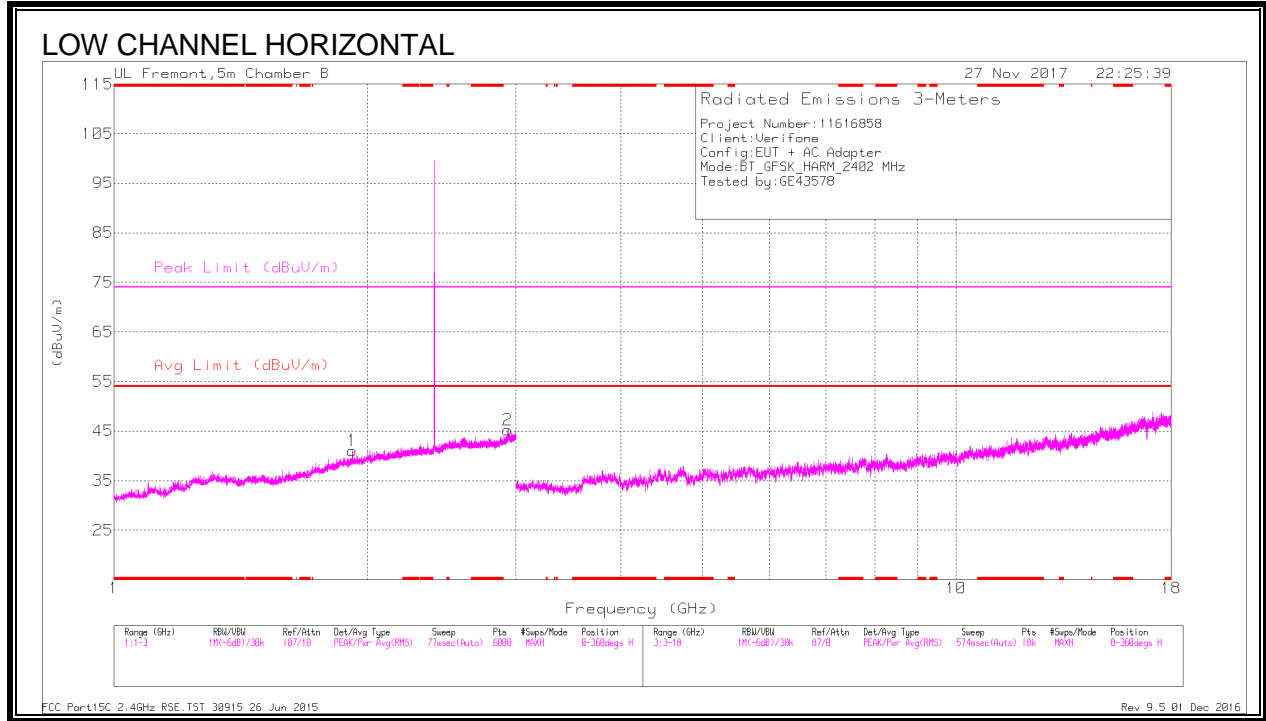

Radiated Emissions

Marker	Frequency (GHz)	Meter Reading (dBuV)	Det	AF T863 (dB/m)	Amp/Cbl/Fitr/P ad (dB)	Corrected Reading (dBuV/m)	Avg Limit (dBuV/m)	Margin (dB)	Peak Limit (dBuV/m)	PK Margin (dB)	Azimuth (Degs)	Height (cm)	Polarity
3	* 1.098	34.04	PKFH	27.6	-22.9	38.74	-	-	74	-35.26	301	199	V
	* 1.098	24.14	VA1T	27.6	-23	28.74	54	-25.26	-	-	301	199	V
4	* 4.722	36.81	PKFH	34.2	-28.7	42.31	-	-	74	-31.69	212	104	V
	* 4.724	25.83	VA1T	34.2	-28.7	31.33	54	-22.67	-	-	212	104	V
1	1.92	34.98	PKFH	31	-20.9	45.08	-	-	-	-	243	101	H
	1.92	27.45	VA1T	31	-20.9	37.55	-	-	-	-	243	101	H
2	2.932	34.95	PKFH	32.6	-19.6	47.95	-	-	-	-	285	199	H
	2.933	23.77	VA1T	32.6	-19.6	36.77	-	-	-	-	285	199	H
5	7.206	35.19	PKFH	35.8	-27.2	43.79	-	-	-	-	195	104	V
	7.206	24.21	VA1T	35.8	-27.2	32.81	-	-	-	-	195	104	V
6	7.754	23.18	VA1T	36	-25.6	33.58	-	-	-	-	202	200	V
	7.756	34.14	PKFH	36	-25.8	44.34	-	-	-	-	202	200	V

\* - indicates frequency in CFR47 Pt 15 / IC RSS-Restricted Band

PKFH - FHSS: RB=100k/1MHz VB=3 x RB, Peak

VA1T - FHSS: Linear Voltage Average VB=1/Ton where: Ton is transmit duration

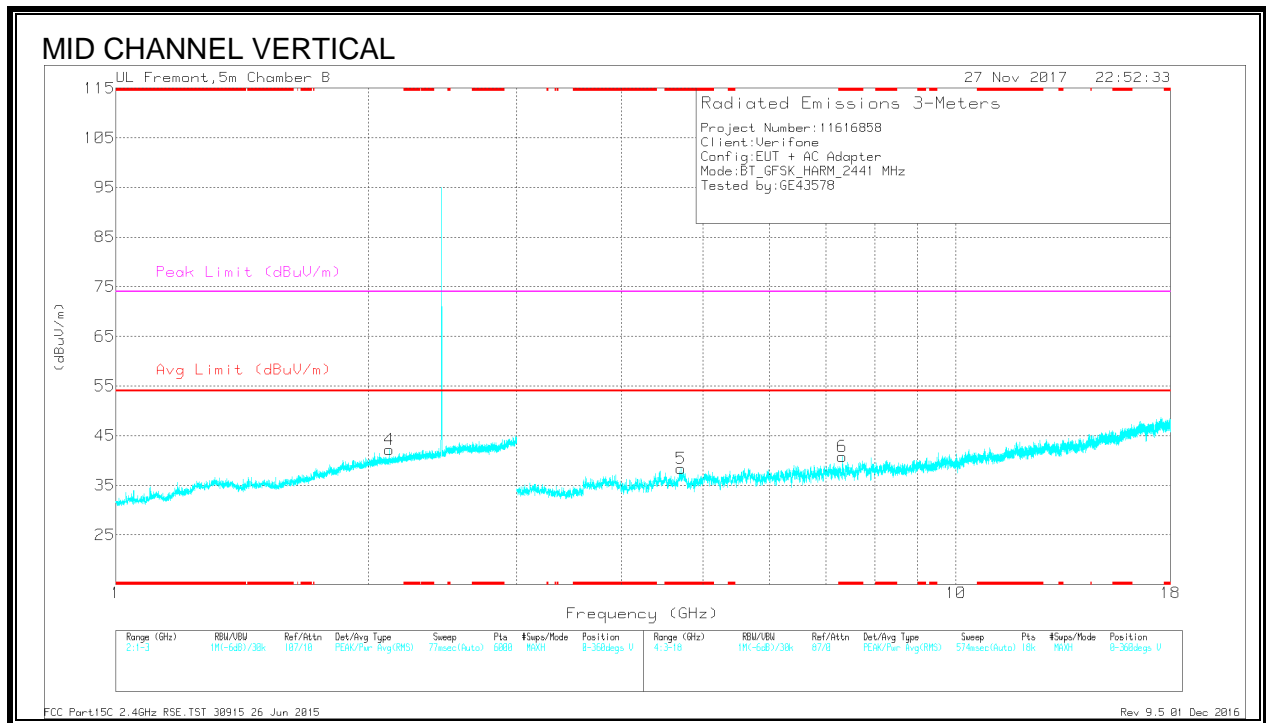
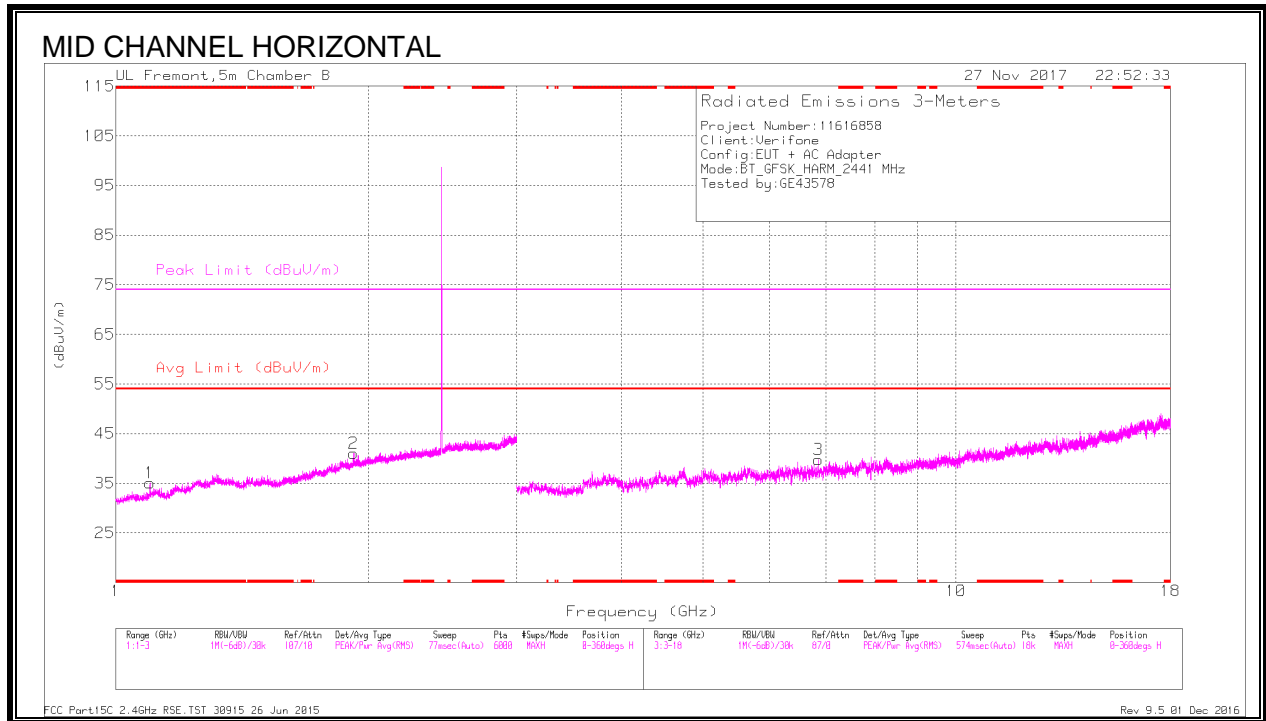



Radiated Emissions

Marker	Frequency (GHz)	Meter Reading (dBuV)	Det	AF T863 (dB/m)	Amp/Cbl/Fitr/P ad (dB)	Corrected Reading (dBuV/m)	Avg Limit (dBuV/m)	Margin (dB)	Peak Limit (dBuV/m)	PK Margin (dB)	Azimuth (Degs)	Height (cm)	Polarity
1	* 1.098	34.84	PKFH	27.6	-22.9	39.54	-	-	74	-34.46	174	199	H
	* 1.098	25.52	VA1T	27.6	-23	30.12	54	-23.88	-	-	174	199	H
5	* 4.703	36.82	PKFH	34.2	-29.5	41.52	-	-	74	-32.48	92	104	V
	* 4.705	25.99	VA1T	34.2	-29.3	30.89	54	-23.11	-	-	92	104	V
6	* 7.322	34.58	PKFH	35.9	-27.5	42.98	-	-	74	-31.02	115	104	V
	* 7.323	24.06	VA1T	35.9	-27.4	32.56	54	-21.44	-	-	115	104	V
2	1.92	35.3	PKFH	31	-20.9	45.4	-	-	-	-	239	104	H
	1.92	27.59	VA1T	31	-20.9	37.69	-	-	-	-	239	104	H
4	2.114	36.14	PKFH	31.4	-21	46.54	-	-	-	-	202	104	V
	2.116	23.2	VA1T	31.4	-21	33.6	-	-	-	-	202	104	V
3	6.859	34.81	PKFH	35.8	-27.1	43.51	-	-	-	-	121	199	H
	6.859	23.98	VA1T	35.8	-27.1	32.68	-	-	-	-	121	199	H

\* - indicates frequency in CFR47 Pt 15 / IC RSS-Restricted Band

PKFH - FHSS: RB=100k/1MHz VB=3 x RB, Peak

VA1T - FHSS: Linear Voltage Average VB=1/Ton where: Ton is transmit duration

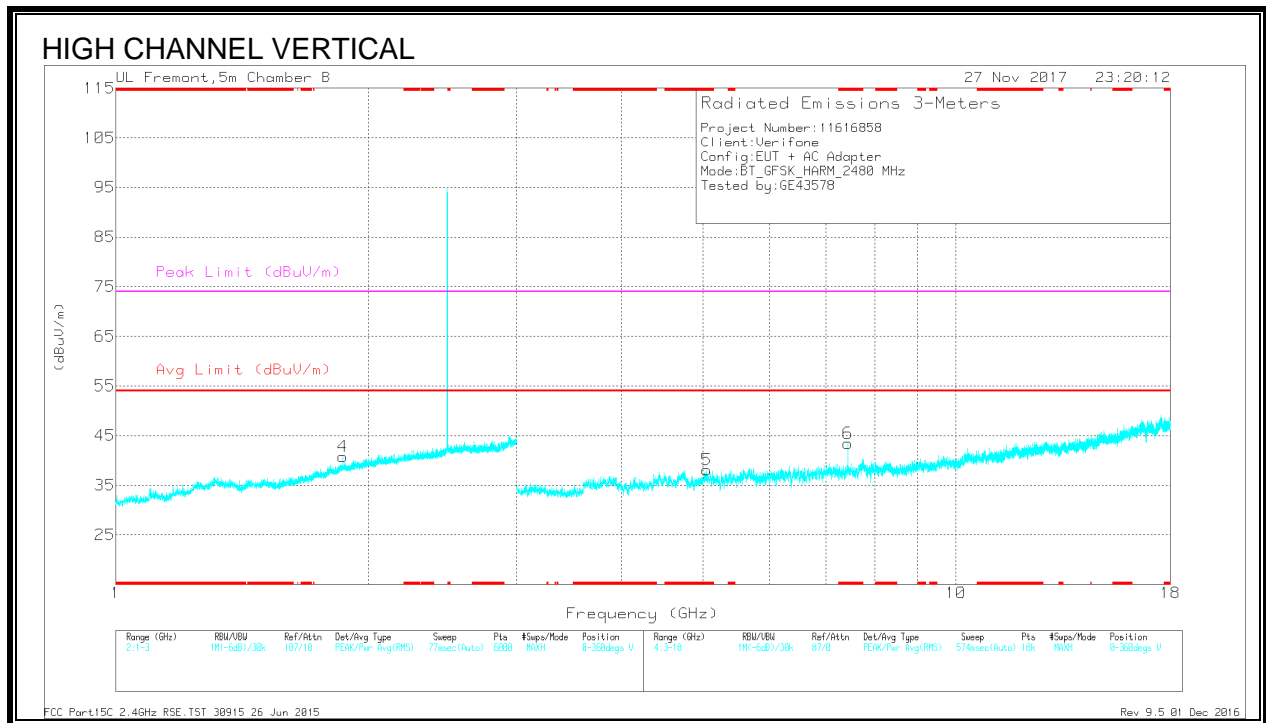
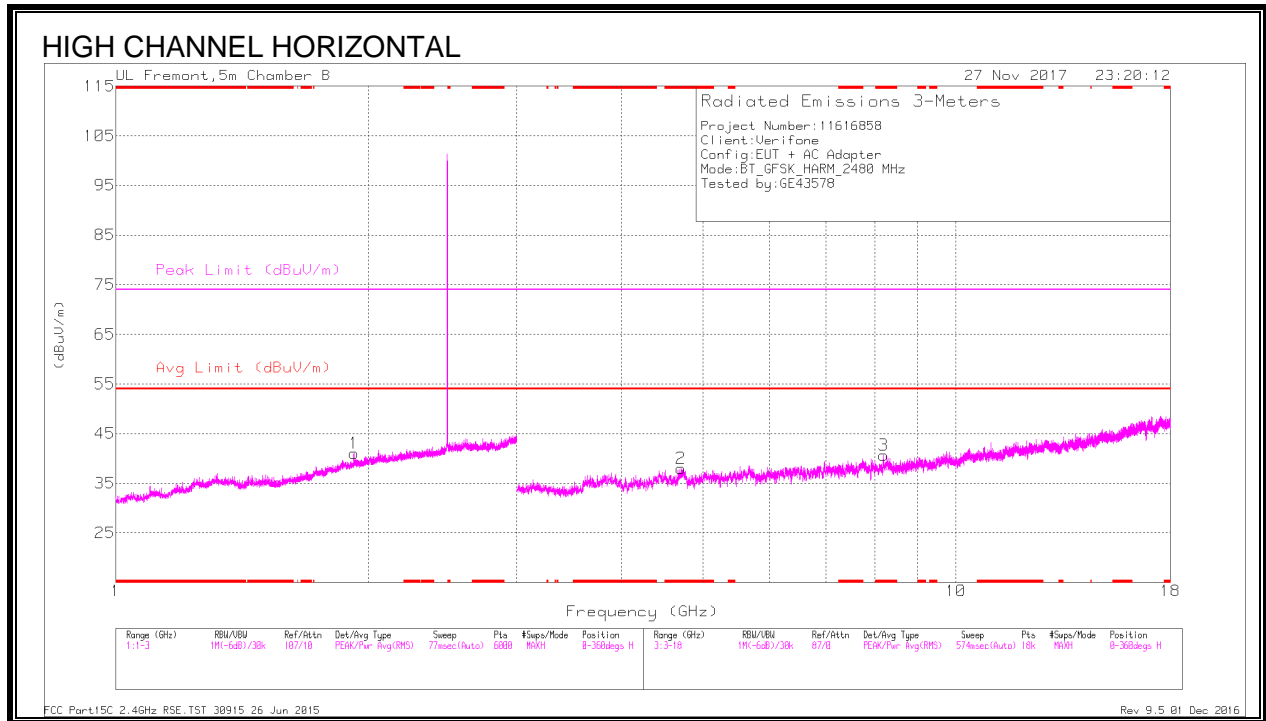

Radiated Emissions

Marker	Frequency (GHz)	Meter Reading (dBuV)	Det	AF T863 (dB/m)	Amp/Cbl/Fitr/P ad (dB)	Corrected Reading (dBuV/m)	Avg Limit (dBuV/m)	Margin (dB)	Peak Limit (dBuV/m)	PK Margin (dB)	Azimuth (Degs)	Height (cm)	Polarity
2	* 4.708	36.68	PKFH	34.2	-29.1	41.78	-	-	74	-32.22	171	104	H
	* 4.709	25.62	VA1T	34.2	-29	30.82	54	-23.18	-	-	171	104	H
3	* 8.203	34.71	PKFH	36	-26.5	44.21	-	-	74	-29.79	212	104	H
	* 8.201	23.7	VA1T	36	-26.4	33.3	54	-20.7	-	-	212	104	H
5	* 5.05	36.13	PKFH	34.4	-28.2	42.33	-	-	74	-31.67	265	104	V
	* 5.05	25.15	VA1T	34.4	-28.2	31.35	54	-22.65	-	-	265	104	V
6	* 7.439	34.2	PKFH	35.9	-26.5	43.6	-	-	74	-30.4	231	104	V
	* 7.44	24.09	VA1T	35.9	-26.5	33.49	54	-20.51	-	-	231	104	V
4	1.861	22.76	VA1T	30.8	-20.9	32.66	-	-	-	-	195	104	V
	1.862	33.62	PKFH	30.8	-20.9	43.52	-	-	-	-	195	104	V
1	1.92	36.13	PKFH	31	-20.9	46.23	-	-	-	-	241	199	H
	1.92	26.72	VA1T	31	-20.9	36.82	-	-	-	-	241	199	H

\* - indicates frequency in CFR47 Pt 15 / IC RSS-Restricted Band

PKFH - FHSS: RB=100k/1MHz VB=3 x RB, Peak

VA1T - FHSS: Linear Voltage Average VB=1/Ton where: Ton is transmit duration

**7.5.2. ENHANCED DATA RATE 8PSK MODULATION**

**BANDEDGE (LOW CHANNEL)**

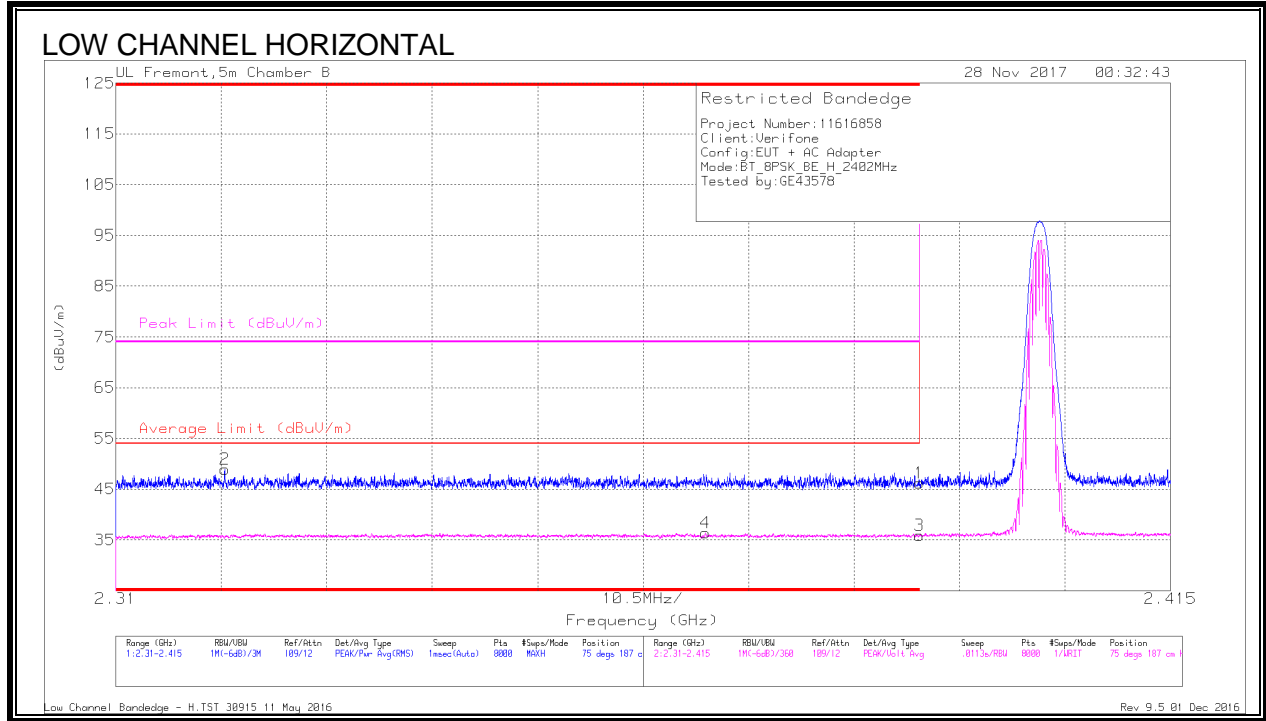

**Trace Markers**

Marker	Frequency (GHz)	Meter Reading (dBuV)	Det	AF T863 (dB/m)	Amp/Cb/Filtr/Pa d (dB)	Corrected Reading (dBuV/m)	Average Limit (dBuV/m)	Margin (dB)	Peak Limit (dBuV/m)	PK Margin (dB)	Azimuth (Degs)	Height (cm)	Polarity
1	* 2.39	35.38	Pk	32	-21.2	46.18	-	-	74	-27.82	75	187	H
2	* 2.321	38.08	Pk	31.9	-21.1	48.88	-	-	74	-25.12	75	187	H
3	* 2.39	25.08	VA1T	32	-21.2	35.88	54	-18.12	-	-	75	187	H
4	* 2.369	25.54	VA1T	31.9	-21.1	36.34	54	-17.66	-	-	75	187	H

\* - indicates frequency in CFR15.205/RSS-GEN 8.10 -Restricted Band

Pk - Peak detector

VA1T - FHSS: Linear Voltage Average VB=1/Ton where: Ton is transmit duration

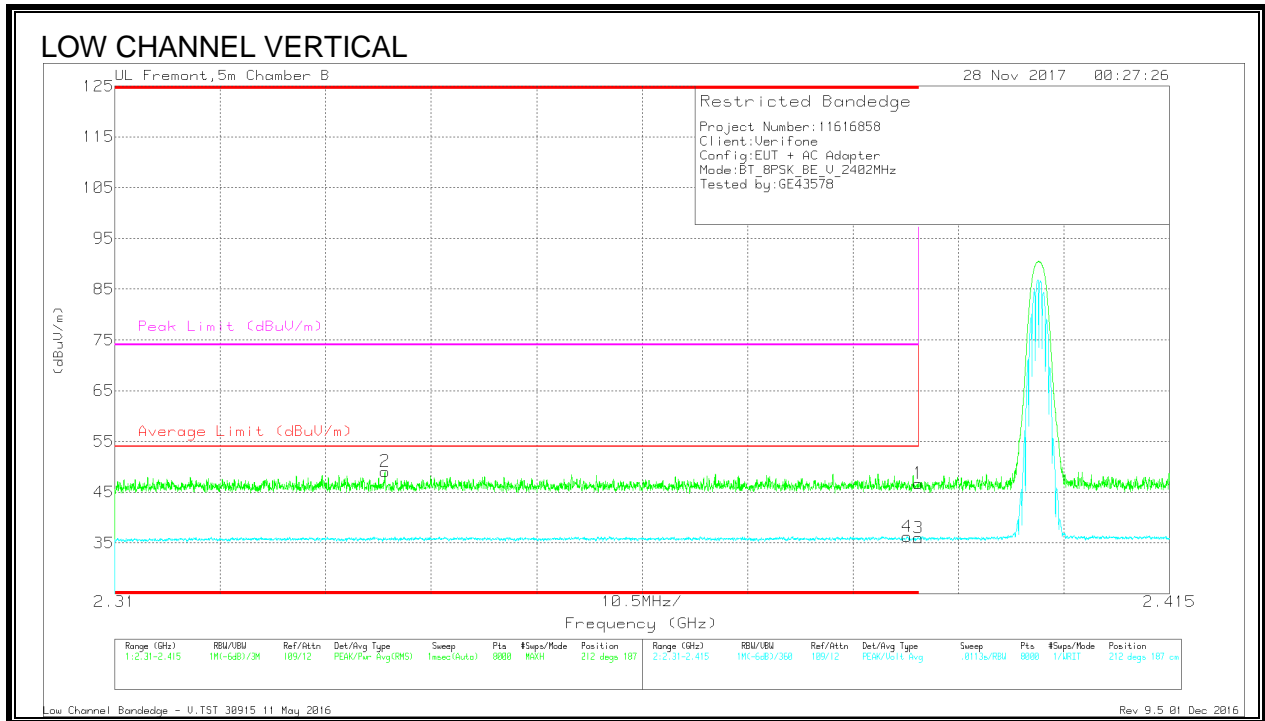

Trace Markers

Marker	Frequency (GHz)	Meter Reading (dBuV)	Det	AF T863 (dB/m)	Amp/Cb/Fltr/Pa d (dB)	Corrected Reading (dBuV/m)	Average Limit (dBuV/m)	Margin (dB)	Peak Limit (dBuV/m)	PK Margin (dB)	Azimuth (Degs)	Height (cm)	Polarity
1	* 2.39	35.95	Pk	32	-21.2	46.75	-	-	74	-27.25	212	187	V
2	* 2.337	38.31	Pk	31.9	-21.1	49.11	-	-	74	-24.89	212	187	V
3	* 2.39	25.23	VA1T	32	-21.2	36.03	54	-17.97	-	-	212	187	V
4	* 2.389	25.48	VA1T	32	-21.2	36.28	54	-17.72	-	-	212	187	V

\* - indicates frequency in CFR15.205/RSS-GEN 8.10 -Restricted Band  
 Pk - Peak detector  
 VA1T - FHSS: Linear Voltage Average VB=1/Ton where: Ton is transmit duration

**BADEDGE (HIGH CHANNEL)**

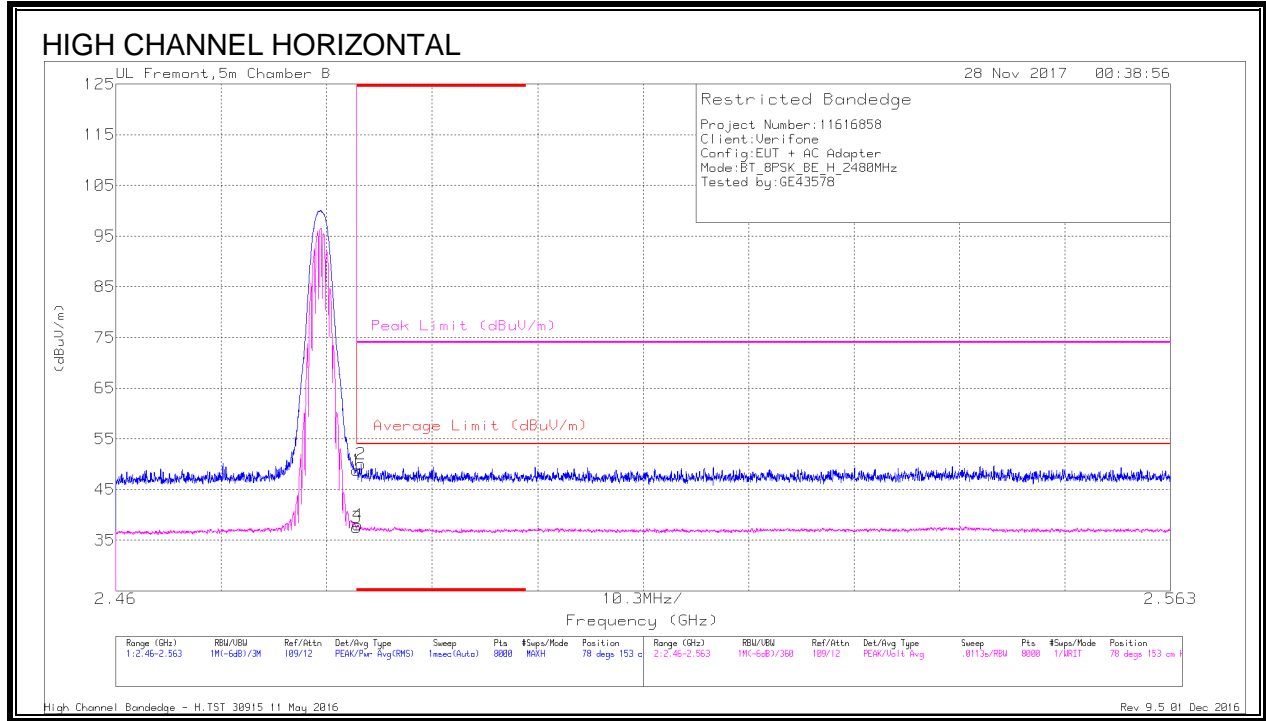

**Trace Markers**

Marker	Frequency (GHz)	Meter Reading (dBuV)	Det	AFT863 (dB/m)	Amp/Cbl/Fitr/Pad (dB)	Corrected Reading (dBuV/m)	Average Limit (dBuV/m)	Margin (dB)	Peak Limit (dBuV/m)	PK Margin (dB)	Azimuth (Degs)	Height (cm)	Polarity
1	* 2.484	37.17	Pk	32.5	-20.9	48.77	-	-	74	-25.23	78	153	H
2	* 2.484	38.48	Pk	32.5	-20.9	50.08	-	-	74	-23.92	78	153	H
3	* 2.484	25.87	VA1T	32.5	-20.9	37.47	54	-16.53	-	-	78	153	H
4	* 2.484	26.45	VA1T	32.5	-20.9	38.05	54	-15.95	-	-	78	153	H

\* - indicates frequency in CFR15.205/RSS-GEN 8.10 -Restricted Band

Pk - Peak detector

VA1T - FHSS: Linear Voltage Average VB=1/Ton where: Ton is transmit duration

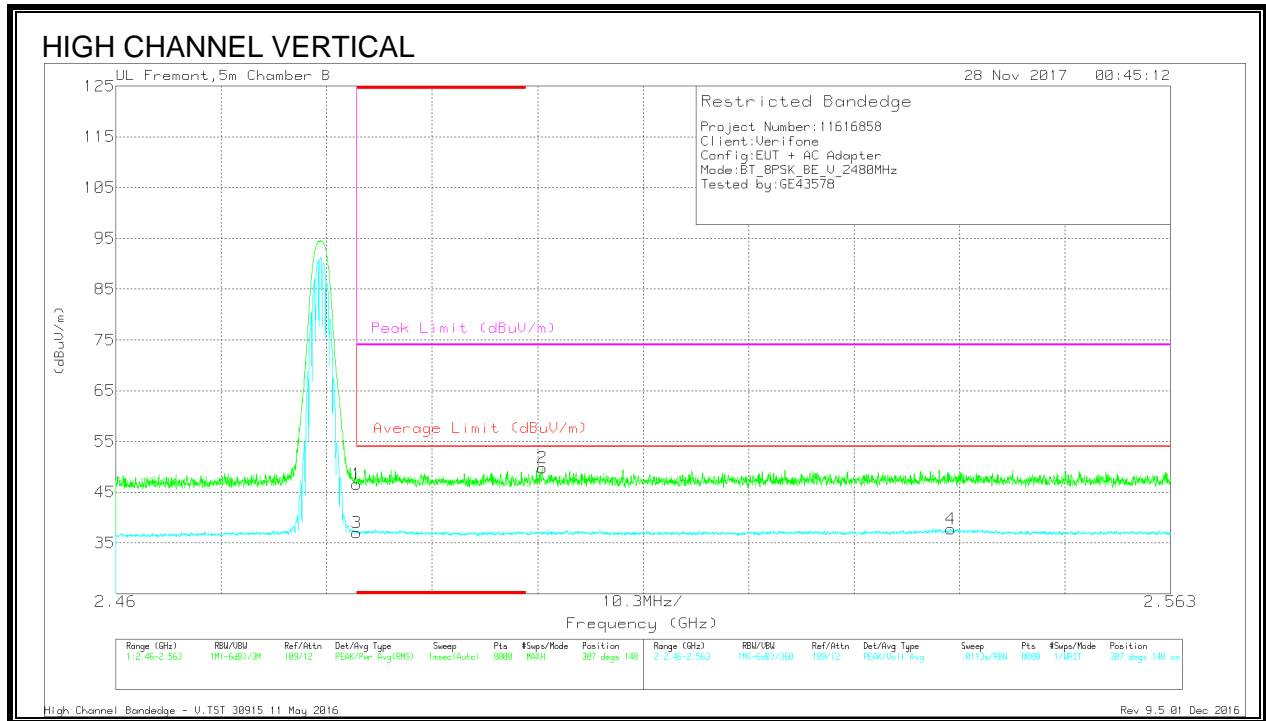

Trace Markers

Marker	Frequency (GHz)	Meter Reading (dBuV)	Det	AF T863 (dB/m)	Amp/Cbl/Filtr/Path (dB)	Corrected Reading (dBuV/m)	Average Limit (dBuV/m)	Margin (dB)	Peak Limit (dBuV/m)	PK Margin (dB)	Azimuth (Degs)	Height (cm)	Polarity
1	* 2.484	34.96	Pk	32.5	-20.9	46.56	-	-	74	-27.44	307	148	V
3	* 2.484	25.36	VA1T	32.5	-20.9	36.96	54	-17.04	-	-	307	148	V
2	2.502	38.15	Pk	32.6	-21	49.75	-	-	74	-24.25	307	148	V
4	2.542	25.87	VA1T	32.5	-20.6	37.77	54	-16.23	-	-	307	148	V

\* - indicates frequency in CFR15.205/RSS-GEN 8.10 -Restricted Band  
 Pk - Peak detector  
 VA1T - FHSS: Linear Voltage Average VB=1/Ton where: Ton is transmit duration

**HARMONICS AND SPURIOUS EMISSIONS**

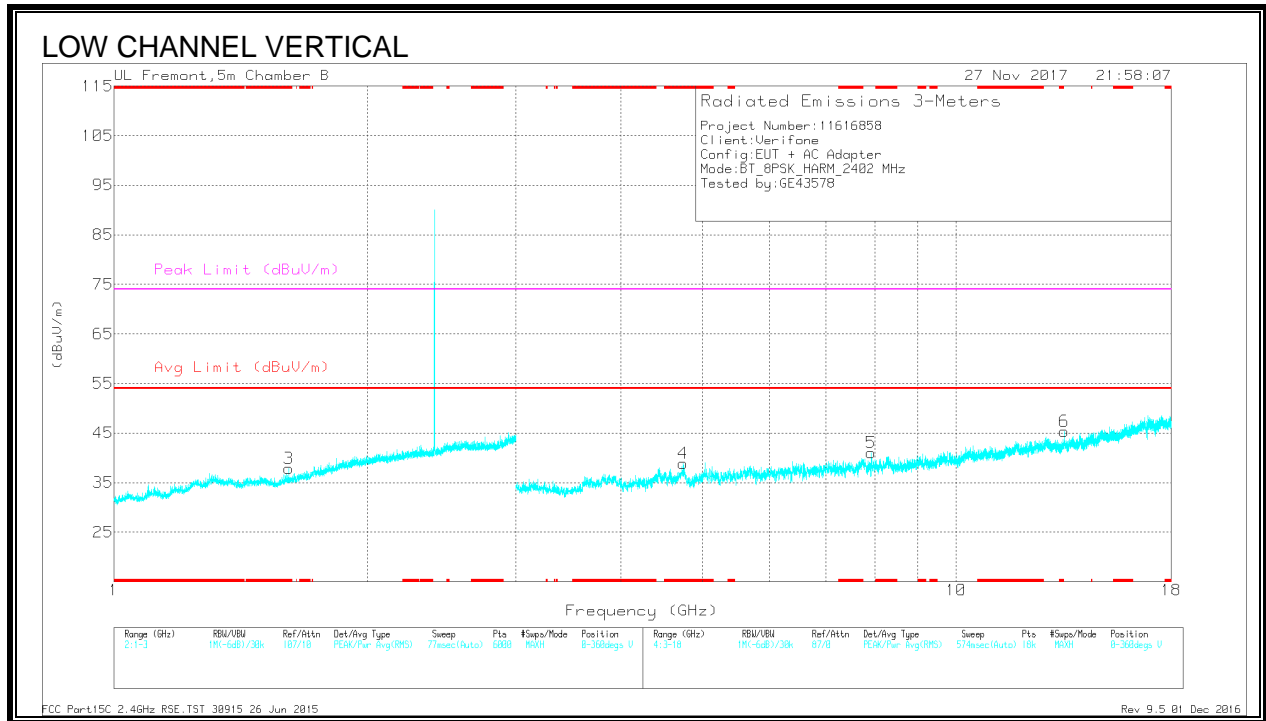
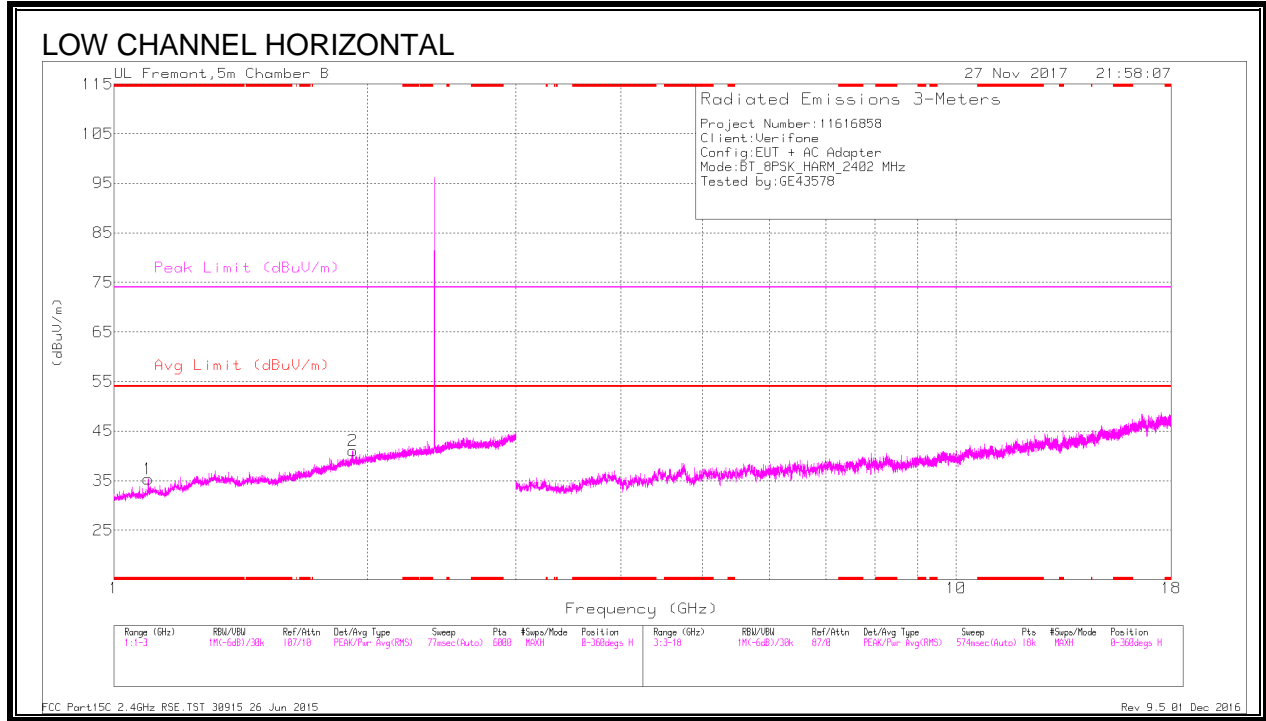



Radiated Emissions

Marker	Frequency (GHz)	Meter Reading (dBuV)	Det	AF T863 (dB/m)	Amp/Cbl/Fitr/P ad (dB)	Corrected Reading (dBuV/m)	Avg Limit (dBuV/m)	Margin (dB)	Peak Limit (dBuV/m)	PK Margin (dB)	Azimuth (Degs)	Height (cm)	Polarity
1	* 1.098	34.57	PKFH	27.6	-23	39.17	-	-	74	-34.83	196	199	H
	* 1.098	25.88	VA1T	27.6	-23	30.48	54	-23.52	-	-	196	199	H
3	* 1.613	32.96	PKFH	28.4	-21.4	39.96	-	-	74	-34.04	241	200	V
	* 1.613	22.48	VA1T	28.4	-21.4	29.48	54	-24.52	-	-	241	200	V
4	* 4.74	37.92	PKFH	34.2	-28.3	43.82	-	-	74	-30.18	212	200	V
	* 4.742	26.62	VA1T	34.2	-28.3	32.52	54	-21.48	-	-	212	200	V
2	1.919	33.8	PKFH	31	-20.9	43.9	-	-	-	-	275	104	H
	1.92	23.54	VA1T	31	-20.9	33.64	-	-	-	-	275	104	H
5	7.926	34.15	PKFH	36	-25.1	45.05	-	-	-	-	152	200	V
	7.929	23.37	VA1T	36	-25.3	34.07	-	-	-	-	152	200	V
6	13.426	30.17	PKFH	39.3	-20.5	48.97	-	-	-	-	88	200	V
	13.427	19.15	VA1T	39.3	-20.6	37.85	-	-	-	-	88	200	V

\* - indicates frequency in CFR47 Pt 15 / IC RSS-Restricted Band

PKFH - FHSS: RB=100k/1MHz VB=3 x RB, Peak

VA1T - FHSS: Linear Voltage Average VB=1/Ton where: Ton is transmit duration

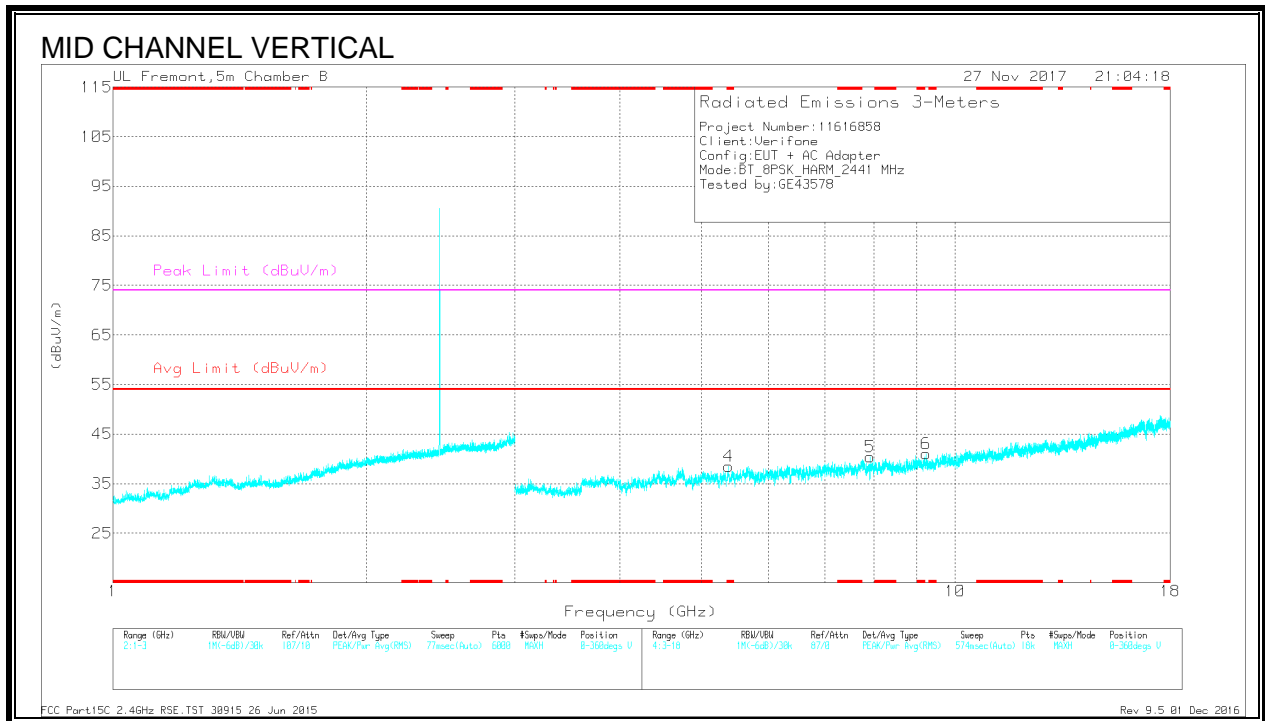
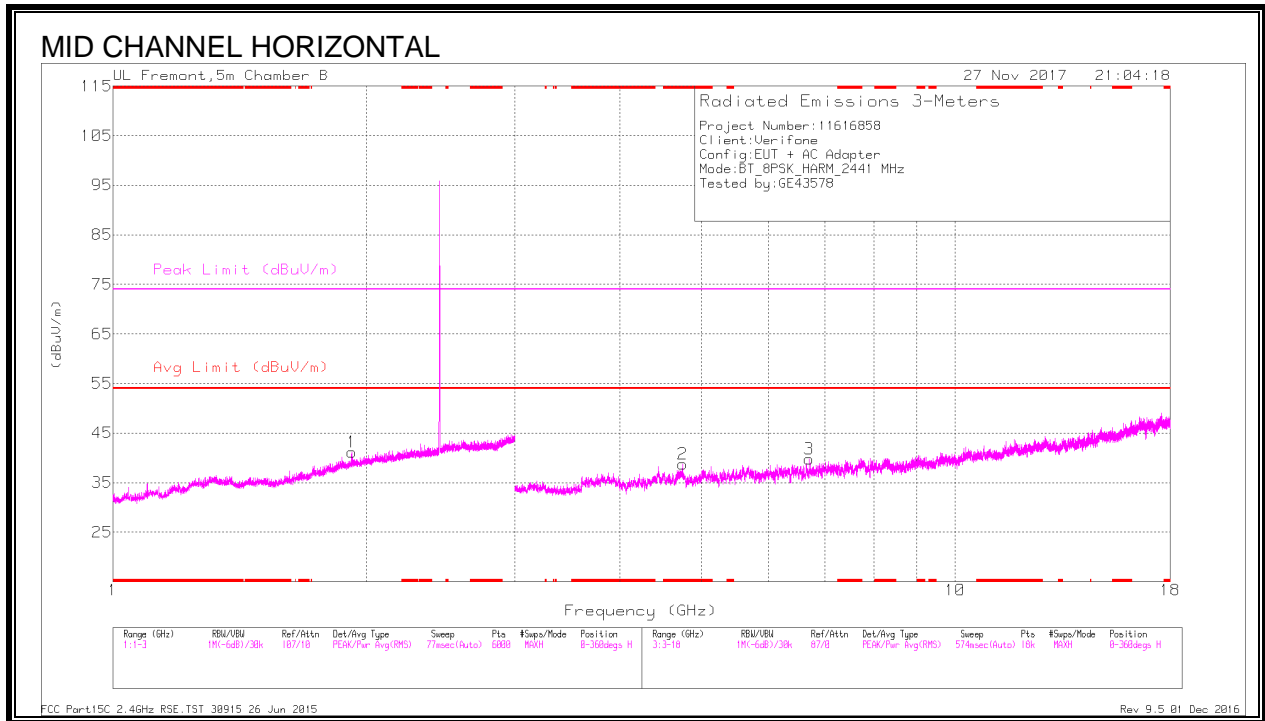

Radiated Emissions

Marker	Frequency (GHz)	Meter Reading (dBuV)	Det	AF T863 (dB/m)	Amp/Cb/Filtr/Pad (dB)	Corrected Reading (dBuV/m)	Avg Limit (dBuV/m)	Margin (dB)	Peak Limit (dBuV/m)	PK Margin (dB)	Azimuth (Degs)	Height (cm)	Polarity
2	* 4.743	37.35	PKFH	34.2	-28.4	43.15	-	-	74	-30.85	301	100	H
	* 4.742	26.67	VA1T	34.2	-28.4	32.47	54	-21.53	-	-	301	100	H
4	* 5.385	36.26	PKFH	35	-28.4	42.86	-	-	74	-31.14	286	100	V
	* 5.385	24.98	VA1T	35	-28.4	31.58	54	-22.42	-	-	286	100	V
1	1.92	37.01	PKFH	31	-20.9	47.11	-	-	-	-	325	100	H
	1.92	27.92	VA1T	31	-20.9	38.02	-	-	-	-	325	100	H
3	6.712	35	PKFH	35.7	-28	42.7	-	-	-	-	277	100	H
	6.712	24.5	VA1T	35.7	-28	32.2	-	-	-	-	277	100	H
5	7.927	33.83	PKFH	36	-25.1	44.73	-	-	-	-	212	200	V
	7.927	23.28	VA1T	36	-25	34.28	-	-	-	-	212	200	V
6	9.23	32.35	PKFH	36.4	-24.1	44.65	-	-	-	-	151	104	V
	9.231	21.42	VA1T	36.4	-24.1	33.72	-	-	-	-	151	104	V

\* - indicates frequency in CFR47 Pt 15 / IC RSS-Restricted Band

PKFH - FHSS: RB=100k/1MHz VB=3 x RB, Peak

VA1T - FHSS: Linear Voltage Average VB=1/Ton where: Ton is transmit duration

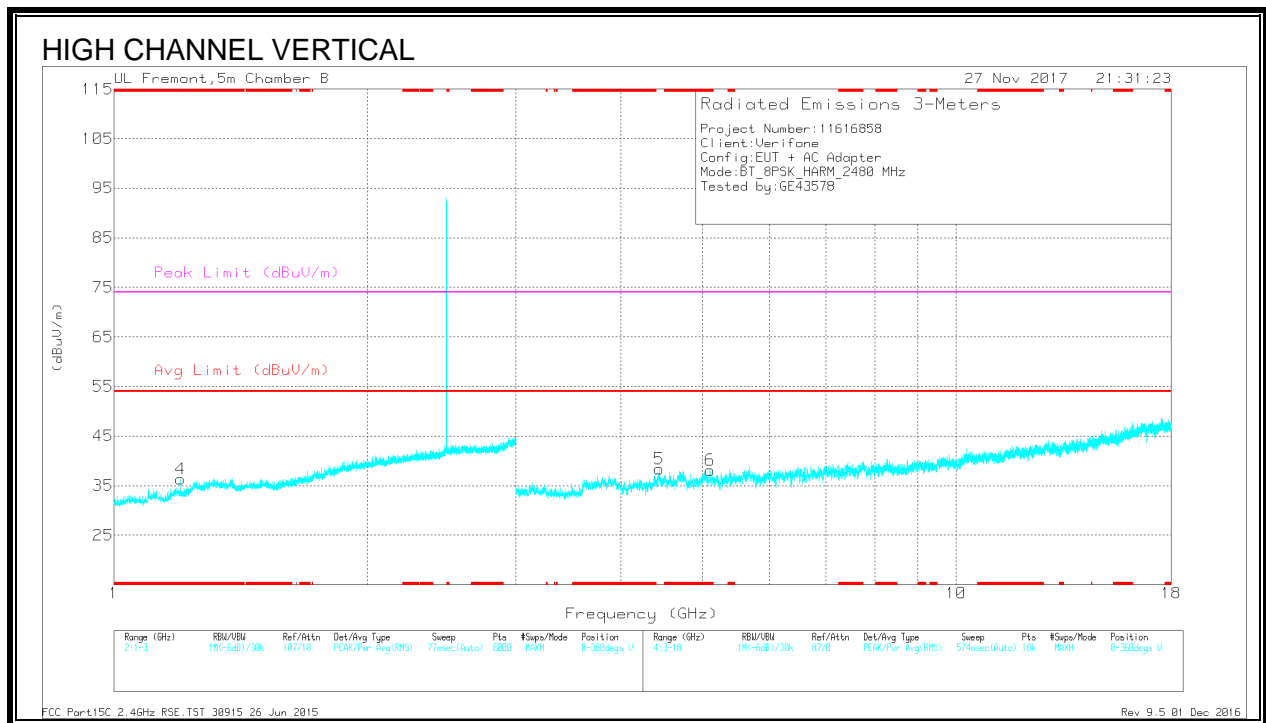
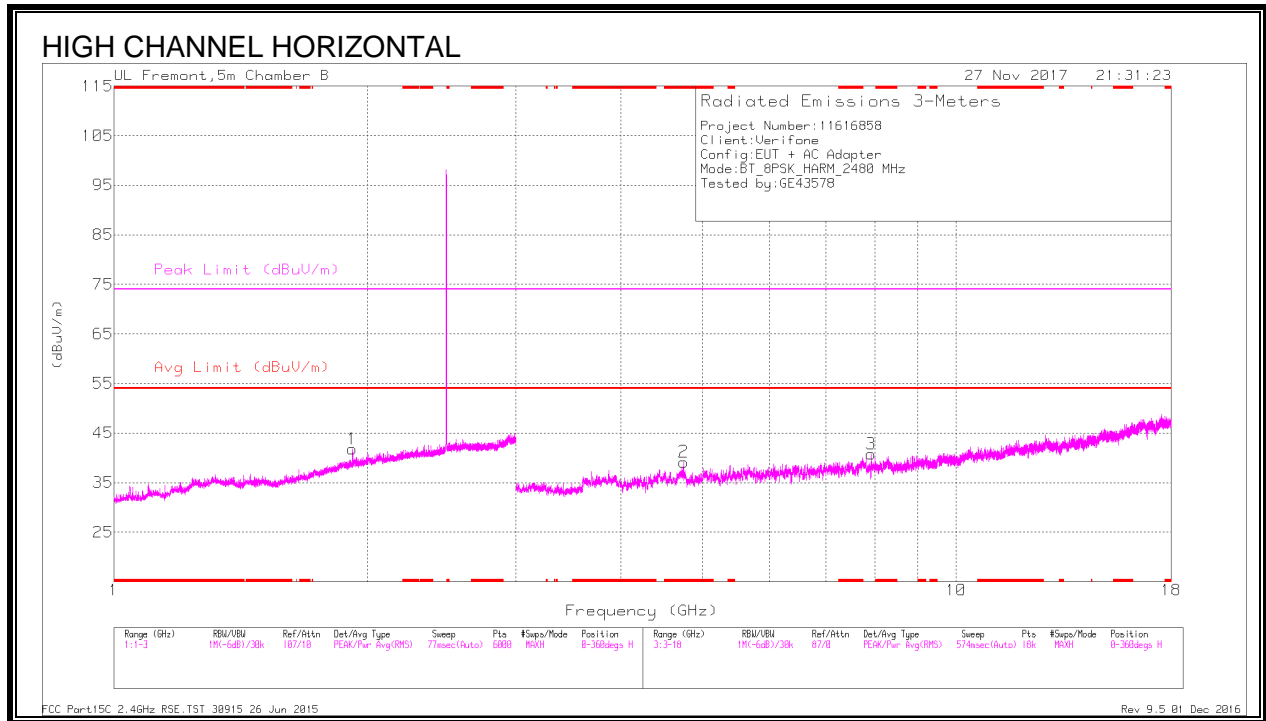

Radiated Emissions

Marker	Frequency (GHz)	Meter Reading (dBuV)	Det	AF T863 (dB/m)	Amp/Cbl/Fitr/Pad (dB)	Corrected Reading (dBuV/m)	Avg Limit (dBuV/m)	Margin (dB)	Peak Limit (dBuV/m)	PK Margin (dB)	Azimuth (Degs)	Height (cm)	Polarity
4	* 1.201	33.94	PKFH	28	-22.3	39.64	-	-	74	-34.36	345	200	V
	* 1.2	22.67	VA1T	28	-22.4	28.27	54	-25.73	-	-	345	200	V
2	* 4.742	37.79	PKFH	34.2	-28.3	43.69	-	-	74	-30.31	284	200	H
	* 4.742	26.65	VA1T	34.2	-28.4	32.45	54	-21.55	-	-	284	200	H
6	* 5.101	36.67	PKFH	34.3	-28.8	42.17	-	-	74	-31.83	74	200	V
	* 5.099	25.95	VA1T	34.3	-28.6	31.65	54	-22.35	-	-	74	200	V
1	1.92	35.55	PKFH	31	-20.9	45.65	-	-	-	-	318	101	H
	1.92	27.99	VA1T	31	-20.9	38.09	-	-	-	-	318	101	H
5	4.44	37.53	PKFH	33.8	-28.2	43.13	-	-	-	-	155	104	V
	4.442	26.01	VA1T	33.8	-28.2	31.61	-	-	-	-	155	104	V
3	7.929	34.53	PKFH	36	-25.4	45.13	-	-	-	-	201	200	H
	7.929	23.41	VA1T	36	-25.2	34.21	-	-	-	-	201	200	H

\* - indicates frequency in CFR47 Pt 15 / IC RSS-Restricted Band

PKFH - FHSS: RB=100k/1MHz VB=3 x RB, Peak

VA1T - FHSS: Linear Voltage Average VB=1/Ton where: Ton is transmit duration

## 7.6. WORST-CASE ABOVE 18 GHz

### SPURIOUS EMISSIONS 18 TO 26 GHz (WORST-CASE CONFIGURATION)

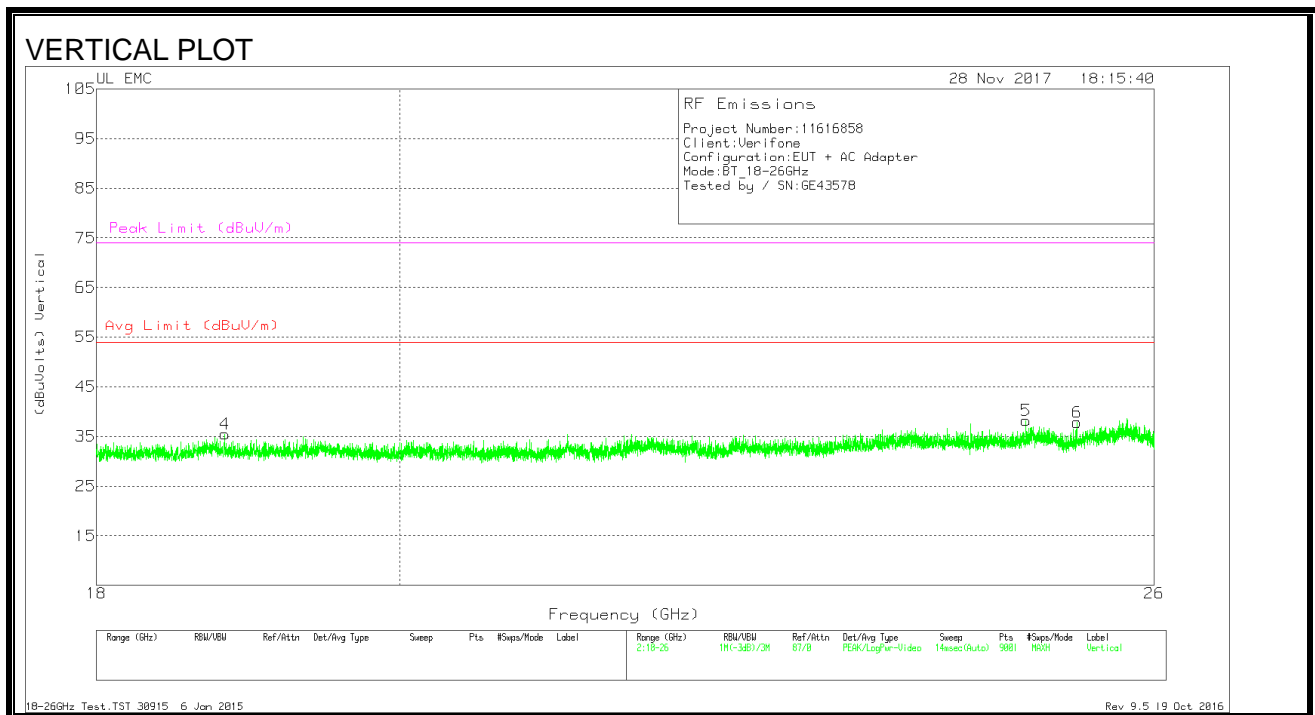
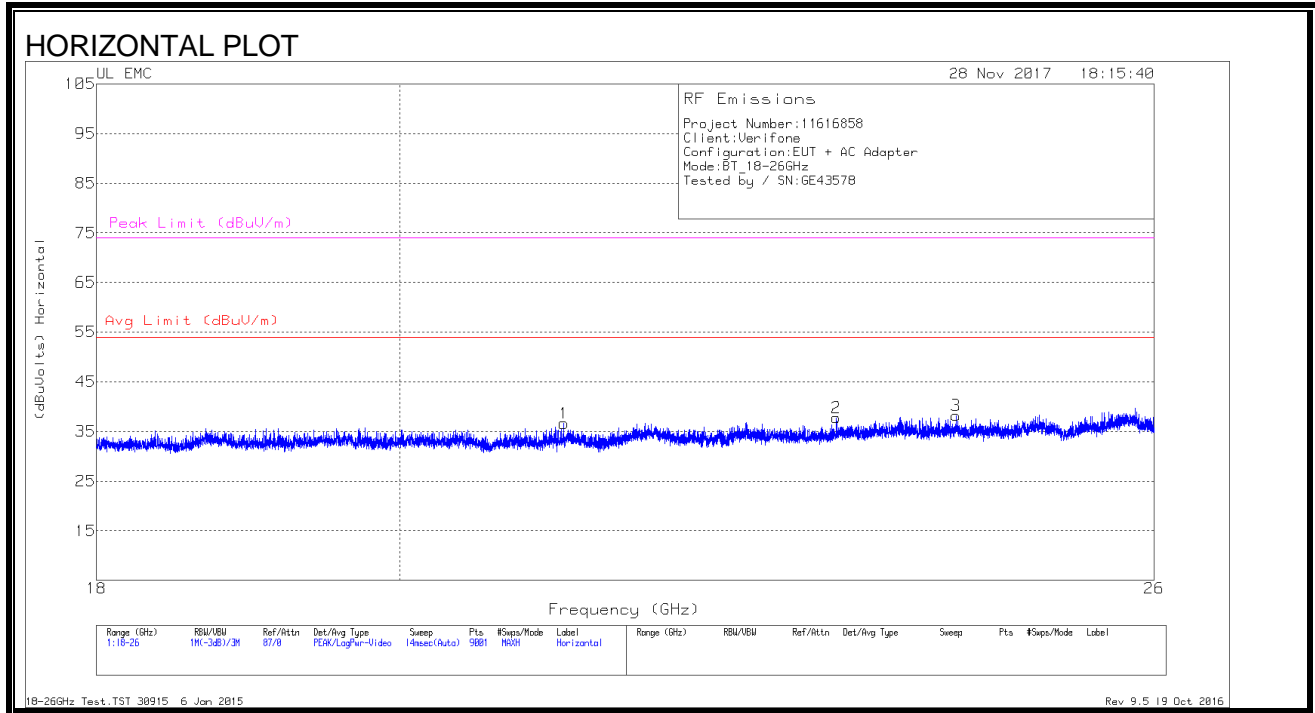

**Data**

Marker	Frequency (GHz)	Meter Reading (dBuV)	Det	T89 AF (dB/m)	Amp/Cbl (dB)	Dist Corr (dB)	Corrected Reading (dBuVolts)	Avg Limit (dBuV/m)	Margin (dB)	Peak Limit (dBuV/m)	PK Margin (dB)
1	21.175	38.32	Pk	33	-25.2	-9.5	36.62	54	-17.38	74	-37.38
2	23.279	38.47	Pk	33.5	-24.7	-9.5	37.77	54	-16.23	74	-36.23
3	24.268	38.28	Pk	33.6	-24.2	-9.5	38.18	54	-15.82	74	-35.82
4	18.821	37.57	Pk	32.4	-25	-9.5	35.47	54	-18.53	74	-38.53
5	24.866	38.28	Pk	34	-24.6	-9.5	38.18	54	-15.82	74	-35.82
6	25.312	38.23	Pk	33.6	-24.5	-9.5	37.83	54	-16.17	74	-36.17

Pk - Peak detector