



CERTIFICATION TEST REPORT

Report Number. : 11631998-E4V4

Applicant : Verifone, Inc.
1400 West Stanford Ranch Road
Rocklin, CA 95765, USA

Model : V240m Plus 3GBW

FCC ID : B32V240MPLUS

IC : 787C-V240MPLUS

EUT Description : Mobile Point of Sale Terminal

Test Standard(s) : FCC 47 CFR PART 15 SUBPART E (EXCEPT DFS)
INDUSTRY CANADA RSS - 247 ISSUE 2
INDUSTRY CANADA RSS-GEN ISSUE 4

Date Of Issue:

January 18, 2018

Prepared by:

UL Verification Services Inc.
47173 Benicia Street
Fremont, CA 94538, U.S.A.
TEL: (510) 771-1000
FAX: (510) 661-0888



Revision History

<u>Rev.</u>	<u>Issue Date</u>	<u>Revisions</u>	<u>Revised By</u>
V1	08/16/17	Initial Issue	D. Corona
V2	12/01/17	Added 802.11ac VHT80	D. Corona
V3	12/06/17	Updated Section 8.10.3, 8.11.3 and 8.12.3,	D. Corona
V4	01/18/18	Updated Section 7	D. Corona

TABLE OF CONTENTS

1. ATTESTATION OF TEST RESULTS	6
2. TEST METHODOLOGY	7
3. FACILITIES AND ACCREDITATION	7
4. CALIBRATION AND UNCERTAINTY	8
4.1. MEASURING INSTRUMENT CALIBRATION	8
4.2. SAMPLE CALCULATION	8
4.3. MEASUREMENT UNCERTAINTY	8
5. EQUIPMENT UNDER TEST	9
5.1. DESCRIPTION OF EUT	9
5.2. MAXIMUM OUTPUT POWER	9
5.3. DESCRIPTION OF AVAILABLE ANTENNAS	10
5.4. SOFTWARE AND FIRMWARE	10
5.5. WORST-CASE CONFIGURATION AND MODE	10
5.6. DESCRIPTION OF TEST SETUP	11
6. TEST AND MEASUREMENT EQUIPMENT	14
7. MEASUREMENT METHODS	15
8. ANTENNA PORT TEST RESULTS	16
8.1. ON TIME AND DUTY CYCLE	16
8.2. 11a MODE IN THE 5.2GHz BAND	19
8.2.1. 26 dB BANDWIDTH	19
8.2.2. 99% BANDWIDTH	22
8.2.3. OUTPUT POWER AND PPSD	25
8.3. 11n HT20 MODE IN THE 5.2GHz BAND	30
8.3.1. 26 dB BANDWIDTH	30
8.3.2. 99% BANDWIDTH	33
8.3.3. OUTPUT POWER AND PPSD	36
8.4. 11n HT40 MODE IN THE 5.2GHz BAND	41
8.4.1. 26 dB BANDWIDTH	41
8.4.2. 99% BANDWIDTH	43
8.4.3. OUTPUT POWER AND PPSD	45
8.5. 11ac VHT80 MODE IN THE 5.2GHz BAND	49
8.5.1. 26 dB BANDWIDTH	49
8.5.2. 99% BANDWIDTH	51
8.5.3. OUTPUT POWER AND PPSD	53
8.6. 11a MODE IN THE 5.3GHz BAND	57
8.6.1. 26 dB BANDWIDTH	57
8.6.2. 99% BANDWIDTH	60

8.6.3.	OUTPUT POWER AND PPSD	63
8.7.	<i>11n HT20 MODE IN THE 5.3GHz BAND</i>	67
8.7.1.	26 dB BANDWIDTH	67
8.7.2.	99% BANDWIDTH	70
8.7.3.	OUTPUT POWER AND PPSD	73
8.8.	<i>11n HT40 MODE IN THE 5.3GHz BAND</i>	77
8.8.1.	26 dB BANDWIDTH	77
8.8.2.	99% BANDWIDTH	79
8.8.3.	OUTPUT POWER AND PPSD	81
8.9.	<i>11ac VHT80 MODE IN THE 5.3GHz BAND</i>	84
8.9.1.	26 dB BANDWIDTH	84
8.9.2.	99% BANDWIDTH	86
8.9.3.	OUTPUT POWER AND PPSD	88
8.10.	<i>11a MODE IN THE 5.6GHz BAND</i>	91
8.10.1.	26 dB BANDWIDTH	91
8.10.2.	99% BANDWIDTH.....	94
8.10.3.	OUTPUT POWER AND PPSD	97
8.11.	<i>11n HT20 MODE IN THE 5.6GHz BAND</i>	101
8.11.1.	26 dB BANDWIDTH	101
8.11.2.	99% BANDWIDTH.....	104
8.11.3.	OUTPUT POWER AND PPSD	107
8.12.	<i>11n HT40 MODE IN THE 5.6GHz BAND</i>	111
8.12.1.	26 dB BANDWIDTH	111
8.12.2.	99% BANDWIDTH.....	114
8.12.3.	OUTPUT POWER AND PPSD.....	117
8.13.	<i>11ac VHT80 MODE IN THE 5.6GHz BAND</i>	121
8.13.1.	26 dB BANDWIDTH	121
8.13.2.	99% BANDWIDTH.....	123
8.13.3.	OUTPUT POWER AND PPSD	125
8.14.	<i>11a MODE IN THE 5.8GHz BAND</i>	128
8.14.1.	6 dB BANDWIDTH	128
8.14.2.	26 dB BANDWIDTH	131
8.14.3.	99% BANDWIDTH.....	134
8.14.4.	OUTPUT POWER AND PSD	137
8.15.	<i>11n HT20 MODE IN THE 5.8GHz BAND</i>	141
8.15.1.	6 dB BANDWIDTH	141
8.15.2.	26 dB BANDWIDTH	144
8.15.3.	99% BANDWIDTH.....	147
8.15.4.	OUTPUT POWER AND PSD	150
8.16.	<i>11n HT40 MODE IN THE 5.8GHz BAND</i>	154
8.16.1.	6 dB BANDWIDTH	154
8.16.2.	26 dB BANDWIDTH	156
8.16.3.	99% BANDWIDTH.....	158
8.16.4.	OUTPUT POWER AND PSD	160
8.17.	<i>11ac VHT80 MODE IN THE 5.8GHz BAND</i>	163
8.17.1.	6 dB BANDWIDTH	163
8.17.2.	26 dB BANDWIDTH	165
8.17.3.	99% BANDWIDTH.....	167

8.17.4.	OUTPUT POWER AND PSD	169
9.	RADIATED TEST RESULTS	172
9.1.	LIMITS AND PROCEDURE	172
9.1.1.	11a MODE IN THE 5.2GHz BAND	173
9.1.2.	11n HT20 MODE IN THE 5.2GHz BAND.....	181
9.1.3.	11n HT40 MODE IN THE 5.2GHz BAND.....	189
9.1.4.	11ac VHT80 MODE IN THE 5.2GHz BAND	195
9.1.5.	11a MODE IN THE 5.3GHz BAND	199
9.1.6.	11n HT20 MODE IN THE 5.3GHz BAND.....	207
9.1.7.	11n HT40 MODE IN THE 5.3GHz BAND.....	215
9.1.8.	11ac VHT80 MODE IN THE 5.3GHz BAND	221
9.1.9.	11a MODE IN THE 5.6GHz BAND	225
9.1.10.	11n HT20 MODE IN THE 5.6GHz BAND	235
9.1.11.	11n HT40 MODE IN THE 5.6GHz BAND	245
9.1.12.	11ac VHT80 MODE IN THE 5.6GHz BAND.....	255
9.1.13.	11a MODE IN THE 5.8GHz BAND.....	263
9.1.14.	11n HT20 MODE IN THE 5.8GHz BAND	273
9.1.15.	11n HT40 MODE IN THE 5.8GHz BAND	283
9.1.16.	11ac VHT80 MODE IN THE 5.8GHz BAND.....	291
9.2.	WORST-CASE BELOW 30 MHz.....	297
9.3.	WORST-CASE BELOW 1 GHz.....	298
9.4.	WORST-CASE 18 to 26 GHz.....	300
9.5.	WORST-CASE 26 to 40 GHz.....	302
10.	AC POWER LINE CONDUCTED EMISSIONS	304
11.	SETUP PHOTOS.....	307

1. ATTESTATION OF TEST RESULTS

COMPANY NAME: Verifone, Inc.
1400 West Stanford Ranch Road Suite 200
Rocklin, CA 95765, USA

EUT DESCRIPTION: Mobile Point of Sale Terminal.

MODEL: V240m Plus 3GBW

SERIAL NUMBER: 313-855-592, 313-855-662

DATE TESTED: APRIL 25 - MAY 31, 2017 AND NOVEMBER 29 -30, 2017

APPLICABLE STANDARDS	
STANDARD	TEST RESULTS
CFR 47 Part 15 Subpart E (Except DFS)	Pass
INDUSTRY CANADA RSS-247 Issue 2	Pass
INDUSTRY CANADA RSS-GEN Issue 4	Pass

*This report contains data that are not covered by the NVLAP accreditation.

UL Verification Services Inc. tested the above equipment in accordance with the requirements set forth in the above standards. All indications of Pass/Fail in this report are opinions expressed by UL Verification Services Inc. based on interpretations and/or observations of test results. Measurement Uncertainties were not taken into account and are published for informational purposes only. The test results show that the equipment tested is capable of demonstrating compliance with the requirements as documented in this report.

Note: The results documented in this report apply only to the tested sample, under the conditions and modes of operation as described herein. This document may not be altered or revised in any way unless done so by UL Verification Services Inc. and all revisions are duly noted in the revisions section. Any alteration of this document not carried out by UL Verification Services Inc. will constitute fraud and shall nullify the document. This report must not be used by the client to claim product certification, approval, or endorsement by NVLAP, NIST, any agency of the Federal Government, or any agency of any government.

Approved & Released For
UL Verification Services Inc. By:

Prepared By:



DAN CORONIA
OPERATIONS LEADER
UL VERIFICATION SERVICES INC.

GLENN ESCANO
TEST ENGINEER
UL VERIFICATION SERVICES INC.

2. TEST METHODOLOGY

FCC: The tests documented in this report were performed in accordance with FCC CFR 47 Part 2, FCC CFR 47 Part 15, FCC 14-30, FCC KDB 662911 D01 v02r01, FCC KDB 789033 D02 v01r04, FCC KDB 644545 D03 v01, ANSI C63.10-2013.

IC: The tests documented in this report were performed in accordance with FCC CFR 47 Part 2, FCC CFR 47 Part 15, FCC 14-30, FCC KDB 662911 D01 v02r01, FCC KDB 789033 D02 v01r04, FCC KDB 644545 D03 v01, ANSI C63.10-2013, RSS-GEN Issue 4, and RSS-247 Issue 2.

3. FACILITIES AND ACCREDITATION

The test sites and measurement facilities used to collect data are located at 47173 and 47266 Benicia Street, Fremont, California, USA. Line conducted emissions are measured only at the 47173 address. The following table identifies which facilities were utilized for radiated emission measurements documented in this report. Specific facilities are also identified in the test results sections.

47173 Benicia Street		47266 Benicia Street	
<input checked="" type="checkbox"/>	Chamber A (IC:2324B-1)	<input type="checkbox"/>	Chamber D (IC:22541-1)
<input checked="" type="checkbox"/>	Chamber B (IC:2324B-2)	<input type="checkbox"/>	Chamber E (IC:22541-2)
<input type="checkbox"/>	Chamber C (IC:2324B-3)	<input type="checkbox"/>	Chamber F (IC:22541-3)
		<input type="checkbox"/>	Chamber G (IC:22541-4)
		<input type="checkbox"/>	Chamber H (IC:22541-5)

The above test sites and facilities are covered under FCC Test Firm Registration # 208313. UL Verification Services Inc. is accredited by NVLAP, Laboratory Code 200065-0. Chambers A through C are covered under Industry Canada company address code 2324B with site numbers 2324B -1 through 2324B-3, respectively. Chambers D through H are covered under Industry Canada company address code 22541 with site numbers 22541 -1 through 22541-5, respectively.

4. CALIBRATION AND UNCERTAINTY

4.1. MEASURING INSTRUMENT CALIBRATION

The measuring equipment utilized to perform the tests documented in this report has been calibrated in accordance with the manufacturer's recommendations, and is traceable to recognized national standards.

4.2. SAMPLE CALCULATION

Where relevant, the following sample calculation is provided:

$$\begin{aligned} \text{Field Strength (dBuV/m)} &= \text{Measured Voltage (dBuV)} + \text{Antenna Factor (dB/m)} + \text{Cable} \\ &\text{Loss (dB)} - \text{Preamp Gain (dB)} \\ 36.5 \text{ dBuV} + 18.7 \text{ dB/m} + 0.6 \text{ dB} - 26.9 \text{ dB} &= 28.9 \text{ dBuV/m} \end{aligned}$$

4.3. MEASUREMENT UNCERTAINTY

Where relevant, the following measurement uncertainty levels have been estimated for tests performed on the apparatus:

Where relevant, the following measurement uncertainty levels have been estimated for tests performed on the apparatus:

Parameter	Uncertainty
Worst Case Conducted Disturbance, 9KHz to 0.15 MHz	3.84 dB
Worst Case Conducted Disturbance, 0.15 to 30 MHz	3.65 dB
Worst Case Radiated Disturbance, 9KHz to 30 MHz	3.15 dB
Worst Case Radiated Disturbance, 30 to 1000 MHz	5.36 dB
Worst Case Radiated Disturbance, 1000 to 18000 MHz	4.32 dB
Worst Case Radiated Disturbance, 18000 to 26000 MHz	4.45 dB
Worst Case Radiated Disturbance, 26000 to 40000 MHz	5.24 dB

Uncertainty figures are valid to a confidence level of 95%.

5. EQUIPMENT UNDER TEST

5.1. DESCRIPTION OF EUT

The EUT is the Mobile Point of Sale Terminal which contains an 11a/b/g/n/ac W-LAN + Bluetooth 4.1 combo module.

5.2. MAXIMUM OUTPUT POWER

The transmitter has a maximum conducted output power for SISO modes as follows:

5.2GHz Band

Frequency Range (MHz)	Mode	Output Power (dBm)	Output Power (mW)
5180 - 5240	802.11a	12.72	18.71
	802.11n HT20 SISO	12.49	17.74
5190 - 5230	802.11n HT40 SISO	12.70	18.62
5210	802.11ac VHT80 SISO	11.85	15.31

5.3GHz Band

Frequency Range (MHz)	Mode	Output Power (dBm)	Output Power (mW)
5260 - 5320	802.11a	13.30	21.38
	802.11n HT20 SISO	13.04	20.14
5270 - 5310	802.11n HT40 SISO	12.89	19.45
5290	802.11ac VHT80 SISO	12.02	15.92

5.6GHz Band

Frequency Range (MHz)	Mode	Output Power (dBm)	Output Power (mW)
5500 - 5700	802.11a	12.61	18.24
	802.11n HT20 SISO	12.47	17.66
5510 - 5670	802.11n HT40 SISO	12.37	17.26
5530 - 5610	802.11ac VHT80 SISO	12.05	16.03

5.8GHz Band

Frequency Range (MHz)	Mode	Output Power (dBm)	Output Power (mW)
5745 - 5825	802.11a	11.93	15.60
	802.11n HT20 SISO	11.52	14.19
5755 - 5795	802.11n HT40 SISO	11.55	14.29
5775	802.11ac VHT80 SISO	11.23	13.27

5.3. DESCRIPTION OF AVAILABLE ANTENNAS

The EUT utilizes WiFi antennas, with maximum gain as table below;

Frequency Band (GHz)	Antenna Gain (dBi)
	Chain 0
5.2	3.30
5.3	3.30
5.6	2.80
5.8	2.80

5.4. SOFTWARE AND FIRMWARE

The firmware installed in the EUT during testing was VOS2 – 30640xxx.

5.5. WORST-CASE CONFIGURATION AND MODE

Radiated bandedge, harmonics, and spurious emissions from 1 GHz to 18GHz were performed. The EUT was set to transmit at the Low/Middle/High channels.

Radiated emission below 1GHz, above 18GHz, and power line conducted emission were performed with the EUT was set to transmit at the channel with highest output power as worst-case scenario.

The fundamental of the EUT was investigated in three orthogonal orientations X/Y/Z, it was determined that X orientation was worst-case orientation. Therefore, all final radiated testing was performed with the EUT in X orientation.

Worst-case data rates as provided by the client were:

- 802.11a mode: 6 Mbps
- 802.11n HT20 mode: 13 Mbps (MCS0)
- 802.11n HT40 mode: 27 Mbps (MCS0)
- 802.11ac VHT80 mode: 58.5Mbps (MCS0)

5.6. DESCRIPTION OF TEST SETUP

SUPPORT EQUIPMENT

Support Equipment List				
Description	Manufacturer	Model	Serial Number	FCC ID
Laptop	Lenovo	20B7S0A200	PC015REW	NA
AC Adapter	Verifone	SC1402	1708200053701	NA
AC Adapter	Verifone	AM11A-050A	1650A1P	NA

I/O CABLES (CONDUCTED TEST)

I/O Cable List						
Cable No	Port	# of identical ports	Connector Type	Cable Type	Cable Length (m)	Remarks
1	Antenna	1	SMA	Un-Shielded	0.1	To spectrum Analyzer
2	DC	1	AC	Un-shielded	2	N/A
3	USB	1	USB	Shielded	2	N/A

I/O CABLES (RADIATED AND CONDUCTED EMISSIONS)

I/O Cable List						
Cable No	Port	# of identical ports	Connector Type	Cable Type	Cable Length (m)	Remarks
1	DC	1	AC	Un-shielded	2	N/A

TEST SETUP

CONDCUTED TEST SETUP DIAGRAM

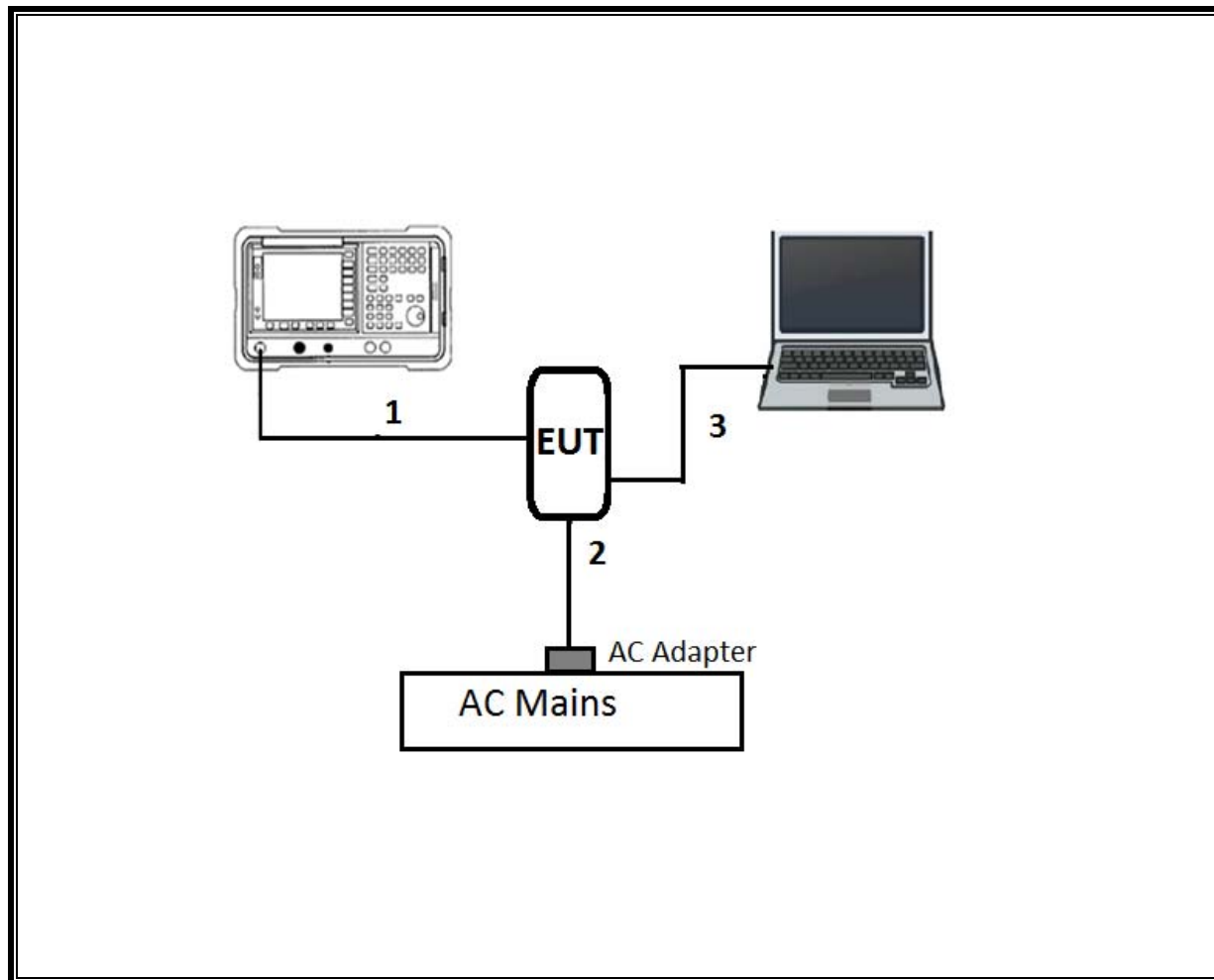

TEST SETUP

RADIATED AND AC LINE CONDUCTED EMISSIONS SETUP DIAGRAM

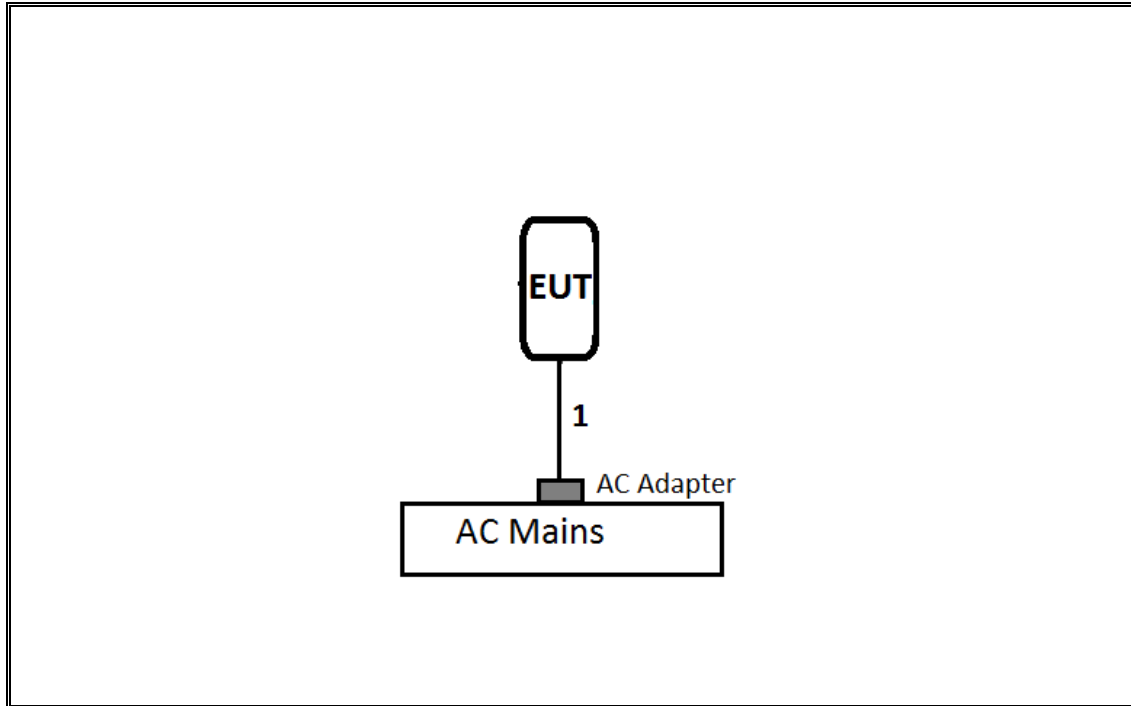

6. TEST AND MEASUREMENT EQUIPMENT

The following test and measurement equipment was utilized for the tests documented in this report:

TEST EQUIPMENT LIST				
Description	Manufacturer	Model	Asset	Cal Due
Antenna, Broadband Hybrid, 30MHz to 2000MHz w/4dB Pad	Sunol Sciences Corp.	JB3	T477	06/22/2017
Antenna, Active Loop 9kHz-30MHz	ETS-Lindgren	6502	T1683	02/17/2018
Antenna, Horn 1-18GHz	ETS-Lindgren	3117	T712	01/30/2018
Antenna, Horn 18-26.5GHz	ARA	MWH-1826/B	T449	06/12/2018
Antenna, Horn 26.5 - 40GHz	ARA	MWH-1826/B	T446	06/12/2018
Power Meter, P-series single channel	Agilent (Keysight) Technologies	N1911A	T1268	06/15/2018
Power Sensor, P – series, 50MHz to 18GHz, Wideband	Agilent (Keysight) Technologies	N1921A	T413	06/22/2018
Amplifier, 1-26.5GHz	MITEQ	AFS42-00101800-25-S-42	T1165	08/01/2018
Amplifier, 1-26.5GHz	Agilent (Keysight) Technologies	8449B	T404	07/05/2017
Amplifier, 10kHz-1GHz	Agilent (Keysight) Technologies	8447D	T15	08/26/2017
Amplifier, 1-8 GHz	MITEQ	AFS42-00101800-25-S-42	T931	08/26/2018
Pre-Amp, 26-40GHz	MITEQ	NSP4000-SP2	88	04/07/2018
Spectrum Analyzer, PSA, 3Hz to 26.5GHz	Agilent (Keysight) Technologies	E4446A	T99	06/22/2018
Spectrum Analyzer, PXA, 3Hz to 44GHz	Agilent (Keysight) Technologies	N9030A	T907	01/23/2018
Spectrum Analyzer, PSA, 3Hz to 26.5GHz	Agilent (Keysight) Technologies	E9030A	T905	01/11/2018
EMI Receiver	Rohde & Schwarz	ESR-EMI	1436	01/06/2018
LISN	FISCHER	FCC-LISN-50/250-25-2-01	T1310	06/08/2017

NOTE: *testing is completed before equipment calibration expiration date.

Test Software List			
Description	Manufacturer	Model	Version
Radiated Software	UL	UL EMC	Ver 9.5, Apr 26, 2016
Antenna Port Software	UL	UL RF	Ver 5.1.1, July 15, 2016

7. MEASUREMENT METHODS

On Time and Duty Cycle: KDB 789033 D02 v02r01, Section B.

26 dB Emission BW: KDB 789033 D02 v02r01, Section C.

99% Occupied BW: KDB 789033 D02 v02r01, Section D.

Conducted Output Power: KDB 789033 D02 v02r01, Section E.3.b (Method PM-G) and KDB 662911 D01 v02r01.

Power Spectral Density: KDB 789033 D02 v02r01, Section F and KDB 662911 D01 v02r01.

Unwanted emissions in restricted bands: KDB 789033 D02 v02r01, Sections G.3, G.4, G.5, and G.6.

Unwanted emissions in non-restricted bands: KDB 789033 D02 v02r01, Sections G.3, G.4, and G.5.

AC Power Line Conducted Emissions: ANSI C63.10-2013, Section 6.2.

8. ANTENNA PORT TEST RESULTS

8.1. ON TIME AND DUTY CYCLE

LIMITS

None; for reporting purposes only.

PROCEDURE

KDB 789033 Zero-Span Spectrum Analyzer Method.

RESULTS

Mode	ON Time B (msec)	Period (msec)	Duty Cycle x (linear)	Duty Cycle (%)	Duty Cycle Correction Factor (dB)	1/T Minimum VBW (kHz)
802.11a	1.429	1.528	0.935	93.5%	0.29	0.700
802.11n HT20	1.338	1.436	0.932	93.2%	0.31	0.747
802.11n HT40	0.968	1.067	0.907	90.7%	0.42	1.033
802.11ac VHT80	0.331	0.434	0.763	76.3%	1.18	3.021

DUTY CYCLE PLOTS

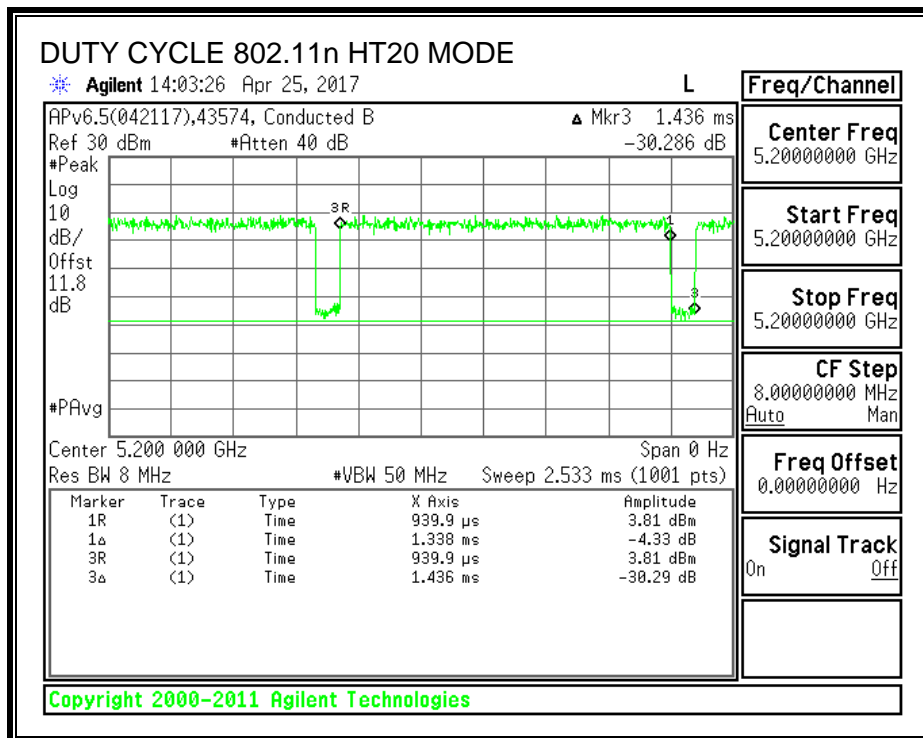
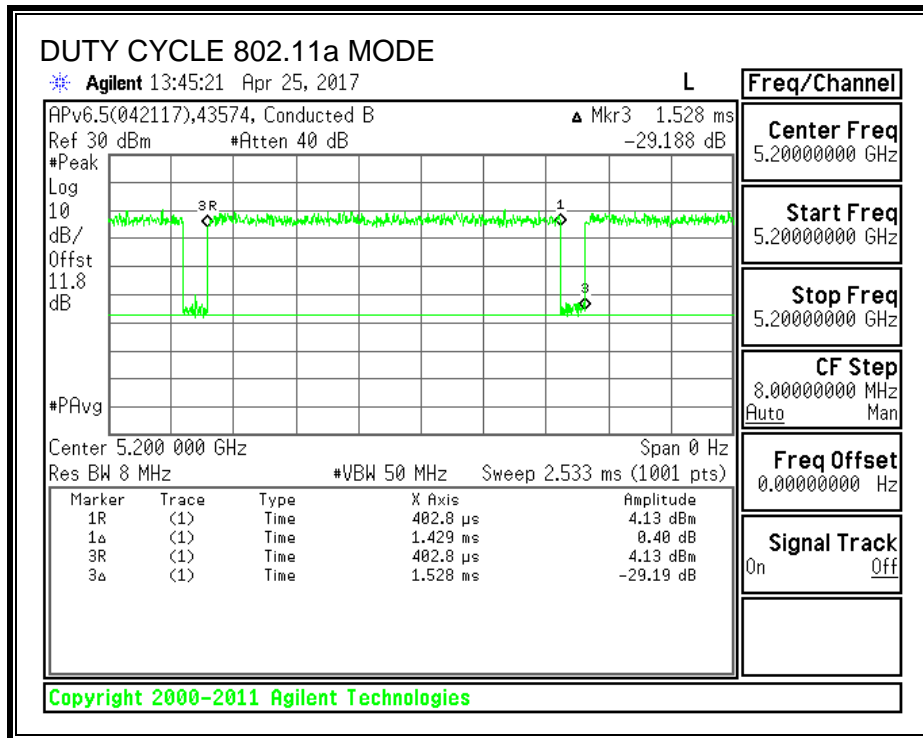

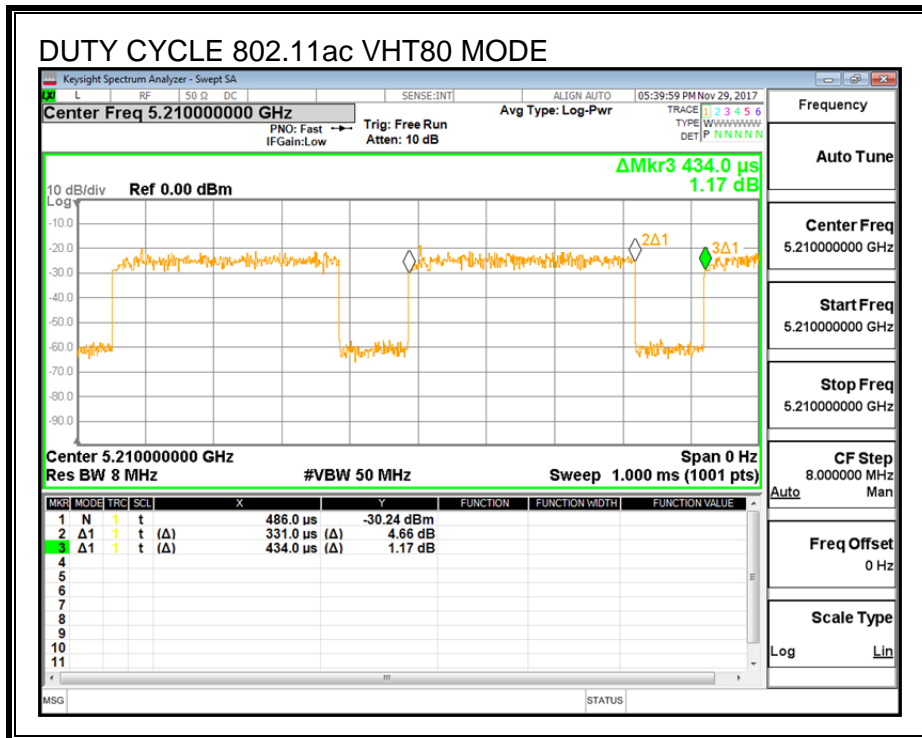
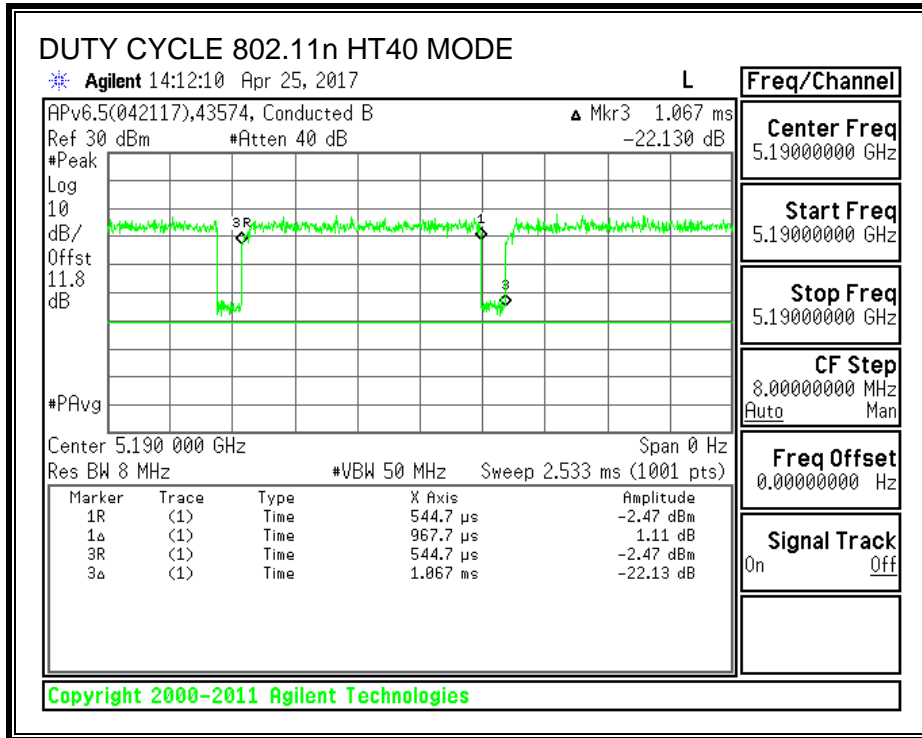

8.2. 11a MODE IN THE 5.2GHz BAND

8.2.1. 26 dB BANDWIDTH

LIMITS

None; for reporting purposes only.

RESULTS

Channel	Frequency	26 dB BW (MHz)
Low	5180	21.80
Mid	5200	21.80
High	5240	22.95

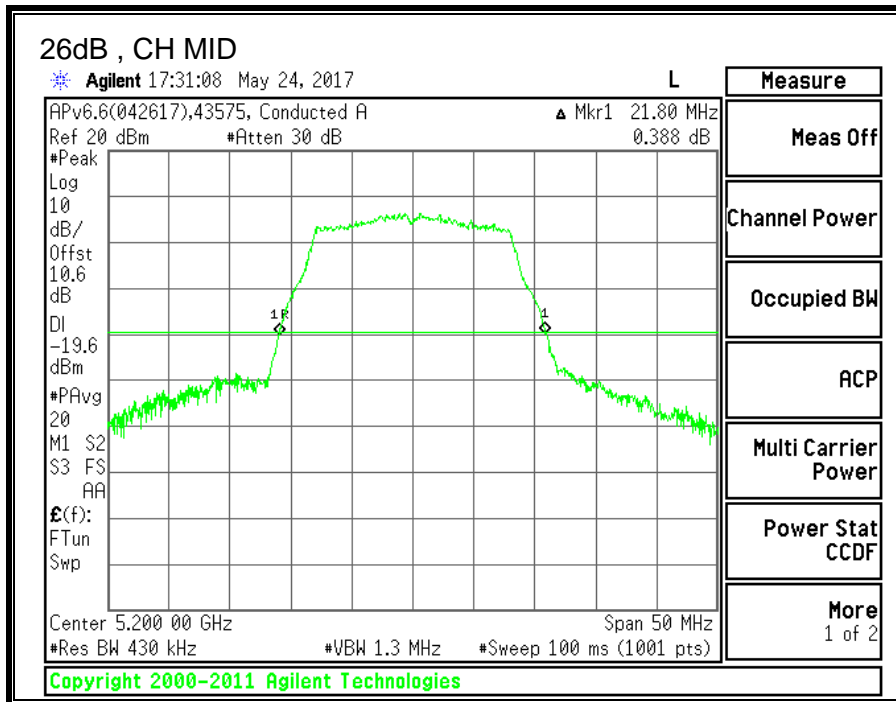
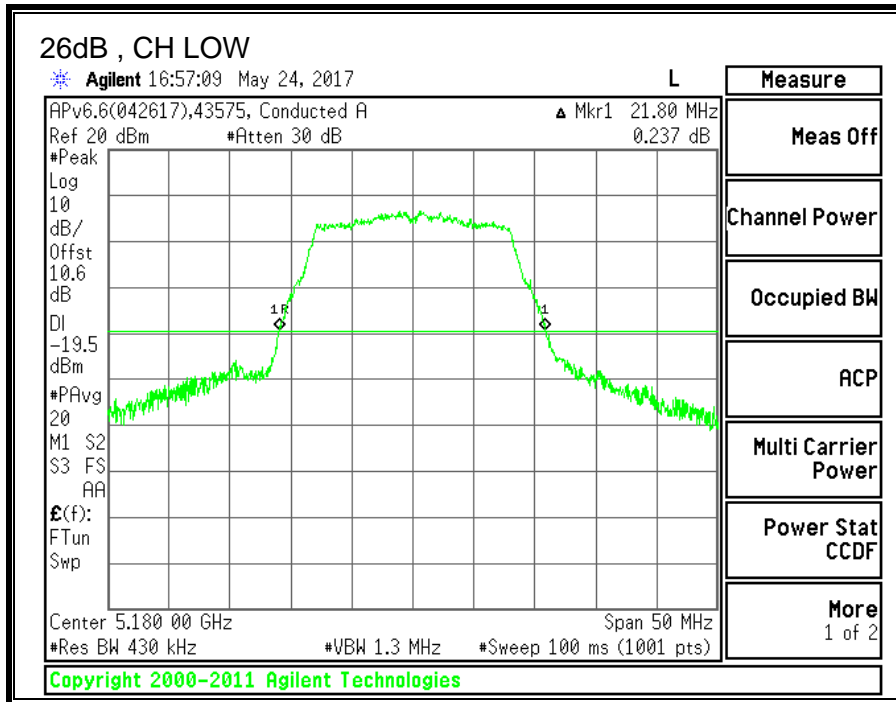

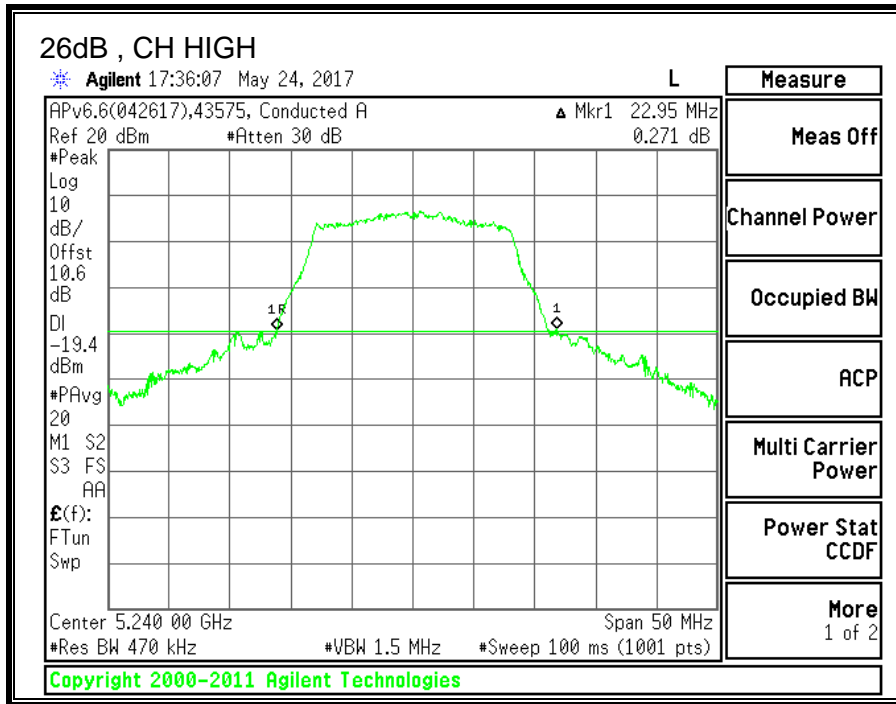

8.2.2. 99% BANDWIDTH

LIMITS

None; for reporting purposes only.

RESULTS

Channel	Frequency	99% BW (MHz)
Low	5180	16.0984
Mid	5200	16.5000
High	5240	16.3097

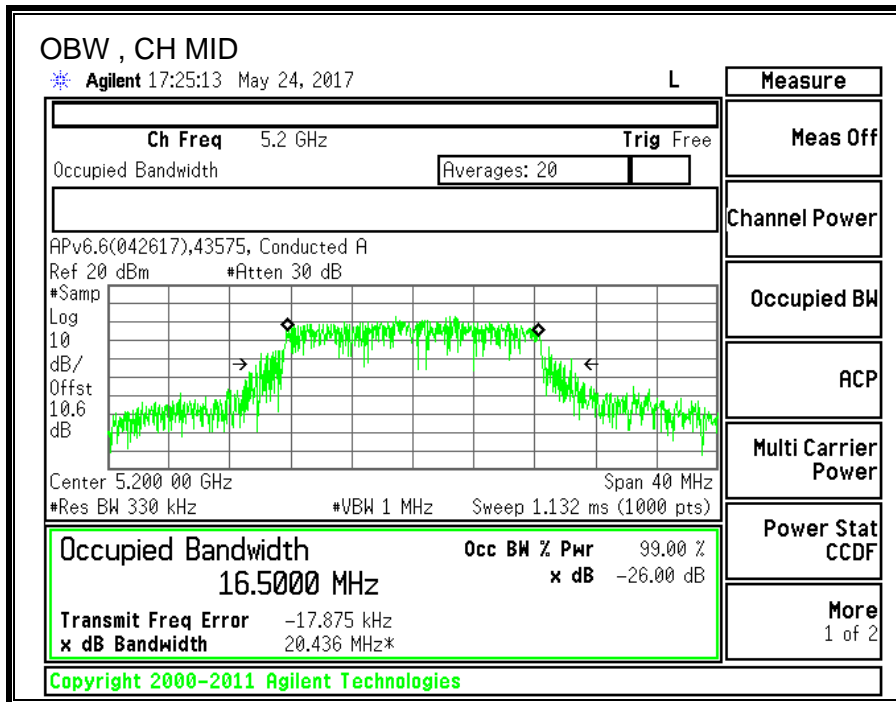
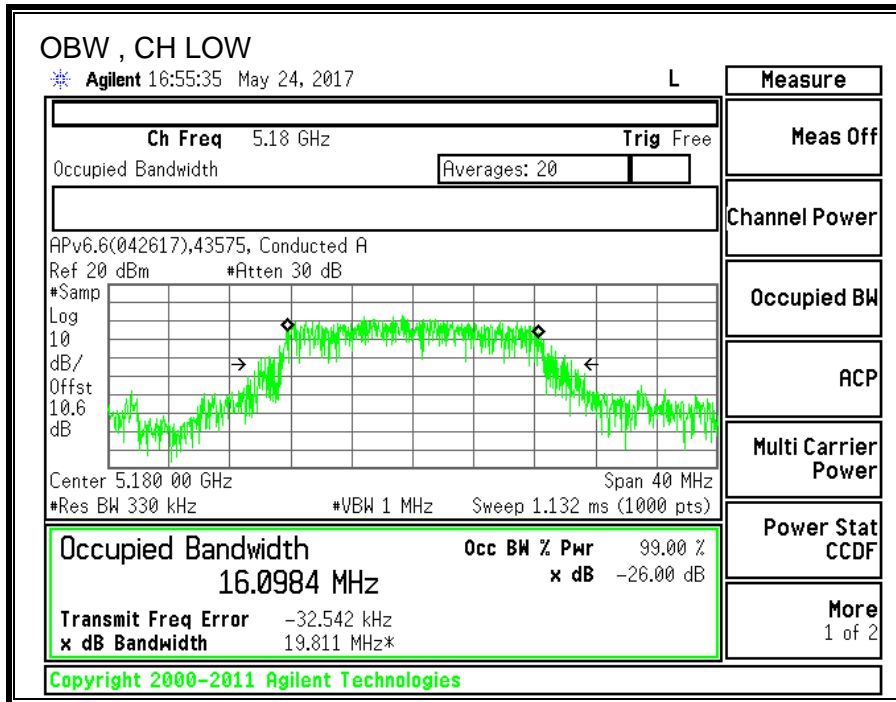

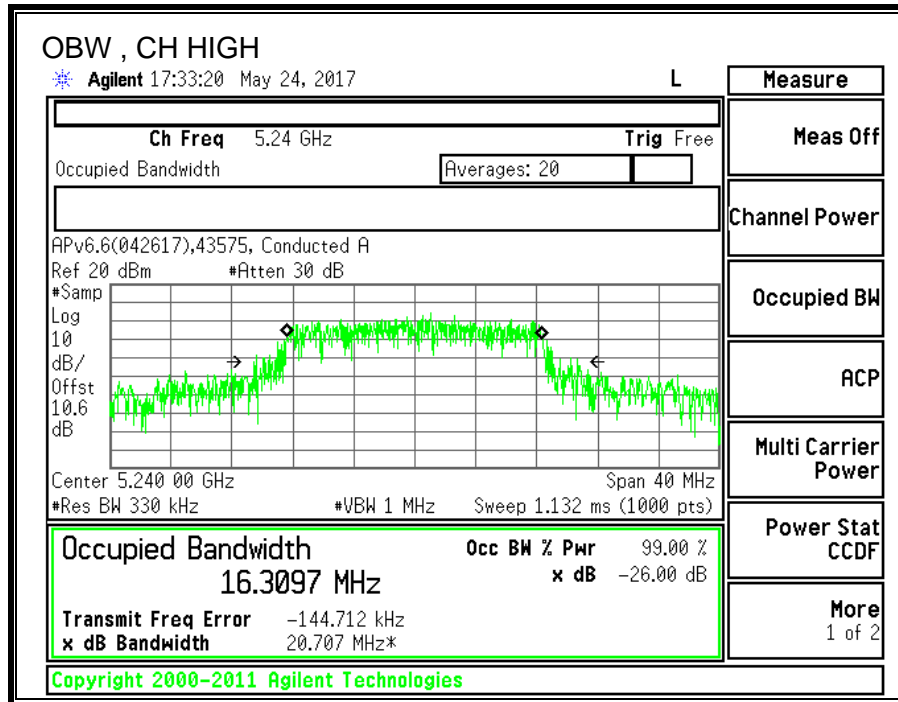

8.2.3. OUTPUT POWER AND PPSD

LIMITS

FCC §15.407 (a) (1)

(i) For an outdoor access point operating in the band 5.15-5.25 GHz, the maximum conducted output power over the frequency band of operation shall not exceed 1 W provided the maximum antenna gain does not exceed 6 dBi. In addition, the maximum power spectral density shall not exceed 17 dBm in any 1 megahertz band. If transmitting antennas of directional gain greater than 6 dBi are used, both the maximum conducted output power and the maximum power spectral density shall be reduced by the amount in dB that the directional gain of the antenna exceeds 6 dBi. The maximum e.i.r.p. at any elevation angle above 30 degrees as measured from the horizon must not exceed 125 mW (21 dBm).

(ii) For an indoor access point operating in the band 5.15-5.25 GHz, the maximum conducted output power over the frequency band of operation shall not exceed 1 W provided the maximum antenna gain does not exceed 6 dBi. In addition, the maximum power spectral density shall not exceed 17 dBm in any 1 megahertz band. If transmitting antennas of directional gain greater than 6 dBi are used, both the maximum conducted output power and the maximum power spectral density shall be reduced by the amount in dB that the directional gain of the antenna exceeds 6 dBi.

(iii) For fixed point-to-point access points operating in the band 5.15-5.25 GHz, the maximum conducted output power over the frequency band of operation shall not exceed 1 W. Fixed point-to-point U-NII devices may employ antennas with directional gain up to 23 dBi without any corresponding reduction in the maximum conducted output power or maximum power spectral density. For fixed point-to-point transmitters that employ a directional antenna gain greater than 23 dBi, a 1 dB reduction in maximum conducted output power and maximum power spectral density is required for each 1 dB of antenna gain in excess of 23 dBi. Fixed, point-to-point operations exclude the use of point-to-multipoint systems, omnidirectional applications, and multiple collocated transmitters transmitting the same information. The operator of the U-NII device, or if the equipment is professionally installed, the installer, is responsible for ensuring that systems employing high gain directional antennas are used exclusively for fixed, point-to-point operations.

(iv) For mobile and portable client devices in the 5.15-5.25 GHz band, the maximum conducted output power over the frequency band of operation shall not exceed 250 mW provided the maximum antenna gain does not exceed 6 dBi. In addition, the maximum power spectral density shall not exceed 11 dBm in any 1 megahertz band. If transmitting antennas of directional gain greater than 6 dBi are used, both the maximum conducted output power and the maximum power spectral density shall be reduced by the amount in dB that the directional gain of the antenna exceeds 6 dBi.

IC RSS-247 (6.2.1.1)

The maximum EIRP shall not exceed 200 mW or $10 + 10 \log_{10} B$, dBm, whichever power is less. B is the 99% emission bandwidth in MHz. The e.i.r.p. spectral density shall not exceed 10 dBm in any 1.0 MHz band.

TEST PROCEDURE

Measurements perform using a wideband gated RF power meter provided that the gate parameters are adjusted such that the power is measured only when the EUT is transmitting at its maximum power control level. Since the measurement is made only during the ON time of the transmitter, no duty cycle correction factor is required.

DIRECTIONAL ANTENNA GAIN

There is only one transmitter output therefore the directional gain is equal to the antenna gain.

RESULTS

ID:	43574	Date:	5/24/17
------------	-------	--------------	---------

Bandwidth and Antenna Gain

Channel	Frequency (MHz)	Min 26 dB BW (MHz)	Min 99% BW (MHz)	Directional Gain for Power (dBi)	Directional Gain for PPSD (dBi)
Low	5180	21.80	16.0984	3.30	3.30
Mid	5200	21.80	16.5000	3.30	3.30
High	5240	22.95	16.3097	3.30	3.30

Limits

Channel	Frequency (MHz)	FCC Power Limit (dBm)	IC EIRP Limit (dBm)	Max IC Power (dBm)	Power Limit (dBm)	FCC PPSD Limit (dBm)	IC eirp PSD Limit (dBm)	PPSD Limit (dBm)
Low	5180	24.00	22.07	18.77	18.77	11.00	10.00	6.70
Mid	5200	24.00	22.17	18.87	18.87	11.00	10.00	6.70
High	5240	24.00	22.12	18.82	18.82	11.00	10.00	6.70

Duty Cycle CF (dB)	0.29	Included in Calculations of Corr'd PPSD
---------------------------	------	--

Output Power Results

Channel	Frequency (MHz)	Meas Power (dBm)	Total Corr'd Power (dBm)	Power Limit (dBm)	Power Margin (dB)
Low	5180	12.72	12.72	18.77	-6.05
Mid	5200	12.69	12.69	18.87	-6.18
High	5240	12.49	12.49	18.82	-6.33

PPSD Results

Channel	Frequency (MHz)	Meas PPSD (dBm)	Total Corr'd PPSD (dBm)	PPSD Limit (dBm)	PPSD Margin (dB)
Low	5180	2.206	2.496	6.70	-4.20
Mid	5200	2.837	3.127	6.70	-3.57
High	5240	2.775	3.065	6.70	-3.64

Note: the power readings above were measured with gated method, and the measurement was taken only during the ON time. No duty cycle correction was necessary.

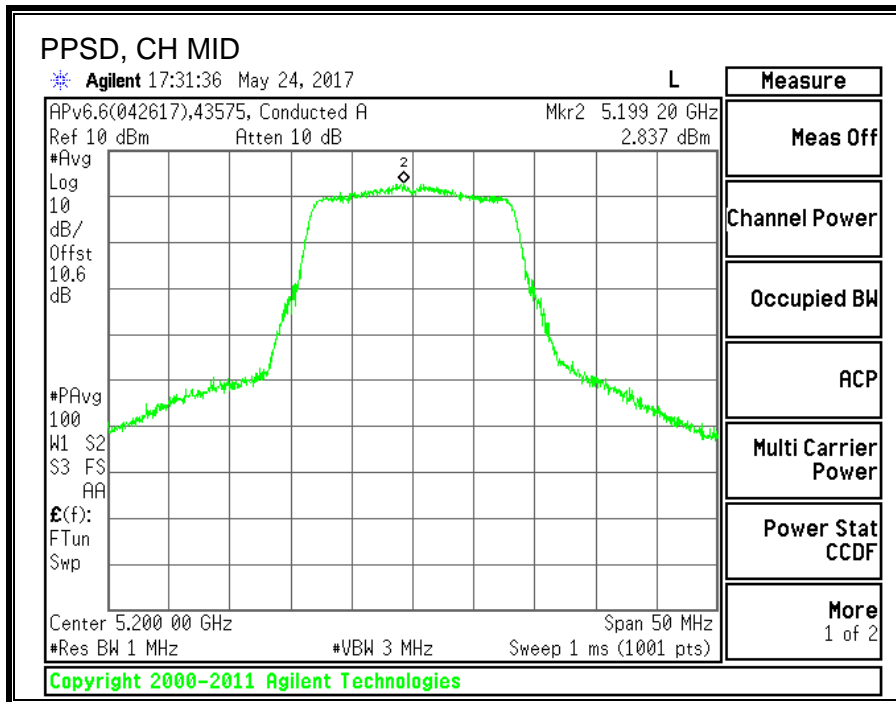
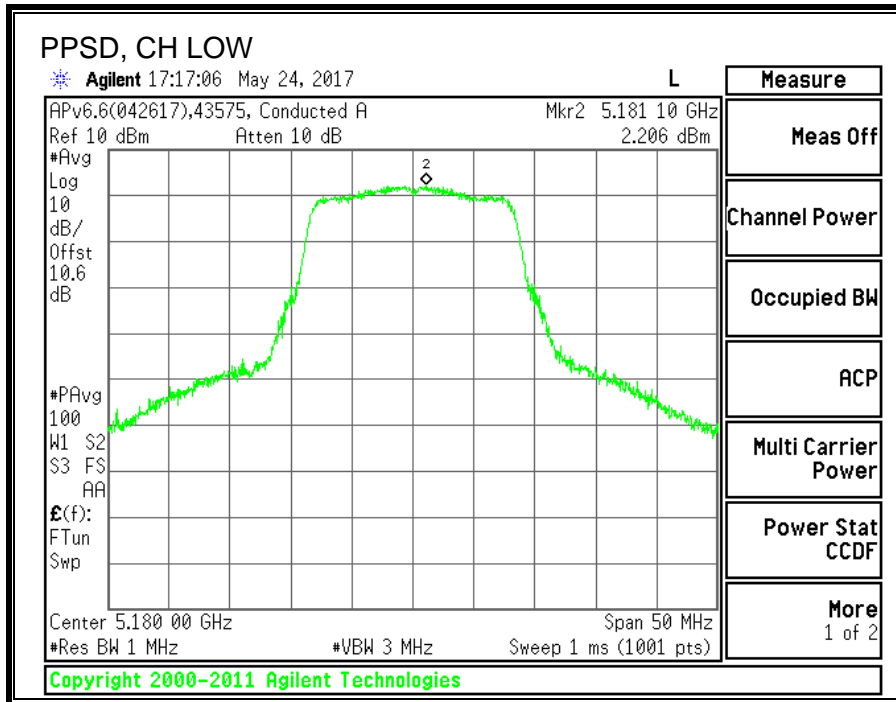

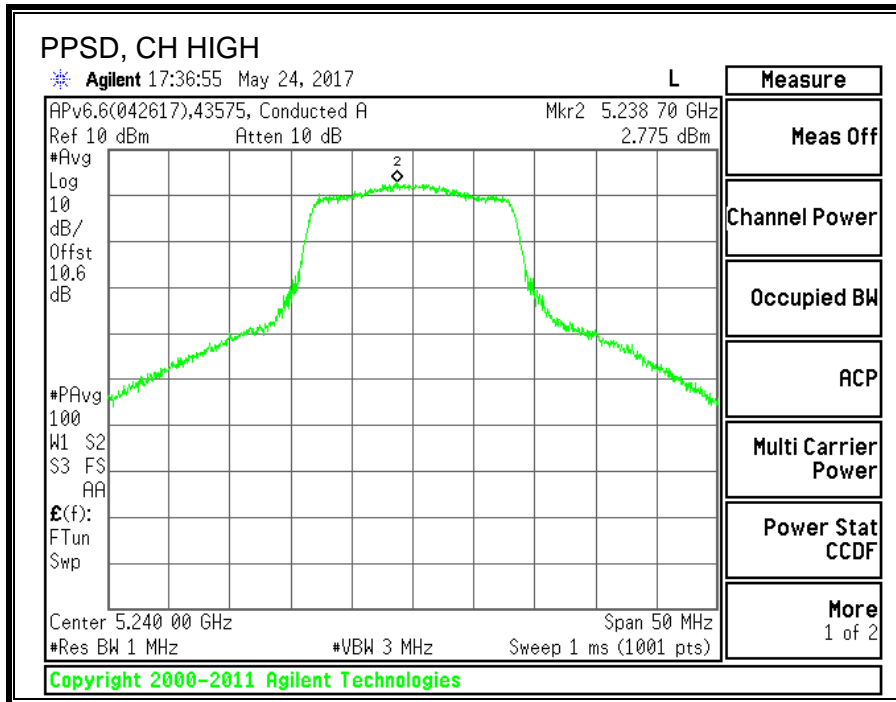

8.3. 11n HT20 MODE IN THE 5.2GHz BAND

8.3.1. 26 dB BANDWIDTH

LIMITS

None; for reporting purposes only.

RESULTS

Channel	Frequency	26 dB BW (MHz)
Low	5180	21.90
Mid	5200	21.90
High	5240	22.05

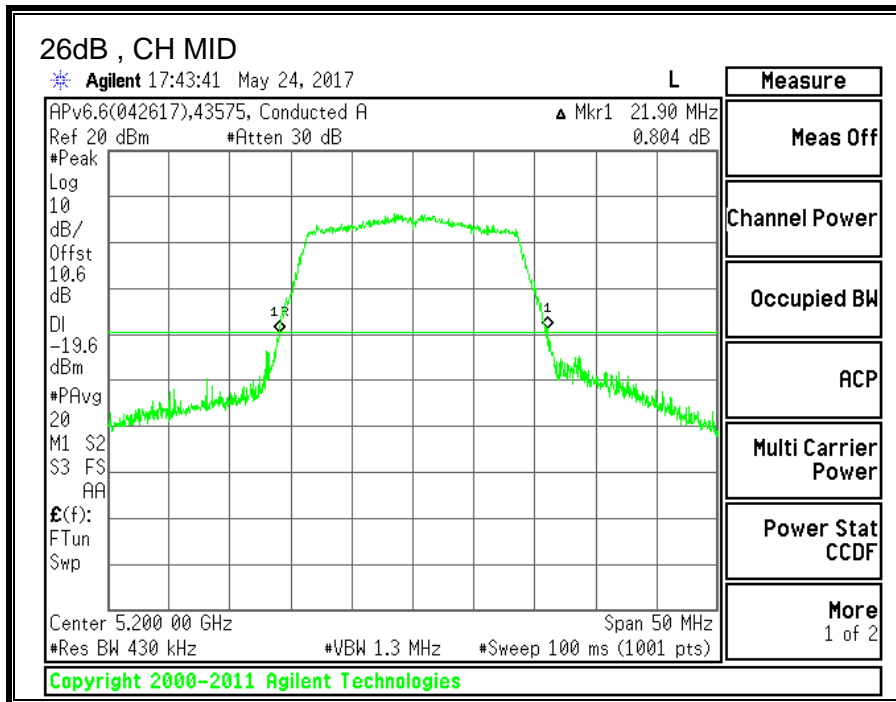
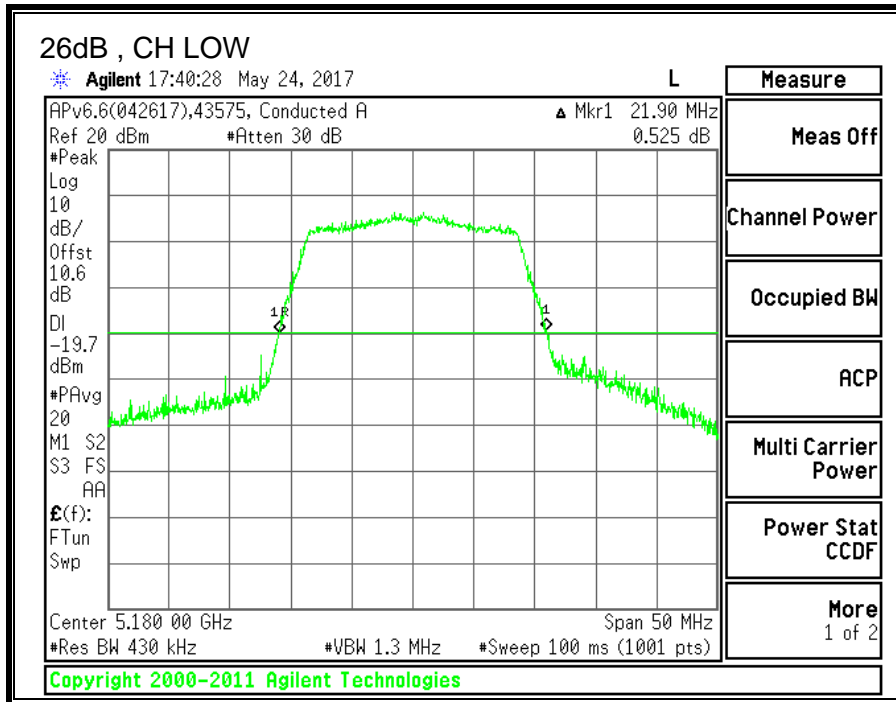

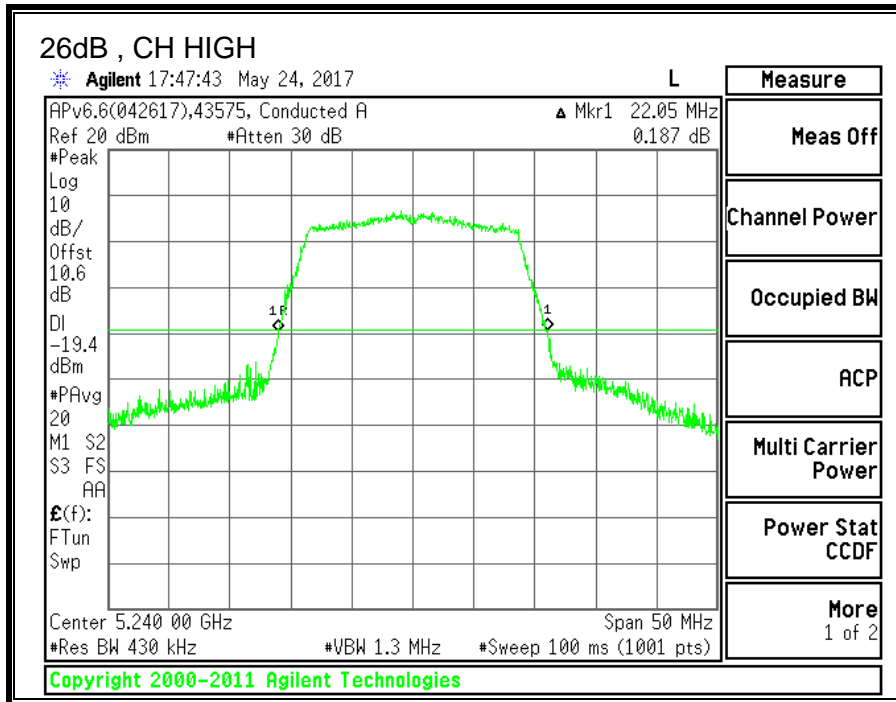

8.3.2. 99% BANDWIDTH

LIMITS

None; for reporting purposes only.

RESULTS

Channel	Frequency	99% BW (MHz)
Low	5180	17.3390
Mid	5200	17.3036
High	5240	17.3256

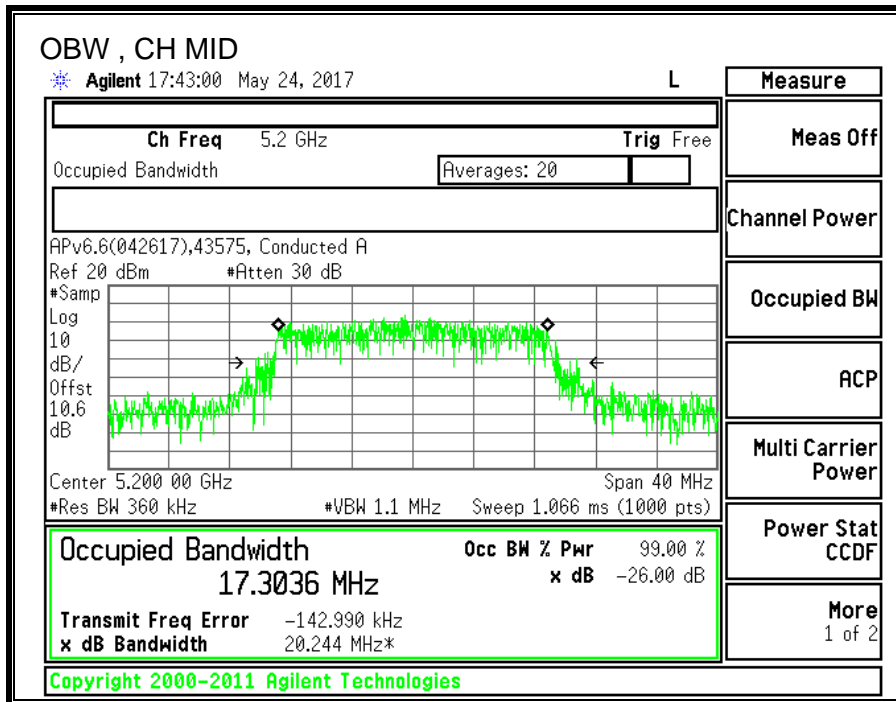
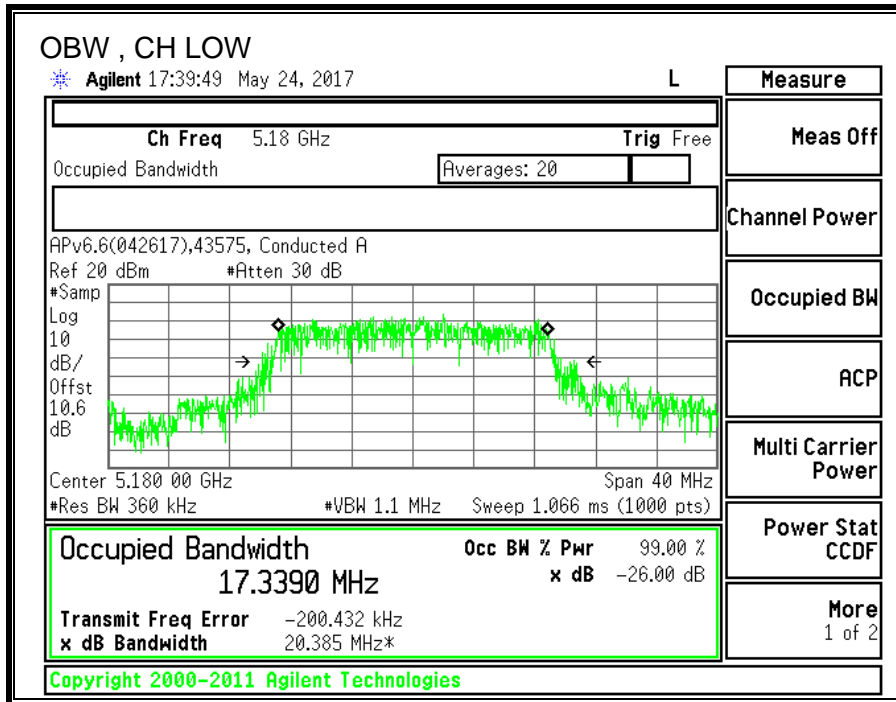

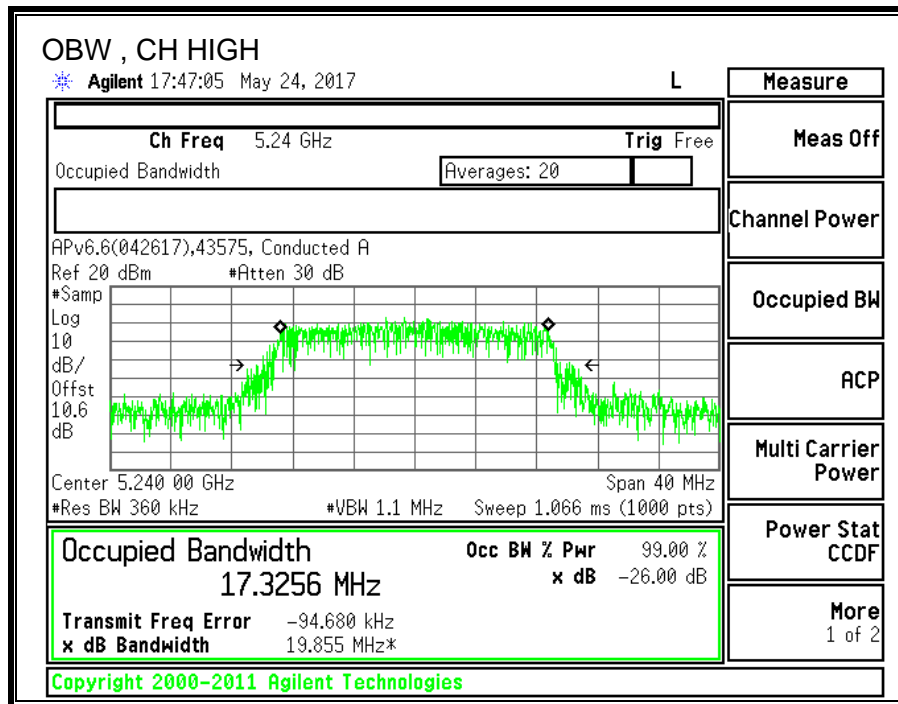

8.3.3. OUTPUT POWER AND PPSD

LIMITS

FCC §15.407 (a) (1)

(i) For an outdoor access point operating in the band 5.15-5.25 GHz, the maximum conducted output power over the frequency band of operation shall not exceed 1 W provided the maximum antenna gain does not exceed 6 dBi. In addition, the maximum power spectral density shall not exceed 17 dBm in any 1 megahertz band. If transmitting antennas of directional gain greater than 6 dBi are used, both the maximum conducted output power and the maximum power spectral density shall be reduced by the amount in dB that the directional gain of the antenna exceeds 6 dBi. The maximum e.i.r.p. at any elevation angle above 30 degrees as measured from the horizon must not exceed 125 mW (21 dBm).

(ii) For an indoor access point operating in the band 5.15-5.25 GHz, the maximum conducted output power over the frequency band of operation shall not exceed 1 W provided the maximum antenna gain does not exceed 6 dBi. In addition, the maximum power spectral density shall not exceed 17 dBm in any 1 megahertz band. If transmitting antennas of directional gain greater than 6 dBi are used, both the maximum conducted output power and the maximum power spectral density shall be reduced by the amount in dB that the directional gain of the antenna exceeds 6 dBi.

(iii) For fixed point-to-point access points operating in the band 5.15-5.25 GHz, the maximum conducted output power over the frequency band of operation shall not exceed 1 W. Fixed point-to-point U-NII devices may employ antennas with directional gain up to 23 dBi without any corresponding reduction in the maximum conducted output power or maximum power spectral density. For fixed point-to-point transmitters that employ a directional antenna gain greater than 23 dBi, a 1 dB reduction in maximum conducted output power and maximum power spectral density is required for each 1 dB of antenna gain in excess of 23 dBi. Fixed, point-to-point operations exclude the use of point-to-multipoint systems, omnidirectional applications, and multiple collocated transmitters transmitting the same information. The operator of the U-NII device, or if the equipment is professionally installed, the installer, is responsible for ensuring that systems employing high gain directional antennas are used exclusively for fixed, point-to-point operations.

(iv) For mobile and portable client devices in the 5.15-5.25 GHz band, the maximum conducted output power over the frequency band of operation shall not exceed 250 mW provided the maximum antenna gain does not exceed 6 dBi. In addition, the maximum power spectral density shall not exceed 11 dBm in any 1 megahertz band. If transmitting antennas of directional gain greater than 6 dBi are used, both the maximum conducted output power and the maximum power spectral density shall be reduced by the amount in dB that the directional gain of the antenna exceeds 6 dBi.

IC RSS-247 (6.2.1.1)

The maximum EIRP shall not exceed 200 mW or $10 + 10 \log_{10} B$, dBm, whichever power is less. B is the 99% emission bandwidth in MHz. The e.i.r.p. spectral density shall not exceed 10 dBm in any 1.0 MHz band.

TEST PROCEDURE

Measurements perform using a wideband gated RF power meter provided that the gate parameters are adjusted such that the power is measured only when the EUT is transmitting at its maximum power control level. Since the measurement is made only during the ON time of the transmitter, no duty cycle correction factor is required.

DIRECTIONAL ANTENNA GAIN

There is only one transmitter output therefore the directional gain is equal to the antenna gain.

RESULTS

ID:	43574	Date:	5/24/17
------------	-------	--------------	---------

Bandwidth and Antenna Gain

Channel	Frequency (MHz)	Min 26 dB BW (MHz)	Min 99% BW (MHz)	Directional Gain for Power (dBi)	Directional Gain for PPSD (dBi)
Low	5180	21.90	17.3390	3.30	3.30
Mid	5200	21.90	17.3036	3.30	3.30
High	5240	22.05	17.3256	3.30	3.30

Limits

Channel	Frequency (MHz)	FCC Power Limit (dBm)	IC EIRP Limit (dBm)	Max IC Power (dBm)	Power Limit (dBm)	FCC PPSD Limit (dBm)	IC eirp PSD Limit (dBm)	PPSD Limit (dBm)
Low	5180	24.00	22.39	19.09	19.09	11.00	10.00	6.70
Mid	5200	24.00	22.38	19.08	19.08	11.00	10.00	6.70
High	5240	24.00	22.39	19.09	19.09	11.00	10.00	6.70

Duty Cycle CF (dB)	0.31	Included in Calculations of Corr'd PPSD
---------------------------	------	--

Output Power Results

Channel	Frequency (MHz)	Meas Power (dBm)	Total Corr'd Power (dBm)	Power Limit (dBm)	Power Margin (dB)
Low	5180	12.45	12.45	19.09	-6.64
Mid	5200	12.34	12.34	19.08	-6.74
High	5240	12.49	12.49	19.09	-6.60

PPSD Results

Channel	Frequency (MHz)	Meas PPSD (dBm)	Total Corr'd PPSD (dBm)	PPSD Limit (dBm)	PPSD Margin (dB)
Low	5180	1.834	2.144	6.70	-4.56
Mid	5200	2.393	2.703	6.70	-4.00
High	5240	2.237	2.547	6.70	-4.15

Note: the power readings above were measured with gated method, and the measurement was taken only during the ON time. No duty cycle correction was necessary.

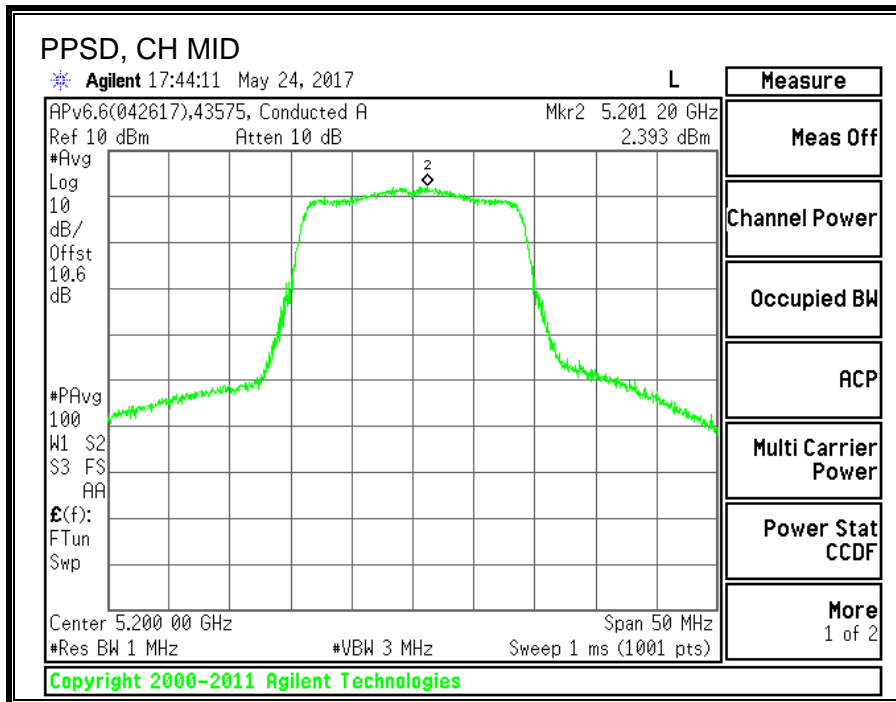
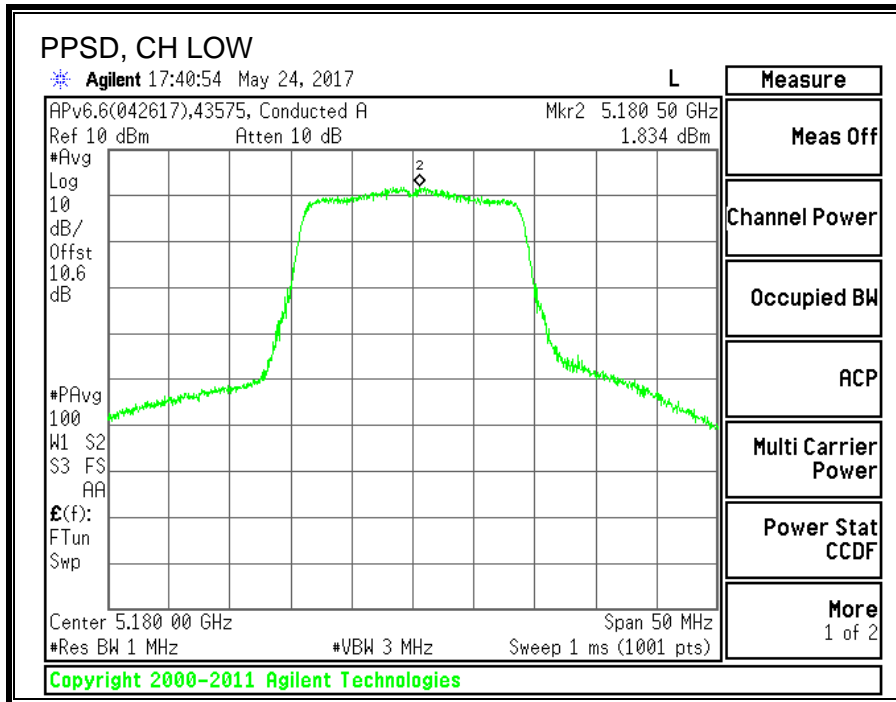

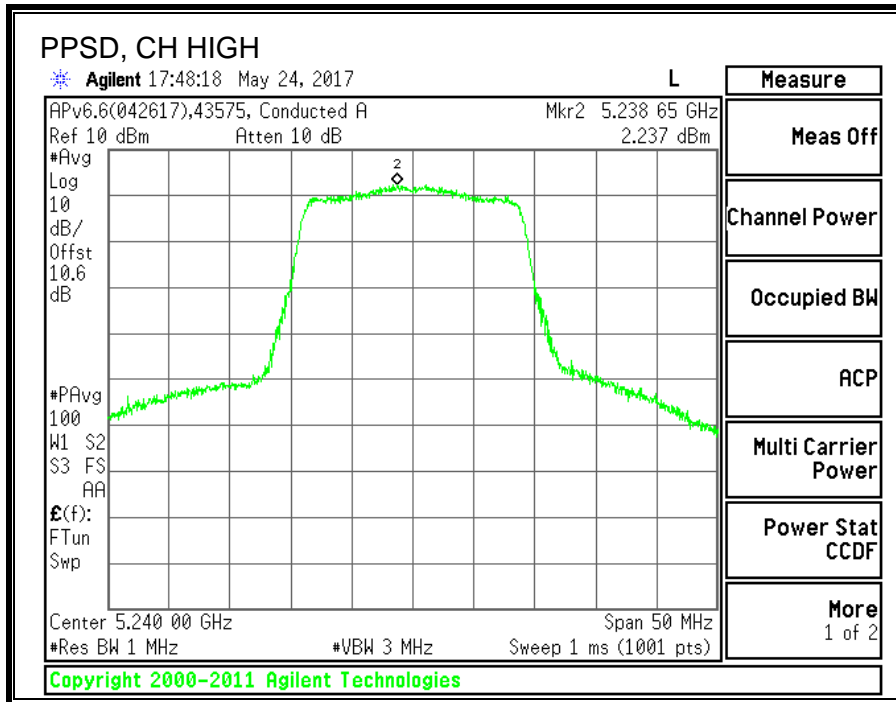

8.4. 11n HT40 MODE IN THE 5.2GHz BAND

8.4.1. 26 dB BANDWIDTH

LIMITS

None; for reporting purposes only.

RESULTS

Channel	Frequency	26 dB BW (MHz)
Low	5190	40.8
High	5230	40.7

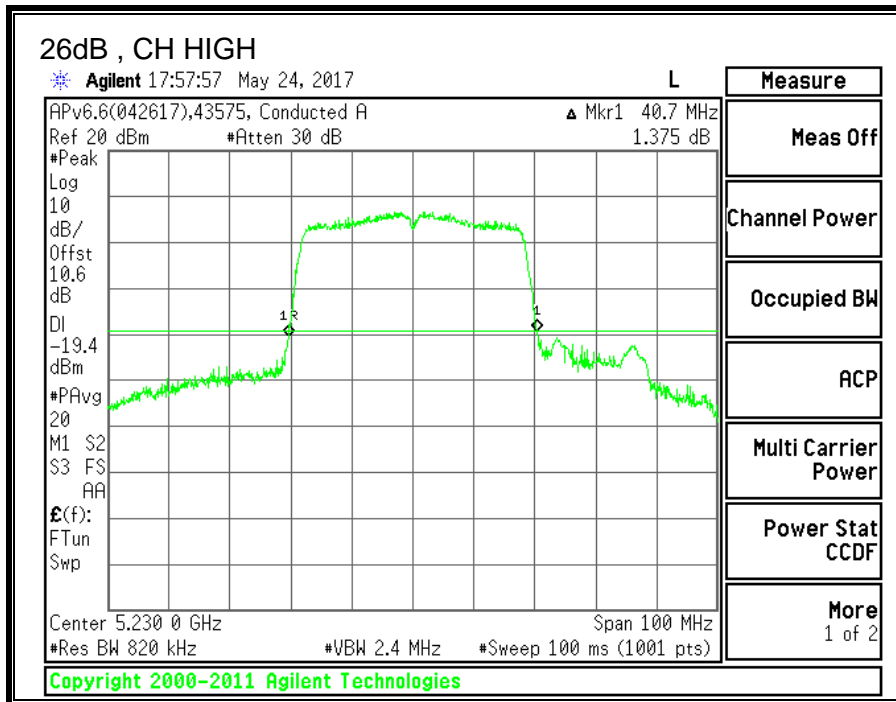
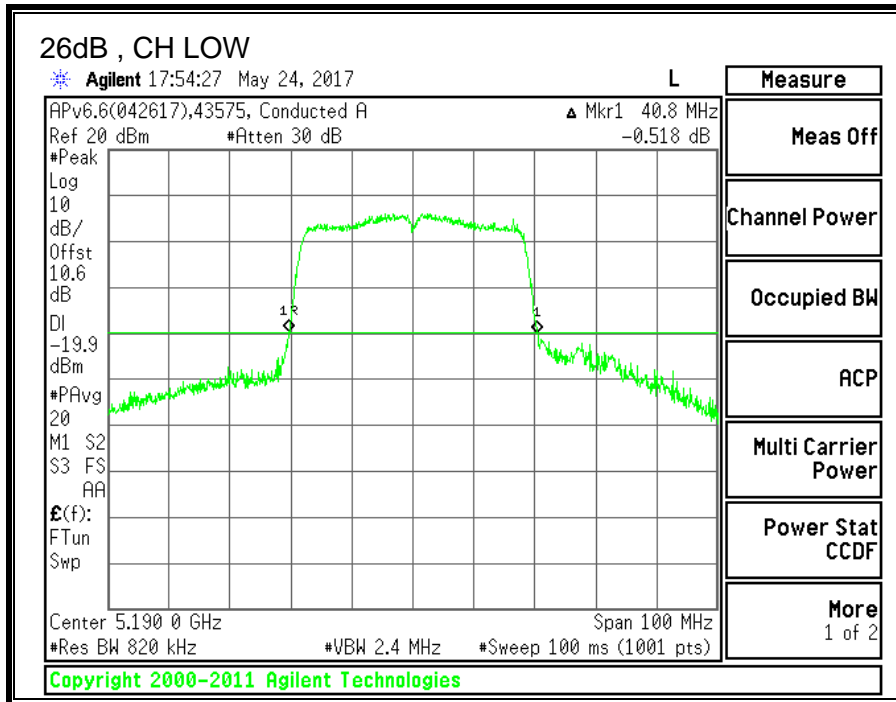

8.4.2. 99% BANDWIDTH

LIMITS

None; for reporting purposes only.

RESULTS

Channel	Frequency	99% BW (MHz)
Low	5190	35.5463
High	5230	36.2701

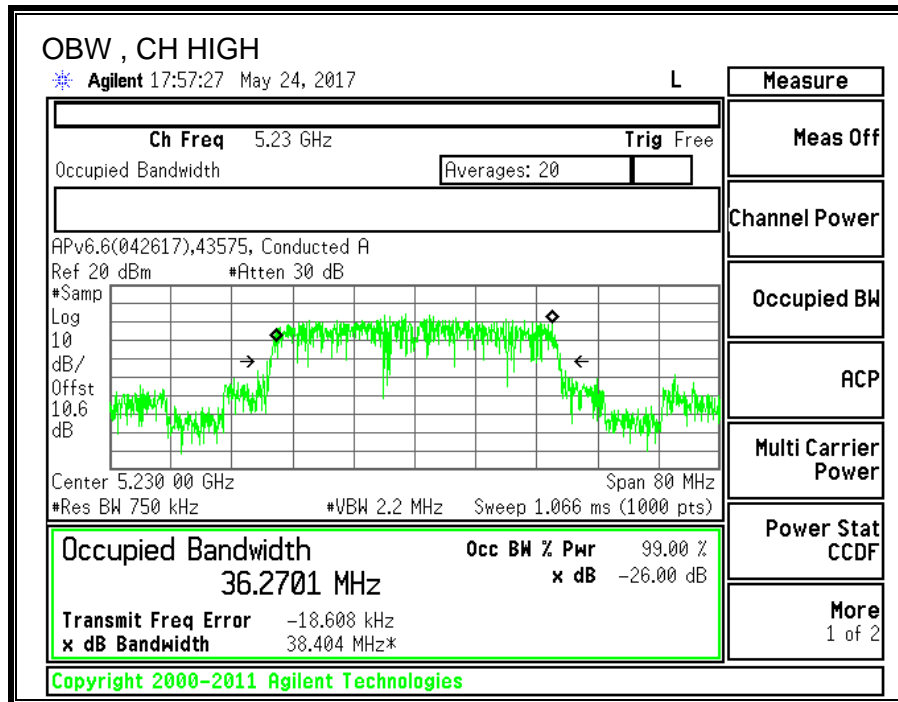
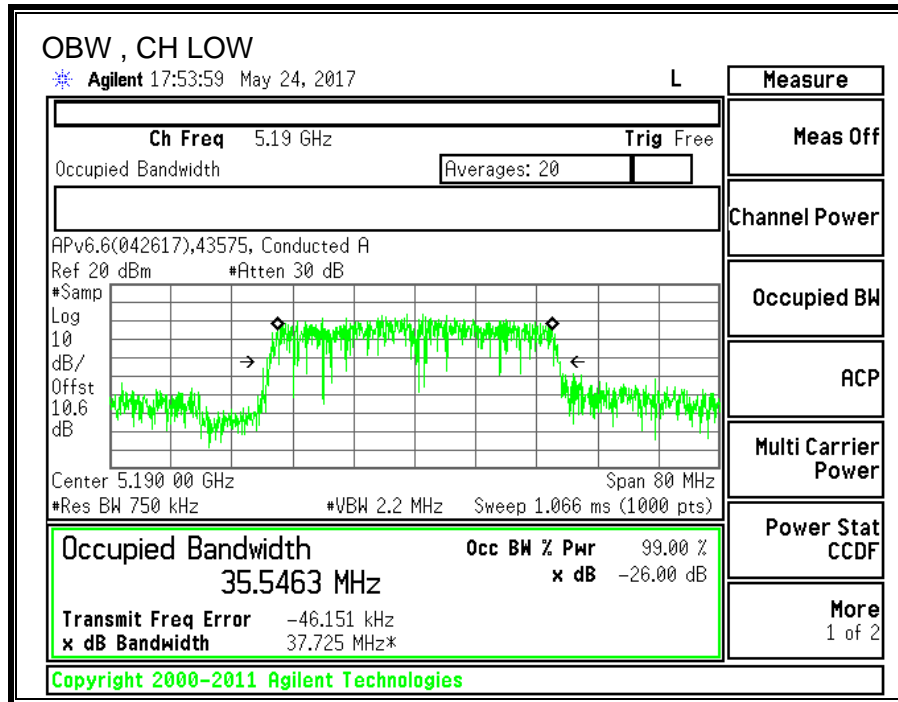

8.4.3. OUTPUT POWER AND PPSD

LIMITS

FCC §15.407 (a) (1)

(i) For an outdoor access point operating in the band 5.15-5.25 GHz, the maximum conducted output power over the frequency band of operation shall not exceed 1 W provided the maximum antenna gain does not exceed 6 dBi. In addition, the maximum power spectral density shall not exceed 17 dBm in any 1 megahertz band. If transmitting antennas of directional gain greater than 6 dBi are used, both the maximum conducted output power and the maximum power spectral density shall be reduced by the amount in dB that the directional gain of the antenna exceeds 6 dBi. The maximum e.i.r.p. at any elevation angle above 30 degrees as measured from the horizon must not exceed 125 mW (21 dBm).

(ii) For an indoor access point operating in the band 5.15-5.25 GHz, the maximum conducted output power over the frequency band of operation shall not exceed 1 W provided the maximum antenna gain does not exceed 6 dBi. In addition, the maximum power spectral density shall not exceed 17 dBm in any 1 megahertz band. If transmitting antennas of directional gain greater than 6 dBi are used, both the maximum conducted output power and the maximum power spectral density shall be reduced by the amount in dB that the directional gain of the antenna exceeds 6 dBi.

(iii) For fixed point-to-point access points operating in the band 5.15-5.25 GHz, the maximum conducted output power over the frequency band of operation shall not exceed 1 W. Fixed point-to-point U-NII devices may employ antennas with directional gain up to 23 dBi without any corresponding reduction in the maximum conducted output power or maximum power spectral density. For fixed point-to-point transmitters that employ a directional antenna gain greater than 23 dBi, a 1 dB reduction in maximum conducted output power and maximum power spectral density is required for each 1 dB of antenna gain in excess of 23 dBi. Fixed, point-to-point operations exclude the use of point-to-multipoint systems, omnidirectional applications, and multiple collocated transmitters transmitting the same information. The operator of the U-NII device, or if the equipment is professionally installed, the installer, is responsible for ensuring that systems employing high gain directional antennas are used exclusively for fixed, point-to-point operations.

(iv) For mobile and portable client devices in the 5.15-5.25 GHz band, the maximum conducted output power over the frequency band of operation shall not exceed 250 mW provided the maximum antenna gain does not exceed 6 dBi. In addition, the maximum power spectral density shall not exceed 11 dBm in any 1 megahertz band. If transmitting antennas of directional gain greater than 6 dBi are used, both the maximum conducted output power and the maximum power spectral density shall be reduced by the amount in dB that the directional gain of the antenna exceeds 6 dBi.

IC RSS-247 (6.2.1) (1)

The maximum EIRP shall not exceed 200 mW or $10 + 10 \log_{10} B$, dBm, whichever power is less. B is the 99% emission bandwidth in MHz. The e.i.r.p. spectral density shall not exceed 10 dBm in any 1.0 MHz band.

TEST PROCEDURE

Measurements perform using a wideband gated RF power meter provided that the gate parameters are adjusted such that the power is measured only when the EUT is transmitting at its maximum power control level. Since the measurement is made only during the ON time of the transmitter, no duty cycle correction factor is required.

DIRECTIONAL ANTENNA GAIN

There is only one transmitter output therefore the directional gain is equal to the antenna gain.

RESULTS

ID:	43574	Date:	5/24/2017
------------	-------	--------------	-----------

Bandwidth and Antenna Gain

Channel	Frequency (MHz)	Min 26 dB BW (MHz)	Min 99% BW (MHz)	Directional Gain for Power (dBi)	Directional Gain for PPSD (dBi)
Low	5190	40.80	35.546	3.30	3.30
High	5230	40.70	36.270	3.30	3.30

Limits

Channel	Frequency (MHz)	FCC Power Limit (dBm)	IC EIRP Limit (dBm)	Max IC Power (dBm)	Power Limit (dBm)	FCC PPSD Limit (dBm)	IC eirp PSD Limit (dBm)	PPSD Limit (dBm)
Low	5190	24.00	23.00	19.70	19.70	11.00	10.00	6.70
High	5230	24.00	23.00	19.70	19.70	11.00	10.00	6.70

Duty Cycle CF (dB)	0.42	Included in Calculations of Corr'd PPSD
---------------------------	------	--

Output Power Results

Channel	Frequency (MHz)	Meas Power (dBm)	Total Corr'd Power (dBm)	Power Limit (dBm)	Power Margin (dB)
Low	5190	12.28	12.28	19.70	-7.42
High	5230	12.70	12.70	19.70	-7.00

PPSD Results

Channel	Frequency (MHz)	Meas PPSD (dBm)	Total Corr'd PPSD (dBm)	PPSD Limit (dBm)	PPSD Margin (dB)
Low	5190	-0.818	-0.40	6.70	-7.10
High	5230	-0.849	-0.43	6.70	-7.13

Note: the power readings above were measured with gated method, and the measurement was taken only during the ON time. No duty cycle correction was necessary.

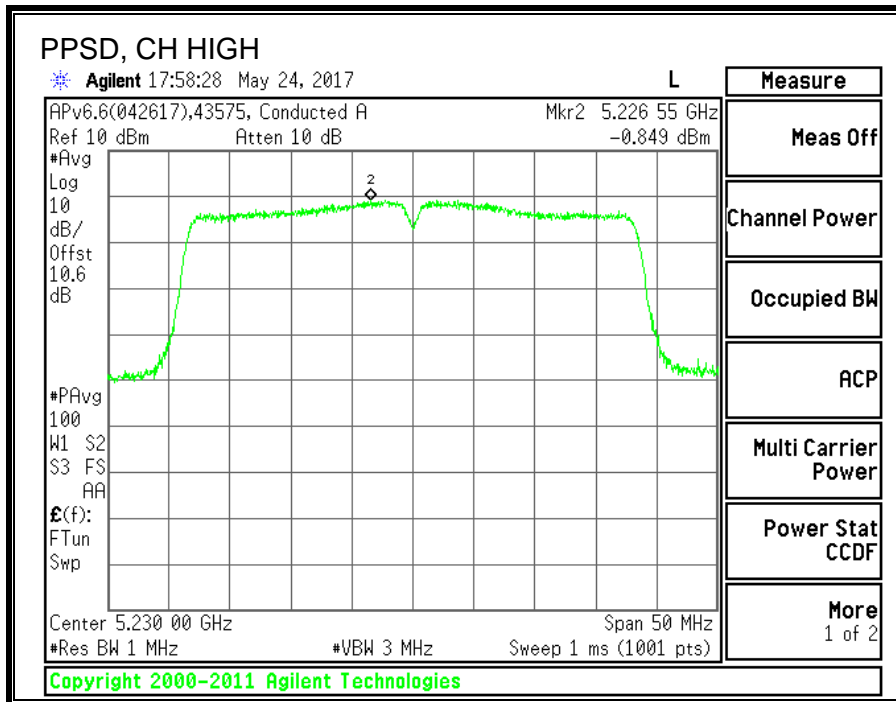
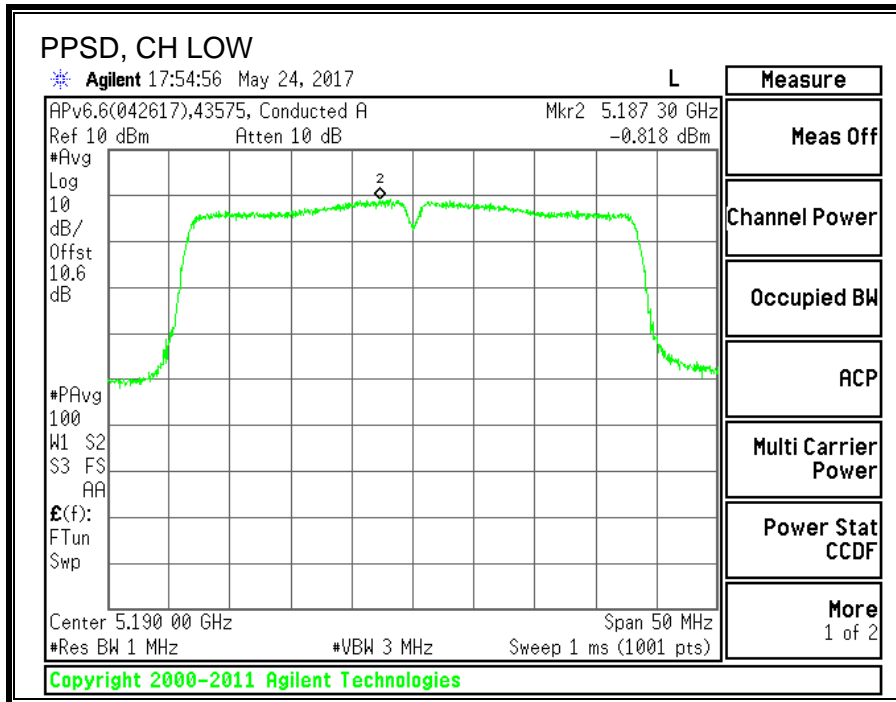

8.5. 11ac VHT80 MODE IN THE 5.2GHz BAND

8.5.1. 26 dB BANDWIDTH

LIMITS

None; for reporting purposes only.

RESULTS

Channel	Frequency	26 dB BW (MHz)
Mid	5210	82.4

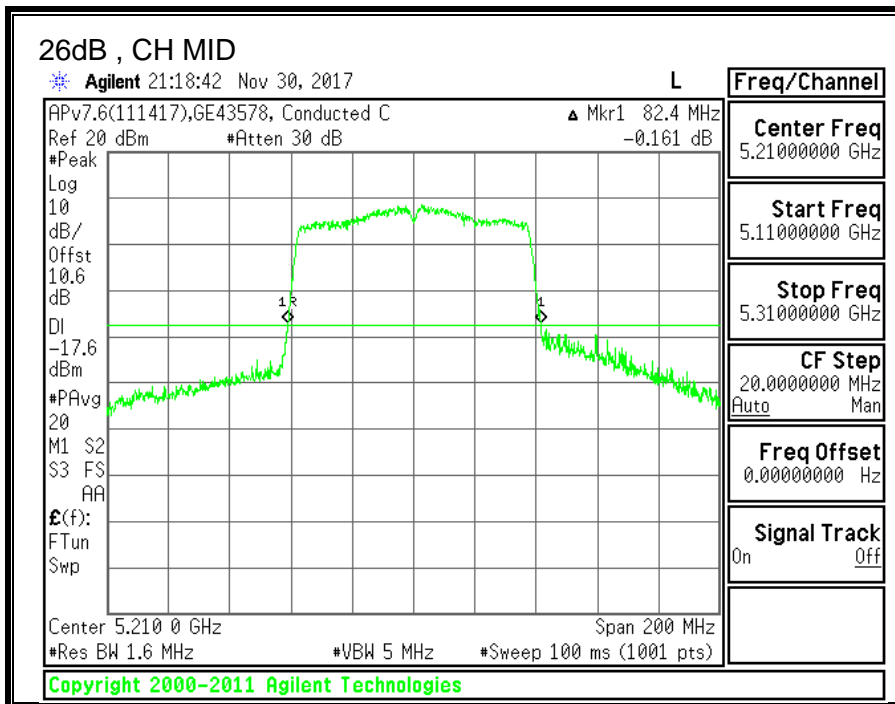

8.5.2. 99% BANDWIDTH

LIMITS

None; for reporting purposes only.

RESULTS

Channel	Frequency	99% BW (MHz)
Mid	5210	75.4805

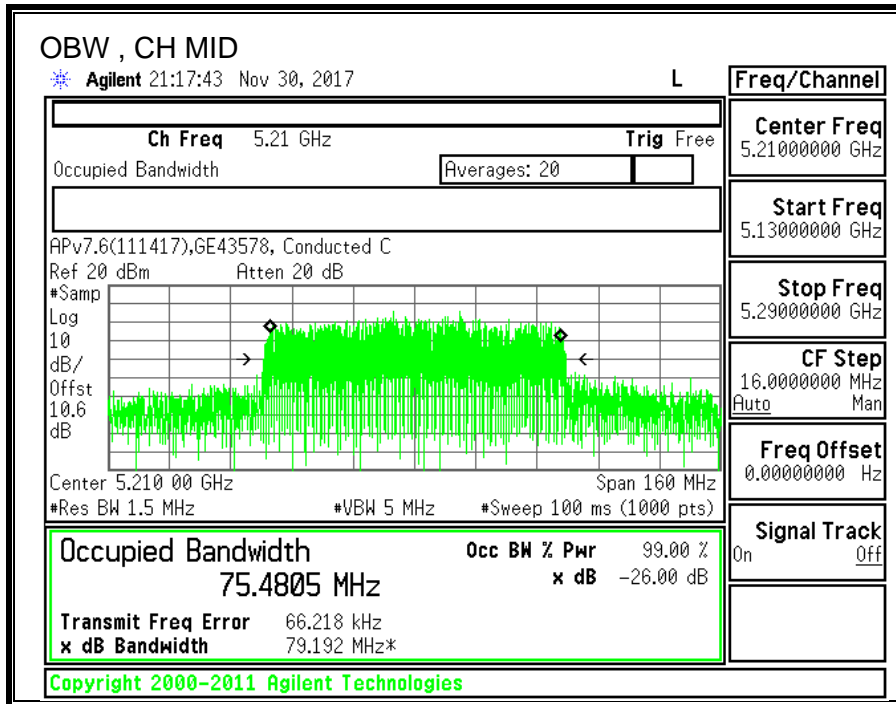

8.5.3. OUTPUT POWER AND PPSD

LIMITS

FCC §15.407 (a) (1)

(i) For an outdoor access point operating in the band 5.15-5.25 GHz, the maximum conducted output power over the frequency band of operation shall not exceed 1 W provided the maximum antenna gain does not exceed 6 dBi. In addition, the maximum power spectral density shall not exceed 17 dBm in any 1 megahertz band. If transmitting antennas of directional gain greater than 6 dBi are used, both the maximum conducted output power and the maximum power spectral density shall be reduced by the amount in dB that the directional gain of the antenna exceeds 6 dBi. The maximum e.i.r.p. at any elevation angle above 30 degrees as measured from the horizon must not exceed 125 mW (21 dBm).

(ii) For an indoor access point operating in the band 5.15-5.25 GHz, the maximum conducted output power over the frequency band of operation shall not exceed 1 W provided the maximum antenna gain does not exceed 6 dBi. In addition, the maximum power spectral density shall not exceed 17 dBm in any 1 megahertz band. If transmitting antennas of directional gain greater than 6 dBi are used, both the maximum conducted output power and the maximum power spectral density shall be reduced by the amount in dB that the directional gain of the antenna exceeds 6 dBi.

(iii) For fixed point-to-point access points operating in the band 5.15-5.25 GHz, the maximum conducted output power over the frequency band of operation shall not exceed 1 W. Fixed point-to-point U-NII devices may employ antennas with directional gain up to 23 dBi without any corresponding reduction in the maximum conducted output power or maximum power spectral density. For fixed point-to-point transmitters that employ a directional antenna gain greater than 23 dBi, a 1 dB reduction in maximum conducted output power and maximum power spectral density is required for each 1 dB of antenna gain in excess of 23 dBi. Fixed, point-to-point operations exclude the use of point-to-multipoint systems, omnidirectional applications, and multiple collocated transmitters transmitting the same information. The operator of the U-NII device, or if the equipment is professionally installed, the installer, is responsible for ensuring that systems employing high gain directional antennas are used exclusively for fixed, point-to-point operations.

(iv) For mobile and portable client devices in the 5.15-5.25 GHz band, the maximum conducted output power over the frequency band of operation shall not exceed 250 mW provided the maximum antenna gain does not exceed 6 dBi. In addition, the maximum power spectral density shall not exceed 11 dBm in any 1 megahertz band. If transmitting antennas of directional gain greater than 6 dBi are used, both the maximum conducted output power and the maximum power spectral density shall be reduced by the amount in dB that the directional gain of the antenna exceeds 6 dBi.

IC RSS-247 (6.2.1) (1)

The maximum EIRP shall not exceed 200 mW or $10 + 10 \log_{10} B$, dBm, whichever power is less. B is the 99% emission bandwidth in MHz. The e.i.r.p. spectral density shall not exceed 10 dBm in any 1.0 MHz band.

TEST PROCEDURE

Measurements perform using a wideband gated RF power meter provided that the gate parameters are adjusted such that the power is measured only when the EUT is transmitting at its maximum power control level. Since the measurement is made only during the ON time of the transmitter, no duty cycle correction factor is required.

DIRECTIONAL ANTENNA GAIN

There is only one transmitter output therefore the directional gain is equal to the antenna gain.

RESULTS

ID:	GE43578	Date:	11/30/2017
------------	---------	--------------	------------

Bandwidth and Antenna Gain

Channel	Frequency (MHz)	Min 26 dB BW (MHz)	Min 99% BW (MHz)	Directional Gain for Power (dBi)	Directional Gain for PPSD (dBi)
Mid	5210	82.40	75.4805	3.30	3.30

Limits

Channel	Frequency (MHz)	FCC Power Limit (dBm)	IC EIRP Limit (dBm)	Max IC Power (dBm)	Power Limit (dBm)	FCC PPSD Limit (dBm)	IC eirp PSD Limit (dBm)	PPSD Limit (dBm)
Mid	5210	24.00	23.00	19.70	19.70	11.00	10.00	6.70

Duty Cycle CF (dB)	1.18	Included in Calculations of Corr'd PPSD
---------------------------	------	--

Output Power Results

Channel	Frequency (MHz)	Meas Power (dBm)	Total Corr'd Power (dBm)	Power Limit (dBm)	Power Margin (dB)
Mid	5210	11.85	11.85	19.70	-7.85

PPSD Results

Channel	Frequency (MHz)	Meas PPSD (dBm)	Total Corr'd PPSD (dBm)	PPSD Limit (dBm)	PPSD Margin (dB)
Mid	5210	-4.060	-2.88	6.70	-9.58

Note: the power readings above were measured with gated method, and the measurement was taken only during the ON time. No duty cycle correction was necessary.

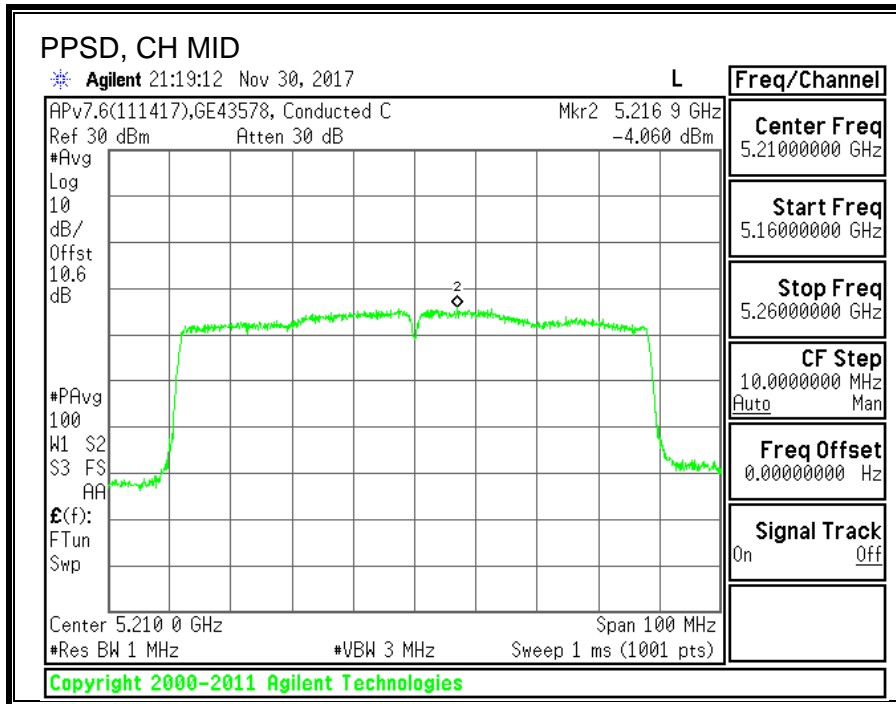

8.6. 11a MODE IN THE 5.3GHz BAND

8.6.1. 26 dB BANDWIDTH

LIMITS

None; for reporting purposes only.

RESULTS

Channel	Frequency	26 dB BW (MHz)
Low	5260	21.80
Mid	5300	21.90
High	5320	21.85

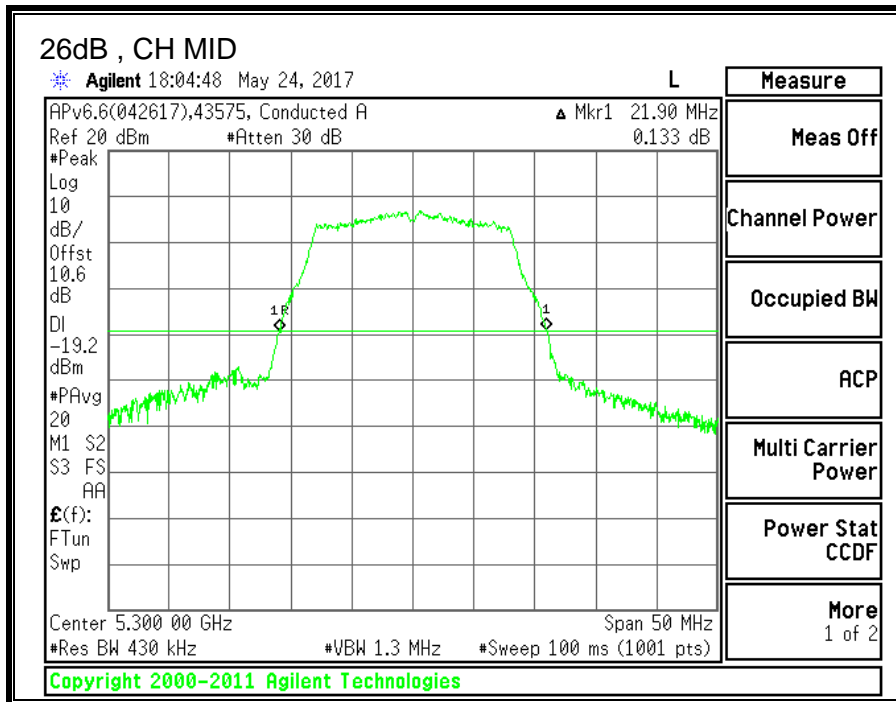
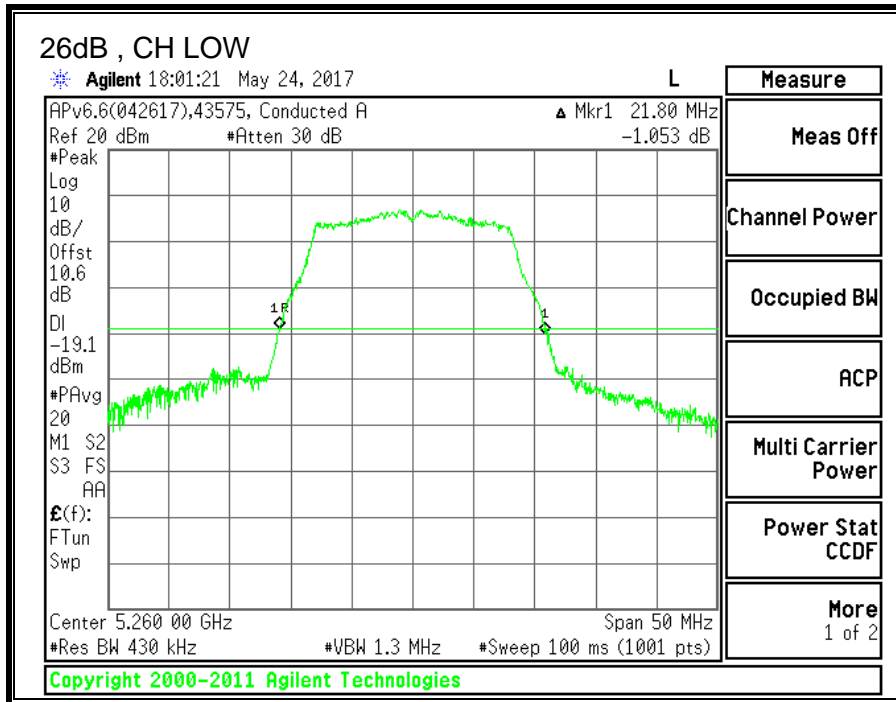

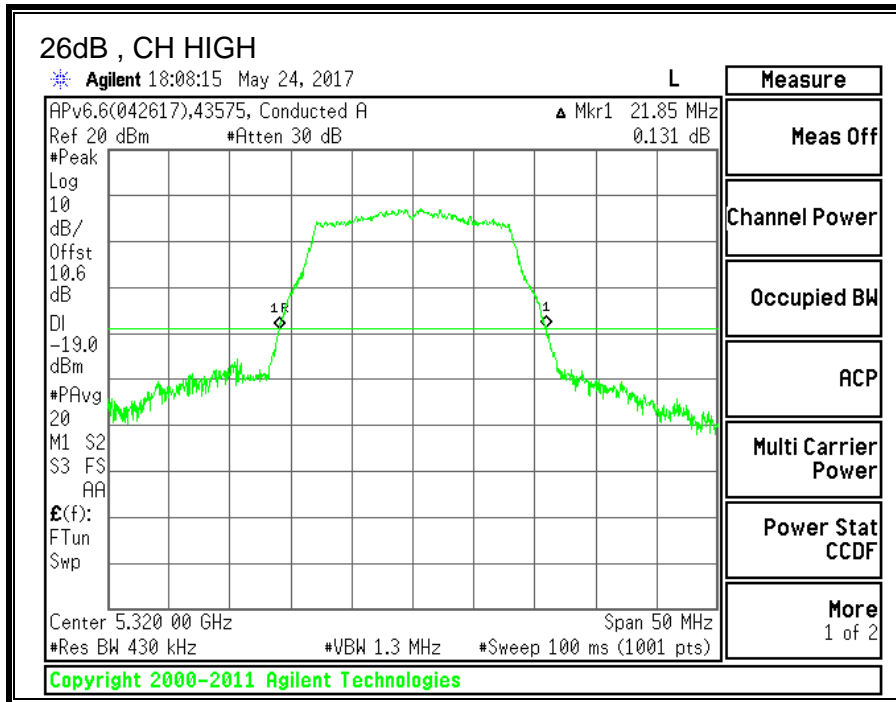

8.6.2. 99% BANDWIDTH

LIMITS

None; for reporting purposes only.

RESULTS

Channel	Frequency	99% BW (MHz)
Low	5260	16.0190
Mid	5300	16.4464
High	5320	16.2754

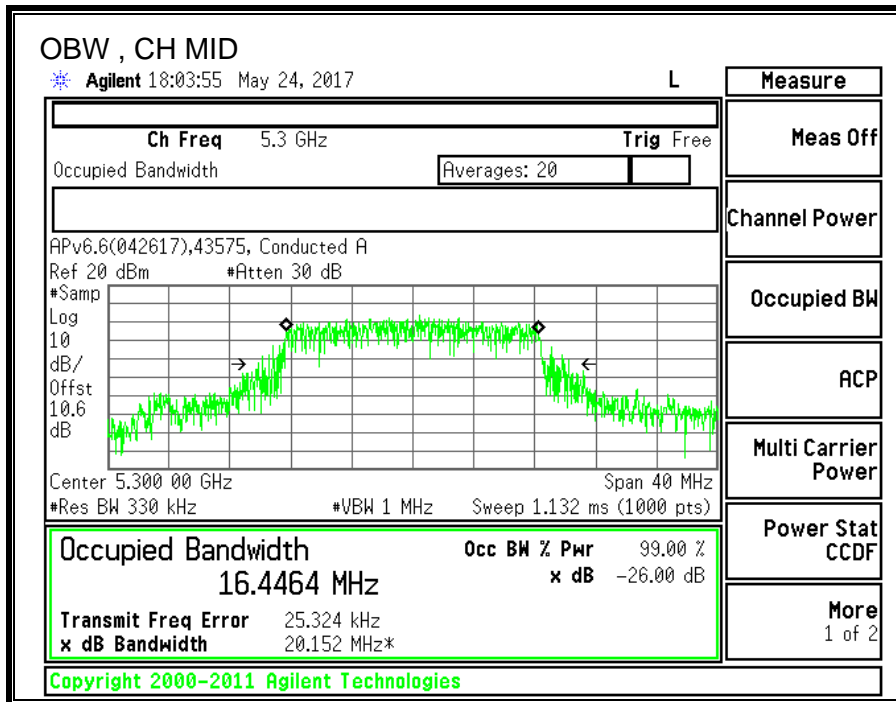
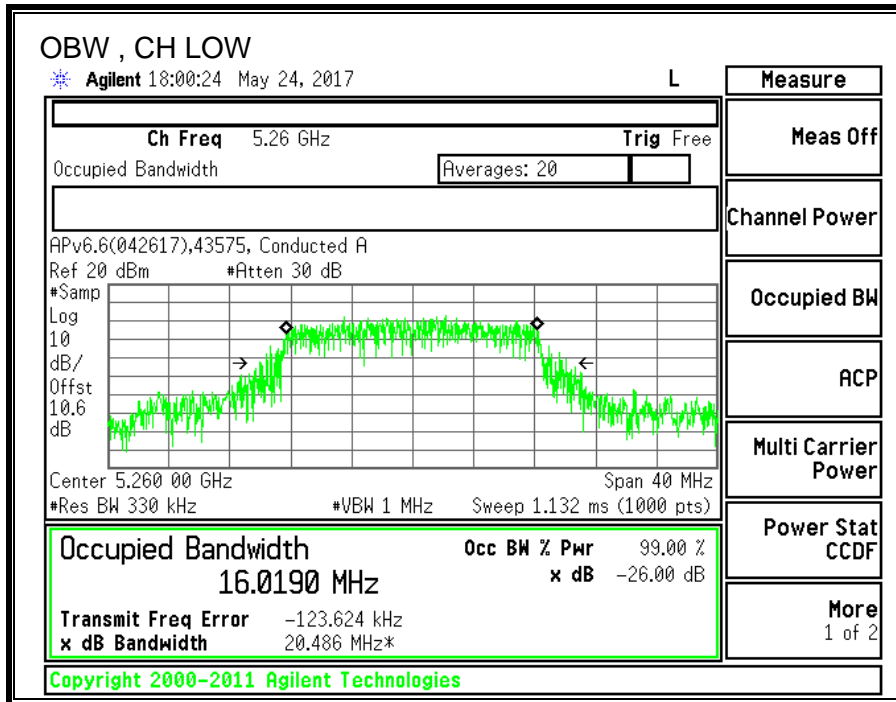

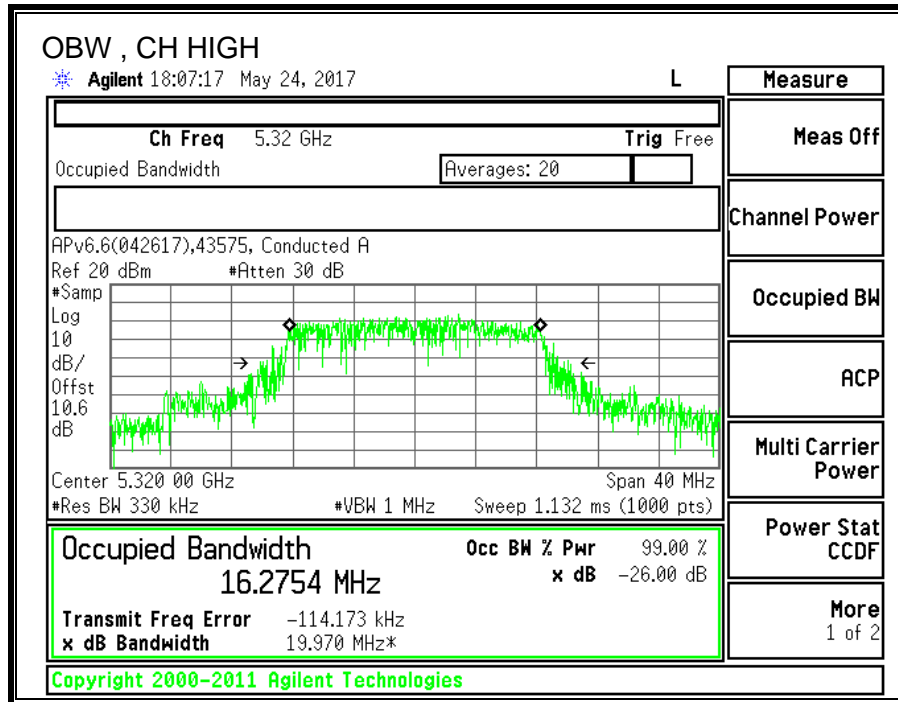

8.6.3. OUTPUT POWER AND PPSD

LIMITS

FCC §15.407 (a) (2)

For the band 5.25–5.35 GHz, the maximum conducted output power over the frequency band of operation shall not exceed the lesser of 250 mW or $11 \text{ dBm} + 10 \log B$, where B is the 26-dB emission bandwidth in MHz. In addition, the maximum power spectral density shall not exceed 11 dBm in any 1-MHz band. If transmitting antennas of directional gain greater than 6 dBi are used, both the maximum conducted output power and the peak power spectral density shall be reduced by the amount in dB that the directional gain of the antenna exceeds 6 dBi.

IC RSS-247 (6.2.2.1)

The maximum conducted output power shall not exceed 250 mW or $11 + 10 \log_{10} B$, dBm, whichever is less. The power spectral density shall not exceed 11 dBm in any 1.0 MHz band.

The maximum e.i.r.p. shall not exceed 1.0 W or $17 + 10 \log_{10} B$, dBm, whichever is less. B is the 99% emission bandwidth in megahertz. Note that devices with a maximum e.i.r.p. greater than 500 mW shall implement TPC in order to have the capability to operate at least 6 dB below the maximum permitted e.i.r.p. of 1 W.

TEST PROCEDURE

Measurements perform using a wideband gated RF power meter provided that the gate parameters are adjusted such that the power is measured only when the EUT is transmitting at its maximum power control level. Since the measurement is made only during the ON time of the transmitter, no duty cycle correction factor is required.

DIRECTIONAL ANTENNA GAIN

There is only one transmitter output therefore the directional gain is equal to the antenna gain.

RESULTS

ID:	43574	Date:	5/24/2017
------------	-------	--------------	-----------

Bandwidth and Antenna Gain

Channel	Frequency (MHz)	Min 26 dB BW (MHz)	Min 99% BW (MHz)	Directional Gain for Power (dBi)	Directional Gain for PPSD (dBi)
Low	5260	21.80	16.019	3.30	3.30
Mid	5300	21.90	16.446	3.30	3.30
High	5320	21.85	16.275	3.30	3.30

Limits

Channel	Frequency (MHz)	FCC Power Limit (dBm)	IC Power Limit (dBm)	IC EIRP Limit (dBm)	Power Limit (dBm)	FCC PPSD Limit (dBm)	IC PSD Limit (dBm)	PPSD Limit (dBm)
Low	5260	24.00	23.05	29.05	23.05	11.00	11.00	11.00
Mid	5300	24.00	23.16	29.16	23.16	11.00	11.00	11.00
High	5320	24.00	23.12	29.12	23.12	11.00	11.00	11.00

Duty Cycle CF (dB)	0.29	Included in Calculations of Corr'd PPSD
---------------------------	------	--

Output Power Results

Channel	Frequency (MHz)	Meas Power (dBm)	Total Corr'd Power (dBm)	Power Limit (dBm)	Power Margin (dB)
Low	5260	12.80	12.80	23.05	-10.25
Mid	5300	13.07	13.07	23.16	-10.09
High	5320	13.30	13.30	23.12	-9.82

PPSD Results

Channel	Frequency (MHz)	Meas PPSD (dBm)	Total Corr'd PPSD (dBm)	PPSD Limit (dBm)	PPSD Margin (dB)
Low	5260	3.457	3.75	11.00	-7.25
Mid	5300	3.043	3.33	11.00	-7.67
High	5320	3.413	3.70	11.00	-7.30

Note: the power readings above were measured with gated method, and the measurement was taken only during the ON time. No duty cycle correction was necessary.

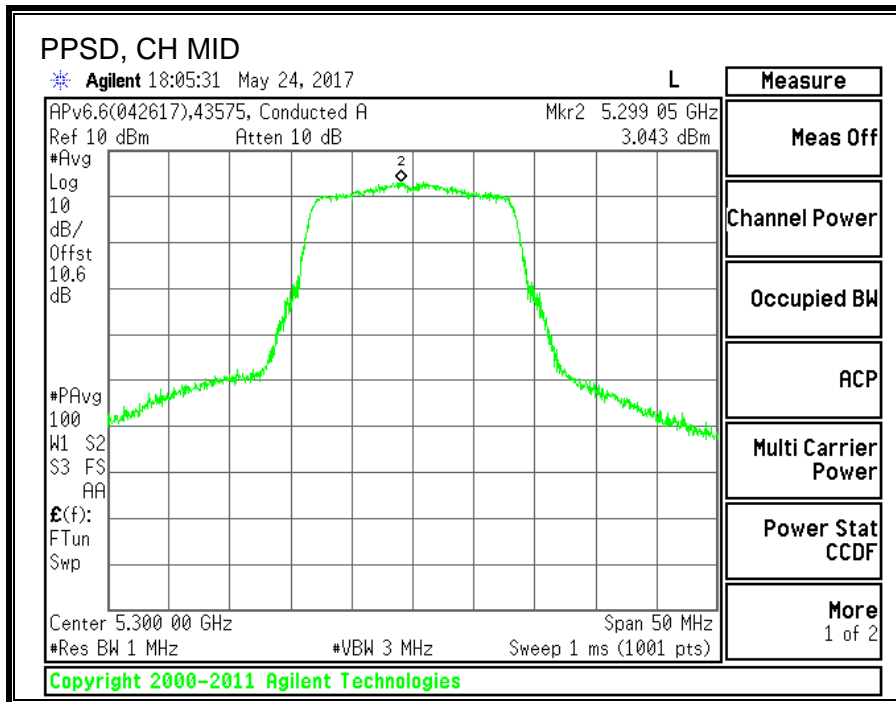
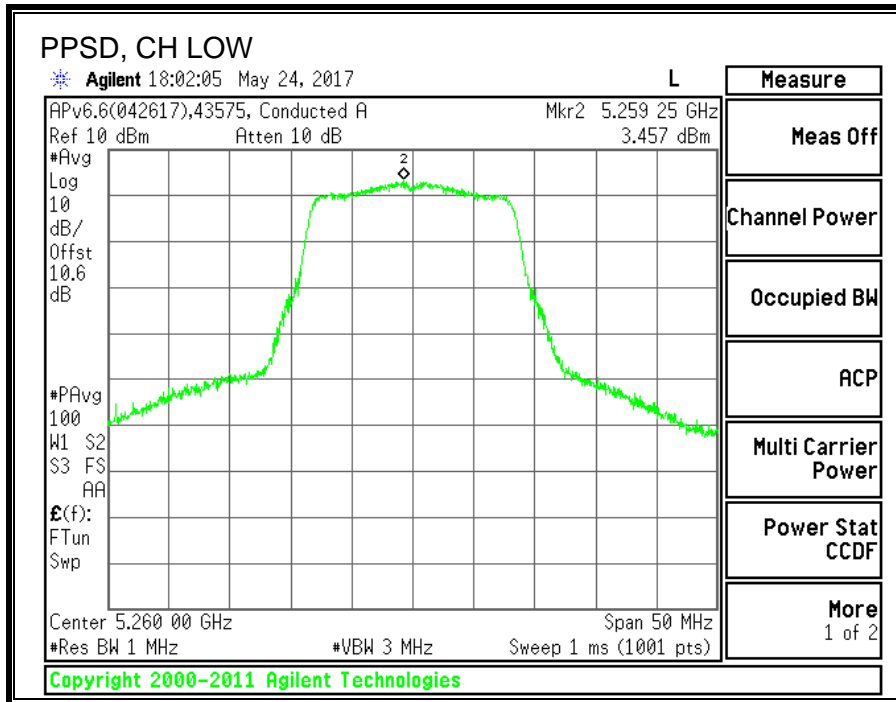

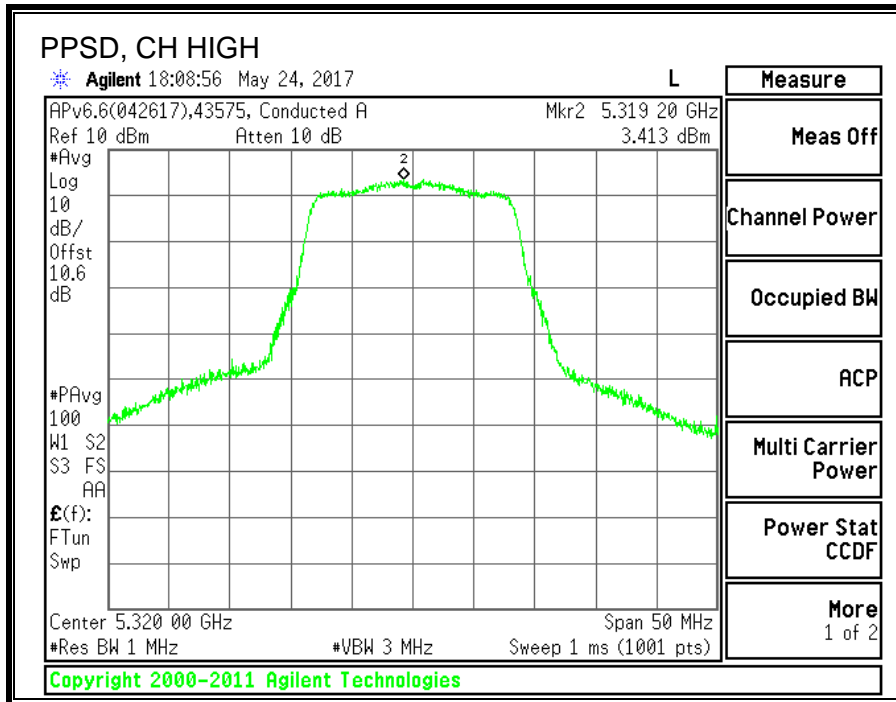

8.7. 11n HT20 MODE IN THE 5.3GHz BAND

8.7.1. 26 dB BANDWIDTH

LIMITS

None; for reporting purposes only.

RESULTS

Channel	Frequency	26 dB BW (MHz)
Low	5260	22.00
Mid	5300	21.95
High	5320	21.95

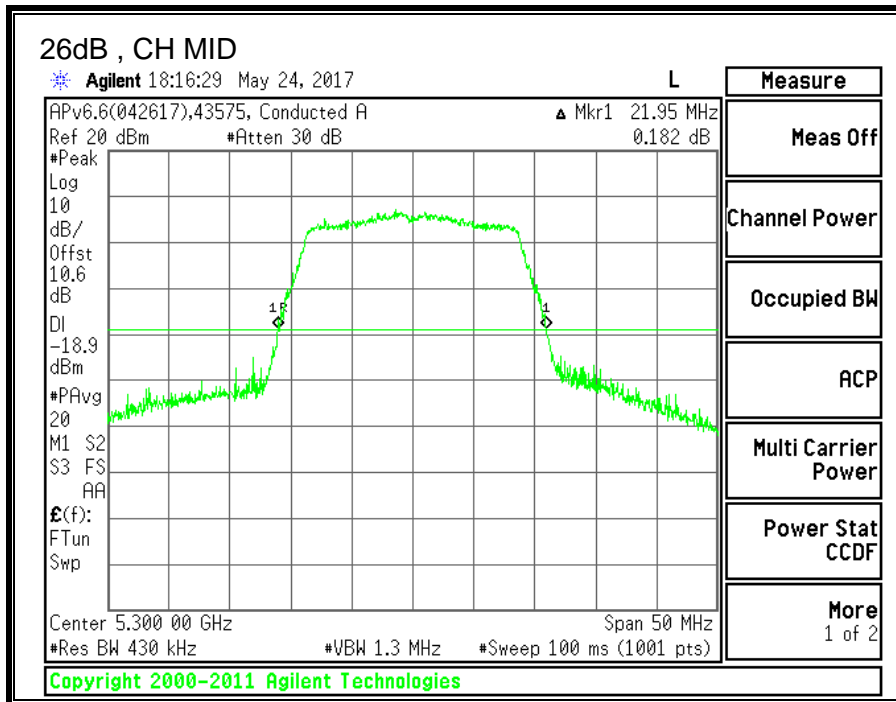
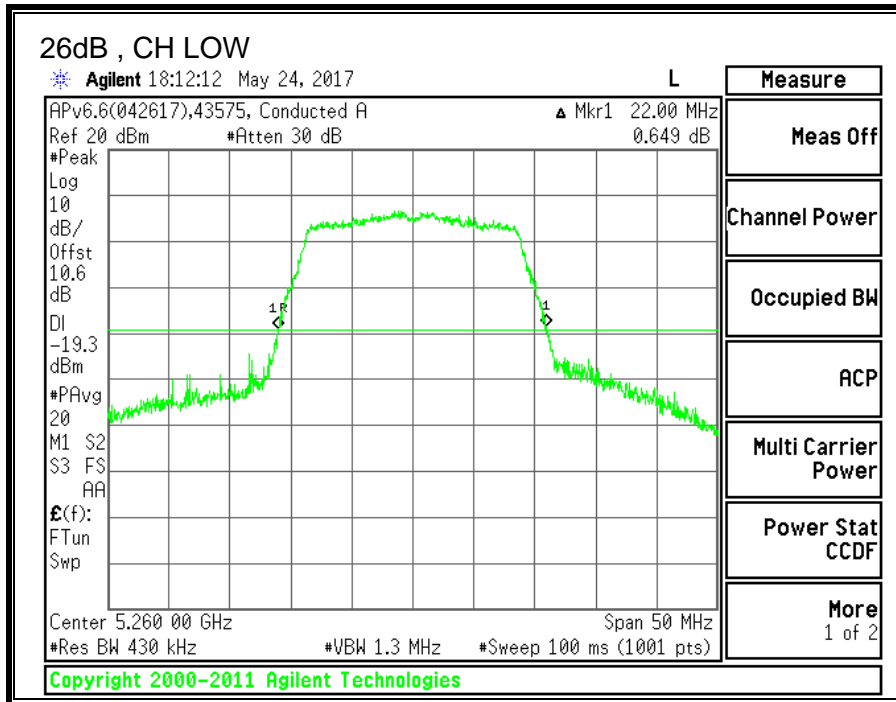

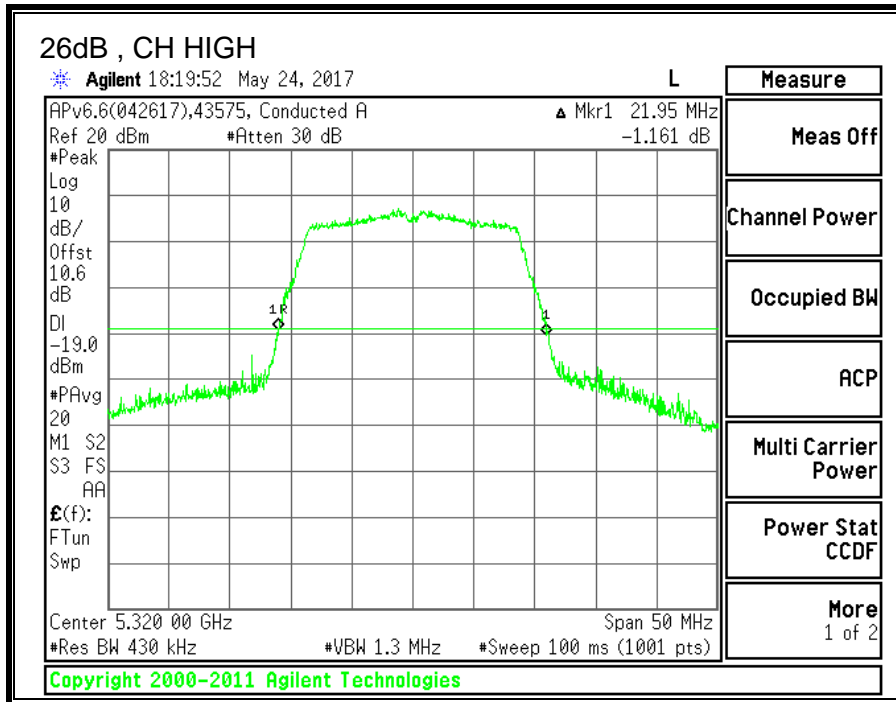

8.7.2. 99% BANDWIDTH

LIMITS

None; for reporting purposes only.

RESULTS

Channel	Frequency	99% BW (MHz)
Low	5260	17.4700
Mid	5300	17.2054
High	5320	17.1024

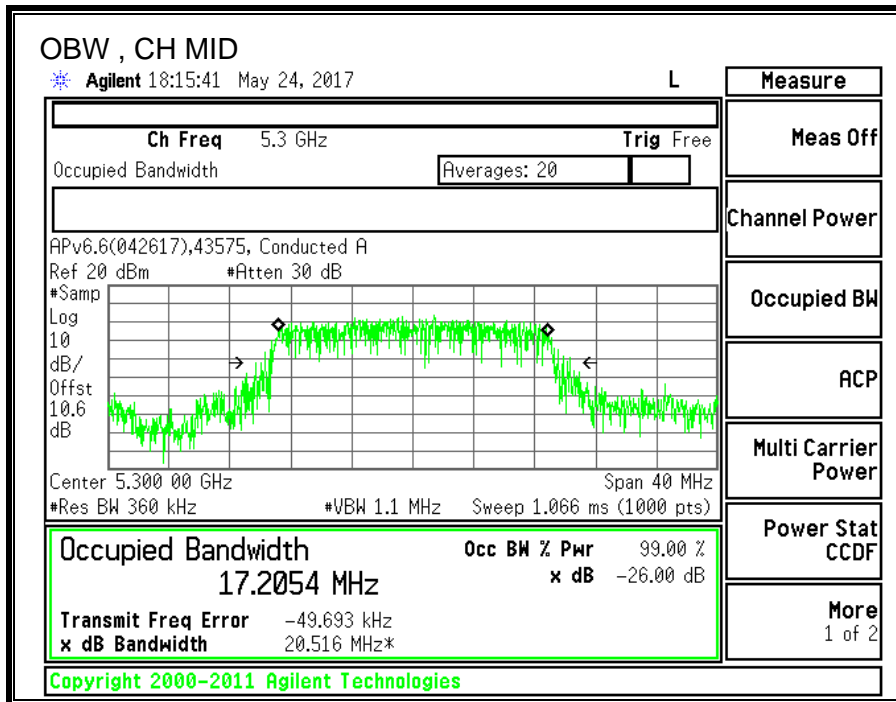
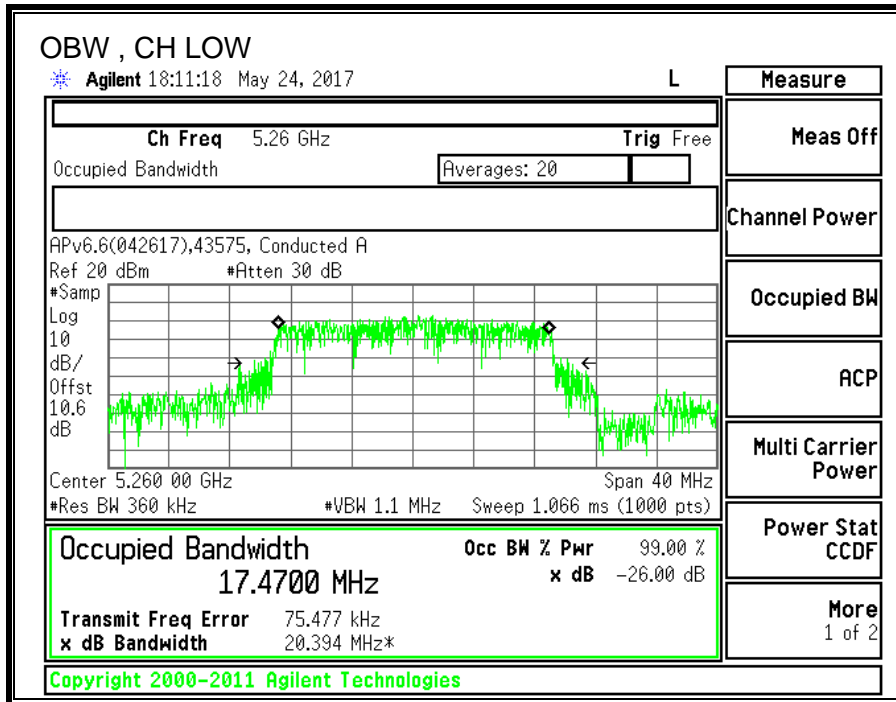

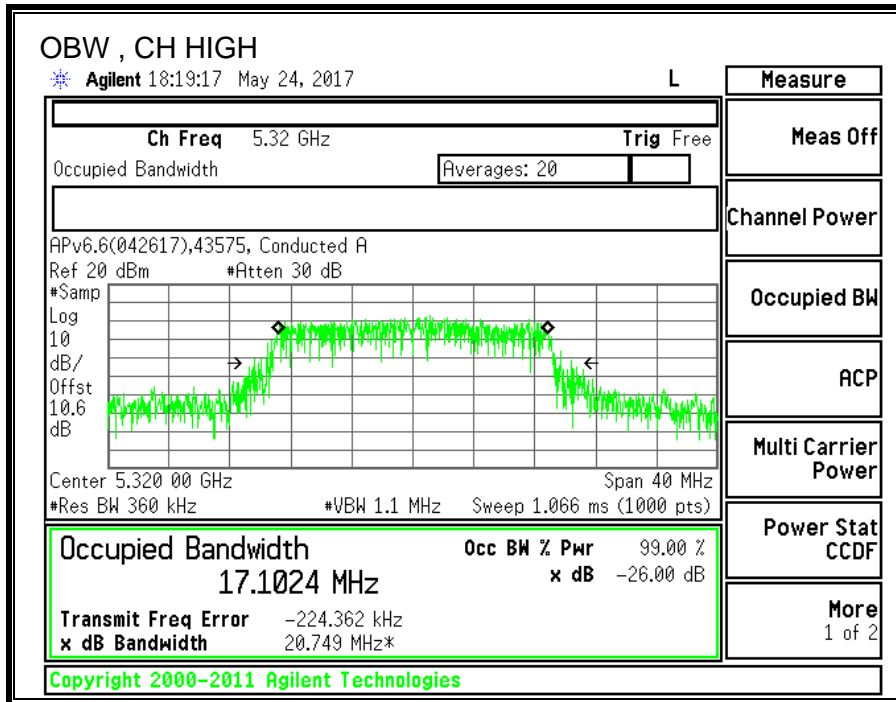

8.7.3. OUTPUT POWER AND PPSD

LIMITS

FCC §15.407 (a) (2)

For the band 5.25–5.35 GHz, the maximum conducted output power over the frequency band of operation shall not exceed the lesser of 250 mW or $11 \text{ dBm} + 10 \log B$, where B is the 26-dB emission bandwidth in MHz. In addition, the maximum power spectral density shall not exceed 11 dBm in any 1-MHz band. If transmitting antennas of directional gain greater than 6 dBi are used, both the maximum conducted output power and the peak power spectral density shall be reduced by the amount in dB that the directional gain of the antenna exceeds 6 dBi.

IC RSS-247 (6.2.2) (1)

The maximum conducted output power shall not exceed 250 mW or $11 + 10 \log_{10} B$, dBm, whichever is less. The power spectral density shall not exceed 11 dBm in any 1.0 MHz band.

The maximum e.i.r.p. shall not exceed 1.0 W or $17 + 10 \log_{10} B$, dBm, whichever is less. B is the 99% emission bandwidth in megahertz. Note that devices with a maximum e.i.r.p. greater than 500 mW shall implement TPC in order to have the capability to operate at least 6 dB below the maximum permitted e.i.r.p. of 1 W.

TEST PROCEDURE

Measurements perform using a wideband gated RF power meter provided that the gate parameters are adjusted such that the power is measured only when the EUT is transmitting at its maximum power control level. Since the measurement is made only during the ON time of the transmitter, no duty cycle correction factor is required.

DIRECTIONAL ANTENNA GAIN

There is only one transmitter output therefore the directional gain is equal to the antenna gain.

RESULTS

ID:	43574	Date:	5/24/2017
------------	-------	--------------	-----------

Bandwidth and Antenna Gain

Channel	Frequency (MHz)	Min 26 dB BW (MHz)	Min 99% BW (MHz)	Directional Gain for Power (dBi)	Directional Gain for PPSD (dBi)
Low	5260	22.00	17.470	3.30	3.30
Mid	5300	21.95	17.205	3.30	3.30
High	5320	21.95	17.102	3.30	3.30

Limits

Channel	Frequency (MHz)	FCC Power Limit (dBm)	IC Power Limit (dBm)	IC EIRP Limit (dBm)	Power Limit (dBm)	FCC PPSD Limit (dBm)	IC PSD Limit (dBm)	PPSD Limit (dBm)
Low	5260	24.00	23.42	29.42	23.42	11.00	11.00	11.00
Mid	5300	24.00	23.36	29.36	23.36	11.00	11.00	11.00
High	5320	24.00	23.33	29.33	23.33	11.00	11.00	11.00

Duty Cycle CF (dB)	0.31	Included in Calculations of Corr'd PPSD
---------------------------	------	--

Output Power Results

Channel	Frequency (MHz)	Meas Power (dBm)	Total Corr'd Power (dBm)	Power Limit (dBm)	Power Margin (dB)
Low	5260	12.51	12.51	23.42	-10.91
Mid	5300	13.04	13.04	23.36	-10.32
High	5320	12.83	12.83	23.33	-10.50

PPSD Results

Channel	Frequency (MHz)	Meas PPSD (dBm)	Total Corr'd PPSD (dBm)	PPSD Limit (dBm)	PPSD Margin (dB)
Low	5260	2.632	2.94	11.00	-8.06
Mid	5300	2.471	2.78	11.00	-8.22
High	5320	2.811	3.12	11.00	-7.88

Note: the power readings above were measured with gated method, and the measurement was taken only during the ON time. No duty cycle correction was necessary.

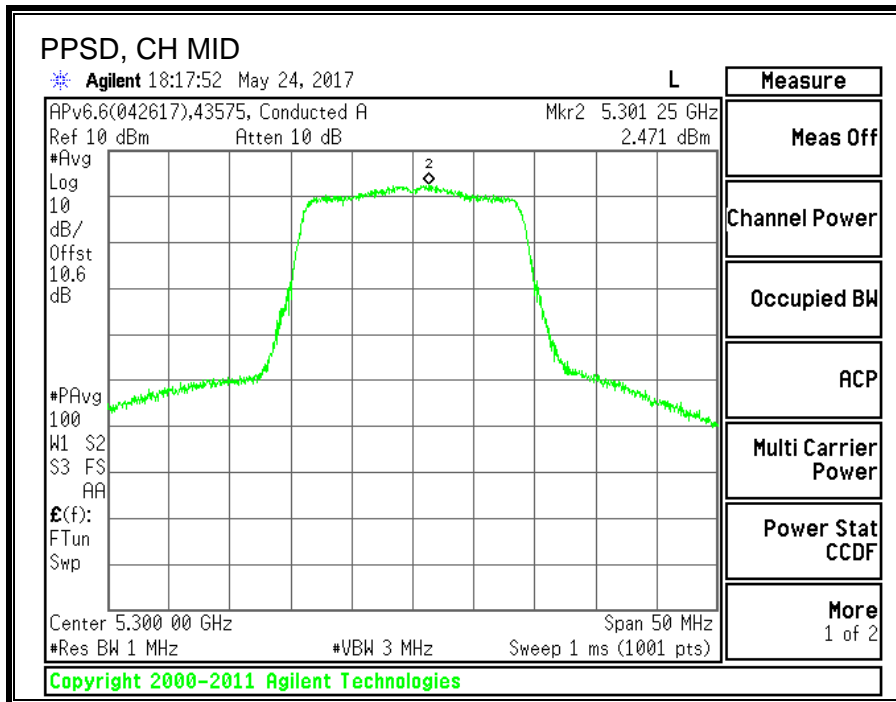
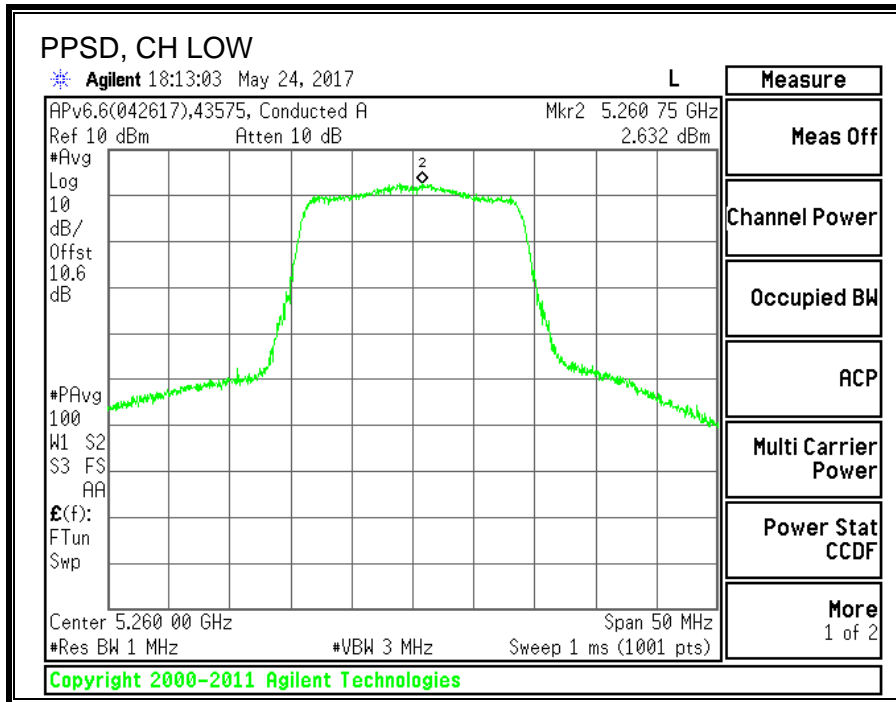

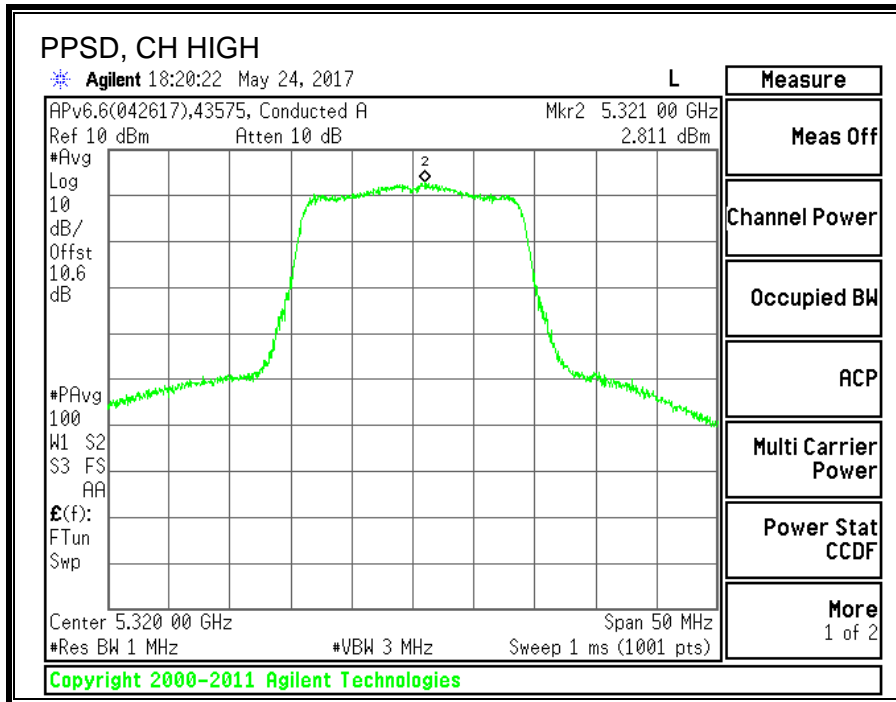

8.8. 11n HT40 MODE IN THE 5.3GHz BAND

8.8.1. 26 dB BANDWIDTH

LIMITS

None; for reporting purposes only.

RESULTS

Channel	Frequency	26 dB BW (MHz)
Low	5270	40.8
High	5310	40.8

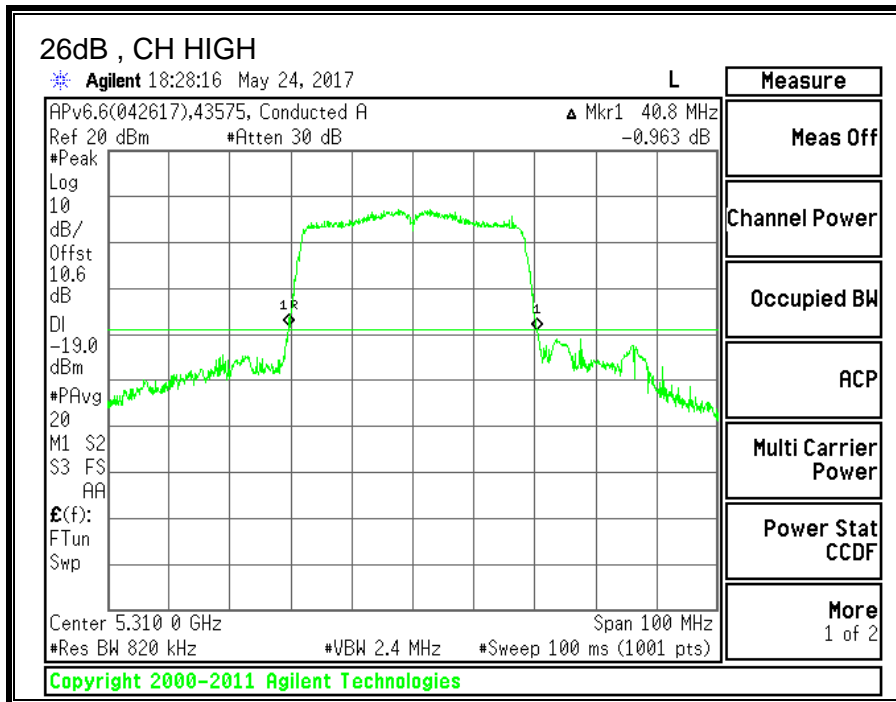
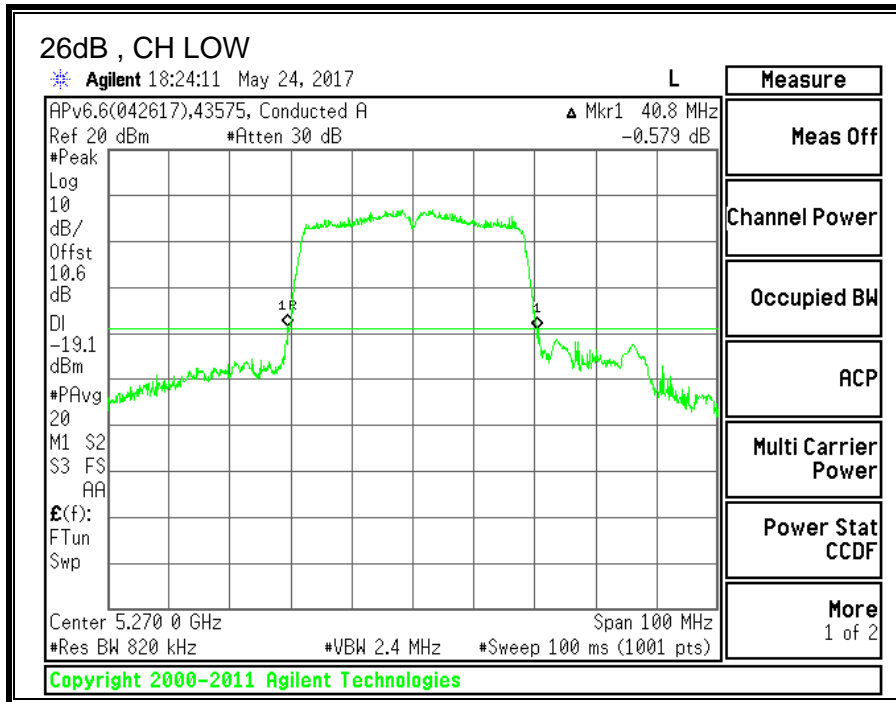

8.8.2. 99% BANDWIDTH

LIMITS

None; for reporting purposes only.

RESULTS

Channel	Frequency	99% BW (MHz)
Low	5270	34.7784
High	5310	36.3052

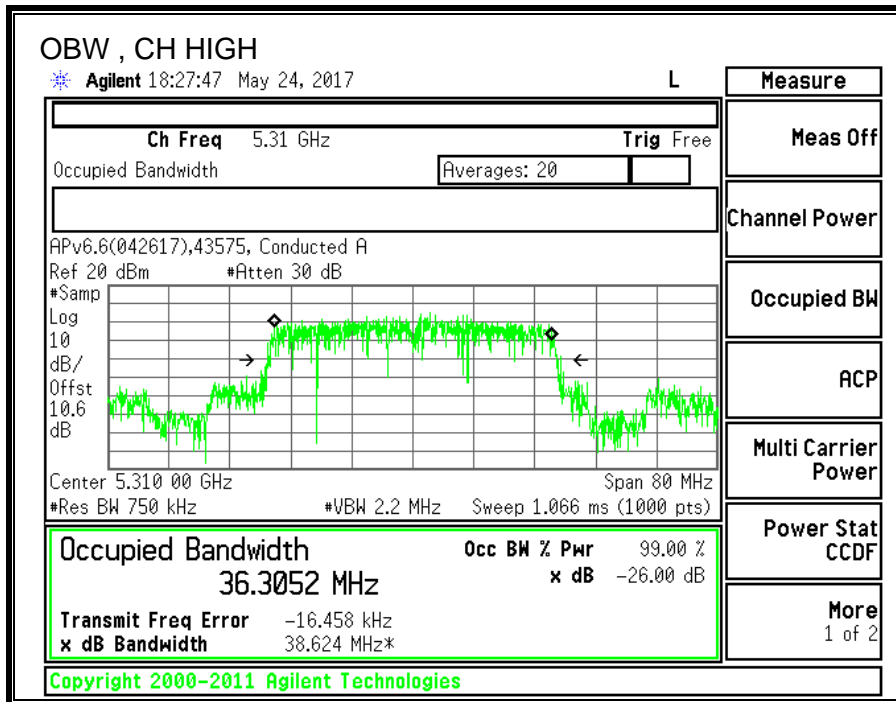
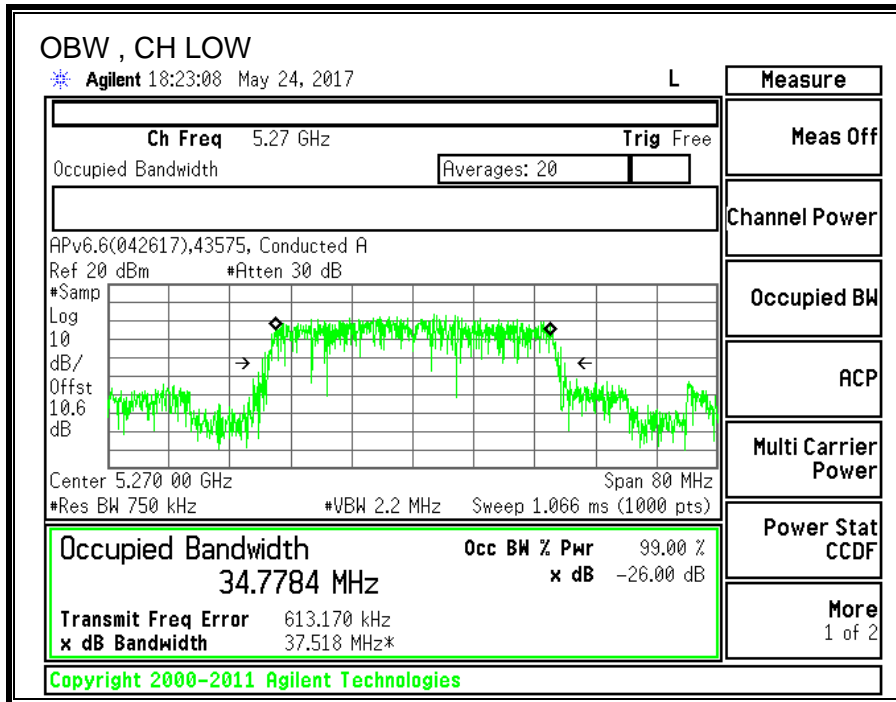

8.8.3. OUTPUT POWER AND PPSD

LIMITS

FCC §15.407 (a) (2)

For the band 5.25–5.35 GHz, the maximum conducted output power over the frequency band of operation shall not exceed the lesser of 250 mW or $11 \text{ dBm} + 10 \log B$, where B is the 26-dB emission bandwidth in MHz. In addition, the maximum power spectral density shall not exceed 11 dBm in any 1-MHz band. If transmitting antennas of directional gain greater than 6 dBi are used, both the maximum conducted output power and the peak power spectral density shall be reduced by the amount in dB that the directional gain of the antenna exceeds 6 dBi.

IC RSS-247 (6.2.2.1)

The maximum conducted output power shall not exceed 250 mW or $11 + 10 \log_{10} B$, dBm, whichever is less. The power spectral density shall not exceed 11 dBm in any 1.0 MHz band.

The maximum e.i.r.p. shall not exceed 1.0 W or $17 + 10 \log_{10} B$, dBm, whichever is less. B is the 99% emission bandwidth in megahertz. Note that devices with a maximum e.i.r.p. greater than 500 mW shall implement TPC in order to have the capability to operate at least 6 dB below the maximum permitted e.i.r.p. of 1 W.

TEST PROCEDURE

Measurements perform using a wideband gated RF power meter provided that the gate parameters are adjusted such that the power is measured only when the EUT is transmitting at its maximum power control level. Since the measurement is made only during the ON time of the transmitter, no duty cycle correction factor is required.

DIRECTIONAL ANTENNA GAIN

There is only one transmitter output therefore the directional gain is equal to the antenna gain.

RESULTS

ID:	43574	Date:	5/24/2017
------------	-------	--------------	-----------

Bandwidth and Antenna Gain

Channel	Frequency (MHz)	Min 26 dB BW (MHz)	Min 99% BW (MHz)	Directional Gain for Power (dBi)	Directional Gain for PPSD (dBi)
Low	5270	40.80	34.778	3.30	3.30
High	5310	40.80	36.305	3.30	3.30

Limits

Channel	Frequency (MHz)	FCC Power Limit (dBm)	IC Power Limit (dBm)	IC EIRP Limit (dBm)	Power Limit (dBm)	FCC PPSD Limit (dBm)	IC PSD Limit (dBm)	PPSD Limit (dBm)
Low	5270	24.00	24.00	30.00	24.00	11.00	11.00	11.00
High	5310	24.00	24.00	30.00	24.00	11.00	11.00	11.00

Duty Cycle CF (dB)	0.42	Included in Calculations of Corr'd PPSD
---------------------------	------	--

Output Power Results

Channel	Frequency (MHz)	Meas Power (dBm)	Total Corr'd Power (dBm)	Power Limit (dBm)	Power Margin (dB)
Low	5270	12.60	12.60	24.00	-11.40
High	5310	12.89	12.89	24.00	-11.11

PPSD Results

Channel	Frequency (MHz)	Meas PPSD (dBm)	Total Corr'd PPSD (dBm)	PPSD Limit (dBm)	PPSD Margin (dB)
Low	5270	-0.668	-0.25	11.00	-11.25
High	5310	-0.638	-0.22	11.00	-11.22

Note: the power readings above were measured with gated method, and the measurement was taken only during the ON time. No duty cycle correction was necessary.

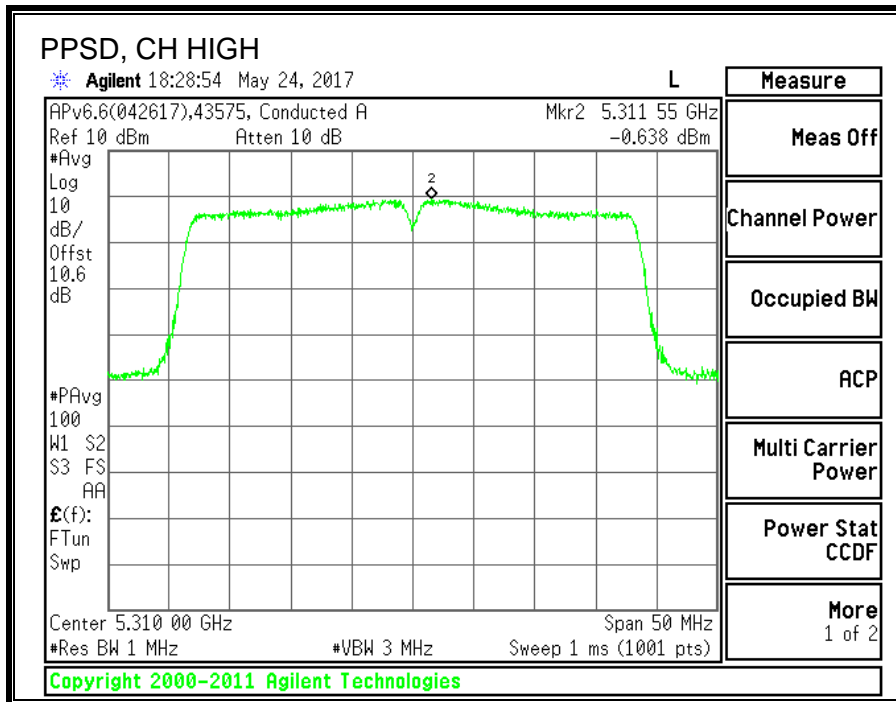
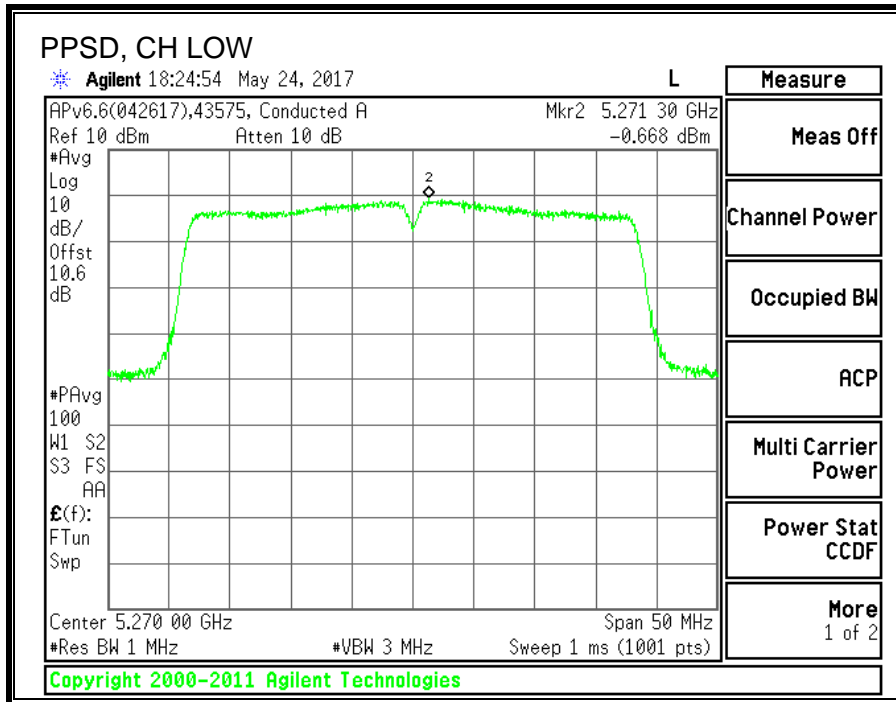

8.9. 11ac VHT80 MODE IN THE 5.3GHz BAND

8.9.1. 26 dB BANDWIDTH

LIMITS

None; for reporting purposes only.

RESULTS

Channel	Frequency	26 dB BW (MHz)
Mid	5290	82.6

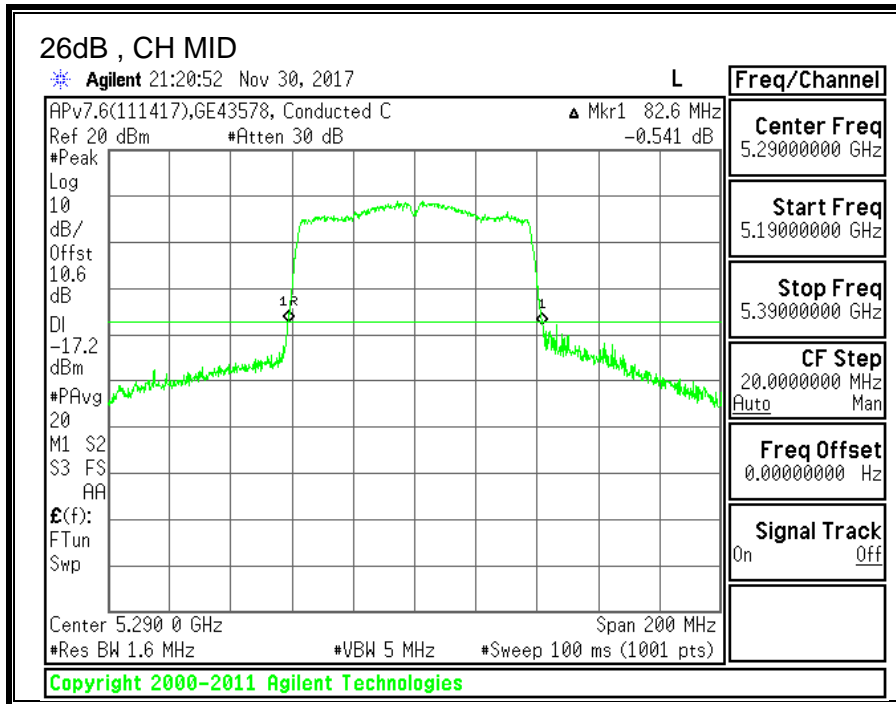

8.9.2. 99% BANDWIDTH

LIMITS

None; for reporting purposes only.

RESULTS

Channel	Frequency	99% BW (MHz)
Mid	5290	75.4797

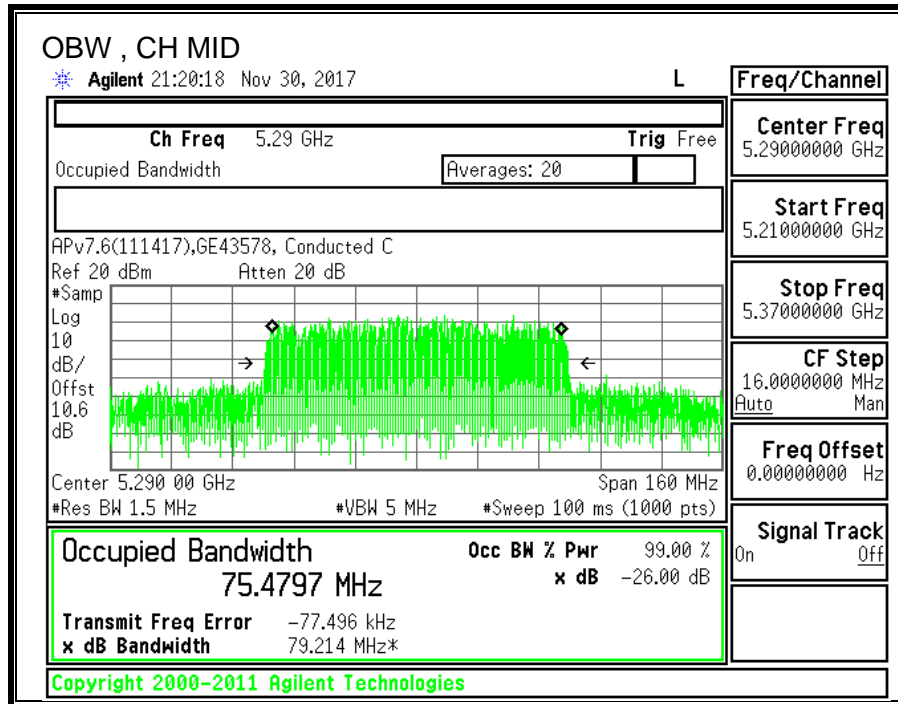

8.9.3. OUTPUT POWER AND PPSD

LIMITS

FCC §15.407 (a) (2)

For the band 5.25–5.35 GHz, the maximum conducted output power over the frequency band of operation shall not exceed the lesser of 250 mW or $11 \text{ dBm} + 10 \log B$, where B is the 26-dB emission bandwidth in MHz. In addition, the maximum power spectral density shall not exceed 11 dBm in any 1-MHz band. If transmitting antennas of directional gain greater than 6 dBi are used, both the maximum conducted output power and the peak power spectral density shall be reduced by the amount in dB that the directional gain of the antenna exceeds 6 dBi.

IC RSS-247 (6.2.2.1)

The maximum conducted output power shall not exceed 250 mW or $11 + 10 \log_{10} B$, dBm, whichever is less. The power spectral density shall not exceed 11 dBm in any 1.0 MHz band.

The maximum e.i.r.p. shall not exceed 1.0 W or $17 + 10 \log_{10} B$, dBm, whichever is less. B is the 99% emission bandwidth in megahertz. Note that devices with a maximum e.i.r.p. greater than 500 mW shall implement TPC in order to have the capability to operate at least 6 dB below the maximum permitted e.i.r.p. of 1 W.

TEST PROCEDURE

Measurements perform using a wideband gated RF power meter provided that the gate parameters are adjusted such that the power is measured only when the EUT is transmitting at its maximum power control level. Since the measurement is made only during the ON time of the transmitter, no duty cycle correction factor is required.

DIRECTIONAL ANTENNA GAIN

There is only one transmitter output therefore the directional gain is equal to the antenna gain.

RESULTS

ID:	GE43578	Date:	11/30/2017
------------	---------	--------------	------------

Bandwidth and Antenna Gain

Channel	Frequency (MHz)	Min 26 dB BW (MHz)	Min 99% BW (MHz)	Directional Gain for Power (dBi)	Directional Gain for PPSD (dBi)
Mid	5290	82.60	75.4797	3.30	3.30

Limits

Channel	Frequency (MHz)	FCC Power Limit (dBm)	IC Power Limit (dBm)	IC EIRP Limit (dBm)	Power Limit (dBm)	FCC PPSD Limit (dBm)	IC PSD Limit (dBm)	PPSD Limit (dBm)
Mid	5290	24.00	24.00	30.00	24.00	11.00	11.00	11.00

Duty Cycle CF (dB)	1.18	Included in Calculations of Corr'd PPSD
---------------------------	------	--

Output Power Results

Channel	Frequency (MHz)	Meas Power (dBm)	Total Corr'd Power (dBm)	Power Limit (dBm)	Power Margin (dB)
Mid	5290	12.02	12.02	24.00	-11.98

PPSD Results

Channel	Frequency (MHz)	Meas PPSD (dBm)	Total Corr'd PPSD (dBm)	PPSD Limit (dBm)	PPSD Margin (dB)
Mid	5290	-3.816	-2.64	11.00	-13.64

Note: the power readings above were measured with gated method, and the measurement was taken only during the ON time. No duty cycle correction was necessary.

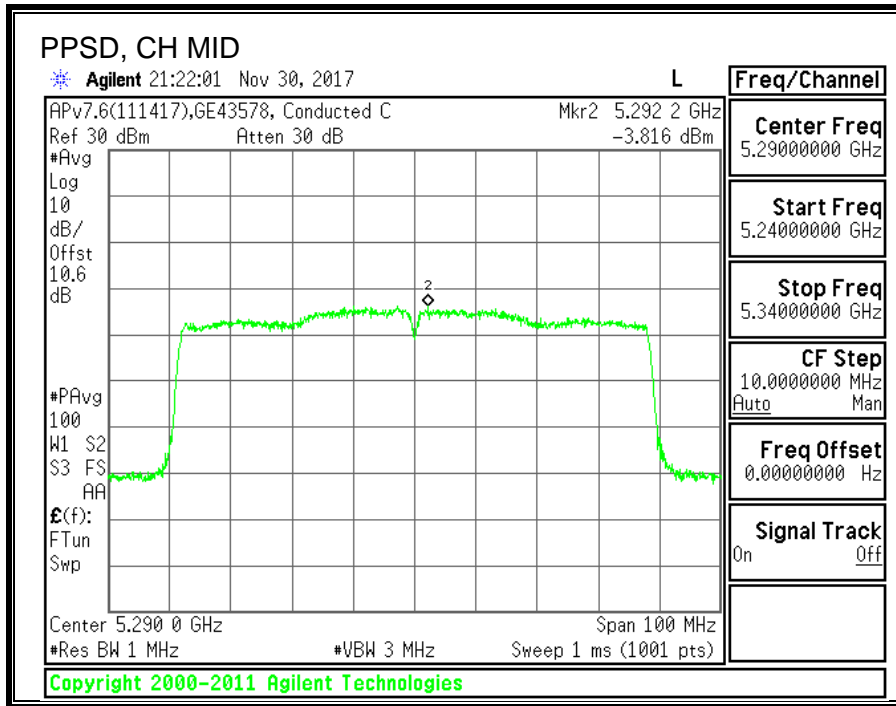

8.10. 11a MODE IN THE 5.6GHz BAND

8.10.1. 26 dB BANDWIDTH

LIMITS

None; for reporting purposes only.

RESULTS

Channel	Frequency	26 dB BW (MHz)
Low	5500	21.85
Mid	5580	21.90
High	5700	22.05

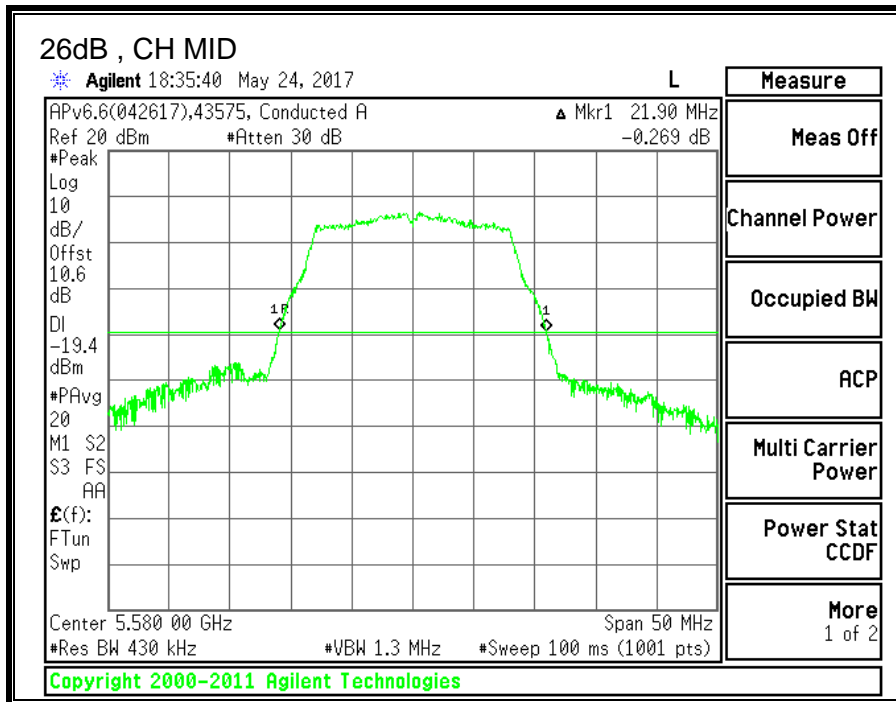
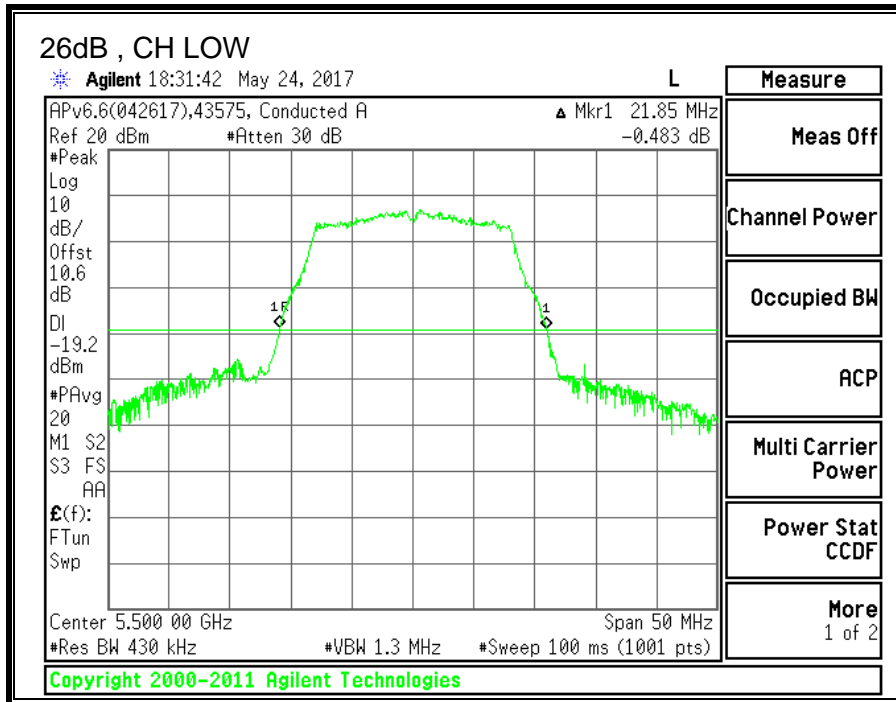

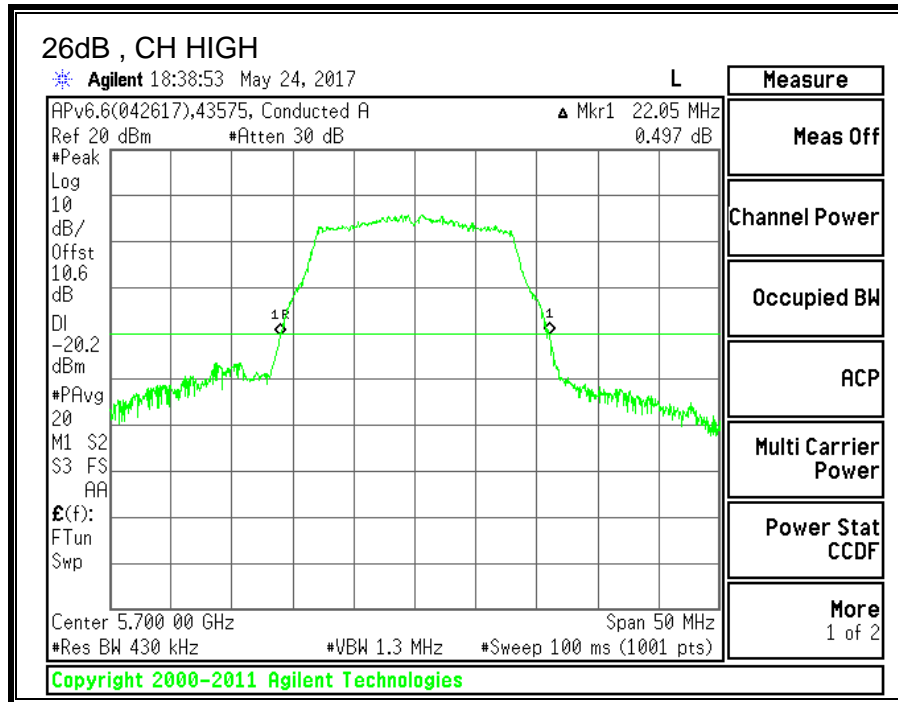

8.10.2. 99% BANDWIDTH

LIMITS

None; for reporting purposes only.

RESULTS

Channel	Frequency	99% BW (MHz)
Low	5500	16.3592
Mid	5580	15.8958
High	5700	16.3266

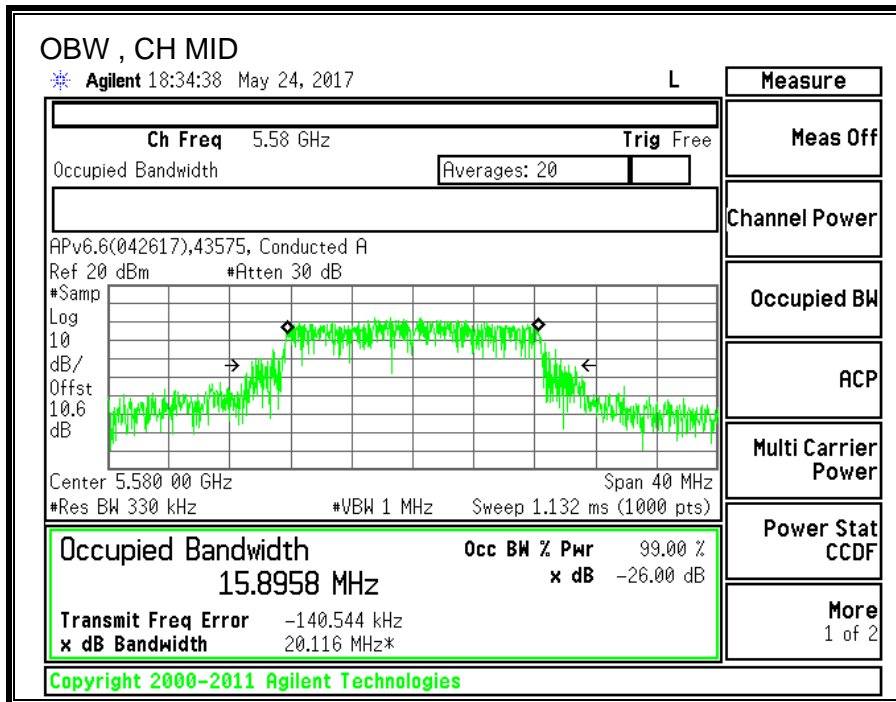
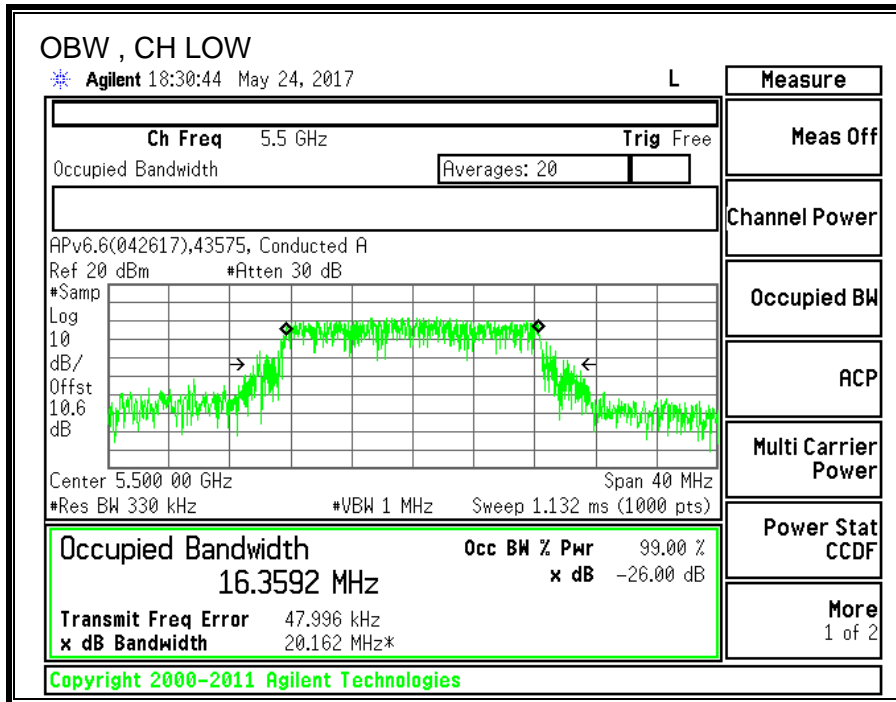

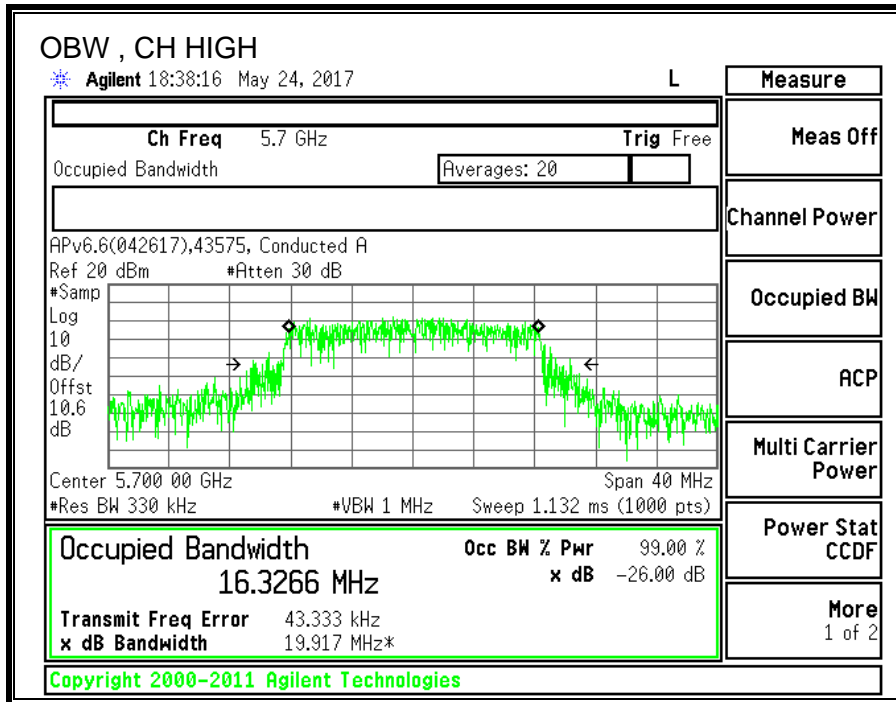

8.10.3. OUTPUT POWER AND PPSD

LIMITS

FCC §15.407 (a) (2)

For the band 5.47–5.725 GHz, the maximum conducted output power over the frequency band of operation shall not exceed the lesser of 250 mW or $11 \text{ dBm} + 10 \log B$, where B is the 26–dB emission bandwidth in MHz. In addition, the maximum power spectral density shall not exceed 11 dBm in any 1–MHz band. If transmitting antennas of directional gain greater than 6 dBi are used, both the maximum conducted output power and the peak power spectral density shall be reduced by the amount in dB that the directional gain of the antenna exceeds 6 dBi.

IC RSS-247 (6.2.3) (1)

The maximum conducted output power shall not exceed 250 mW or $11 + 10 \log_{10} B$, dBm, whichever is less. The power spectral density shall not exceed 11 dBm in any 1.0 MHz band.

The maximum e.i.r.p. shall not exceed 1.0 W or $17 + 10 \log_{10} B$, dBm, whichever is less. B is the 99% emission bandwidth in megahertz. Note that devices with a maximum e.i.r.p. greater than 500 mW shall implement TPC in order to have the capability to operate at least 6 dB below the maximum permitted e.i.r.p. of 1 W.

TEST PROCEDURE

Measurements perform using a wideband gated RF power meter provided that the gate parameters are adjusted such that the power is measured only when the EUT is transmitting at its maximum power control level. Since the measurement is made only during the ON time of the transmitter, no duty cycle correction factor is required.

Straddle channel power is measured using PXA spectrum analyzer, duty cycle correction factor is required.

DIRECTIONAL ANTENNA GAIN

There is only one transmitter output therefore the directional gain is equal to the antenna gain.

RESULTS

ID:	43574	Date:	5/24/2017
------------	-------	--------------	-----------

Bandwidth and Antenna Gain

Channel	Frequency (MHz)	Min 26 dB BW (MHz)	Min 99% BW (MHz)	Directional Gain for Power (dBi)	Directional Gain for PPSD (dBi)
Low	5500	21.850	16.359	2.80	2.80
Mid	5580	21.900	15.896	2.80	2.80
High	5700	22.050	16.327	2.80	2.80

Limits

Channel	Frequency (MHz)	FCC Power Limit (dBm)	IC Power Limit (dBm)	IC EIRP Limit (dBm)	Power Limit (dBm)	FCC PSD Limit (dBm)	IC PSD Limit (dBm)	PPSD Limit (dBm)
Low	5500	24.00	23.14	29.14	23.14	11.00	11.00	11.00
Mid	5580	24.00	23.01	29.01	23.01	11.00	11.00	11.00
High	5700	24.00	23.13	29.13	23.13	11.00	11.00	11.00

Duty Cycle CF (dB)	0.29	Included in Calculations of Corr'd PPSD
---------------------------	------	--

Output Power Results

Channel	Frequency (MHz)	Meas Power (dBm)	Total Corr'd Power (dBm)	Power Limit (dBm)	Power Margin (dB)
Low	5500	12.51	12.51	23.14	-10.63
Mid	5580	12.50	12.50	23.01	-10.51
High	5700	12.61	12.61	23.13	-10.52

PPSD Results

Channel	Frequency (MHz)	Meas PPSD (dBm)	Total Corr'd PPSD (dBm)	PPSD Limit (dBm)	PPSD Margin (dB)
Low	5500	3.285	3.58	11.00	-7.43
Mid	5580	2.836	3.13	11.00	-7.87
High	5700	1.884	2.17	11.00	-8.83

Note: the power readings above were measured with gated method, and the measurement was taken only during the ON time. No duty cycle correction was necessary.

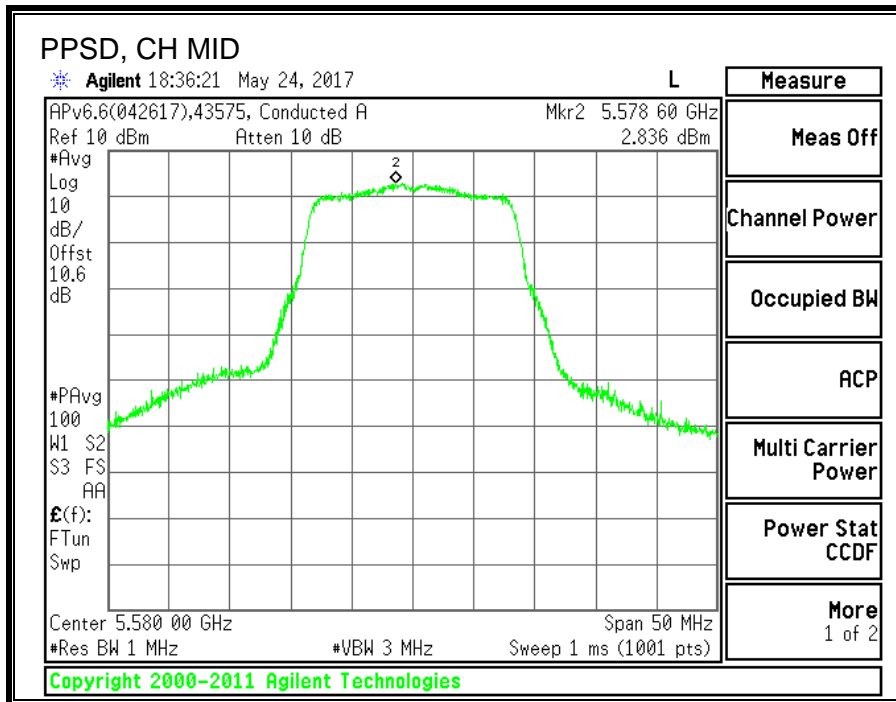
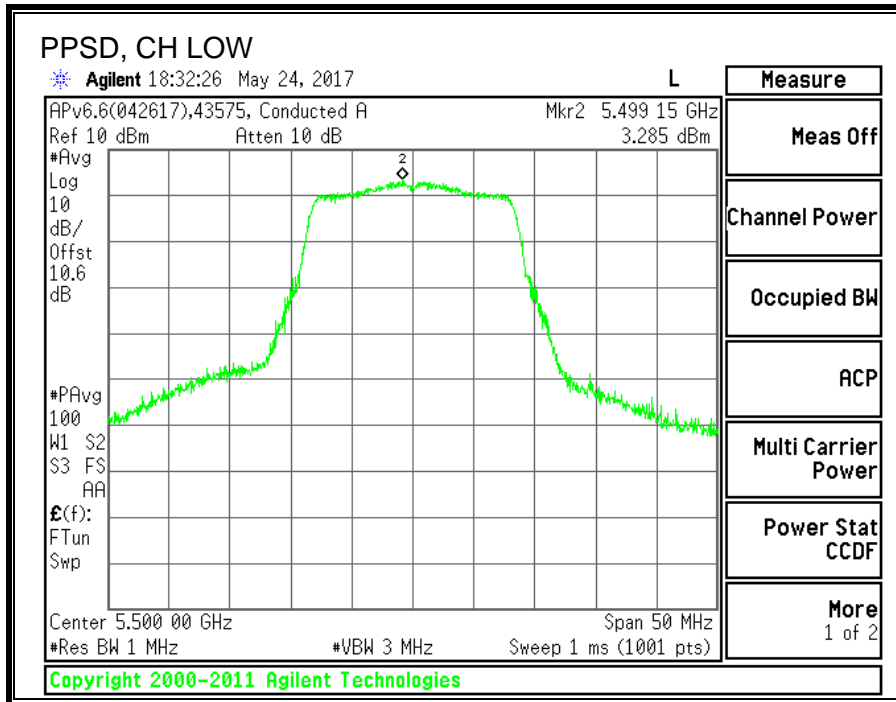

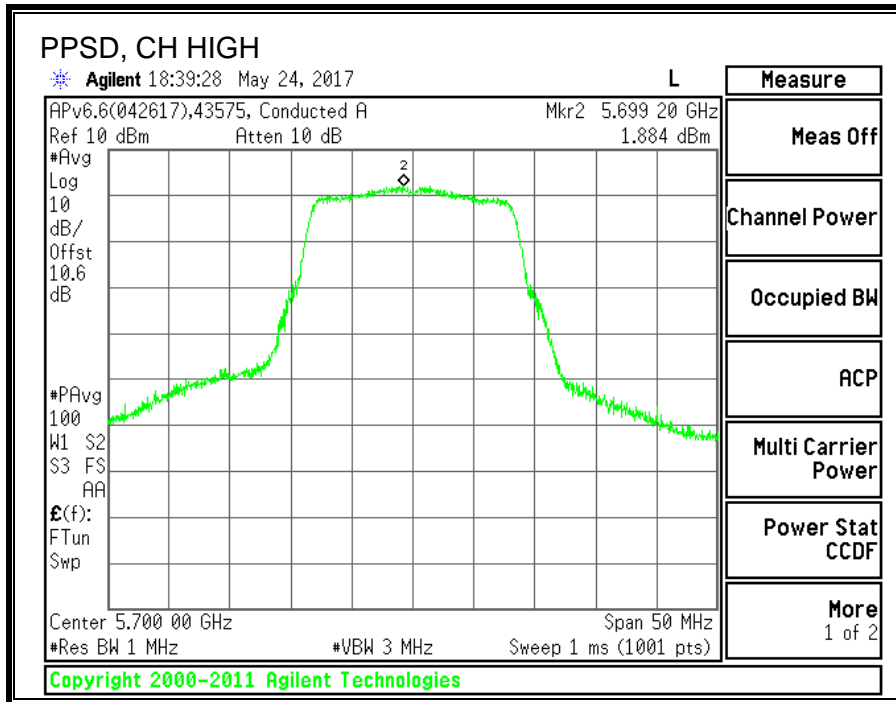

8.11. 11n HT20 MODE IN THE 5.6GHz BAND

8.11.1. 26 dB BANDWIDTH

LIMITS

None; for reporting purposes only.

RESULTS

Channel	Frequency	26 dB BW (MHz)
Low	5500	22.00
Mid	5580	21.95
High	5700	22.00

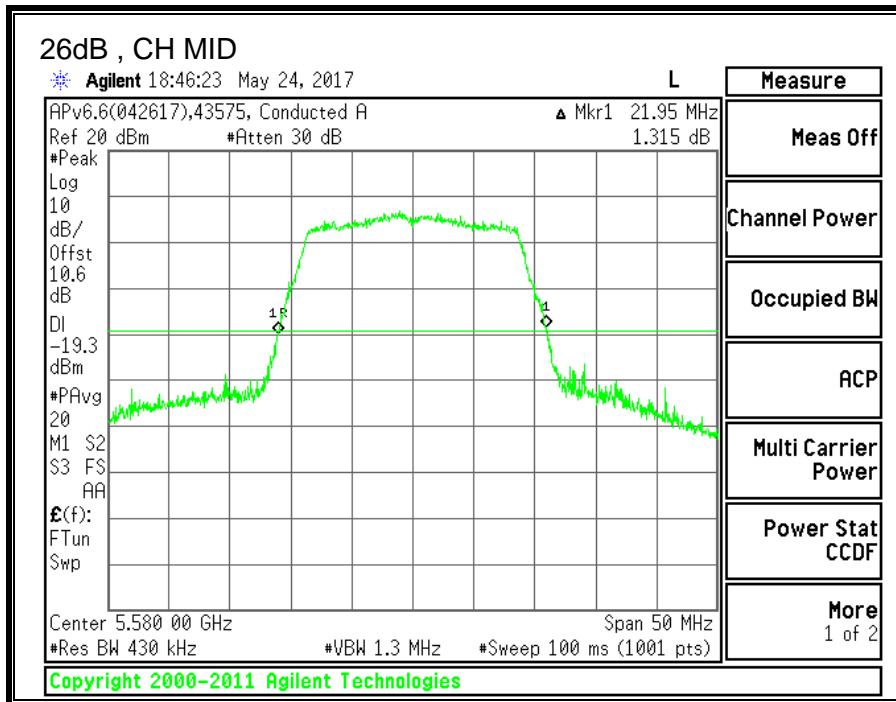
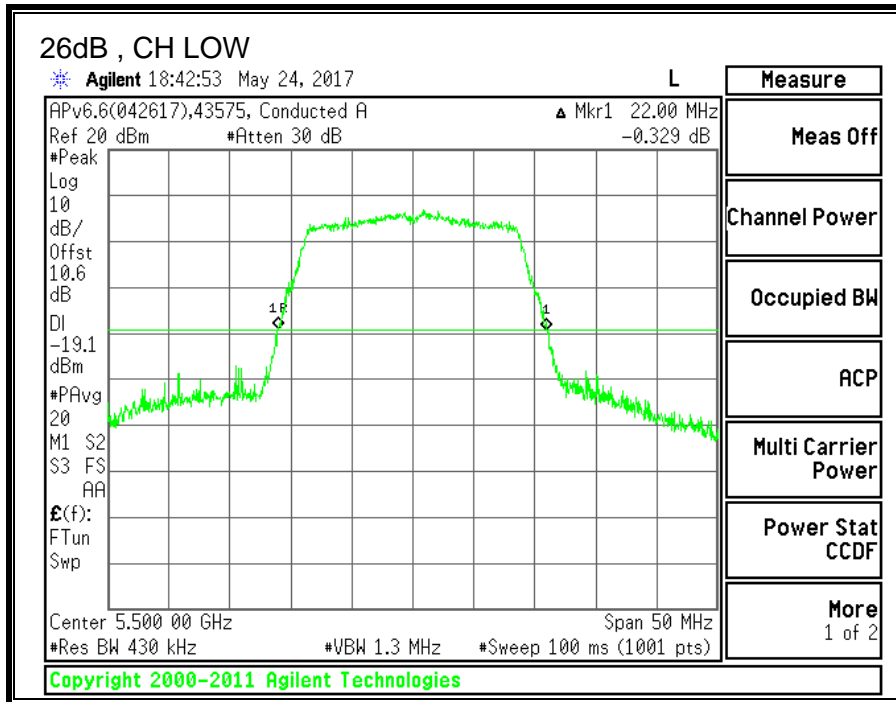

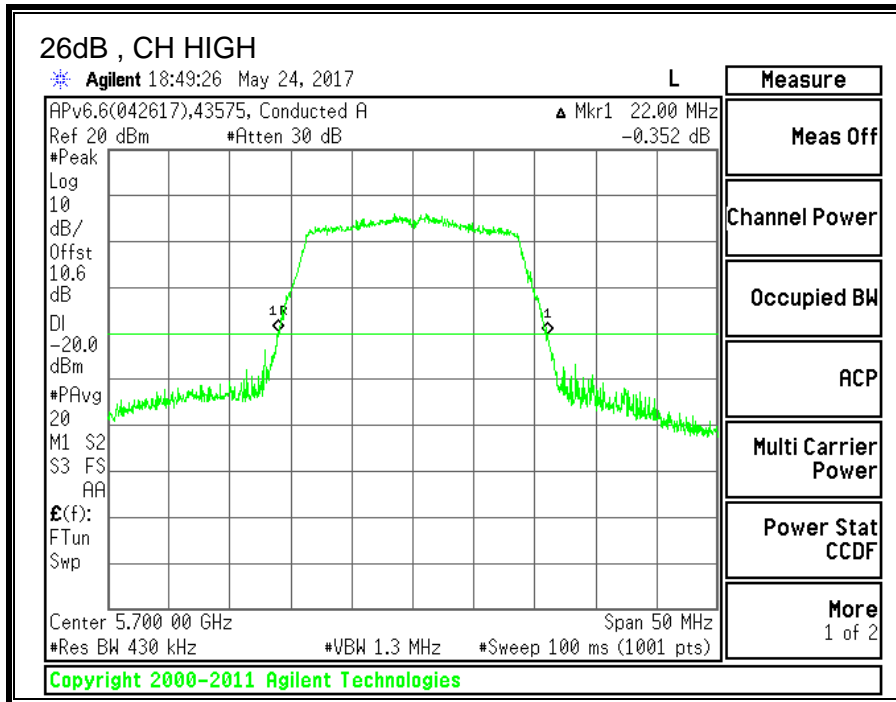

8.11.2. 99% BANDWIDTH

LIMITS

None; for reporting purposes only.

RESULTS

Channel	Frequency	99% BW (MHz)
Low	5500	17.5333
Mid	5580	17.4372
High	5700	17.3610

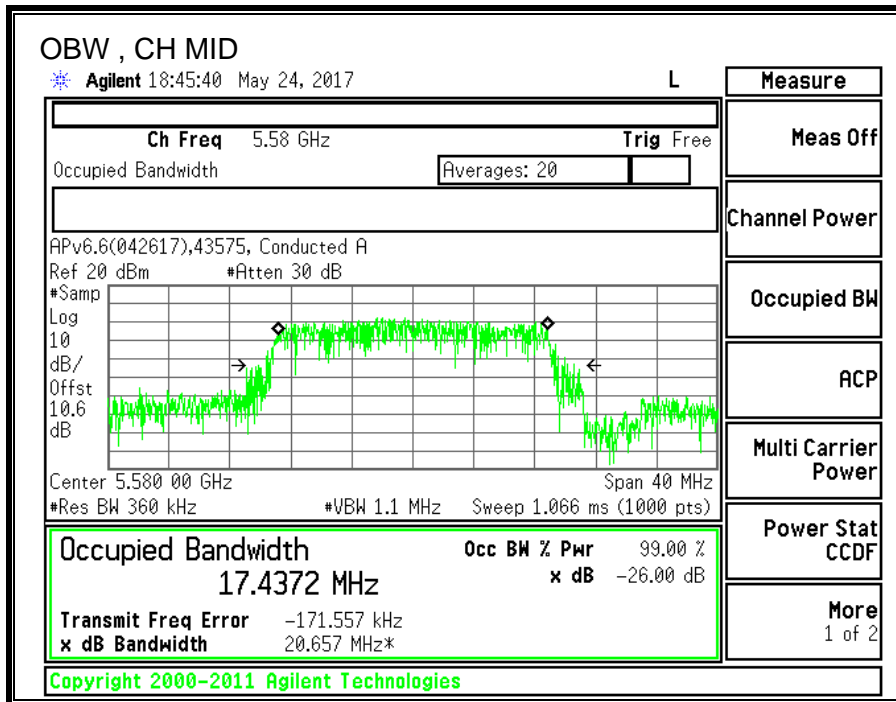
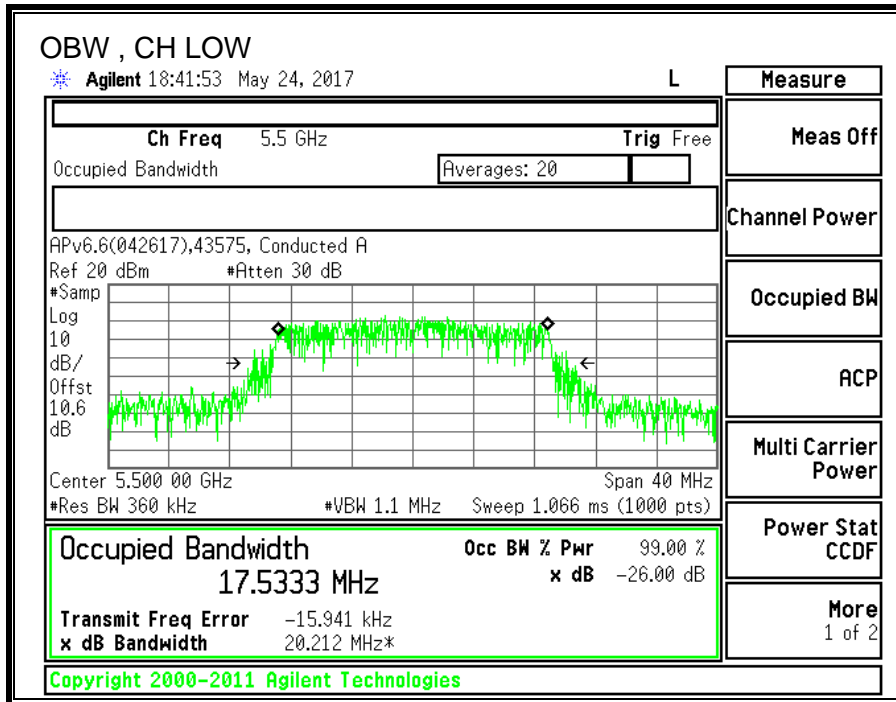

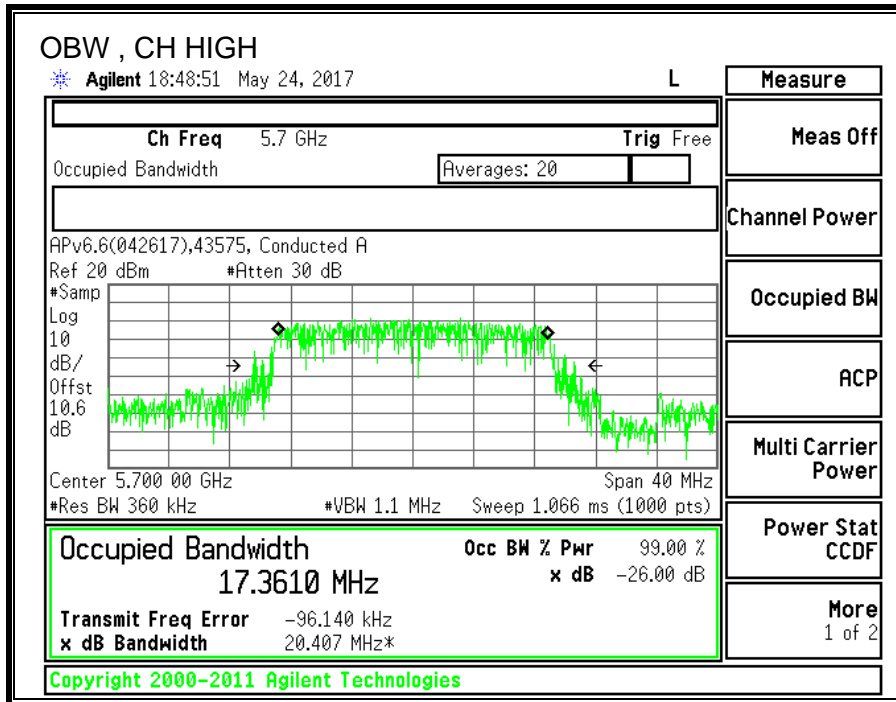

8.11.3. OUTPUT POWER AND PPSD

LIMITS

FCC §15.407 (a) (2)

For the band 5.47–5.725 GHz, the maximum conducted output power over the frequency band of operation shall not exceed the lesser of 250 mW or $11 \text{ dBm} + 10 \log B$, where B is the 26–dB emission bandwidth in MHz. In addition, the maximum power spectral density shall not exceed 11 dBm in any 1–MHz band. If transmitting antennas of directional gain greater than 6 dBi are used, both the maximum conducted output power and the peak power spectral density shall be reduced by the amount in dB that the directional gain of the antenna exceeds 6 dBi.

IC RSS-247 (6.2.3.1)

The maximum conducted output power shall not exceed 250 mW or $11 + 10 \log_{10} B$, dBm, whichever is less. The power spectral density shall not exceed 11 dBm in any 1.0 MHz band.

The maximum e.i.r.p. shall not exceed 1.0 W or $17 + 10 \log_{10} B$, dBm, whichever is less. B is the 99% emission bandwidth in megahertz. Note that devices with a maximum e.i.r.p. greater than 500 mW shall implement TPC in order to have the capability to operate at least 6 dB below the maximum permitted e.i.r.p. of 1 W.

TEST PROCEDURE

Measurements perform using a wideband gated RF power meter provided that the gate parameters are adjusted such that the power is measured only when the EUT is transmitting at its maximum power control level. Since the measurement is made only during the ON time of the transmitter, no duty cycle correction factor is required.

Straddle channel power is measured using PXA spectrum analyzer, duty cycle correction factor is required.

DIRECTIONAL ANTENNA GAIN

There is only one transmitter output therefore the directional gain is equal to the antenna gain.

RESULTS

ID:	43574	Date:	5/24/2017
------------	-------	--------------	-----------

Bandwidth and Antenna Gain

Channel	Frequency (MHz)	Min 26 dB BW (MHz)	Min 99% BW (MHz)	Directional Gain for Power (dBi)	Directional Gain for PPSD (dBi)
Low	5500	22.000	17.533	2.80	2.80
Mid	5580	21.950	17.437	2.80	2.80
High	5700	22.000	17.361	2.80	2.80

Limits

Channel	Frequency (MHz)	FCC Power Limit (dBm)	IC Power Limit (dBm)	IC EIRP Limit (dBm)	Power Limit (dBm)	FCC PSD Limit (dBm)	IC PSD Limit (dBm)	PPSD Limit (dBm)
Low	5500	24.00	23.44	29.44	23.44	11.00	11.00	11.00
Mid	5580	24.00	23.41	29.41	23.41	11.00	11.00	11.00
High	5700	24.00	23.40	29.40	23.40	11.00	11.00	11.00

Duty Cycle CF (dB)	0.31	Included in Calculations of Corr'd PPSD
---------------------------	------	--

Output Power Results

Channel	Frequency (MHz)	Meas Power (dBm)	Total Corr'd Power (dBm)	Power Limit (dBm)	Power Margin (dB)
Low	5500	12.51	12.30	23.44	-11.14
Mid	5580	12.37	12.37	23.41	-11.04
High	5700	12.47	12.47	23.40	-10.93

PPSD Results

Channel	Frequency (MHz)	Meas PPSD (dBm)	Total Corr'd PPSD (dBm)	PPSD Limit (dBm)	PPSD Margin (dB)
Low	5500	2.368	2.68	11.00	-8.32
Mid	5580	2.581	2.89	11.00	-8.11
High	5700	1.861	2.17	11.00	-8.83

Note: the power readings above were measured with gated method, and the measurement was taken only during the ON time. No duty cycle correction was necessary.

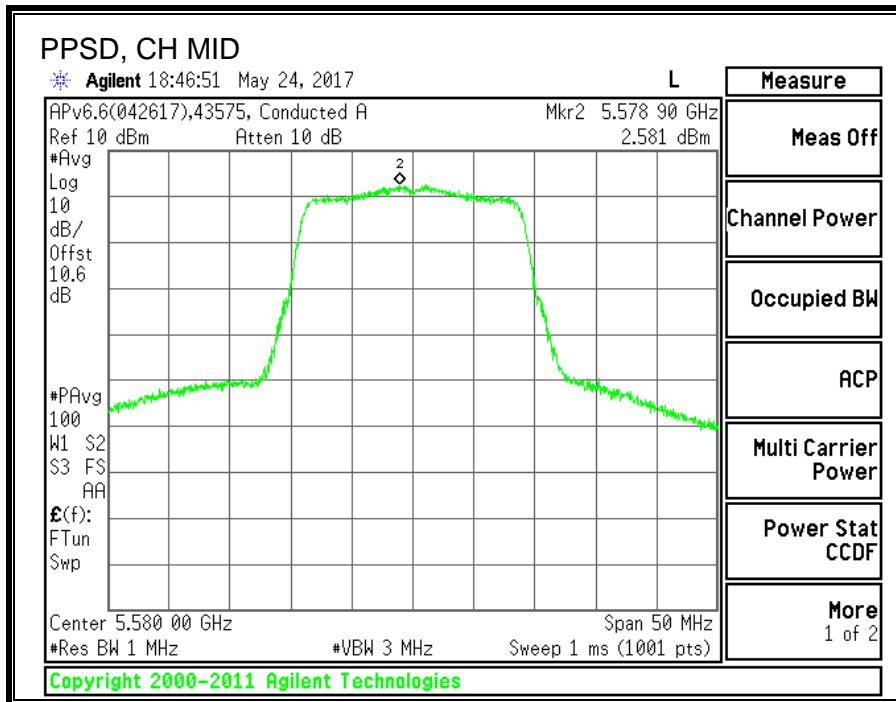
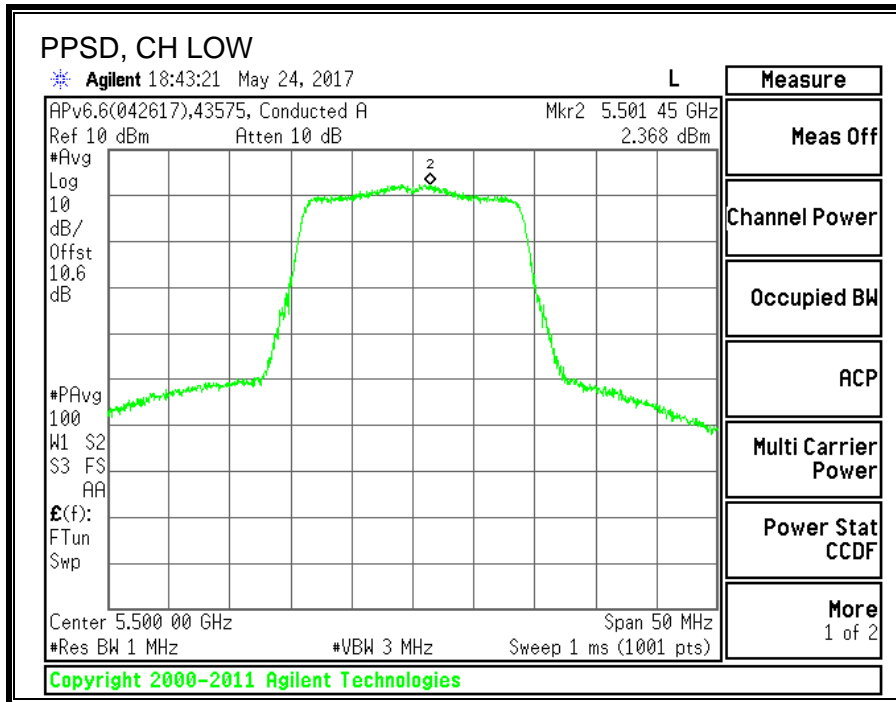

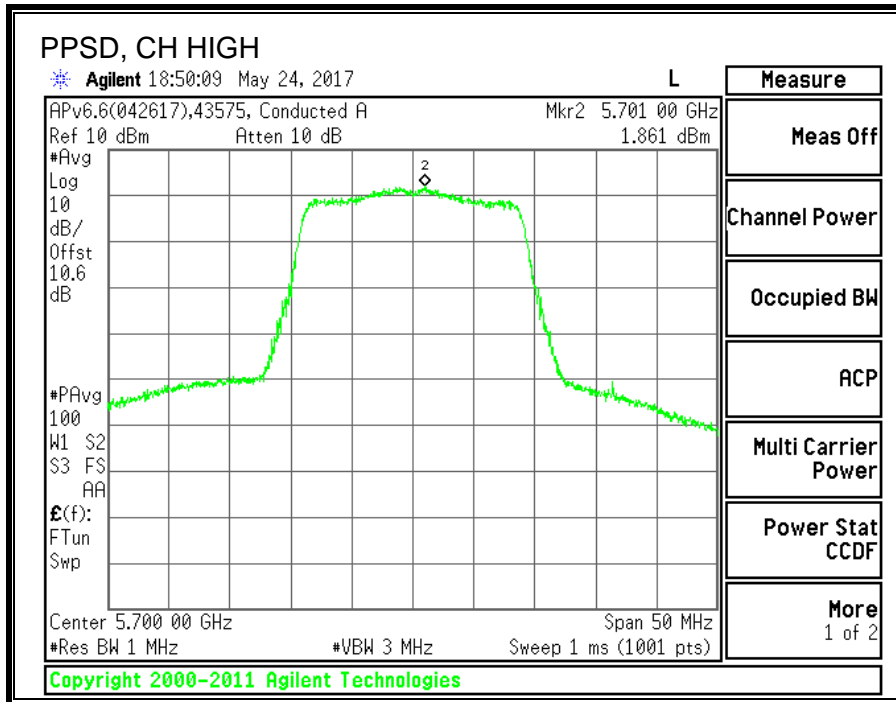

8.12. 11n HT40 MODE IN THE 5.6GHz BAND

8.12.1. 26 dB BANDWIDTH

LIMITS

None; for reporting purposes only.

RESULTS

Channel	Frequency	26 dB BW (MHz)
Low	5510	40.7
Mid	5550	40.6
High	5670	40.4

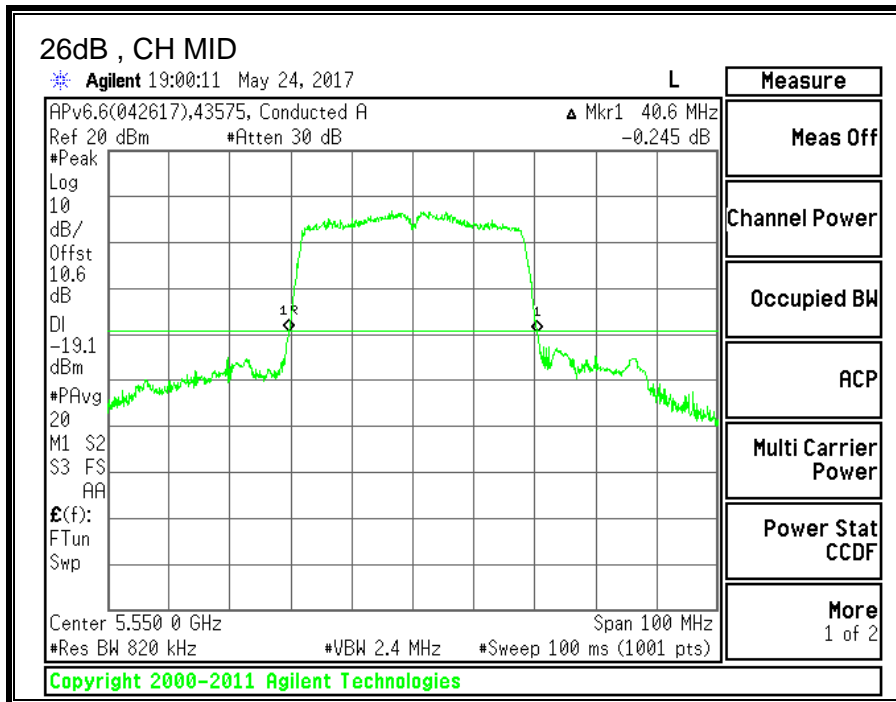
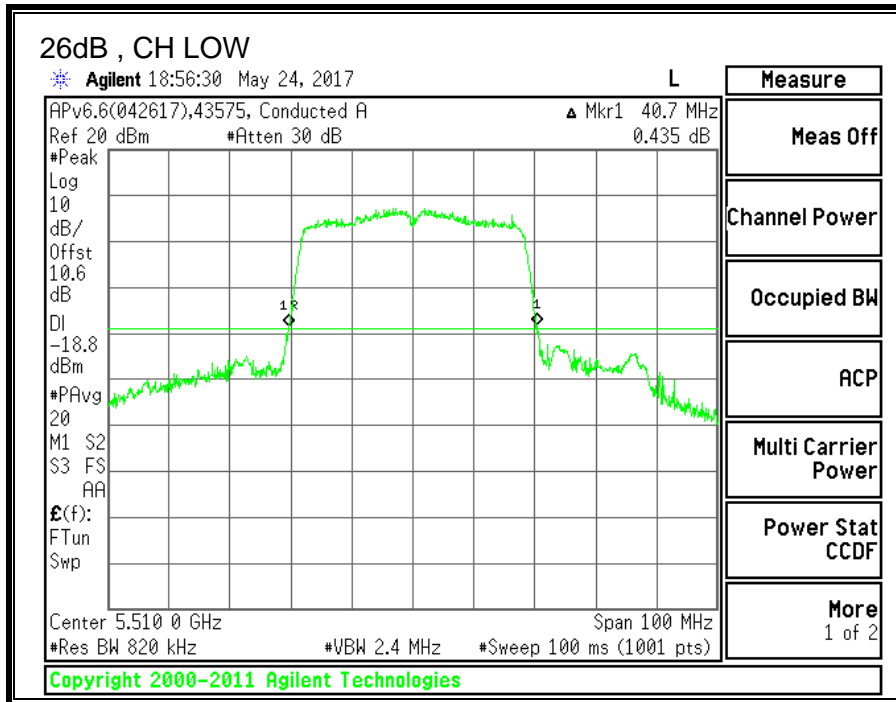

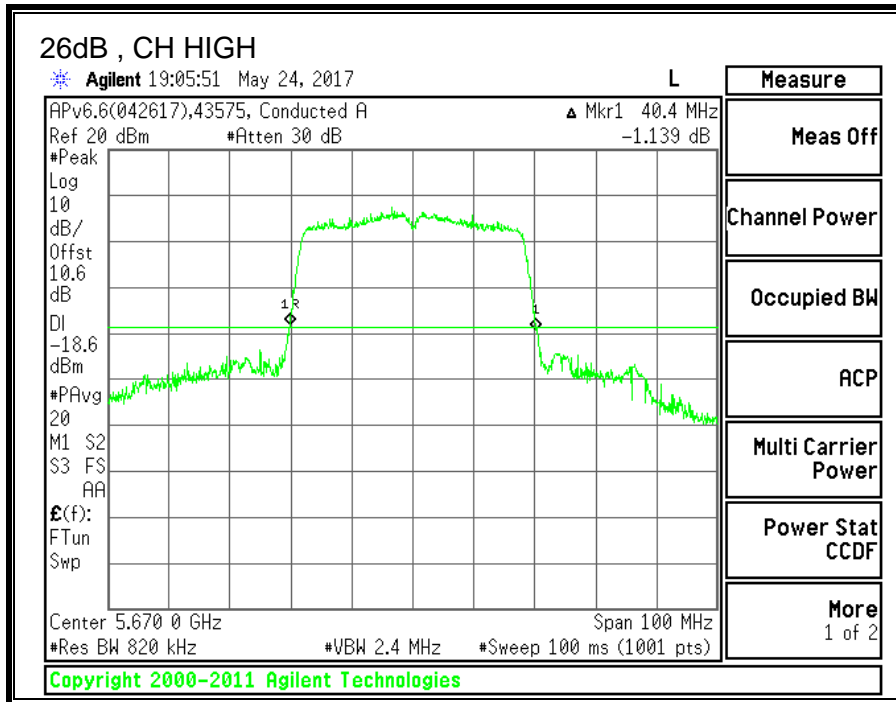

8.12.2. 99% BANDWIDTH

LIMITS

None; for reporting purposes only.

RESULTS

Channel	Frequency	99% BW (MHz)
Low	5510	35.4929
Mid	5550	35.7740
High	5670	36.1993

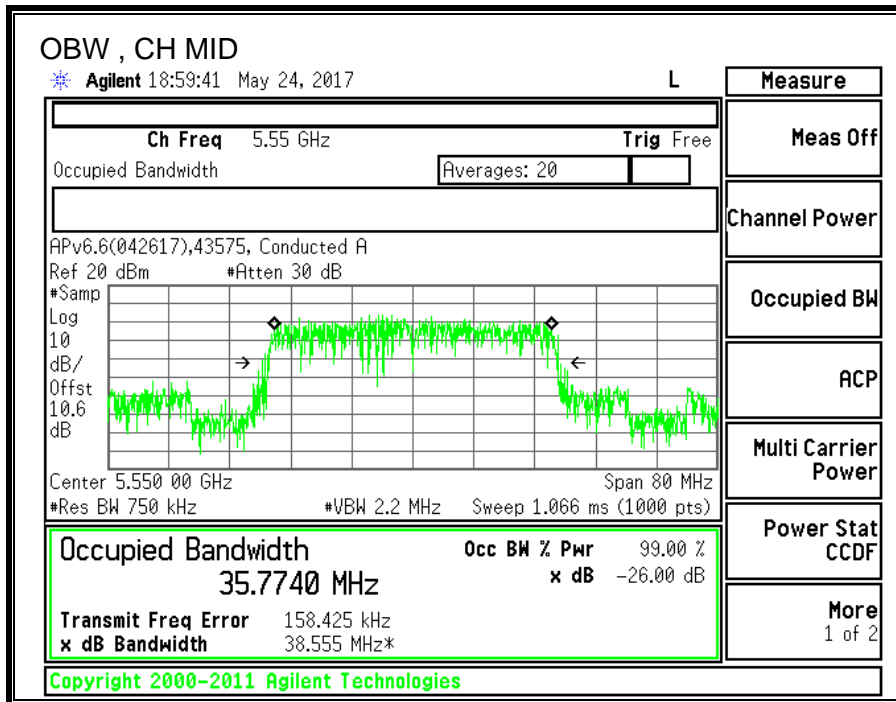
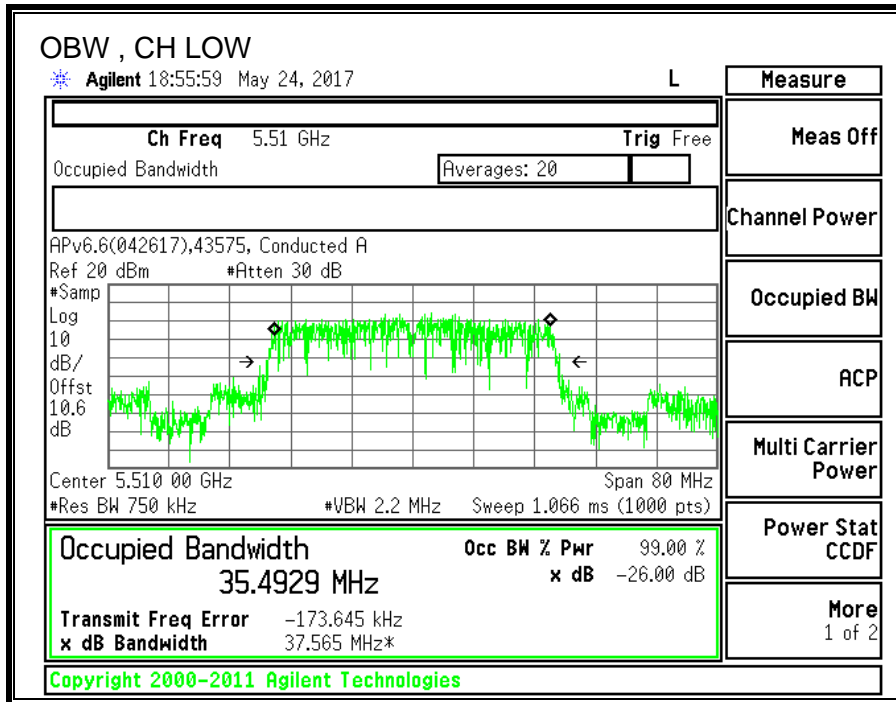

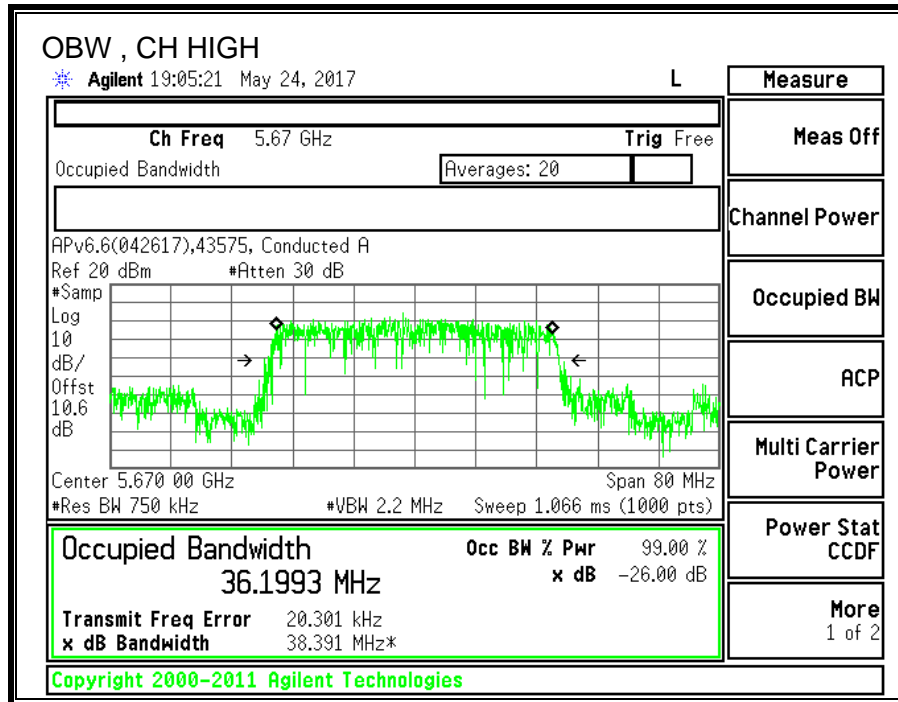

8.12.3. OUTPUT POWER AND PPSD

LIMITS

FCC §15.407 (a) (2)

For the band 5.47–5.725 GHz, the maximum conducted output power over the frequency band of operation shall not exceed the lesser of 250 mW or $11 \text{ dBm} + 10 \log B$, where B is the 26-dB emission bandwidth in MHz. In addition, the maximum power spectral density shall not exceed 11 dBm in any 1-MHz band. If transmitting antennas of directional gain greater than 6 dBi are used, both the maximum conducted output power and the peak power spectral density shall be reduced by the amount in dB that the directional gain of the antenna exceeds 6 dBi.

IC RSS-247 (6.2.3.1)

The maximum conducted output power shall not exceed 250 mW or $11 + 10 \log_{10} B$, dBm, whichever is less. The power spectral density shall not exceed 11 dBm in any 1.0 MHz band.

The maximum e.i.r.p. shall not exceed 1.0 W or $17 + 10 \log_{10} B$, dBm, whichever is less. B is the 99% emission bandwidth in megahertz. Note that devices with a maximum e.i.r.p. greater than 500 mW shall implement TPC in order to have the capability to operate at least 6 dB below the maximum permitted e.i.r.p. of 1 W.

TEST PROCEDURE

Measurements perform using a wideband gated RF power meter provided that the gate parameters are adjusted such that the power is measured only when the EUT is transmitting at its maximum power control level. Since the measurement is made only during the ON time of the transmitter, no duty cycle correction factor is required.

Straddle channel power is measured using PXA spectrum analyzer, duty cycle correction factor is required.

DIRECTIONAL ANTENNA GAIN

There is only one transmitter output therefore the directional gain is equal to the antenna gain.

RESULTS

ID:	43574	Date:	5/24/2017
------------	-------	--------------	-----------

Bandwidth and Antenna Gain

Channel	Frequency (MHz)	Min 26 dB BW (MHz)	Min 99% BW (MHz)	Directional Gain for Power (dBi)	Directional Gain for PPSD (dBi)
Low	5510	40.700	35.493	2.80	2.80
Mid	5550	40.600	35.774	2.80	2.80
High	5670	40.400	36.199	2.80	2.80

Limits

Channel	Frequency (MHz)	FCC Power Limit (dBm)	IC Power Limit (dBm)	IC EIRP Limit (dBm)	Power Limit (dBm)	FCC PSD Limit (dBm)	IC PSD Limit (dBm)	PPSD Limit (dBm)
Low	5510	24.00	24.00	30.00	24.00	11.00	11.00	11.00
Mid	5550	24.00	24.00	30.00	24.00	11.00	11.00	11.00
High	5670	24.00	24.00	30.00	24.00	11.00	11.00	11.00

Duty Cycle CF (dB)	0.42	Included in Calculations of Corr'd PPSD
---------------------------	------	--

Output Power Results

Channel	Frequency (MHz)	Meas Power (dBm)	Total Corr'd Power (dBm)	Power Limit (dBm)	Power Margin (dB)
Low	5510	12.17	12.17	24.00	-11.83
Mid	5550	12.37	12.37	24.00	-11.63
High	5670	12.28	12.28	24.00	-11.72

PPSD Results

Channel	Frequency (MHz)	Meas PPSD (dBm)	Total Corr'd PPSD (dBm)	PPSD Limit (dBm)	PPSD Margin (dB)
Low	5510	-0.325	0.09	11.00	-10.91
Mid	5550	-0.957	-0.54	11.00	-11.54
High	5670	-1.327	-0.91	11.00	-11.91

Note: the power readings above were measured with gated method, and the measurement was taken only during the ON time. No duty cycle correction was necessary.

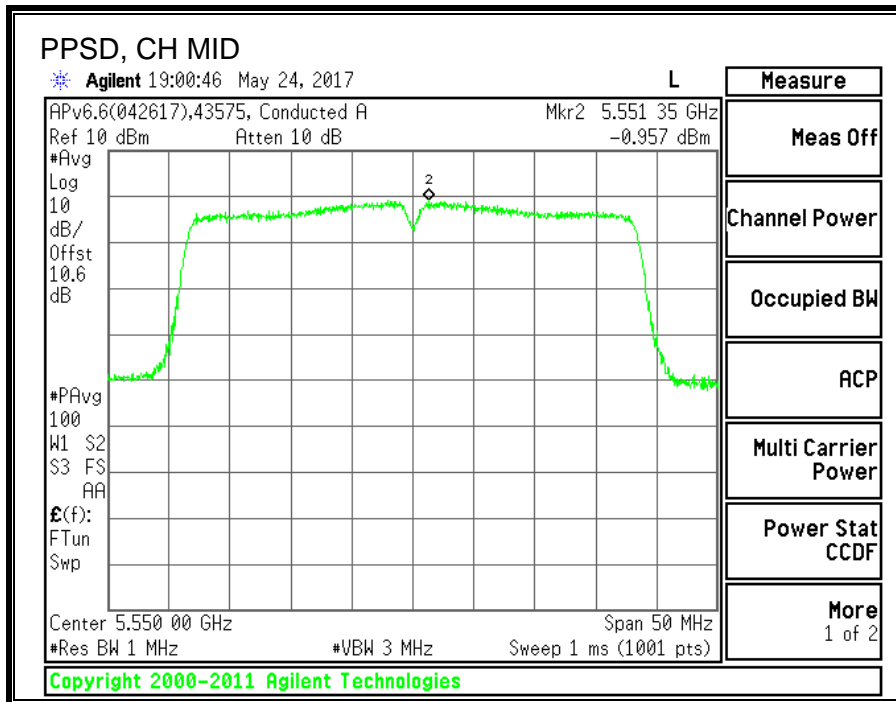
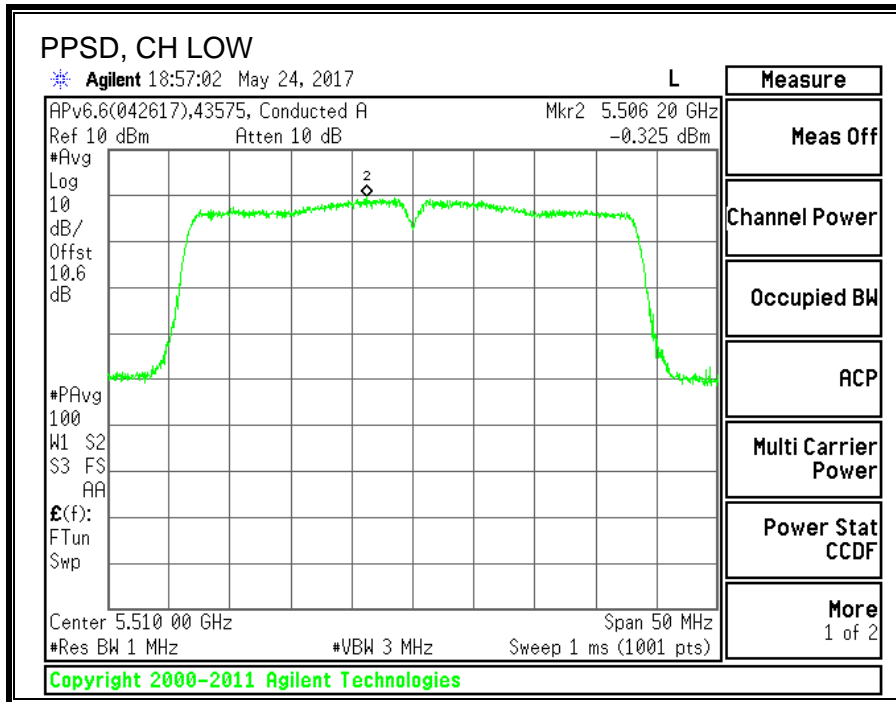

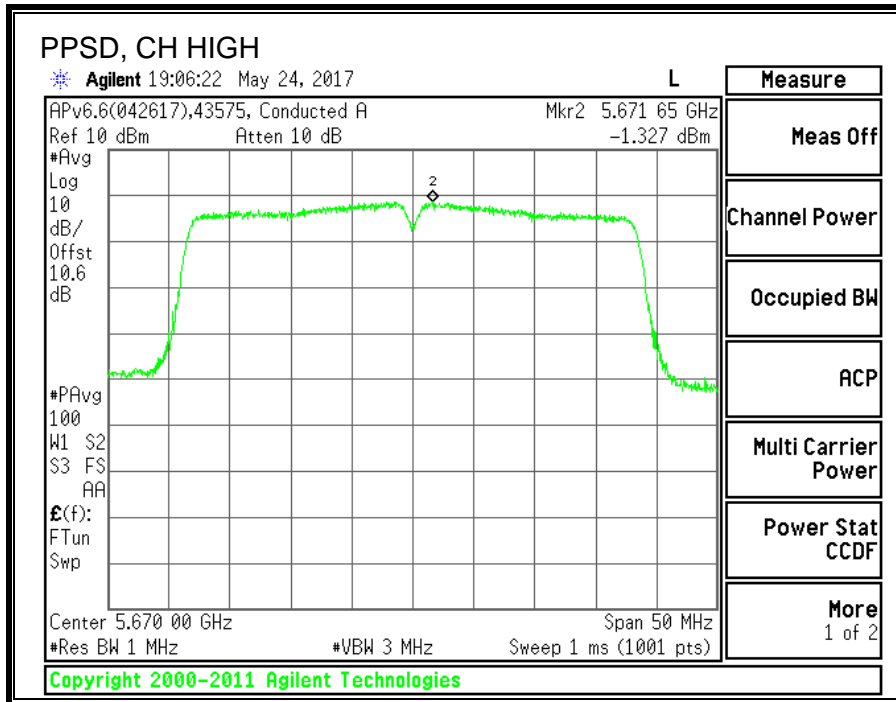

8.13. 11ac VHT80 MODE IN THE 5.6GHz BAND

8.13.1. 26 dB BANDWIDTH

LIMITS

None; for reporting purposes only.

RESULTS

Channel	Frequency	26 dB BW (MHz)
Low	5530	82.8
Mid	5610	82.6

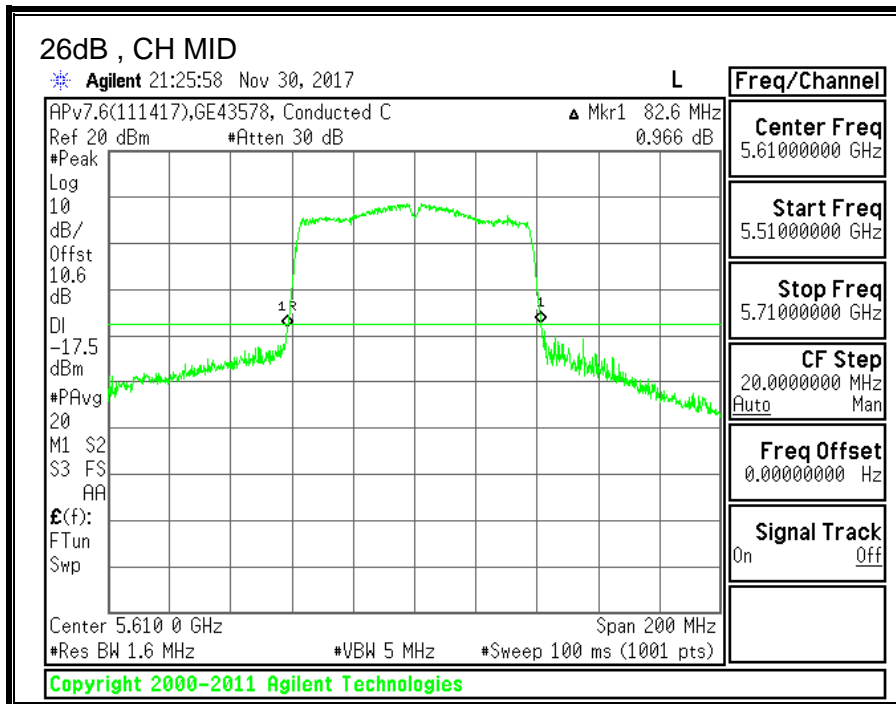
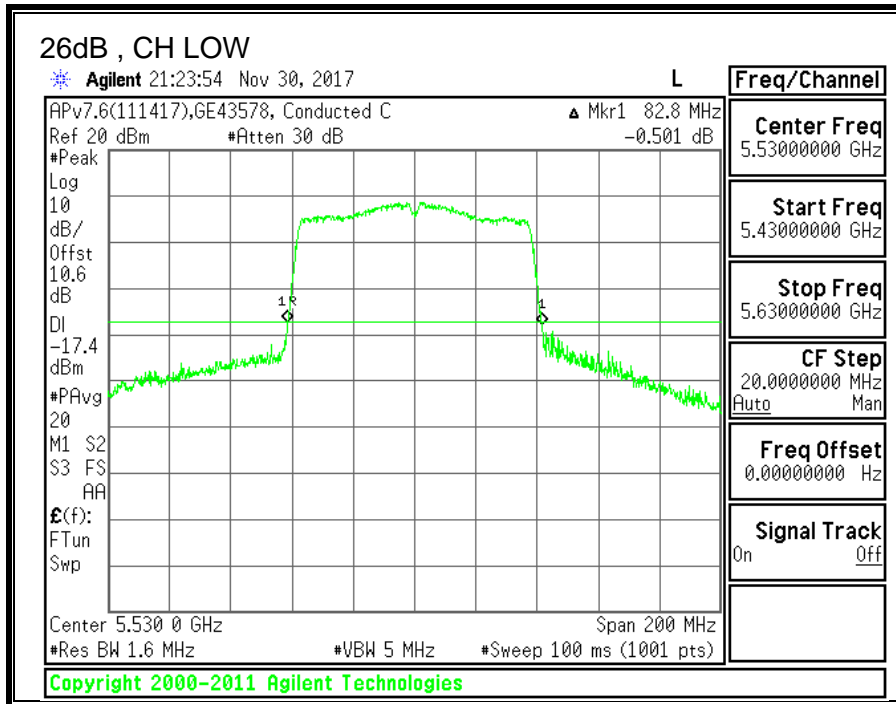

8.13.2. 99% BANDWIDTH

LIMITS

None; for reporting purposes only.

RESULTS

Channel	Frequency	99% BW (MHz)
Low	5530	75.6419
Mid	5610	75.4530

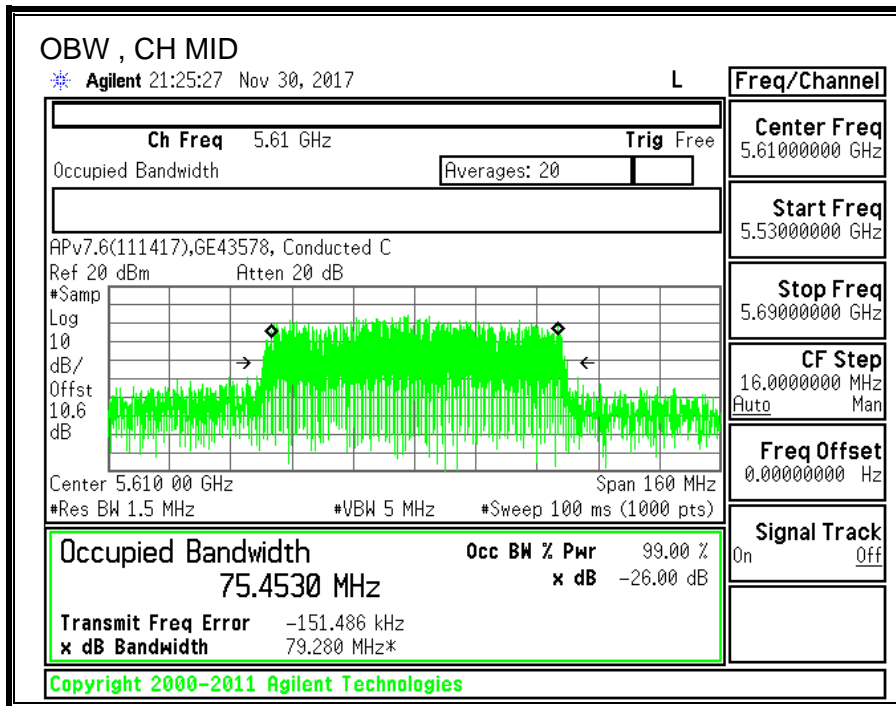
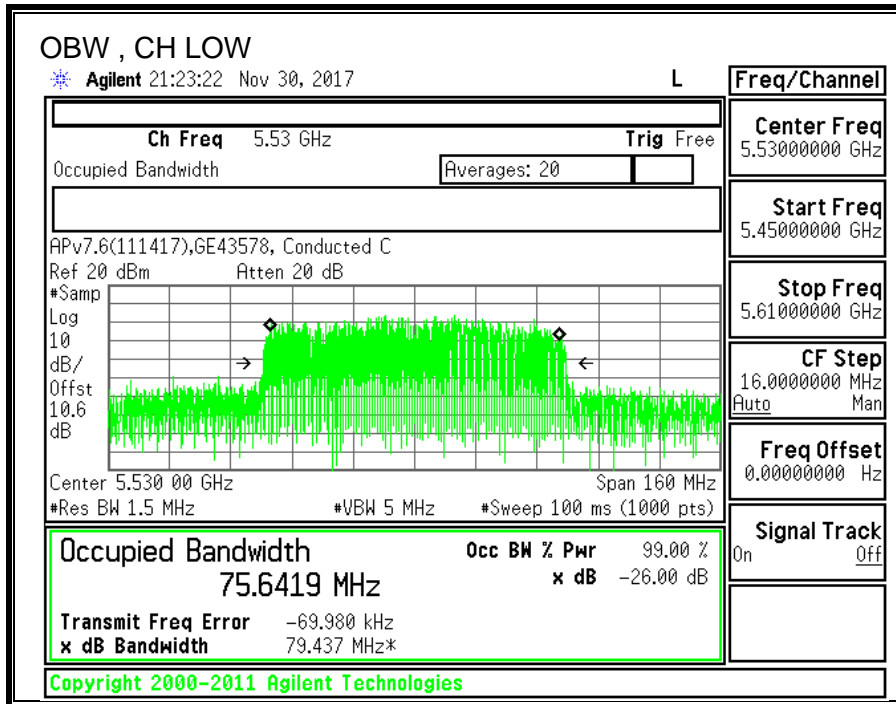

8.13.3. OUTPUT POWER AND PPSD

LIMITS

FCC §15.407 (a) (2)

For the band 5.47–5.725 GHz, the maximum conducted output power over the frequency band of operation shall not exceed the lesser of 250 mW or $11 \text{ dBm} + 10 \log B$, where B is the 26-dB emission bandwidth in MHz. In addition, the maximum power spectral density shall not exceed 11 dBm in any 1-MHz band. If transmitting antennas of directional gain greater than 6 dBi are used, both the maximum conducted output power and the peak power spectral density shall be reduced by the amount in dB that the directional gain of the antenna exceeds 6 dBi.

IC RSS-247 (6.2.3.1)

The maximum conducted output power shall not exceed 250 mW or $11 + 10 \log_{10} B$, dBm, whichever is less. The power spectral density shall not exceed 11 dBm in any 1.0 MHz band.

The maximum e.i.r.p. shall not exceed 1.0 W or $17 + 10 \log_{10} B$, dBm, whichever is less. B is the 99% emission bandwidth in megahertz. Note that devices with a maximum e.i.r.p. greater than 500 mW shall implement TPC in order to have the capability to operate at least 6 dB below the maximum permitted e.i.r.p. of 1 W.

TEST PROCEDURE

Measurements perform using a wideband gated RF power meter provided that the gate parameters are adjusted such that the power is measured only when the EUT is transmitting at its maximum power control level. Since the measurement is made only during the ON time of the transmitter, no duty cycle correction factor is required.

Straddle channel power is measured using PXA spectrum analyzer, duty cycle correction factor is required.

DIRECTIONAL ANTENNA GAIN

There is only one transmitter output therefore the directional gain is equal to the antenna gain.

RESULTS

ID:	GE43578	Date:	11/30/2017
------------	---------	--------------	------------

Bandwidth and Antenna Gain

Channel	Frequency (MHz)	Min 26 dB BW (MHz)	Min 99% BW (MHz)	Directional Gain for Power (dBi)	Directional Gain for PPSD (dBi)
Low	5530	82.800	75.642	2.80	2.80
Mid	5610	82.600	75.453	2.80	2.80

Limits

Channel	Frequency (MHz)	FCC Power Limit (dBm)	IC Power Limit (dBm)	IC EIRP Limit (dBm)	Power Limit (dBm)	FCC PPSD Limit (dBm)	IC PSD Limit (dBm)	PPSD Limit (dBm)
Low	5530	24.00	24.00	30.00	24.00	11.00	11.00	11.00
Mid	5610	24.00	24.00	30.00	24.00	11.00	11.00	11.00

Duty Cycle CF (dB)	1.18	Included in Calculations of Corr'd PPSD
---------------------------	------	--

Output Power Results

Channel	Frequency (MHz)	Meas Power (dBm)	Total Corr'd Power (dBm)	Power Limit (dBm)	Power Margin (dB)
Low	5530	12.05	12.05	24.00	-11.95
Mid	5610	12.01	12.01	24.00	-11.99

PPSD Results

Channel	Frequency (MHz)	Meas PPSD (dBm)	Total Corr'd PPSD (dBm)	PPSD Limit (dBm)	PPSD Margin (dB)
Low	5530	-0.325	0.86	11.00	-10.15
Mid	5610	-0.957	0.22	11.00	-10.78

Note: the power readings above were measured with gated method, and the measurement was taken only during the ON time. No duty cycle correction was necessary.

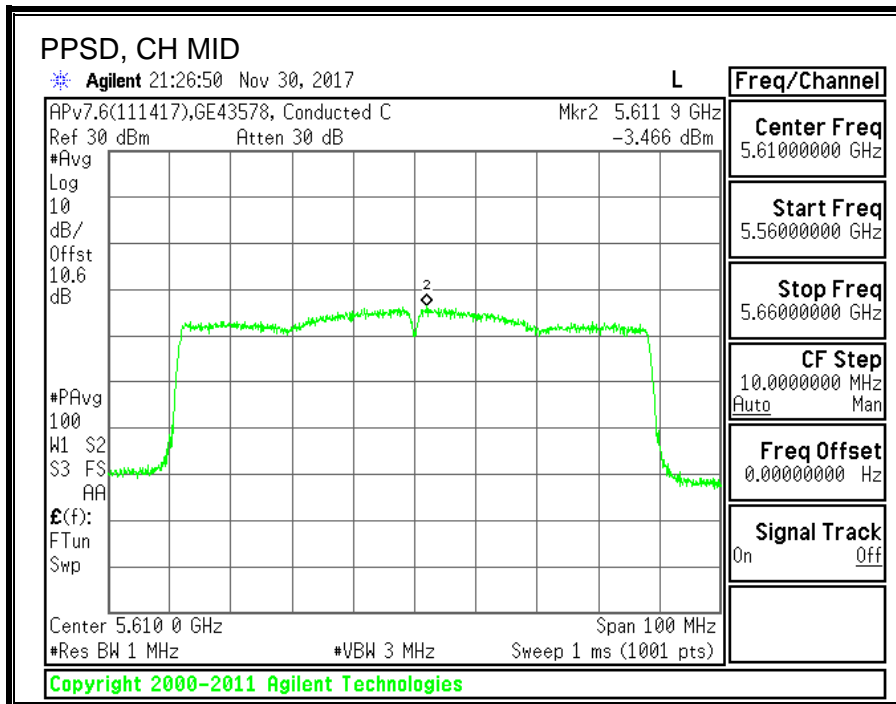
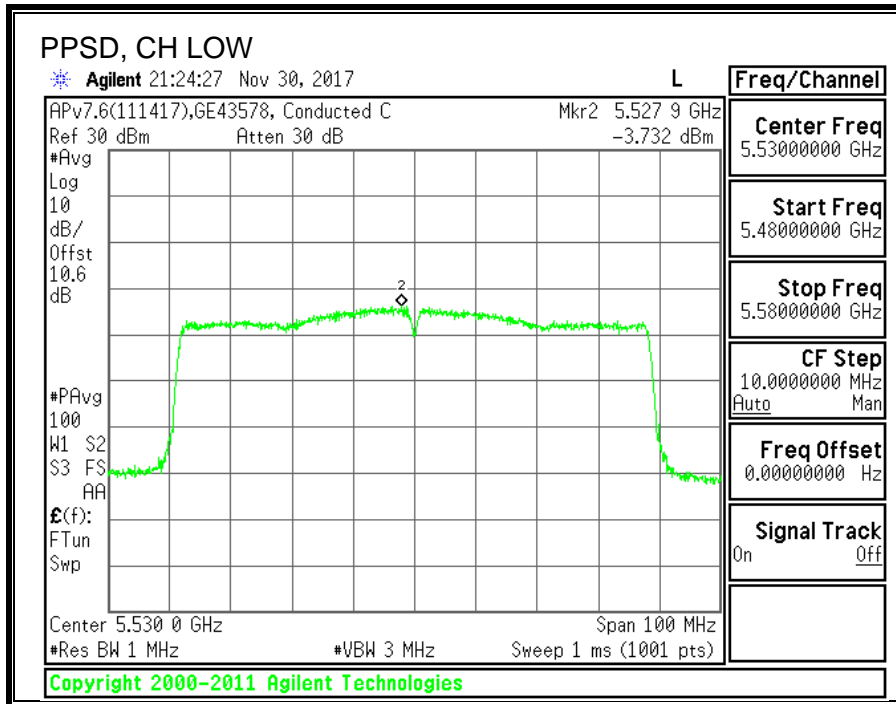

8.14. 11a MODE IN THE 5.8GHz BAND

8.14.1. 6 dB BANDWIDTH

LIMITS

FCC §15.407 (e)

IC RSS-247 (6.2.4) (1)

The minimum 6 dB bandwidth shall be at least 500 kHz.

RESULTS

Channel	Frequency	6 dB BW (MHz)	Minimum Limit (MHz)
Low	5745	16.35	0.5
Mid	5785	16.35	0.5
High	5825	16.35	0.5

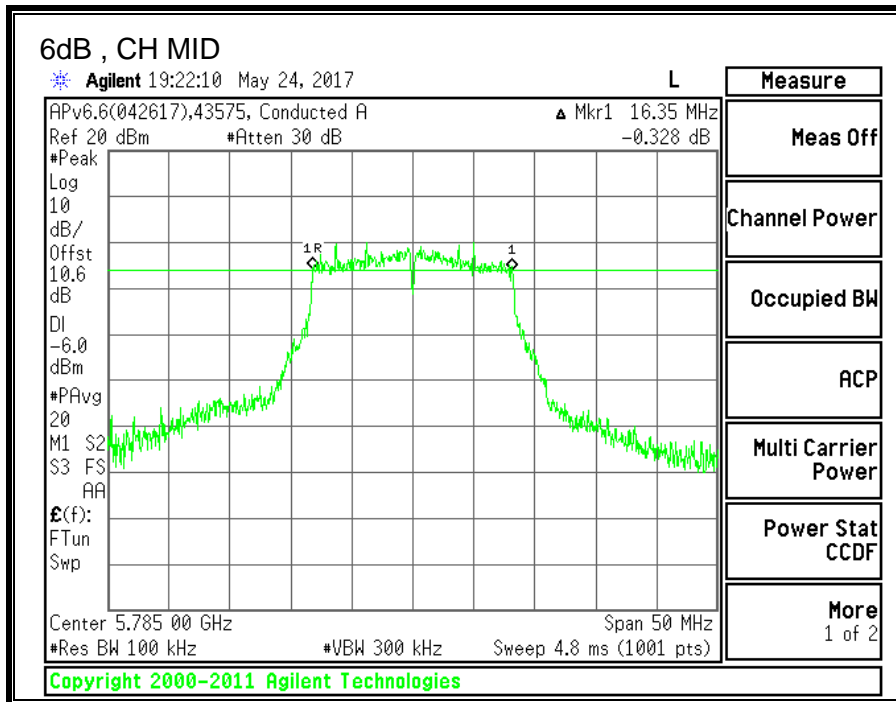
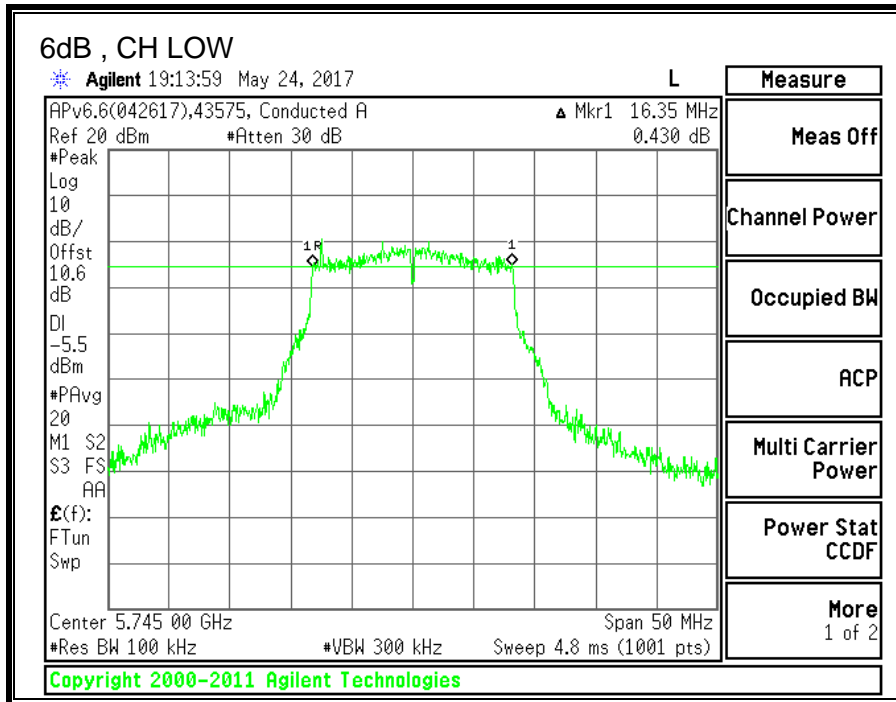

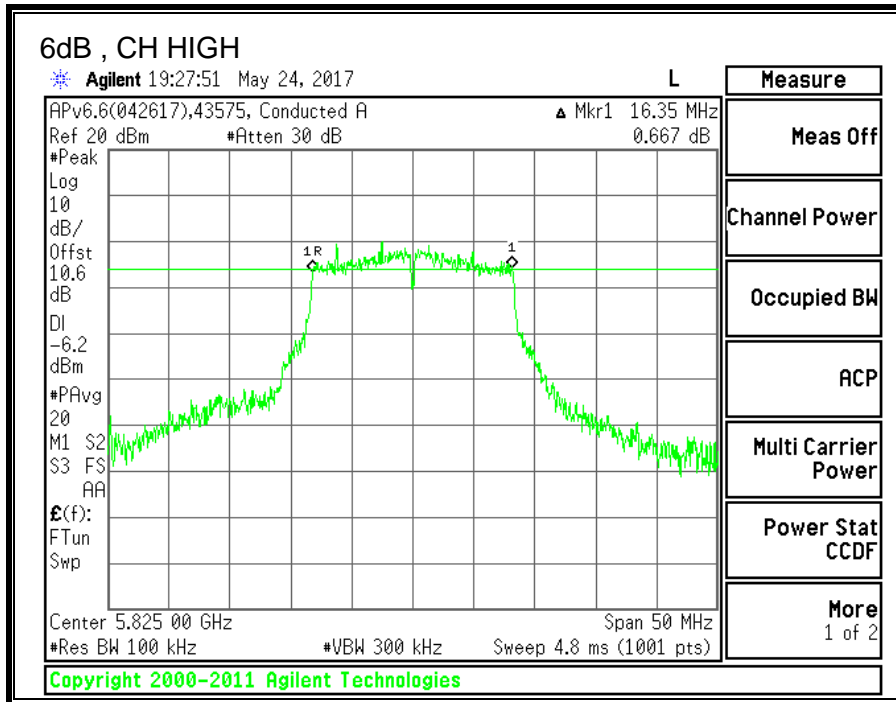

8.14.2. 26 dB BANDWIDTH

LIMITS

None; for reporting purposes only.

RESULTS

Channel	Frequency	26 dB BW (MHz)
Low	5745	22.00
Mid	5785	22.00
High	5825	22.05

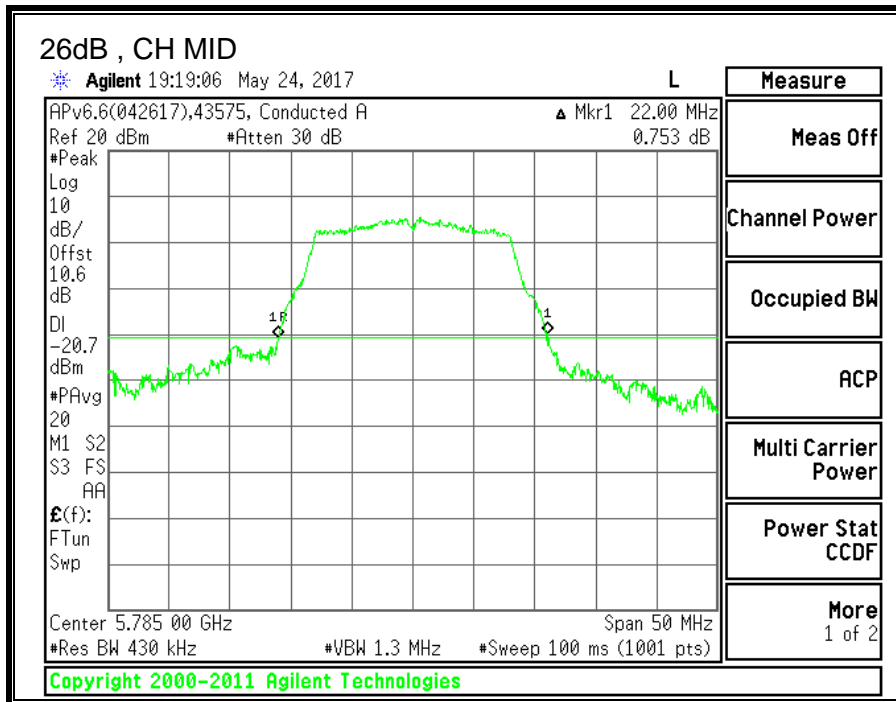
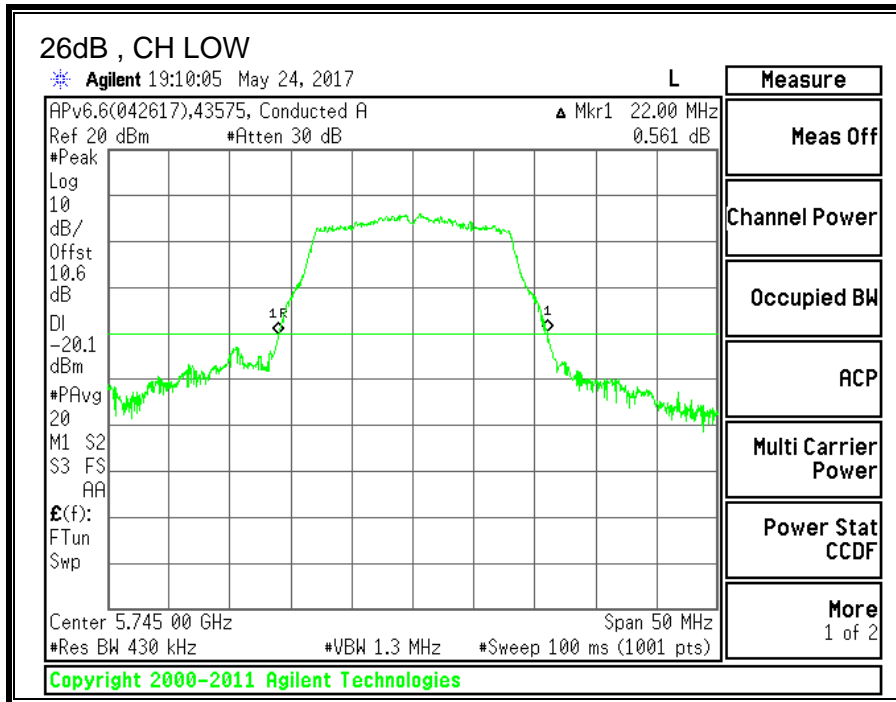

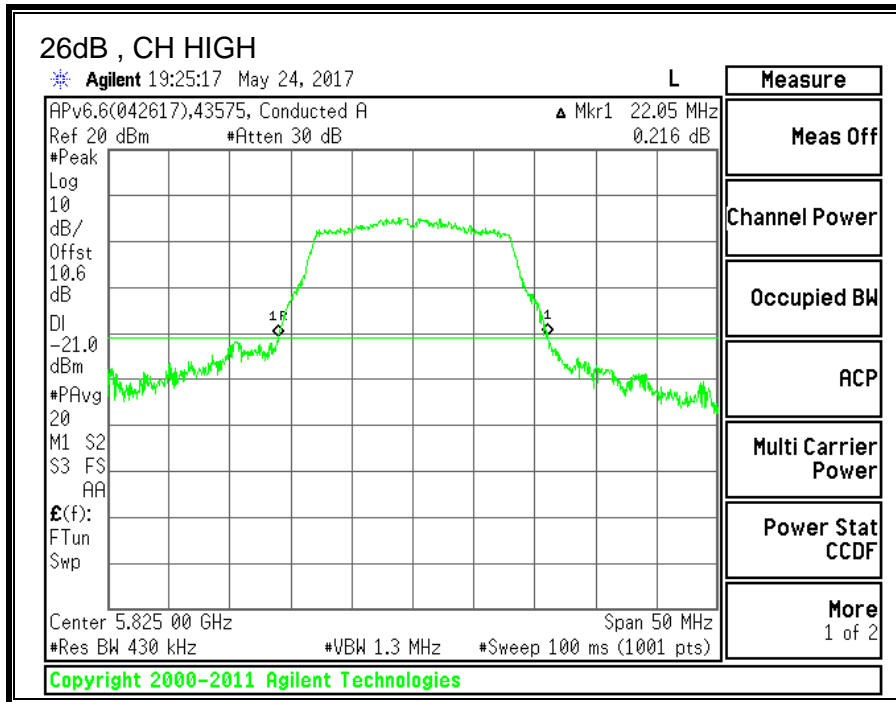

8.14.3. 99% BANDWIDTH

LIMITS

None; for reporting purposes only.

RESULTS

Channel	Frequency	99% BW (MHz)
Low	5745	16.0934
Mid	5785	16.3834
High	5825	15.8842

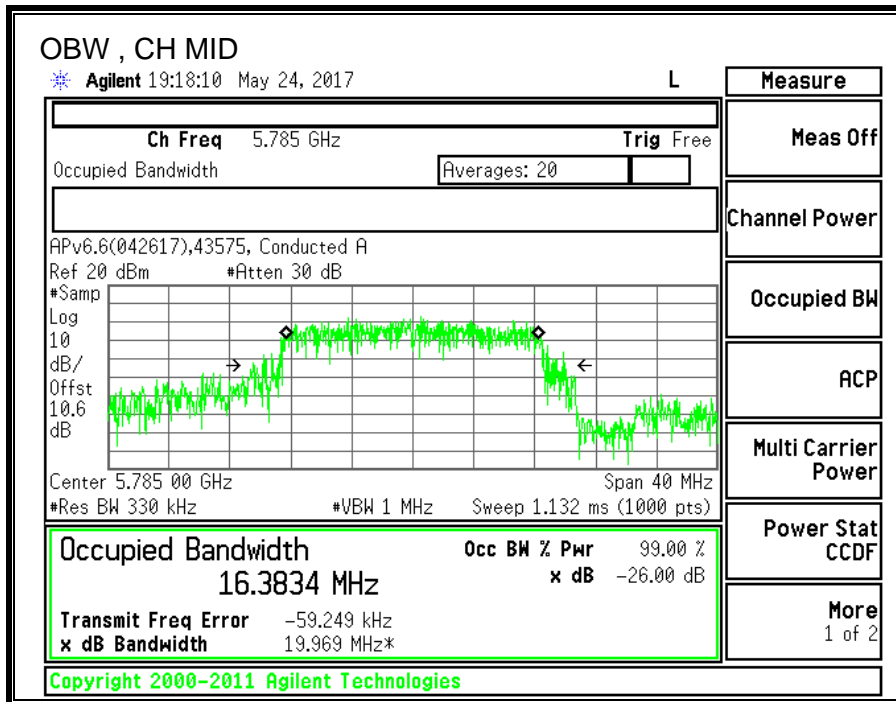
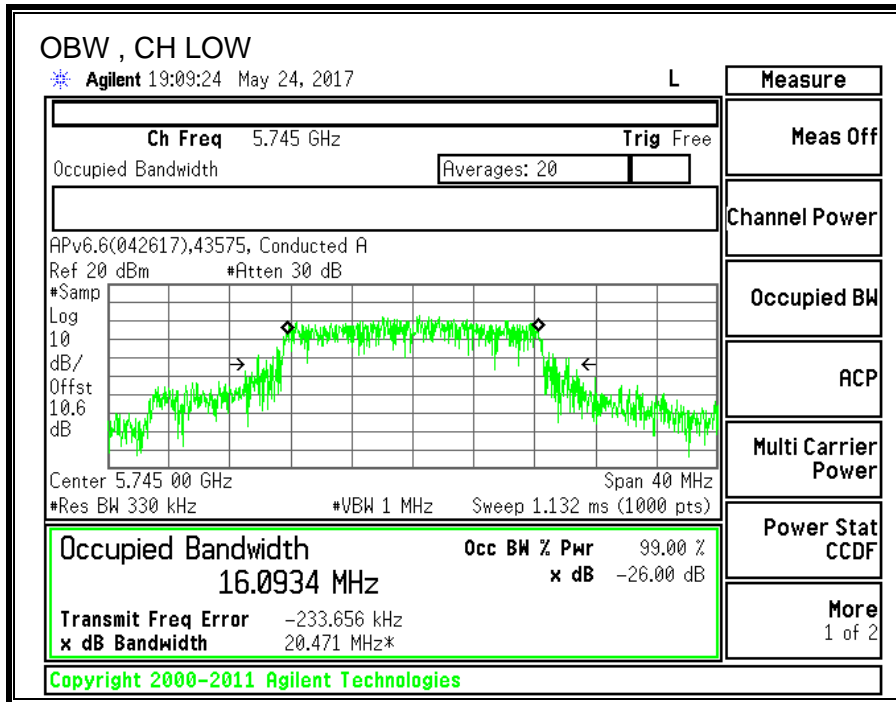

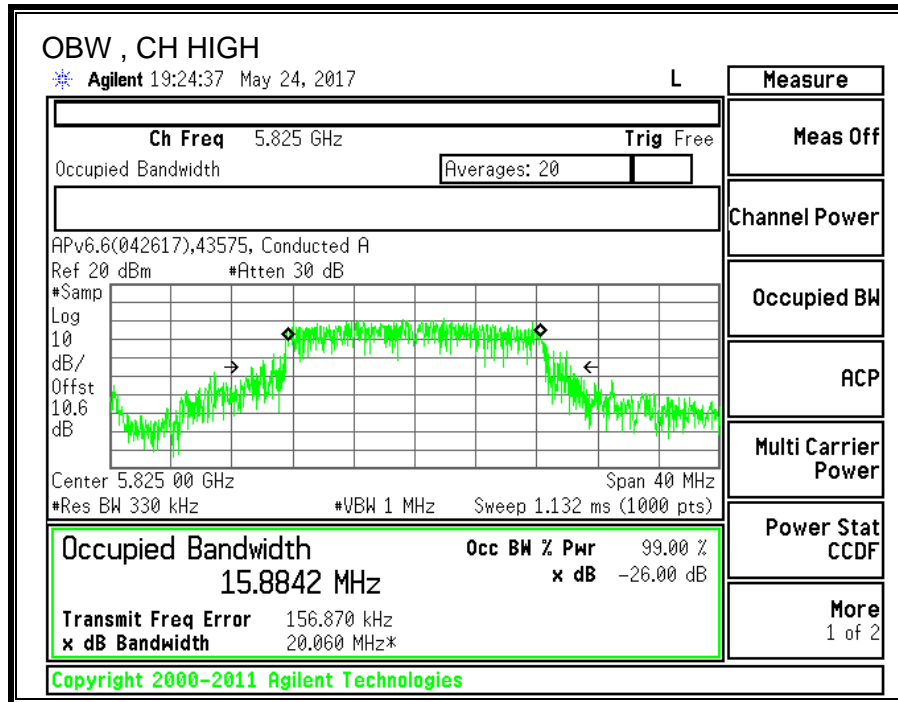

8.14.4. OUTPUT POWER AND PSD

LIMITS

FCC §15.407 (a) (3)
IC RSS-247 (6.2.4.1)

For the band 5.725-5.85 GHz, the maximum conducted output power over the frequency band of operation shall not exceed 1 W. In addition, the maximum power spectral density shall not exceed 30 dBm in any 500-kHz band. If transmitting antennas of directional gain greater than 6 dBi are used, both the maximum conducted output power and the maximum power spectral density shall be reduced by the amount in dB that the directional gain of the antenna exceeds 6 dBi.

TEST PROCEDURE

Measurements perform using a wideband gated RF power meter provided that the gate parameters are adjusted such that the power is measured only when the EUT is transmitting at its maximum power control level. Since the measurement is made only during the ON time of the transmitter, no duty cycle correction factor is required.

DIRECTIONAL ANTENNA GAIN

There is only one transmitter output therefore the directional gain is equal to the antenna gain.

RESULTS

ID:	43574	Date:	5/24/2017
------------	-------	--------------	-----------

Antenna Gain and Limit

Channel	Frequency (MHz)	Directional Gain for Power (dBi)	Directional Gain for PSD (dBi)	Power Limit (dBm)	Power Limit (dBm)
Low	5745	2.80	2.80	30.00	30.00
Mid	5785	2.80	2.80	30.00	30.00
High	5825	2.80	2.80	30.00	30.00

Duty Cycle CF (dB)	0.29	Included in Calculations of Corr'd PSD
---------------------------	------	---

Output Power Results

Channel	Frequency (MHz)	Meas Power (dBm)	Total Corr'd Power (dBm)	Power Limit (dBm)	Power Margin (dB)
Low	5745	11.93	11.93	30.00	-18.07
Mid	5785	11.50	11.50	30.00	-18.50
High	5825	11.32	11.32	30.00	-18.68

PSD Results

Channel	Frequency (MHz)	Meas PSD (dBm)	Total Corr'd PSD (dBm)	PSD Limit (dBm)	PSD Margin (dB)
Low	5745	-0.371	-0.08	30.00	-30.08
Mid	5785	-0.920	-0.63	30.00	-30.63
High	5825	-1.003	-0.71	30.00	-30.71

Note: the power readings above were measured with gated method, and the measurement was taken only during the ON time. No duty cycle correction was necessary.

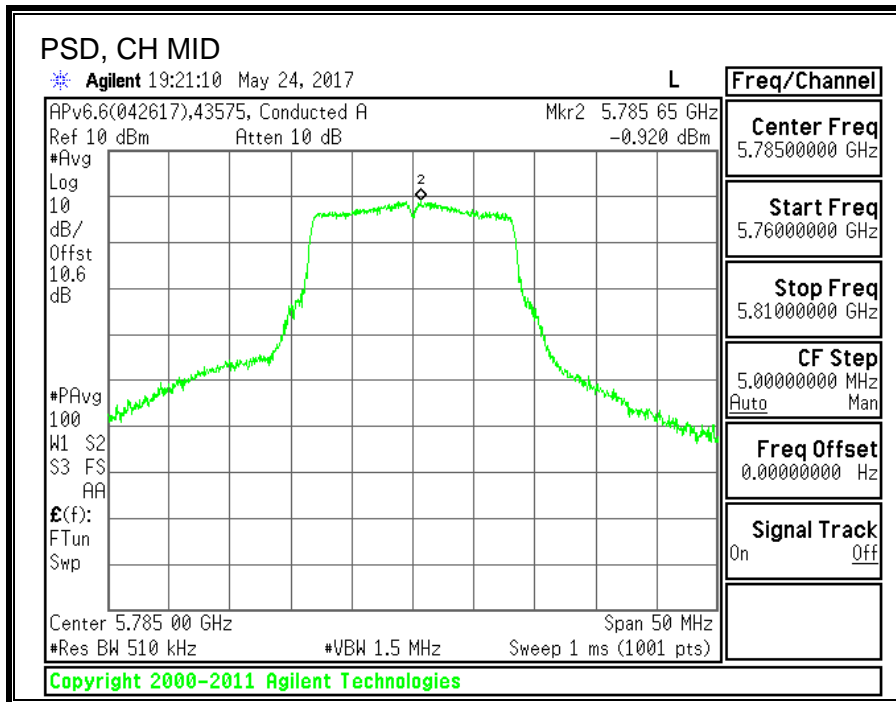
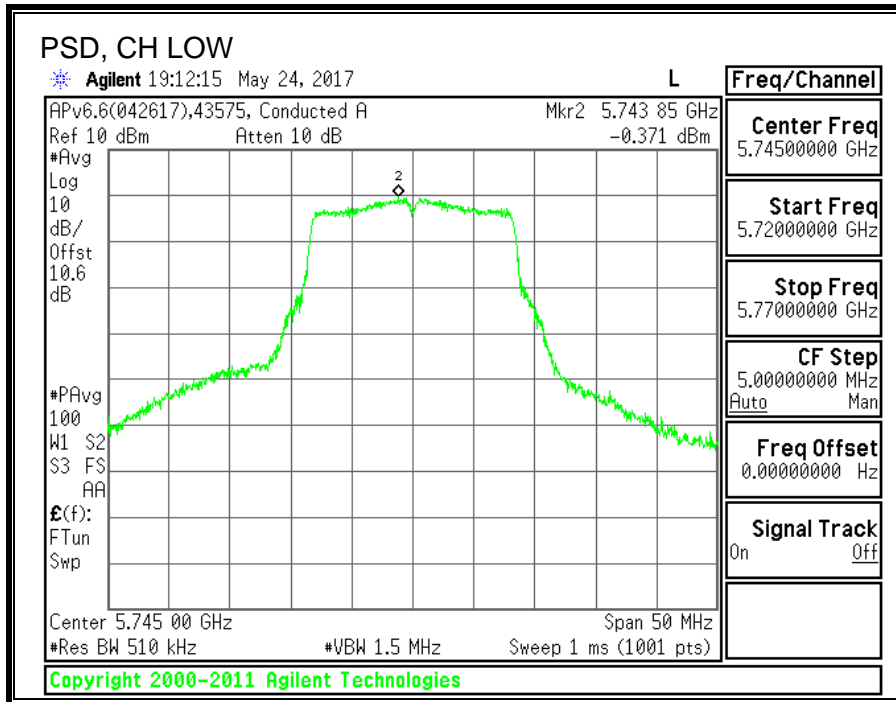

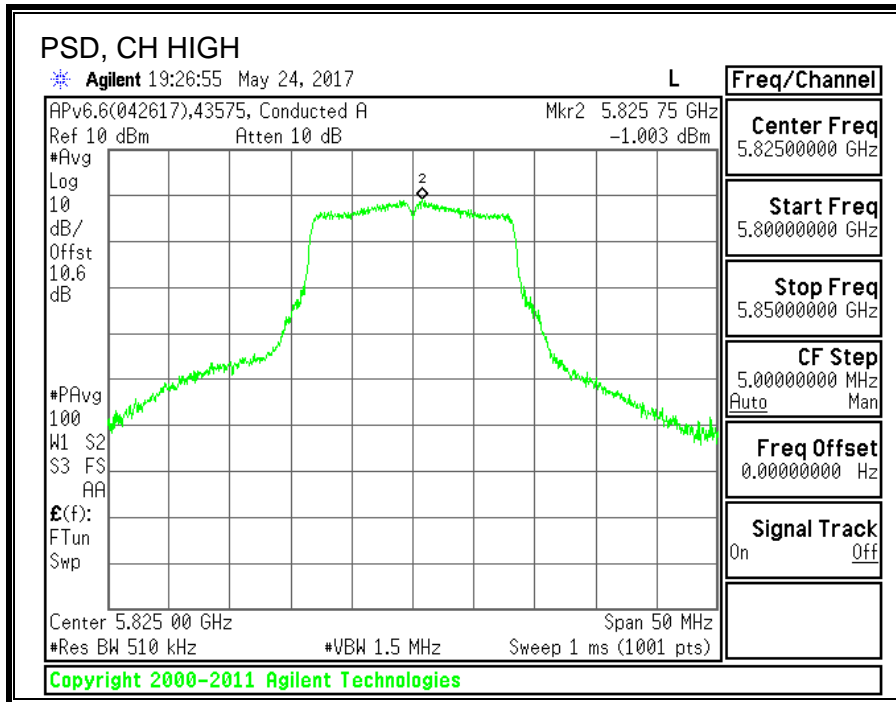

8.15. 11n HT20 MODE IN THE 5.8GHz BAND

8.15.1. 6 dB BANDWIDTH

LIMITS

FCC §15.407 (e)
IC RSS-247 (6.2.4.1)

The minimum 6 dB bandwidth shall be at least 500 kHz.

RESULTS

Channel	Frequency	6 dB BW (MHz)	Minimum Limit (MHz)
Low	5745	17.55	0.5
Mid	5785	16.95	0.5
High	5825	17.35	0.5

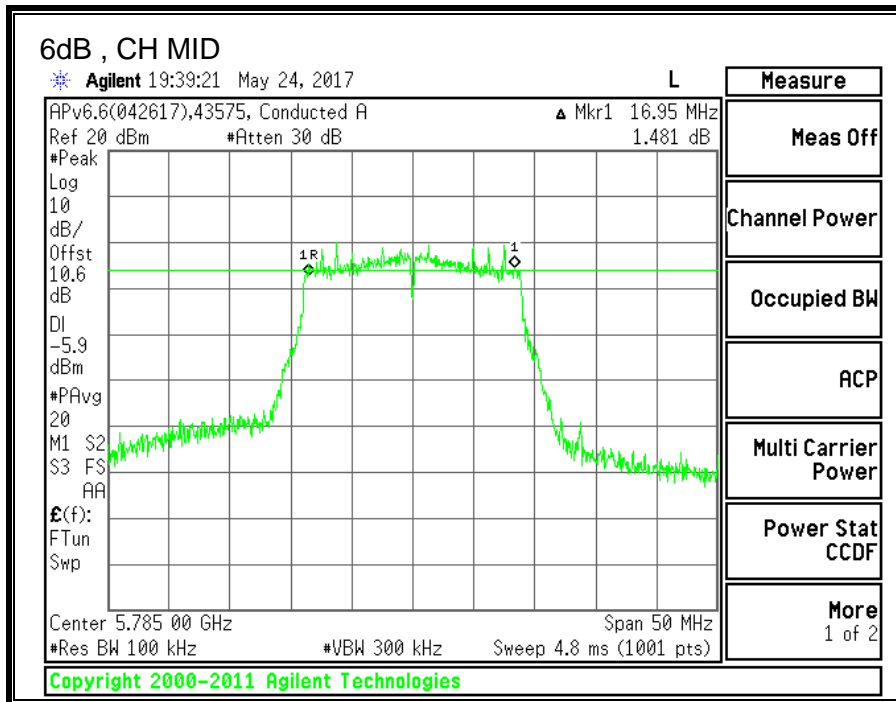
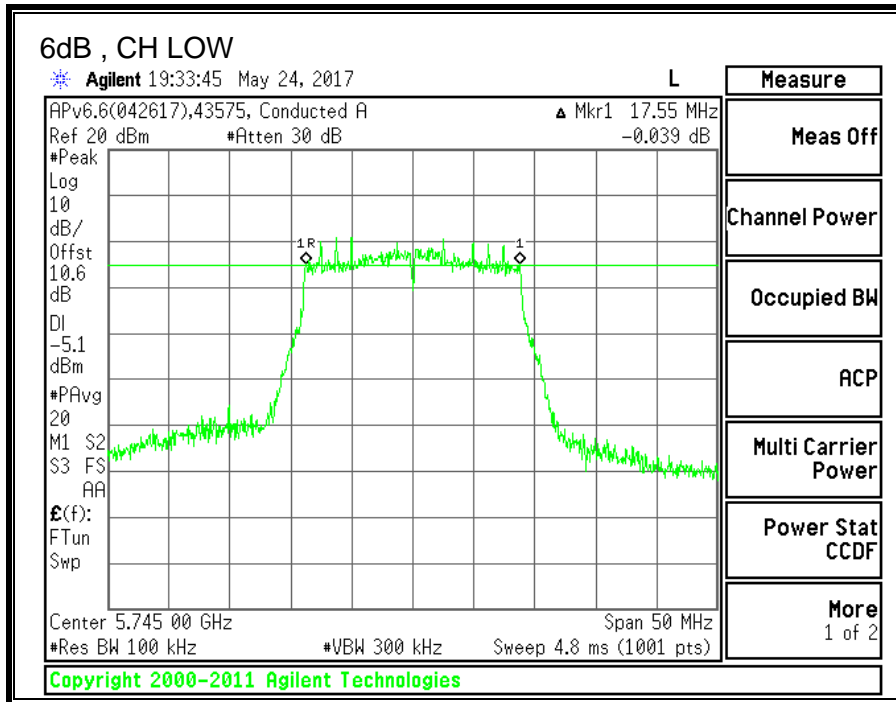

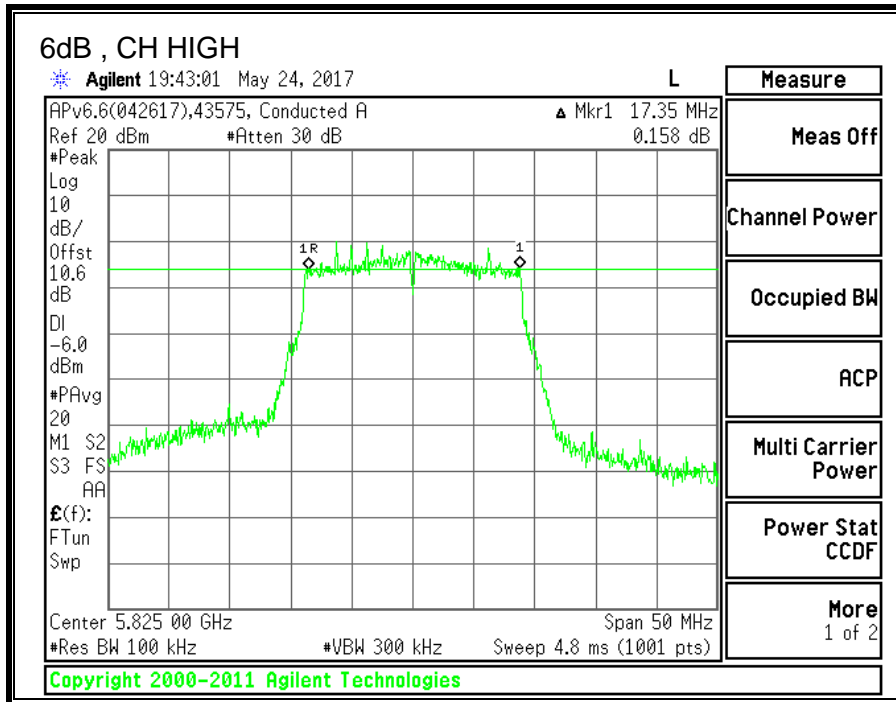

8.15.2. 26 dB BANDWIDTH

LIMITS

None; for reporting purposes only.

RESULTS

Channel	Frequency	26 dB BW (MHz)
Low	5745	22.00
Mid	5785	22.00
High	5825	22.10

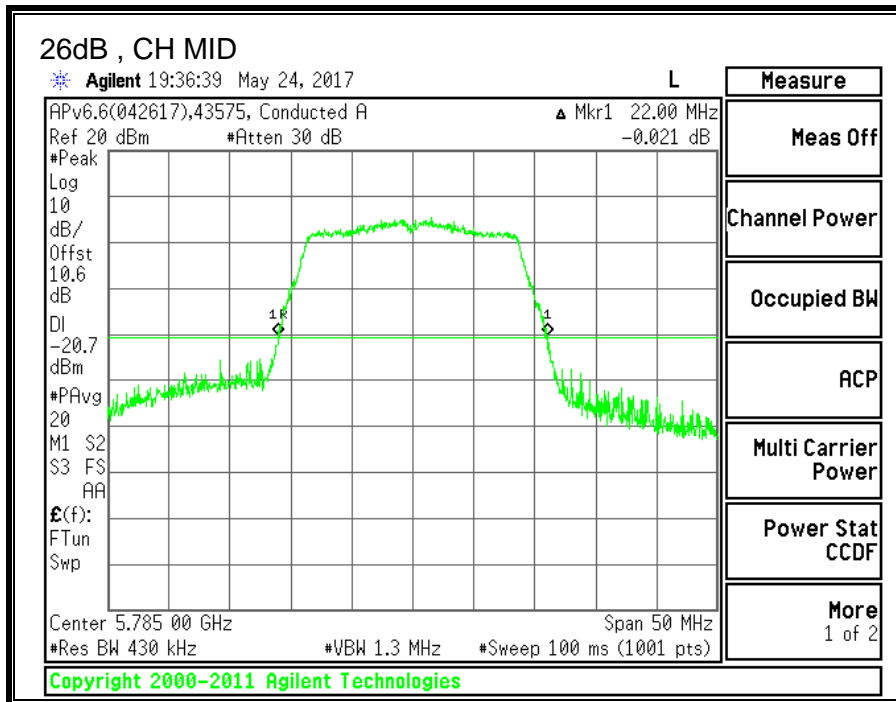
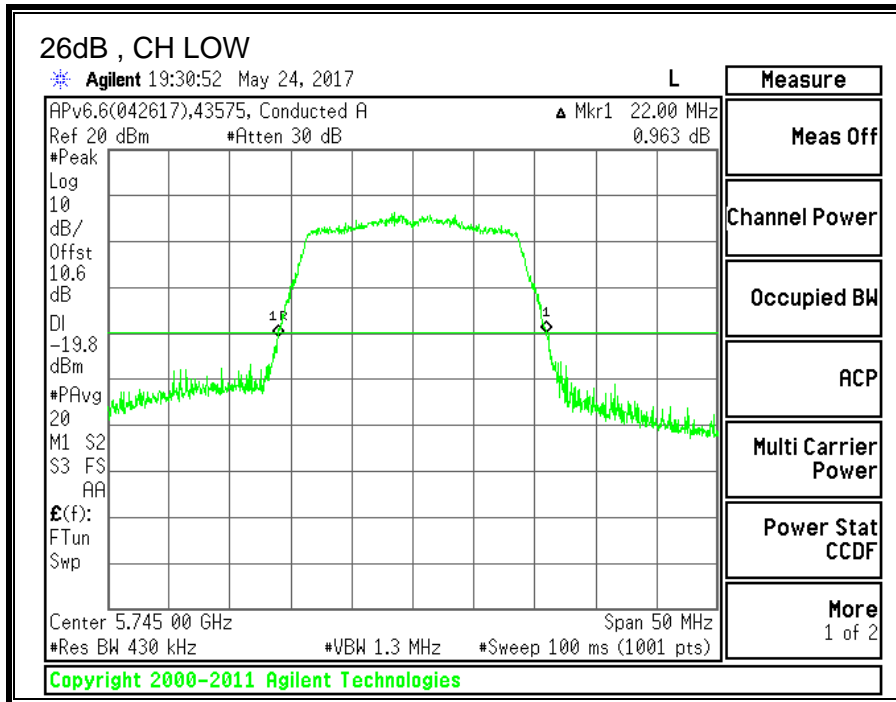

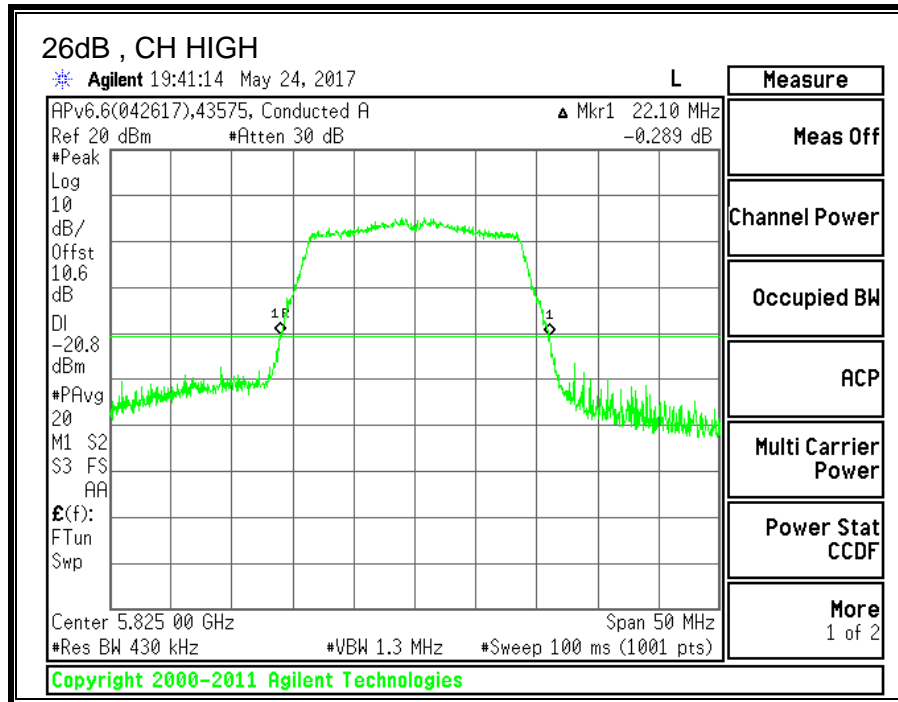

8.15.3. 99% BANDWIDTH

LIMITS

None; for reporting purposes only.

RESULTS

Channel	Frequency	99% BW (MHz)
Low	5745	16.9033
Mid	5785	17.6975
High	5825	17.2921

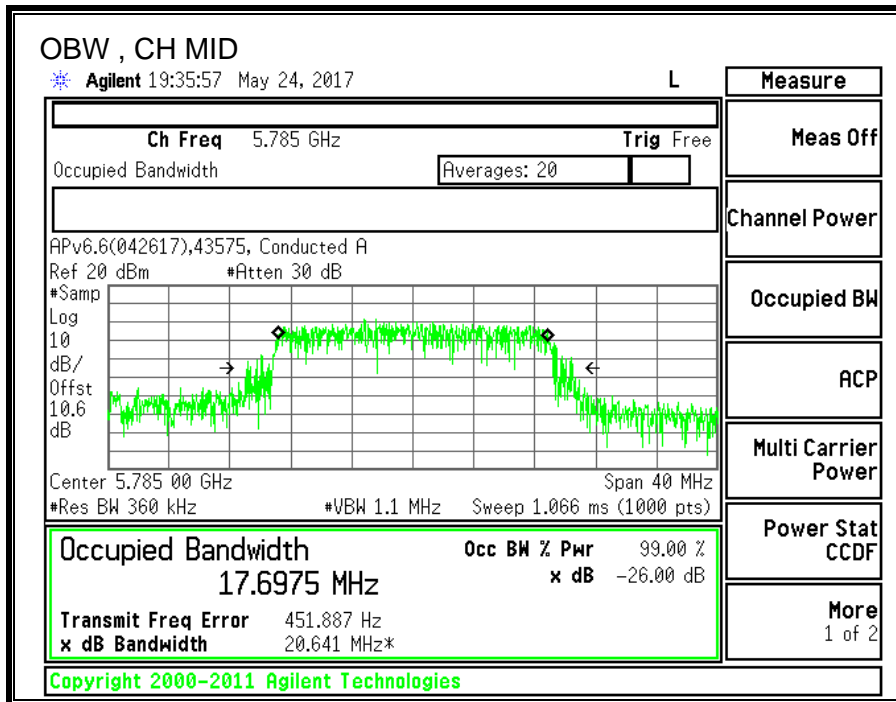
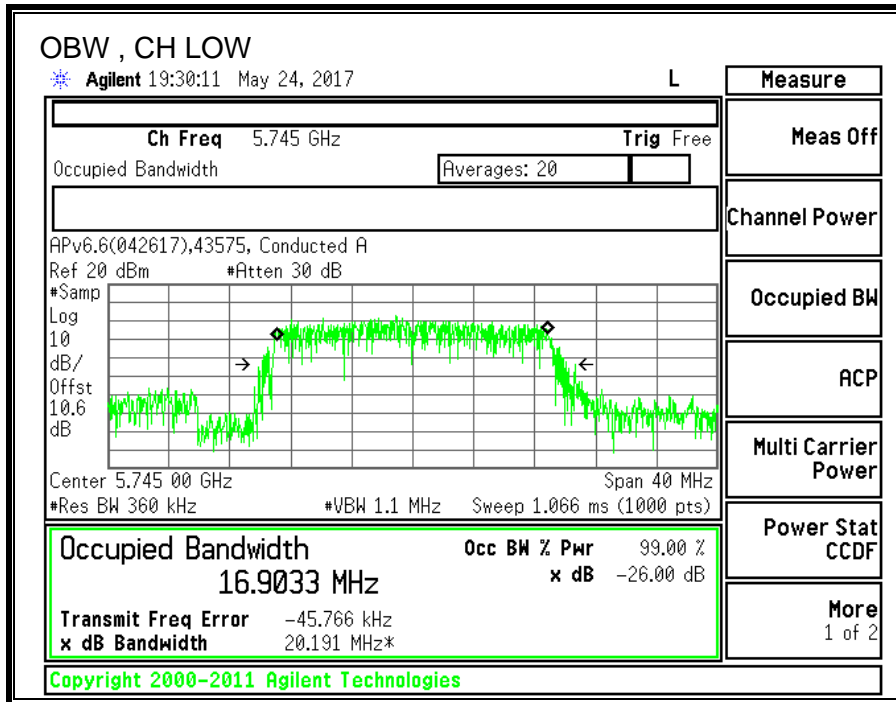

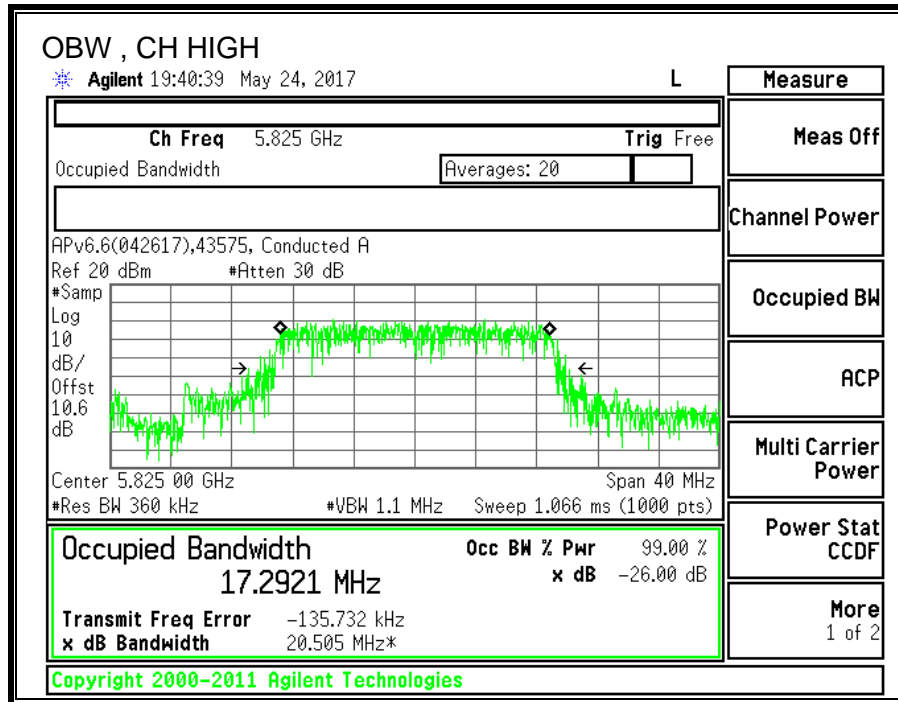

8.15.4. OUTPUT POWER AND PSD

LIMITS

FCC §15.407 (a) (3)
IC RSS-247 (6.2.4.1)

For the band 5.725-5.85 GHz, the maximum conducted output power over the frequency band of operation shall not exceed 1 W. In addition, the maximum power spectral density shall not exceed 30 dBm in any 500-kHz band. If transmitting antennas of directional gain greater than 6 dBi are used, both the maximum conducted output power and the maximum power spectral density shall be reduced by the amount in dB that the directional gain of the antenna exceeds 6 dBi.

TEST PROCEDURE

Measurements perform using a wideband gated RF power meter provided that the gate parameters are adjusted such that the power is measured only when the EUT is transmitting at its maximum power control level. Since the measurement is made only during the ON time of the transmitter, no duty cycle correction factor is required.

DIRECTIONAL ANTENNA GAIN

There is only one transmitter output therefore the directional gain is equal to the antenna gain.

RESULTS

ID:	43574	Date:	5/24/2017
------------	-------	--------------	-----------

Antenna Gain and Limit

Channel	Frequency (MHz)	Directional Gain for Power (dBi)	Directional Gain for PSD (dBi)	Power Limit (dBm)	Power Limit (dBm)
Low	5745	2.80	2.80	30.00	30.00
Mid	5785	2.80	2.80	30.00	30.00
High	5825	2.80	2.80	30.00	30.00

Duty Cycle CF (dB)	0.31	Included in Calculations of Corr'd PSD
---------------------------	------	---

Output Power Results

Channel	Frequency (MHz)	Meas Power (dBm)	Total Corr'd Power (dBm)	Power Limit (dBm)	Power Margin (dB)
Low	5745	11.52	11.52	30.00	-18.48
Mid	5785	11.23	11.23	30.00	-18.77
High	5825	10.75	10.75	30.00	-19.25

PSD Results

Channel	Frequency (MHz)	Meas PSD (dBm)	Total Corr'd PSD (dBm)	PSD Limit (dBm)	PSD Margin (dB)
Low	5745	-0.933	-0.62	30.00	-30.62
Mid	5785	-1.621	-1.31	30.00	-31.31
High	5825	-1.448	-1.14	30.00	-31.14

Note: the power readings above were measured with gated method, and the measurement was taken only during the ON time. No duty cycle correction was necessary.

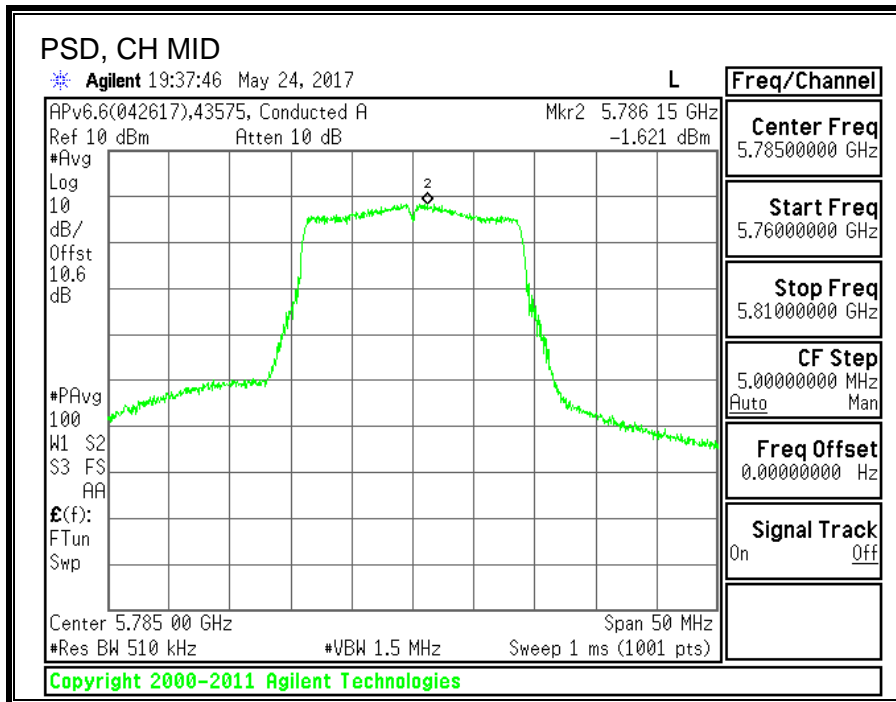
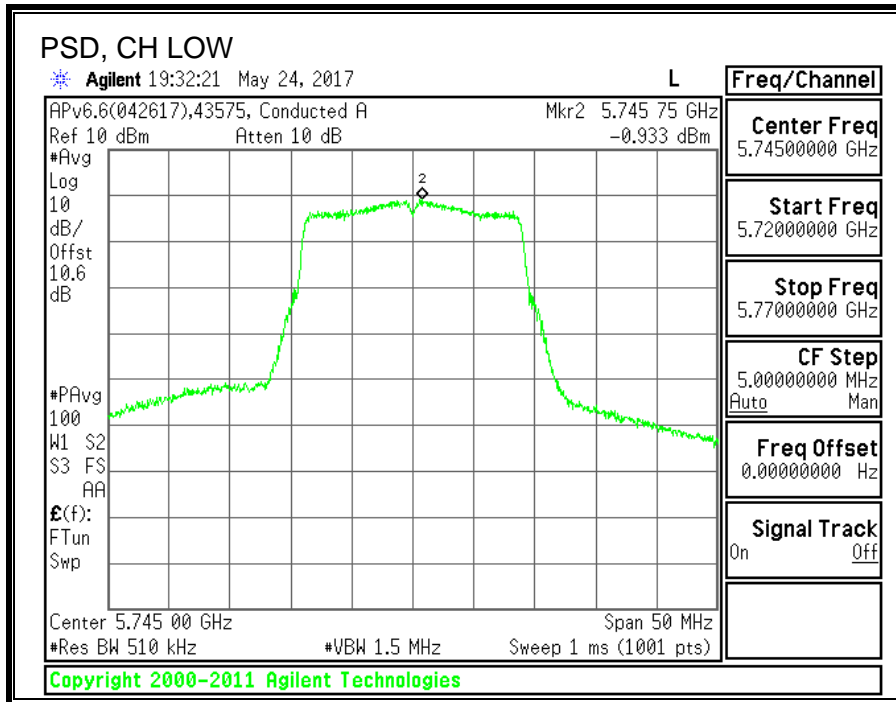

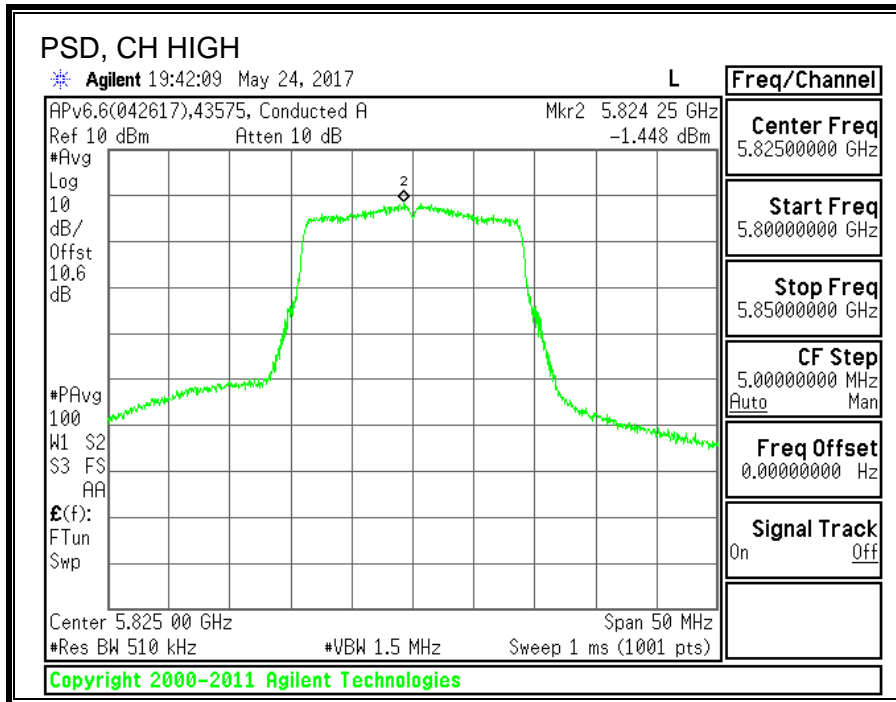

8.16. 11n HT40 MODE IN THE 5.8GHz BAND

8.16.1. 6 dB BANDWIDTH

LIMITS

FCC §15.407 (e)
IC RSS-247 (6.2.4.1)

The minimum 6 dB bandwidth shall be at least 500 kHz.

RESULTS

Channel	Frequency	6 dB BW (MHz)	Minimum Limit (MHz)
Low	5755	35.4	0.5
High	5795	36.0	0.5

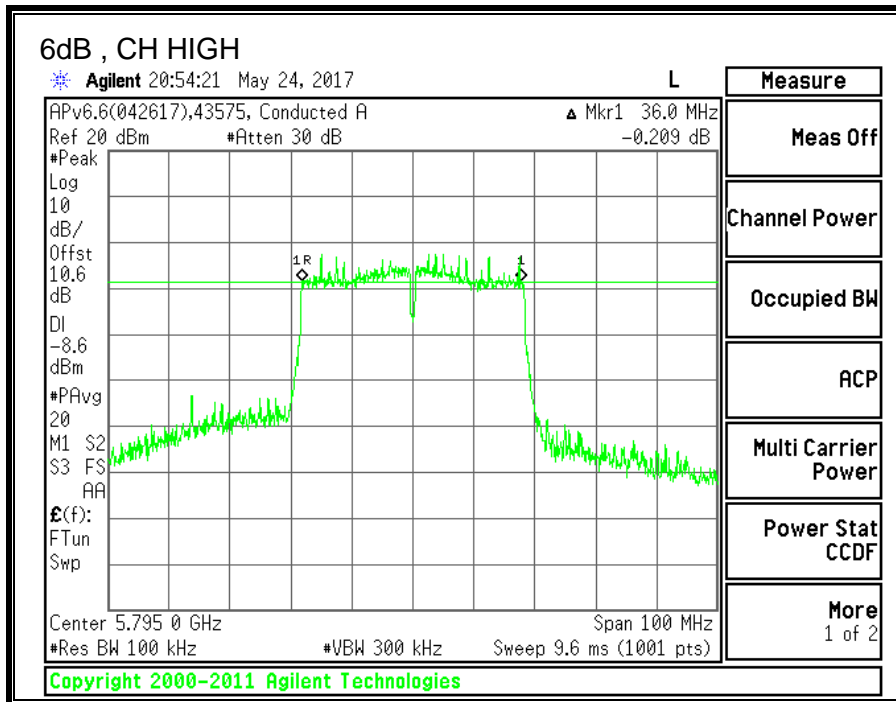
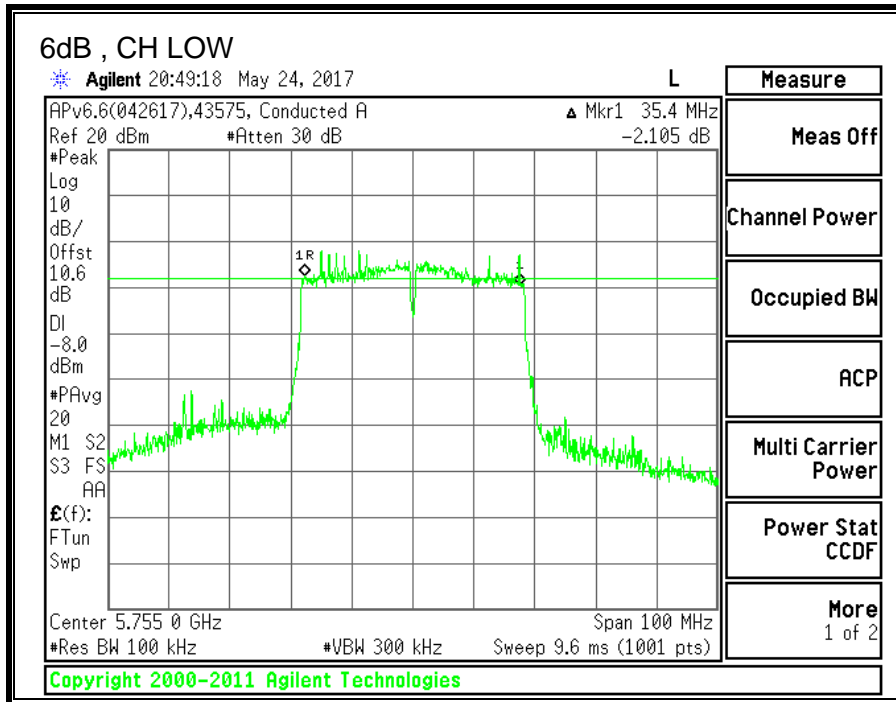

8.16.2. 26 dB BANDWIDTH

LIMITS

None; for reporting purposes only.

RESULTS

Channel	Frequency	26 dB BW (MHz)
Low	5755	40.6
High	5795	40.5

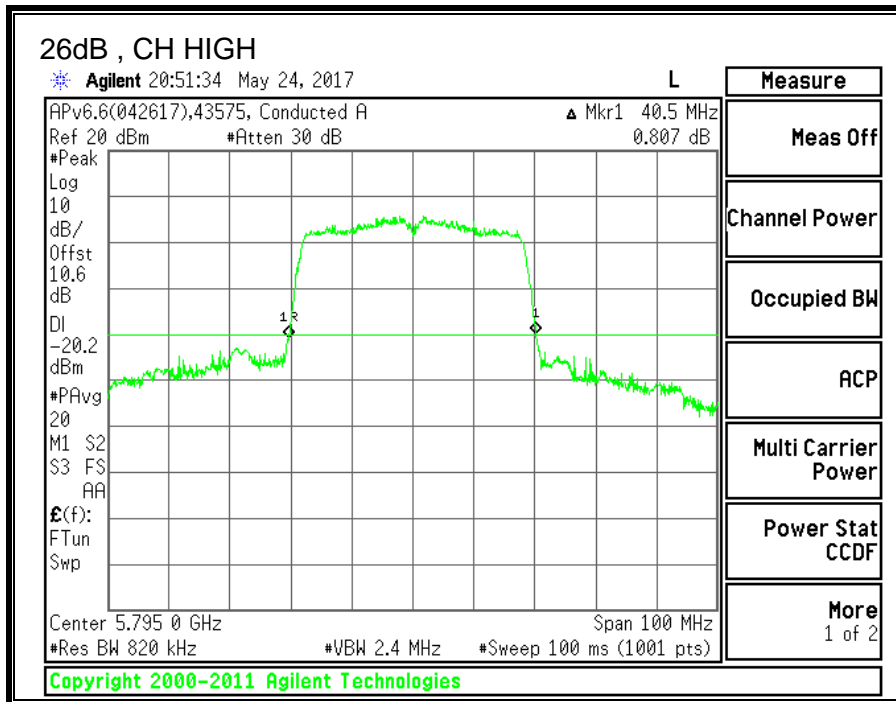
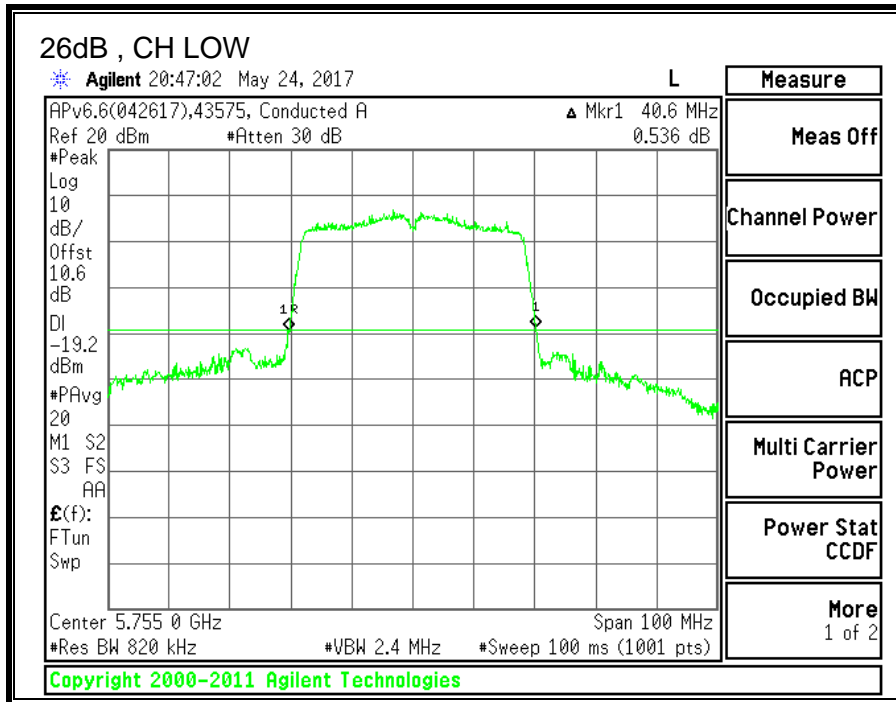

8.16.3. 99% BANDWIDTH

LIMITS

None; for reporting purposes only.

RESULTS

Channel	Frequency	99% BW (MHz)
Low	5755	35.8174
High	5795	35.0889

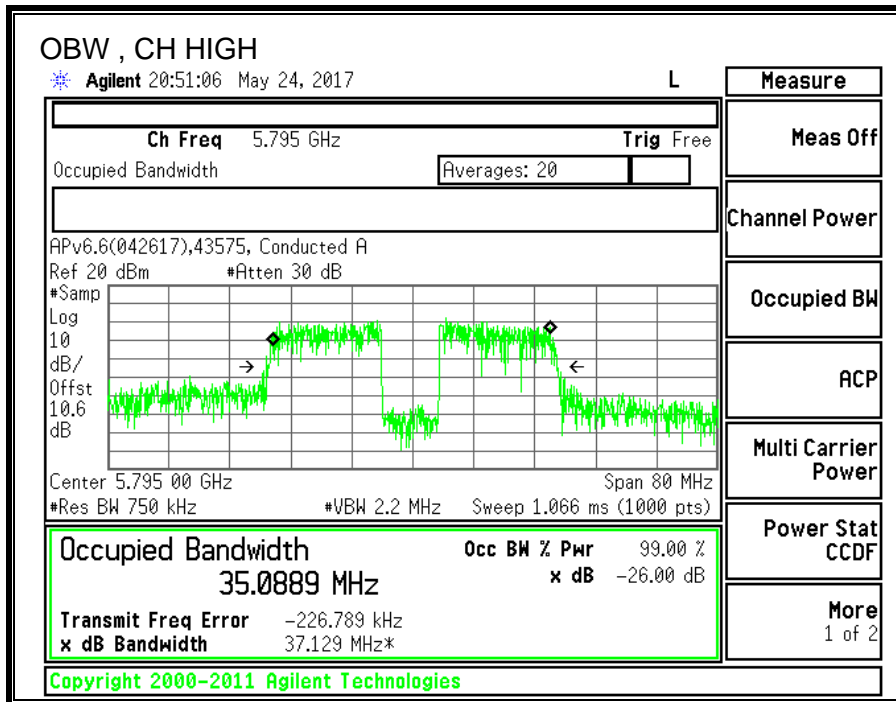
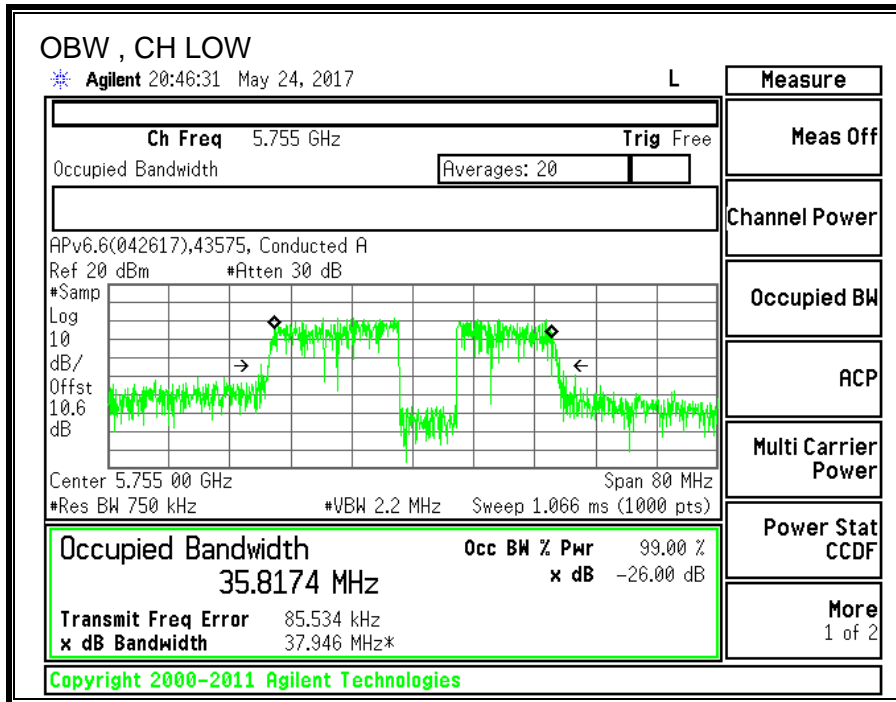

8.16.4. OUTPUT POWER AND PSD

LIMITS

FCC §15.407 (a) (3)

IC RSS-247 (6.2.4.1)

For the band 5.725-5.85 GHz, the maximum conducted output power over the frequency band of operation shall not exceed 1 W. In addition, the maximum power spectral density shall not exceed 30 dBm in any 500-kHz band. If transmitting antennas of directional gain greater than 6 dBi are used, both the maximum conducted output power and the maximum power spectral density shall be reduced by the amount in dB that the directional gain of the antenna exceeds 6 dBi.

TEST PROCEDURE

Measurements perform using a wideband gated RF power meter provided that the gate parameters are adjusted such that the power is measured only when the EUT is transmitting at its maximum power control level. Since the measurement is made only during the ON time of the transmitter, no duty cycle correction factor is required.

DIRECTIONAL ANTENNA GAIN

There is only one transmitter output therefore the directional gain is equal to the antenna gain.

RESULTS

ID:	43574	Date:	5/24/2017
------------	-------	--------------	-----------

Antenna Gain and Limit

Channel	Frequency (MHz)	Directional Gain For Power (dBi)	Directional Gain For PSD (dBi)	Power Limit (dBm)	Power Limit (dBm)
Low	5755	2.80	2.80	30.00	30.00
High	5795	2.80	2.80	30.00	30.00

Duty Cycle CF (dB)	0.42	Included in Calculations of Corr'd PSD
---------------------------	------	---

Output Power Results

Channel	Frequency (MHz)	Meas Power (dBm)	Total Corr'd Power (dBm)	Power Limit (dBm)	Power Margin (dB)
Low	5755	11.55	11.55	30.00	-18.45
High	5795	11.31	11.31	30.00	-18.69

Output Power Results

Channel	Frequency (MHz)	Meas PSD (dBm)	Total Corr'd PSD (dBm)	PSD Limit (dBm)	PSD Margin (dB)
Low	5755	-4.213	-3.79	30.00	-33.79
High	5795	-5.147	-4.73	30.00	-34.73

Note: the power readings above were measured with gated method, and the measurement was taken only during the ON time. No duty cycle correction was necessary.

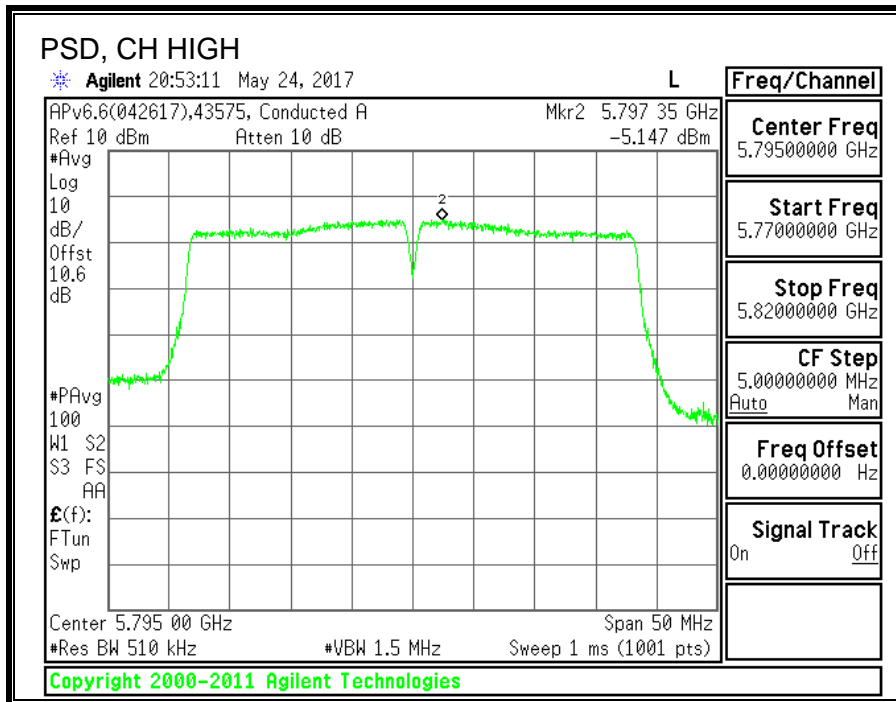
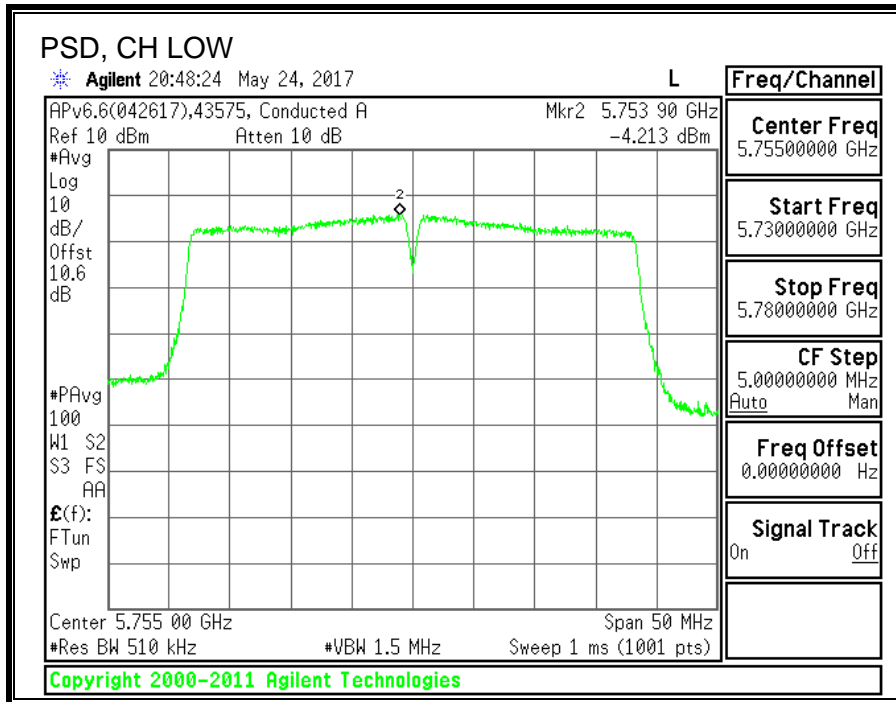

8.17. 11ac VHT80 MODE IN THE 5.8GHz BAND

8.17.1. 6 dB BANDWIDTH

LIMITS

FCC §15.407 (e)
IC RSS-247 (6.2.4.1)

The minimum 6 dB bandwidth shall be at least 500 kHz.

RESULTS

Channel	Frequency	6 dB BW (MHz)	Minimum Limit (MHz)
Mid	5775	75.131	0.5

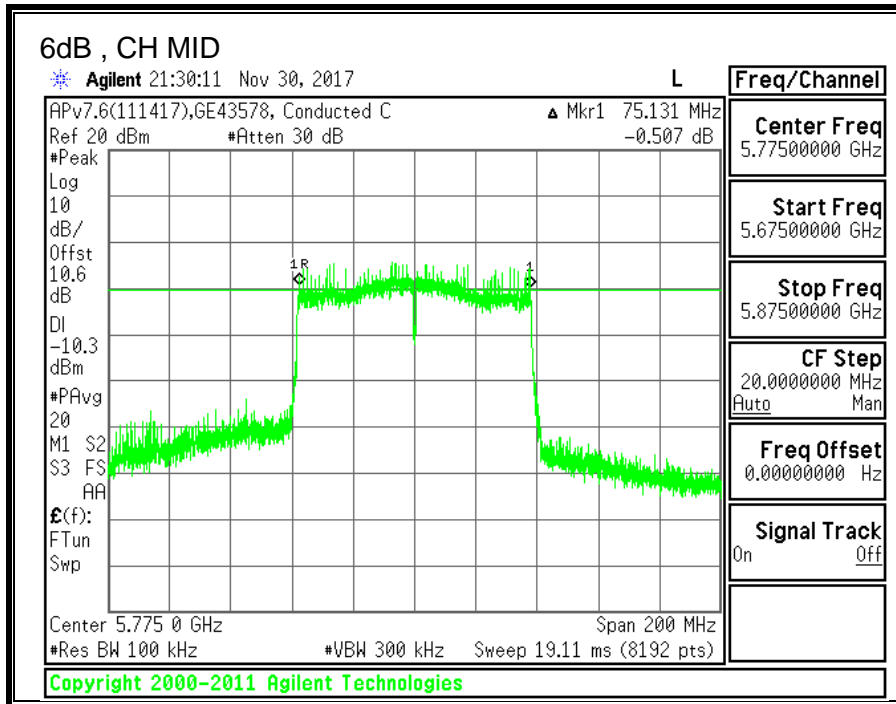

8.17.2. 26 dB BANDWIDTH

LIMITS

None; for reporting purposes only.

RESULTS

Channel	Frequency	26 dB BW (MHz)
Mid	5775	82.6

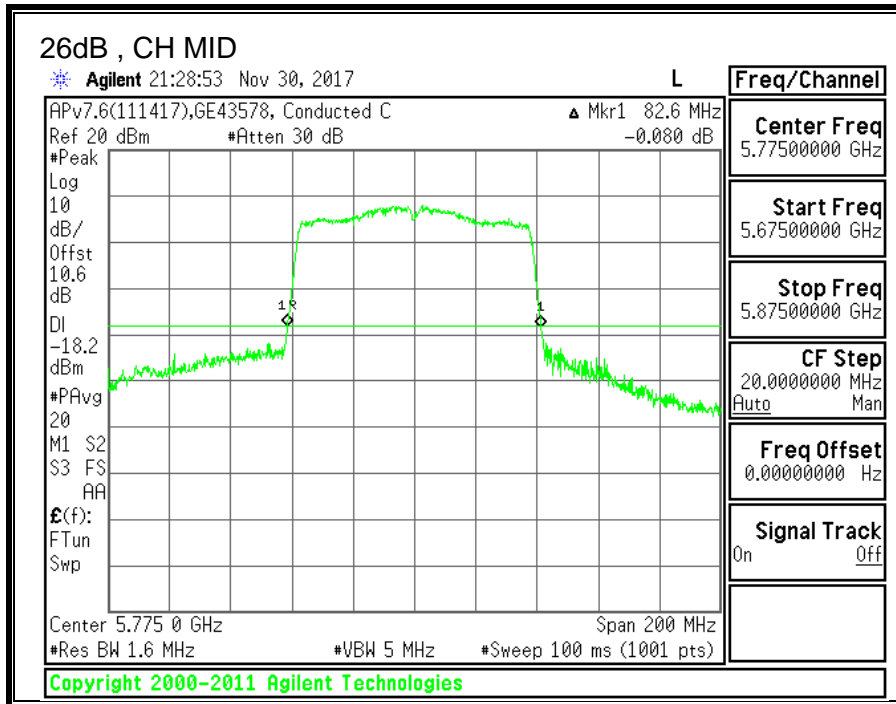

8.17.3. 99% BANDWIDTH

LIMITS

None; for reporting purposes only.

RESULTS

Channel	Frequency	99% BW (MHz)
Mid	5775	75.6245

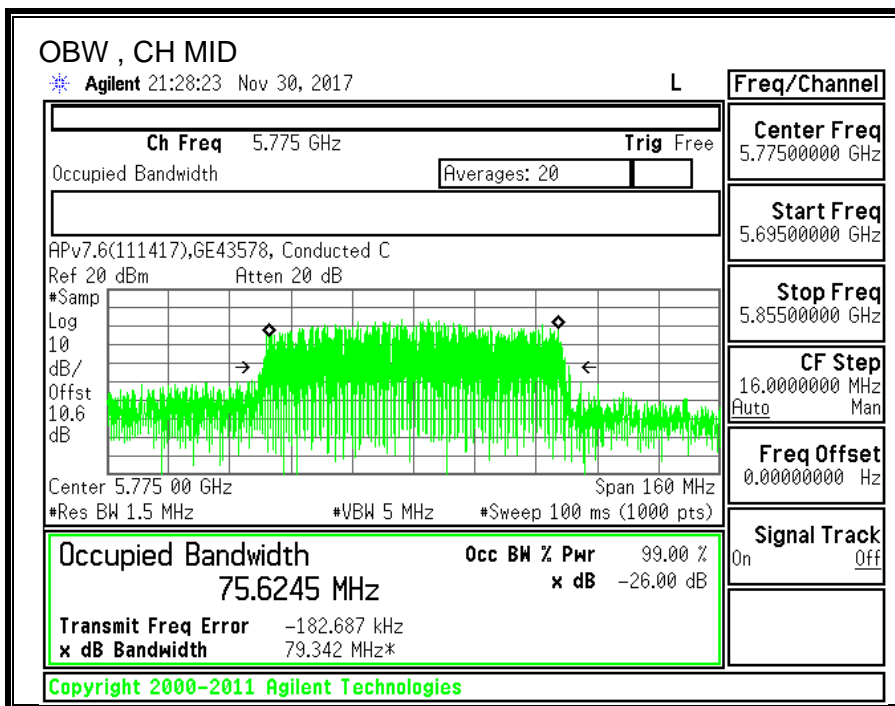

8.17.4. OUTPUT POWER AND PSD

LIMITS

FCC §15.407 (a) (3)

IC RSS-247 (6.2.4.1)

For the band 5.725-5.85 GHz, the maximum conducted output power over the frequency band of operation shall not exceed 1 W. In addition, the maximum power spectral density shall not exceed 30 dBm in any 500-kHz band. If transmitting antennas of directional gain greater than 6 dBi are used, both the maximum conducted output power and the maximum power spectral density shall be reduced by the amount in dB that the directional gain of the antenna exceeds 6 dBi.

TEST PROCEDURE

Measurements perform using a wideband gated RF power meter provided that the gate parameters are adjusted such that the power is measured only when the EUT is transmitting at its maximum power control level. Since the measurement is made only during the ON time of the transmitter, no duty cycle correction factor is required.

DIRECTIONAL ANTENNA GAIN

There is only one transmitter output therefore the directional gain is equal to the antenna gain.

RESULTS

ID:	GE43578	Date:	11/30/2017
------------	---------	--------------	------------

Antenna Gain and Limit

Channel	Frequency (MHz)	Directional Gain For Power (dBi)	Directional Gain For PSD (dBi)	Power Limit (dBm)	Power Limit (dBm)
Mid	5775	2.80	2.80	30.00	30.00

Duty Cycle CF (dB)	1.18	Included in Calculations of Corr'd PSD
---------------------------	------	---

Output Power Results

Channel	Frequency (MHz)	Meas Power (dBm)	Total Corr'd Power (dBm)	Power Limit (dBm)	Power Margin (dB)
Mid	5775	11.23	11.23	30.00	-18.77

Output Power Results

Channel	Frequency (MHz)	Meas PSD (dBm)	Total Corr'd PSD (dBm)	PSD Limit (dBm)	PSD Margin (dB)
Mid	5775	-7.020	-5.84	30.00	-35.84

Note: the power readings above were measured with gated method, and the measurement was taken only during the ON time. No duty cycle correction was necessary.

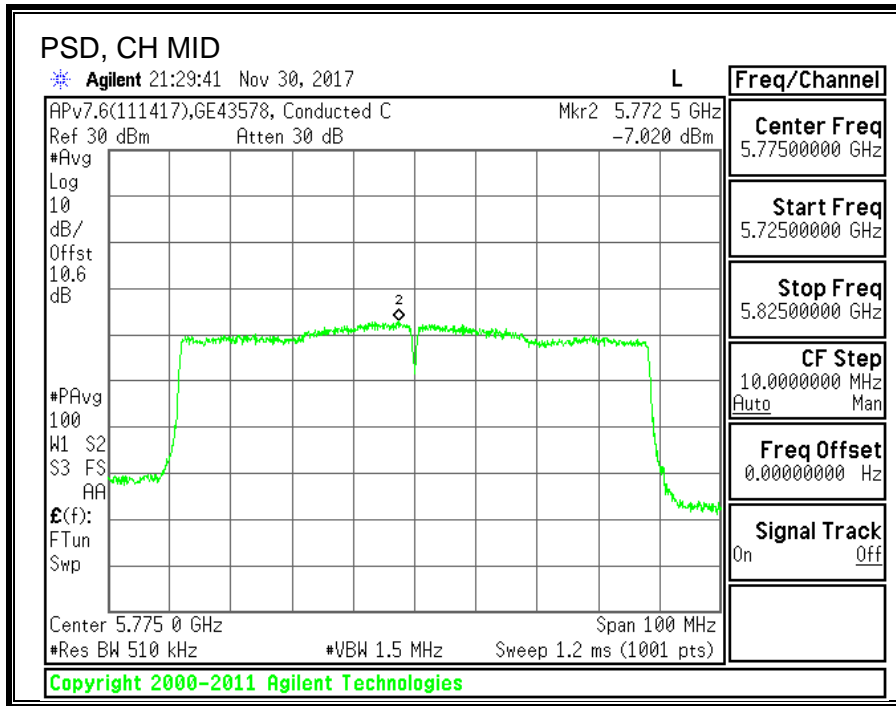

9. RADIATED TEST RESULTS

9.1. LIMITS AND PROCEDURE

LIMITS

FCC §15.205 and §15.209
IC RSS-GEN, Section 8.9 and 8.10.

Frequency Range (MHz)	Field Strength Limit (uV/m) at 3 m	Field Strength Limit (dBuV/m) at 3 m
30 - 88	100	40
88 - 216	150	43.5
216 - 960	200	46
Above 960	500	54

TEST PROCEDURE

The EUT is placed on a non-conducting table 80 cm above the ground plane for measurement below 1GHz; 1.5 m above the ground plane for measurement above 1GHz. The antenna to EUT distance is 3 meters. The EUT is configured in accordance with ANSI C63.10. The EUT is set to transmit in a continuous mode.

For measurements below 1 GHz the resolution bandwidth is set to 100 kHz for peak detection measurements or 120 kHz for quasi-peak detection measurements. Peak detection is used unless otherwise noted as quasi-peak.

For measurements above 1 GHz the resolution bandwidth is set to 1 MHz; the video bandwidth is set to 3 MHz for peak measurements and as applicable for average measurements.

The spectrum from 1 GHz to 18 GHz is investigated with the transmitter set to the lowest, middle, and highest channels in each applicable band. Below 1GHz and above 18GHz emissions, the channel with the highest output power was tested.

The frequency range of interest is monitored at a fixed antenna height and EUT azimuth. The EUT is rotated through 360 degrees to maximize emissions received. The antenna is scanned from 1 to 4 meters above the ground plane to further maximize the emission. Measurements are made with the antenna polarized in both the vertical and the horizontal positions.

Radiated emission were performed with the EUT set to transmit at the channel with highest output power as worst-case scenario.

9.1.1. 11a MODE IN THE 5.2GHz BAND

BANDEDGE (LOW CHANNEL)

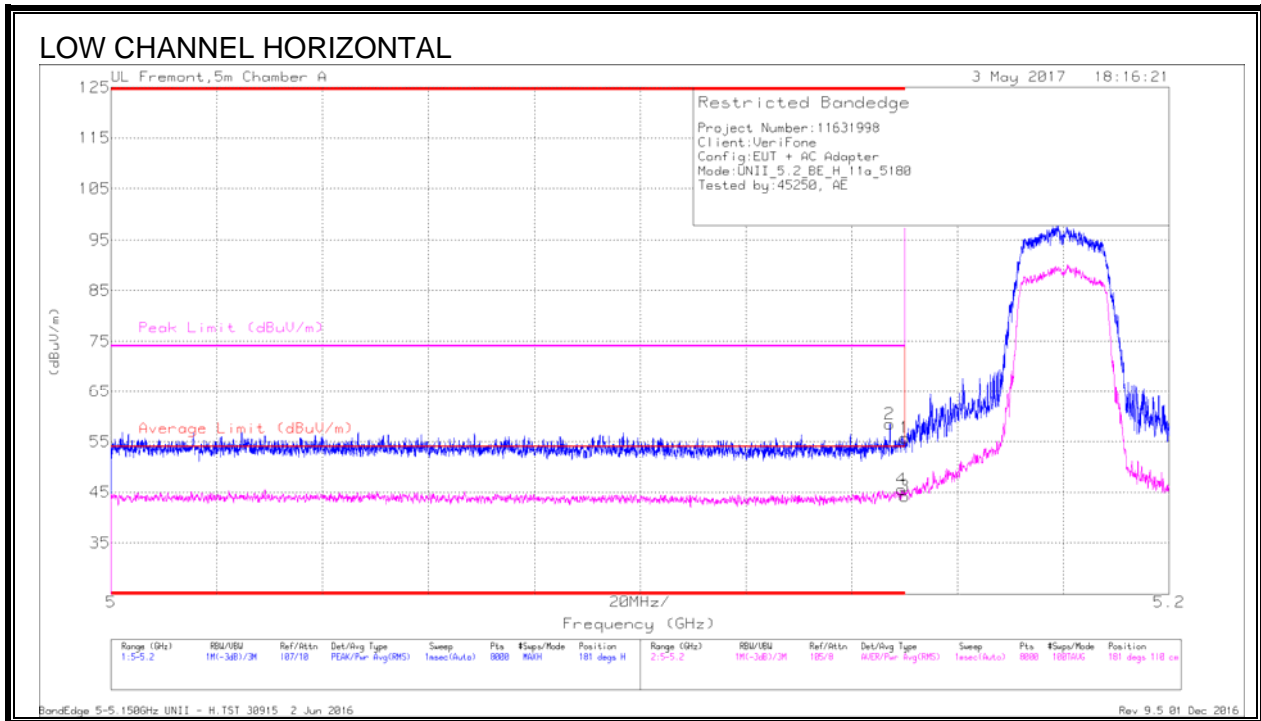

Trace Markers

Marker	Frequency (GHz)	Meter Reading (dBuV)	Det	AF T711 (dB/m)	Amp/Cb/Filtr/ Pad (dB)	DC Corr (dB)	Corrected Reading (dBuV/m)	Average Limit (dBuV/m)	Margin (dB)	Peak Limit (dBuV/m)	PK Margin (dB)	Azimuth (Degs)	Height (cm)	Polarity
1	* 5.15	40.37	Pk	34.1	-18.7	0	55.77	-	-	74	-18.23	181	110	H
2	* 5.147	42.97	Pk	34.1	-18.6	0	58.47	-	-	74	-15.53	181	110	H
3	* 5.15	28.49	RMS	34.1	-18.7	.29	44.18	54	-9.82	-	-	181	110	H
4	* 5.149	29.78	RMS	34.1	-18.6	.29	45.57	54	-8.43	-	-	181	110	H

* - indicates frequency in CFR47 Pt 15 / IC RSS-Restricted Band

Pk - Peak detector

RMS - RMS detection

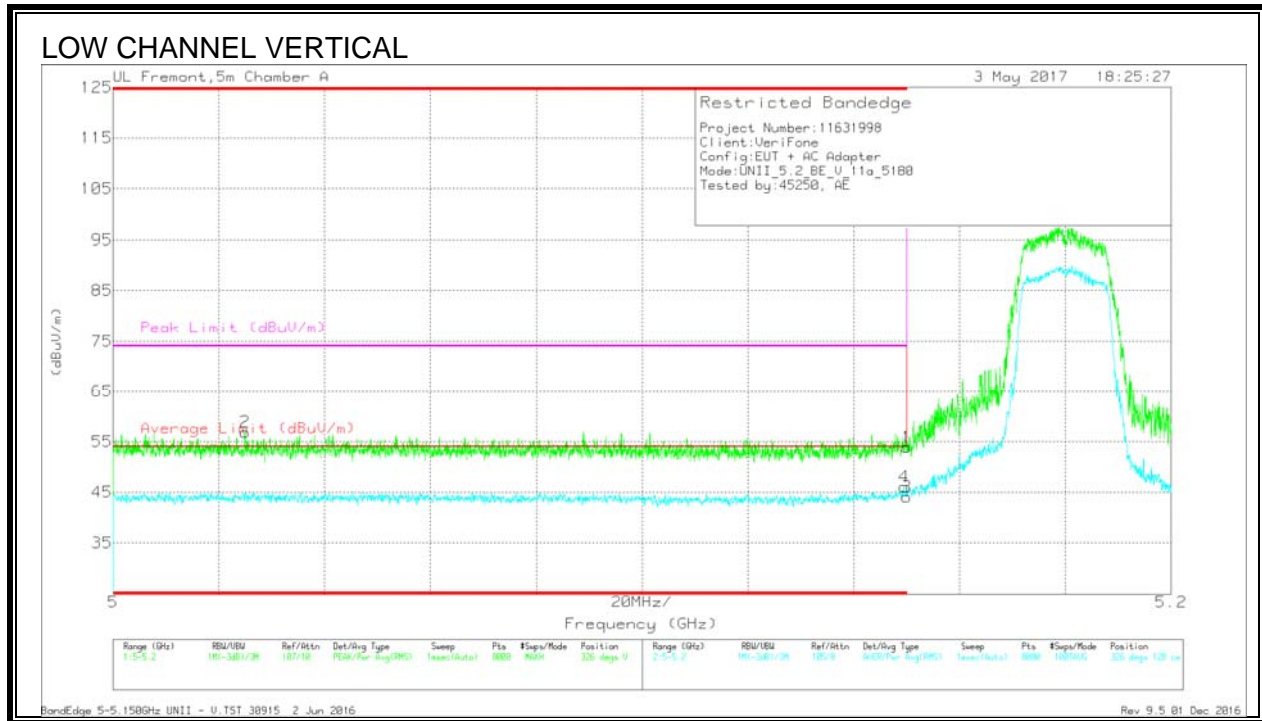

Trace Markers

Marker	Frequency (GHz)	Meter Reading (dBuV)	Det	AF T711 (dB/m)	Amp/Cbl/Filtr/ Pad (dB)	DC Corr (dB)	Corrected Reading (dBuV/m)	Average Limit (dBuV/m)	Margin (dB)	Peak Limit (dBuV/m)	PK Margin (dB)	Azimuth (Degs)	Height (cm)	Polarity
1	* 5.15	38.46	Pk	34.1	-18.7	0	53.86	-	-	74	-20.14	326	128	V
2	* 5.025	41.07	Pk	34.1	-18.3	0	56.87	-	-	74	-17.13	326	128	V
3	* 5.15	28.4	RMS	34.1	-18.7	.29	44.09	54	-9.91	-	-	326	128	V
4	* 5.149	30.32	RMS	34.1	-18.6	.29	46.11	54	-7.89	-	-	326	128	V

* - indicates frequency in CFR47 Pt 15 / IC RSS-Restricted Band

Pk - Peak detector

RMS - RMS detection

HARMONICS AND SPURIOUS EMISSIONS

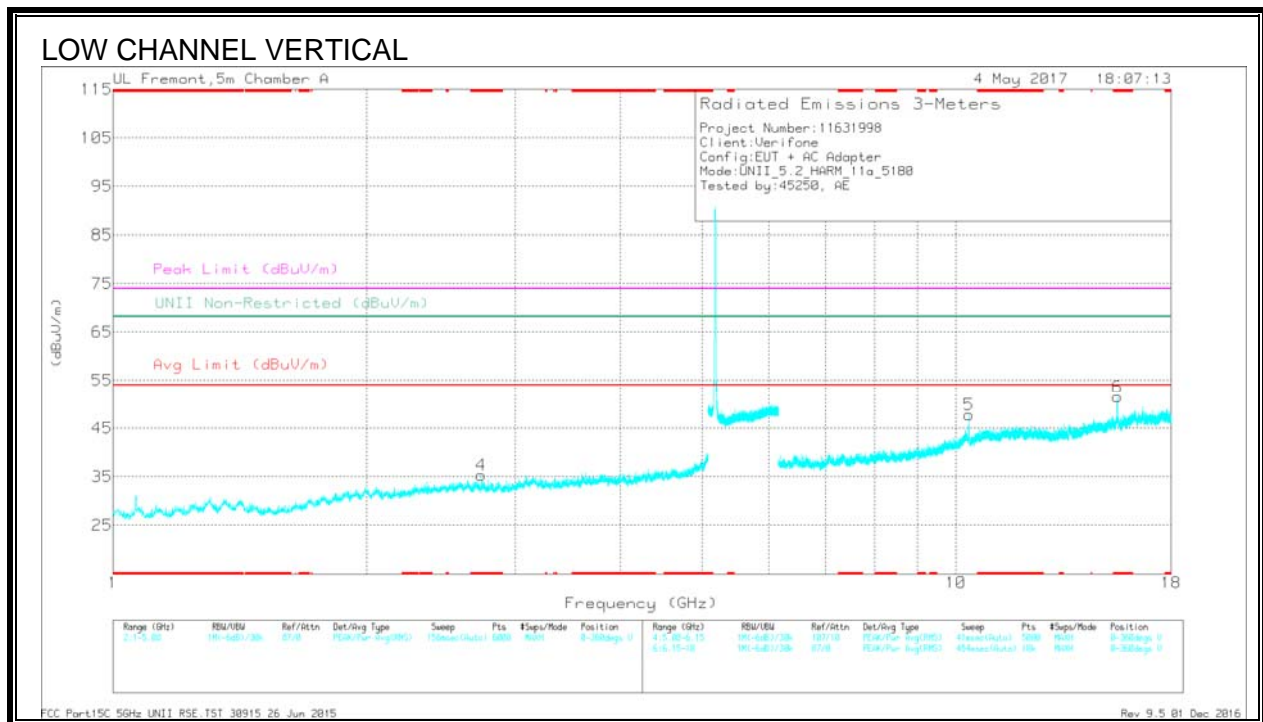
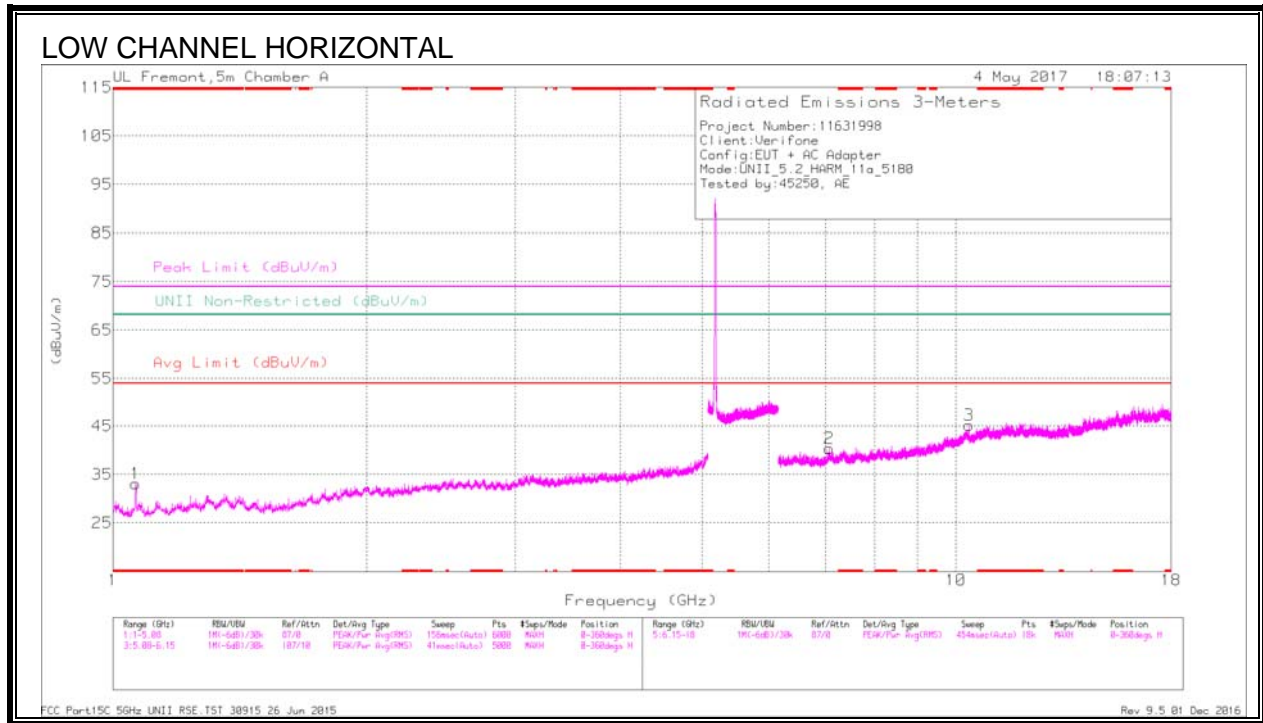

Trace Markers

Marker	Frequency (GHz)	Meter Reading (dBuV)	Det	AF T711 (dB/m)	Amp/Cb/Filt/ Pad (dB)	DC Corr (dB)	Corrected Reading (dBuV/m)	Avg Limit (dBuV/m)	Margin (dB)	Peak Limit (dBuV/m)	PK Margin (dB)	UNII Non-Restricted (dBuV/m)	PK Margin (dB)	Azimuth (Degs)	Height (cm)	Polarity
1	* 1.064	39.14	Pk	27.8	-33.8	0	33.14	-	-	74	-40.86	-	-	0-360	199	H
4	* 2.736	34.74	Pk	32.6	-32	0	35.34	-	-	74	-38.66	-	-	0-360	200	V
6	* 15.543	30.32	Pk	40.3	-19.1	0	51.52	-	-	74	-22.48	-	-	0-360	101	V
2	7.068	28.32	Pk	35.4	-23.3	0	40.42	-	-	-	-	68.2	-27.78	0-360	101	H
5	10.356	30.93	Pk	37.4	-20.5	0	47.83	-	-	-	-	68.2	-20.37	0-360	101	V
3	10.362	28.24	Pk	37.4	-20.5	0	45.14	-	-	-	-	68.2	-23.06	0-360	101	H

* - indicates frequency in CFR47 Pt 15 / IC RSS-Restricted Band
 Pk - Peak detector

Radiated Emissions

Frequency (GHz)	Meter Reading (dBuV)	Det	AF T711 (dB/m)	Amp/Cb/Filt/Pad (dB)	DC Corr (dB)	Corrected Reading (dBuV/m)	Avg Limit (dBuV/m)	Margin (dB)	Peak Limit (dBuV/m)	PK Margin (dB)	UNII Non-Restricted (dBuV/m)	PK Margin (dB)	Azimuth (Degs)	Height (cm)	Polarity
* 1.065	45.41	PK-U	27.8	-33.8	0	39.41	-	-	74	-34.59	-	-	47	265	H
* 1.065	36.24	ADR	27.8	-33.8	29	30.53	54	-23.47	-	-	-	-	47	265	H
* 2.736	39.84	PK-U	32.6	-32	0	40.44	-	-	74	-33.56	-	-	9	248	V
* 2.737	28.14	ADR	32.6	-32	29	29.03	54	-24.97	-	-	-	-	9	248	V
* 15.543	37.63	PK-U	40.3	-19.1	0	58.83	-	-	74	-15.17	-	-	359	111	V
* 15.541	24.02	ADR	40.3	-19.1	29	45.51	54	-8.49	-	-	-	-	359	111	V
7.069	33.99	PK-U	35.4	-23.3	0	46.09	-	-	-	-	68.2	-22.11	120	102	H
10.356	37.8	PK-U	37.4	-20.5	0	54.7	-	-	-	-	68.2	-13.5	312	109	V
10.36	35.89	PK-U	37.4	-20.5	0	52.79	-	-	-	-	68.2	-15.41	61	110	H

* - indicates frequency in CFR47 Pt 15 / IC RSS-Restricted Band
 PK-U - U-NII: Maximum Peak
 ADR - U-NII AD primary method, RMS average

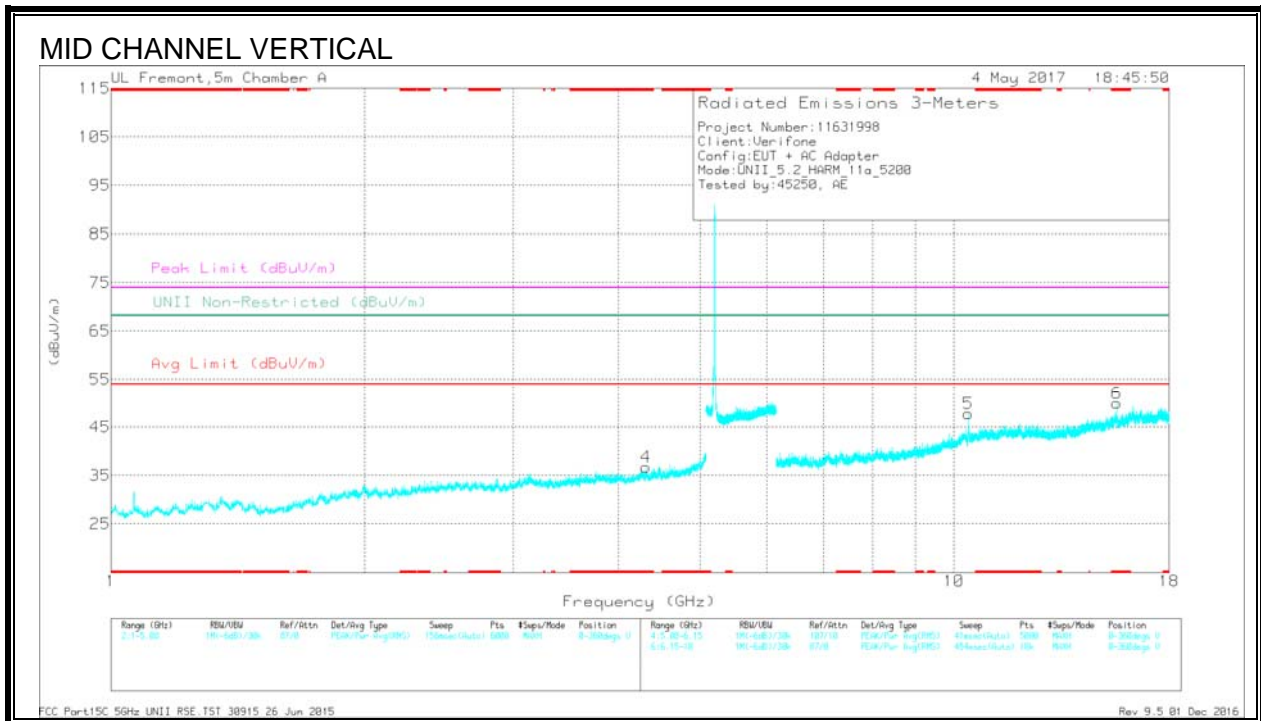
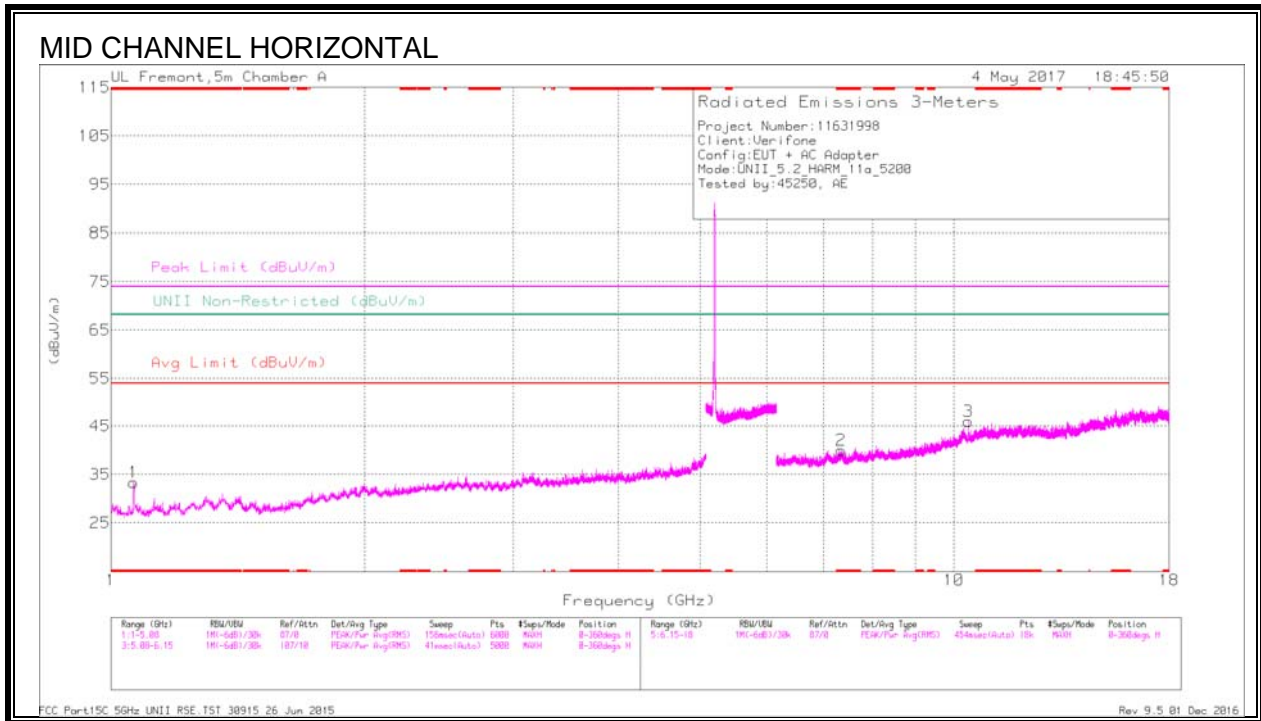

Trace Markers

Marker	Frequency (GHz)	Meter Reading (dBuV)	Det	AF T711 (dB/m)	Amp/CM/FT/Pad (dB)	DC Corr (dB)	Corrected Reading (dBuV/m)	Avg Limit (dBuV/m)	Margin (dB)	Peak Limit (dBuV/m)	PK Margin (dB)	UNII Non-Restricted (dBuV/m)	PK Margin (dB)	Azimuth (Degs)	Height (cm)	Polarity
1	* 1.064	39.39	Pk	27.8	-33.8	0	33.39	-	-	74	-40.61	-	-	0-360	199	H
4	* 4.314	32.25	Pk	33.4	-28.9	0	36.75	-	-	74	-37.25	-	-	0-360	101	V
2	* 7.348	27.68	Pk	35.5	-23.2	0	39.98	-	-	74	-34.02	-	-	0-360	199	H
6	* 15.603	29.73	Pk	40.4	-20.2	0	49.93	-	-	74	-24.07	-	-	0-360	101	V
5	10.396	31.19	Pk	37.4	-20.8	0	47.79	-	-	-	-	68.2	-20.41	0-360	101	V
3	10.398	29.21	Pk	37.5	-20.8	0	45.91	-	-	-	-	68.2	-22.29	0-360	101	H

* - indicates frequency in CFR47 Pt 15 / IC RSS-Restricted Band
 Pk - Peak detector

Radiated Emissions

Frequency (GHz)	Meter Reading (dBuV)	Det	AF T711 (dB/m)	Amp/CM/FT/Pad (dB)	DC Corr (dB)	Corrected Reading (dBuV/m)	Avg Limit (dBuV/m)	Margin (dB)	Peak Limit (dBuV/m)	PK Margin (dB)	UNII Non-Restricted (dBuV/m)	PK Margin (dB)	Azimuth (Degs)	Height (cm)	Polarity
* 1.064	46.55	PK-U	27.8	-33.8	0	40.55	-	-	74	-33.45	-	-	51	186	H
* 1.064	38.96	ADR	27.8	-33.8	29	33.25	54	-20.75	-	-	-	-	51	186	H
* 4.315	38.8	PK-U	33.4	-28.9	0	43.3	-	-	74	-30.7	-	-	1	119	V
* 4.316	26.89	ADR	33.4	-28.9	29	31.68	54	-22.32	-	-	-	-	1	119	V
* 7.348	33.39	PK-U	35.5	-23.2	0	45.69	-	-	74	-28.31	-	-	360	115	H
* 7.346	22.7	ADR	35.5	-23.2	29	35.29	54	-18.71	-	-	-	-	360	115	H
* 15.603	38.14	PK-U	40.4	-20.2	0	58.34	-	-	74	-15.66	-	-	357	102	V
* 15.601	24.73	ADR	40.4	-20.2	29	45.22	54	-8.78	-	-	-	-	357	102	V
10.396	38.52	PK-U	37.4	-20.8	0	55.12	-	-	-	-	68.2	-13.08	85	101	V
10.399	36.5	PK-U	37.5	-20.8	0	53.2	-	-	-	-	68.2	-15	61	103	H

* - indicates frequency in CFR47 Pt 15 / IC RSS-Restricted Band
 PK-U - U-NII: Maximum Peak
 ADR - U-NII AD primary method, RMS average

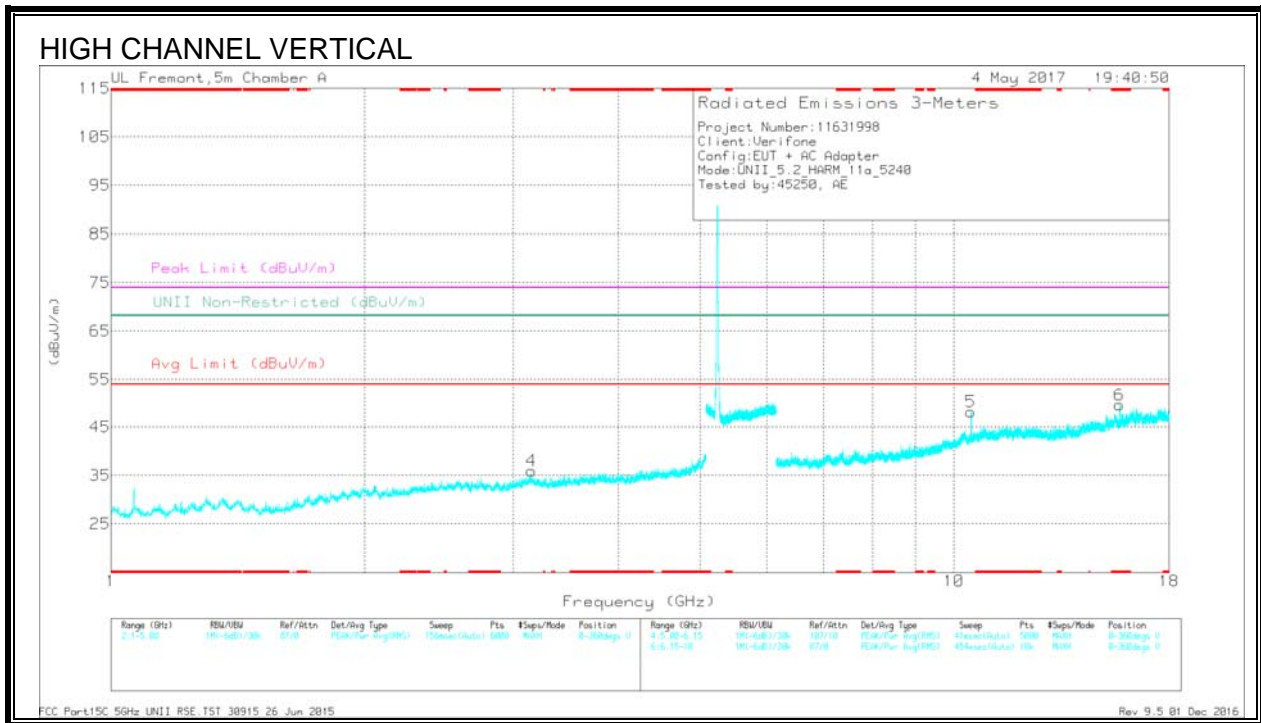
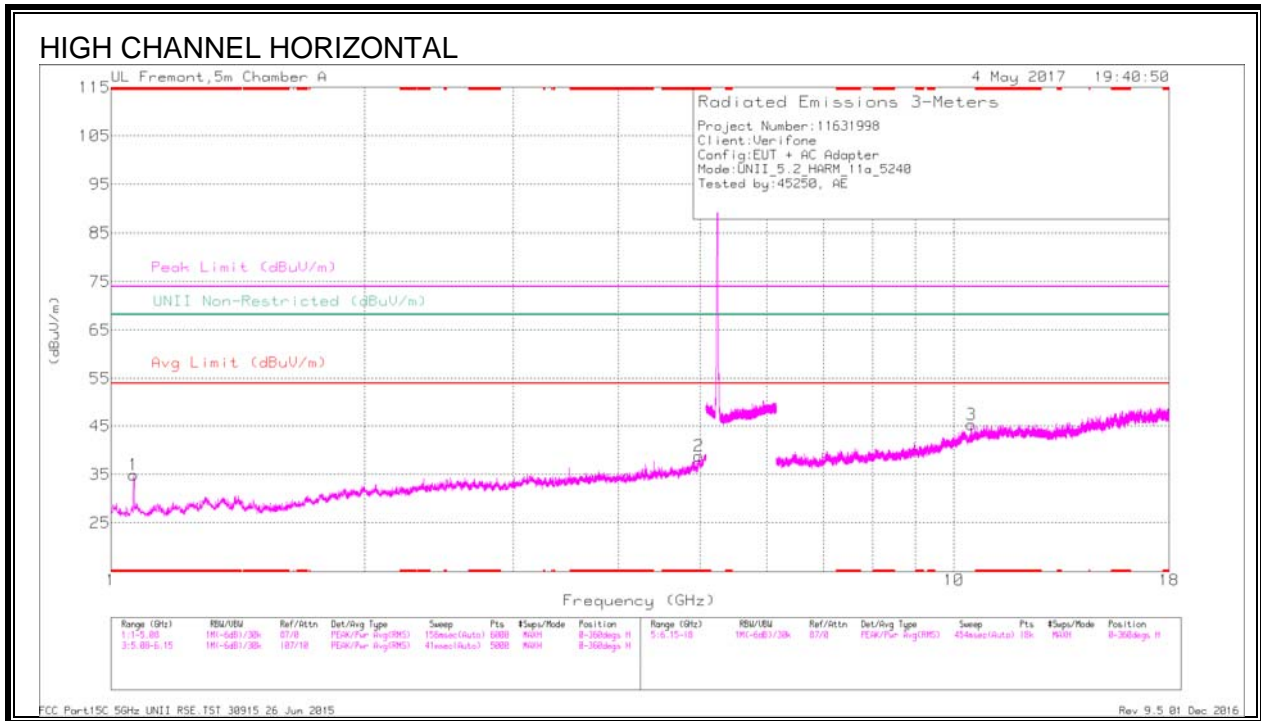

Trace Markers

Marker	Frequency (GHz)	Meter Reading (dBuV)	Det	Af T711 (dB/m)	Amp/CS/FR/Pad (dB)	DC Corr (dB)	Corrected Reading (dBuV/m)	Avg Limit (dBuV/m)	Margin (dB)	Peak Limit (dBuV/m)	PK Margin (dB)	UNII Non-Restricted (dBuV/m)	PK Margin (dB)	Azimuth (Degs)	Height (cm)	Polarity
1	* 1.064	40.91	Pk	27.8	-33.8	0	34.91	-	-	74	-39.09	-	-	0-360	199	H
2	* 4.981	31.86	Pk	34.1	-27.2	0	38.76	-	-	74	-35.24	-	-	0-360	199	H
6	* 15.721	30.2	Pk	40.4	-21	0	49.6	-	-	74	-24.4	-	-	0-360	101	V
4	3.155	33.41	Pk	33	-30.5	0	35.91	-	-	-	-	68.2	-32.29	0-360	101	V
5	10.478	31.32	Pk	37.6	-20.8	0	48.12	-	-	-	-	68.2	-20.08	0-360	101	V
3	10.479	28.57	Pk	37.6	-20.8	0	45.37	-	-	-	-	68.2	-22.83	0-360	101	H

* - indicates frequency in CFR47 Pt 15 / IC RSS-Restricted Band
 Pk - Peak detector

Radiated Emissions

Frequency (GHz)	Meter Reading (dBuV)	Det	Af T711 (dB/m)	Amp/CS/FR/Pad (dB)	DC Corr (dB)	Corrected Reading (dBuV/m)	Avg Limit (dBuV/m)	Margin (dB)	Peak Limit (dBuV/m)	PK Margin (dB)	UNII Non-Restricted (dBuV/m)	PK Margin (dB)	Azimuth (Degs)	Height (cm)	Polarity
* 1.064	47.07	PK-U	27.8	-33.8	0	41.07	-	-	74	-32.93	-	-	183	192	H
* 1.065	37.68	ADR	27.8	-33.8	29	31.97	54	-22.03	-	-	-	-	183	192	H
* 4.979	38.03	PK-U	34.1	-27.2	0	44.93	-	-	74	-29.07	-	-	72	198	H
* 4.979	26.94	ADR	34.1	-27.2	29	34.13	54	-19.87	-	-	-	-	72	198	H
* 15.723	37.39	PK-U	40.4	-21	0	56.79	-	-	74	-17.21	-	-	357	102	V
* 15.722	24.88	ADR	40.4	-21	29	44.57	54	-9.43	-	-	-	-	357	102	V
3.155	38.67	PK-U	33	-30.5	0	41.17	-	-	-	-	68.2	-27.03	0	146	V
10.479	39.32	PK-U	37.6	-20.8	0	56.12	-	-	-	-	68.2	-12.08	314	104	V
10.48	36.51	PK-U	37.6	-20.8	0	53.31	-	-	-	-	68.2	-14.89	59	101	H

* - indicates frequency in CFR47 Pt 15 / IC RSS-Restricted Band
 PK-U - U-NII: Maximum Peak
 ADR - U-NII AD primary method, RMS average

9.1.2. 11n HT20 MODE IN THE 5.2GHz BAND

BANDEDGE (LOW CHANNEL)

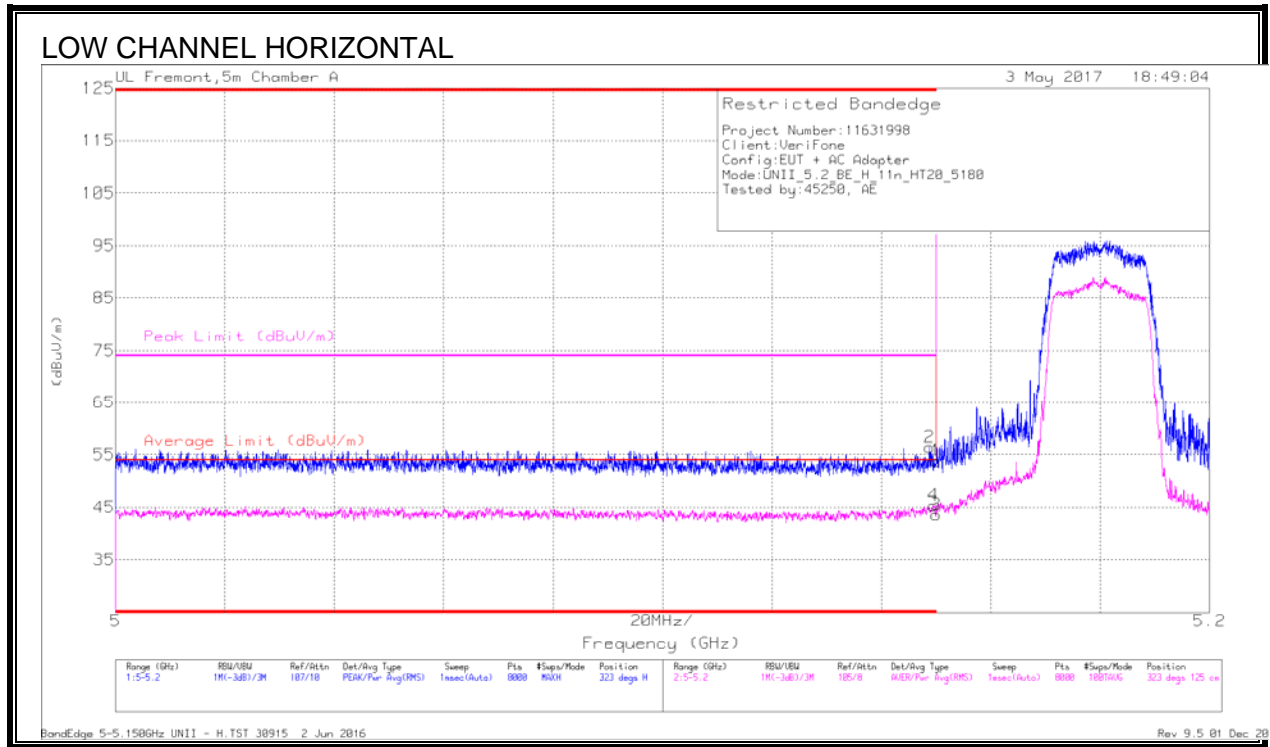

Trace Markers

Marker	Frequency (GHz)	Meter Reading (dBuV)	Det	AF T711 (dB/m)	Amp/Cb/Filtr/ Pad (dB)	DC Corr (dB)	Corrected Reading (dBuV/m)	Average Limit (dBuV/m)	Margin (dB)	Peak Limit (dBuV/m)	PK Margin (dB)	Azimuth (Degs)	Height (cm)	Polarity
2	* 5.149	40.89	Pk	34.1	-18.6	0	56.39	-	-	74	-17.61	323	125	H
4	* 5.149	29.48	RMS	34.1	-18.6	.31	45.29	54	-8.71	-	-	323	125	H
1	* 5.15	38.33	Pk	34.1	-18.7	0	53.73	-	-	74	-20.27	323	125	H
3	* 5.15	27.93	RMS	34.1	-18.7	.31	43.64	54	-10.36	-	-	323	125	H

* - indicates frequency in CFR47 Pt 15 / IC RSS-Restricted Band

Pk - Peak detector

RMS - RMS detection

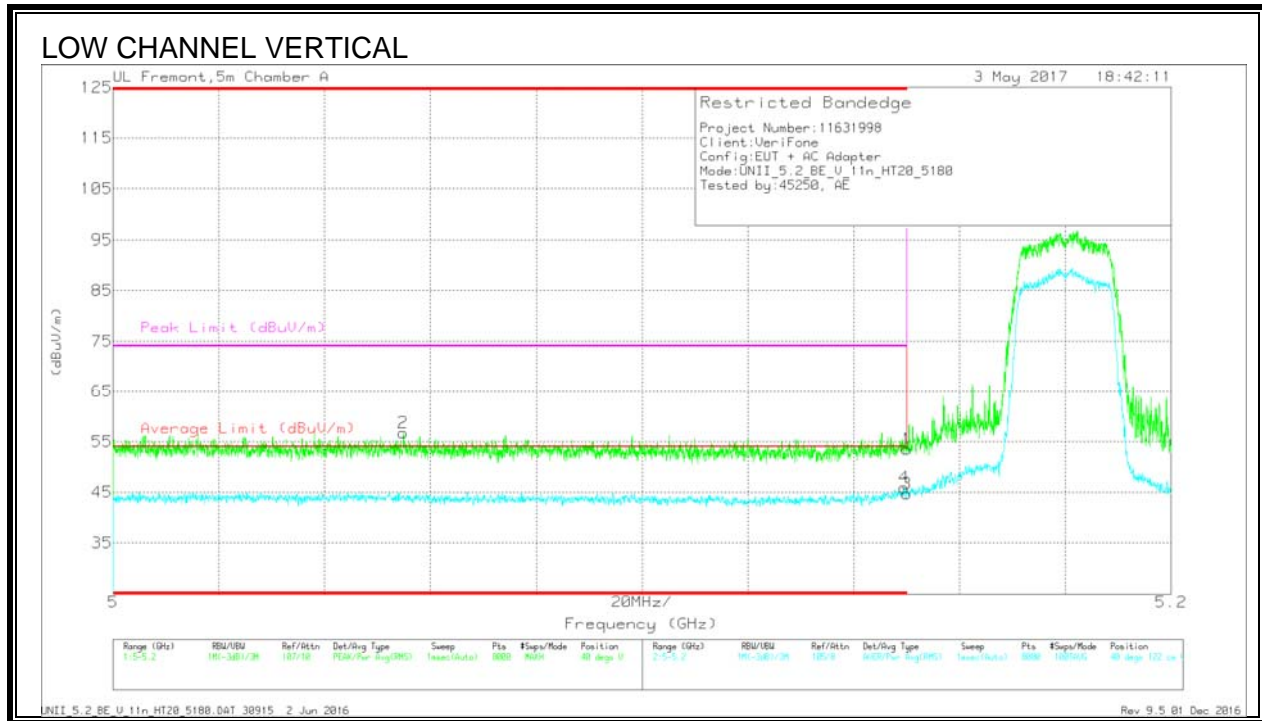

Trace Markers

Marker	Frequency (GHz)	Meter Reading (dBuV)	Det	AFT711 (dB/m)	Amp/Cbl/Filtr/Pad (dB)	DC Corr (dB)	Corrected Reading (dBuV/m)	Average Limit (dBuV/m)	Margin (dB)	Peak Limit (dBuV/m)	PK Margin (dB)	Azimuth (Degs)	Height (cm)	Polarity
1	* 5.15	38.13	Pk	34.1	-18.7	0	53.53	-	-	74	-20.47	40	122	V
2	* 5.055	41.08	Pk	34.1	-18.4	0	56.78	-	-	74	-17.22	40	122	V
3	* 5.15	28.94	RMS	34.1	-18.7	.31	44.65	54	-9.35	-	-	40	122	V
4	* 5.15	30.12	RMS	34.1	-18.6	.31	45.93	54	-8.07	-	-	40	122	V

* - indicates frequency in CFR47 Pt 15 / IC RSS-Restricted Band

Pk - Peak detector

RMS - RMS detection

HARMONICS AND SPURIOUS EMISSIONS

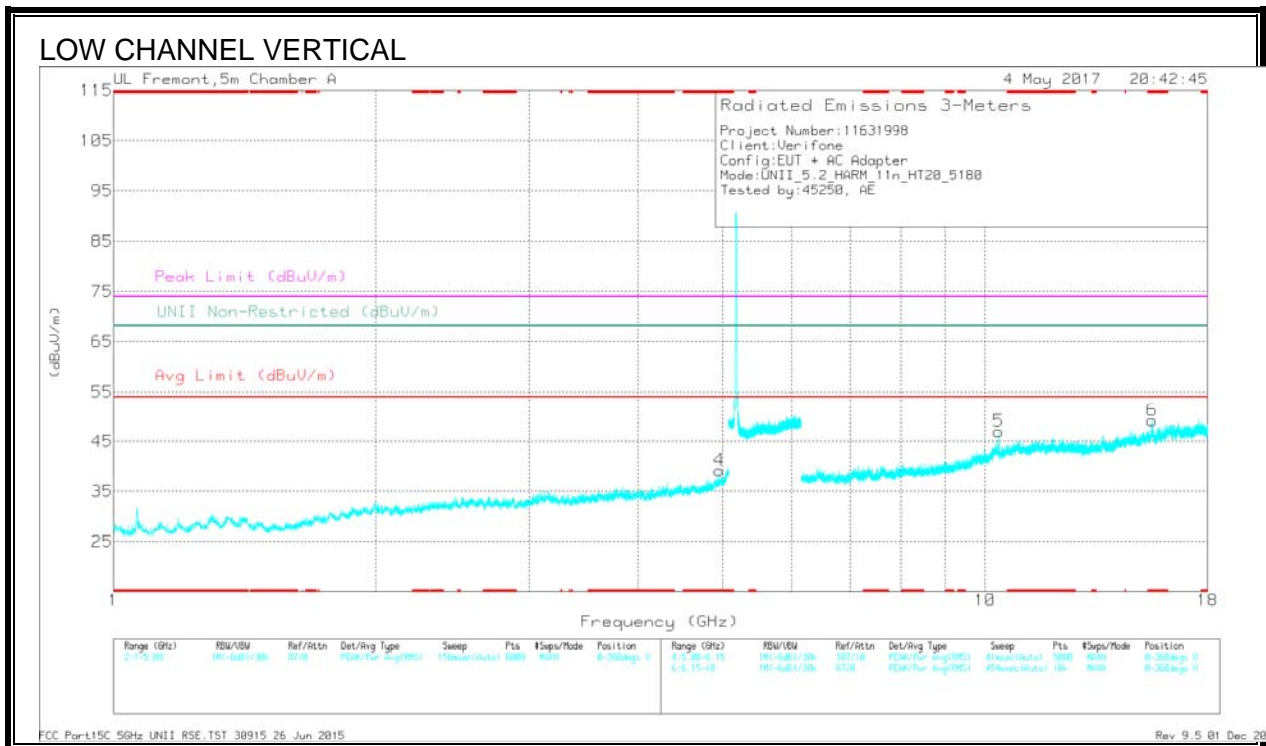
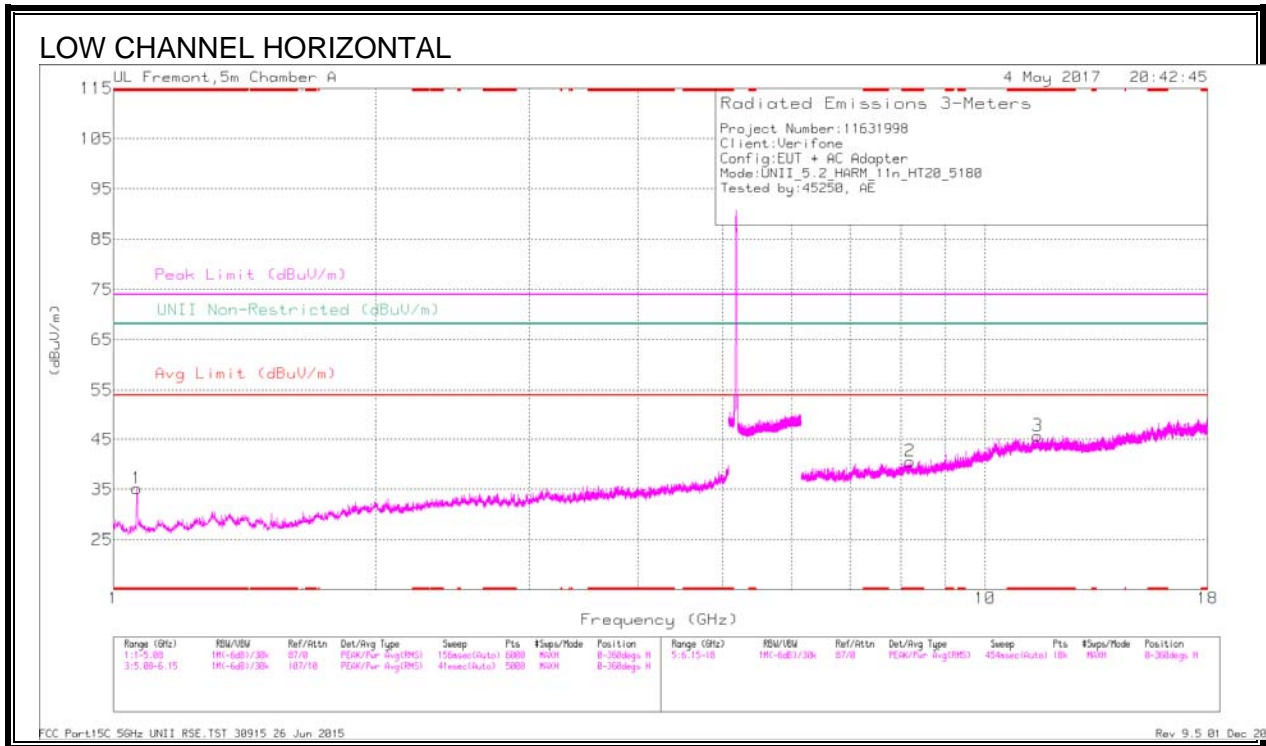

Trace Markers

Marker	Frequency (GHz)	Meter Reading (dBuV)	Det	AF T711 (dB/m)	Amp/Ch/Ftr/Pad (dB)	DC Corr (dB)	Corrected Reading (dBuV/m)	Avg Limit (dBuV/m)	Margin (dB)	Peak Limit (dBuV/m)	PK Margin (dB)	UNII Non-Restricted (dBuV/m)	PK Margin (dB)	Altitude (Degs)	Height (cm)	Polarity
1	* 1.064	41.22	Pk	27.8	-33.8	0	35.22	-	-	74	-38.78	-	-	0-360	199	H
4	* 4.956	33.06	Pk	34.1	-28	0	39.16	-	-	74	-34.84	-	-	0-360	101	V
2	* 8.203	27.9	Pk	35.7	-23	0	40.6	-	-	74	-33.4	-	-	0-360	199	H
3	* 11.495	27.31	Pk	38.1	-19.7	0	45.71	-	-	74	-28.29	-	-	0-360	199	H
6	* 15.544	28.02	Pk	40.3	-19.1	0	49.22	-	-	74	-24.78	-	-	0-360	101	V
5	10.355	30.06	Pk	37.4	-20.5	0	46.96	-	-	-	-	68.2	-21.24	0-360	101	V

* - indicates frequency in CFR47 Pt 15 / IC RSS-Restricted Band
 Pk - Peak detector

Radiated Emissions

Frequency (GHz)	Meter Reading (dBuV)	Det	AF T711 (dB/m)	Amp/Ch/Ftr/Pad (dB)	DC Corr (dB)	Corrected Reading (dBuV/m)	Avg Limit (dBuV/m)	Margin (dB)	Peak Limit (dBuV/m)	PK Margin (dB)	UNII Non-Restricted (dBuV/m)	PK Margin (dB)	Altitude (Degs)	Height (cm)	Polarity
* 1.065	46.66	PK-U	27.8	-33.8	0	40.56	-	-	74	-33.34	-	-	60	190	H
* 1.064	38.61	ADR	27.8	-33.8	.31	32.92	54	-21.08	-	-	-	-	60	190	H
* 4.956	38	PK-U	34.1	-28	0	44.1	-	-	74	-29.9	-	-	130	163	V
* 4.955	26.67	ADR	34.1	-28	.31	33.08	54	-20.92	-	-	-	-	130	163	V
* 8.205	33.1	PK-U	35.7	-23	0	45.8	-	-	74	-28.2	-	-	1	186	H
* 8.202	22.65	ADR	35.7	-23	.31	35.66	54	-18.34	-	-	-	-	1	186	H
* 11.497	33.33	PK-U	38.1	-19.7	0	51.73	-	-	74	-22.27	-	-	187	125	H
* 11.495	21.47	ADR	38.1	-19.7	.31	40.18	54	-13.82	-	-	-	-	187	125	H
* 15.545	36.34	PK-U	40.3	-19.1	0	57.54	-	-	74	-16.46	-	-	357	101	V
* 15.543	23.22	ADR	40.3	-19.1	.31	44.73	54	-9.27	-	-	-	-	357	101	V
10.357	38.07	PK-U	37.4	-20.5	0	54.97	-	-	-	-	68.2	-13.23	312	103	V

* - indicates frequency in CFR47 Pt 15 / IC RSS-Restricted Band
 PK-U - U-NII: Maximum Peak
 ADR - U-NII AD primary method, RMS average

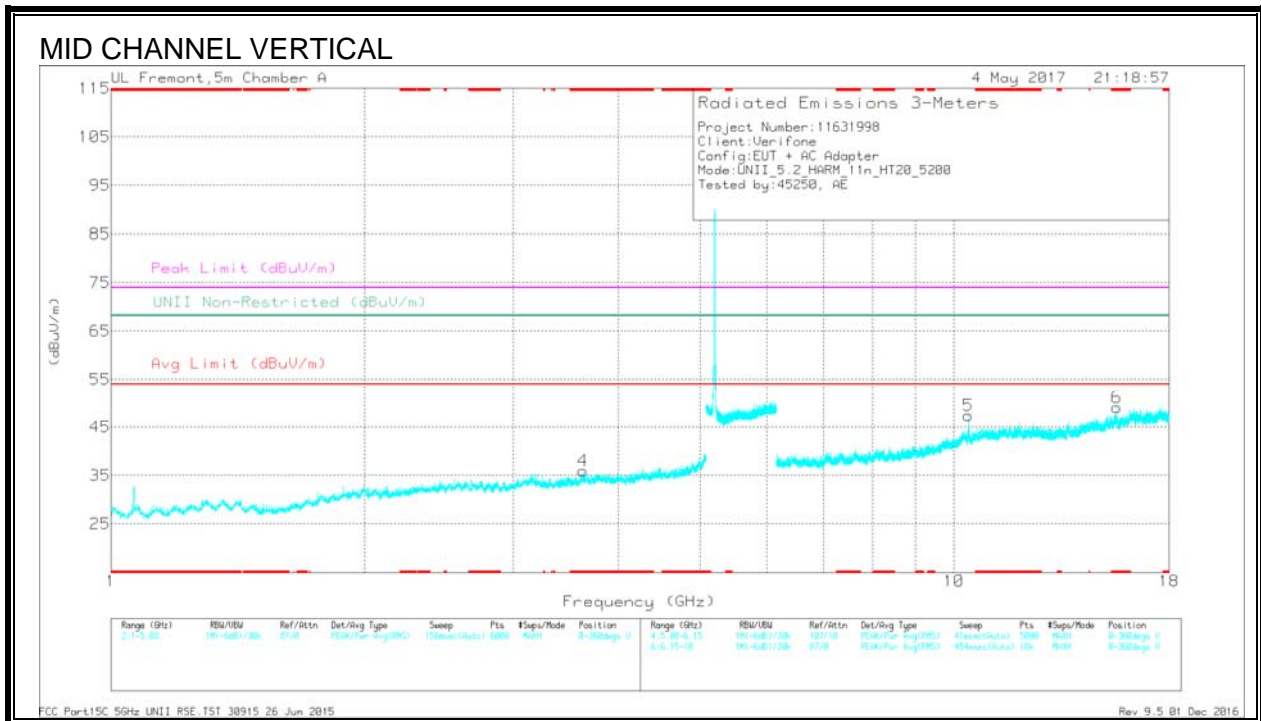
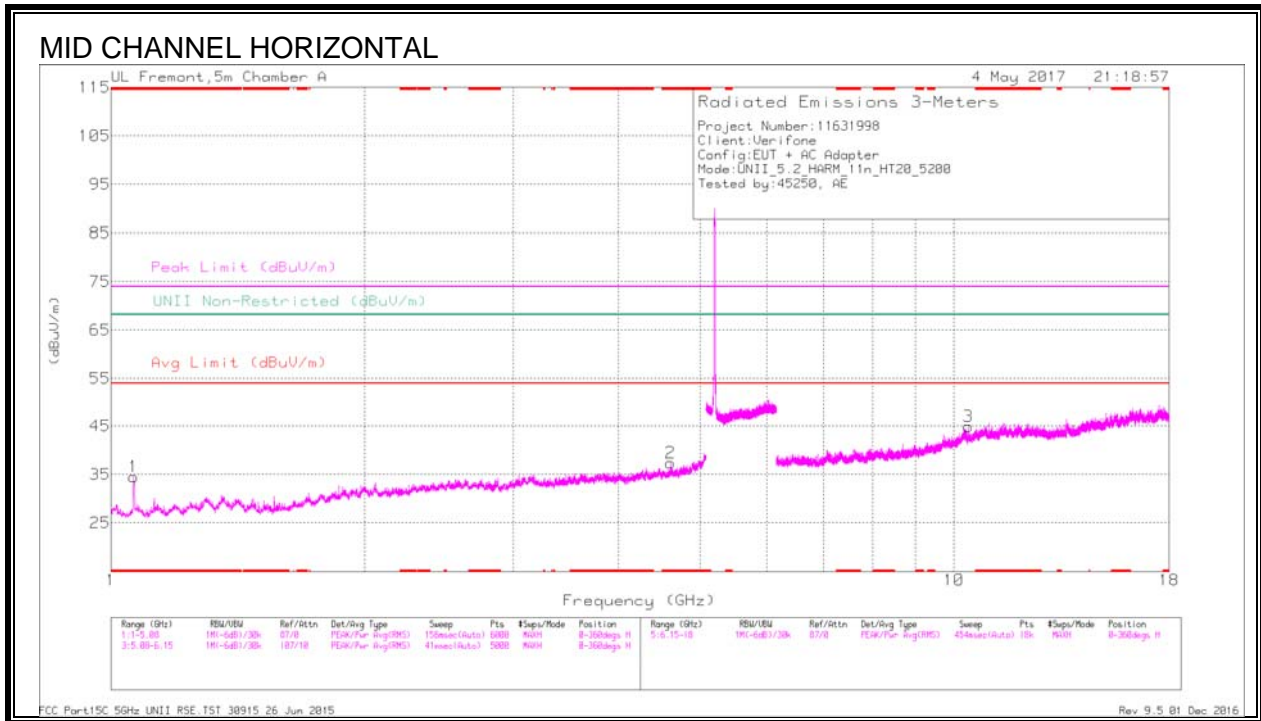

Trace Markers

Marker	Frequency (GHz)	Meter Reading (dBuV)	Det	AF T711 (dB/m)	Amp/Cb/Pk/Psd (dB)	DC Corr (dB)	Corrected Reading (dBuV/m)	Avg Limit (dBuV/m)	Margin (dB)	Peak Limit (dBuV/m)	PK Margin (dB)	UNII Non-Restricted (dBuV/m)	PK Margin (dB)	Asimuth (Degs)	Height (cm)	Polarity
1	* 1.064	40.58	Pk	27.8	-33.8	0	34.58	-	-	74	-39.42	-	-	0-360	199	H
2	* 4.609	32.04	Pk	33.7	-28.4	0	37.34	-	-	74	-36.66	-	-	0-360	199	H
4	* 3.632	33.68	Pk	33.1	-30.8	0	35.98	-	-	74	-38.02	-	-	0-360	200	V
6	* 15.604	28.92	Pk	40.4	-20.2	0	49.12	-	-	74	-24.88	-	-	0-360	101	V
3	10.398	28.27	Pk	37.5	-20.8	0	44.97	-	-	-	-	68.2	-23.23	0-360	101	H
5	10.398	30.63	Pk	37.5	-20.8	0	47.33	-	-	-	-	68.2	-20.87	0-360	101	V

* - indicates frequency in CFR47 Pt 15 / IC RSS-Restricted Band
 Pk - Peak detector

Radiated Emissions

Frequency (GHz)	Meter Reading (dBuV)	Det	AF T711 (dB/m)	Amp/Cb/Pk/Psd (dB)	DC Corr (dB)	Corrected Reading (dBuV/m)	Avg Limit (dBuV/m)	Margin (dB)	Peak Limit (dBuV/m)	PK Margin (dB)	UNII Non-Restricted (dBuV/m)	PK Margin (dB)	Asimuth (Degs)	Height (cm)	Polarity
* 1.064	46.51	PK-U	27.8	-33.8	0	40.51	-	-	74	-33.49	-	-	62	193	H
* 1.064	37.82	ADR	27.8	-33.8	31	32.13	54	-21.87	-	-	-	-	62	193	H
* 4.607	37.27	PK-U	33.7	-28.4	0	42.57	-	-	74	-31.43	-	-	4	198	H
* 4.611	26.2	ADR	33.7	-28.3	31	31.91	54	-22.09	-	-	-	-	4	198	H
* 3.631	38.06	PK-U	33.1	-30.7	0	40.46	-	-	74	-33.54	-	-	0	108	V
* 3.632	27.06	ADR	33.1	-30.8	31	29.67	54	-24.33	-	-	-	-	0	108	V
* 15.605	36.08	PK-U	40.4	-20.2	0	56.28	-	-	74	-17.72	-	-	357	102	V
* 15.602	24.15	ADR	40.4	-20.2	31	44.66	54	-9.34	-	-	-	-	357	102	V
10.398	38.16	PK-U	37.5	-20.8	0	54.86	-	-	-	-	68.2	-13.34	308	123	V
10.399	36.22	PK-U	37.5	-20.8	0	52.92	-	-	-	-	68.2	-15.28	57	103	H

* - indicates frequency in CFR47 Pt 15 / IC RSS-Restricted Band
 PK-U - U-NII: Maximum Peak
 ADR - U-NII AD primary method, RMS average

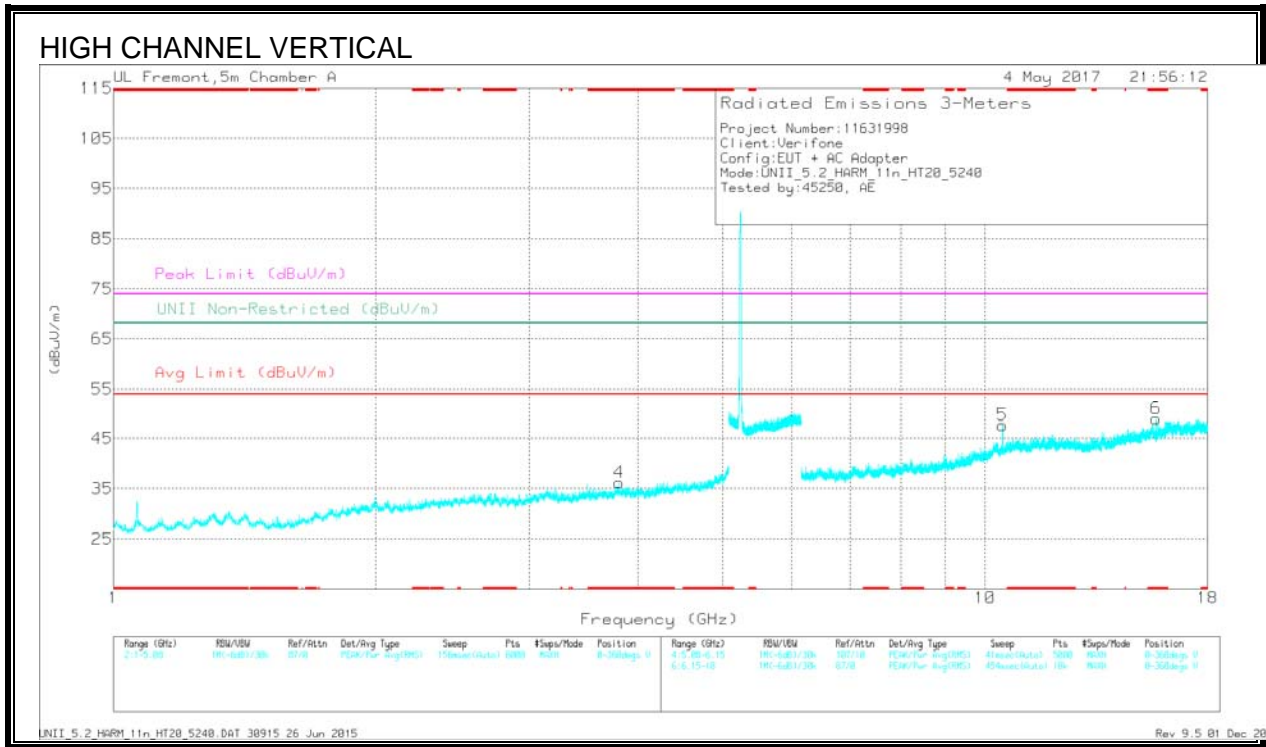
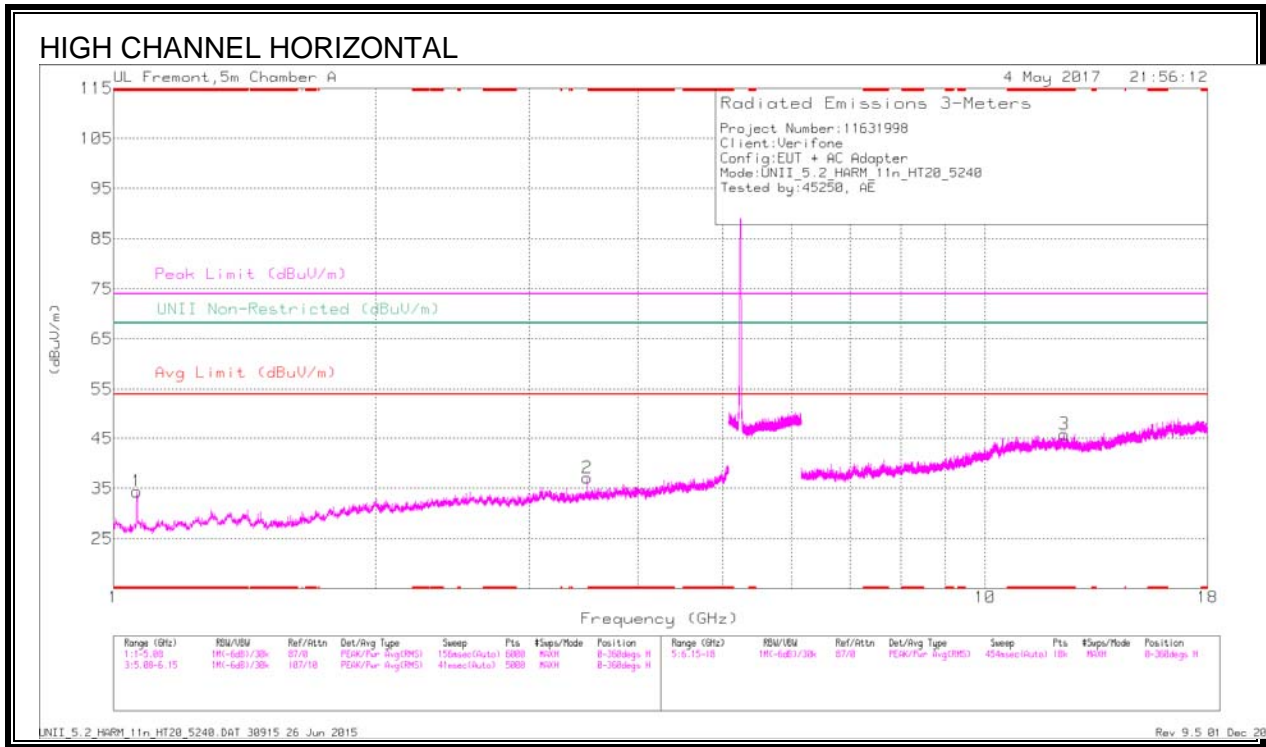

Trace Markers

Marker	Frequency (GHz)	Meter Reading (dBuV)	Det	AF T711 (dB/m)	Amp/Ch/Ftr/Pad (dB)	DC Corr (dB)	Corrected Reading (dBuV/m)	Avg Limit (dBuV/m)	Margin (dB)	Peak Limit (dBuV/m)	PK Margin (dB)	U-NII Non-Restricted (dBuV/m)	PK Margin (dB)	Altitude (Degs)	Height (cm)	Polarity
1	* 1.064	40.38	Pk	27.8	-33.8	0	34.38	-	-	74	-39.62	-	-	0-360	199	H
3	* 12.335	27.72	Pk	38.8	-20.7	0	45.82	-	-	74	-28.18	-	-	0-360	101	H
6	* 15.722	29.57	Pk	40.4	-21	0	48.97	-	-	74	-25.03	-	-	0-360	101	V
4	* 3.802	32.58	Pk	33.1	-29.5	0	36.18	-	-	74	-37.82	-	-	0-360	200	V
5	10.476	30.89	Pk	37.6	-20.8	0	47.69	-	-	-	-	68.2	-20.51	0-360	101	V
2	3.493	34.43	Pk	33	-30.3	0	37.13	-	-	-	-	68.2	-31.07	0-360	101	H

* - indicates frequency in CFR47 Pt 15 / IC RSS-Restricted Band
 Pk - Peak detector

Radiated Emissions

Frequency (GHz)	Meter Reading (dBuV)	Det	AF T711 (dB/m)	Amp/Ch/Ftr/Pad (dB)	DC Corr (dB)	Corrected Reading (dBuV/m)	Avg Limit (dBuV/m)	Margin (dB)	Peak Limit (dBuV/m)	PK Margin (dB)	U-NII Non-Restricted (dBuV/m)	PK Margin (dB)	Altitude (Degs)	Height (cm)	Polarity
* 1.063	46.26	PK-U	27.8	-33.8	0	40.26	-	-	74	-33.74	-	-	60	187	H
* 1.065	37.53	ADR	27.8	-33.8	.31	31.84	54	-22.16	-	-	-	-	60	187	H
* 3.802	37.51	PK-U	33.1	-29.5	0	41.11	-	-	74	-32.89	-	-	1	169	V
* 3.802	26.61	ADR	33.1	-29.5	.31	30.52	54	-23.48	-	-	-	-	1	169	V
* 12.335	32.48	PK-U	38.8	-20.7	0	50.58	-	-	74	-23.42	-	-	144	112	H
* 12.333	21.51	ADR	38.8	-20.8	.31	39.82	54	-14.18	-	-	-	-	144	112	H
* 15.722	37.92	PK-U	40.4	-21	0	57.32	-	-	74	-16.68	-	-	8	102	V
* 15.72	25.06	ADR	40.4	-21	.31	44.77	54	-9.23	-	-	-	-	8	102	V
3.492	39	PK-U	33	-30.4	0	41.6	-	-	-	-	68.2	-26.6	126	131	H
10.476	38.35	PK-U	37.6	-20.8	0	55.15	-	-	-	-	68.2	-13.05	323	101	V

* - indicates frequency in CFR47 Pt 15 / IC RSS-Restricted Band
 PK-U - U-NII: Maximum Peak
 ADR - U-NII AD primary method, RMS average

9.1.3. 11n HT40 MODE IN THE 5.2GHz BAND

BANDEDGE (LOW CHANNEL)

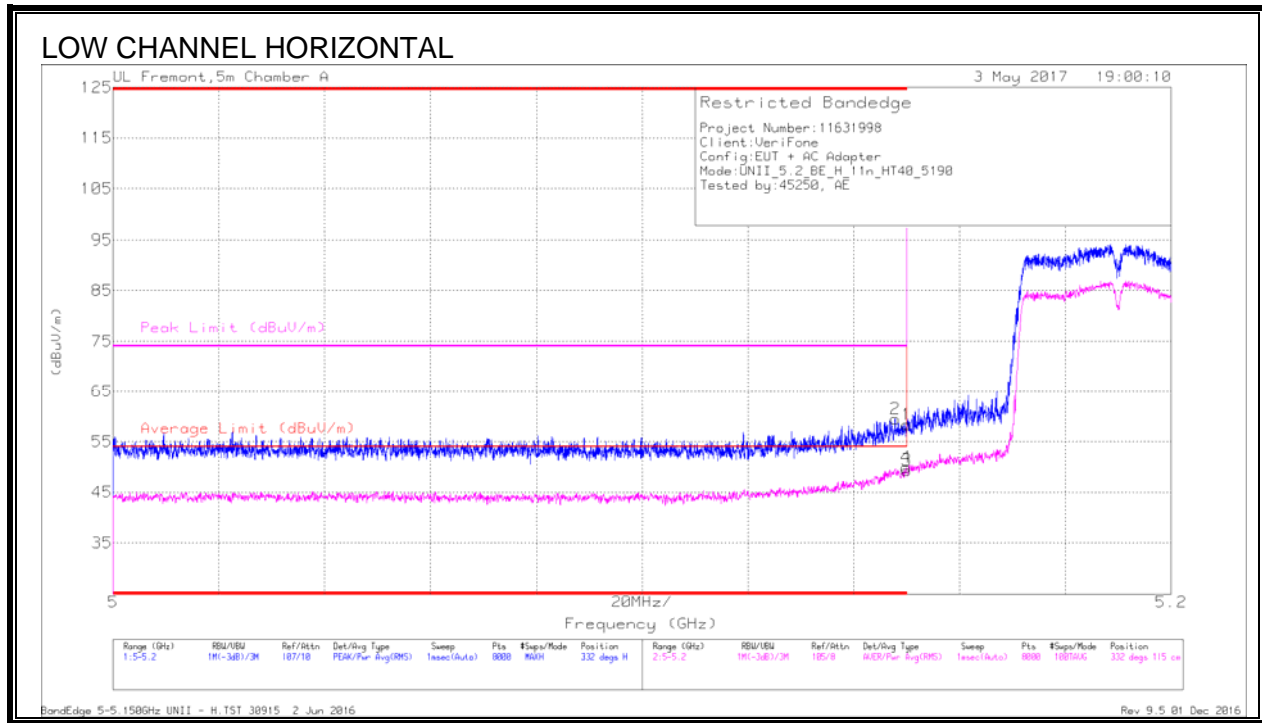

Trace Markers

Marker	Frequency (GHz)	Meter Reading (dBuV)	Det	AF T711 (dB/m)	Amp/Cbl/Filtr/ Pad (dB)	DC Corr (dB)	Corrected Reading (dBuV/m)	Average Limit (dBuV/m)	Margin (dB)	Peak Limit (dBuV/m)	PK Margin (dB)	Azimuth (Degs)	Height (cm)	Polarity
1	* 5.15	42.91	Pk	34.1	-18.7	0	58.31	-	-	74	-15.69	332	115	H
2	* 5.148	44.03	Pk	34.1	-18.6	0	59.53	-	-	74	-14.47	332	115	H
3	* 5.15	33.54	RMS	34.1	-18.7	.42	49.36	54	-4.64	-	-	332	115	H
4	* 5.15	34.14	RMS	34.1	-18.7	.42	49.96	54	-4.04	-	-	332	115	H

* - indicates frequency in CFR47 Pt 15 / IC RSS-Restricted Band

Pk - Peak detector

RMS - RMS detection

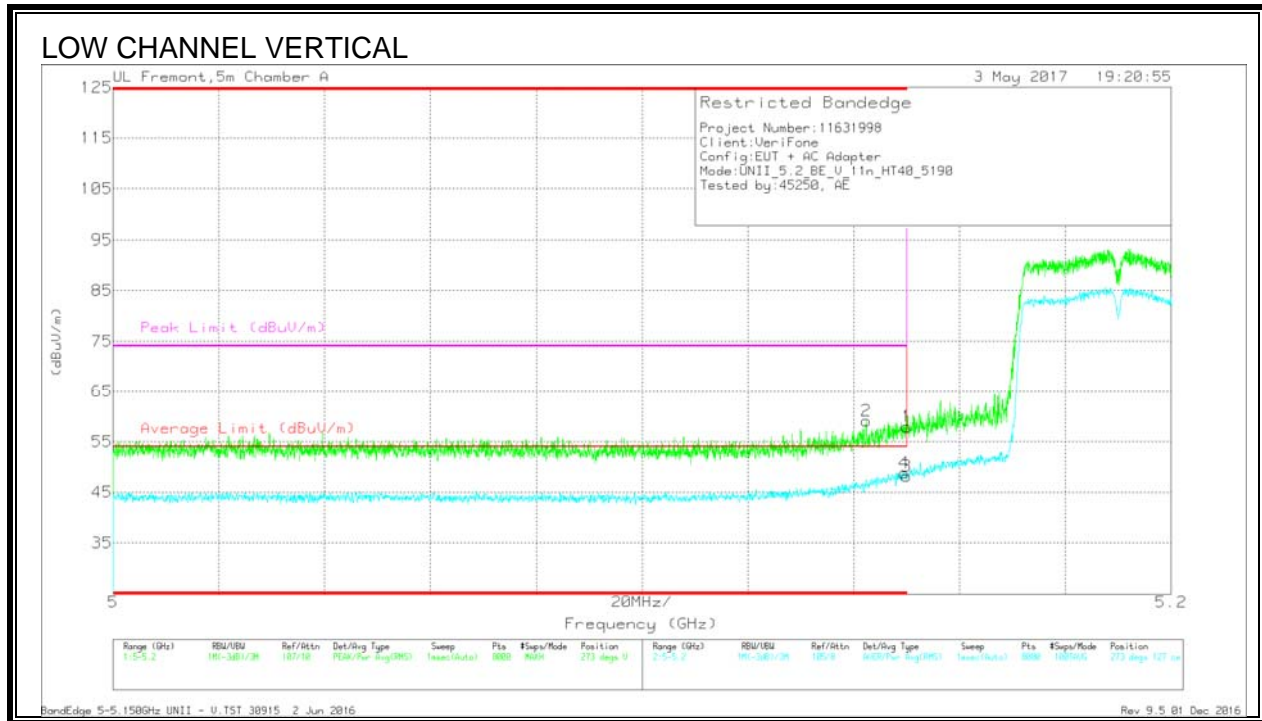

Trace Markers

Marker	Frequency (GHz)	Meter Reading (dBuV)	Det	AFT711 (dB/m)	Amp/Cbl/Filtr/Pad (dB)	DC Corr (dB)	Corrected Reading (dBuV/m)	Average Limit (dBuV/m)	Margin (dB)	Peak Limit (dBuV/m)	PK Margin (dB)	Azimuth (Degs)	Height (cm)	Polarity
1	* 5.15	42.53	Pk	34.1	-18.7	0	57.93	-	-	74	-16.07	273	127	V
2	* 5.142	43.66	Pk	34.1	-18.6	0	59.16	-	-	74	-14.84	273	127	V
3	* 5.15	32.38	RMS	34.1	-18.7	.42	48.2	54	-5.8	-	-	273	127	V
4	* 5.15	32.92	RMS	34.1	-18.6	.42	48.84	54	-5.16	-	-	273	127	V

* - indicates frequency in CFR47 Pt 15 / IC RSS-Restricted Band

Pk - Peak detector

RMS - RMS detection

HARMONICS AND SPURIOUS EMISSIONS

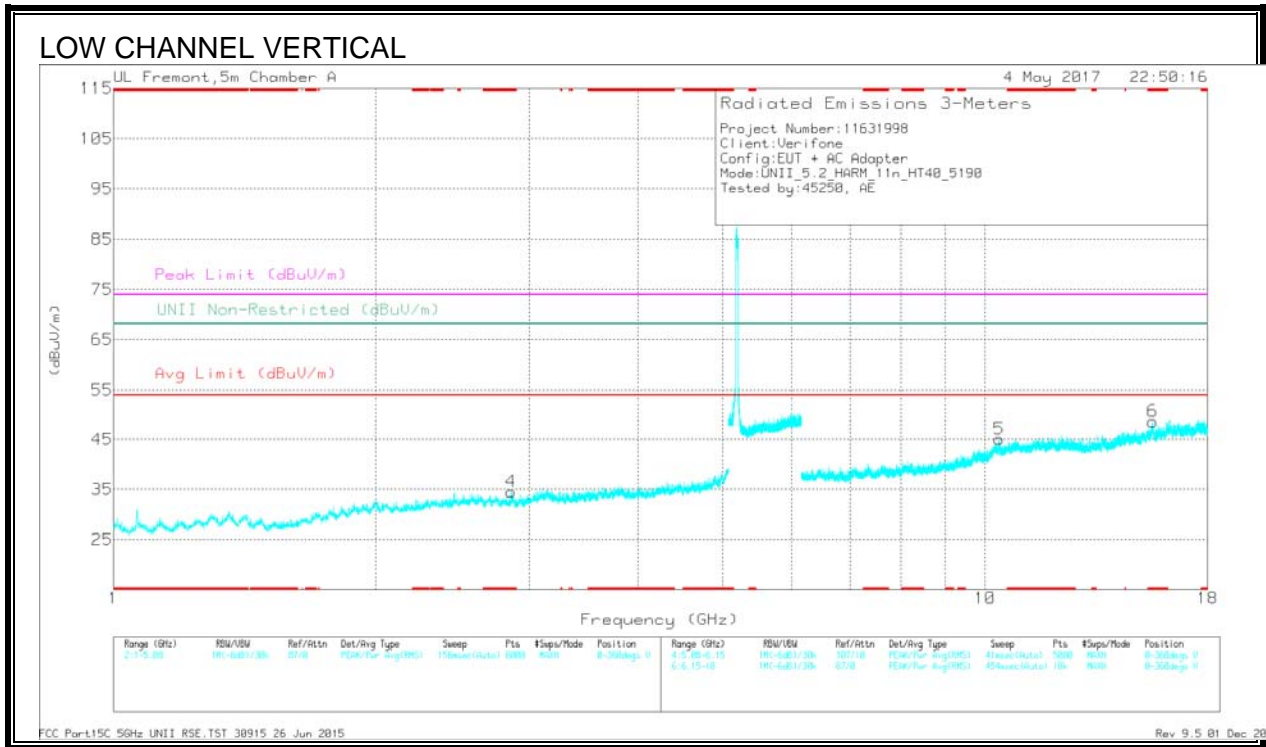
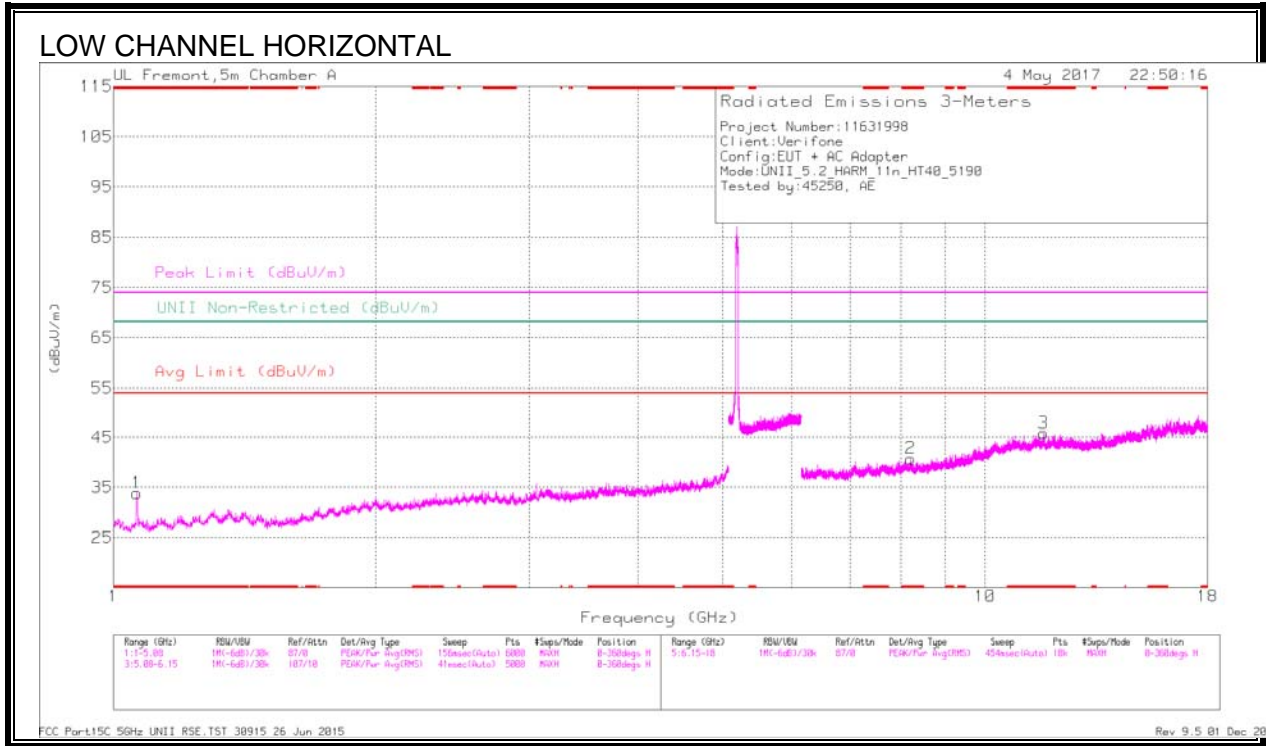

Trace Markers

Marker	Frequency (GHz)	Meter Reading (dBuV)	Det	AF T711 (dB/m)	Amp/Ch/Ftr/Pad (dB)	DC Corr (dB)	Corrected Reading (dBuV/m)	Avg Limit (dBuV/m)	Margin (dB)	Peak Limit (dBuV/m)	PK Margin (dB)	UNI Non-Restricted (dBuV/m)	PK Margin (dB)	Azimuth (Degs)	Height (cm)	Polarity
1	* 1.063	39.84	Pk	27.8	-33.8	0	33.84	-	-	74	-40.16	-	-	0-360	199	H
4	* 2.858	33.7	Pk	32.1	-31.3	0	34.5	-	-	74	-39.5	-	-	0-360	101	V
2	* 8.212	27.91	Pk	35.7	-22.9	0	40.71	-	-	74	-33.29	-	-	0-360	199	H
3	* 11.658	26.84	Pk	38.2	-19.2	0	45.84	-	-	74	-28.16	-	-	0-360	199	H
6	* 15.563	27.61	Pk	40.3	-19.4	0	48.51	-	-	74	-25.49	-	-	0-360	101	V
5	10.381	28.61	Pk	37.4	-21	0	45.01	-	-	-	-	68.2	-23.19	0-360	101	V

* - indicates frequency in CFR47 Pt 15 / IC RSS-Restricted Band
 Pk - Peak detector

Radiated Emissions

Frequency (GHz)	Meter Reading (dBuV)	Det	AF T711 (dB/m)	Amp/Ch/Ftr/Pad (dB)	DC Corr (dB)	Corrected Reading (dBuV/m)	Avg Limit (dBuV/m)	Margin (dB)	Peak Limit (dBuV/m)	PK Margin (dB)	UNI Non-Restricted (dBuV/m)	PK Margin (dB)	Azimuth (Degs)	Height (cm)	Polarity
* 1.064	46.22	PK-U	27.8	-33.8	0	40.22	-	-	74	-33.78	-	-	56	187	H
* 1.064	38.67	ADR	27.8	-33.8	.42	33.09	54	-20.91	-	-	-	-	56	187	H
* 2.857	39.68	PK-U	32.2	-31.4	0	40.48	-	-	74	-33.52	-	-	103	154	V
* 2.858	27.55	ADR	32.1	-31.3	.42	28.77	54	-25.23	-	-	-	-	103	154	V
* 8.211	32.97	PK-U	35.7	-22.9	0	45.77	-	-	74	-28.23	-	-	257	193	H
* 8.21	22.32	ADR	35.7	-22.9	.42	35.54	54	-18.46	-	-	-	-	257	193	H
* 11.659	32.12	PK-U	38.2	-19.3	0	51.02	-	-	74	-22.98	-	-	353	243	H
* 11.657	21.22	ADR	38.2	-19.2	.42	40.64	54	-13.36	-	-	-	-	353	243	H
* 15.565	33.84	PK-U	40.3	-19.3	0	54.84	-	-	74	-19.16	-	-	8	102	V
* 15.564	22.55	ADR	40.3	-19.3	.42	43.97	54	-10.03	-	-	-	-	8	102	V
10.382	35.79	PK-U	37.4	-21	0	52.19	-	-	-	-	68.2	-16.01	89	101	V

* - indicates frequency in CFR47 Pt 15 / IC RSS-Restricted Band
 PK-U - U-NII: Maximum Peak
 ADR - U-NII AD primary method, RMS average

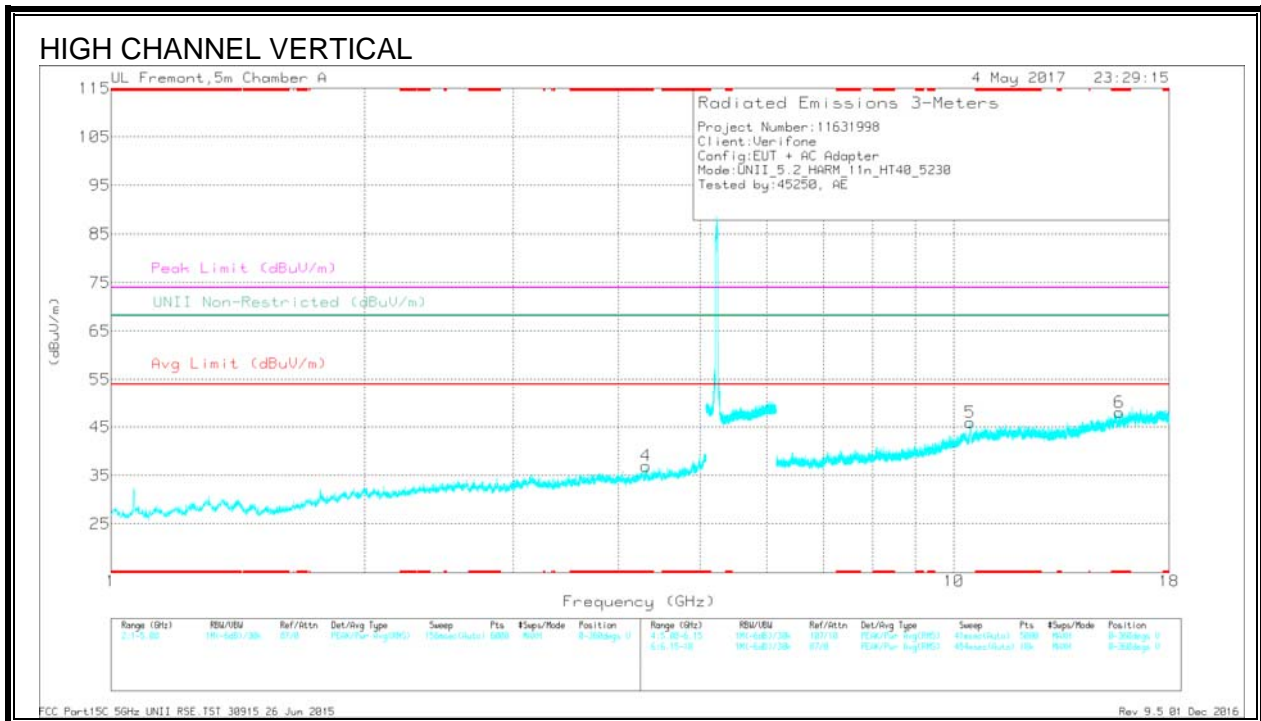
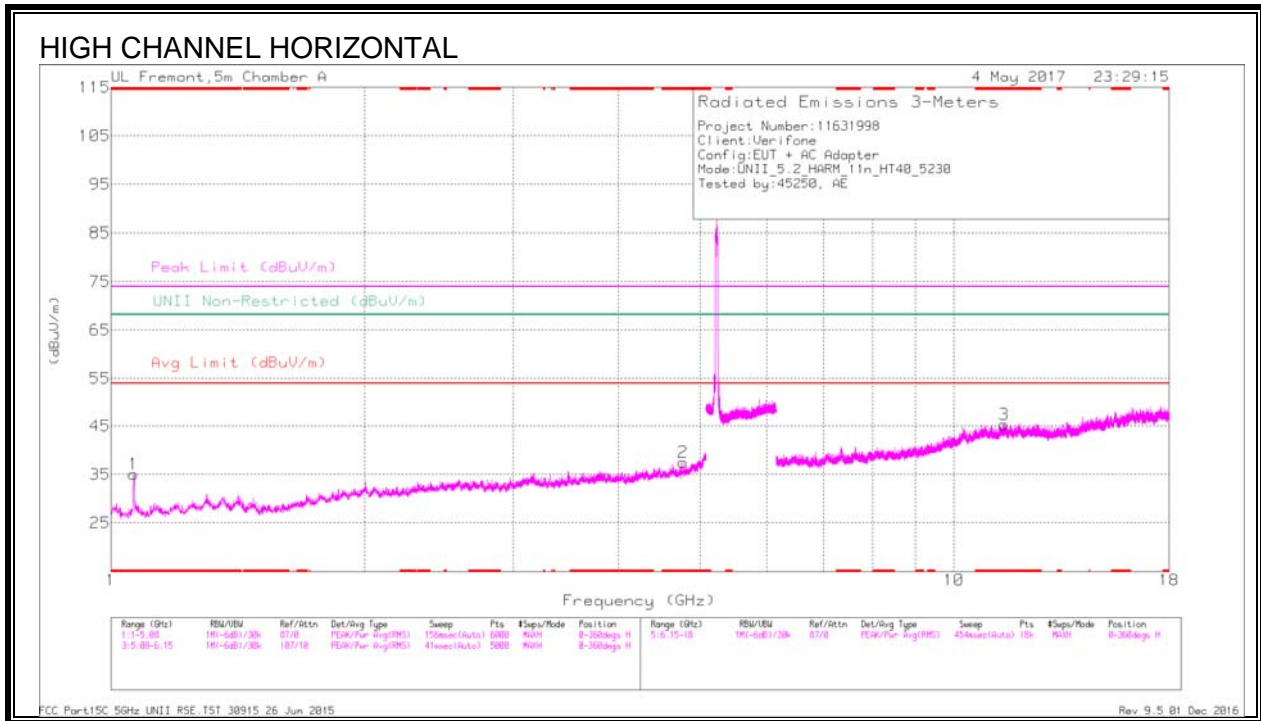

Trace Markers

Marker	Frequency (GHz)	Meter Reading (dBuV)	Det	AF T711 (dB/m)	Amp/Ch/Flt/Psd (dB)	DC Corr (dB)	Corrected Reading (dBuV/m)	Avg Limit (dBuV/m)	Margin (dB)	Peak Limit (dBuV/m)	PK Margin (dB)	UNII Non-Restricted (dBuV/m)	PK Margin (dB)	Asimuth (Degs)	Height (cm)	Polarity
1	* 1.064	41.06	Pk	27.8	-33.8	0	35.06	-	-	74	-38.94	-	-	0-360	199	H
2	* 4.769	32.08	Pk	33.9	-28.4	0	37.58	-	-	74	-36.42	-	-	0-360	199	H
4	* 4.314	32.44	Pk	33.4	-28.9	0	36.94	-	-	74	-37.06	-	-	0-360	101	V
3	* 11.47	26.79	Pk	38	-19.5	0	45.29	-	-	74	-28.71	-	-	0-360	199	H
6	* 15.702	28.76	Pk	40.4	-21.1	0	48.06	-	-	74	-25.94	-	-	0-360	101	V
5	10.458	29.17	Pk	37.5	-20.7	0	45.97	-	-	-	-	68.2	-22.23	0-360	101	V

* - indicates frequency in CFR47 Pt 15 / IC RSS-Restricted Band
 Pk - Peak detector

Radiated Emissions

Frequency (GHz)	Meter Reading (dBuV)	Det	AF T711 (dB/m)	Amp/Ch/Flt/Psd (dB)	DC Corr (dB)	Corrected Reading (dBuV/m)	Avg Limit (dBuV/m)	Margin (dB)	Peak Limit (dBuV/m)	PK Margin (dB)	UNII Non-Restricted (dBuV/m)	PK Margin (dB)	Asimuth (Degs)	Height (cm)	Polarity
* 1.064	46.66	PK-U	27.8	-33.8	0	40.66	-	-	74	-33.34	-	-	201	192	H
* 1.064	38.2	ADR	27.8	-33.8	42	32.62	54	-21.38	-	-	-	-	201	192	H
* 4.771	36.85	PK-U	33.9	-28.4	0	42.35	-	-	74	-31.65	-	-	6	233	H
* 4.77	25.37	ADR	33.9	-28.4	42	31.29	54	-22.71	-	-	-	-	6	233	H
* 4.315	37.85	PK-U	33.4	-28.9	0	42.35	-	-	74	-31.65	-	-	168	166	V
* 4.315	26.57	ADR	33.4	-28.9	42	31.49	54	-22.51	-	-	-	-	168	166	V
* 11.468	32.24	PK-U	38	-19.6	0	50.64	-	-	74	-23.36	-	-	28	239	H
* 11.471	20.92	ADR	38	-19.5	42	39.84	54	-14.16	-	-	-	-	28	239	H
* 15.703	34.93	PK-U	40.4	-21.1	0	54.23	-	-	74	-19.77	-	-	2	101	V
* 15.701	23.05	ADR	40.4	-21.1	42	42.77	54	-11.23	-	-	-	-	2	101	V
10.46	36.54	PK-U	37.5	-20.7	0	53.34	-	-	-	-	68.2	-14.86	316	102	V

* - indicates frequency in CFR47 Pt 15 / IC RSS-Restricted Band
 PK-U - U-NII: Maximum Peak
 ADR - U-NII AD primary method, RMS average

9.1.4. 11ac VHT80 MODE IN THE 5.2GHz BAND

BANDEDGE (MID CHANNEL)

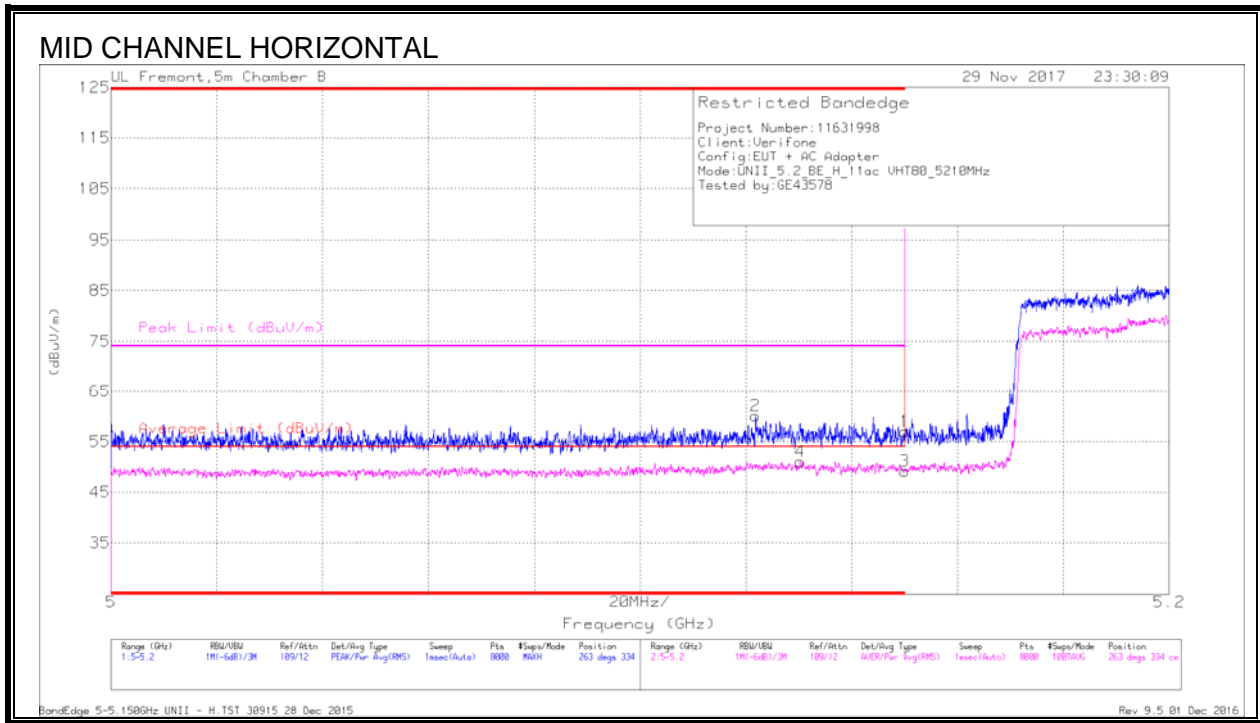

Trace Markers

Marker	Frequency (GHz)	Meter Reading (dBuV)	Det	AF T863 (dB/m)	Amp/Cb/Flt/Pad (dB)	DC Corr (dB)	Corrected Reading (dBuV/m)	Average Limit (dBuV/m)	Margin (dB)	Peak Limit (dBuV/m)	PK Margin (dB)	Azimuth (Degs)	Height (cm)	Polarity
1	* 5.15	40.4	Pk	34.4	-17.8	0	57	-	-	74	-17	263	334	H
2	* 5.122	42.72	PK	34.4	-17	0	60.12	-	-	74	-13.88	263	334	H
3	* 5.15	31.44	RMS	34.4	-17.8	1.18	49.22	54	-4.78	-	-	263	334	H
4	* 5.13	32.56	RMS	34.4	-17.1	1.18	51.04	54	-2.96	-	-	263	334	H

* - indicates frequency in CFR47 Pt 15 / IC RSS-Restricted Band

Pk - Peak detector

RMS - RMS detection

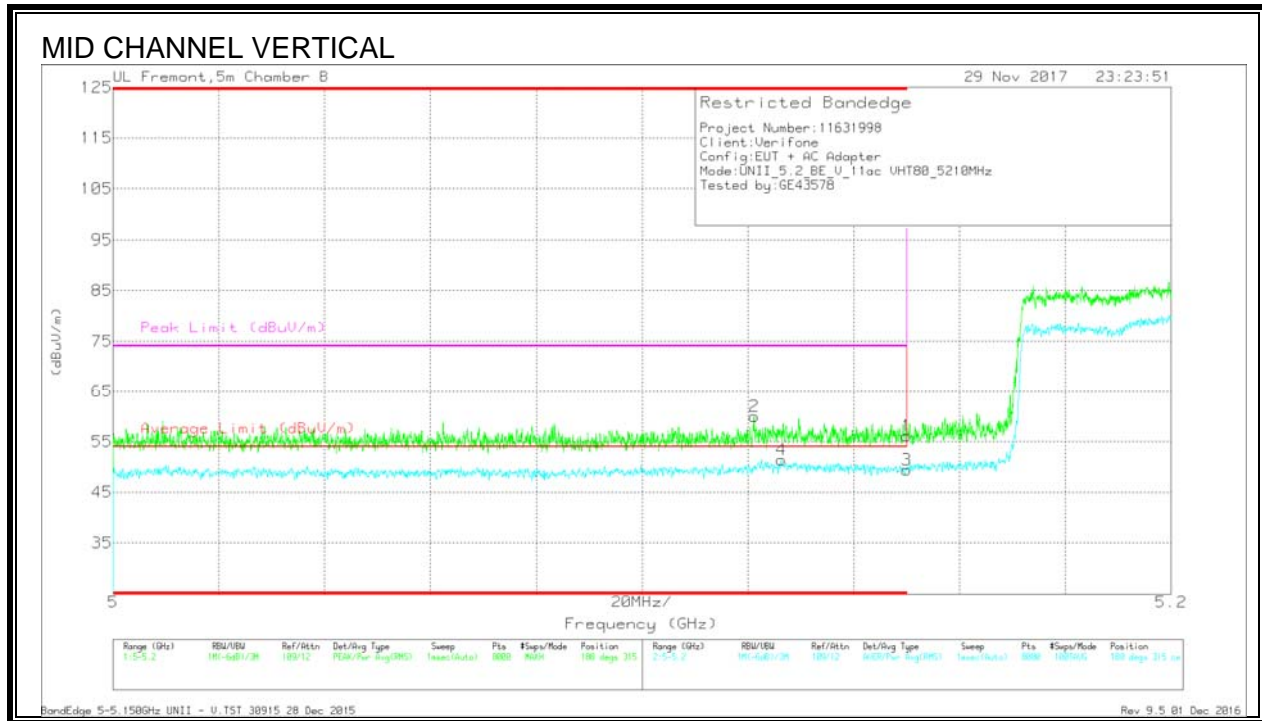

Trace Markers

Marker	Frequency (GHz)	Meter Reading (dBuV)	Det	AF T863 (dB/m)	Amp/Cbl/Fitr/Pad (dB)	DC Corr (dB)	Corrected Reading (dBuV/m)	Average Limit (dBuV/m)	Margin (dB)	Peak Limit (dBuV/m)	PK Margin (dB)	Azimuth (Degs)	Height (cm)	Polarity
1	* 5.15	39.51	Pk	34.4	-17.8	0	56.11	-	-	74	-17.89	188	315	V
2	* 5.121	42.58	Pk	34.4	-17	0	59.98	-	-	74	-14.02	188	315	V
3	* 5.15	31.65	RMS	34.4	-17.8	1.18	49.43	54	-4.57	-	-	188	315	V
4	* 5.126	32.71	RMS	34.4	-16.9	1.18	51.39	54	-2.61	-	-	188	315	V

* - indicates frequency in CFR47 Pt 15 / IC RSS-Restricted Band

Pk - Peak detector

RMS - RMS detection

HARMONICS AND SPURIOUS EMISSIONS

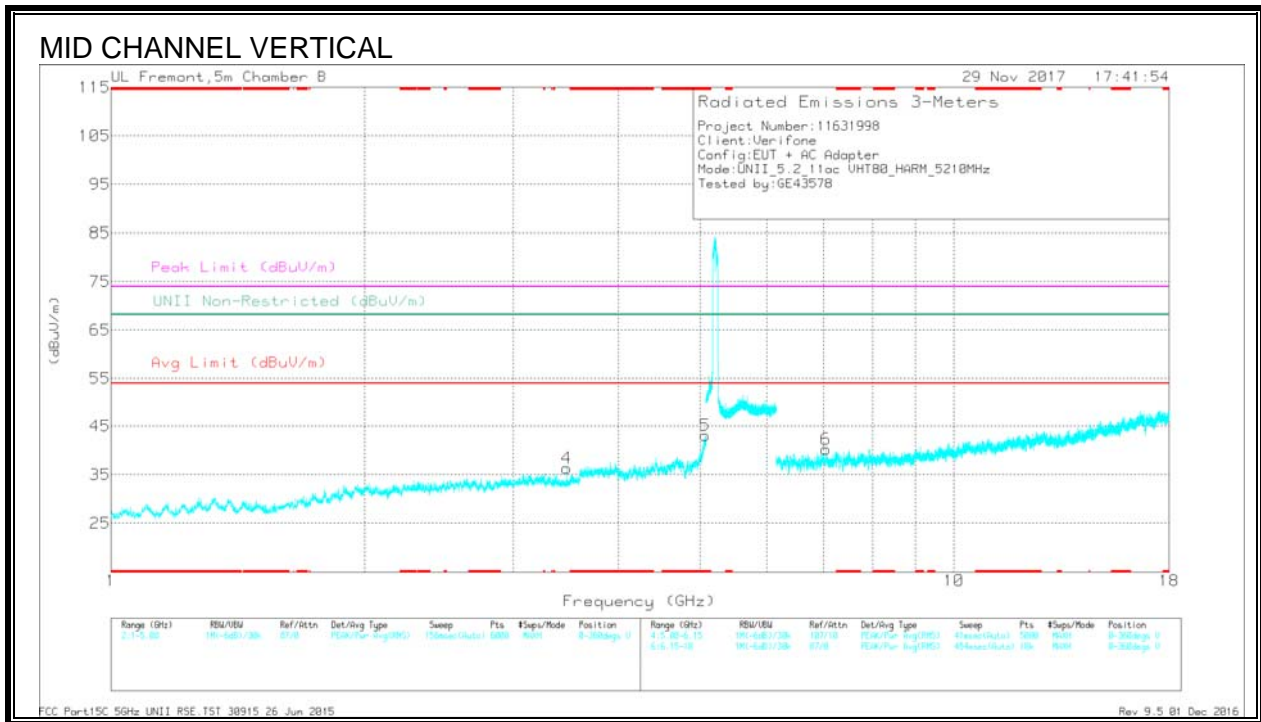
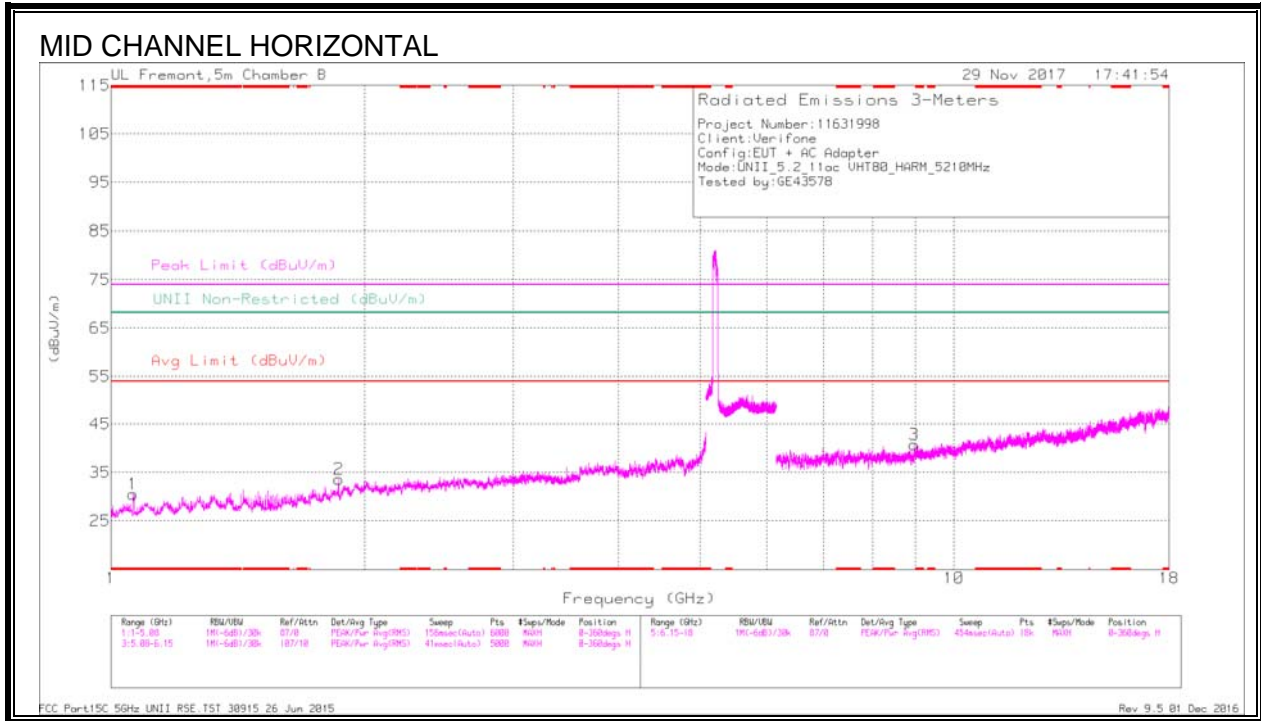

Radiated Emissions

Marker	Frequency (GHz)	Meter Reading (dBuV)	Det	AF T863 (dB/m)	Amp/Cb/Filtr/Pad (dB)	DC Corr (dB)	Corrected Reading (dBuV/m)	Avg Limit (dBuV/m)	Margin (dB)	Peak Limit (dBuV/m)	PK Margin (dB)	UNII Non-Restricted (dBuV/m)	PK Margin (dB)	Azimuth (Degs)	Height (cm)	Polarity
1	* 1.064	45.17	PK-U	27.2	-34.1	0	38.27	-	-	74	-35.73	-	-	338	199	H
	* 1.064	34.55	ADR	27.2	-34.1	1.18	28.83	54	-25.17	-	-	-	-	338	199	H
5	* 5.068	42.44	PK-U	34.4	-26.9	0	49.94	-	-	74	-24.06	-	-	338	104	V
	* 5.069	29.57	ADR	34.4	-26.9	1.18	38.25	54	-15.75	-	-	-	-	338	104	V
2	1.862	42.19	PK-U	30.8	-33.2	0	39.79	-	-	-	-	68.2	-28.41	40	199	H
4	3.473	40.45	PK-U	32.7	-31.4	0	41.75	-	-	-	-	68.2	-26.45	12	104	V
6	7.055	37.06	PK-U	35.9	-26.8	0	46.16	-	-	-	-	68.2	-22.04	277	199	V
3	8.976	34.58	PK-U	36.2	-24.5	0	46.28	-	-	-	-	68.2	-21.92	301	104	H

* - indicates frequency in CFR47 Pt 15 / IC RSS-Restricted Band

PK-U - U-NII: Maximum Peak

ADR - U-NII AD primary method, RMS average

9.1.5. 11a MODE IN THE 5.3GHz BAND

AUTHORIZED BANDEDGE (HIGH CHANNEL)

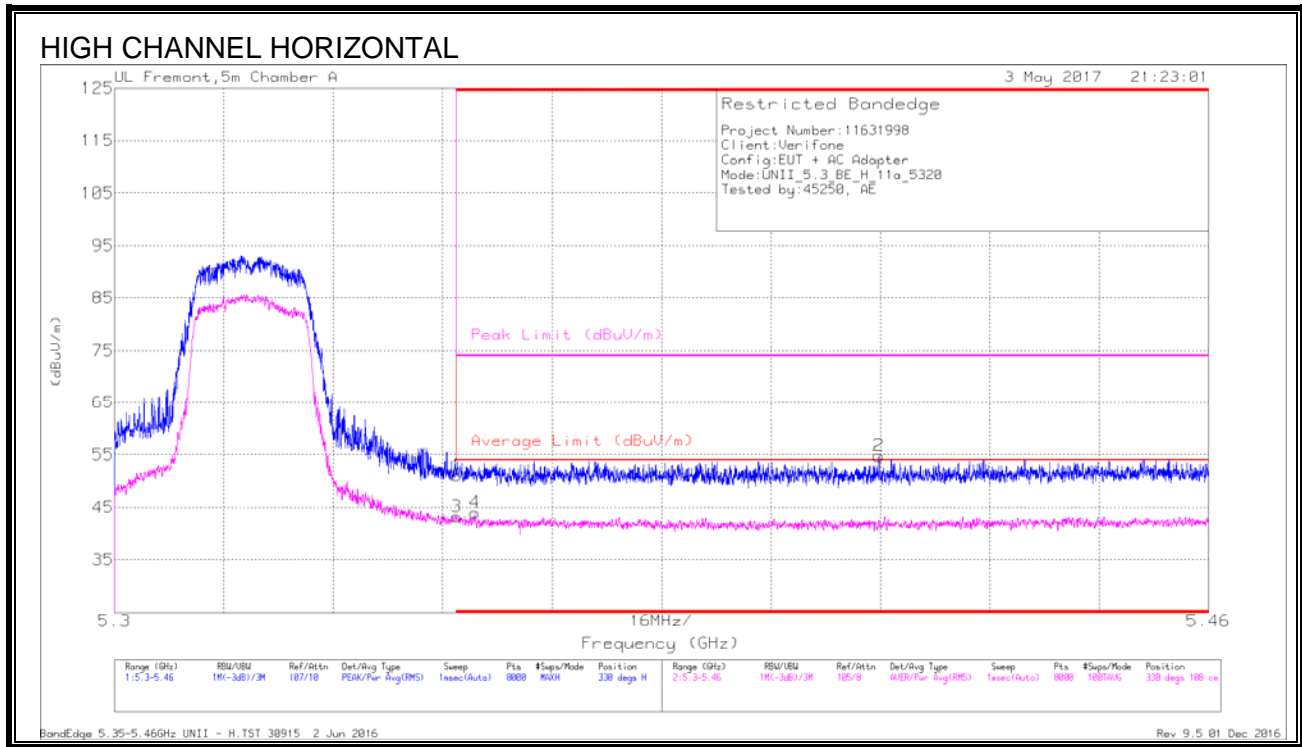

Trace Markers

Marker	Frequency (GHz)	Meter Reading (dBuV)	Det	AF T711 (dB/m)	Amp/Cb/Filtr/ Pad (dB)	DC Corr (dB)	Corrected Reading (dBuV/m)	Average Limit (dBuV/m)	Margin (dB)	Peak Limit (dBuV/m)	PK Margin (dB)	Azimuth (Degs)	Height (cm)	Polarity
1	* 5.35	35.66	Pk	34.3	-18.9	0	51.06	-	-	74	-22.94	330	108	H
3	* 5.35	27.52	RMS	34.3	-18.9	.29	43.21	54	-10.79	-	-	330	108	H
4	* 5.353	28.12	RMS	34.3	-18.8	.29	43.91	54	-10.09	-	-	330	108	H
2	* 5.412	39.41	Pk	34.3	-18.9	0	54.81	-	-	74	-19.19	330	108	H

* - indicates frequency in CFR47 Pt 15 / IC RSS-Restricted Band

Pk - Peak detector

RMS - RMS detection

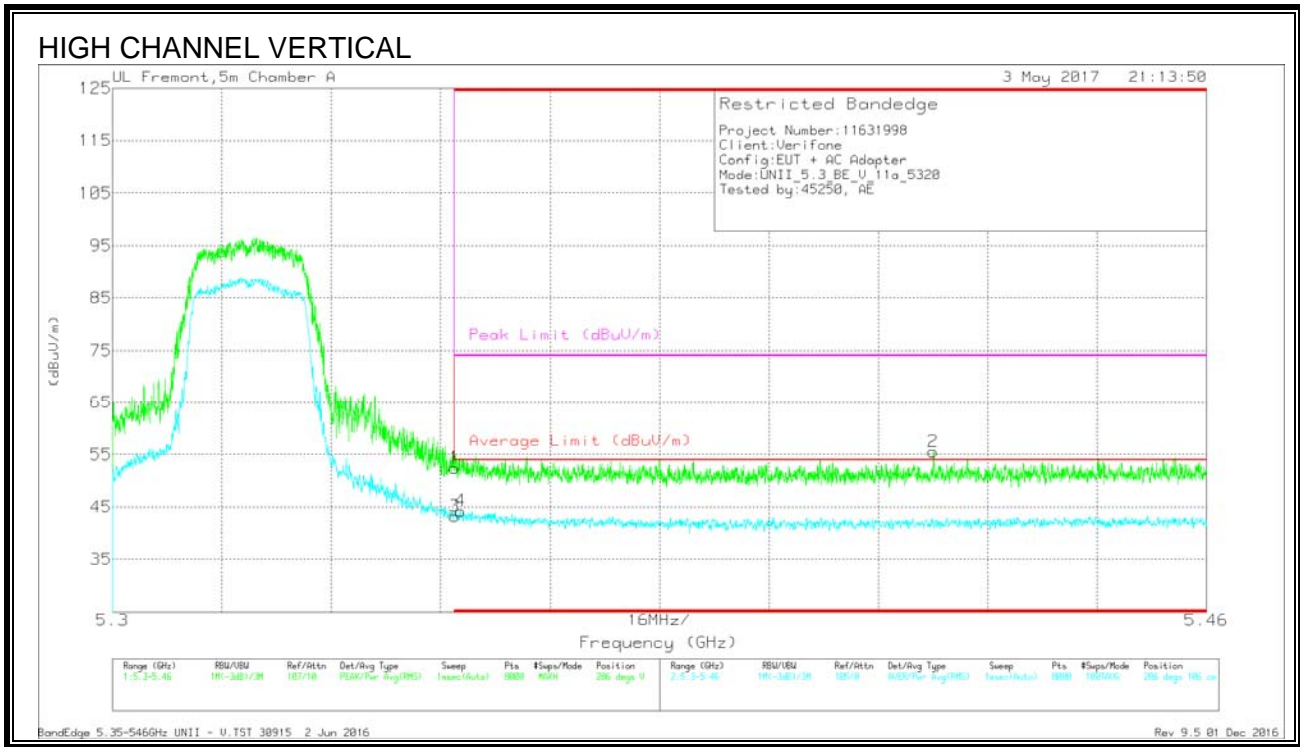

Trace Markers

Marker	Frequency (GHz)	Meter Reading (dBuV)	Det	AF T711 (dB/m)	Amp/Cb/Filtr/Pad (dB)	DC Corr (dB)	Corrected Reading (dBuV/m)	Average Limit (dBuV/m)	Margin (dB)	Peak Limit (dBuV/m)	PK Margin (dB)	Azimuth (Degs)	Height (cm)	Polarity
1	* 5.35	37.04	Pk	34.3	-18.9	0	52.44	-	-	74	-21.56	286	106	V
3	* 5.35	27.53	RMS	34.3	-18.9	.29	43.22	54	-10.78	-	-	286	106	V
4	* 5.351	28.57	RMS	34.3	-18.9	.29	44.26	54	-9.74	-	-	286	106	V
2	* 5.42	40.16	Pk	34.3	-18.9	0	55.56	-	-	74	-18.44	286	106	V

* - indicates frequency in CFR47 Pt 15 / IC RSS-Restricted Band

Pk - Peak detector

RMS - RMS detection

HARMONICS AND SPURIOUS EMISSIONS

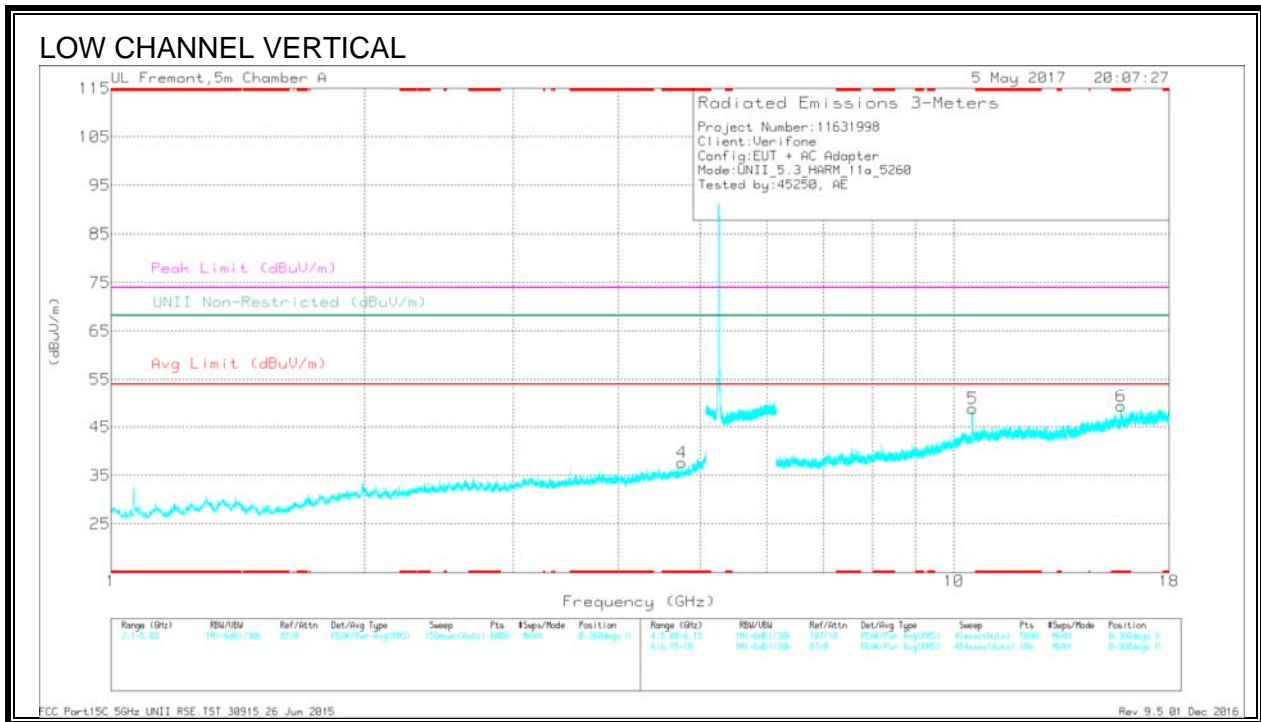
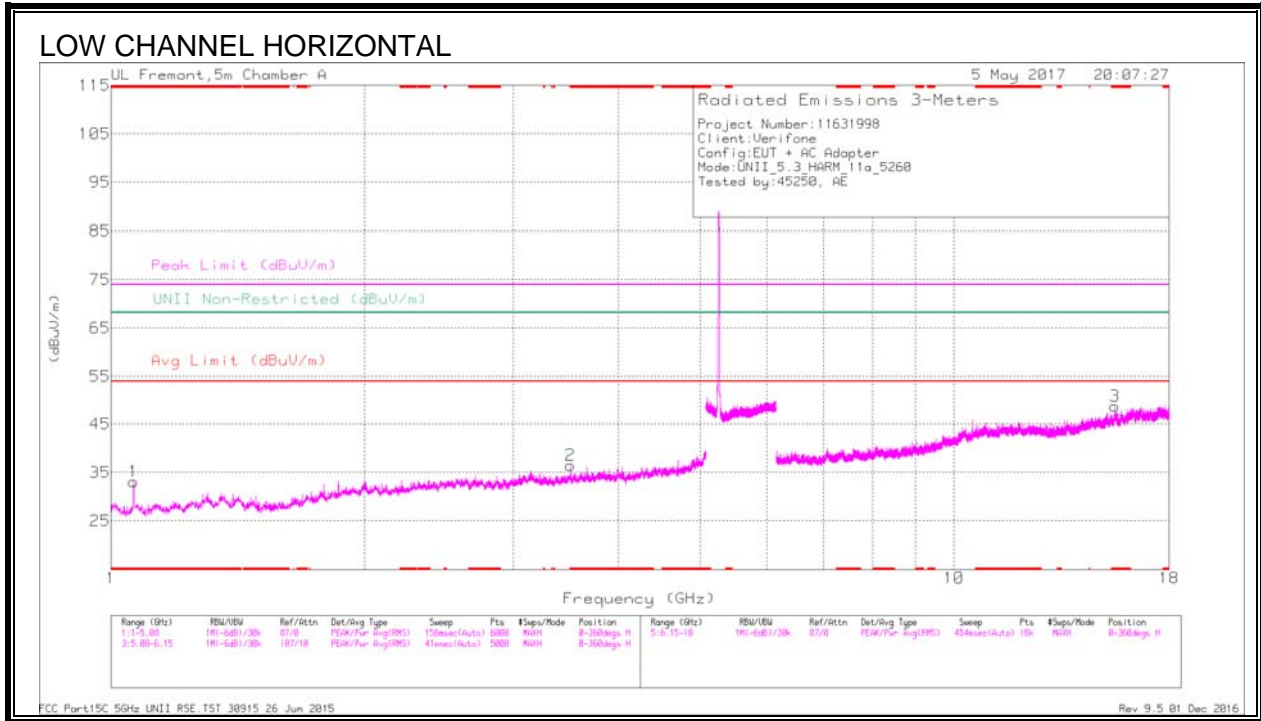

Trace Markers

Marker	Frequency (GHz)	Meter Reading (dBuV)	Det	AF T711 (dB/m)	Amp/CM/ftz/Pad (dB)	DC Corr (dB)	Corrected Reading (dBuV/m)	Aug Limit (dBuV/m)	Margin (dB)	Peak Limit (dBuV/m)	PK Margin (dB)	UNII Non-Restricted (dBuV/m)	PK Margin (dB)	Aimuth (Degs)	Height (cm)	Polarity
1	* 1.063	39.11	Pk	27.8	-33.8	0	33.11	-	-	74	-40.89	-	-	0-360	199	H
2	* 3.507	33.73	Pk	33	-30.3	0	36.43	-	-	74	-37.57	-	-	0-360	101	H
4	* 4.758	32.24	Pk	33.9	-28.5	0	37.64	-	-	74	-36.36	-	-	0-360	200	V
3	* 15.528	27.34	Pk	40.3	-19	0	48.64	-	-	74	-25.36	-	-	0-360	199	H
6	* 15.779	29.11	Pk	40.5	-20.3	0	49.31	-	-	74	-24.69	-	-	0-360	101	V
5	10.523	31.86	Pk	37.6	-20.7	0	48.76	-	-	-	-	68.2	-19.44	0-360	101	V

* - indicates frequency in CFR47 Pt 15 / IC RSS-Restricted Band
 Pk - Peak detector

Radiated Emissions

Frequency (GHz)	Meter Reading (dBuV)	Det	AF T711 (dB/m)	Amp/CM/ftz/Pad (dB)	DC Corr (dB)	Corrected Reading (dBuV/m)	Aug Limit (dBuV/m)	Margin (dB)	Peak Limit (dBuV/m)	PK Margin (dB)	UNII Non-Restricted (dBuV/m)	PK Margin (dB)	Aimuth (Degs)	Height (cm)	Polarity
* 1.063	45.42	PK-U	27.8	-33.9	0	39.32	-	-	74	-34.68	-	-	193	334	H
* 1.065	36.16	ADR	27.8	-33.8	29	30.45	54	-23.55	-	-	-	-	193	334	H
* 3.508	37.54	PK-U	33	-30.4	0	40.14	-	-	74	-33.86	-	-	141	280	H
* 3.509	26.68	ADR	33	-30.4	29	29.57	54	-24.43	-	-	-	-	141	280	H
* 4.757	36.79	PK-U	33.9	-28.5	0	42.19	-	-	74	-31.81	-	-	78	226	V
* 4.757	25.8	ADR	33.9	-28.5	29	31.49	54	-22.51	-	-	-	-	78	226	V
* 15.528	32.34	PK-U	40.3	-18.9	0	53.74	-	-	74	-20.26	-	-	15	181	H
* 15.53	21.22	ADR	40.3	-19	29	42.81	54	-11.19	-	-	-	-	15	181	H
* 15.781	37.69	PK-U	40.5	-20.2	0	57.99	-	-	74	-16.01	-	-	7	102	V
* 15.781	25.22	ADR	40.5	-20.2	29	45.81	54	-8.19	-	-	-	-	7	102	V
10.522	39.19	PK-U	37.6	-20.7	0	56.09	-	-	-	-	68.2	-12.11	312	103	V

* - indicates frequency in CFR47 Pt 15 / IC RSS-Restricted Band
 PK-U - U-NII: Maximum Peak
 ADR - U-NII AD primary method, RMS average

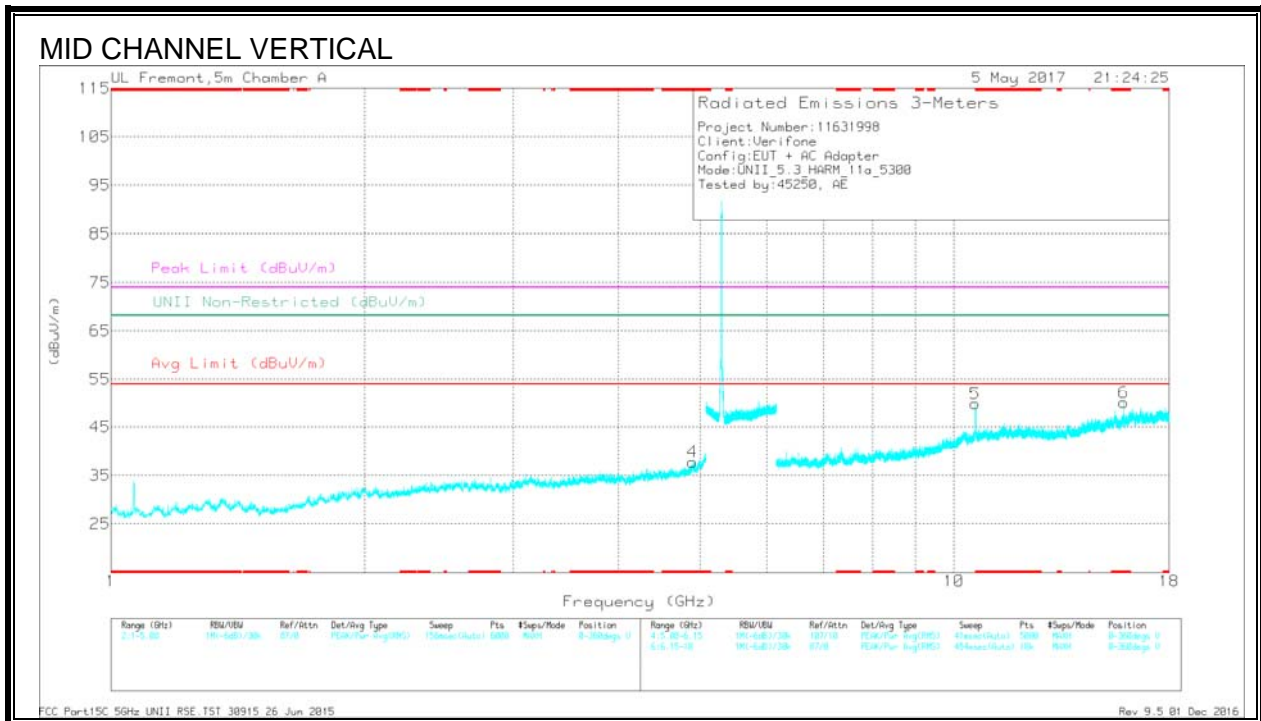
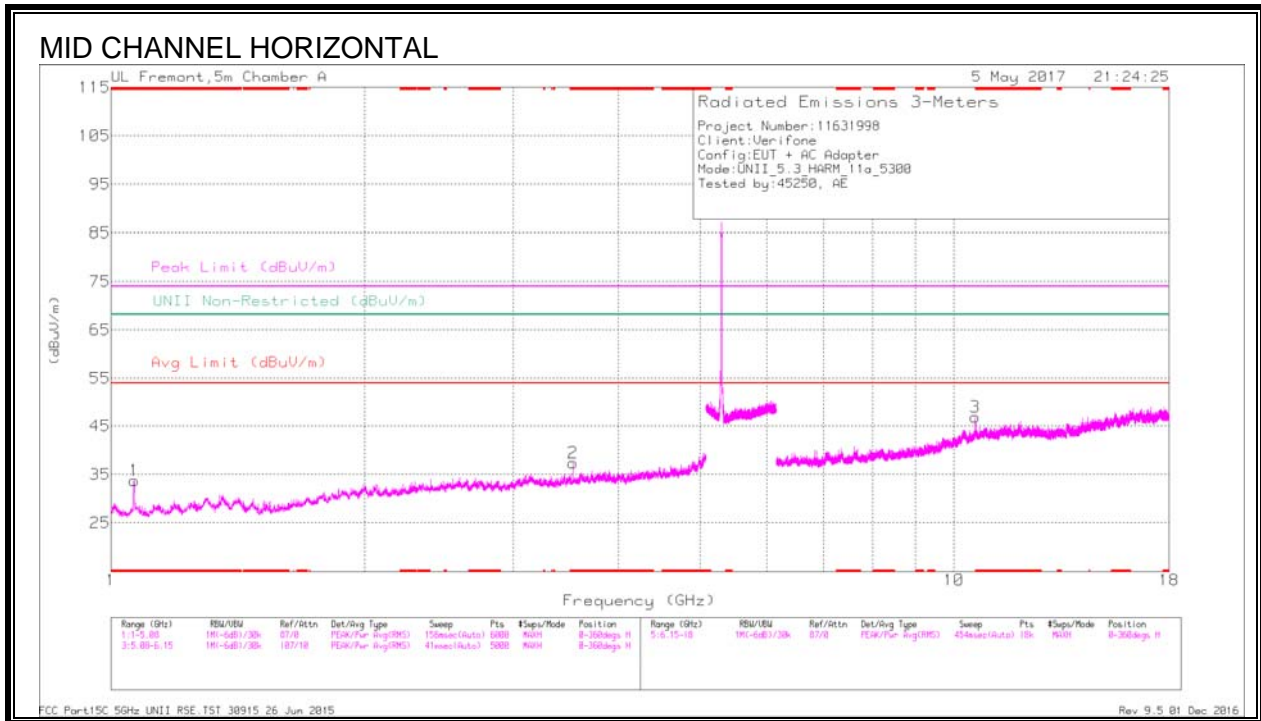

Trace Markers

Marker	Frequency (GHz)	Meter Reading (dBuV)	Det	AF T711 (dB/m)	Amp/Cb/Pk/Pad (dB)	DC Corr (dB)	Corrected Reading (dBuV/m)	Avg Limit (dBuV/m)	Margin (dB)	Peak Limit (dBuV/m)	PK Margin (dB)	UNII Non-Restricted (dBuV/m)	PK Margin (dB)	Aimuth (Degs)	Height (cm)	Polarity
1	* 1.065	39.79	Pk	27.8	-33.8	0	33.79	-	-	74	-40.21	-	-	0-360	102	H
2	* 3.533	34.91	Pk	33	-30.5	0	37.41	-	-	74	-36.59	-	-	0-360	102	H
4	* 4.895	31.21	Pk	34	-27.4	0	37.81	-	-	74	-36.19	-	-	0-360	200	V
3	* 10.603	29.61	Pk	37.8	-20.5	0	46.91	-	-	74	-27.09	-	-	0-360	101	H
6	* 15.902	30.07	Pk	40.6	-20.5	0	50.17	-	-	74	-23.83	-	-	0-360	101	V
5	10.6	32.43	Pk	37.8	-20.4	0	49.83	-	-	-	-	68.2	-18.37	0-360	101	V

* - indicates frequency in CFR47 Pt 15 / IC RSS-Restricted Band
 Pk - Peak detector

Radiated Emissions

Frequency (GHz)	Meter Reading (dBuV)	Det	AF T711 (dB/m)	Amp/Cb/Pk/Pad (dB)	DC Corr (dB)	Corrected Reading (dBuV/m)	Avg Limit (dBuV/m)	Margin (dB)	Peak Limit (dBuV/m)	PK Margin (dB)	UNII Non-Restricted (dBuV/m)	PK Margin (dB)	Aimuth (Degs)	Height (cm)	Polarity
* 1.064	46.47	PK-U	27.8	-33.8	0	40.47	-	-	74	-33.53	-	-	195	184	H
* 1.064	38.48	ADR	27.8	-33.8	29	32.77	54	-21.23	-	-	-	-	195	184	H
* 3.533	40.99	PK-U	33	-30.5	0	43.49	-	-	74	-30.51	-	-	10	110	H
* 3.533	32.49	ADR	33	-30.5	29	35.28	54	-18.72	-	-	-	-	10	110	H
* 4.895	37.25	PK-U	34	-27.4	0	43.85	-	-	74	-30.15	-	-	4	152	V
* 4.895	26.22	ADR	34	-27.4	29	33.11	54	-20.89	-	-	-	-	4	152	V
* 10.603	36.78	PK-U	37.8	-20.5	0	54.08	-	-	74	-19.92	-	-	67	103	H
* 10.602	25.21	ADR	37.8	-20.4	29	42.9	54	-11.1	-	-	-	-	67	103	H
* 15.903	39.69	PK-U	40.6	-20.5	0	59.79	-	-	74	-14.21	-	-	5	101	V
* 15.901	25.25	ADR	40.6	-20.5	29	45.64	54	-8.36	-	-	-	-	5	101	V
10.599	39.54	PK-U	37.8	-20.4	0	56.94	-	-	-	-	68.2	-11.26	313	110	V

* - indicates frequency in CFR47 Pt 15 / IC RSS-Restricted Band
 PK-U - U-NII: Maximum Peak
 ADR - U-NII AD primary method, RMS average

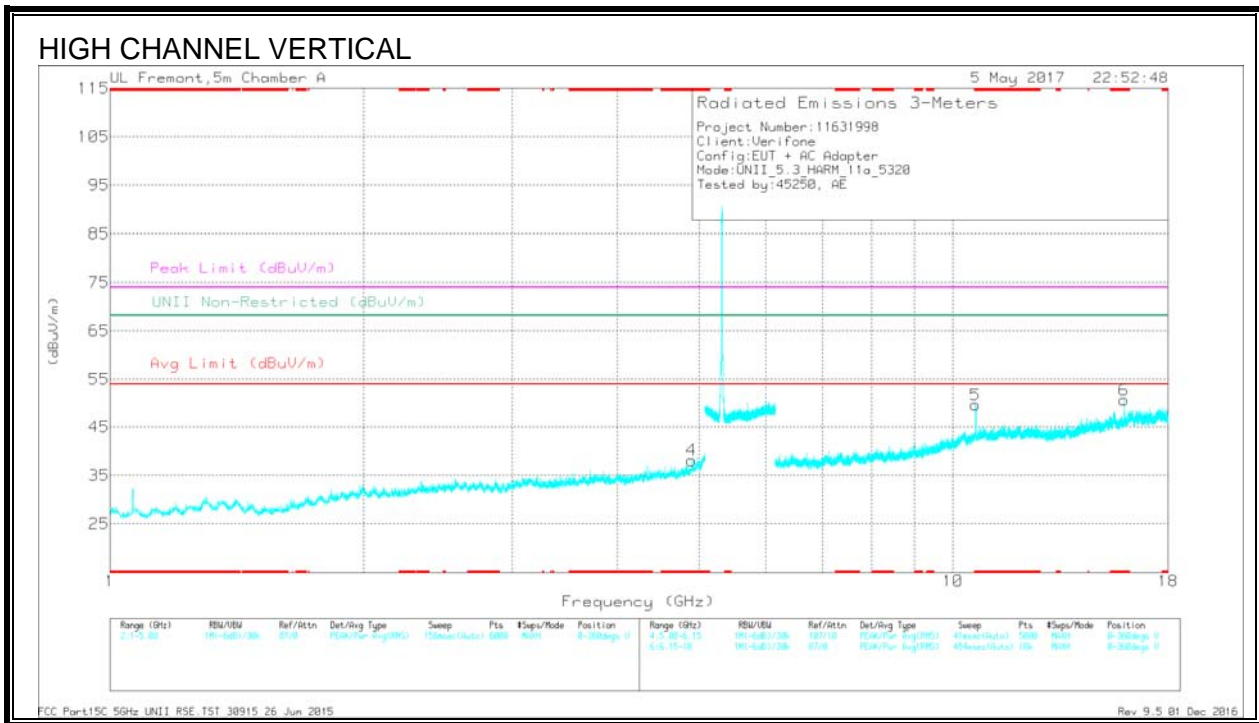
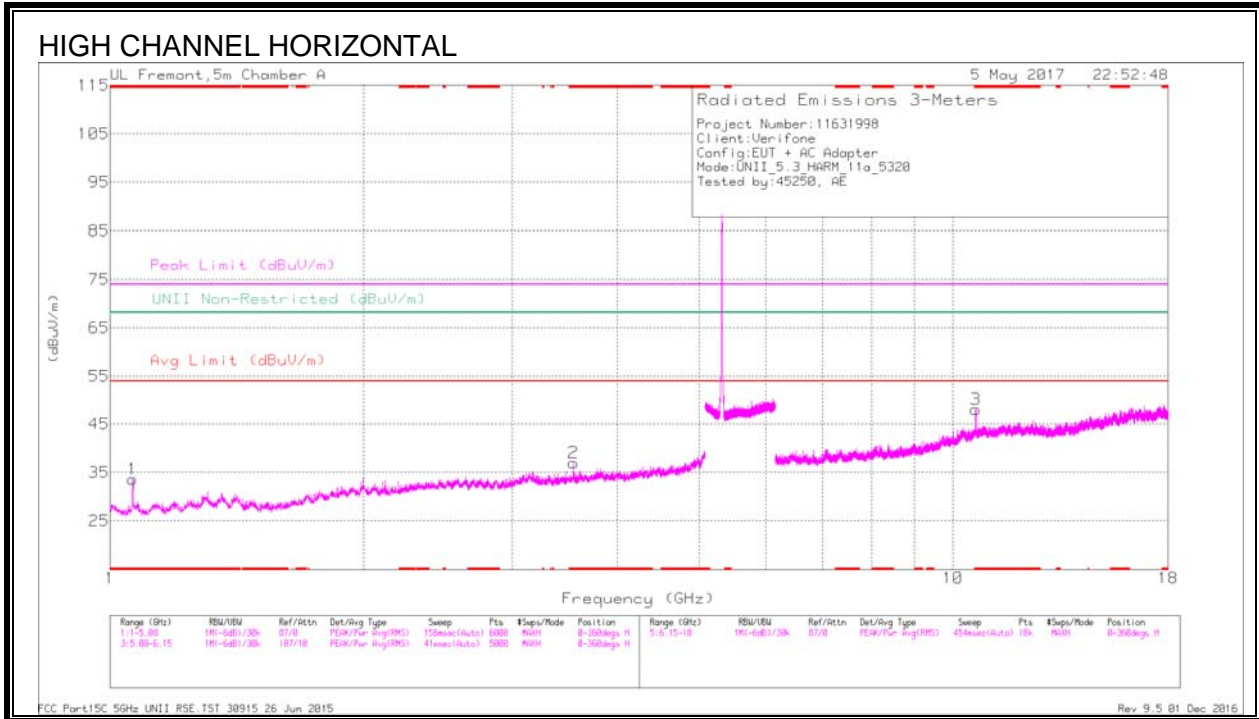

Trace Markers

Marker	Frequency (GHz)	Meter Reading (dBuV)	Det	AF 1711 (dB/m)	Amp/CS/Flt/Pad (dB)	DC Corr (dB)	Corrected Reading (dBuV/m)	Avg Limit (dBuV/m)	Margin (dB)	Peak Limit (dBuV/m)	PK Margin (dB)	UNII Non-Restricted (dBuV/m)	PK Margin (dB)	Asimuth (Degs)	Height (cm)	Polarity
1	* 1.064	39.63	Pk	27.8	-33.8	0	33.63	-	-	74	-40.37	-	-	0-360	199	H
2	* 3.547	34.61	Pk	33	-30.6	0	37.01	-	-	74	-36.99	-	-	0-360	101	H
4	* 4.897	31.51	Pk	34	-27.4	0	38.11	-	-	74	-35.89	-	-	0-360	200	V
3	* 10.642	30.86	Pk	37.8	-20.6	0	48.06	-	-	74	-25.94	-	-	0-360	101	H
5	* 10.635	32.37	Pk	37.8	-20.6	0	49.57	-	-	74	-24.43	-	-	0-360	101	V
6	* 15.963	30.37	Pk	40.8	-20.5	0	50.67	-	-	74	-23.33	-	-	0-360	101	V

* - indicates frequency in CFR47 Pt 15 / IC RSS-Restricted Band
 Pk - Peak detector

Radiated Emissions

Frequency (GHz)	Meter Reading (dBuV)	Det	AF 1711 (dB/m)	Amp/CS/Flt/Pad (dB)	DC Corr (dB)	Corrected Reading (dBuV/m)	Avg Limit (dBuV/m)	Margin (dB)	Peak Limit (dBuV/m)	PK Margin (dB)	UNII Non-Restricted (dBuV/m)	PK Margin (dB)	Asimuth (Degs)	Height (cm)	Polarity
* 1.065	46.16	PK-U	27.8	-33.8	0	40.16	-	-	74	-33.84	-	-	49	185	H
* 1.064	37.73	ADR	27.8	-33.8	-29	32.02	54	-21.98	-	-	-	-	49	185	H
* 3.547	40.97	PK-U	33	-30.6	0	43.37	-	-	74	-30.63	-	-	9	107	H
* 3.547	32.94	ADR	33	-30.6	-29	35.63	54	-18.37	-	-	-	-	9	107	H
* 4.896	37.57	PK-U	34	-27.4	0	44.17	-	-	74	-29.83	-	-	68	129	V
* 4.897	25.95	ADR	34	-27.4	-29	32.84	54	-21.16	-	-	-	-	68	129	V
* 10.642	37.6	PK-U	37.8	-20.6	0	54.8	-	-	74	-19.2	-	-	70	101	H
* 10.642	26.02	ADR	37.8	-20.6	-29	43.51	54	-10.49	-	-	-	-	70	101	H
* 10.637	39.85	PK-U	37.8	-20.6	0	57.05	-	-	74	-16.95	-	-	311	110	V
* 10.636	28.73	ADR	37.8	-20.6	-29	46.22	54	-7.78	-	-	-	-	311	110	V
* 15.963	37.83	PK-U	40.8	-20.5	0	58.13	-	-	74	-15.87	-	-	4	104	V
* 15.962	24.65	ADR	40.8	-20.5	-29	45.24	54	-8.76	-	-	-	-	4	104	V

* - indicates frequency in CFR47 Pt 15 / IC RSS-Restricted Band
 PK-U - U-NII: Maximum Peak
 ADR - U-NII AD primary method, RMS average

9.1.6. 11n HT20 MODE IN THE 5.3GHz BAND

AUTHORIZED BANDEDGE (HIGH CHANNEL)

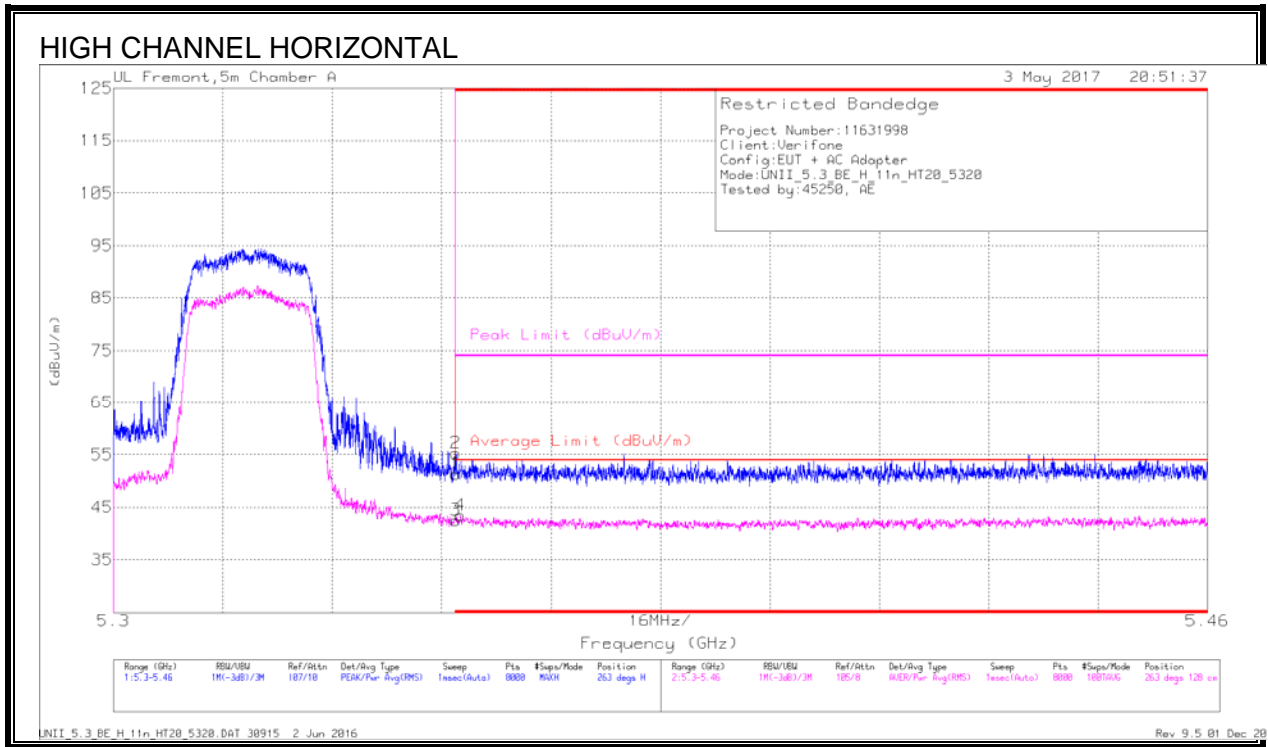

Trace Markers

Marker	Frequency (GHz)	Meter Reading (dBuV)	Det	AF T711 (dB/m)	Amp/Cb/Fltr/Pad (dB)	DC Corr (dB)	Corrected Reading (dBuV/m)	Average Limit (dBuV/m)	Margin (dB)	Peak Limit (dBuV/m)	PK Margin (dB)	Azimuth (Degs)	Height (cm)	Polarity
1	* 5.35	35.84	Pk	34.3	-18.9	0	51.24	-	-	74	-22.76	263	128	H
2	* 5.35	39.87	Pk	34.3	-18.9	0	55.27	-	-	74	-18.73	263	128	H
3	* 5.35	26.84	RMS	34.3	-18.9	.31	42.55	54	-11.45	-	-	263	128	H
4	* 5.351	27.79	RMS	34.3	-18.9	.31	43.5	54	-10.5	-	-	263	128	H

* - indicates frequency in CFR47 Pt 15 / IC RSS-Restricted Band

Pk - Peak detector

RMS - RMS detection

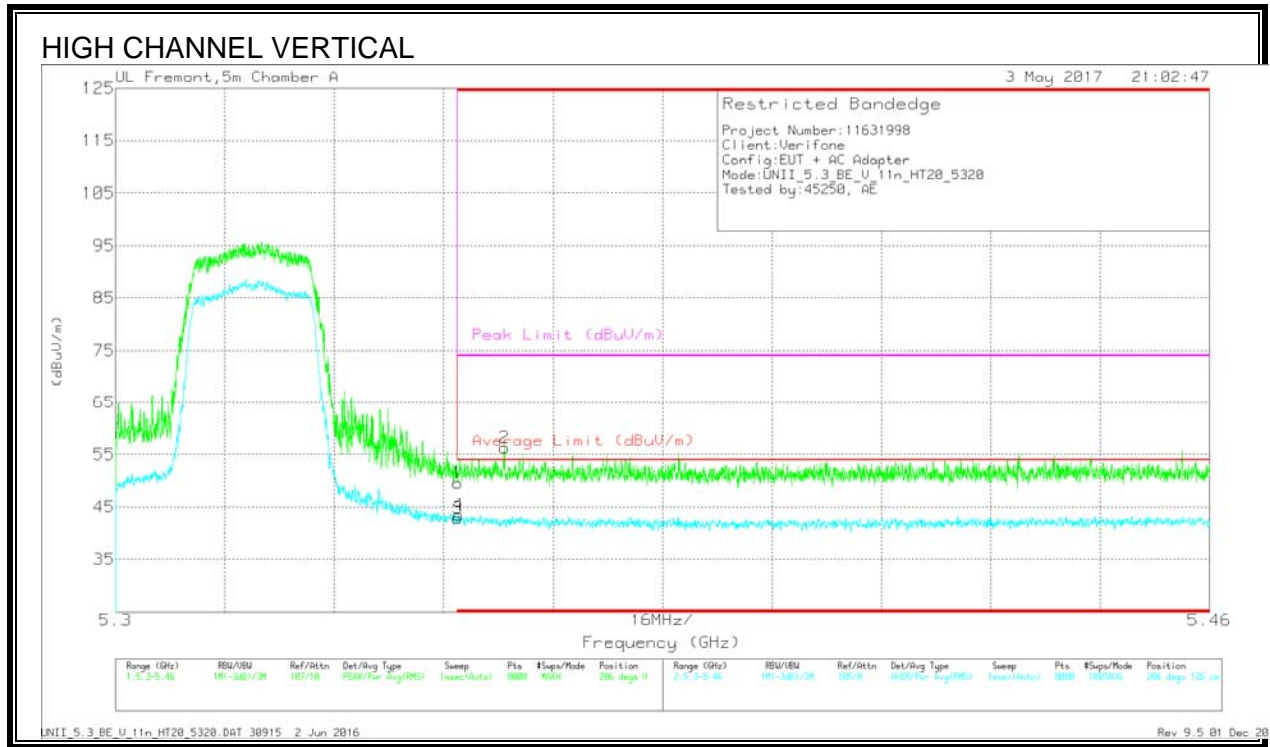

Trace Markers

Marker	Frequency (GHz)	Meter Reading (dBuV)	Det	AF T711 (dB/m)	Amp/Cb/Filtr/Pad (dB)	DC Corr (dB)	Corrected Reading (dBuV/m)	Average Limit (dBuV/m)	Margin (dB)	Peak Limit (dBuV/m)	PK Margin (dB)	Azimuth (Degs)	Height (cm)	Polarity
1	* 5.35	34.1	Pk	34.3	-18.9	0	49.5	-	-	74	-24.5	286	126	V
3	* 5.35	27.18	RMS	34.3	-18.9	.31	42.89	54	-11.11	-	-	286	126	V
4	* 5.35	27.76	RMS	34.3	-18.9	.31	43.47	54	-10.53	-	-	286	126	V
2	* 5.357	40.75	Pk	34.3	-18.8	0	56.25	-	-	74	-17.75	286	126	V

* - indicates frequency in CFR47 Pt 15 / IC RSS-Restricted Band

Pk - Peak detector

RMS - RMS detection

HARMONICS AND SPURIOUS EMISSIONS

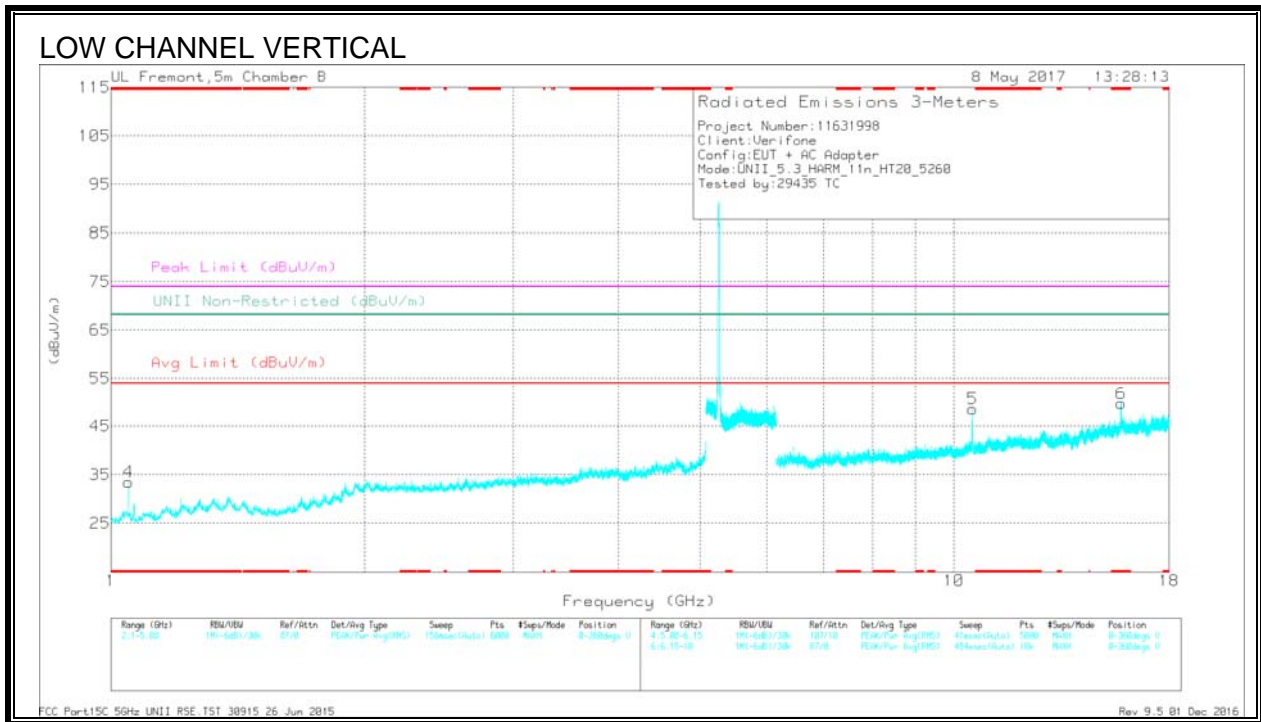
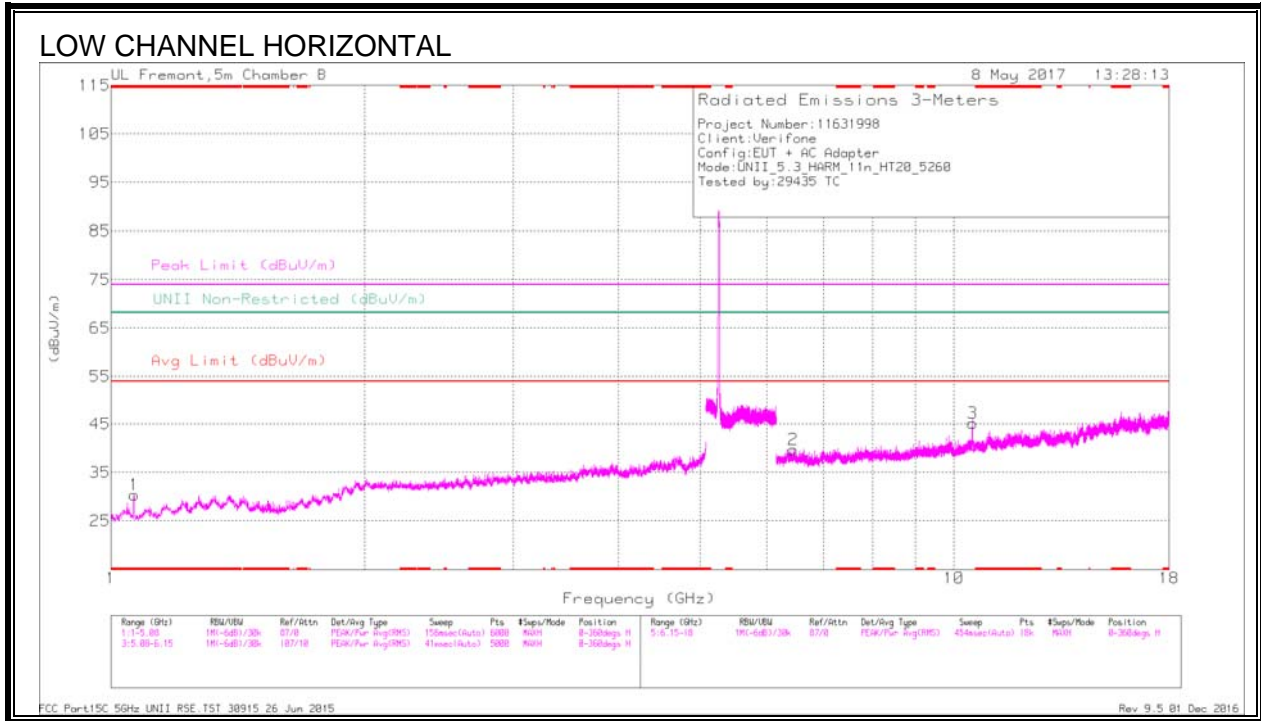

Trace Markers

Marker	Frequency (GHz)	Meter Reading (dBuV)	Det	AF T346 (dB/m)	Amp/CM/Plr/Psd (dB)	DC Corr (dB)	Corrected Reading (dBuV/m)	Avg Limit (dBuV/m)	Margin (dB)	Peak Limit (dBuV/m)	PK Margin (dB)	UNII Non-Restricted (dBuV/m)	PK Margin (dB)	Asimuth (Degs)	Height (cm)	Polarity
1	* 1.065	38.1	Pk	26.4	-34.1	0	30.4	-	-	74	-43.6	-	-	0-360	102	H
4	* 1.049	41.26	Pk	26.4	-34.2	0	33.46	-	-	74	-40.54	-	-	0-360	200	V
6	* 15.778	29.43	Pk	41.7	-21.4	0	49.73	-	-	74	-24.27	-	-	0-360	102	V
2	6.444	31.66	Pk	36.2	-28.1	0	39.76	-	-	-	-	68.2	-28.44	0-360	199	H
3	10.521	30.57	Pk	38	-23.4	0	45.17	-	-	-	-	68.2	-23.03	0-360	102	H
5	10.522	33.91	Pk	38	-23.4	0	48.51	-	-	-	-	68.2	-19.69	0-360	102	V

* - indicates frequency in CFR47 Pt 15 / IC RSS-Restricted Band
 Pk - Peak detector

Radiated Emissions

Frequency (GHz)	Meter Reading (dBuV)	Det	AF T346 (dB/m)	Amp/CM/Plr/Psd (dB)	DC Corr (dB)	Corrected Reading (dBuV/m)	Avg Limit (dBuV/m)	Margin (dB)	Peak Limit (dBuV/m)	PK Margin (dB)	UNII Non-Restricted (dBuV/m)	PK Margin (dB)	Asimuth (Degs)	Height (cm)	Polarity
* 1.065	43.85	PK-U	26.4	-34.1	0	36.15	-	-	74	-37.85	-	-	303	387	H
* 1.064	34.66	ADR	26.4	-34.1	31	27.27	54	-26.73	-	-	-	-	303	387	H
* 1.05	41.94	PK-U	26.4	-34.2	0	34.14	-	-	74	-39.86	-	-	157	208	V
* 1.049	29.73	ADR	26.4	-34.2	31	22.24	54	-31.76	-	-	-	-	157	208	V
* 15.777	37.57	PK-U	41.7	-21.4	0	57.87	-	-	74	-16.13	-	-	291	102	V
* 15.778	24.34	ADR	41.7	-21.4	31	44.95	54	-9.05	-	-	-	-	291	102	V
6.445	38.1	PK-U	36.2	-28.1	0	46.2	-	-	-	-	68.2	-22	2	121	H
10.521	39.05	PK-U	38	-23.4	0	53.65	-	-	-	-	68.2	-14.55	353	105	H
10.522	40.38	PK-U	38	-23.4	0	54.98	-	-	-	-	68.2	-13.22	250	186	V

* - indicates frequency in CFR47 Pt 15 / IC RSS-Restricted Band
 PK-U - U-NII: Maximum Peak
 ADR - U-NII AD primary method, RMS average

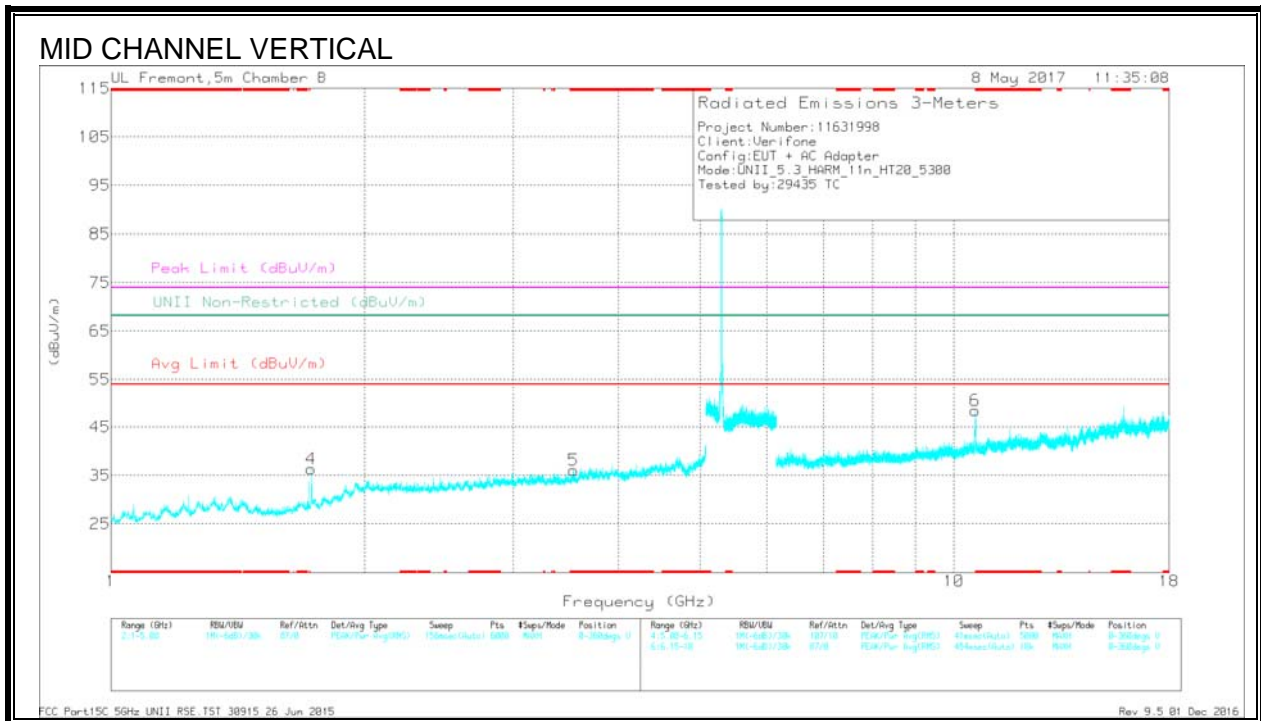
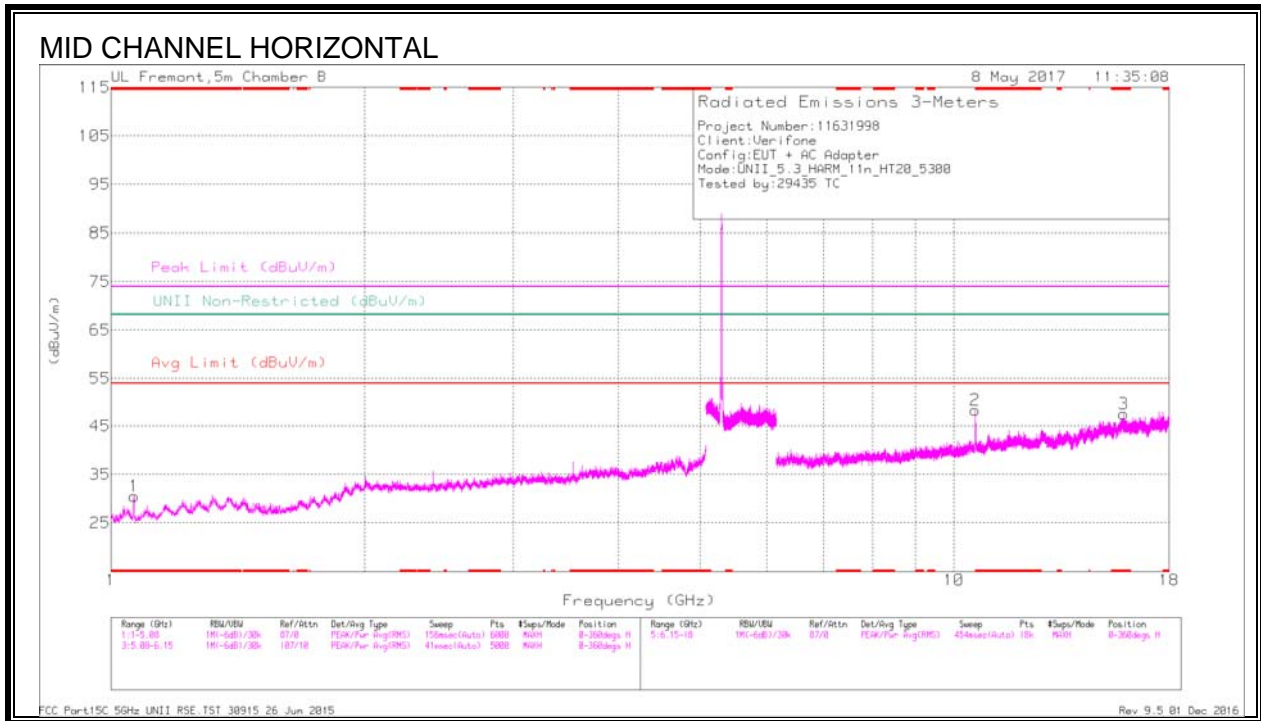

Trace Markers

Marker	Frequency (GHz)	Meter Reading (dBuV)	Det	AF T346 (dB/m)	Amp/Ch/Flt/Psd (dB)	DC Corr (dB)	Corrected Reading (dBuV/m)	Avg Limit (dBuV/m)	Margin (dB)	Peak Limit (dBuV/m)	PK Margin (dB)	UNII Non-Restricted (dBuV/m)	PK Margin (dB)	Asimuth (Degs)	Height (cm)	Polarity
1	* 1.065	38.21	Pk	26.4	-34.1	0	30.51	-	-	74	-43.49	-	-	0-360	199	H
5	* 3.538	33.49	Pk	33.2	-30.6	0	36.09	-	-	74	-37.91	-	-	0-360	102	V
3	* 15.907	25.86	Pk	41.4	-19.7	0	47.56	-	-	74	-26.44	-	-	0-360	199	H
6	* 10.602	34.22	Pk	38.1	-23.9	0	48.42	-	-	74	-25.58	-	-	0-360	199	V
4	1.728	40.44	Pk	28.6	-32.7	0	36.34	-	-	-	-	68.2	-31.86	0-360	102	V
2	10.6	34.13	Pk	38.1	-23.9	0	48.33	-	-	-	-	68.2	-19.87	0-360	102	H

* - indicates frequency in CFR47 Pt 15 / IC RSS-Restricted Band
 Pk - Peak detector

Radiated Emissions

Frequency (GHz)	Meter Reading (dBuV)	Det	AF T346 (dB/m)	Amp/Ch/Flt/Psd (dB)	DC Corr (dB)	Corrected Reading (dBuV/m)	Avg Limit (dBuV/m)	Margin (dB)	Peak Limit (dBuV/m)	PK Margin (dB)	UNII Non-Restricted (dBuV/m)	PK Margin (dB)	Asimuth (Degs)	Height (cm)	Polarity
* 1.063	42.8	PK-U	26.4	-34.1	0	35.1	-	-	74	-37.9	-	-	357	382	H
* 1.065	33.53	ADR	26.4	-34.1	31	26.14	54	-27.86	-	-	-	-	357	382	H
* 3.536	39.48	PK-U	33.2	-30.6	0	42.08	-	-	74	-31.92	-	-	274	187	V
* 3.536	26.96	ADR	33.2	-30.6	31	29.87	54	-24.13	-	-	-	-	274	187	V
* 15.908	32.62	PK-U	41.4	-19.7	0	54.32	-	-	74	-19.68	-	-	117	279	H
* 15.905	19.19	ADR	41.4	-19.6	31	41.3	54	-12.7	-	-	-	-	117	279	H
* 11.781	32.62	PK-U	39.4	-23.2	0	48.82	-	-	74	-25.18	-	-	261	106	V
* 11.709	20.34	ADR	39.2	-23.5	31	36.35	54	-17.65	-	-	-	-	261	106	V
1.728	40.91	PK-U	28.6	-32.7	0	36.81	-	-	-	-	68.2	-31.39	306	150	V
10.6	40.42	PK-U	38.1	-23.9	0	54.62	-	-	-	-	68.2	-13.58	356	103	H

* - indicates frequency in CFR47 Pt 15 / IC RSS-Restricted Band
 PK-U - U-NII: Maximum Peak
 ADR - U-NII AD primary method, RMS average

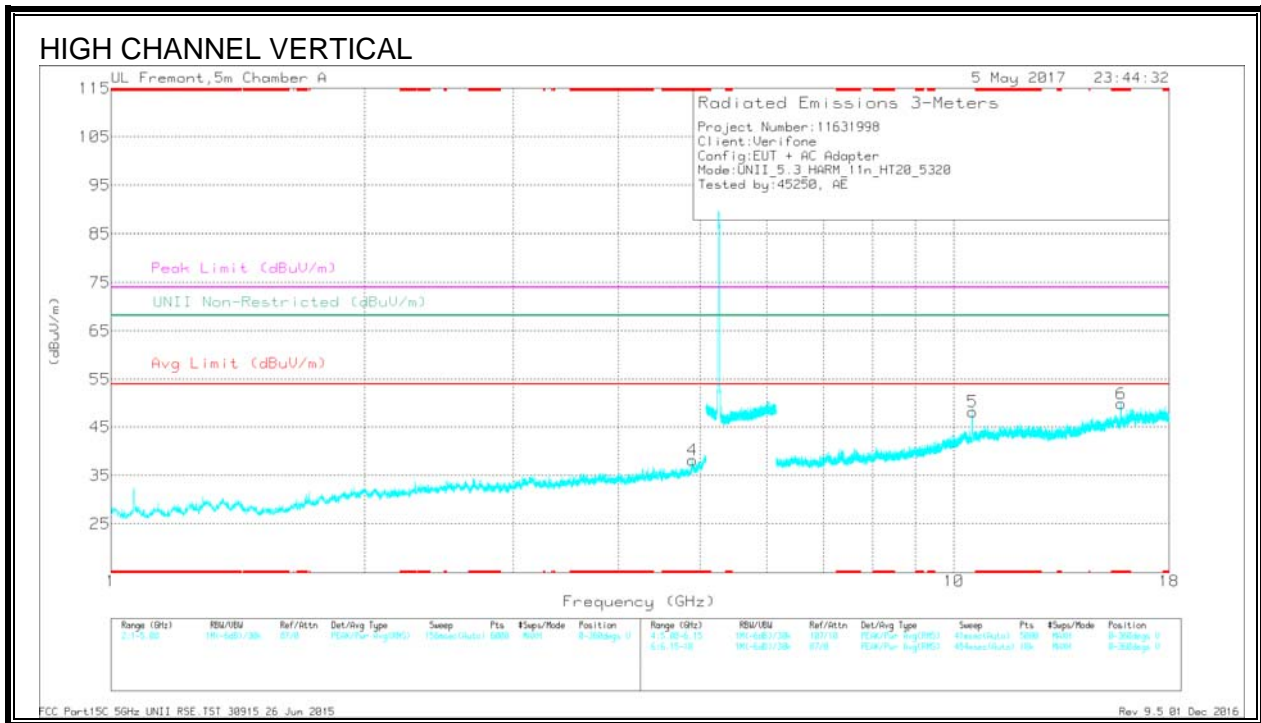
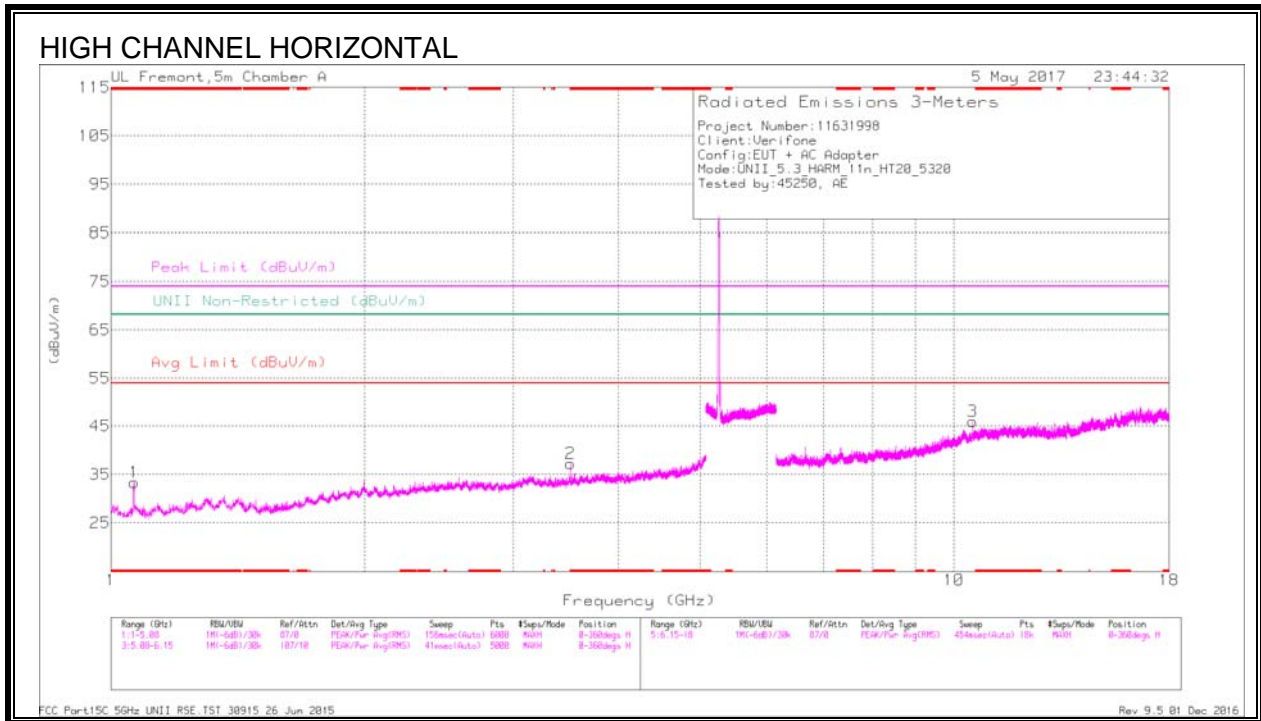

Trace Markers

Marker	Frequency (GHz)	Meter Reading (dBuV)	Det	AF T711 (dB/m)	Amp/CM/ftb/Pad (dB)	DC Corr (dB)	Corrected Reading (dBuV/m)	Aug Limit (dBuV/m)	Margin (dB)	Peak Limit (dBuV/m)	PK Margin (dB)	UNI Non-Restricted (dBuV/m)	PK Margin (dB)	Altitude (Degs)	Height (cm)	Polarity
1	* 1.065	39.37	Pk	27.8	-33.8	0	33.37	-	-	74	-40.63	-	-	0-360	199	H
2	* 3.507	34.58	Pk	33	-30.3	0	37.28	-	-	74	-36.72	-	-	0-360	102	H
4	* 4.896	31.53	Pk	34	-27.4	0	38.13	-	-	74	-35.87	-	-	0-360	101	V
6	* 15.78	29.58	Pk	40.5	-20.2	0	49.88	-	-	74	-24.12	-	-	0-360	101	V
5	10.516	31.23	Pk	37.6	-20.7	0	48.13	-	-	-	-	68.2	-20.07	0-360	101	V
3	10.52	28.97	Pk	37.6	-20.6	0	45.97	-	-	-	-	68.2	-22.23	0-360	101	H

* - indicates frequency in CFR47 Pt 15 / IC RSS-Restricted Band
 Pk - Peak detector

Radiated Emissions

Frequency (GHz)	Meter Reading (dBuV)	Det	AF T711 (dB/m)	Amp/CM/ftb/Pad (dB)	DC Corr (dB)	Corrected Reading (dBuV/m)	Aug Limit (dBuV/m)	Margin (dB)	Peak Limit (dBuV/m)	PK Margin (dB)	UNI Non-Restricted (dBuV/m)	PK Margin (dB)	Altitude (Degs)	Height (cm)	Polarity
* 1.064	46.21	PK-U	27.8	-33.8	0	40.21	-	-	74	-33.79	-	-	175	178	H
* 1.064	38.22	ADR	27.8	-33.8	.31	32.53	54	-21.47	-	-	-	-	175	178	H
* 3.507	40.48	PK-U	33	-30.3	0	43.18	-	-	74	-30.82	-	-	360	104	H
* 3.507	31.82	ADR	33	-30.3	.31	34.83	54	-19.17	-	-	-	-	360	104	H
* 4.896	37.01	PK-U	34	-27.4	0	43.61	-	-	74	-30.39	-	-	335	103	V
* 4.896	26.01	ADR	34	-27.4	.31	32.92	54	-21.08	-	-	-	-	335	103	V
* 15.781	36.94	PK-U	40.5	-20.2	0	57.24	-	-	74	-16.76	-	-	0	101	V
* 15.78	24.5	ADR	40.5	-20.2	.31	45.11	54	-8.89	-	-	-	-	0	101	V
10.518	36.82	PK-U	37.6	-20.7	0	53.72	-	-	-	-	68.2	-14.48	68	101	H
10.518	38.55	PK-U	37.6	-20.7	0	55.45	-	-	-	-	68.2	-12.75	314	124	V

* - indicates frequency in CFR47 Pt 15 / IC RSS-Restricted Band
 PK-U - U-NII: Maximum Peak
 ADR - U-NII AD primary method, RMS average

9.1.7. 11n HT40 MODE IN THE 5.3GHz BAND

AUTHORIZED BANDEDGE (HIGH CHANNEL)

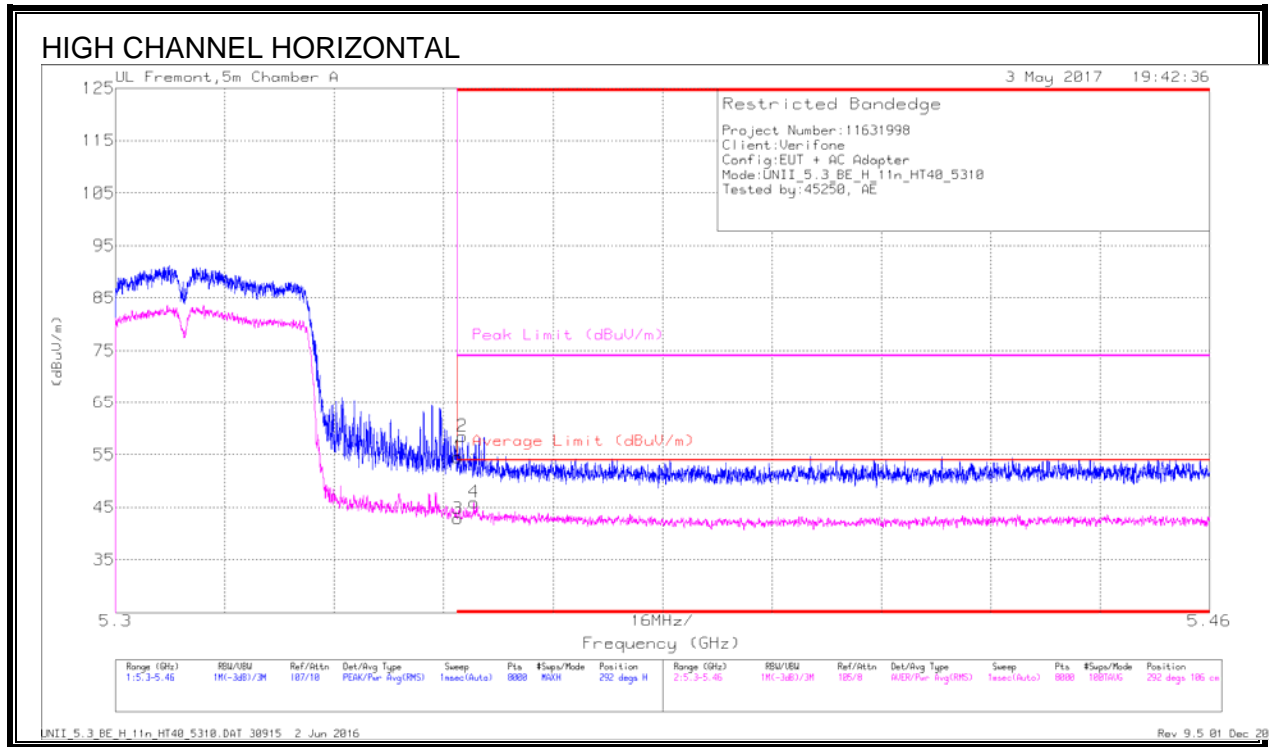

Trace Markers

Marker	Frequency (GHz)	Meter Reading (dBuV)	Det	AF T711 (dB/m)	Amp/Cb/Filtr/ Pad (dB)	DC Corr (dB)	Corrected Reading (dBuV/m)	Average Limit (dBuV/m)	Margin (dB)	Peak Limit (dBuV/m)	PK Margin (dB)	Azimuth (Degs)	Height (cm)	Polarity
1	* 5.35	39.11	Pk	34.3	-18.9	0	54.51	-	-	74	-19.49	292	106	H
3	* 5.35	26.82	RMS	34.3	-18.9	.42	42.64	54	-11.36	-	-	292	106	H
2	* 5.351	43.13	Pk	34.3	-18.9	0	58.53	-	-	74	-15.47	292	106	H
4	* 5.352	29.88	RMS	34.3	-18.8	.42	45.8	54	-8.2	-	-	292	106	H

* - indicates frequency in CFR47 Pt 15 / IC RSS-Restricted Band

Pk - Peak detector

RMS - RMS detection

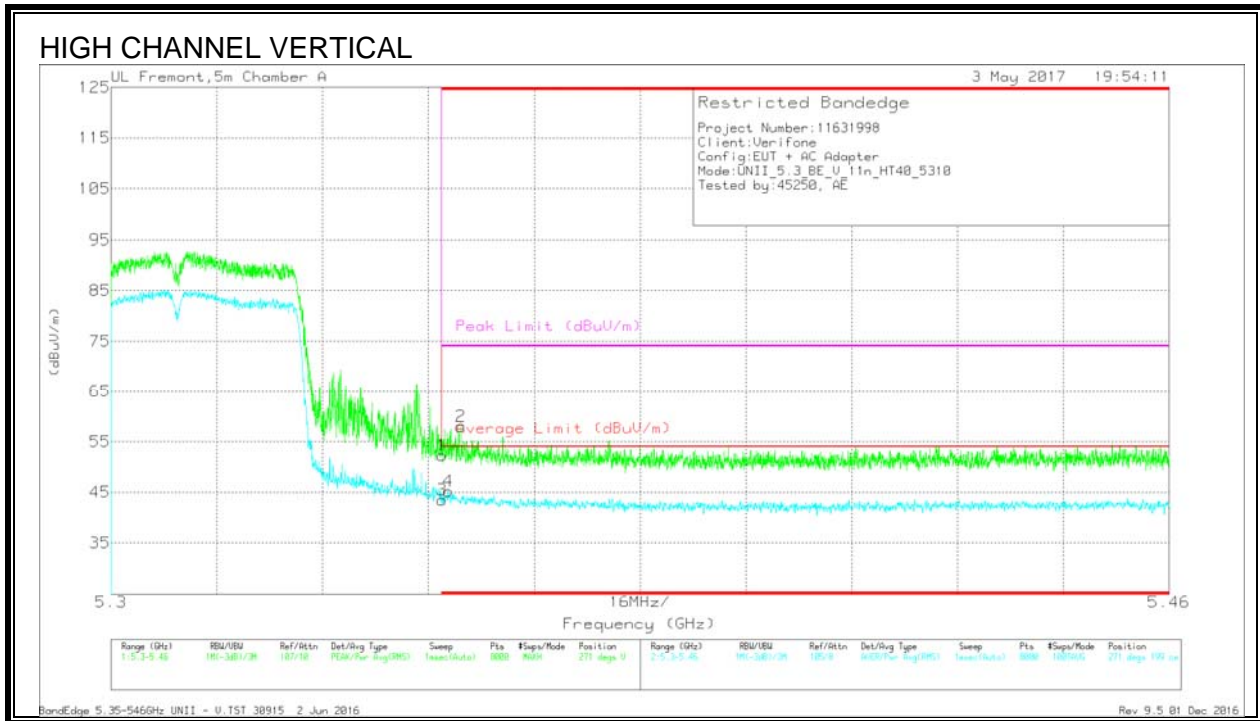

Trace Markers

Marker	Frequency (GHz)	Meter Reading (dBuV)	Det	AFT711 (dB/m)	Amp/Cbl/Filtr/Pad (dB)	DC Corr (dB)	Corrected Reading (dBuV/m)	Average Limit (dBuV/m)	Margin (dB)	Peak Limit (dBuV/m)	PK Margin (dB)	Azimuth (Degs)	Height (cm)	Polarity
1	* 5.35	36.83	Pk	34.3	-18.9	0	52.23	-	-	74	-21.77	271	199	V
2	* 5.353	42.47	Pk	34.3	-18.8	0	57.97	-	-	74	-16.03	271	199	V
3	* 5.35	27.43	RMS	34.3	-18.9	.42	43.25	54	-10.75	-	-	271	199	V
4	* 5.351	29.15	RMS	34.3	-18.9	.42	44.97	54	-9.03	-	-	271	199	V

* - indicates frequency in CFR47 Pt 15 / IC RSS-Restricted Band

Pk - Peak detector

RMS - RMS detection

HARMONICS AND SPURIOUS EMISSIONS

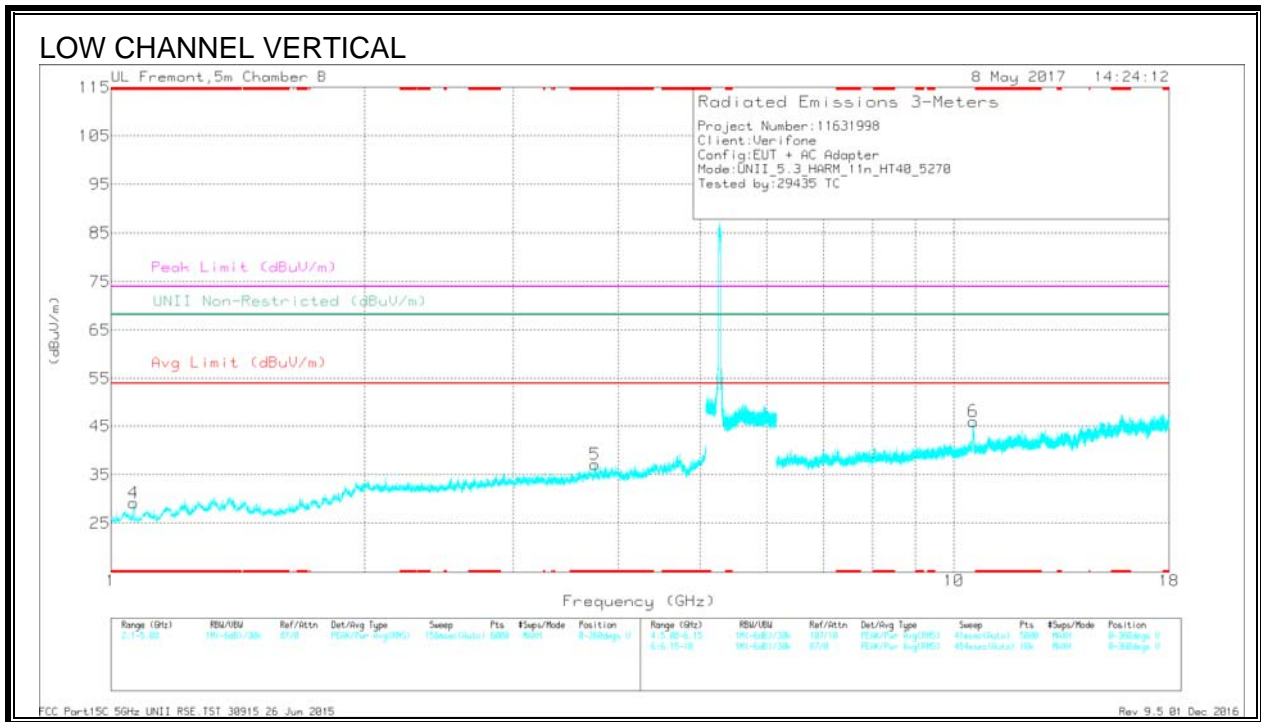
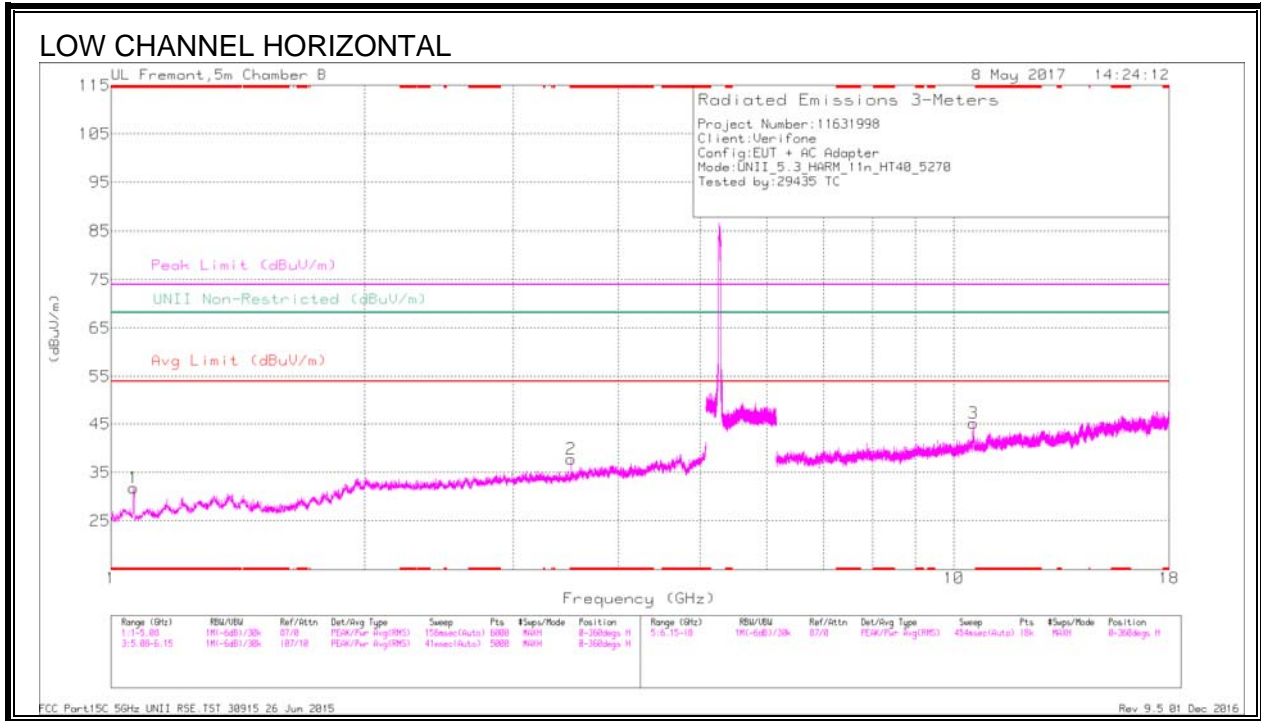

Trace Markers

Marker	Frequency (GHz)	Meter Reading (dBuV)	Det	AF T346 (dB/m)	Amp/Ch/Filt/Pad (dB)	DC Corr (dB)	Corrected Reading (dBuV/m)	Aug Limit (dBuV/m)	Margin (dB)	Peak Limit (dBuV/m)	PK Margin (dB)	UNII Non-Restricted (dBuV/m)	PK Margin (dB)	Asimuth (Degs)	Height (cm)	Polarity
1	* 1.064	39.52	Pk	26.4	-34.1	0	31.82	-	-	74	-42.18	-	-	0-360	199	H
2	* 3.513	35.73	Pk	33.1	-31	0	37.83	-	-	74	-36.17	-	-	0-360	102	H
4	* 1.064	36.89	Pk	26.4	-34.1	0	29.19	-	-	74	-44.81	-	-	0-360	102	V
5	* 3.751	34.26	Pk	33.6	-30.7	0	37.16	-	-	74	-36.84	-	-	0-360	200	V
3	10.539	31.08	Pk	38	-23.9	0	45.18	-	-	-	-	68.2	-23.02	0-360	102	H
6	10.539	31.92	Pk	38	-23.9	0	46.02	-	-	-	-	68.2	-22.18	0-360	102	V

* - indicates frequency in CFR47 Pt 15 / IC RSS-Restricted Band
 Pk - Peak detector

Radiated Emissions

Frequency (GHz)	Meter Reading (dBuV)	Det	AF T346 (dB/m)	Amp/Ch/Filt/Pad (dB)	DC Corr (dB)	Corrected Reading (dBuV/m)	Aug Limit (dBuV/m)	Margin (dB)	Peak Limit (dBuV/m)	PK Margin (dB)	UNII Non-Restricted (dBuV/m)	PK Margin (dB)	Asimuth (Degs)	Height (cm)	Polarity
* 1.064	46.04	PK-U	26.4	-34.1	0	38.54	-	-	74	-35.66	-	-	351	312	H
* 1.064	38.45	ADR	26.4	-34.1	-42	31.17	54	-22.83	-	-	-	-	351	312	H
* 3.513	41.44	PK-U	33.1	-31	0	43.54	-	-	74	-30.46	-	-	295	116	H
* 3.513	32.67	ADR	33.1	-31	-42	35.19	54	-18.81	-	-	-	-	295	116	H
* 1.064	43.54	PK-U	26.4	-34.1	0	35.84	-	-	74	-38.16	-	-	254	289	V
* 1.064	34.89	ADR	26.4	-34.1	-42	27.61	54	-26.39	-	-	-	-	254	289	V
* 3.751	39.56	PK-U	33.6	-30.7	0	42.46	-	-	74	-31.54	-	-	299	399	V
* 3.751	27.28	ADR	33.6	-30.7	-42	30.6	54	-23.4	-	-	-	-	299	399	V
10.538	37.42	PK-U	38	-23.8	0	51.62	-	-	-	-	68.2	-16.58	360	105	H
10.54	39.29	PK-U	38	-23.9	0	53.39	-	-	-	-	68.2	-14.81	253	217	V

* - indicates frequency in CFR47 Pt 15 / IC RSS-Restricted Band
 PK-U - U-NII: Maximum Peak
 ADR - U-NII AD primary method, RMS average

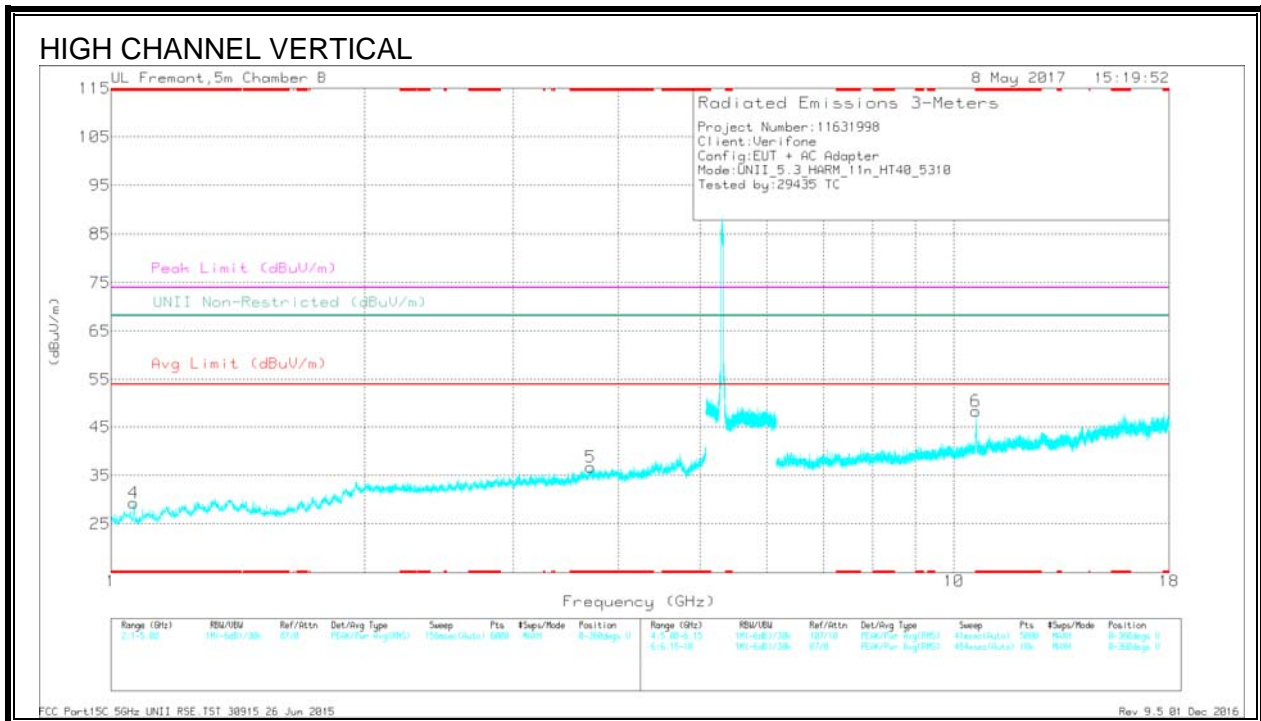
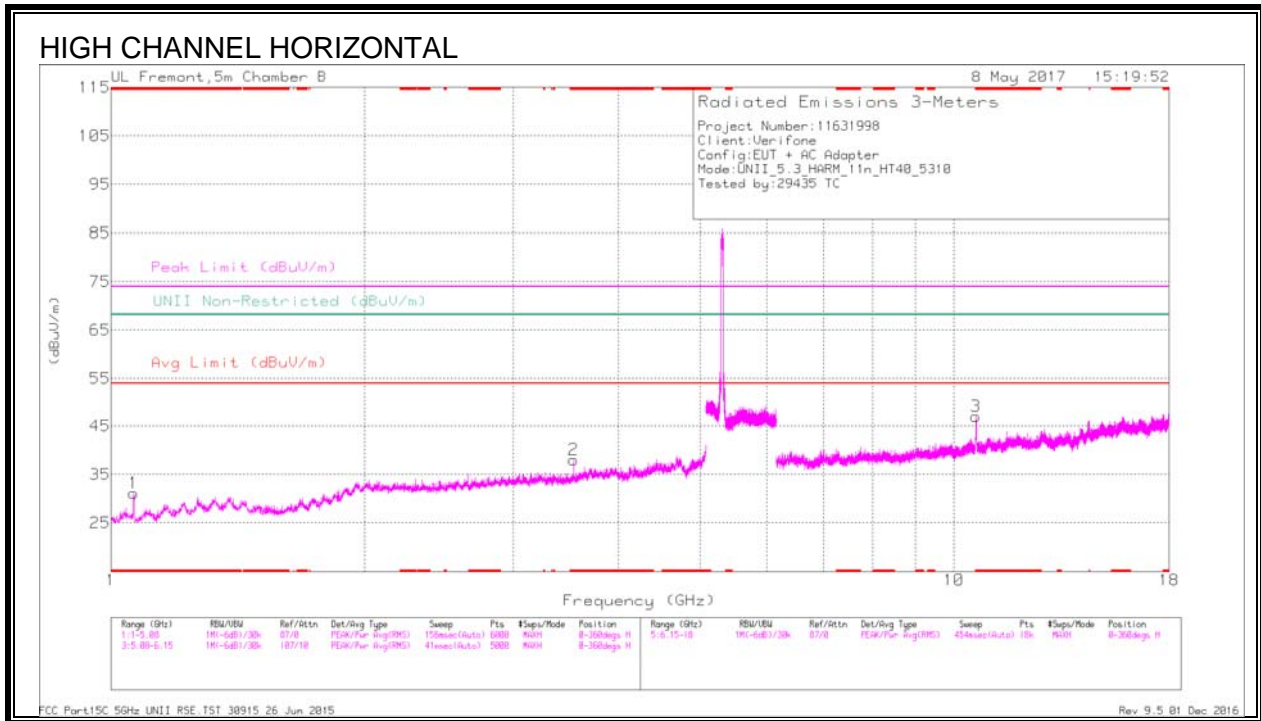

Trace Markers

Marker	Frequency (GHz)	Meter Reading (dBuV)	Det	AF T346 (dB/m)	Amp/Ch/Flt/Psd (dB)	DC Corr (dB)	Corrected Reading (dBuV/m)	Avg Limit (dBuV/m)	Margin (dB)	Peak Limit (dBuV/m)	PK Margin (dB)	UNII Non-Restricted (dBuV/m)	PK Margin (dB)	Asimuth (Degs)	Height (cm)	Polarity
1	* 1.064	38.86	Pk	26.4	-34.1	0	31.16	-	-	74	-42.84	-	-	0-360	102	H
2	* 3.54	35.47	Pk	33.2	-30.6	0	38.07	-	-	74	-35.93	-	-	0-360	102	H
4	* 1.064	37.04	Pk	26.4	-34.1	0	29.34	-	-	74	-44.66	-	-	0-360	102	V
5	* 3.709	33.76	Pk	33.5	-30.5	0	36.76	-	-	74	-37.24	-	-	0-360	102	V
3	* 10.618	32.33	Pk	38.1	-23.4	0	47.03	-	-	74	-26.97	-	-	0-360	102	H
6	* 10.621	33.58	Pk	38.1	-23.4	0	48.28	-	-	74	-25.72	-	-	0-360	102	V

* - indicates frequency in CFR47 Pt 15 / IC RSS-Restricted Band
 Pk - Peak detector

Radiated Emissions

Frequency (GHz)	Meter Reading (dBuV)	Det	AF T346 (dB/m)	Amp/Ch/Flt/Psd (dB)	DC Corr (dB)	Corrected Reading (dBuV/m)	Avg Limit (dBuV/m)	Margin (dB)	Peak Limit (dBuV/m)	PK Margin (dB)	UNII Non-Restricted (dBuV/m)	PK Margin (dB)	Asimuth (Degs)	Height (cm)	Polarity
* 1.063	44.27	PK-U	26.4	-34.1	0	36.57	-	-	74	-37.43	-	-	354	143	H
* 1.064	35.92	ADR	26.4	-34.1	42	28.64	54	-25.36	-	-	-	-	354	143	H
* 3.54	42.2	PK-U	33.2	-30.6	0	44.8	-	-	74	-29.2	-	-	300	106	H
* 3.54	33.73	ADR	33.2	-30.6	42	36.75	54	-17.25	-	-	-	-	300	106	H
* 1.064	41.4	PK-U	26.4	-34.1	0	33.7	-	-	74	-40.3	-	-	256	252	V
* 1.064	31.03	ADR	26.4	-34.1	42	23.75	54	-30.25	-	-	-	-	256	252	V
* 3.71	39.25	PK-U	33.5	-30.5	0	42.25	-	-	74	-31.75	-	-	160	177	V
* 3.708	27.32	ADR	33.5	-30.5	42	30.74	54	-23.26	-	-	-	-	160	177	V
* 10.617	37.54	PK-U	38.1	-23.5	0	52.14	-	-	74	-21.86	-	-	1	103	H
* 10.619	25.24	ADR	38.1	-23.4	42	40.36	54	-13.64	-	-	-	-	1	103	H
* 10.621	39.16	PK-U	38.1	-23.4	0	53.86	-	-	74	-20.14	-	-	243	120	V
* 10.621	26.56	ADR	38.1	-23.4	42	41.68	54	-12.32	-	-	-	-	243	120	V

* - indicates frequency in CFR47 Pt 15 / IC RSS-Restricted Band
 PK-U - U-NII: Maximum Peak
 ADR - U-NII AD primary method, RMS average

9.1.8. 11ac VHT80 MODE IN THE 5.3GHz BAND

AUTHORIZED BANDEDGE (MID CHANNEL)

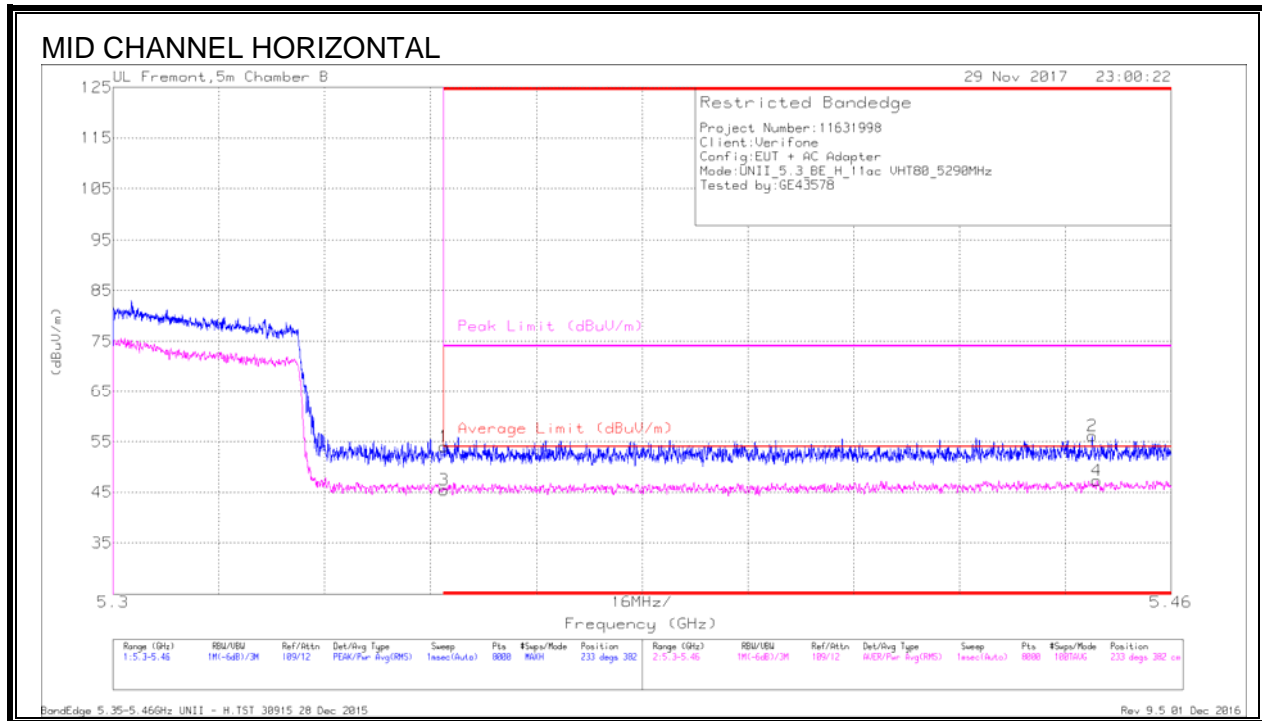

Trace Markers

Marker	Frequency (GHz)	Meter Reading (dBuV)	Det	AF T863 (dB/m)	Amp/Cb/Ftr/Pad (dB)	DC Corr (dB)	Corrected Reading (dBuV/m)	Average Limit (dBuV/m)	Margin (dB)	Peak Limit (dBuV/m)	PK Margin (dB)	Azimuth (Degs)	Height (cm)	Polarity
1	* 5.35	37.58	Pk	34.9	-18.5	0	53.98	-	-	74	-20.02	233	382	H
2	* 5.448	39.66	PK	35.1	-18.6	0	56.16	-	-	74	-17.84	233	382	H
3	* 5.35	27.9	RMS	34.9	-18.5	1.18	45.48	54	-8.52	-	-	233	382	H
4	* 5.449	29.71	RMS	35.1	-18.7	1.18	47.29	54	-6.71	-	-	233	382	H

* - indicates frequency in CFR47 Pt 15 / IC RSS-Restricted Band

Pk - Peak detector

RMS - RMS detection

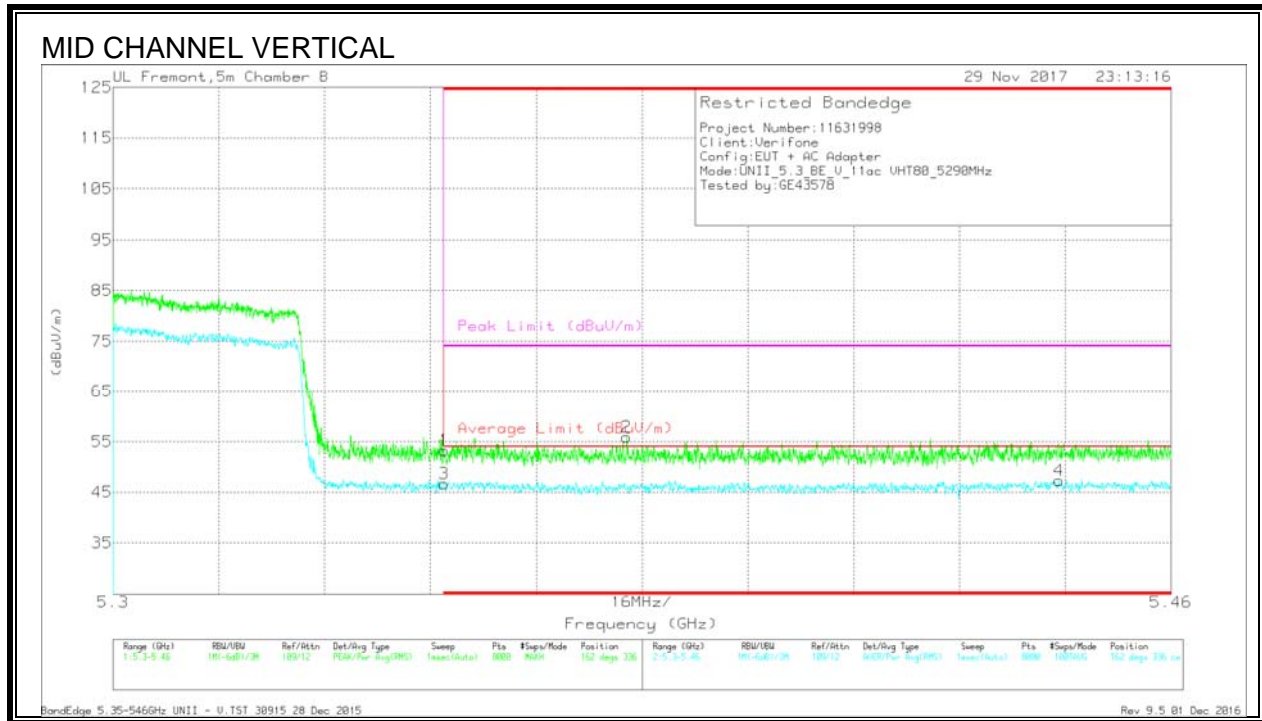

Trace Markers

Marker	Frequency (GHz)	Meter Reading (dBuV)	Det	AF T863 (dB/m)	Amp/Cbl/Fitr/Pad (dB)	DC Corr (dB)	Corrected Reading (dBuV/m)	Average Limit (dBuV/m)	Margin (dB)	Peak Limit (dBuV/m)	PK Margin (dB)	Azimuth (Degs)	Height (cm)	Polarity
1	* 5.35	36.87	Pk	34.9	-18.5	0	53.27	-	-	74	-20.73	162	336	V
2	* 5.378	39.43	Pk	35	-18.6	0	55.83	-	-	74	-18.17	162	336	V
3	* 5.35	29.12	RMS	34.9	-18.5	1.18	46.7	54	-7.3	-	-	162	336	V
4	* 5.443	29.63	RMS	35.1	-18.6	1.18	47.31	54	-6.69	-	-	162	336	V

* - indicates frequency in CFR47 Pt 15 / IC RSS-Restricted Band

Pk - Peak detector

RMS - RMS detection

HARMONICS AND SPURIOUS EMISSIONS

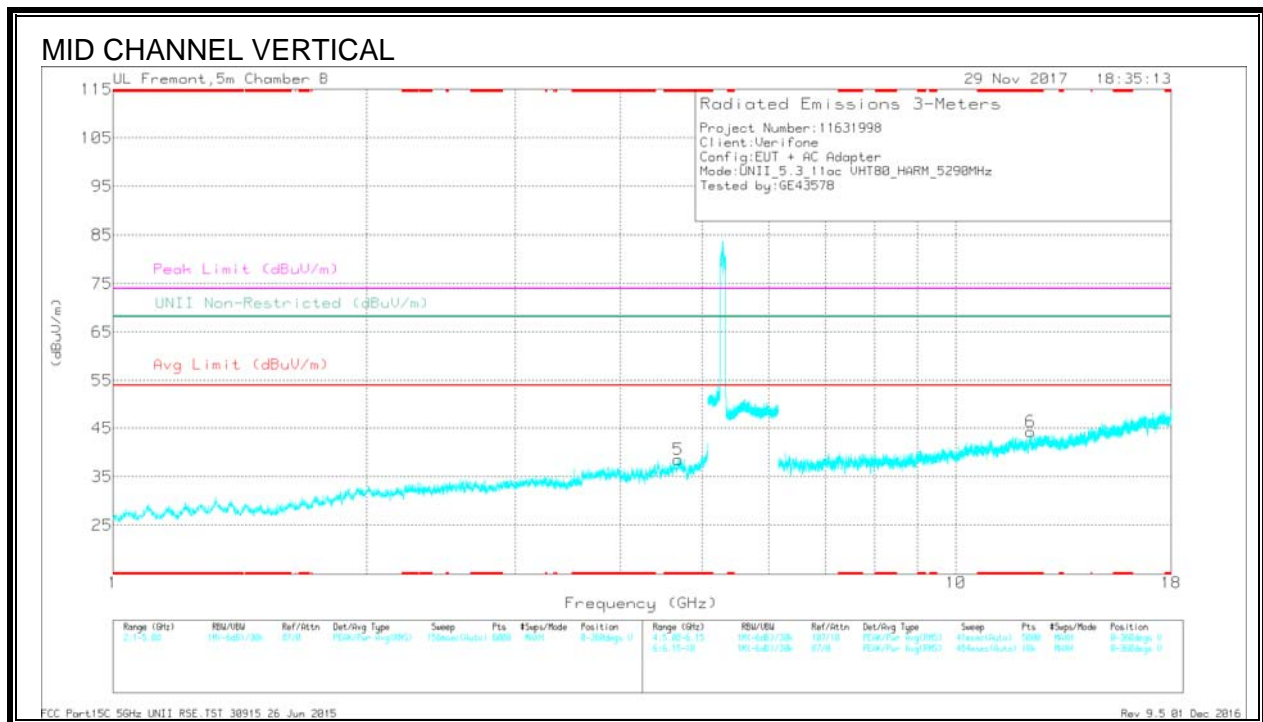
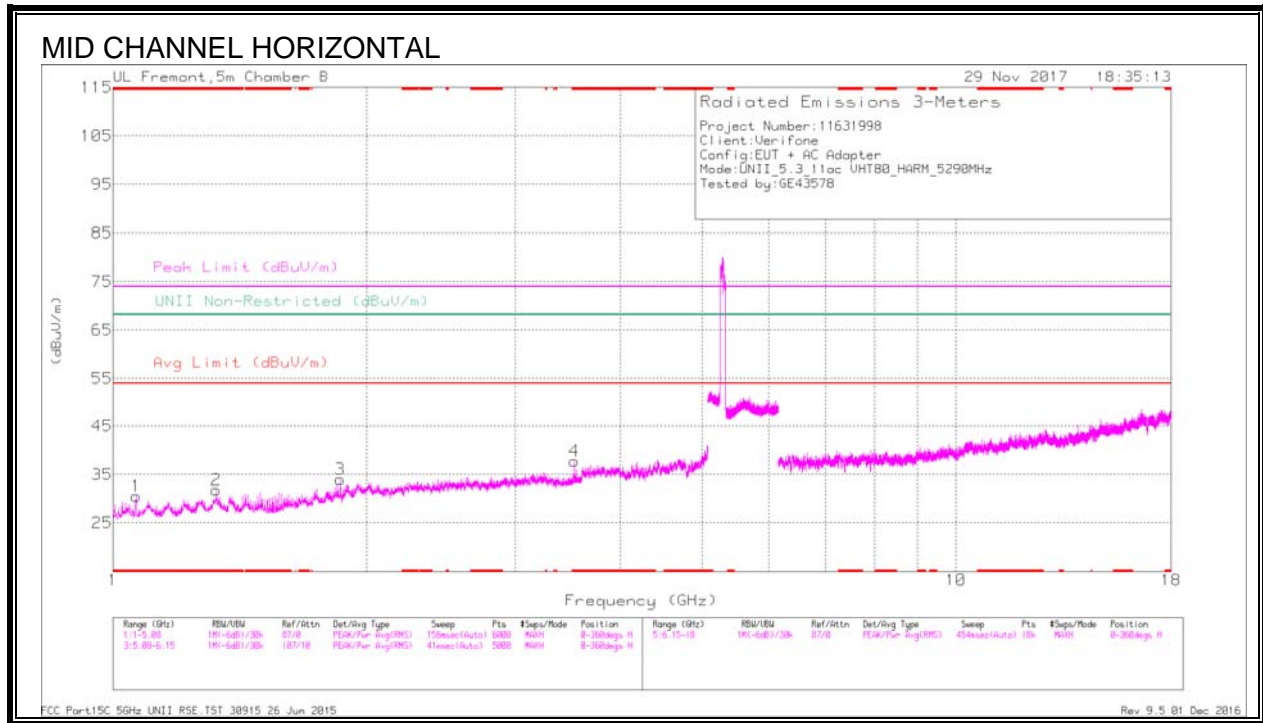

Radiated Emissions

Marker	Frequency (GHz)	Meter Reading (dBuV)	Det	AF T863 (dB/m)	Amp/Cbl/Filtr/Pad (dB)	DC Corr (dB)	Corrected Reading (dBuV/m)	Avg Limit (dBuV/m)	Margin (dB)	Peak Limit (dBuV/m)	PK Margin (dB)	UNII Non-Restricted (dBuV/m)	PK Margin (dB)	Azimuth (Degs)	Height (cm)	Polarity
1	* 1.063	44.63	PK-U	27.1	-34.1	0	37.63	-	-	74	-36.37	-	-	340	198	H
	* 1.064	34.65	ADR	27.2	-34.1	1.18	28.93	54	-25.07	-	-	-	-	340	198	H
2	* 1.325	42.32	PK-U	28.9	-33.6	0	37.62	-	-	74	-36.38	-	-	51	104	H
	* 1.325	30.98	ADR	28.9	-33.6	1.18	27.46	54	-26.54	-	-	-	-	51	104	H
4	* 3.527	40.97	PK-U	32.9	-30.6	0	43.27	-	-	74	-30.73	-	-	297	199	H
	* 3.527	31.93	ADR	32.9	-30.6	1.18	35.41	54	-18.59	-	-	-	-	297	199	H
5	* 4.683	39.28	PK-U	34.2	-29	0	44.48	-	-	74	-29.52	-	-	30	104	V
	* 4.683	27.41	ADR	34.2	-29	1.18	33.79	54	-20.21	-	-	-	-	30	104	V
6	* 12.27	33.1	PK-U	39.1	-22.1	0	50.1	-	-	74	-23.9	-	-	51	200	V
	* 12.269	21.18	ADR	39.1	-22.1	1.18	39.36	54	-14.64	-	-	-	-	51	200	V
3	1.86	36.45	Pk	30.8	-33.2	0	34.05	-	-	-	-	68.2	-34.15	0-360	199	H

* - indicates frequency in CFR47 Pt 15 / IC RSS-Restricted Band

PK-U - U-NII: Maximum Peak

ADR - U-NII AD primary method, RMS average

9.1.9. 11a MODE IN THE 5.6GHz BAND

BANDEDGE (LOW CHANNEL)

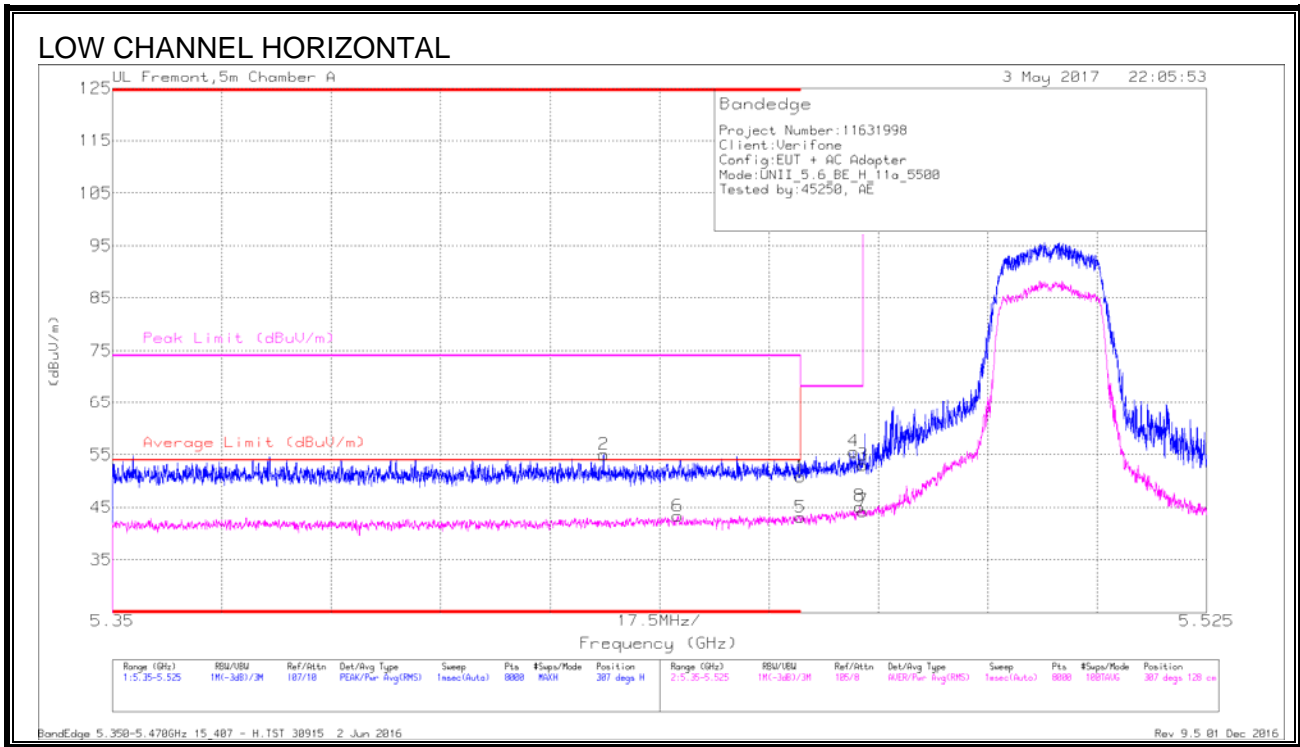

Trace Markers

Marker	Frequency (GHz)	Meter Reading (dBuV)	Det	AF T345 (dB/m)	Amp/Cbl/Fltr/Pad (dB)	DC Corr (dB)	Corrected Reading (dBuV/m)	Average Limit (dBuV/m)	Margin (dB)	Peak Limit (dBuV/m)	PK Margin (dB)	Azimuth (Degs)	Height (cm)	Polarity
2	* 5.429	39.46	Pk	34.3	-18.8	0	54.96	-	-	74	-19.04	307	128	H
6	* 5.44	27.38	RMS	34.4	-18.7	.29	43.37	54	-10.63	-	-	307	128	H
1	* 5.46	35.28	Pk	34.4	-18.9	0	50.78	-	-	74	-23.22	307	128	H
5	* 5.46	27.25	RMS	34.4	-18.9	.29	43.04	54	-10.96	-	-	307	128	H
4	5.469	39.87	Pk	34.4	-18.7	0	55.57	-	-	68.2	-12.63	307	128	H
8	5.469	29.13	RMS	34.4	-18.7	.29	45.12	-	-	-	-	307	128	H
3	5.47	37.3	Pk	34.4	-18.7	0	53	-	-	68.2	-15.2	307	128	H
7	5.47	28.26	RMS	34.4	-18.7	.29	44.25	-	-	-	-	307	128	H

* - indicates frequency in CFR47 Pt 15 / IC RSS-Restricted Band

Pk - Peak detector

RMS - RMS detection