



CERTIFICATION TEST REPORT

Report Number. : 11631998-E2V1

Applicant : Verifone, Inc.
1400 West Stanford Ranch Road
Rocklin, CA 95765, USA

Model : V240m Plus 3GBW

FCC ID : B32V240MPLUS

IC : 787C-V240MPLUS

EUT Description : Mobile Point of Sale Terminal

Test Standard(s) : FCC 47 CFR PART 15 SUBPART C
INDUSTRY CANADA RSS - 247 ISSUE 2
INDUSTRY CANADA RSS-GEN ISSUE 4

Date Of Issue:

August 16, 2017

Prepared by:

UL Verification Services Inc.
47173 Benicia Street
Fremont, CA 94538, U.S.A.
TEL: (510) 771-1000
FAX: (510) 661-0888



NVLAP LAB CODE 200065-0

Revision History

<u>Rev.</u>	<u>Issue Date</u>	<u>Revisions</u>	<u>Revised By</u>
V1	08/16/17	Initial Issue	D. Corona

TABLE OF CONTENTS

1. ATTESTATION OF TEST RESULTS	5
2. TEST METHODOLOGY	6
3. FACILITIES AND ACCREDITATION	6
4. CALIBRATION AND UNCERTAINTY	6
4.1. <i>MEASURING INSTRUMENT CALIBRATION</i>	6
4.2. <i>SAMPLE CALCULATION</i>	6
4.3. <i>MEASUREMENT UNCERTAINTY.....</i>	7
5. EQUIPMENT UNDER TEST	8
5.1. <i>DESCRIPTION OF EUT</i>	8
5.2. <i>MAXIMUM OUTPUT POWER.....</i>	8
5.3. <i>DESCRIPTION OF AVAILABLE ANTENNAS</i>	8
5.4. <i>SOFTWARE AND FIRMWARE.....</i>	8
5.5. <i>WORST-CASE CONFIGURATION AND MODE.....</i>	9
5.6. <i>DESCRIPTION OF TEST SETUP.....</i>	10
6. TEST AND MEASUREMENT EQUIPMENT	13
7. SUMMARY TABLE	14
8. ANTENNA PORT TEST RESULTS	15
8.1. <i>MEASUREMENT METHODS</i>	15
8.2. <i>ON TIME, DUTY CYCLE</i>	16
8.3.1. <i>6 dB BANDWIDTH.....</i>	17
8.3.2. <i>99% BANDWIDTH.....</i>	19
8.3.3. <i>AVERAGE POWER</i>	22
8.3.4. <i>OUTPUT POWER</i>	23
8.3.5. <i>POWER SPECTRAL DENSITY</i>	25
8.3.6. <i>CONDUCTED BANDEDGE AND SPURIOUS EMISSIONS.....</i>	28
9. RADIATED TEST RESULTS.....	32
9.1. <i>LIMITS AND PROCEDURE.....</i>	32
9.2. <i>SPURIOUS EMISSIONS BELOW 30 MHz (WORST-CASE CONFIGURATION).....</i>	33
9.2.1. <i>SPURIOUS EMISSIONS 30 TO 1000 MHz (WORST-CASE CONFIGURATION).....</i>	34
9.2.2. <i>TRANSMITTER ABOVE 1 GHz.....</i>	36
9.2.3. <i>SPURIOUS EMISSIONS 18 TO 26 GHz (WORST-CASE CONFIGURATION)....</i>	46
9.3. <i>AC POWER LINE CONDUCTED EMISSIONS</i>	48

10. SETUP PHOTOS51

1. ATTESTATION OF TEST RESULTS

COMPANY NAME: Verifone, Inc.
1400 West Stanford Ranch Road Suite 200
Rocklin, CA 95765, USA

EUT DESCRIPTION: Mobile Point of Sale Terminal

MODEL: V240m Plus 3GBW

SERIAL NUMBER: 313-855-592, 313-855-662

DATE TESTED: May 04 to 24, 2017

APPLICABLE STANDARDS	
STANDARD	TEST RESULTS
FCC 47 CFR PART 15 SUBPART C	Pass
INDUSTRY CANADA RSS-247 Issue 2	Pass
INDUSTRY CANADA RSS-GEN Issue 4	Pass

UL Verification Services Inc. tested the above equipment in accordance with the requirements set forth in the above standards. All indications of Pass/Fail in this report are opinions expressed by UL Verification Services Inc. based on interpretations and/or observations of test results. Measurement Uncertainties were not taken into account and are published for informational purposes only. The test results show that the equipment tested is capable of demonstrating compliance with the requirements as documented in this report.

Note: The results documented in this report apply only to the tested sample, under the conditions and modes of operation as described herein. This document may not be altered or revised in any way unless done so by UL Verification Services Inc. and all revisions are duly noted in the revisions section. Any alteration of this document not carried out by UL Verification Services Inc. will constitute fraud and shall nullify the document. This report must not be used by the client to claim product certification, approval, or endorsement by NVLAP, NIST, any agency of the Federal Government, or any agency of any government.

Approved & Released For
UL Verification Services Inc. By:



DAN CORONIA
WiSE PROJECT LEAD
UL VERIFICATION SERVICES INC.

Prepared By:

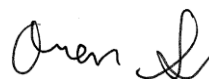

OREN STOELTING
WiSE LAB TECHNICIAN
UL VERIFICATION SERVICES INC.

2. TEST METHODOLOGY

The tests documented in this report were performed in accordance with FCC CFR 47 Part 2, FCC CFR 47 Part 15 Subpart C, KDB 558074 D01 v04, ANSI C63.10-2013, IC RSS-GEN Issue 4, and IC RSS-247 Issue 2.

3. FACILITIES AND ACCREDITATION

The test sites and measurement facilities used to collect data are located at 47173 and 47266 Benicia Street, Fremont, California, USA. Line conducted emissions are measured only at the 47173 address. The following table identifies which facilities were utilized for radiated emission measurements documented in this report. Specific facilities are also identified in the test results sections.

47173 Benicia Street		47266 Benicia Street	
<input type="checkbox"/>	Chamber A (IC:2324B-1)	<input type="checkbox"/>	Chamber D (IC:22541-1)
<input checked="" type="checkbox"/>	Chamber B (IC:2324B-2)	<input type="checkbox"/>	Chamber E (IC:22541-2)
<input checked="" type="checkbox"/>	Chamber C (IC:2324B-3)	<input type="checkbox"/>	Chamber F (IC:22541-3)
		<input type="checkbox"/>	Chamber G (IC:22541-4)
		<input type="checkbox"/>	Chamber H (IC:22541-5)

The above test sites and facilities are covered under FCC Test Firm Registration # 208313. UL Verification Services Inc. is accredited by NVLAP, Laboratory Code 200065-0.

Chambers A through C are covered under Industry Canada Company address code 2324B with site numbers 2324B -1 through 2324B-3, respectively and Chambers D through H are covered under Industry Canada company address code 22541 with site numbers 22541 -1 through 22541-5, respectively.

4. CALIBRATION AND UNCERTAINTY

4.1. MEASURING INSTRUMENT CALIBRATION

The measuring equipment utilized to perform the tests documented in this report has been calibrated in accordance with the manufacturer's recommendations, and is traceable to recognized national standards.

4.2. SAMPLE CALCULATION

Where relevant, the following sample calculation is provided:

$$\begin{aligned} \text{Field Strength (dBuV/m)} &= \text{Measured Voltage (dBuV)} + \text{Antenna Factor (dB/m)} + \\ &\text{Cable Loss (dB)} - \text{Preamp Gain (dB)} \\ 36.5 \text{ dBuV} + 18.7 \text{ dB/m} + 0.6 \text{ dB} - 26.9 \text{ dB} &= 28.9 \text{ dBuV/m} \end{aligned}$$

4.3. MEASUREMENT UNCERTAINTY

Where relevant, the following measurement uncertainty levels have been estimated for tests performed on the apparatus:

Parameter	Uncertainty
Worst Case Conducted Disturbance, 9KHz to 0.15 MHz	3.84 dB
Worst Case Conducted Disturbance, 0.15 to 30 MHz	3.65 dB
Worst Case Radiated Disturbance, 9KHz to 30 MHz	3.15 dB
Worst Case Radiated Disturbance, 30 to 1000 MHz	5.36 dB
Worst Case Radiated Disturbance, 1000 to 18000 MHz	4.32 dB
Worst Case Radiated Disturbance, 18000 to 26000 MHz	4.45 dB
Worst Case Radiated Disturbance, 26000 to 40000 MHz	5.24 dB

Uncertainty figures are valid to a confidence level of 95%.

5. EQUIPMENT UNDER TEST

5.1. DESCRIPTION OF EUT

The EUT is the Mobile Point of Sale Terminal which contains an 11a/b/g/n/ac WLAN + Bluetooth 4.1 combo module.

5.2. MAXIMUM OUTPUT POWER

The transmitter has a maximum peak conducted output power as follows:

Frequency Range (MHz)	Mode	Output Power (dBm)	Output Power (mW)
2402 - 2480	BLE	4.59	2.88

5.3. DESCRIPTION OF AVAILABLE ANTENNAS

The radio utilizes a WiFi antenna with a maximum gain of 1.90 dBi across the frequencies in 2.4GHz band.

5.4. SOFTWARE AND FIRMWARE

The firmware installed in the EUT during testing was VOS2 – 30640xxx.

5.5. **WORST-CASE CONFIGURATION AND MODE**

Radiated band edge, harmonics, and spurious emissions from 1 GHz to 18GHz were performed with the EUT was set to transmit at the Low/Middle/High channels.

Radiated emission below 30MHz, below 1GHz, above 18GHz, and power line conducted emission were performed with the EUT was set to transmit at the channel with highest output power as worst-case scenario.

The fundamental of the EUT was investigated in three orthogonal orientations X, Y, & Z, and it was determined that X-Axis orientation was worst-case orientation; therefore, all final radiated testing was performed with the EUT in X-Axis orientation.

Worst-case data rates were 1Mbps

5.6. DESCRIPTION OF TEST SETUP

SUPPORT EQUIPMENT

Support Equipment List				
Description	Manufacturer	Model	Serial Number	FCC ID
Laptop	Lenovo	20B7S0A200	PC015REW	NA
AC Adapter	Verifone	SC1402	1708200053701	NA
AC Adapter	Verifone	AM11A-050A	1650A1P	NA

I/O CABLES (CONDUCTED TEST)

I/O Cable List						
Cable No	Port	# of identical ports	Connector Type	Cable Type	Cable Length (m)	Remarks
1	Antenna	1	SMA	Un-Shielded	0.1	To Spectrum Analyzer and Bluetooth Tester
2	DC	1	AC	Un-shielded	2	N/A
3	USB	1	USB	Shielded	2	N/A

I/O CABLES (RADIATED TEST)

I/O Cable List						
Cable No	Port	# of identical ports	Connector Type	Cable Type	Cable Length (m)	Remarks
1	DC	1	AC	Un-shielded	2	N/A

TEST SETUP

CONDUCTED TEST SETUP DIAGRAM

The EUT was tested connected to a host Laptop via USB cable adapter and spectrum analyzer to antenna port. Test software exercised the EUT.

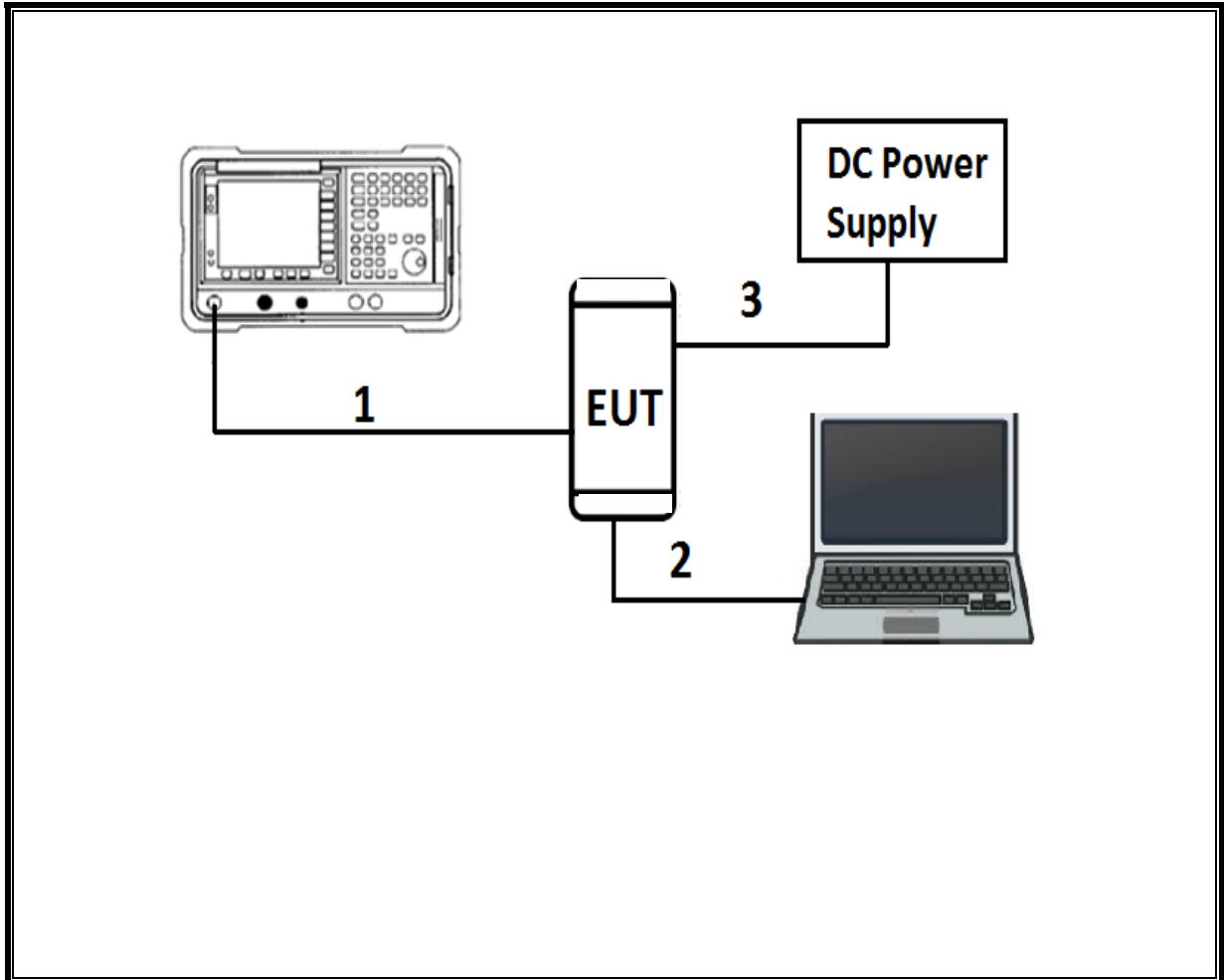

TEST SETUP

RADIATED AND AC LINE CONDUCTED EMISSIONS SETUP DIAGRAM

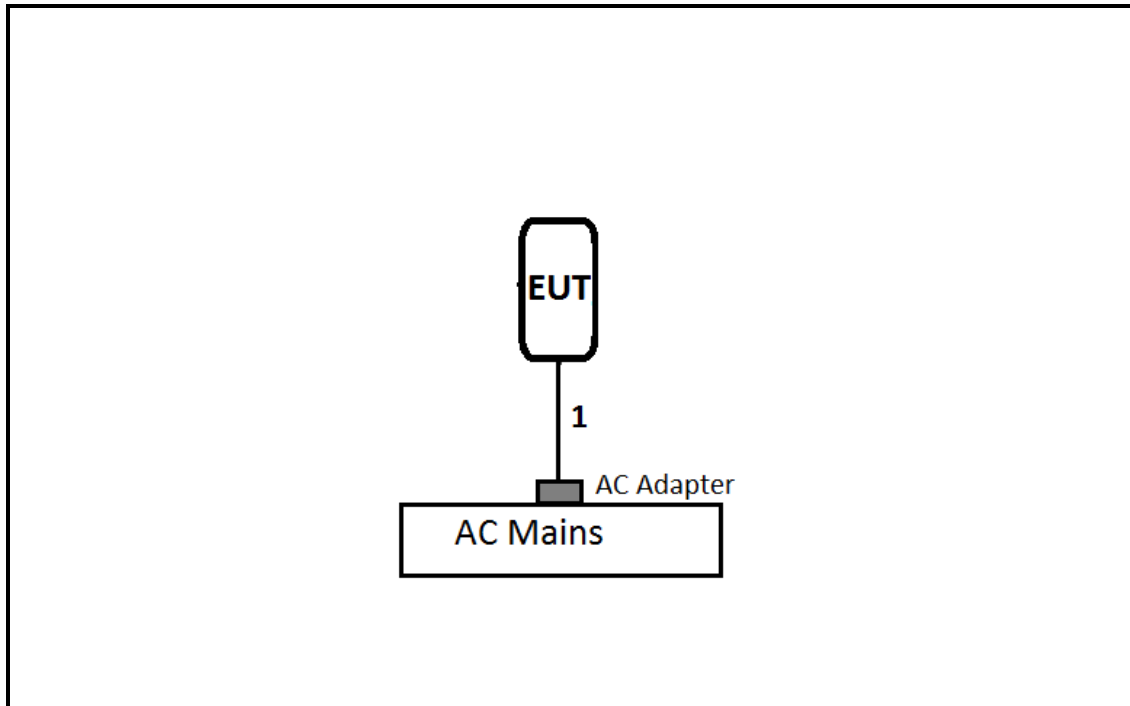

6. TEST AND MEASUREMENT EQUIPMENT

The following test and measurement equipment was utilized for the tests documented in this report:

TEST EQUIPMENT LIST				
Description	Manufacturer	Model	Asset	Cal Due
Antenna, Broadband Hybrid, 30MHz to 2000MHz w/4dB Pad	Sunol Sciences Corp.	JB3	T477	06/22/2017
Antenna, Active Loop 9kHz-30MHz	ETS-Lindgren	6502	T1683	02/17/2018
Antenna, Horn 1-18GHz	ETS-Lindgren	3117	T346	02/22/2018
Antenna, Horn 18-26.5GHz	ARA	MWH-1826/B	T449	05/26/2017
Antenna, Horn 26.5 - 40GHz	ARA	MWH-1826/B	T449	05/26/2017
Power Meter, P-series single channel	Agilent (Keysight) Technologies	N1911A	T1264	07/08/2017
Power Sensor, P – series, 50MHz to 18GHz, Wideband	Agilent (Keysight) Technologies	N1921A	T413	06/20/2017
Amplifier, 1-26.5GHz	Agilent (Keysight) Technologies	8449B	T404	07/05/2017
Amplifier, 10kHz-1GHz	Agilent (Keysight) Technologies	8447D	T15	08/26/2017
Amplifier, 1-8 GHz	MITEQ	AFS42-00101800-25-S-42	T931	08/26/2017
Spectrum Analyzer, PSA, 3Hz to 26.5GHz	Agilent (Keysight) Technologies	E4440A	T199	07/22/2017
Spectrum Analyzer, PXA, 3Hz to 44GHz	Agilent (Keysight) Technologies	N9030A	T907	01/23/2018
Spectrum Analyzer, PSA, 3Hz to 26.5GHz	Agilent (Keysight) Technologies	E9030A	T905	01/11/2018
LISN	FISCHER	FCC-LISN-50/250-25-2-01	T1310	06/08/2017

Test Software List			
Description	Manufacturer	Model	Version
Radiated Software	UL	UL EMC	Ver 9.5, Apr 26, 2016
Antenna Port Software	UL	UL RF	Ver 5.1.1, July 15, 2016

7. SUMMARY TABLE

FCC Part Section	RSS Section(s)	Test Description	Test Limit	Test Condition	Test Result
15.247 (a)(2)	RSS-247 5.2 (a)	Occupied Band width (6dB)	>500KHz	Conducted	Pass
2.1051, 15.247 (d)	RSS-247 5.5	Band Edge / Conducted Spurious Emission	-20dBc		Pass
15.247	RSS-247 5.4 (d)	TX conducted output power	<30dBm		Pass
15.247	RSS-247 5.2 (b)	PSD	<8dBm		Pass
15.207 (a)	RSS-GEN 8.8	AC Power Line conducted emissions	Section 10		Pass
15.205, 15.209, 15.247(d)	RSS-GEN 8.9/7	Radiated Spurious Emission	< 54dBuV/m	Radiated	Pass

8. ANTENNA PORT TEST RESULTS

8.1. MEASUREMENT METHODS

6 dB BW: KDB 558074 D01 v04, Section 8.1.

Output Power: KDB 558074 D01 v04, Section 9.1.1.

Power Spectral Density: KDB 558074 D01 v04, Section 10.2.

Out-of-band emissions in non-restricted bands: KDB 558074 D01 v04, Section 11.0.

Out-of-band emissions in restricted bands: KDB 558074 D01 v04, Section 12.1.

Band-edge: KDB 558074 D01 v04, Section 12.1.

AC Power Line Conducted Emissions: ANSI C63.10-2013, Section 6.2.

8.2. ON TIME, DUTY CYCLE

LIMITS

None; for reporting purposes only.

PROCEDURE

KDB 558074 Zero-Span Spectrum Analyzer Method.

ON TIME AND DUTY CYCLE RESULTS

Mode	ON Time B (msec)	Period (msec)	Duty Cycle x (linear)	Duty Cycle (%)	Duty Cycle Correction Factor (dB)	1/T Minimum VBW (kHz)
BLE	0.390	0.625	0.623	62.33%	2.05	2.567

DUTY CYCLE PLOT

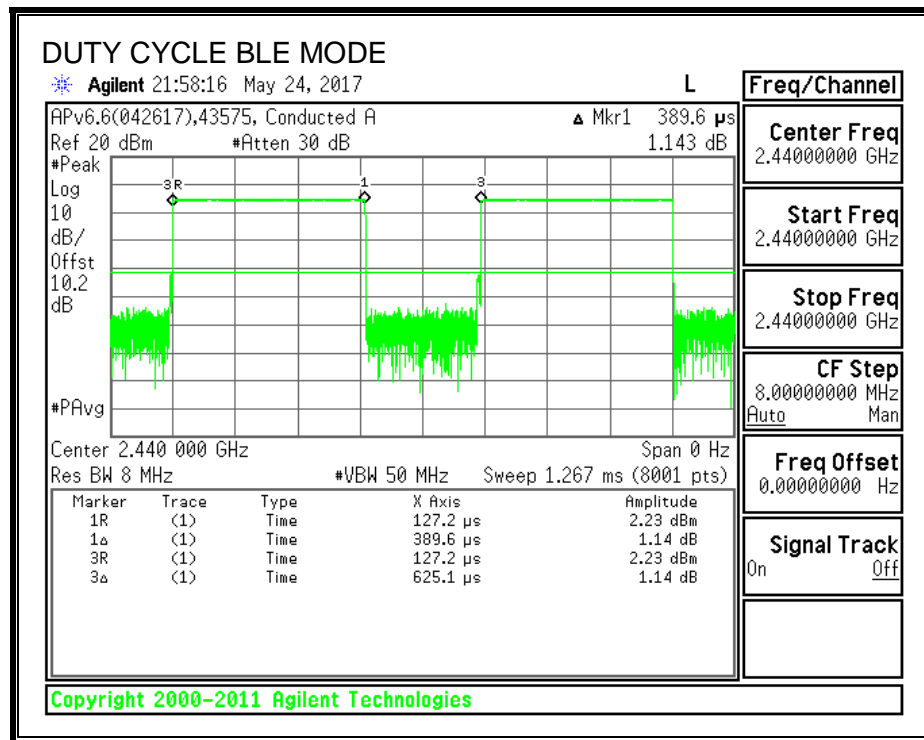

8.3.1. 6 dB BANDWIDTH

LIMITS

FCC §15.247 (a) (2)
 IC RSS-247 (5.2) (a)

The minimum 6 dB bandwidth shall be at least 500 kHz.

RESULTS

6 dB BANDWIDTH

Channel	Frequency	6 dB Bandwidth (MHz)	Minimum Limit (MHz)
Low	2402	0.686	0.5
Middle	2440	0.694	0.5
High	2480	0.680	0.5

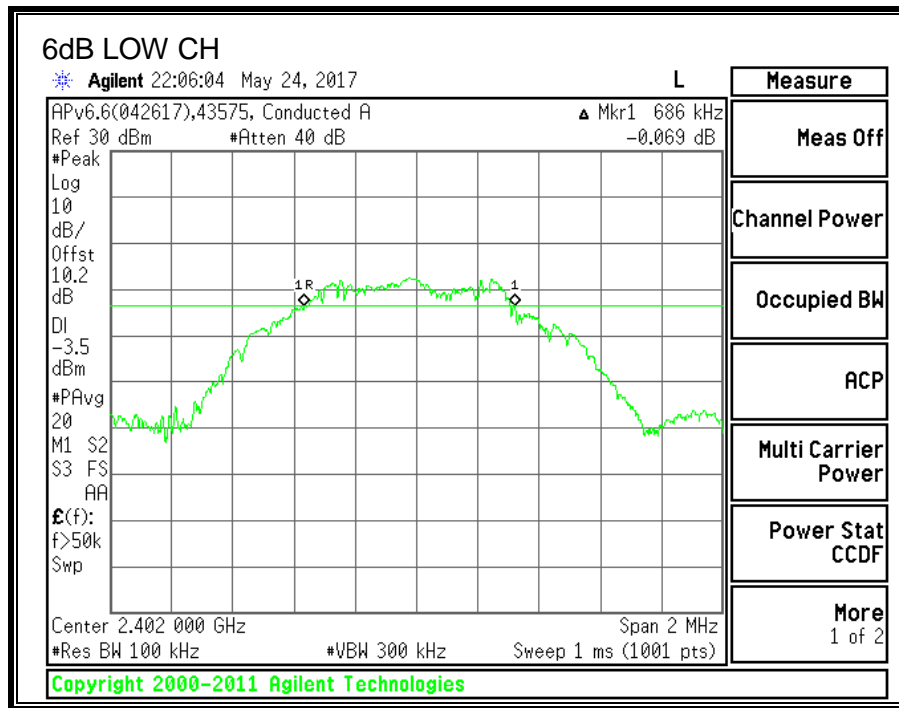

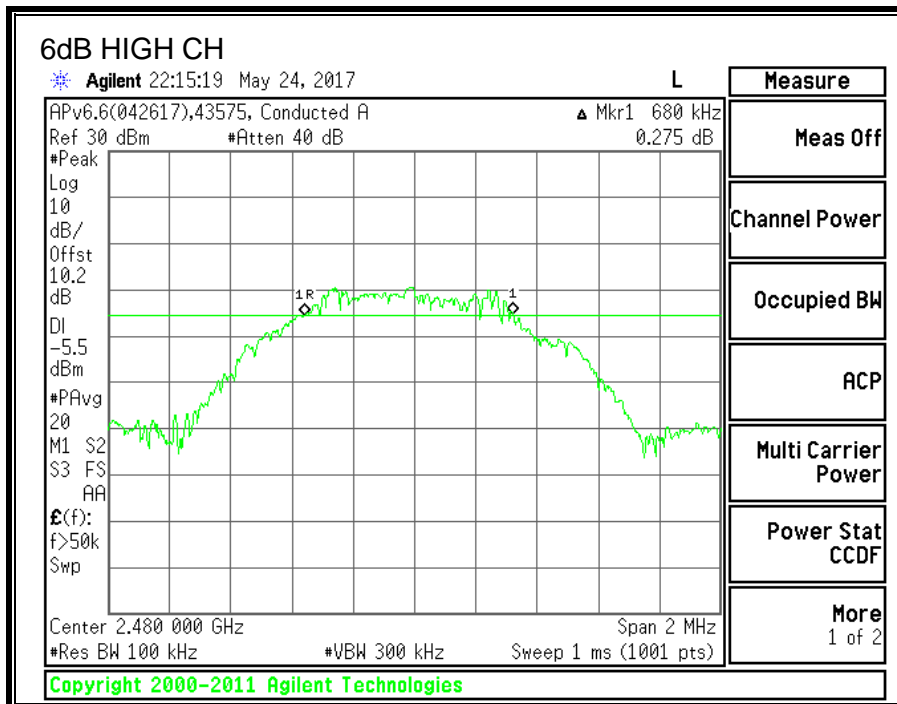
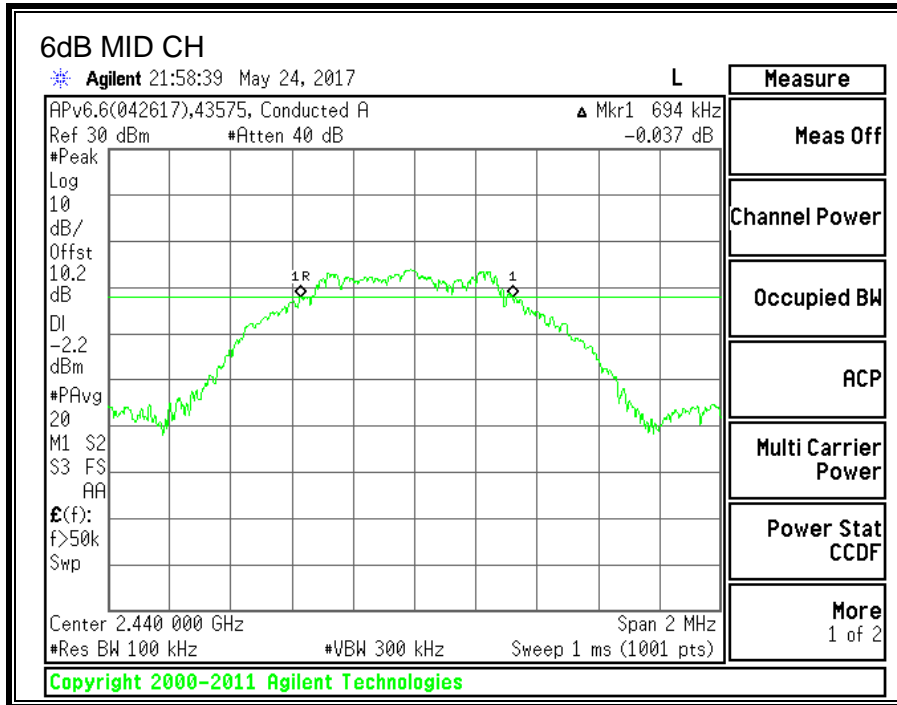

8.3.2. 99% BANDWIDTH

LIMITS

None; for reporting purposes only.

Test Procedure

The transmitter output is connected to the spectrum analyzer. The RBW is set to 1% to 3% of the 99 % bandwidth and to 1% of the span. The VBW is set to 3 times the RBW. The sweep time is coupled. The spectrum analyzer internal 99% bandwidth function is utilized.

RESULTS

99% BANDWIDTH

Channel	Frequency (MHz)	99% Bandwidth (MHz)
Low	2402	1.0476
Middle	2440	1.0512
High	2480	1.0495

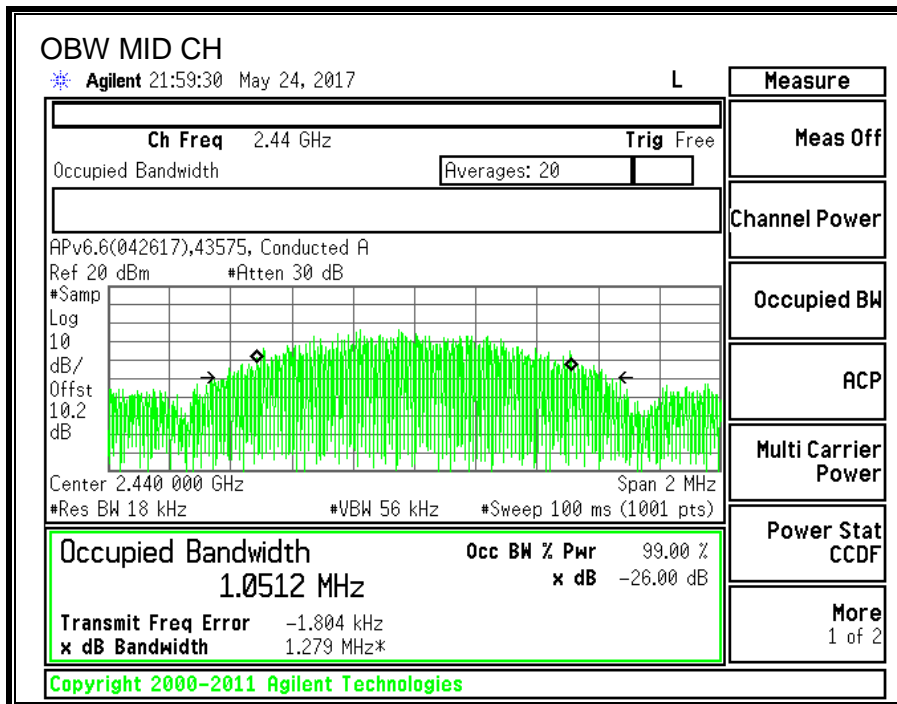
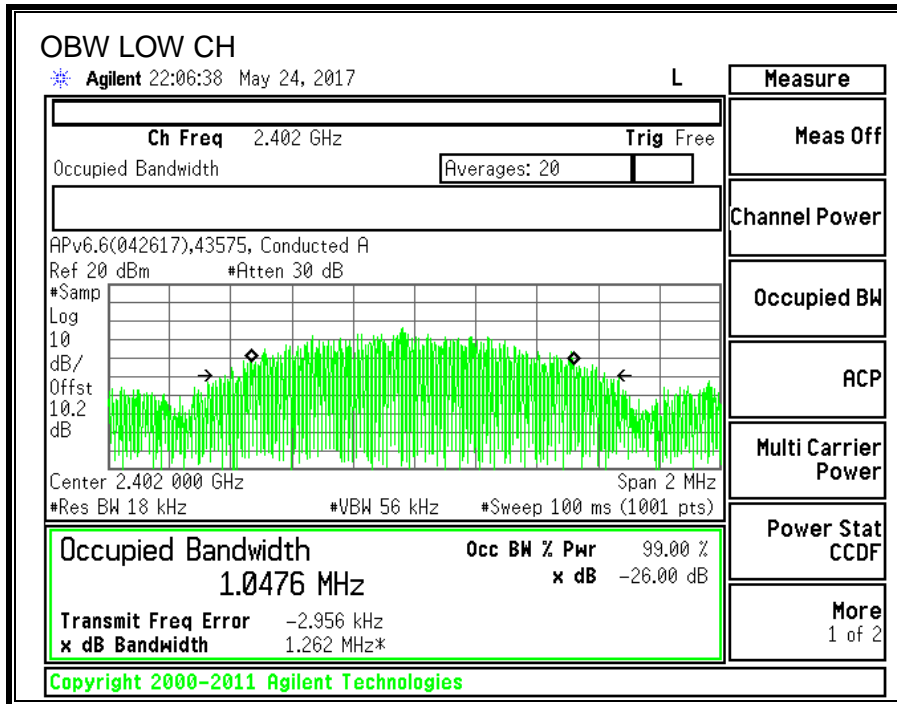

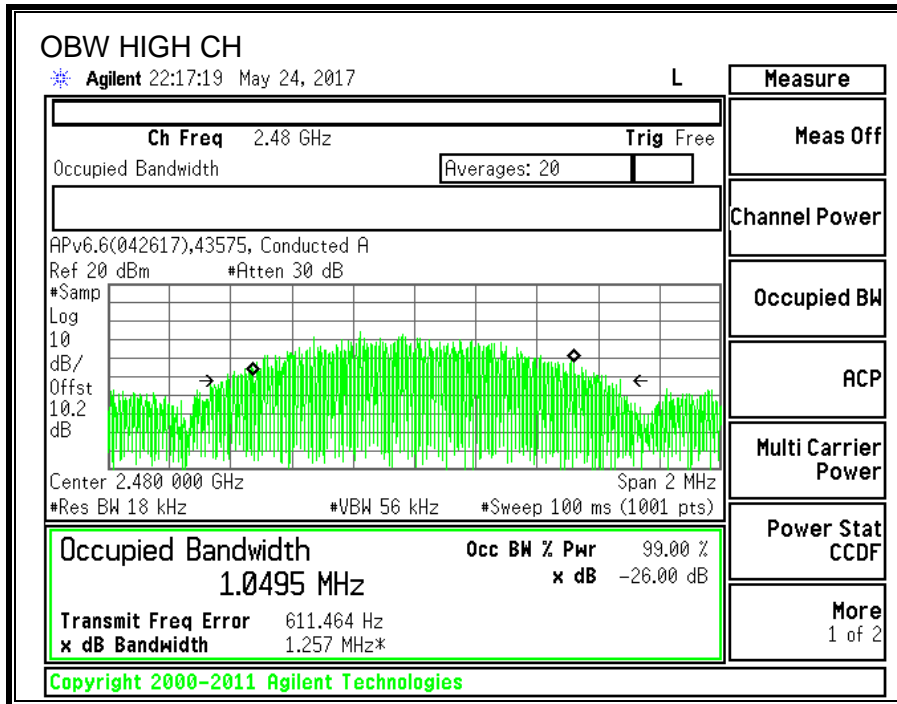

8.3.3. AVERAGE POWER

LIMITS

None; for reporting purposes only.

The cable assembly insertion loss of 10.6 dB (including 10 dB pad and 0.6 dB cable) was entered as an offset in the power meter to allow for direct reading of power.

RESULTS

TEST ENGINEER:	43574	Date:	5/24/17
-----------------------	-------	--------------	---------

Channel	Frequency (MHz)	AV Power (dBm)
Low	2402	2.6
Middle	2440	4.0
High	2480	1.3

8.3.4. OUTPUT POWER

LIMITS

FCC §15.247 (b)
 IC RSS-247 (5.4) (d)

The maximum antenna gain is less than or equal to 6 dBi, therefore the limit is 30 dBm.

RESULTS

OUTPUT POWER

Channel	Frequency (MHz)	Peak Power Reading (dBm)	Limit (dBm)	Margin (dB)
Low	2402	3.22	30	-26.78
Middle	2440	4.59	30	-25.41
High	2480	1.47	30	-28.53

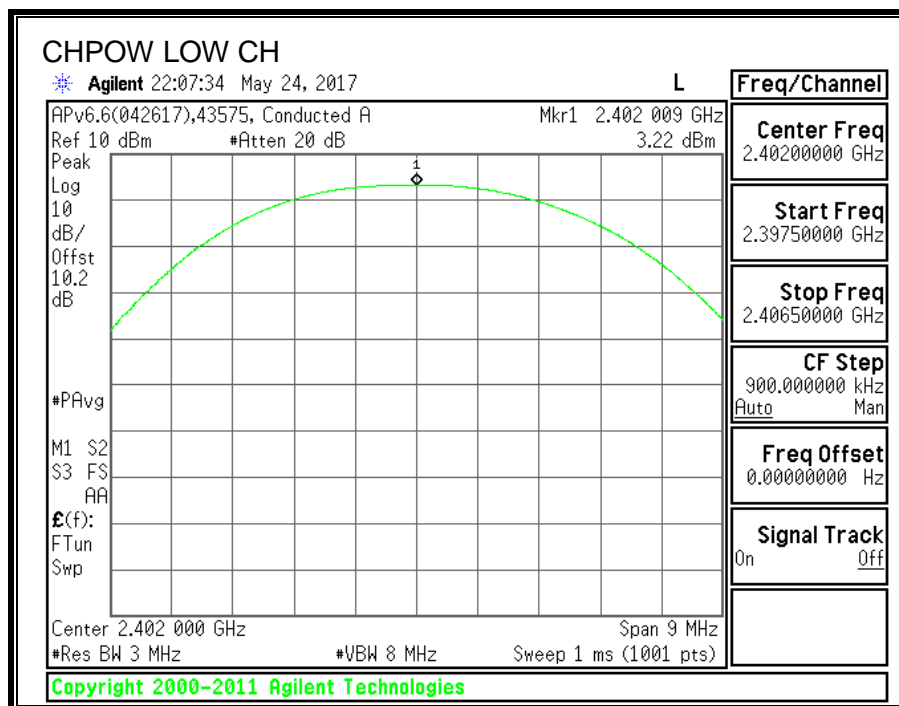

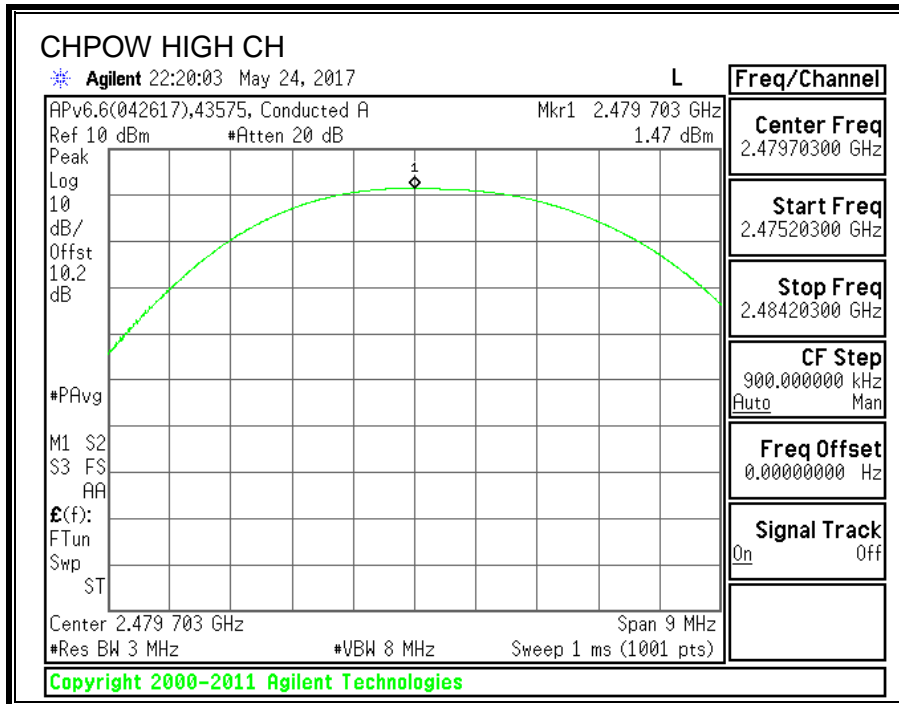
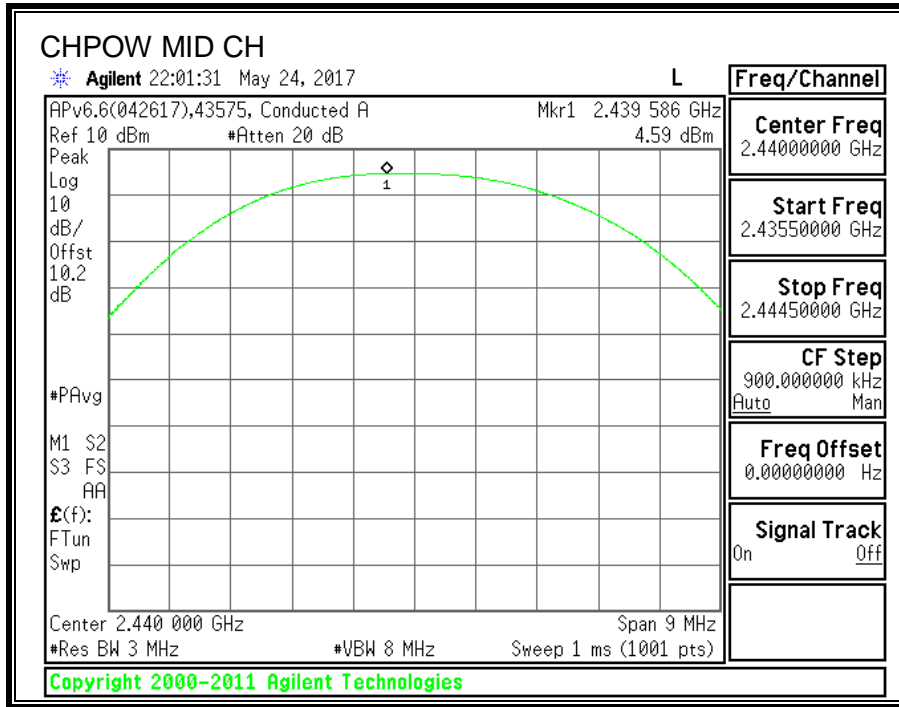

8.3.5. POWER SPECTRAL DENSITY

LIMITS

FCC §15.247 (e)
IC RSS-247 (5.2) (b)

The power spectral density conducted from the transmitter to the antenna shall not be greater than 8 dBm in any 3 kHz band during any time interval of continuous transmission.

RESULTS

POWER SPECTRAL DENSITY

Channel	Frequency (MHz)	PSD (dBm)	Limit (dBm)	Margin (dB)
Low	2402	-11.14	8	-19.14
Middle	2440	-9.81	8	-17.81
High	2480	-12.97	8	-20.97

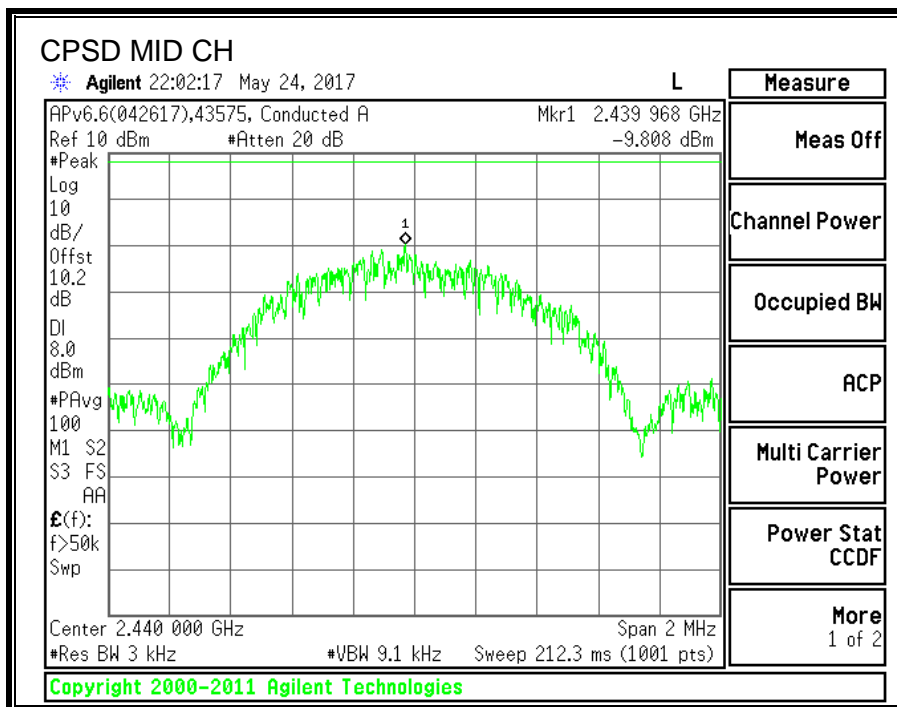
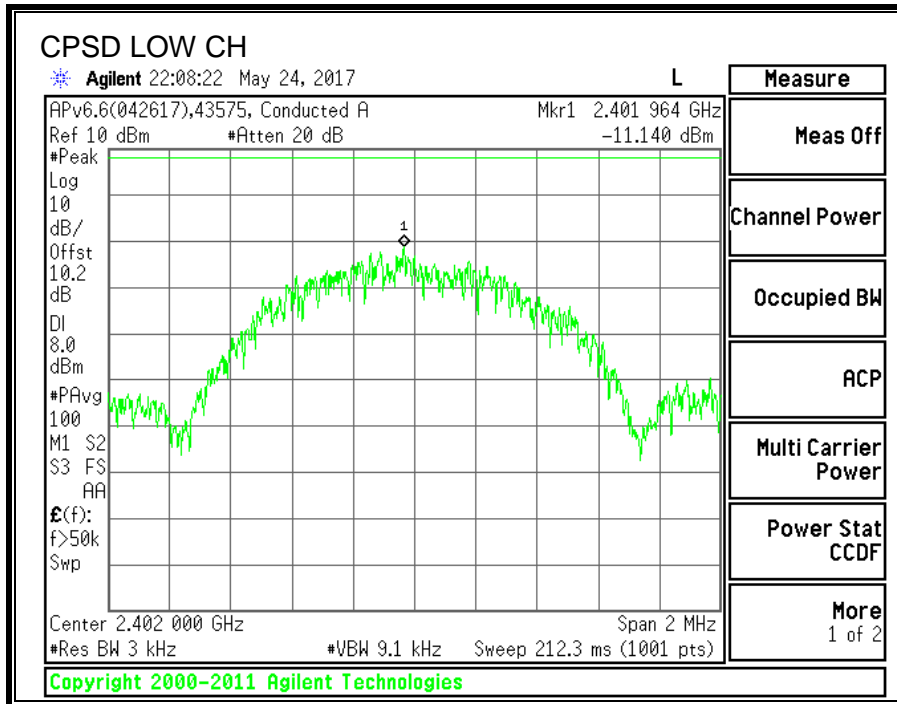

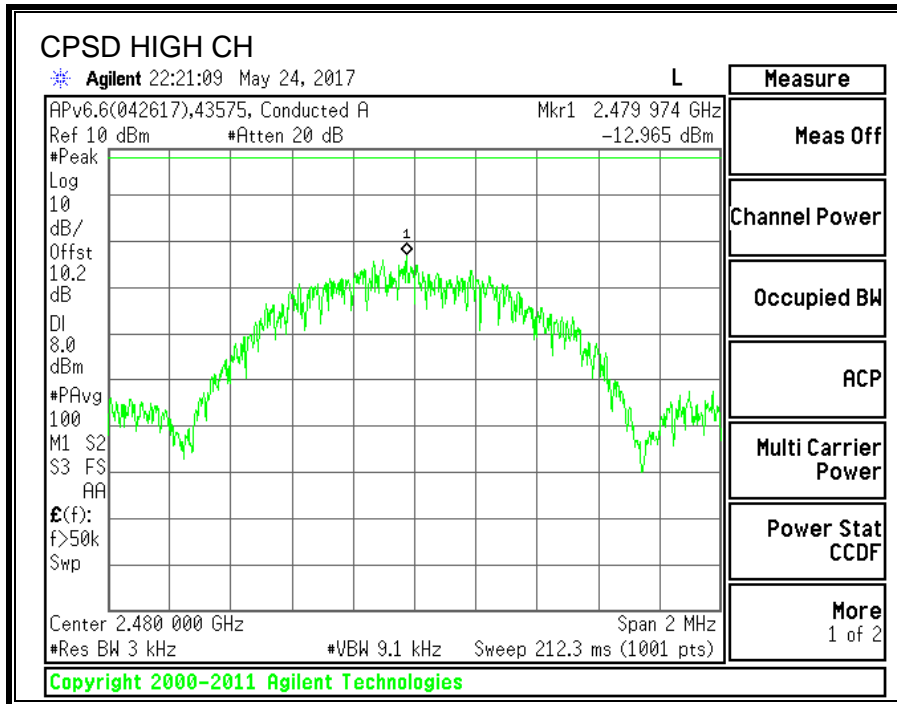

8.3.6. CONDUCTED BANDEGE AND SPURIOUS EMISSIONS

LIMITS

FCC §15.247 (d)
 IC RSS-247 (5.5)

Output power was measured based on the use of a peak measurement, therefore the required attenuation is 20 dB.

RESULTS

CONDUCTED BANDEGE AND SPURIOUS EMISSIONS

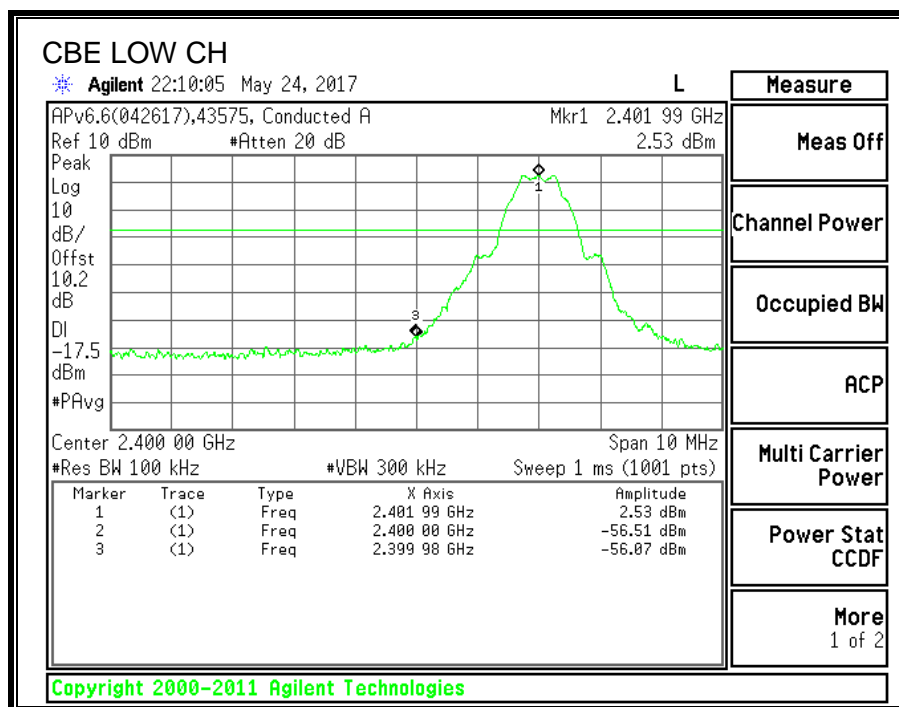

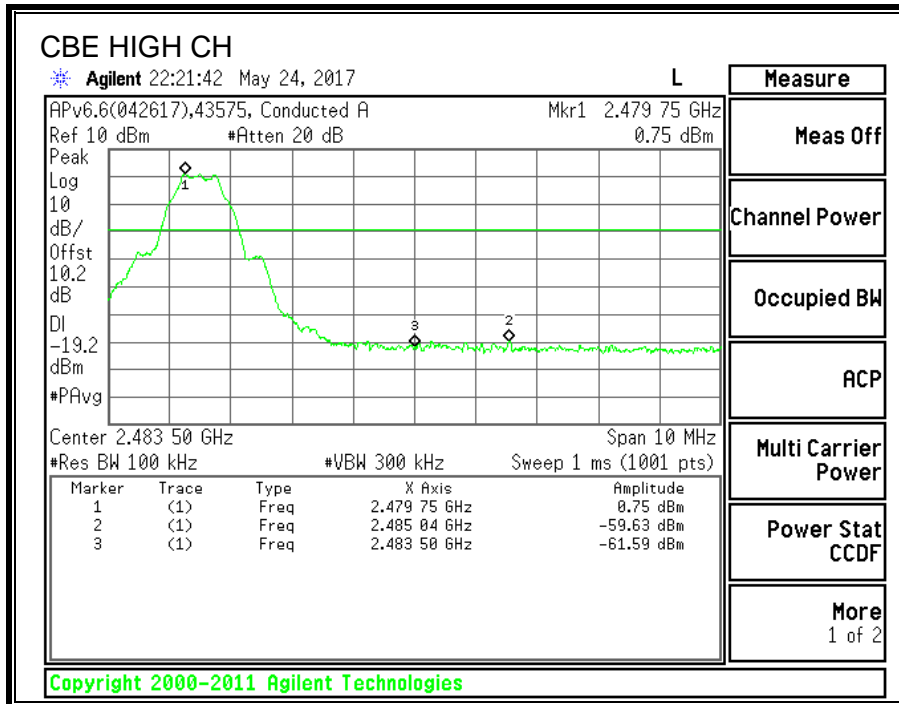
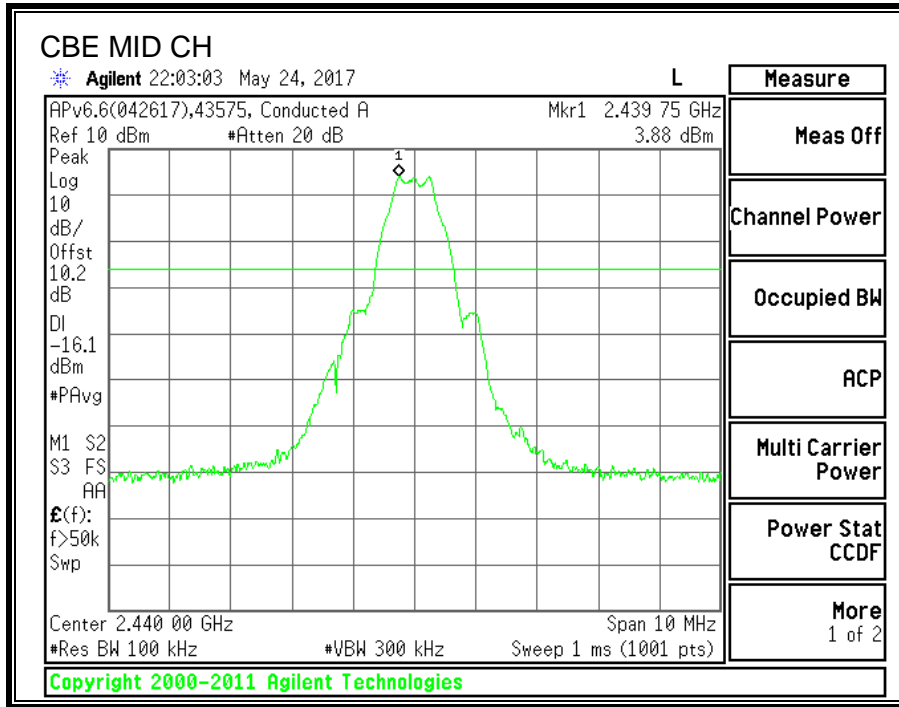

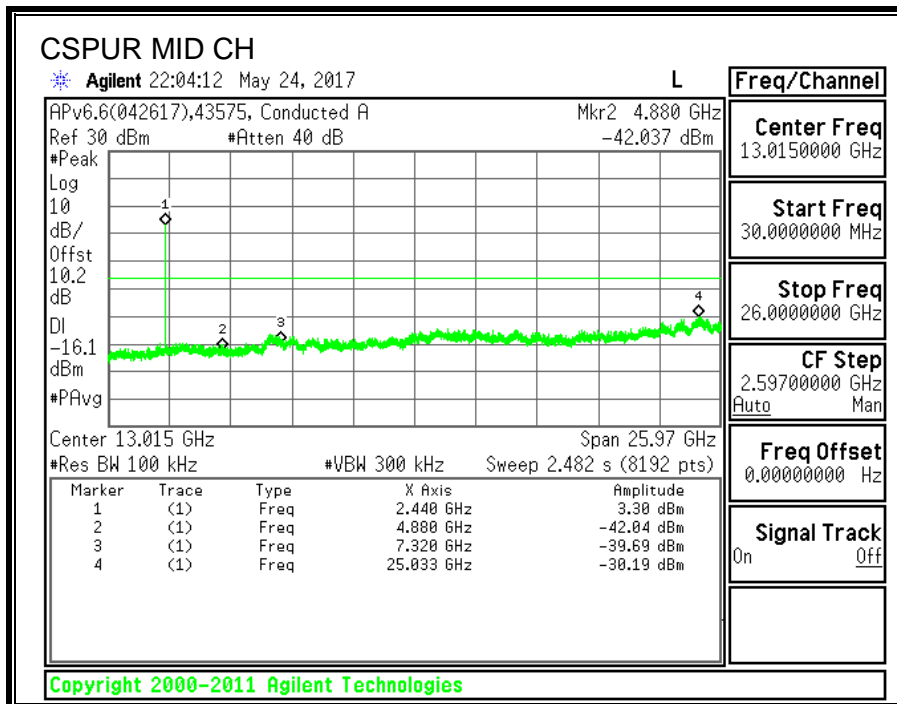
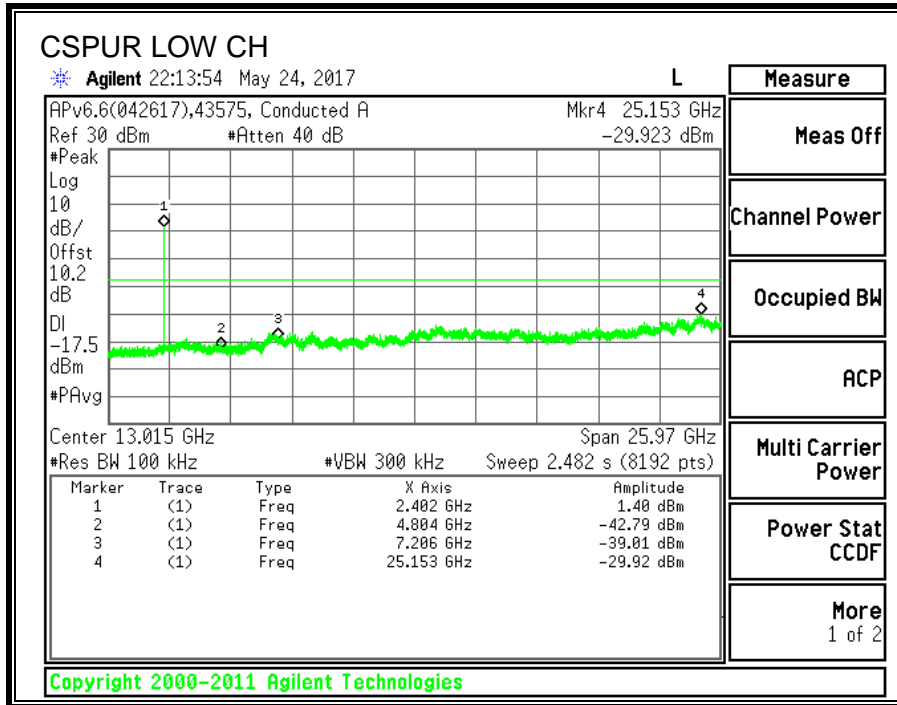

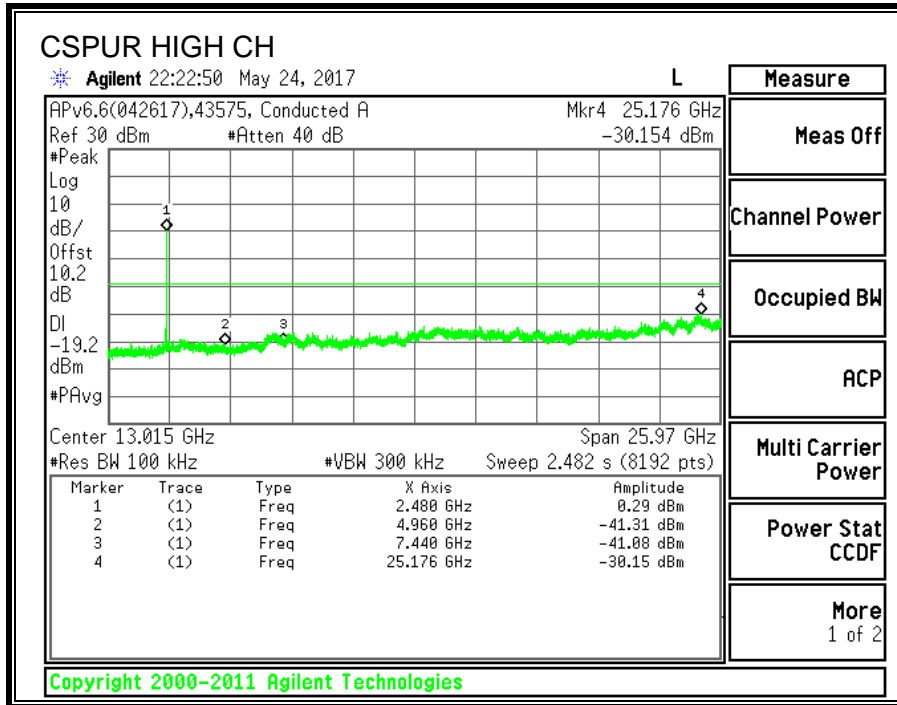

9. RADIATED TEST RESULTS

9.1. LIMITS AND PROCEDURE

LIMITS

FCC §15.205 and §15.209
 IC RSS-GEN, Section 8.9 and 8.10.

Frequency Range (MHz)	Field Strength Limit (uV/m) at 3 m	Field Strength Limit (dBuV/m) at 3 m
0.009-0.490	2400/F(kHz) @ 300m	2400/F(kHz) @ 300m
0.490-1.705	24000/F(kHz) @ 30m	24000/F(kHz) @ 30m
1.705-30.0	30 @ 30m	30 @ 30m
30 - 88	100	40
88 - 216	150	43.5
216 - 960	200	46
Above 960	500	54

NOTE: KDB 414788 D01 OATS and Chamber Correlation Justification

- Based on FCC 15.31 (f) (2): measurements may be performed at a distance closer than that specified in the regulations; however, an attempt should be made to avoid making measurements in the near field.
- OATs and chamber correlation testing had been performed and chamber measured test result is the worst case test result.

TEST PROCEDURE

The EUT is placed on a non-conducting table 80 cm above the ground plane for measurement below 1GHz; 1.5 m above the ground plane for measurement above 1GHz. The antenna to EUT distance is 3 meters. The EUT is configured in accordance with ANSI C63.10. The EUT is set to transmit in a continuous mode.

For measurements below 1 GHz the resolution bandwidth is set to 120 kHz for peak detection measurements or 120 kHz for quasi-peak detection measurements for the 30-1000 MHz range, 9 kHz for peak detection measurements or 9 kHz for quasi-peak detection measurements for the 0.15-30 MHz range and 200 Hz for peak detection measurements or 200 Hz for quasi-peak detection measurements for the 9 to 150 kHz range. Peak detection is used unless otherwise noted as quasi-peak.

For pre-scans above 1 GHz the resolution bandwidth is set to 1 MHz; the video bandwidth is set to 30 KHz for peak measurements.

For final measurements above 1 GHz the resolution bandwidth is set to 1 MHz; the video bandwidth is set to 3 MHz for peak measurements and as applicable for average measurements.

The spectrum from 1 GHz to 18 GHz is investigated with the transmitter set to the lowest, middle, and highest channels in each applicable band. Below 1GHz and above 18GHz emissions, the channel with the highest output power was tested.

The frequency range of interest is monitored at a fixed antenna height and EUT azimuth. The EUT is rotated through 360 degrees to maximize emissions received. The antenna is scanned from 1 to 4 meters above the ground plane to further maximize the emission. Measurements are made with the antenna polarized in both the vertical and the horizontal positions.

9.2. SPURIOUS EMISSIONS BELOW 30 MHz (WORST-CASE CONFIGURATION)

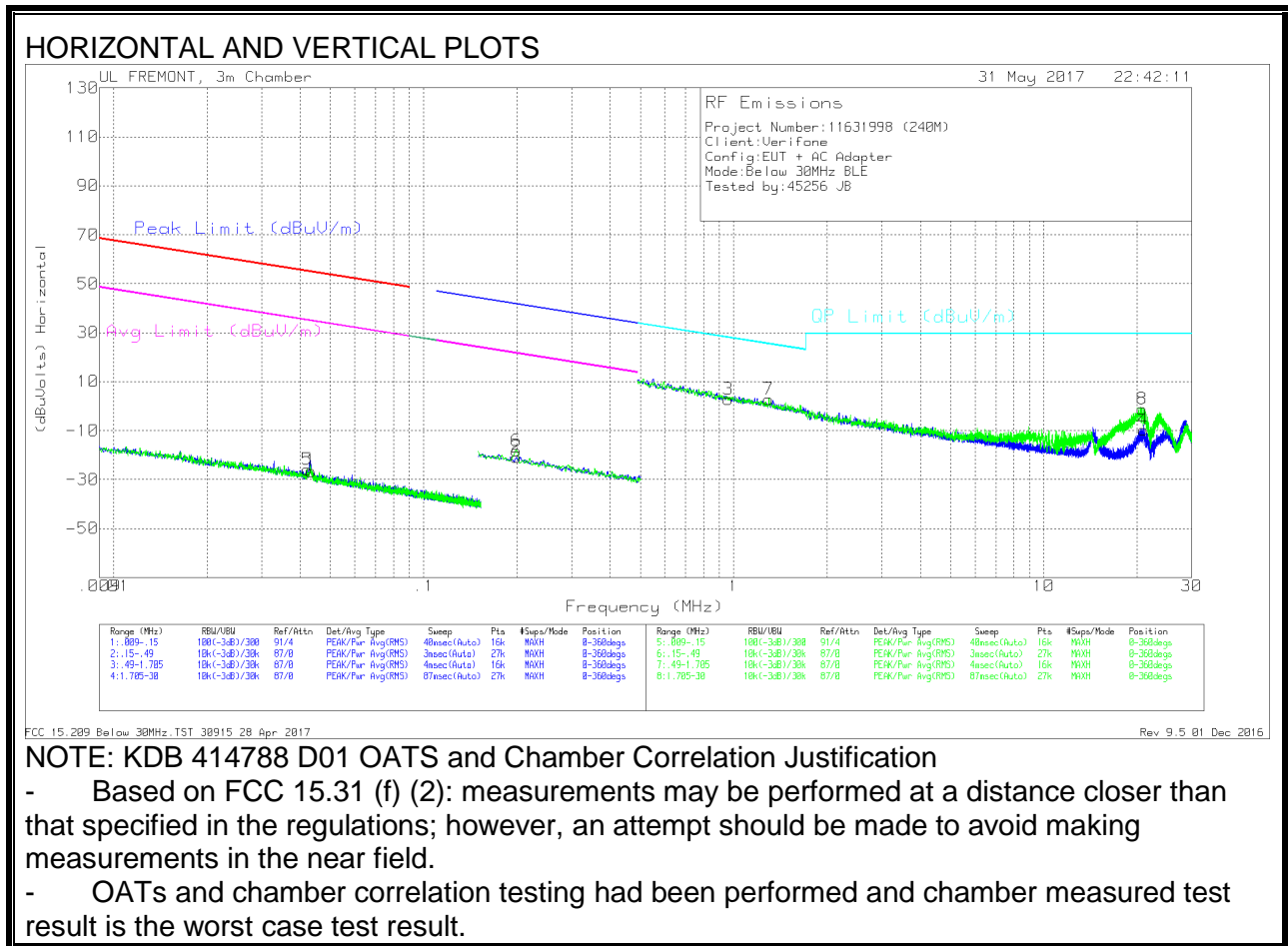

Trace Markers

Marker	Frequency (MHz)	Meter Reading (dBuV)	Det	Loop Antenna (dB/m)	Cbl (dB)	Dist Corr 300m	Corrected Reading (dBuV/m)	Peak Limit (dBuV/m)	Margin (dB)	Avg Limit (dBuV/m)	Margin (dB)	QP Limit (dBuV/m)	Margin (dB)	QP Limit (dBuV/m)	Margin (dB)	Peak Limit (dBuV/m)	Margin (dB)	Avg Limit (dBuV/m)	Margin (dB)	Azimuth (Degs)	
5	0.04218	39.53	Pk	13.2	1.4	-80	-25.87	55.08	-80.95	35.08	-60.95	-	-	-	-	-	-	-	-	-	0-360
1	0.0434	39.01	Pk	13	1.4	-80	-26.59	54.84	-81.43	34.84	-61.43	-	-	-	-	-	-	-	-	-	0-360
6	0.19921	48.79	Pk	11.6	1.5	-80	-18.11	-	-	-	-	-	-	-	-	41.63	-59.74	21.63	-39.74	-	0-360
2	0.19929	45.92	Pk	11.6	1.5	-80	-20.98	-	-	-	-	-	-	-	-	41.63	-62.61	21.63	-42.61	-	0-360

Pk - Peak detector

Marker	Frequency (MHz)	Meter Reading (dBuV)	Det	Loop Antenna (dB/m)	Cbl (dB)	Dist Corr 30m	Corrected Reading (dBuV/m)	Peak Limit (dBuV/m)	Margin (dB)	Avg Limit (dBuV/m)	Margin (dB)	QP Limit (dBuV/m)	Margin (dB)	QP Limit (dBuV/m)	Margin (dB)	Peak Limit (dBuV/m)	Margin (dB)	Avg Limit (dBuV/m)	Margin (dB)	Azimuth (Degs)	
3	0.9604	29.76	Pk	11.5	1.5	-40	2.76	-	-	-	-	-	-	27.97	-25.21	-	-	-	-	-	0-360
7	1.29659	29.88	Pk	11.5	1.5	-40	2.88	-	-	-	-	-	-	25.37	-22.49	-	-	-	-	-	0-360
8	20.7776	27.52	Pk	9.6	1.7	-40	-1.18	-	-	-	-	-	-	29.5	-30.68	-	-	-	-	-	0-360
4	20.9693	19.2	Pk	9.5	1.7	-40	-9.6	-	-	-	-	-	-	29.5	-39.1	-	-	-	-	-	0-360

Pk - Peak detector

9.2.1. SPURIOUS EMISSIONS 30 TO 1000 MHz (WORST-CASE CONFIGURATION)

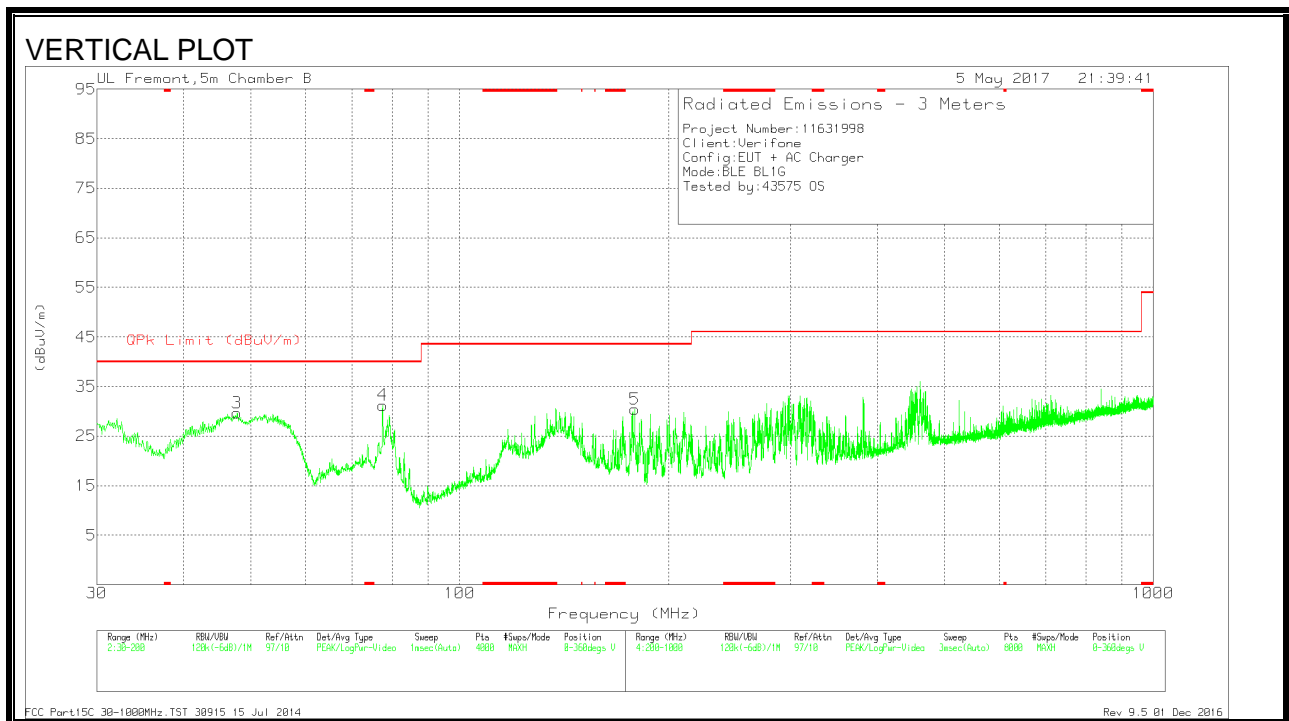
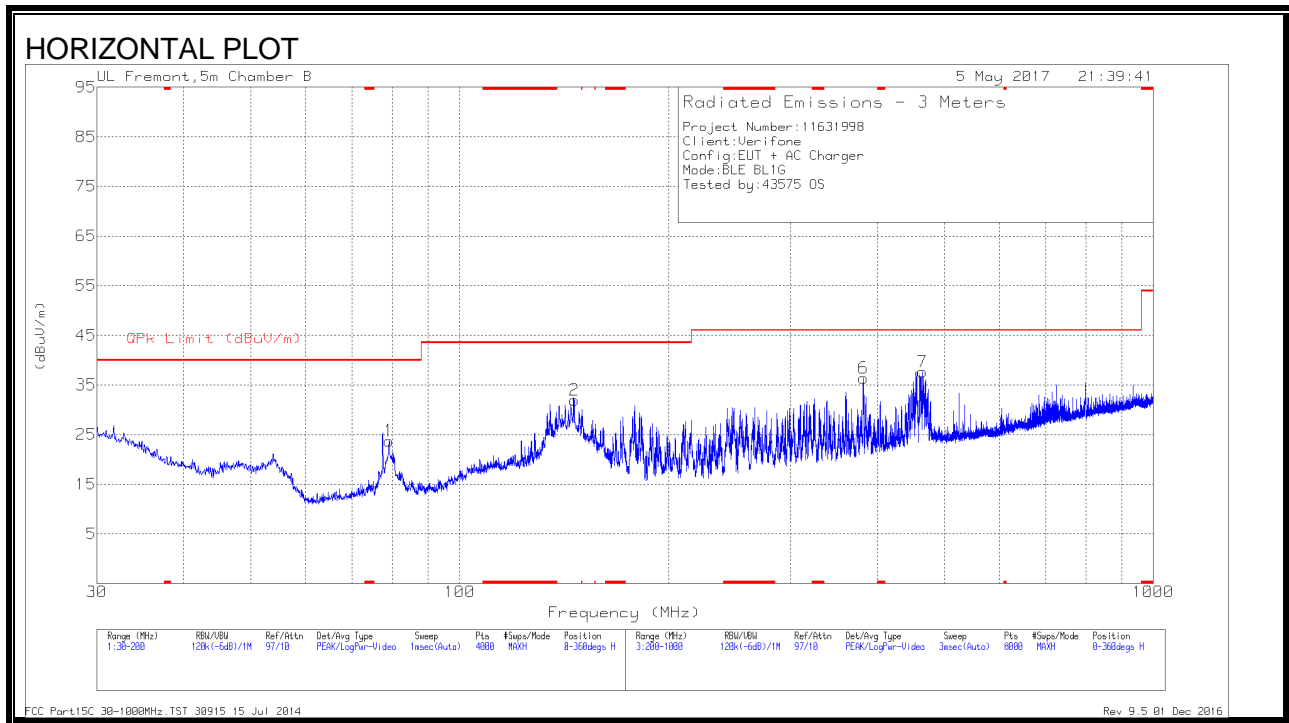

Trace Markers

Marker	Frequency (MHz)	Meter Reading (dBuV)	Det	AF T477 (dB/m)	Amp/Cbl (dB)	Corrected Reading (dBuV/m)	QPk Limit (dBuV/m)	Margin (dB)	Azimuth (Degs)	Height (cm)	Polarity
3	47.7696	45.34	Pk	12.9	-28.6	29.64	40	-10.36	0-360	100	V
4	77.4423	47.75	Pk	11.7	-28.2	31.25	40	-8.75	0-360	100	V
1	79.1852	40.46	Pk	11.5	-28.2	23.76	40	-16.24	0-360	400	H
2	146.3101	42.78	Pk	16.6	-27.4	31.98	43.52	-11.54	0-360	200	H
5	178.831	42.27	Pk	15.2	-27	30.47	43.52	-13.05	0-360	100	V
6	382.5237	43.44	Pk	19	-26	36.44	46.02	-9.58	0-360	100	H
7	464.6344	42.59	Pk	21.1	-26	37.69	46.02	-8.33	0-360	200	H

Pk - Peak detector

9.2.2. TRANSMITTER ABOVE 1 GHz

BANDEDGE (LOW CHANNEL)

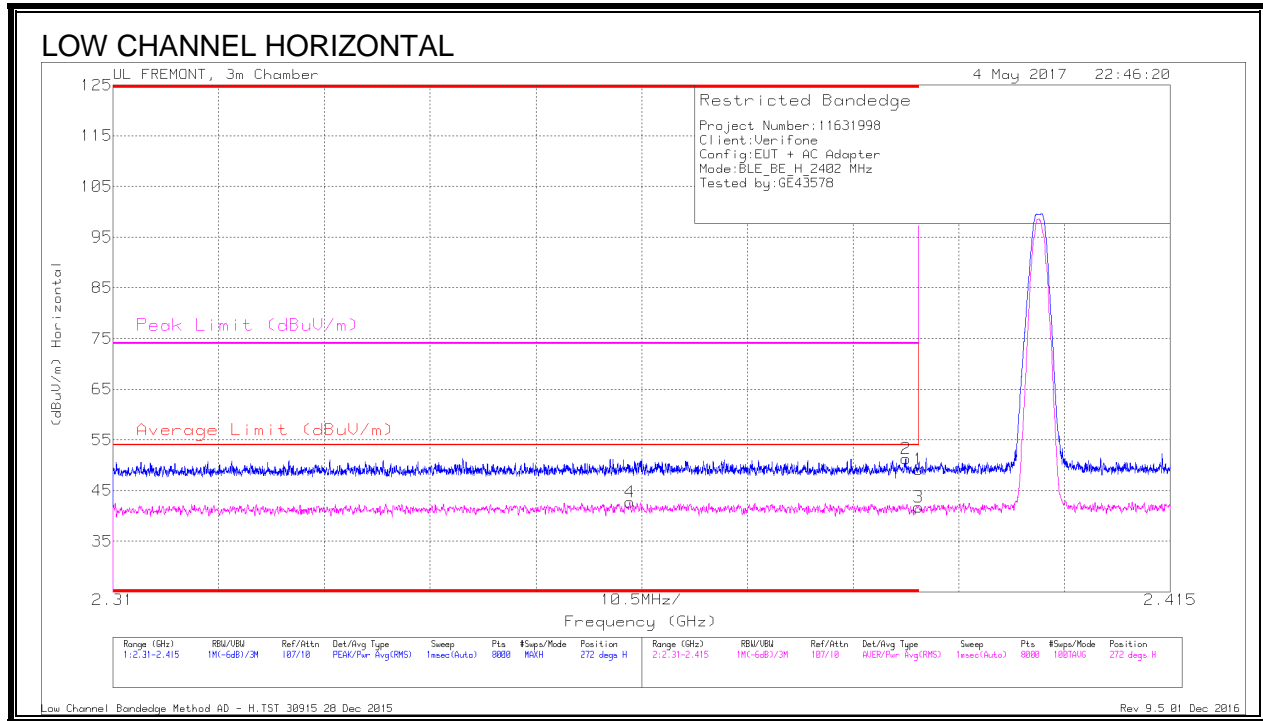

Trace Markers

Marker	Frequency (GHz)	Meter Reading (dBuV)	Det	AF T712 (dBm)	Amp/Cb/Filt/Pad (dB)	DC Corr (dB)	Corrected Reading (dBuV/m)	Average Limit (dBuV/m)	Margin (dB)	Peak Limit (dBuV/m)	PK Margin (dB)	Azimuth (Degs)	Height (cm)	Polarity
1	* 2.39	38.09	Pk	31.9	-20.8	0	49.19	-	-	74	-24.81	272	189	H
2	* 2.389	40.19	Pk	31.9	-20.8	0	51.29	-	-	74	-22.71	272	189	H
3	* 2.39	28.73	RMS	31.9	-20.8	1.95	41.78	54	-12.22	-	-	272	189	H
4	* 2.361	29.63	RMS	31.9	-20.8	1.95	42.68	54	-11.32	-	-	272	189	H

* - indicates frequency in CFR47 Pt 15 / IC RSS-Restricted Band

Pk - Peak detector

RMS - RMS detection

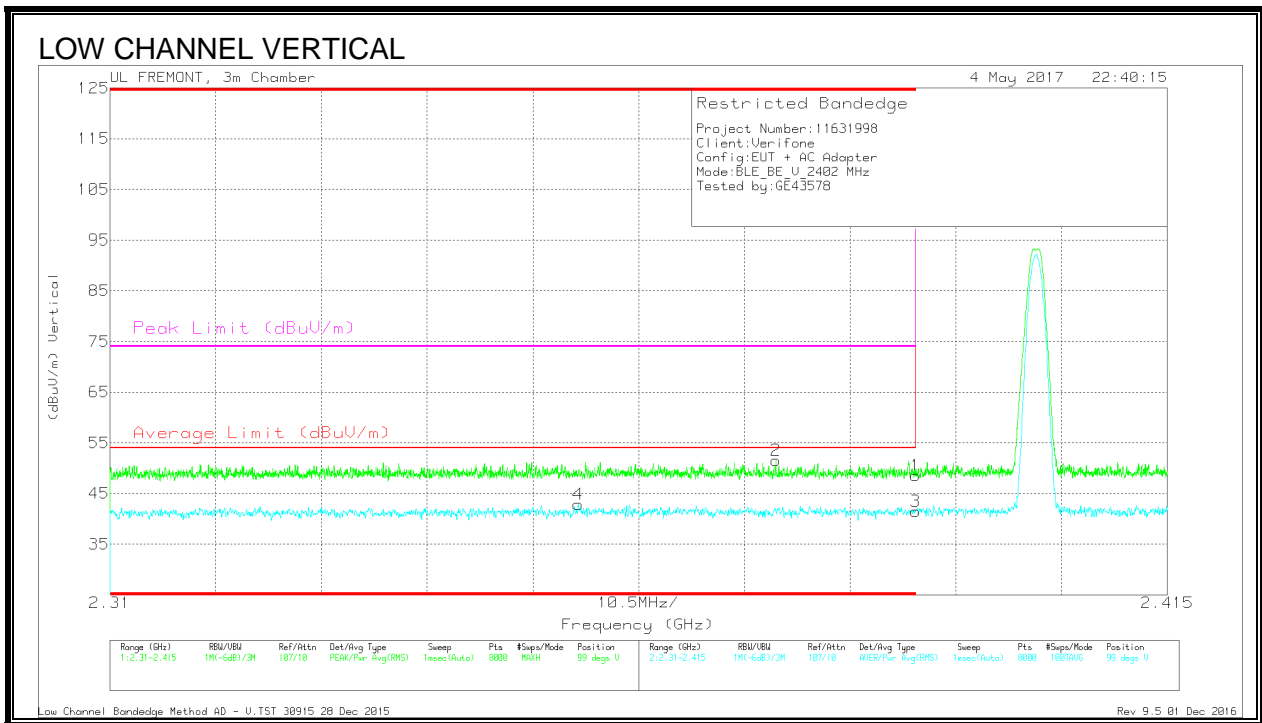

Trace Markers

Marker	Frequency (GHz)	Meter Reading (dBuV)	Det	AF T712 (dBm)	Amp/CbWftr/Pad (dB)	DC Corr (dB)	Corrected Reading (dBuV/m)	Average Limit (dBuV/m)	Margin (dB)	Peak Limit (dBuV/m)	PK Margin (dB)	Azimuth (Degs)	Height (cm)	Polarity
1	* 2.39	37.51	Pk	31.9	-20.8	0	48.61	-	-	74	-25.39	99	138	V
2	* 2.376	40.51	Pk	31.9	-20.9	0	51.51	-	-	74	-22.49	99	138	V
3	* 2.39	28.4	RMS	31.9	-20.8	1.95	41.45	54	-12.55	-	-	99	138	V
4	* 2.356	29.74	RMS	31.9	-20.8	1.95	42.79	54	-11.21	-	-	99	138	V

* - indicates frequency in CFR47 Pt 15 / IC RSS-Restricted Band
 Pk - Peak detector
 RMS - RMS detection

BANDEDGE (HIGH CHANNEL)

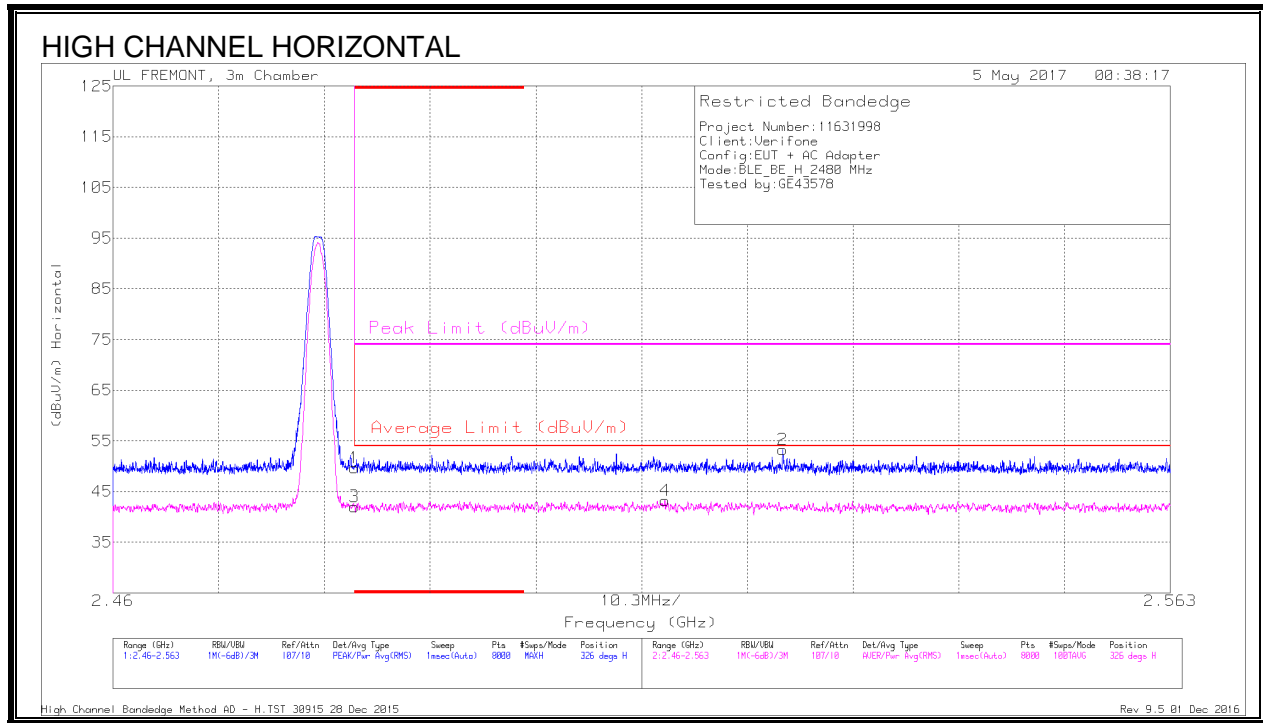

Trace Markers

Marker	Frequency (GHz)	Meter Reading (dBuV)	Det	AF T712 (dBm)	Ampl/Chl/Ftr/Pad (dB)	DC Corr (dB)	Corrected Reading (dBuV/m)	Average Limit (dBuV/m)	Margin (dB)	Peak Limit (dBuV/m)	PK Margin (dB)	Azimuth (Degs)	Height (cm)	Polarity
1	* 2.484	38.12	Pk	32.4	-20.8	0	49.72	-	-	74	-24.28	326	133	H
3	* 2.484	28.48	RMS	32.4	-20.8	1.95	42.03	54	-11.97	-	-	326	133	H
4	2.514	29.48	RMS	32.5	-20.7	1.95	43.23	54	-10.77	-	-	326	133	H
2	2.525	41.49	Pk	32.4	-20.6	0	53.29	-	-	74	-20.71	326	133	H

* - indicates frequency in CFR47 Pt 15 / IC RSS-Restricted Band
 Pk - Peak detector
 RMS - RMS detection

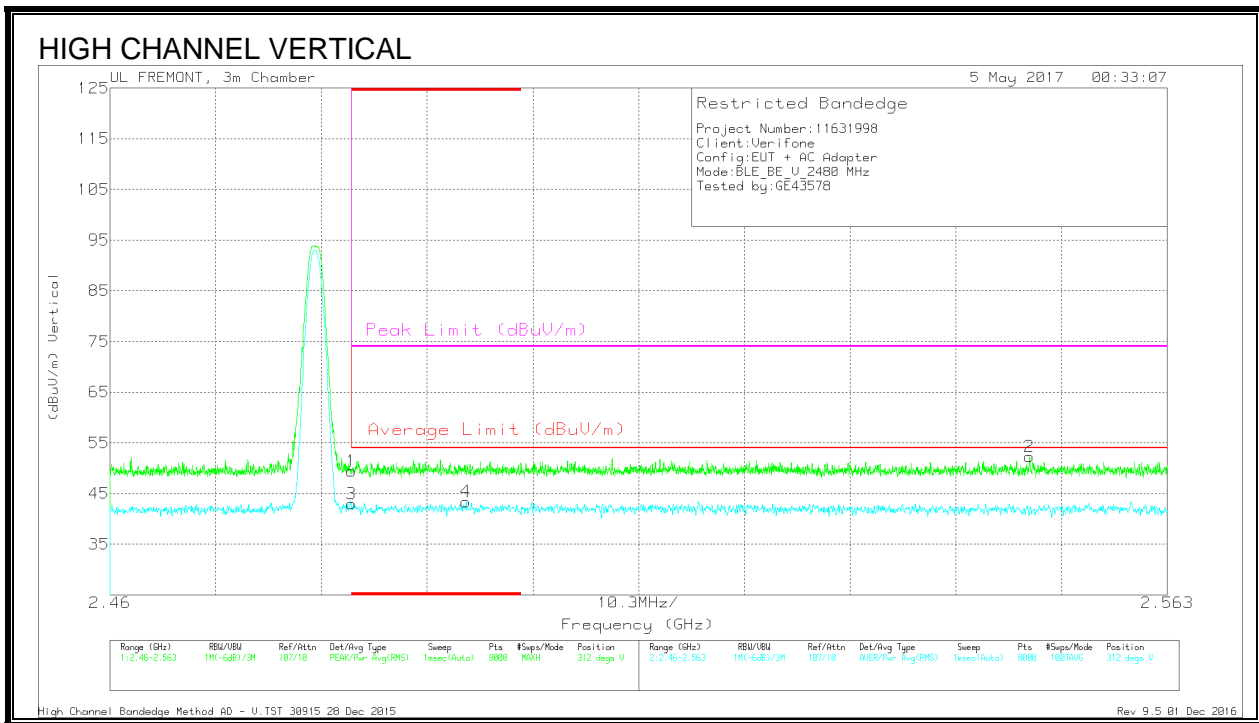

Trace Markers

Marker	Frequency (GHz)	Meter Reading (dBuV)	Det	AF T112 (dBm)	Amp/Cb1/Fit/Pad (dB)	DC Corr (dB)	Corrected Reading (dBuV/m)	Average Limit (dBuV/m)	Margin (dB)	Peak Limit (dBuV/m)	PK Margin (dB)	Azimuth (Degs)	Height (cm)	Polarity
1	* 2.484	37.82	Pk	32.4	-20.8	0	49.42	-	-	74	-24.58	312	136	V
3	* 2.484	29.4	RMS	32.4	-20.8	1.95	42.95	54	-11.05	-	-	312	136	V
4	* 2.495	29.75	RMS	32.5	-20.8	1.95	43.4	54	-10.6	-	-	312	136	V
2	2.55	40.55	Pk	32.4	-20.7	0	52.25	-	-	74	-21.75	312	136	V

* - indicates frequency in CFR47 Pt 15 / IC RSS-Restricted Band
 Pk - Peak detector
 RMS - RMS detection

HARMONICS AND SPURIOUS EMISSIONS 1 TO 18 GHz

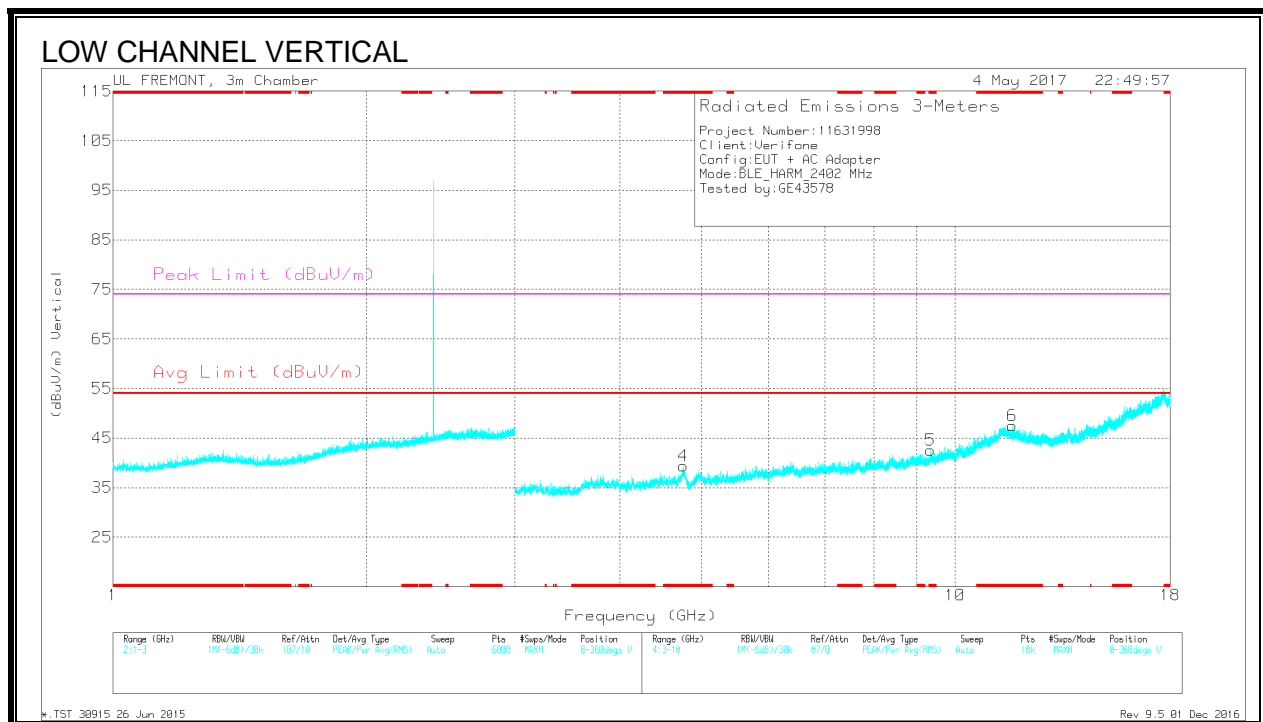
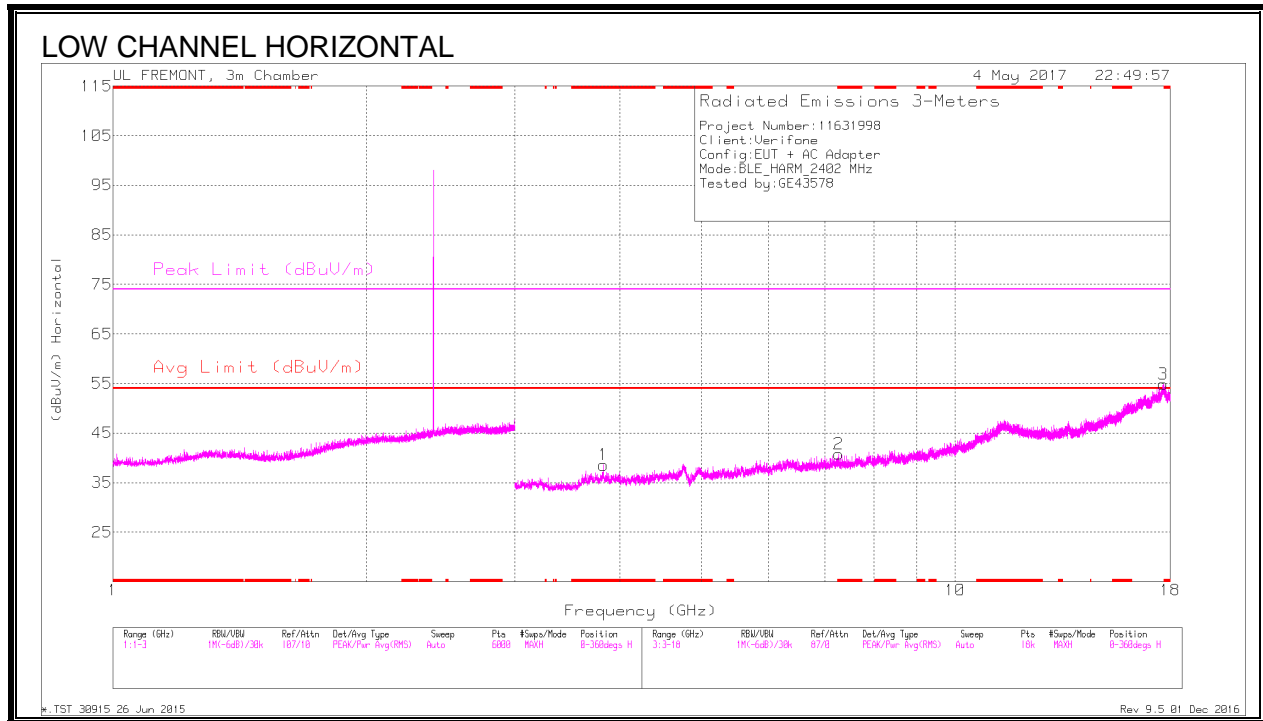

Radiated Emissions

Frequency (GHz)	Meter Reading (dBuV)	Det	AF T712 (dB/m)	Amp/Cbl/Filtr/ Pad (dB)	DC Corr (dB)	Corrected Reading (dBuV/m)	Avg Limit (dBuV/m)	Margin (dB)	Peak Limit (dBuV/m)	PK Margin (dB)	Azimuth (Degs)	Height (cm)	Polarity
* 3.825	39.23	PK2	33.4	-28.8	0	43.83	-	-	74	-30.17	242	100	H
* 3.825	27.16	MAv1	33.4	-28.8	1.95	33.71	54	-20.29	-	-	242	100	H
* 7.275	36.8	PK2	35.6	-26	0	46.4	-	-	74	-27.6	316	200	H
* 7.277	24.87	MAv1	35.6	-26.1	1.95	36.32	54	-17.68	-	-	316	200	H
* 4.751	40.16	PK2	34	-28.3	0	45.86	-	-	74	-28.14	42	100	V
* 4.753	28.38	MAv1	34	-28.4	1.95	35.93	54	-18.07	-	-	42	100	V
* 9.351	34.02	PK2	36.4	-21.6	0	48.82	-	-	74	-25.18	311	100	V
* 9.35	21.96	MAv1	36.4	-21.7	1.95	38.61	54	-15.39	-	-	311	100	V
* 11.68	32.85	PK2	38.3	-18.2	0	52.95	-	-	74	-21.05	263	100	V
* 11.681	20.92	MAv1	38.3	-18.2	1.95	42.97	54	-11.03	-	-	263	100	V
17.647	31.18	PK2	41.4	-11.3	0	61.28	-	-	-	-	114	200	H

* - indicates frequency in CFR15.205/RSS-GEN 8.10 -Restricted Band
 PK2 - KDB558074 Method: Maximum Peak
 MAv1 - KDB558074 Option 1 Maximum RMS Average

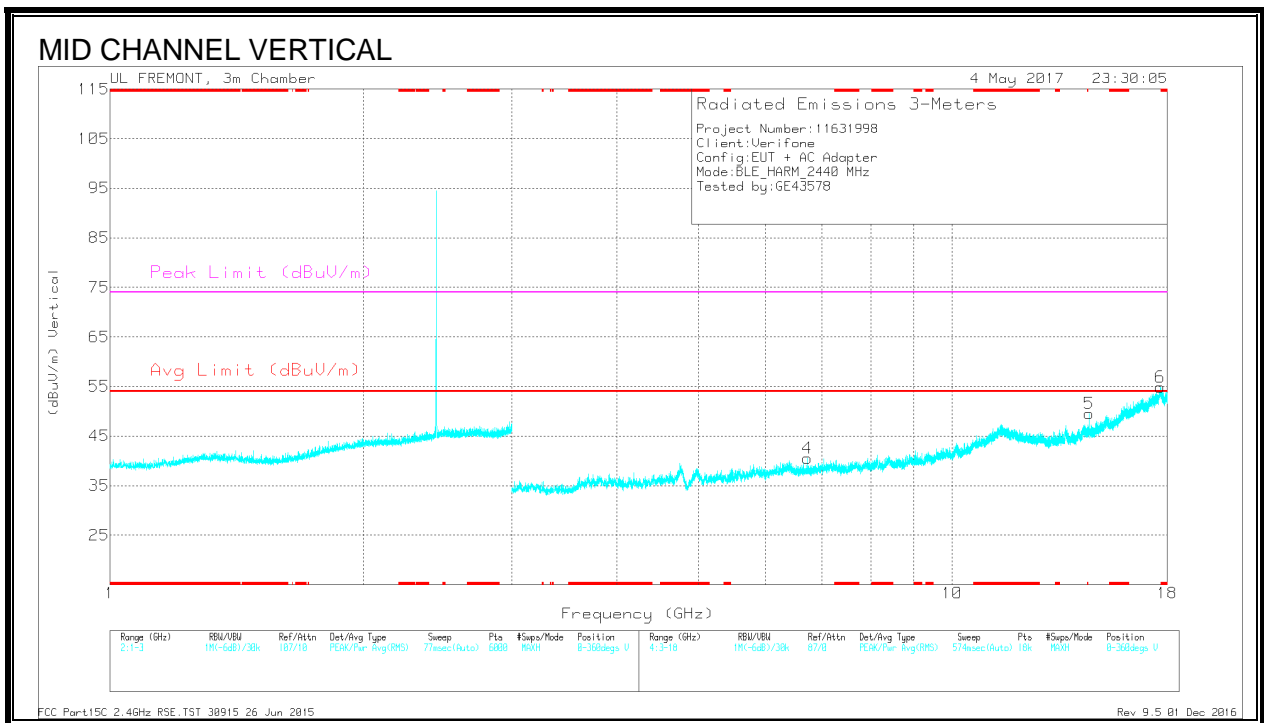
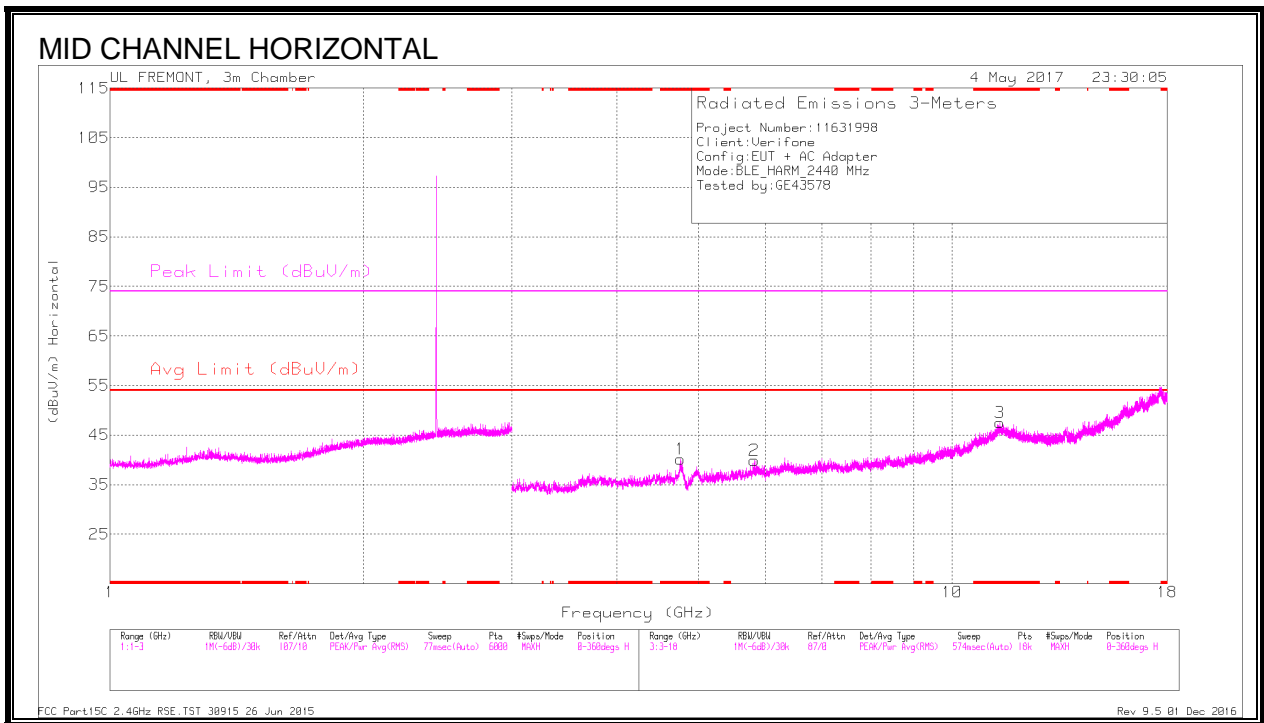

Radiated Emissions

Frequency (GHz)	Meter Reading (dBuV)	Det	AF T712 (dB/m)	Amp/Cbl/Filtr/ Pad (dB)	DC Corr (dB)	Corrected Reading (dBuV/m)	Avg Limit (dBuV/m)	Margin (dB)	Peak Limit (dBuV/m)	PK Margin (dB)	Azimuth (Degs)	Height (cm)	Polarity
* 4.76	40.76	PK2	34	-28.5	0	46.26	-	-	74	-27.74	297	200	H
* 4.76	28.24	MAv1	34	-28.5	1.95	35.69	54	-18.31	-	-	297	200	H
* 11.381	32.55	PK2	38	-17.1	0	53.45	-	-	74	-20.55	187	100	H
* 11.382	20.55	MAv1	38	-17.1	1.95	43.4	54	-10.6	-	-	187	100	H
5.819	37.22	PK2	34.8	-27.1	0	44.92	-	-	-	-	77	200	H
6.732	35.58	PK2	35.6	-25.7	0	45.48	-	-	-	-	28	200	V
14.536	31.85	PK2	39.5	-18.4	0	52.95	-	-	-	-	181	200	V
17.643	30.77	PK2	41.4	-11.3	0	60.87	-	-	-	-	352	200	V

* - indicates frequency in CFR15.205/RSS-GEN 8.10 -Restricted Band
 PK2 - KDB558074 Method: Maximum Peak
 MAv1 - KDB558074 Option 1 Maximum RMS Average

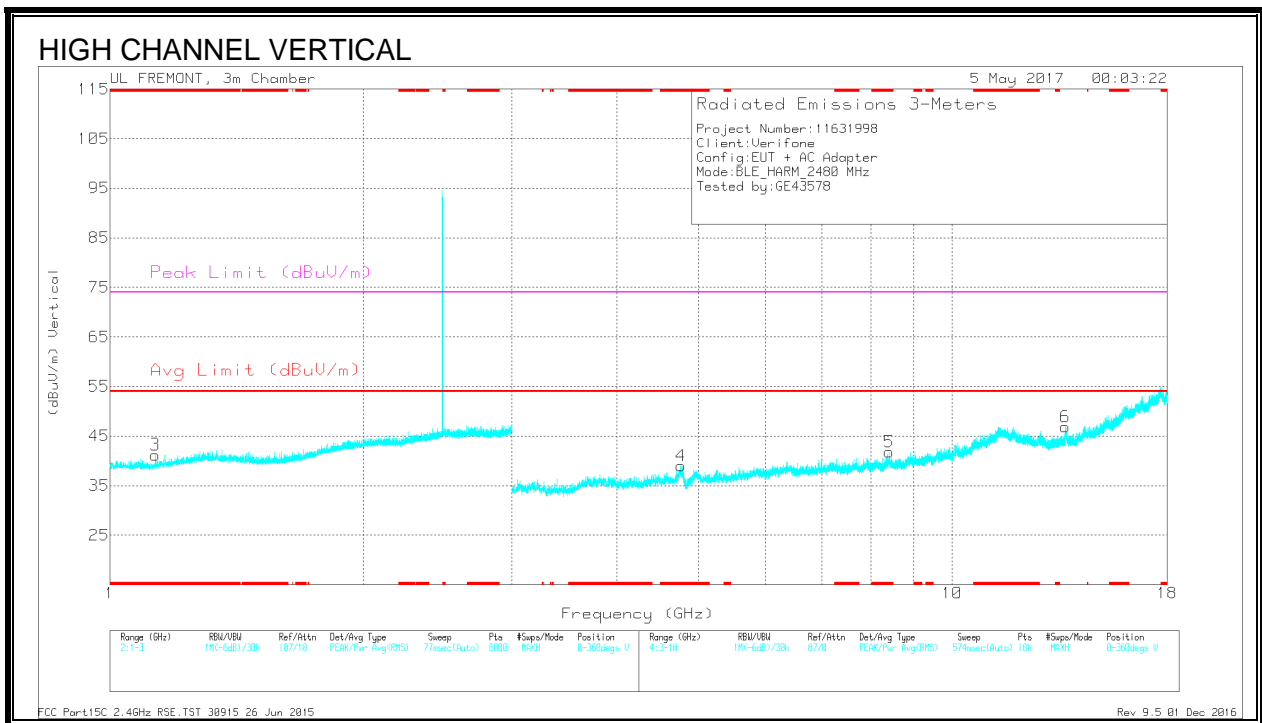
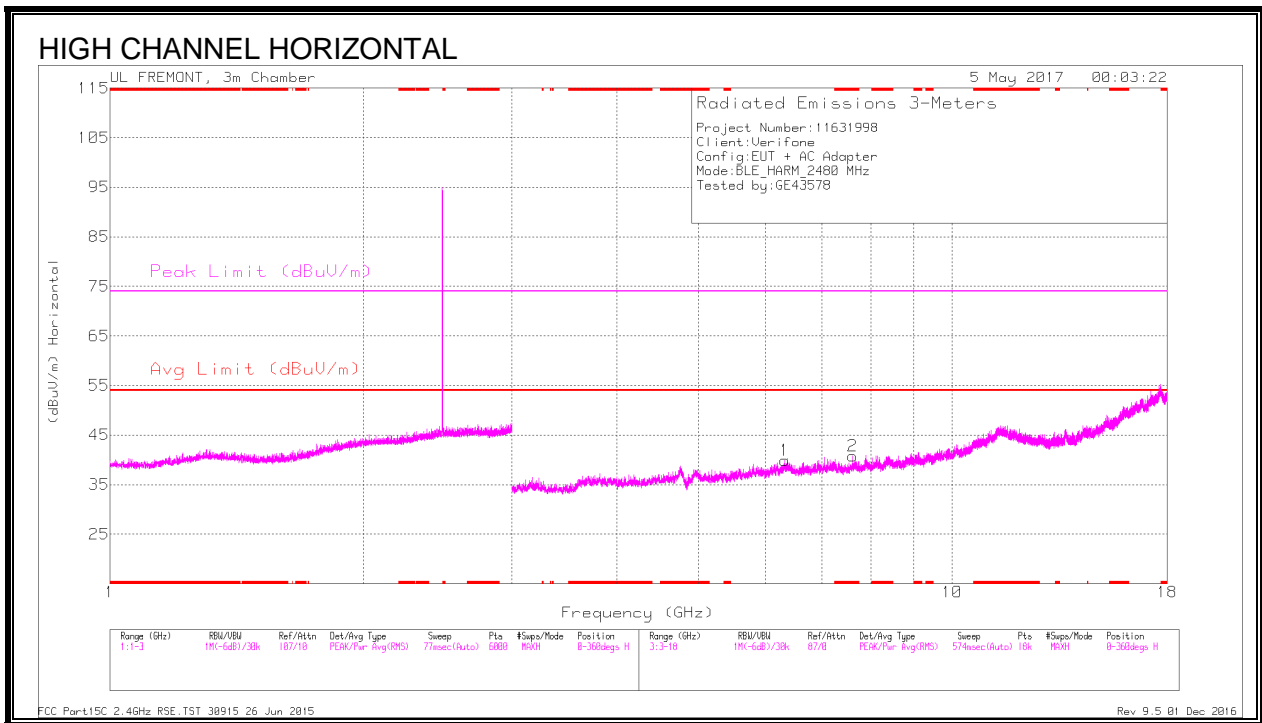

Radiated Emissions

Frequency (GHz)	Meter Reading (dBuV)	Det	AF T712 (dB/m)	Amp/Cbl/Filtr/ Pad (dB)	DC Corr (dB)	Corrected Reading (dBuV/m)	Avg Limit (dBuV/m)	Margin (dB)	Peak Limit (dBuV/m)	PK Margin (dB)	Azimuth (Degs)	Height (cm)	Polarity
* 1.132	41.35	PK2	27.6	-22.2	0	46.75	-	-	74	-27.25	129	200	V
* 1.13	29	MAv1	27.6	-22.2	1.95	36.35	54	-17.65	-	-	129	200	V
* 7.617	36.88	PK2	35.7	-25.1	0	47.48	-	-	74	-26.52	144	200	H
* 7.617	23.8	MAv1	35.7	-25.1	1.95	36.35	54	-17.65	-	-	144	200	H
* 4.767	40.35	PK2	34	-28.2	0	46.15	-	-	74	-27.85	219	100	V
* 4.767	27.99	MAv1	34	-28.2	1.95	35.74	54	-18.26	-	-	219	100	V
* 8.421	35.09	PK2	35.8	-23.1	0	47.79	-	-	74	-26.21	11	100	V
* 8.42	23.03	MAv1	35.8	-23.1	1.95	37.68	54	-16.32	-	-	11	100	V
6.325	36.96	PK2	35.6	-26.8	0	45.76	-	-	-	-	314	200	H
13.617	31.76	PK2	38.7	-18.3	0	52.16	-	-	-	-	139	100	V

* - indicates frequency in CFR15.205/RSS-GEN 8.10 -Restricted Band
 PK2 - KDB558074 Method: Maximum Peak
 MAv1 - KDB558074 Option 1 Maximum RMS Average

9.2.3. SPURIOUS EMISSIONS 18 TO 26 GHz (WORST-CASE CONFIGURATION)

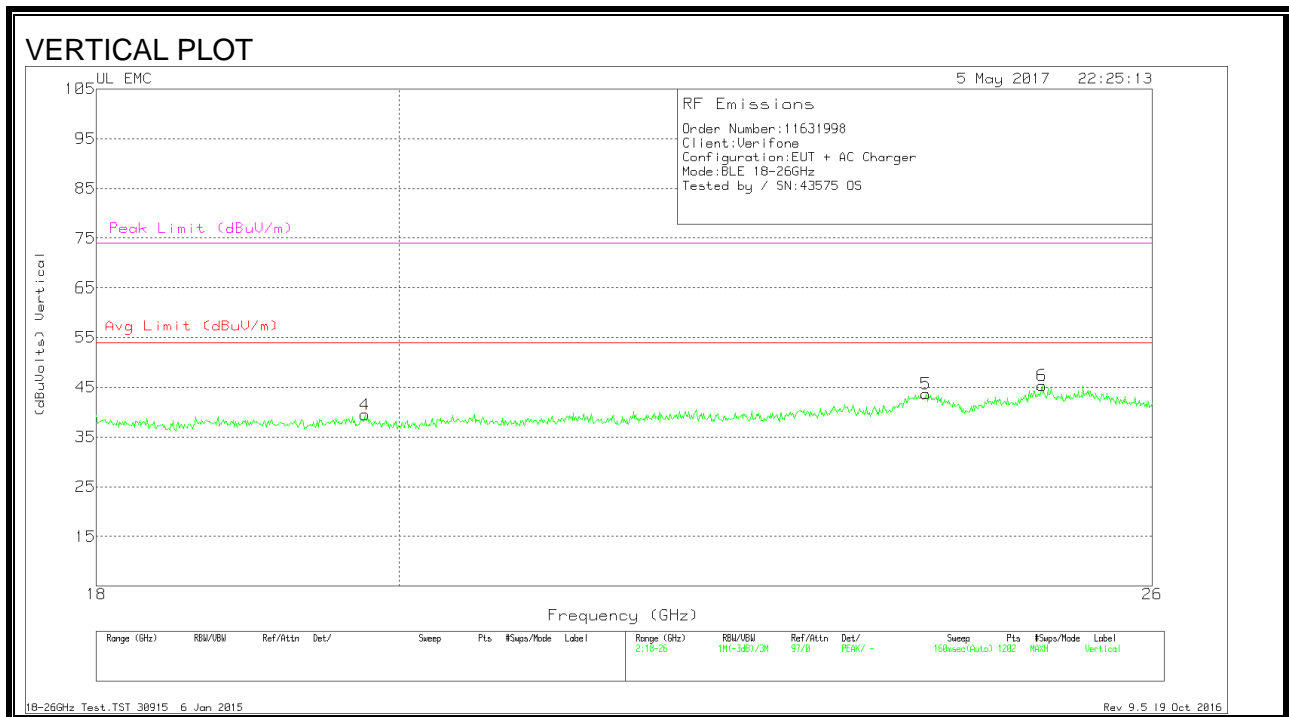
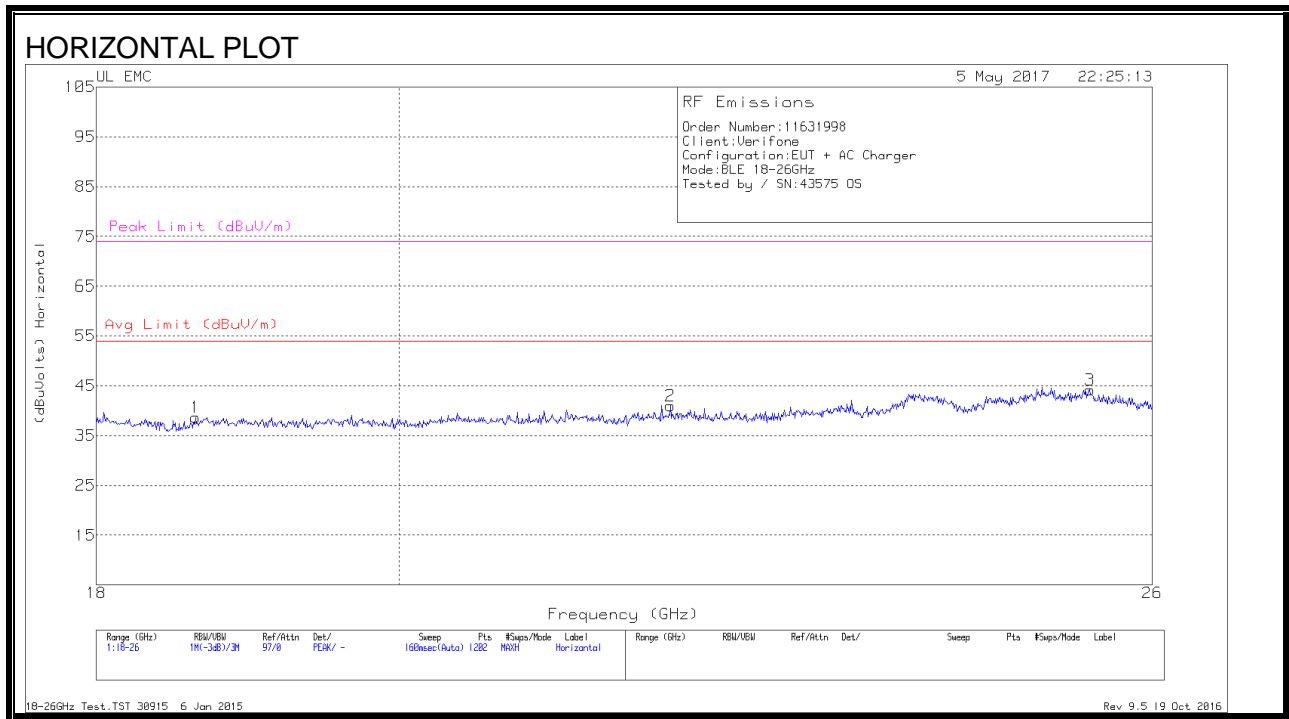

Trace Markers

Marker	Frequency (GHz)	Meter Reading (dBuV)	Det	AF T449 (dB/m)	Amp/Cbl (dB)	Dist Corr (dB)	Corrected Reading (dBuVolts)	Avg Limit (dBuV/m)	Margin (dB)	Peak Limit (dBuV/m)	PK Margin (dB)
1	18.633	40.47	Pk	32.5	-24.8	-9.5	38.667	54	-15.333	74	-35.333
2	21.983	42	Pk	33.5	-25	-9.5	41	54	-13	74	-33
3	25.44	43.57	Pk	34.4	-24.3	-9.5	44.167	54	-9.833	74	-29.833
4	19.765	41.1	Pk	32.7	-24.8	-9.5	39.5	54	-14.5	74	-34.5
5	24.028	43.27	Pk	34	-24.1	-9.5	43.667	54	-10.333	74	-30.333
6	25.021	45.03	Pk	34.2	-24.4	-9.5	45.333	54	-8.667	74	-28.667

Pk - Peak detector

9.3. AC POWER LINE CONDUCTED EMISSIONS

LIMITS

FCC §15.207 (a)
RSS-Gen 8.8

Frequency of Emission (MHz)	Conducted Limit (dB μ V)	
	Quasi-peak	Average
0.15-0.5	66 to 56 *	56 to 46 *
0.5-5	56	46
5-30	60	50

*Decreases with the logarithm of the frequency.

TEST PROCEDURE

The EUT is placed on a non-conducting table 40 cm from the vertical ground plane and 80 cm above the horizontal ground plane. The EUT is configured in accordance with ANSI C63.10.

The receiver is set to a resolution bandwidth of 9 kHz. Peak detection is used unless otherwise noted as quasi-peak or average.

Line conducted data is recorded for both NEUTRAL and HOT lines.

RESULTS

LINE 1 RESULTS

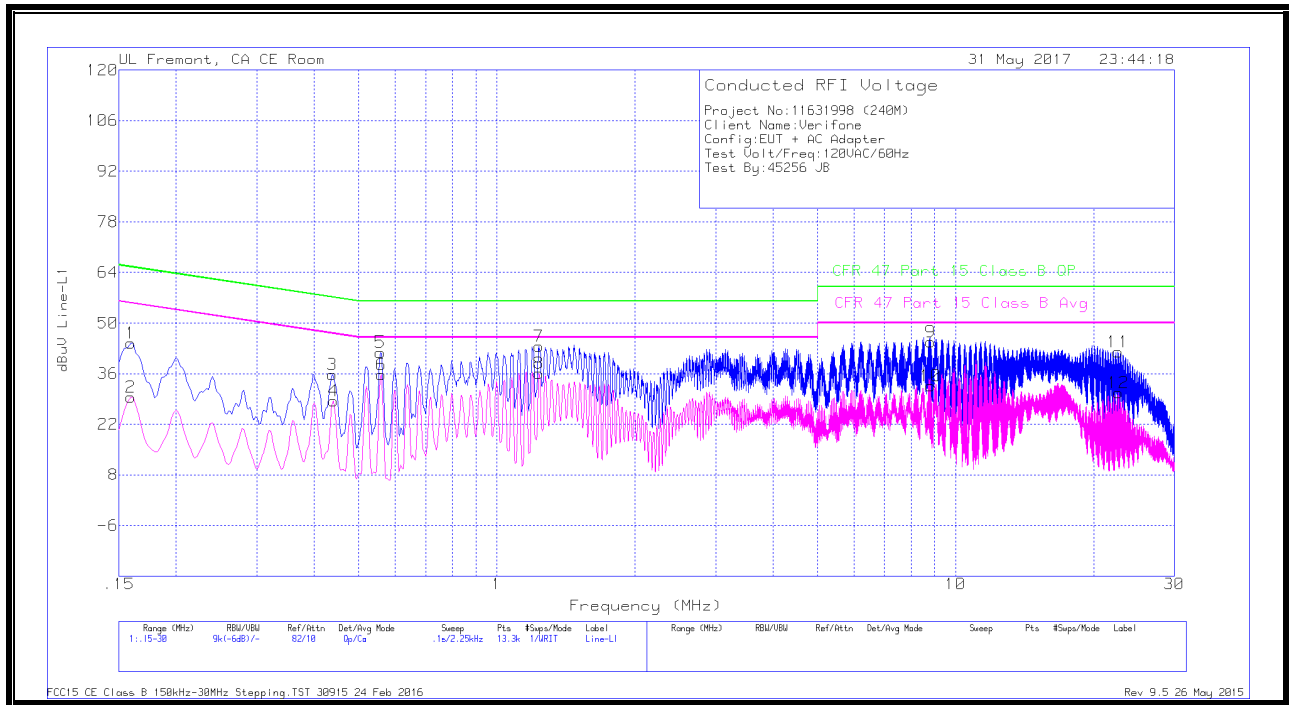

WORST EMISSIONS

Trace Markers

Range 1: Line-L1 .15 - 30MHz

Marker	Frequency (MHz)	Meter Reading (dBuV)	Det	LISN L1	LC Cables C1&C3	Limiter (dB)	Corrected Reading dBuV	CFR 47 Part 15 Class B QP	QP Margin (dB)	CFR 47 Part 15 Class B Avg	Av(CISPR) Margin (dB)
1	.159	34.26	Qp	0	.1	10.1	44.46	65.52	-21.06	-	-
2	.159	19.25	Ca	0	.1	10.1	29.45	-	-	55.52	-26.07
3	.438	25.62	Qp	0	.1	10.1	35.82	57.1	-21.28	-	-
4	.44025	18.18	Ca	0	.1	10.1	28.38	-	-	47.06	-18.68
5	.55725	31.71	Qp	0	.1	10.1	41.91	56	-14.09	-	-
6	.5595	25.5	Ca	0	.1	10.1	35.7	-	-	46	-10.3
7	1.2345	33.34	Qp	0	.1	10.1	43.54	56	-12.46	-	-
8	1.23675	25.94	Ca	0	.1	10.1	36.14	-	-	46	-9.86
9	8.83725	34.32	Qp	0	.2	10.2	44.72	60	-15.28	-	-
10	8.835	22.17	Ca	0	.2	10.2	32.57	-	-	50	-17.43
11	22.614	31.2	Qp	.1	.3	10.4	42	60	-18	-	-
12	22.6545	19.96	Ca	.1	.3	10.4	30.76	-	-	50	-19.24

Qp - Quasi-Peak detector
 Ca - CISPR average detection

LINE 2 RESULTS

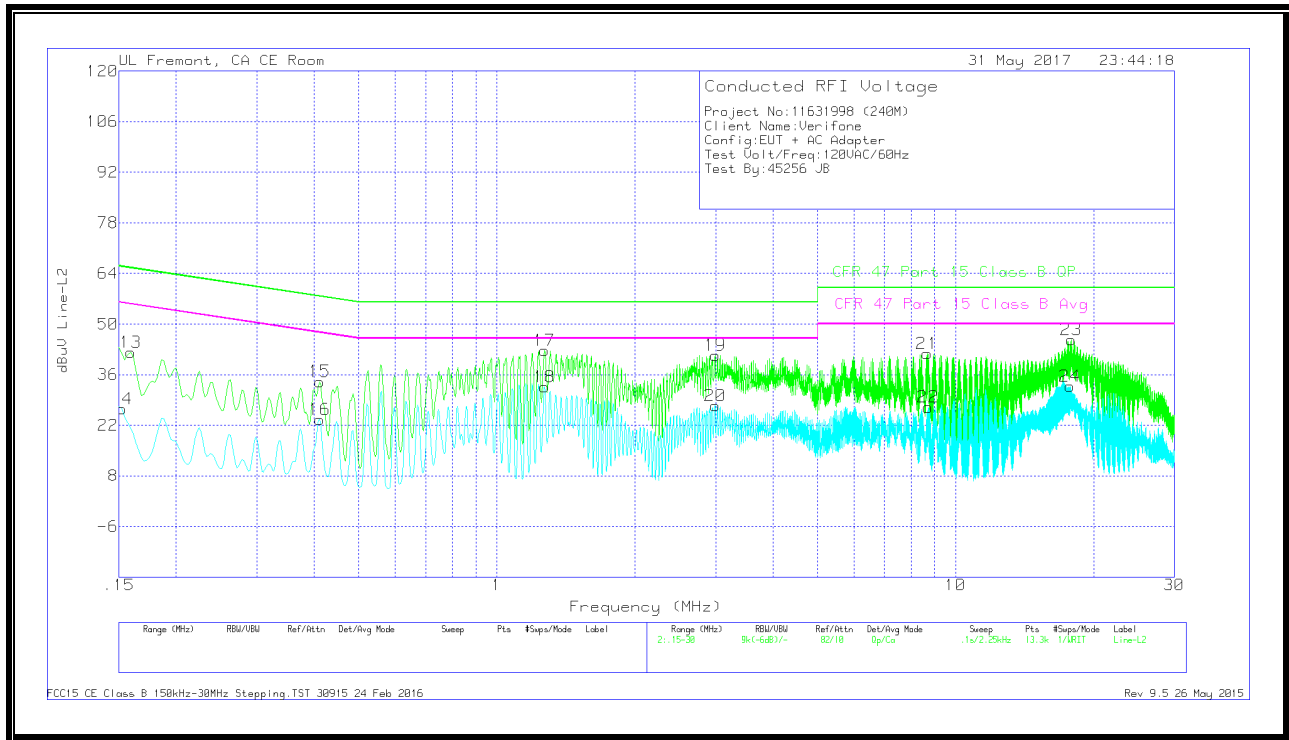

WORST EMISSIONS

Trace Markers

Range 2: Line-L2 .15 - 30MHz

Marker	Frequency (MHz)	Meter Reading (dBuV)	Det	LISN L2	LC Cables C2&C3	Limiter (dB)	Corrected Reading dBuV	CFR 47 Part 15 Class B QP	QP Margin (dB)	CFR 47 Part 15 Class B Avg	Av(CISPR) Margin (dB)
13	.159	31.94	Qp	0	.1	10.1	42.14	65.52	-23.38	-	-
14	.15225	16.41	Ca	0	0	10.1	26.51	-	-	55.88	-29.37
15	.411	23.89	Qp	0	.1	10.1	34.09	57.63	-23.54	-	-
16	.411	13.33	Ca	0	.1	10.1	23.53	-	-	47.63	-24.1
17	1.2705	32.46	Qp	0	.1	10.1	42.66	56	-13.34	-	-
18	1.2705	22.34	Ca	0	.1	10.1	32.54	-	-	46	-13.46
19	2.99175	31.19	Qp	0	.1	10.1	41.39	56	-14.61	-	-
20	2.99175	17.28	Ca	0	.1	10.1	27.48	-	-	46	-18.52
21	8.67525	31.38	Qp	0	.2	10.2	41.78	60	-18.22	-	-
22	8.7135	16.57	Ca	0	.2	10.2	26.97	-	-	50	-23.03
23	17.86425	35.09	Qp	0	.3	10.3	45.69	60	-14.31	-	-
24	17.7945	22.18	Ca	0	.3	10.3	32.78	-	-	50	-17.22

Qp - Quasi-Peak detector

Ca - CISPR average detection