



CERTIFICATION TEST REPORT

Report Number. : 11756319-E1V5

Applicant : Verifone, Inc.
1400 West Stanford Ranch Road
Rocklin, CA 95765

Model : V205c CTLS

FCC ID : B32V205CCTLS
ISED : 787C-V205CCTLS

EUT Description : Mobile Point of Sale Terminal

Test Standard(s) : FCC 47 CFR PART 15 SUBPART C
INDUSTRY CANADA RSS - 210 ISSUE 9

Date Of Issue:

January 10, 2018

Prepared by:

UL Verification Services Inc.
47173 Benicia Street
Fremont, CA 94538, U.S.A.
TEL: (510) 771-1000
FAX: (510) 661-0888



NVLAP LAB CODE 200065-0

Revision History

<u>Ver.</u>	<u>Issue Date</u>	<u>Revisions</u>	<u>Revised By</u>
V1	09/15/17	Initial Issue	D. Corona
V2	09/21/17	Updated Model Number from V205C CTLS to V205c CTLS, Cover and Attestation Pages	A. Aumentado
V3	12/22/17	Updated Section 5.5, 9 and corrected IC number	D. Corona
V4	01/08/18	Updated Section 5.5 (added note)	Dan Corona
V5	01/10/18	Updated Section 6 and 9 (added EUT with Antenna Terminated data)	G. Escano

TABLE OF CONTENTS

1. ATTESTATION OF TEST RESULTS	4
2. TEST METHODOLOGY	5
3. FACILITIES AND ACCREDITATION	5
4. CALIBRATION AND UNCERTAINTY	5
4.1. MEASURING INSTRUMENT CALIBRATION	5
4.2. SAMPLE CALCULATION	5
4.3. MEASUREMENT UNCERTAINTY	6
5. EQUIPMENT UNDER TEST	7
5.1. DESCRIPTION OF EUT	7
5.2. MAXIMUM FIELD STRENGTH	7
5.3. DESCRIPTION OF AVAILABLE ANTENNAS	7
5.4. SOFTWARE AND FIRMWARE	7
5.5. WORST-CASE CONFIGURATION AND MODE	8
5.6. MODIFICATIONS	8
5.7. DESCRIPTION OF TEST SETUP	9
6. TEST AND MEASUREMENT EQUIPMENT	12
7. OCCUPIED BANDWIDTH	13
8. RADIATED EMISSION TEST RESULTS	14
8.1. LIMITS AND PROCEDURE	14
8.1.1. FUNDAMENTAL EMISSION MASK (11.56 – 15.56MHz)	16
8.1.2. SPURIOUS EMISSIONS (0.09 – 30MHz)	18
8.1.3. TX SPURIOUS EMISSIONS (30 – 1000MHz)	19
9. AC MAINS LINE CONDUCTED EMISSIONS	21
10. FREQUENCY STABILITY	26
11. SETUP PHOTOS	27

1. ATTESTATION OF TEST RESULTS

COMPANY NAME: VERIFONE, INC.
EUT DESCRIPTION: MOBILE POINT OF SALE TERMINAL
MODEL: V205c CTLS
SERIAL NUMBER: 401-157-928
DATE TESTED: May 12 – June 1, 2017 and January 10, 2018

APPLICABLE STANDARDS	
STANDARD	TEST RESULTS
FCC PART 15 SUBPART C	Pass
INDUSTRY CANADA RSS-210 Issue 9	Pass
INDUSTRY CANADA RSS-GEN Issue 4	Pass

UL Verification Services Inc. tested the above equipment in accordance with the requirements set forth in the above standards. All indications of Pass/Fail in this report are opinions expressed by UL Verification Services Inc. based on interpretations and/or observations of test results. Measurement Uncertainties were not taken into account and are published for informational purposes only. The test results show that the equipment tested is capable of demonstrating compliance with the requirements as documented in this report.

Note: The results documented in this report apply only to the tested sample, under the conditions and modes of operation as described herein. This document may not be altered or revised in any way unless done so by UL Verification Services Inc. and all revisions are duly noted in the revisions section. Any alteration of this document not carried out by UL Verification Services Inc. will constitute fraud and shall nullify the document. This report must not be used by the client to claim product certification, approval, or endorsement by NVLAP, NIST, any agency of the Federal Government, or any agency of any government.

Approved & Released For
UL Verification Services Inc. By:



DAN CORONIA
CONSUMER TECHNOLOGY DIVISION
OPERATIONS LEADER
UL VERIFICATION SERVICES INC

Prepared By:



GLENN ESCANO
CONSUMER TECHNOLOGY DIVISION
WISE LAB ENGINEER
UL VERIFICATION SERVICES INC

2. TEST METHODOLOGY

The tests documented in this report were performed in accordance with ANSI C63.10-2013, FCC CFR 47 Part 2, and FCC CFR 47 Part 15, RSS-GEN Issue 4, and RSS-210 Issue 9.

3. FACILITIES AND ACCREDITATION

The test sites and measurement facilities used to collect data are located at 47173 and 47266 Benicia Street, Fremont, California, USA. Line conducted emissions are measured only at the 47173 address. The following table identifies which facilities were utilized for radiated emission measurements documented in this report. Specific facilities are also identified in the test results sections.

47173 Benicia Street		47266 Benicia Street	
<input checked="" type="checkbox"/>	Chamber A (IC:2324B-1)	<input type="checkbox"/>	Chamber D (IC:22541-1)
<input type="checkbox"/>	Chamber B (IC:2324B-2)	<input type="checkbox"/>	Chamber E (IC: 22541-2)
<input type="checkbox"/>	Chamber C (IC:2324B-3)	<input type="checkbox"/>	Chamber F (IC: 22541-3)
		<input type="checkbox"/>	Chamber G (IC: 22541-4)
		<input type="checkbox"/>	Chamber H (IC: 22541-5)

The above test sites and facilities are covered under FCC Test Firm Registration # 208313.

UL Verification Services Inc. is accredited by NVLAP, Laboratory Code 200065-0.

Chambers A through C are covered under Industry Canada company address code 2324B with site numbers 2324B -1 through 2324B-3, respectively and Chambers D through H are covered under Industry Canada company address code 22541 with site numbers 22541 -1 through 22541-5, respectively.

4. CALIBRATION AND UNCERTAINTY

4.1. MEASURING INSTRUMENT CALIBRATION

The measuring equipment utilized to perform the tests documented in this report has been calibrated in accordance with the manufacturer's recommendations, and is traceable to recognized national standards.

4.2. SAMPLE CALCULATION

Where relevant, the following sample calculation is provided:

$$\begin{aligned} \text{Field Strength (dBuV/m)} &= \text{Measured Voltage (dBuV)} + \text{Antenna Factor (dB/m)} + \\ &\text{Cable Loss (dB)} - \text{Preamp Gain (dB)} \\ 36.5 \text{ dBuV} + 18.7 \text{ dB/m} + 0.6 \text{ dB} - 26.9 \text{ dB} &= 28.9 \text{ dBuV/m} \end{aligned}$$

4.3. MEASUREMENT UNCERTAINTY

Where relevant, the following measurement uncertainty levels have been estimated for tests performed on the apparatus:

Parameter	Uncertainty
Worst Case Conducted Disturbance, 9KHz to 0.15 MHz	3.84 dB
Worst Case Conducted Disturbance, 0.15 to 30 MHz	3.65 dB
Worst Case Radiated Disturbance, 9KHz to 30 MHz	3.15 dB
Worst Case Radiated Disturbance, 30 to 1000 MHz	5.36 dB
Worst Case Radiated Disturbance, 1000 to 18000 MHz	4.32 dB
Worst Case Radiated Disturbance, 18000 to 26000 MHz	4.45 dB
Worst Case Radiated Disturbance, 26000 to 40000 MHz	5.24 dB

Uncertainty figures are valid to a confidence level of 95%.

5. EQUIPMENT UNDER TEST

5.1. DESCRIPTION OF EUT

The EUT is a Mobile Point of Sale Terminal.

5.2. MAXIMUM FIELD STRENGTH

The testing was performed at 3 meter. The transmitter maximum E-field at 30 meter distance is 42.92 dBuV/m which is converted from the 3 meter data.

5.3. DESCRIPTION OF AVAILABLE ANTENNAS

The radio utilized a two turn, inductive loop antenna.

5.4. SOFTWARE AND FIRMWARE

The firmware installed in the EUT during testing was Low level firmware and higher level operating system software. VOS -30640xxx were installed in the EUT during testing

5.5. WORST-CASE CONFIGURATION AND MODE

Radiated emission was performed with the EUT set to transmit at the channel with highest output power as worst-case scenario.

The fundamental of the EUT was investigated in three orthogonal orientations X, Y, Z, it was determined that X-Axis orientation was worst-case orientation; therefore, all final radiated testing was performed with the EUT in X-Axis orientation.

NOTE: The EUT transmissions data rate is 106kbps. The EUT will only operate in reader mode.

5.6. MODIFICATIONS

No modifications were made during testing.

5.7. DESCRIPTION OF TEST SETUP

SUPPORT EQUIPMENT

Support Equipment List				
Description	Manufacturer	Model	Serial Number	FCC ID
Laptop	Lenovo	20B7S0A200	PC015REW	NA
AC Adapter	Verifone	PSA18A-082A	5RRR164200488	NA

I/O CABLES (RADIATED EMISSIONS)

I/O Cable List						
Cable No	Port	# of identical ports	Connector Type	Cable Type	Cable Length (m)	Remarks
1	DC	1	AC	Un-shielded	2	N/A

I/O CABLES (RADIATED AND CONDUCTED EMISSIONS)

I/O Cable List						
Cable No	Port	# of identical ports	Connector Type	Cable Type	Cable Length (m)	Remarks
1	DC	1	AC	Un-shielded	2	N/A

CONDUCTED TEST SETUP DIAGRAM

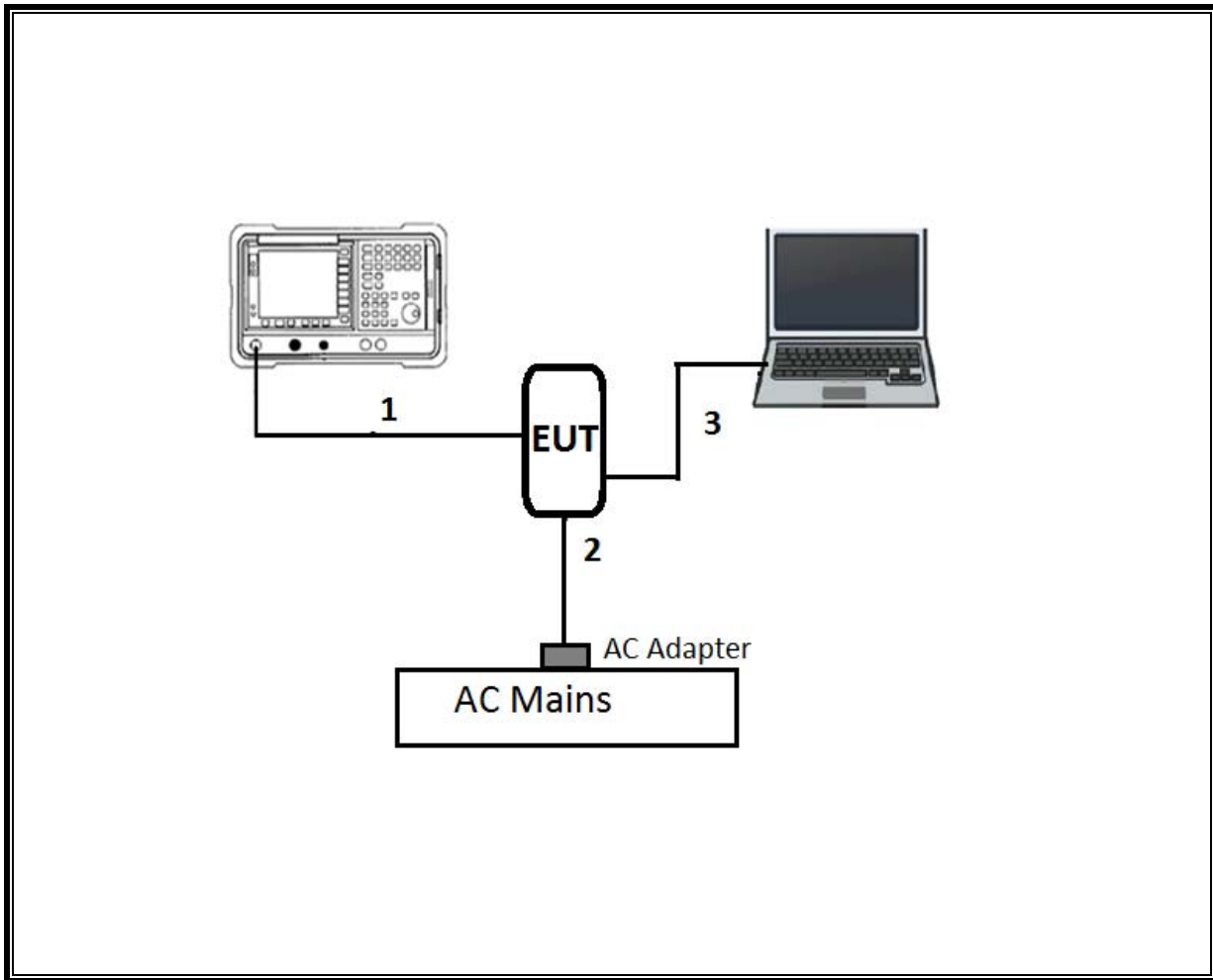

RADIATED AND AC LINE CONDUCTED EMISSIONS SETUP DIAGRAM

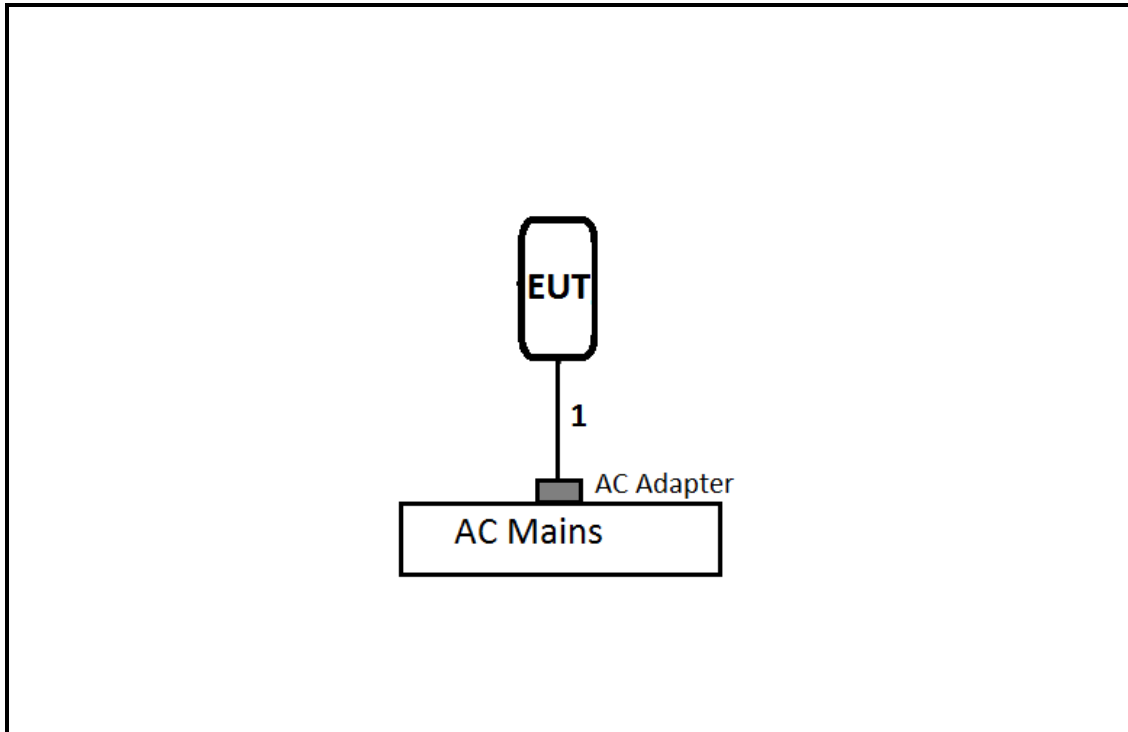

6. TEST AND MEASUREMENT EQUIPMENT

The following test and measurement equipment was utilized for the tests documented in this report:

TEST EQUIPMENT LIST				
Description	Manufacturer	Model	Asset	Cal Due
Antenna, Broadband Hybrid, 30MHz to 2000MHz w/4dB Pad	Sunol Sciences Corp.	JB3	T477	06/22/2017
Antenna, Active Loop 9kHz-30MHz	ETS-Lindgren	6502	T1683	02/17/2018
Amplifier, 10kHz-1GHz	Agilent (Keysight) Technologies	8447D	T15	08/26/2017
Spectrum Analyzer, PXA, 3Hz to 44GHz	Agilent (Keysight) Technologies	N9030A	T907	01/23/2018
Spectrum Analyzer, PXA, 3Hz to 44GHz	Agilent (Keysight) Technologies	N9030A	T1450	01/10/2018
Temperature Chamber	Thermotron Industires	SE-600-10-10	T80	08/21/2017
EMI Test Receiver	Rohde & Schwarz	ESR	T1436	01/18/2018
EMI Test Receiver	Rohde & Schwarz	ESCI 7	T212	09/15/2018
LISN	Fischer Custom Communications	FCC-LISN-50/250-25-2-01	T1310	06/08/2018
Transient Limiter	COM-POWER	LIT-930	T1457	02/24/18

NOTE: *testing is completed before equipment calibration expiration date.

Test Software List			
Description	Manufacturer	Model	Version
Conducted Emissions Software	UL	UL EMC	Ver 9.5, May 26, 2015
Radiated Emissions Software	UL	UL EMC	Ver 9.5, Dec 01, 2016

7. OCCUPIED BANDWIDTH

LIMITS

For reporting purposes only. Tested per ANSI C63.10 (6.9.3)

RESULTS

ID:	43578	Date:	6/1/17
------------	-------	--------------	--------

Frequency (MHz)	99% Bandwidth (kHz)	20dB Bandwidth (kHz)
13.56	21.208	24.890

99% Bandwidth

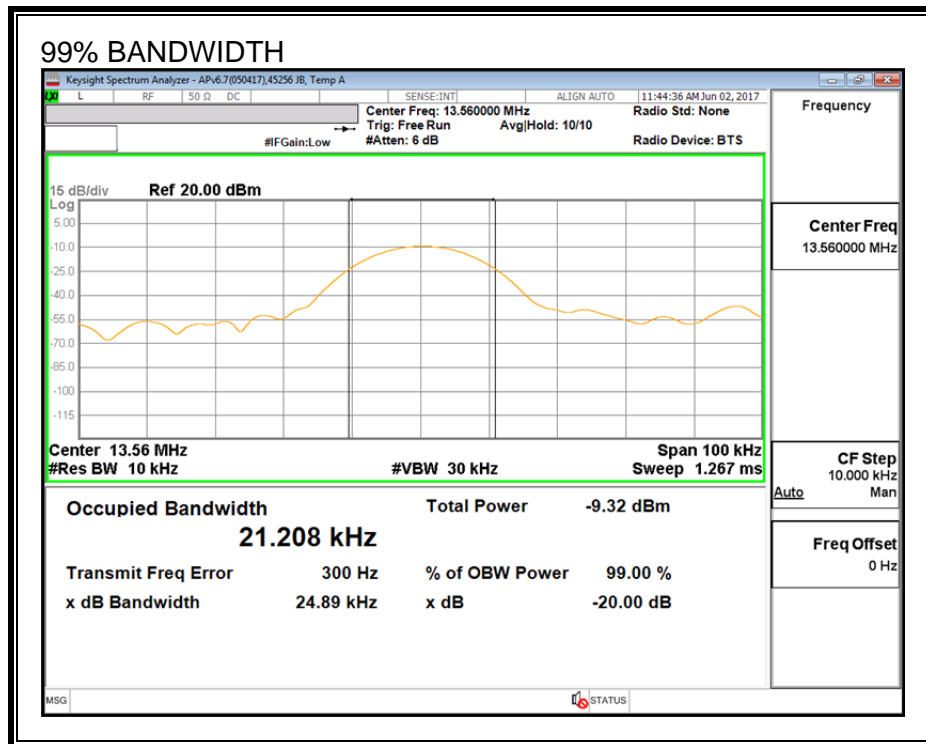

8. RADIATED EMISSION TEST RESULTS

8.1. LIMITS AND PROCEDURE

LIMIT

§15.225, 15.209

IC RSS-210, Annex B.6 (Transmitter)

IC RSS-GEN, Section 7.1.2 (Receiver)

(a) The field strength of any emissions within the band 13.553–13.567 MHz shall not exceed 15,848 microvolts/ meter at 30 meters.

(b) Within the bands 13.410–13.553 MHz and 13.567–13.710 MHz, the field strength of any emissions shall not exceed 334 microvolts/meter at 30 meters.

(c) Within the bands 13.110–13.410 MHz and 13.710–14.010 MHz the field strength of any emissions shall not exceed 106 microvolts/meter at 30 meters.

(d) The field strength of any emissions appearing outside of the 13.110– 14.010 MHz and shall not exceed the general radiated emission limits in § 15.209 as follows:

§15.209 (a) Except as provided elsewhere in this subpart, the emissions from an intentional radiator shall not exceed the field strength levels specified in the following table:

Limits for radiated disturbance of an intentional radiator		
Frequency range (MHz)	Limits (µV/m)	Measurement Distance (m)
0.009 – 0.490	2400 / F (kHz)	300
0.490 – 1.705	24000 / F (kHz)	30
1.705 – 30.0	30	30
30 – 88	100**	3
88 - 216	150**	3
216 – 960	200**	3
Above 960	500	3

** Except as provided in paragraph (g), fundamental emissions from intentional radiators operating under this section shall not be located in the frequency bands 54-72 MHz, 76-88 MHz, 174-216 MHz or 470-806 MHz. However, operation within these frequency bands is permitted under other sections of this part, e.g. §§ 15.231 and 15.241.

§15.209 (b) In the emission table above, the tighter limit applies at the band edges.

Formula for converting the field strength from uV/m to dBuV/m is:

Limit (dBuV/m) = 20 log limit (uV/m)

In addition:

§15.209 (d) The emission limits shown at the above table are based on measurements employing a CISPR quasi-peak detector except for the frequency bands 9-90 kHz, 110-490 kHz and above 1000 MHz. Radiated emissions limits in these three bands are based on measurements employing an average detector.

§15.209 (d) The provisions in §§ 15.225, measuring emissions at distances other than the distances specified in the above table, determining the frequency range over which radiated emissions are to be measured, and limiting peak emissions apply to all devices operated under this part.

TEST PROCEDURE

ANSI C63.10-2013

The EUT is an intentional radiator that incorporates a digital device. The highest fundamental frequency generated or used in the device is 13.56 MHz. The frequency range was investigated from 0.15 MHz to the 10th harmonic of the highest fundamental frequency, or 1000 MHz, whichever is greater (1000MHz)

KDB 414788 OATS and Chamber Correlation Justification

Base on FCC 15.31 (f) (2): measurements may be performed at a distance closer than that specified in the regulations; however, an attempt should be made to avoid making measurements in the near field.

OATs and chamber correlation testing had been performed and chamber measured test result is the worst case test result.

RESULTS

No non-compliance noted:

8.1.1. FUNDAMENTAL EMISSION MASK (11.56 – 15.56MHz)

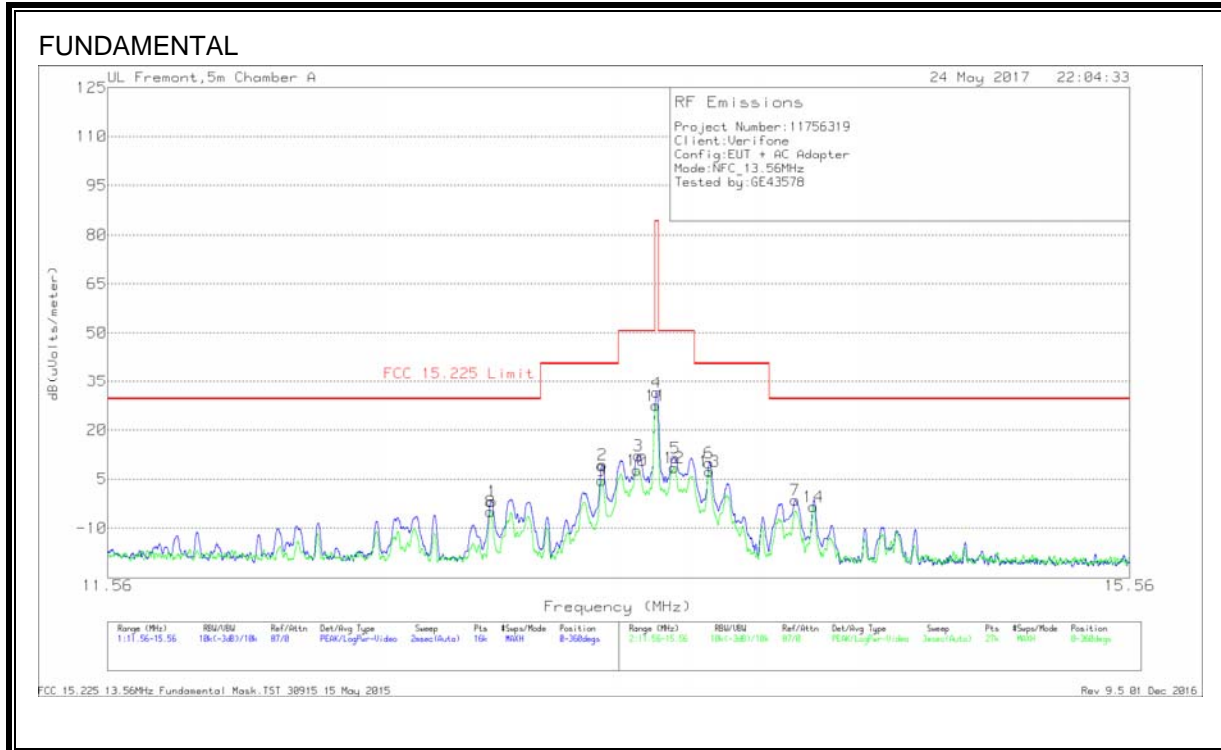

Trace Markers

Marker	Frequency (MHz)	Meter Reading (dBuV)	Det	Loop Antenna (dB/m)	Cbl (dB)	Dist Corr 30m	Corrected Reading dB(uVolts/meter)	FCC 15.225 Limit	PK Margin (dB)	Azimuth (Degs)
8	12.92241	23.8	Pk	10.7	.6	-40	-4.9	29.54	-34.44	0-360
1	12.92725	26.88	Pk	10.7	.6	-40	-1.82	29.54	-31.36	0-360
9	13.34725	33.31	Pk	10.7	.6	-40	4.61	40.51	-35.9	0-360
2	13.34775	38.15	Pk	10.7	.6	-40	9.45	40.51	-31.06	0-360
10	13.48296	36.35	Pk	10.7	.6	-40	7.65	50.5	-42.85	0-360
3	13.48963	40.92	Pk	10.7	.6	-40	12.22	50.5	-38.28	0-360
11	*13.55807	56.24	Pk	10.6	.6	-40	27.44	84	-56.56	0-360
4	*13.55988	60.4	Pk	10.6	.6	-40	31.6	84	-52.4	0-360
12	13.62926	37.23	Pk	10.6	.6	-40	8.43	50.5	-42.07	0-360
5	13.63375	40.27	Pk	10.6	.6	-40	11.47	50.5	-39.03	0-360
6	13.76925	38.82	Pk	10.6	.5	-40	9.92	40.51	-30.59	0-360
13	13.76957	36.26	Pk	10.6	.5	-40	7.36	40.51	-33.15	0-360
7	14.11913	27.48	Pk	10.6	.5	-40	-1.42	29.54	-30.96	0-360
14	14.19314	25.43	Pk	10.6	.5	-40	-3.47	29.54	-33.01	0-360

Pk - Peak detector
 Fundamental Frequency

Frequency (MHz)	Meter Reading (dBuV)	Det	Loop Antenna (dB/m)	Cbl (dB)	Dist Corr 30m	Corrected Reading dB(uVolts/meter)	FCC 15.225 Limit	PK Margin (dB)	Azimuth (Degs)	Antenna Position
13.55807	56.24	Pk	10.4	.6	-40	27.44	84	-56.56	32	Face on
13.55988	60.4	Pk	10.4	.6	-40	31.6	84	-52.4	98	Face off

Pk - Peak detector

8.1.2. SPURIOUS EMISSIONS (0.09 – 30MHz)

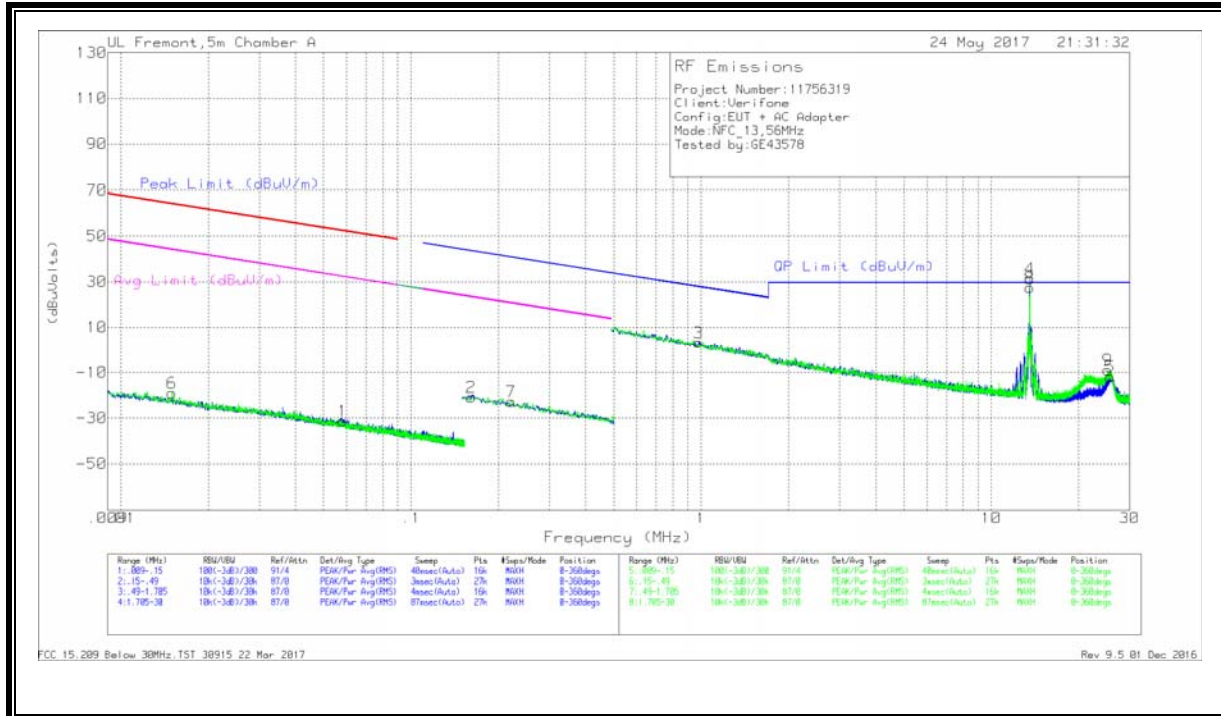

Trace Markers

Marker	Frequency (MHz)	Meter Reading (dBuV)	Det	Loop Antenna (dB/m)	Cbl (dB)	Dist Corr 300m	Corrected Reading (dBuVolts)	Peak Limit (dBuV/m)	Margin (dB)	Avg Limit (dBuV/m)	Margin (dB)	Peak Limit (dBuV/m)	Margin (dB)	Avg Limit (dBuV/m)	Margin (dB)	Azimuth (Degs)
6	.01502	44.5	Pk	16.4	.1	-80	-19	64.05	-83.05	44.05	-63.05	-	-	-	-	0-360
1	.05811	36.59	Pk	12	.1	-80	-31.31	52.3	-83.61	32.3	-63.61	-	-	-	-	0-360
2	.16136	47.42	Pk	11.6	.1	-80	-20.88	-	-	-	-	43.47	-64.35	23.47	-44.35	0-360
7	.22124	45.63	Pk	11.6	.1	-80	-22.67	-	-	-	-	40.72	-63.39	20.72	-43.39	0-360

Pk - Peak detector

Marker	Frequency (MHz)	Meter Reading (dBuV)	Det	Loop Antenna (dB/m)	Cbl (dB)	Dist Corr 30m	Corrected Reading (dBuVolts)	QP Limit (dBuV/m)	Margin (dB)	Peak Limit (dBuV/m)	Margin (dB)	Avg Limit (dBuV/m)	Margin (dB)	Azimuth (Degs)
3	.97822	31.52	Pk	11.6	.2	-40	3.32	27.81	-24.49	-	-	-	-	0-360
4	*13.55945	60.33	Pk	10.4	.6	-40	31.33	-	-	-	-	-	-	0-360
8	*13.55945	56.44	Pk	10.4	.6	-40	27.44	-	-	-	-	-	-	0-360
9	25.2347	21.44	Pk	9	.7	-40	-8.86	29.5	-38.36	-	-	-	-	0-360
5	25.72516	18.58	Pk	8.9	.7	-40	-11.82	29.5	-41.32	-	-	-	-	0-360

*Note: indicates fundamental frequency

Pk - Peak detector

8.1.3. TX SPURIOUS EMISSIONS (30 – 1000MHz)

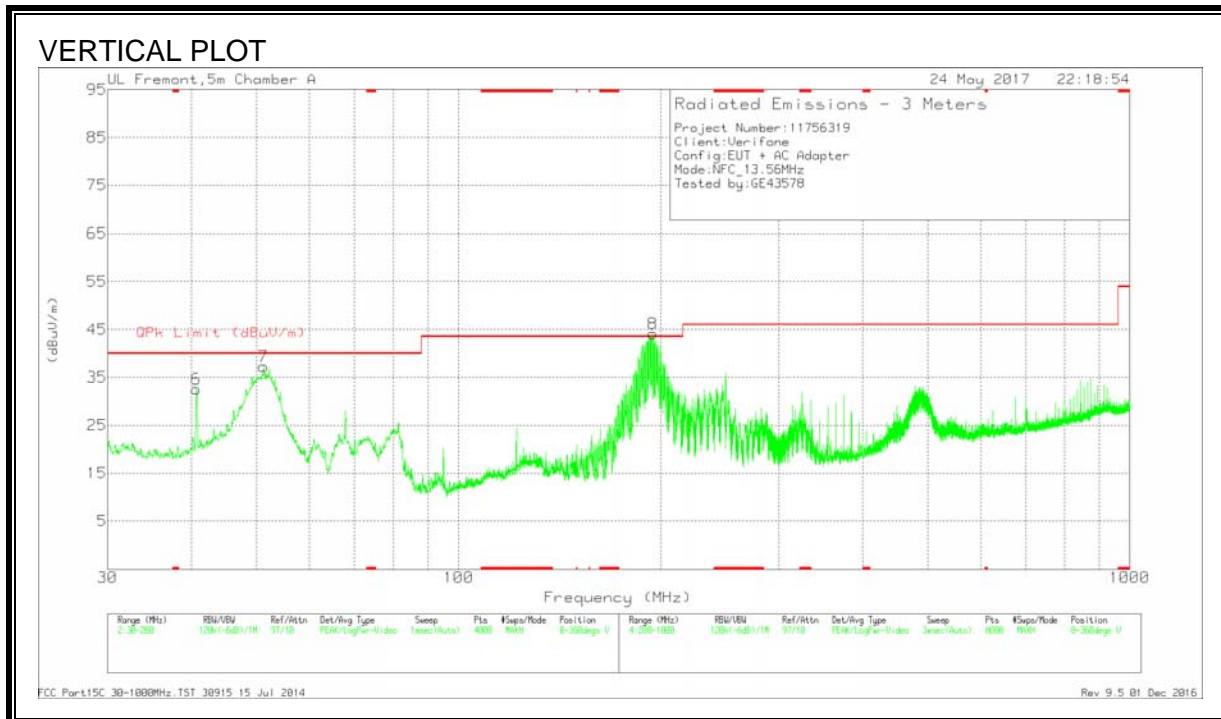
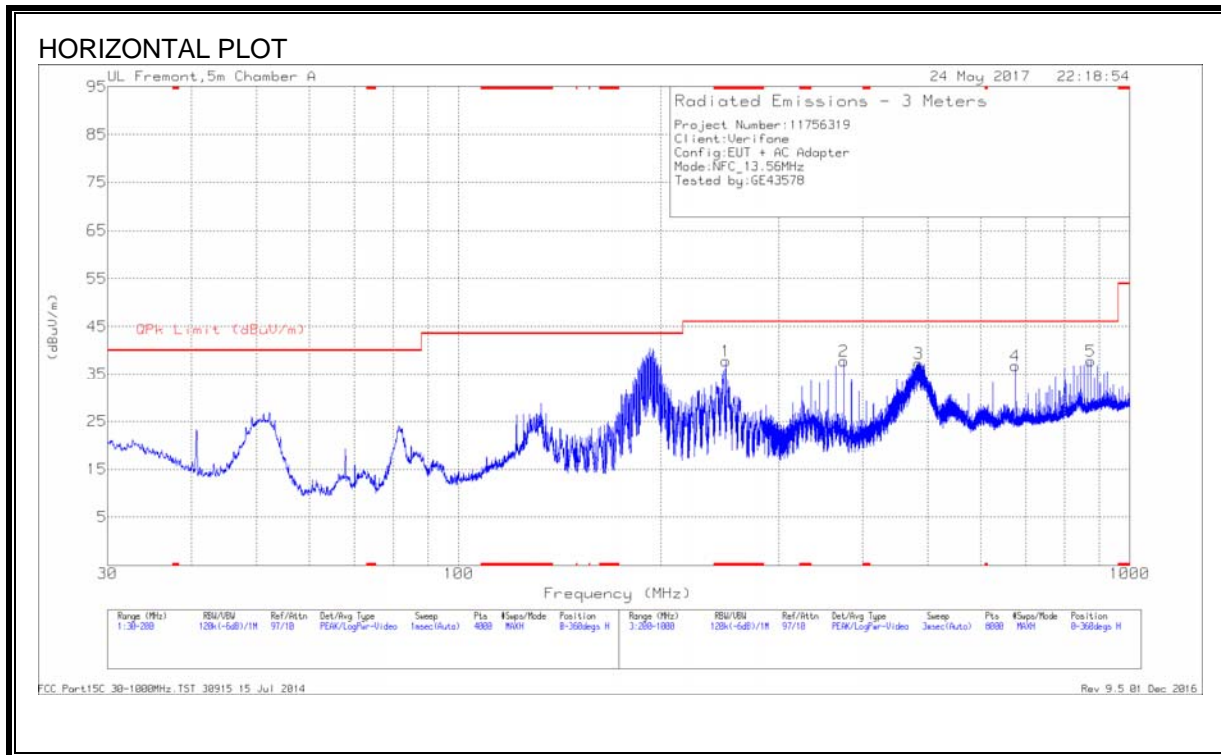

Trace Markers

Marker	Frequency (MHz)	Meter Reading (dBuV)	Det	AF T130 (dB/m)	Amp/Cbl (dB/m)	Corrected Reading (dBuV/m)	QPk Limit (dBuV/m)	Margin (dB)	Azimuth (Degs)	Height (cm)	Polarity
1	* 250.0065	51.83	Pk	15.5	-29.6	37.73	46.02	-8.29	0-360	101	H
6	40.6703	46.08	Pk	17.6	-31.1	32.58	40	-7.42	0-360	100	V
7	51.213	56.93	Pk	11.3	-31	37.23	40	-2.77	0-360	100	V
8	194.9852	58.12	Pk	16	-30	44.12	43.52	.6	0-360	100	V
2	375.0228	47.93	Pk	19	-29.1	37.83	46.02	-8.19	0-360	101	H
3	485.1371	44.32	Pk	21.7	-28.7	37.32	46.02	-8.7	0-360	200	H
4	674.9617	41.22	Pk	23.8	-28.2	36.82	46.02	-9.2	0-360	101	H
5	874.9877	39.42	Pk	25.9	-27.5	37.82	46.02	-8.2	0-360	101	H

Pk - Peak detector

Radiated Emissions

Frequency (MHz)	Meter Reading (dBuV)	Det	AF T130 (dB/m)	Amp/Cbl (dB/m)	Corrected Reading (dBuV/m)	QPk Limit (dBuV/m)	Margin (dB)	Azimuth (Degs)	Height (cm)	Polarity
51.2351	53.99	Qp	11.3	-31	34.29	40	-5.71	246	118	V
194.8858	55.48	Qp	16	-30	41.48	43.52	-2.04	52	105	V

Qp - Quasi-Peak detector

9. AC MAINS LINE CONDUCTED EMISSIONS

LIMITS

§15.207

IC RSS-GEN, Section 8.8

(a) Except as shown in paragraphs (b) and (c) of this section, for an intentional radiator that is designed to be connected to the public utility (AC) power line, the radio frequency voltage that is conducted back onto the AC power line on any frequency or frequencies, within the band 150 kHz to 30 MHz, shall not exceed the limits in the following table, as measured using a 50 μ H/50 ohms line impedance stabilization network (LISN). Compliance with the provisions of this paragraph shall be based on the measurement of the radio frequency voltage between each power line and ground at the power terminal. The lower limit applies at the band edges.

Frequency range (MHz)	Limits (dB μ V)	
	Quasi-peak	Average
0.15 to 0.50	66 to 56	56 to 46
0.50 to 5	56	46
5 to 30	60	50

Notes:
1. The lower limit shall apply at the transition frequencies
2. The limit decreases linearly with the logarithm of the frequency in the range 0.15 MHz to 0.50 MHz.

TEST PROCEDURE

The EUT is placed on a non-conducting table 40 cm from the vertical ground plane and 80 cm above the horizontal ground plane. The EUT is configured in accordance with ANSI C63.10.

The receiver is set to a resolution bandwidth of 9 kHz. Peak detection is used unless otherwise noted as quasi-peak or average.

Line conducted data is recorded for both Line 1 (HOT) and Line 2 (NEUTRAL).

RESULTS

EUT WITH ANTENNA - LINE 1 RESULTS

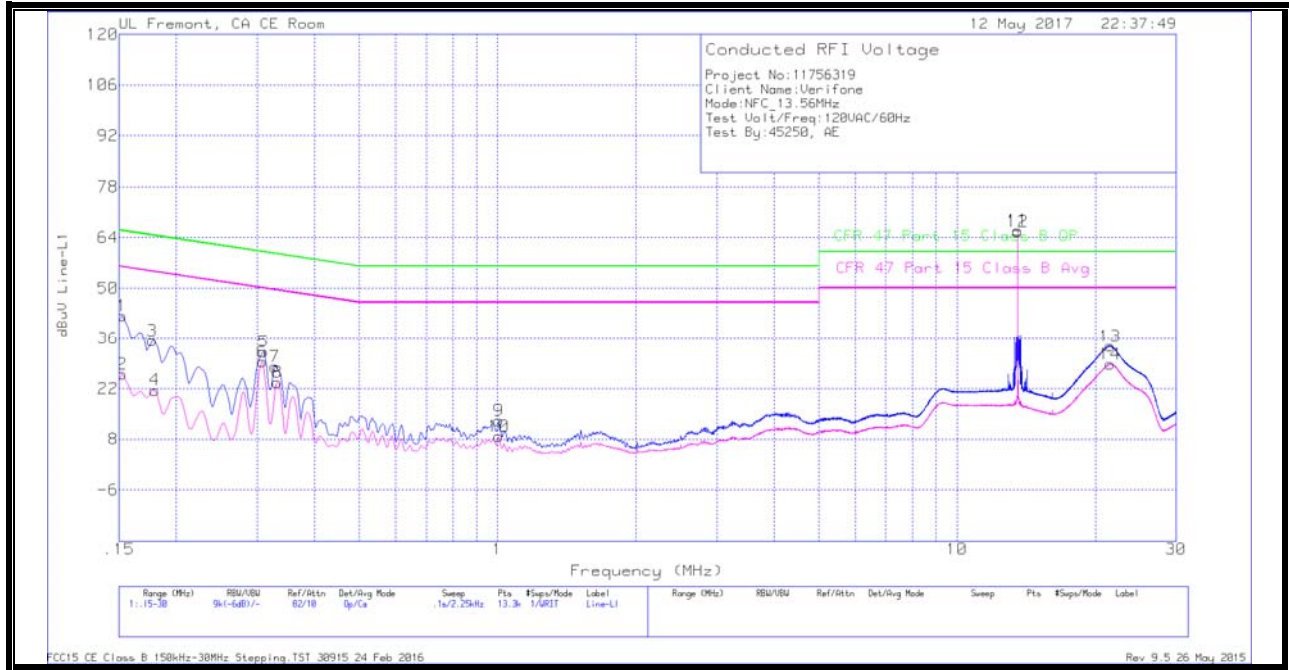

WORST EMISSIONS

Range 1: Line-L1 .15 - 30MHz											
Marker	Frequency (MHz)	Meter Reading (dBuV)	Det	LISN L1	LC Cables C1&C3	Limiter (dB)	Corrected Reading dBuV	CFR 47 Part 15 Class B QP	QP Margin (dB)	CFR 47 Part 15 Class B Avg	Av(CISPR) Margin (dB)
1	.15225	32.07	Qp	.1	.1	10.1	42.37	65.88	-23.51	-	-
2	.15225	15.65	Ca	.1	.1	10.1	25.95	-	-	55.88	-29.93
3	.177	25.21	Qp	0	.1	10.1	35.41	64.63	-29.22	-	-
4	.17925	11.38	Ca	0	.1	10.1	21.58	-	-	54.52	-32.94
5	.30975	22.05	Qp	0	.1	10.1	32.25	59.98	-27.73	-	-
6	.3075	19.24	Ca	0	.1	10.1	29.44	-	-	50.04	-20.6
7	.32775	17.86	Qp	0	.1	10.1	28.06	59.51	-31.45	-	-
8	.33225	13.63	Ca	0	.1	10.1	23.83	-	-	49.39	-25.56
9	1.00725	2.9	Qp	0	.1	10.1	13.1	56	-42.9	-	-
10	1.00725	-1.46	Ca	0	.1	10.1	8.74	-	-	46	-37.26
11	13.56*	55.45	Qp	.1	.2	10.2	65.95	-	-	-	-
12	13.56*	55.2	Ca	.1	.2	10.2	65.7	-	-	-	-
13	21.5205	23.18	Qp	0	.3	10.4	33.88	60	-26.12	-	-
14	21.561	18.14	Ca	0	.3	10.4	28.84	-	-	50	-21.16

* - indicates fundamental frequency

Qp - Quasi-Peak detector

Ca - CISPR average detection

Note: Markers 13 and 14 are the 13.56MHz NFC Fundamental

EUT WITH ANTENNA-LINE 2 RESULTS

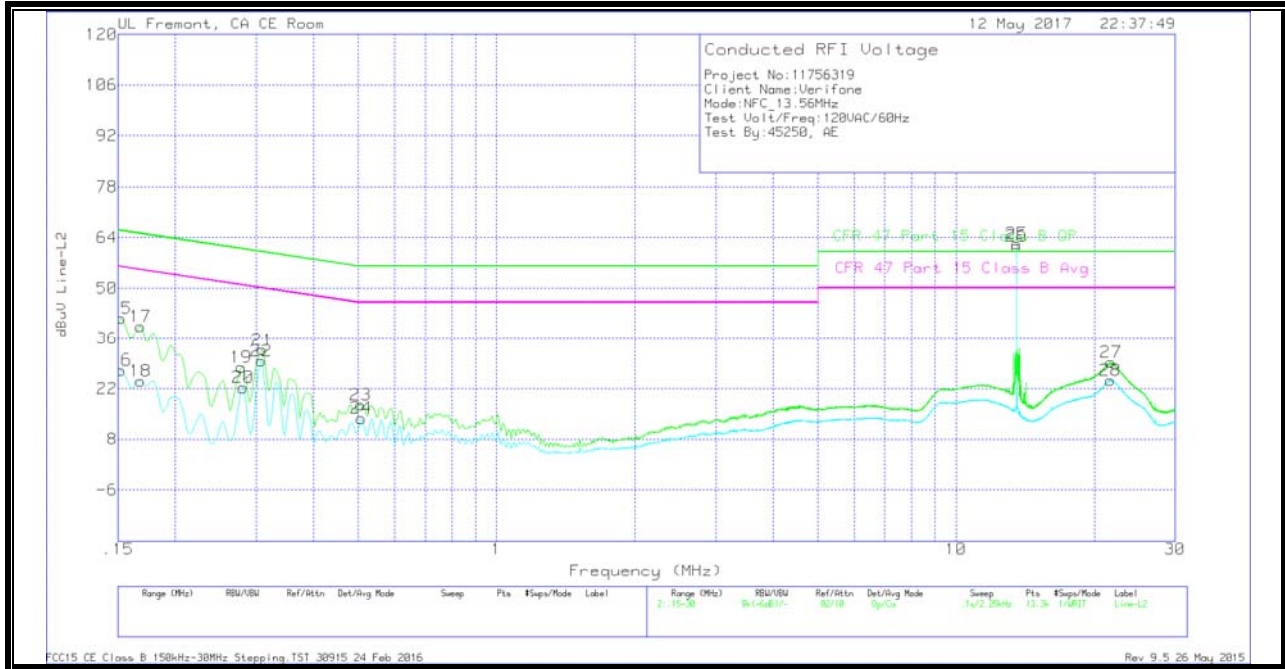

WORST EMISSIONS

Range 2: Line-L2 .15 - 30MHz											
Marker	Frequency (MHz)	Meter Reading (dBuV)	Det	LISN L2	LC Cables C2&C3	Limiter (dB)	Corrected Reading dBuV	CFR 47 Part 15 Class B QP	QP Margin (dB)	CFR 47 Part 15 Class B Avg	Av(CISPR) Margin (dB)
15	.15225	31.55	Qp	0	0	10.1	41.65	65.88	-24.23	-	-
16	.15225	17.04	Ca	0	0	10.1	27.14	-	-	55.88	-28.74
17	.168	29.22	Qp	0	0	10.1	39.32	65.06	-25.74	-	-
18	.168	13.98	Ca	0	0	10.1	24.08	-	-	55.06	-30.98
19	.27825	17.73	Qp	0	.1	10.1	27.93	60.87	-32.94	-	-
20	.2805	12.08	Ca	0	.1	10.1	22.28	-	-	50.8	-28.52
21	.30975	22.52	Qp	0	.1	10.1	32.72	59.98	-27.26	-	-
22	.3075	19.43	Ca	0	.1	10.1	29.63	-	-	50.04	-20.41
23	.5055	7.36	Qp	0	.1	10.1	17.56	56	-38.44	-	-
24	.50775	3.56	Ca	0	.1	10.1	13.76	-	-	46	-32.24
25	13.56*	51.87	Qp	.1	.2	10.2	62.37	-	-	-	-
26	13.56*	51.13	Ca	.1	.2	10.2	61.63	-	-	-	-
27	21.77363	18.55	Qp	0	.3	10.4	29.25	60	-30.75	-	-
28	21.66675	13.6	Ca	0	.3	10.4	24.3	-	-	50	-25.7

* - indicates fundamental frequency

Qp - Quasi-Peak detector

Ca - CISPR average detection

Note: Markers 29 and 30 are the 13.56MHz NFC Fundamental

EUT WITH ANTENNA TERMINATED- LINE 1 RESULTS

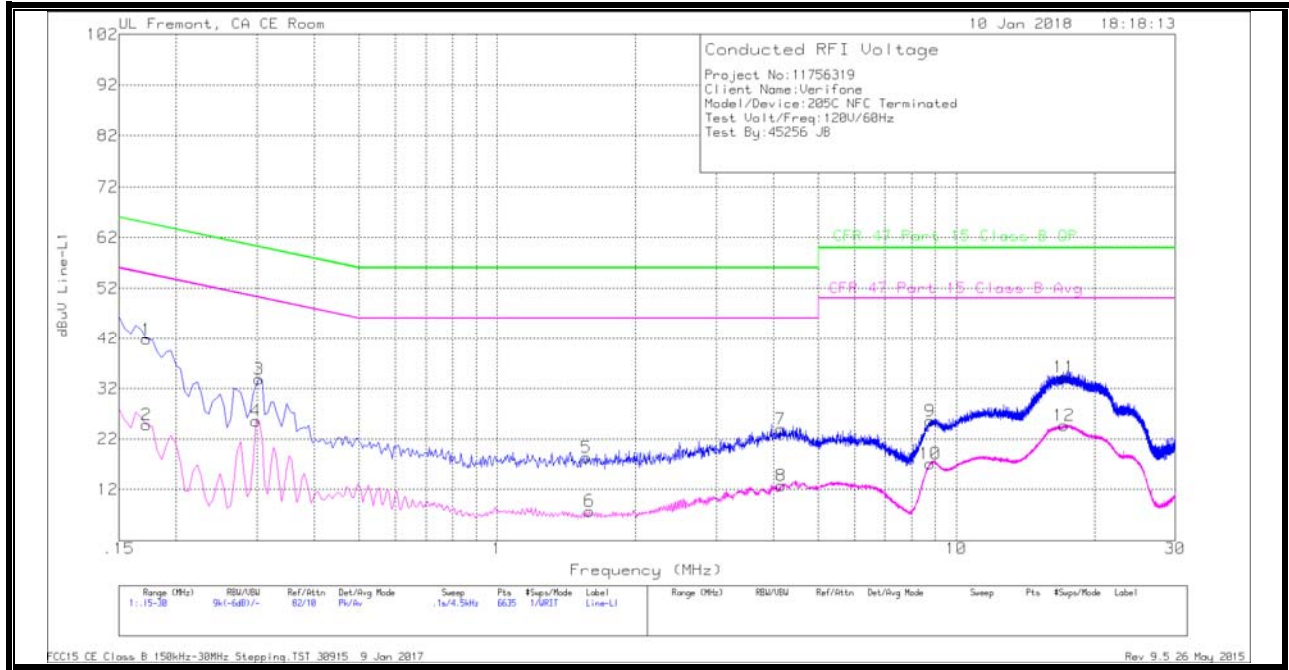

WORST EMISSIONS

Range 1: Line-L1 .15 - 30MHz

Marker	Frequency (MHz)	Meter Reading (dBuV)	Det	LISN L1	LC Cables C1&C3	Limiter (dB)	Corrected Reading dBuV	CFR 47 Part 15 Class B QP	Margin (dB)	CFR 47 Part 15 Class B Avg	Margin (dB)
1	.1725	31.68	Pk	0	0	10.1	41.78	64.84	-23.06	-	-
2	.1725	14.7	Av	0	0	10.1	24.8	-	-	54.84	-30.04
3	.303	23.74	Pk	0	0	10.1	33.84	60.16	-26.32	-	-
4	.2985	15.5	Av	0	0	10.1	25.6	-	-	50.28	-24.68
5	1.563	8.1	Pk	0	.1	10.1	18.3	56	-37.7	-	-
6	1.59	-2.36	Av	0	.1	10.1	7.84	-	-	46	-38.16
7	4.146	13.61	Pk	0	.1	10.2	23.91	56	-32.09	-	-
8	4.1505	2.52	Av	0	.1	10.2	12.82	-	-	46	-33.18
9	8.7675	15.11	Pk	0	.2	10.2	25.51	60	-34.49	-	-
10	8.7675	6.71	Av	0	.2	10.2	17.11	-	-	50	-32.89
11	17.151	23.7	Pk	0	.3	10.3	34.3	60	-25.7	-	-
12	17.1825	14.08	Av	0	.3	10.3	24.68	-	-	50	-25.32

Pk - Peak detector
 Av - Average detection

EUT WITH ANTENNA TERMINATED-LINE 2 RESULTS

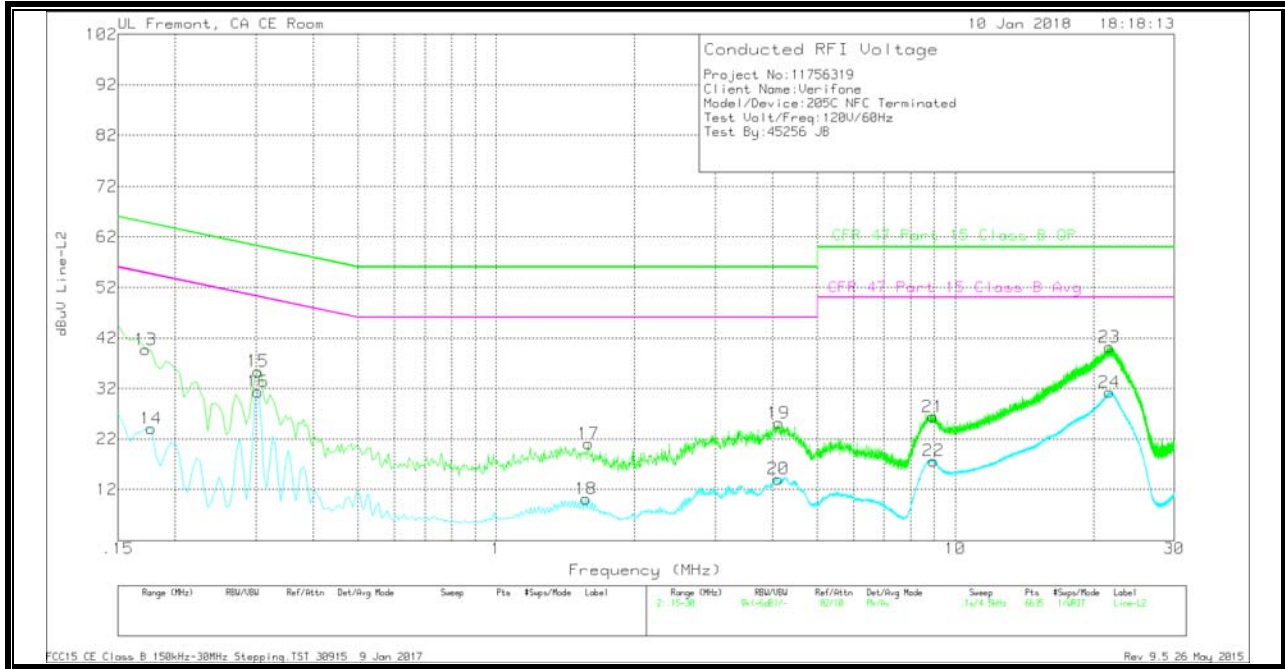

WORST EMISSIONS

Range 2: Line-L2 .15 - 30MHz											
Marker	Frequency (MHz)	Meter Reading (dBuV)	Det	LISN L2	LC Cables C2&C3	Limiter (dB)	Corrected Reading dBuV	CFR 47 Part 15 Class B QP	Margin (dB)	CFR 47 Part 15 Class B Avg	Margin (dB)
13	.1725	29.63	Pk	0	0	10.1	39.73	64.84	-25.11	-	-
14	.177	13.92	Av	0	0	10.1	24.02	-	-	54.63	-30.61
15	.303	25.32	Pk	0	0	10.1	35.42	60.16	-24.74	-	-
16	.303	21.23	Av	0	0	10.1	31.33	-	-	50.16	-18.83
17	1.59	10.83	Pk	0	.1	10.1	21.03	56	-34.97	-	-
18	1.5675	-.07	Av	0	.1	10.1	10.13	-	-	46	-35.87
19	4.1235	14.88	Pk	0	.1	10.2	25.18	56	-30.82	-	-
20	4.119	3.77	Av	0	.1	10.2	14.07	-	-	46	-31.93
21	8.943	16.03	Pk	0	.2	10.2	26.43	60	-33.57	-	-
22	8.9655	7.27	Av	0	.2	10.2	17.67	-	-	50	-32.33
23	21.6645	29.48	Pk	0	.3	10.4	40.18	60	-19.82	-	-
24	21.66	20.56	Av	0	.3	10.4	31.26	-	-	50	-18.74

Pk - Peak detector
 Av - Average detection

10. FREQUENCY STABILITY

LIMIT

§15.225 (e) The frequency tolerance of the carrier signal shall be maintained within $\pm 0.01\%$ of the operating frequency, over a temperature variation of 0 degrees to +50 degrees C at normal supply voltage, and for a variation in the primary supply voltage from 85% to 115% of the rated supply voltage at a temperature of 20 degrees C. For battery operated equipment, the equipment tests shall be performed using a new battery.

TEST PROCEDURE

ANSI C63.10

RESULTS

ID:	43578	Date:	5/15/17
------------	-------	--------------	---------

Reference Frequency: EUT Channel 13.56 MHz @ 20°C Limit: ± 100 ppm = 1.356 kHz										
Power Supply	Envir. Temp	Frequency Deviation Measured with Time Elapse								
(VAC)	(°C)	Startup (MHz)	Delta (ppm)	@ 2 mins (MHz)	Delta (ppm)	@ 5 mins (MHz)	Delta (ppm)	@ 10 mins (MHz)	Delta (ppm)	Limit (ppm)
120.00	50	13.5599746	2.463	13.5599748	2.448	13.5599771	2.279	13.5599796	2.094	± 100
120.00	40	13.5599839	1.777	13.5599785	2.176	13.5599767	2.308	13.5599750	2.434	± 100
120.00	30	13.5599935	1.069	13.5599898	1.342	13.5599879	1.482	13.5599861	1.615	± 100
120.00	20	13.5600080	0.000	13.5599990	0.664	13.5599994	0.634	13.5599954	0.929	± 100
120.00	10	13.5599945	0.996	13.5600036	0.324	13.5600116	-0.265	13.5600245	-1.217	± 100
120.00	0	13.5600432	-2.596	13.5600461	-2.810	13.5600537	-3.370	13.5600624	-4.012	± 100
120.00	-10	13.5600791	-5.243	13.5600803	-5.332	13.5600892	-5.988	13.5600915	-6.158	± 100
120.00	-20	13.5600967	-6.541	13.5600968	-6.549	13.5600971	-6.571	13.5600962	-6.504	± 100
102.00	20	13.5600020	0.442	13.5599951	0.951	13.5599921	1.173	13.5599883	1.453	± 100
138	20	13.5599929	1.114	13.5599877	1.497	13.5599864	1.593	13.5599845	1.733	± 100