

Partial FCC Test Report (Spot Check)

Report No.: RFBCUG-WTW-P22010682C

FCC ID: B32UX700W

Test Model: UX700-ML-1

Received Date: Jan. 12, 2023

Test Date: Jan. 31 ~ Feb. 06, 2023

Issued Date: Feb. 15, 2023

Applicant: Verifone, Inc.

Address: 1400 West Stanford Ranch Road Suite 150 Rocklin CA 95765 USA

Issued By: Bureau Veritas Consumer Products Services (H.K.) Ltd., Taoyuan Branch
Lin Kou Laboratories

Lab Address: No. 47-2, 14th Ling, Chia Pau Vil., Lin Kou Dist., New Taipei City, Taiwan

Test Location (1): No. 19, Hwa Ya 2nd Rd., Wen Hwa Vil., Kwei Shan Dist., Taoyuan City
33383, TAIWAN

**FCC Registration /
Designation Number:** 788550 / TW0003

Test Location (2): No. 70, Wenming Rd., Guishan Dist., Taoyuan City 333, Taiwan (R.O.C.)

**FCC Registration /
Designation Number:** 281270 / TW0032



This report is governed by, and incorporates by reference, the Conditions of Testing as posted at the date of issuance of this report at <http://www.bureauveritas.com/home/about-us/our-business/cps/about-us/terms-conditions/> and is intended for your exclusive use. Any copying or replication of this report to or for any other person or entity, or use of our name or trademark, is permitted only with our prior written permission. This report sets forth our findings solely with respect to the test samples identified herein. The results set forth in this report are not indicative or representative of the quality or characteristics of the lot from which a test sample was taken or any similar or identical product unless specifically and expressly noted. Our report includes all of the tests requested by you and the results thereof based upon the information that you provided to us. Measurement uncertainty is only provided upon request for accredited tests. Statements of conformity are based on simple acceptance criteria without taking measurement uncertainty into account, unless otherwise requested in writing. You have 60 days from date of issuance of this report to notify us of any material error or omission caused by our negligence or if you require measurement uncertainty; provided, however, that such notice shall be in writing and shall specifically address the issue you wish to raise. A failure to raise such issue within the prescribed time shall constitute your unqualified acceptance of the completeness of this report, the tests conducted and the correctness of the report contents.

Table of Contents

Release Control Record	3
1 Certificate of Conformity	4
2 Summary of Test Results	5
2.1 Measurement Uncertainty.....	5
2.2 Modification Record.....	5
3 General Information	6
3.1 General Description of EUT.....	6
3.2 Description of Test Modes.....	7
3.2.1 Test Mode Applicability and Tested Channel Detail.....	8
3.3 Duty Cycle of Test Signal.....	9
3.4 Description of Support Units.....	10
3.4.1 Configuration of System under Test.....	10
3.5 General Description of Applied Standards and References.....	10
4 Test Types and Results	11
4.1 Radiated Emission and Bandedge Measurement.....	11
4.1.1 Limits of Radiated Emission and Bandedge Measurement.....	11
4.1.2 Test Instruments.....	12
4.1.3 Test Procedures.....	13
4.1.4 Deviation from Test Standard.....	13
4.1.5 Test Setup.....	14
4.1.6 EUT Operating Conditions.....	15
4.1.7 Test Results.....	16
4.2 Conducted Emission Measurement.....	21
4.2.1 Limits of Conducted Emission Measurement.....	21
4.2.2 Test Instruments.....	21
4.2.3 Test Procedures.....	22
4.2.4 Deviation from Test Standard.....	22
4.2.5 Test Setup.....	22
4.2.6 EUT Operating Conditions.....	22
4.2.7 Test Results.....	23
4.3 Conducted Output Power Measurement.....	27
4.3.1 Limits of Conducted Output Power Measurement.....	27
4.3.2 Test Setup.....	27
4.3.3 Test Instruments.....	27
4.3.4 Test Procedures.....	27
4.3.5 Deviation from Test Standard.....	27
4.3.6 EUT Operating Conditions.....	27
4.3.7 Test Results.....	28
Annex A - Band Edge Measurement	29
5 Pictures of Test Arrangements	30
Appendix – Information of the Testing Laboratories	31

Release Control Record

Issue No.	Description	Date Issued
RFBCUG-WTW-P22010682C	Original release	Feb. 15, 2023

1 Certificate of Conformity

Product: Point of Sale Terminal
Brand: Verifone
Test Model: UX700-ML-1
Sample Status: Engineering sample
Applicant: Verifone, Inc.
Test Date: Jan. 31 ~ Feb. 06, 2023
Standards: 47 CFR FCC Part 15, Subpart C (Section 15.247)
ANSI C63.10-2013

The above equipment has been tested by **Bureau Veritas Consumer Products Services (H.K.) Ltd., Taoyuan Branch**, and found compliance with the requirement of the above standards. The test record, data evaluation & Equipment Under Test (EUT) configurations represented herein are true and accurate accounts of the measurements of the sample's RF characteristics under the conditions specified in this report.

Prepared by : Celine Chou , **Date:** Feb. 15, 2023
Celine Chou / Senior Specialist

Approved by : Jeremy Lin , **Date:** Feb. 15, 2023
Jeremy Lin / Project Engineer

2 Summary of Test Results

47 CFR FCC Part 15, Subpart C (Section 15.247)			
FCC Clause	Test Item	Result	Remarks
15.207	AC Power Conducted Emission	Pass	Meet the requirement of limit. Minimum passing margin is -15.93dB at 0.39400MHz.
15.205 / 15.209 / 15.247(d)	Radiated Emissions and Band Edge Measurement	Pass	Meet the requirement of limit. Minimum passing margin is -1.3dB at 2390.00MHz.
15.247(d)	Antenna Port Emission	Pass	Refer to note 1
15.247(a)(2)	6dB bandwidth	Pass	Refer to note 1
15.247(b)	Conducted power	Pass	Meet the requirement of limit.
15.247(e)	Power Spectral Density	Pass	Refer to note 1
15.203	Antenna Requirement	Pass	Antenna connector is ipex(MHF) not a standard connector.

Note:

1. This report is a partial report. Therefore, only AC Power Conducted Emission, Output Power and Radiated Emissions were verified and recorded in this report. Other testing data please refer to the original BV CPS report no.: RFBCUG-WTW-P22010682.
2. For 2.4G band compliance with rule 15.247(d) of the band-edge items, the test plots were recorded in Annex A. Test Procedures refer to report 4.1.3.
3. Determining compliance based on the results of the compliance measurement, not taking into account measurement instrumentation uncertainty.

2.1 Measurement Uncertainty

Where relevant, the following measurement uncertainty levels have been estimated for tests performed on the EUT as specified in CISPR 16-4-2:

Measurement	Frequency	Expanded Uncertainty (k=2) (\pm)
Conducted Emissions at mains ports	150kHz ~ 30MHz	2.79 dB
Radiated Emissions up to 1 GHz	9kHz ~ 30MHz	3.00 dB
	30MHz ~ 200MHz	2.91 dB
	200MHz ~ 1000MHz	2.93 dB
Radiated Emissions above 1 GHz	1GHz ~ 18GHz	1.76 dB
	18GHz ~ 40GHz	1.77 dB

2.2 Modification Record

There were no modifications required for compliance.

3 General Information

3.1 General Description of EUT

Product	Point of Sale Terminal
Brand	Verifone
Test Model	UX700-ML-1
Sample Status	Engineering sample
Power Supply Rating	9-43Vdc, 2.4A-0.5A
Modulation Type	CCK, DQPSK, DBPSK for DSSS 64QAM, 16QAM, QPSK, BPSK for OFDM
Modulation Technology	DSSS, OFDM
Transfer Rate	802.11b: 11/5.5/2/1Mbps 802.11g: 54/48/36/24/18/12/9/6Mbps 802.11n: up to 72.2Mbps
Operating Frequency	2412 ~ 2462MHz
Number of Channel	802.11b, 802.11g, 802.11n (HT20): 11
Output Power	168.655mW
Antenna Type	Dipole antenna with 2.60dBi gain
Antenna Connector	ipex(MHF)
Accessory Device	Refer to external photo
Cable Supplied	Refer to external photo

Note:

- This report is FCC spot check verification report to the original BV CPS report no.: RFBCUG-WTW-P22010682. The differences compared with the original design is as below. Exhibit prepared for FCC Spot Check Verification report, the format, test items and amount of spot-check test data are decided by applicant's engineering judgment, for more details please refer to declaration letter exhibit. Therefore, only AC Power Conducted Emission, Output Power and Radiated Emissions were verified and recorded in this report. Radiated Emission tests according to original report radiated emission worst channel.

Difference:

- Changing FCC ID.
- Changing model.
- HW IO Bard:
 - FCC ID: B32UX700 and B32-UX700W are identical expect for IO Board only.
 - SAM slot depopulated.
 - Add cover and no any RF Modify.
- HW Main Borad: UWB module & GPS module depopulated. (GPS and UWB function Removed)
- Add one HUB with tablet including accessories.
- Add two Dongle including accessories.

2. The EUT provides 1 completed transmitter and 1 receiver.

Modulation Mode	TX Function
802.11b	1TX
802.11g	1TX
802.11n (HT20)	1TX

3. The accessory devices of EUT, please refer to external photo.

4. Detail antenna specification please refer to antenna datasheet an antenna gain measurement report.

5. 2.4GHz & BT or 5GHz & BT technology can transmit at same time.

6. Spurious emission of the simultaneous operation (2.4GHz & BT or 5GHz & BT) has been evaluated and no non-compliance was found.

3.2 Description of Test Modes

11 channels are provided for 802.11b, 802.11g and 802.11n (HT20):

Channel	Frequency	Channel	Frequency
1	2412MHz	7	2442MHz
2	2417MHz	8	2447MHz
3	2422MHz	9	2452MHz
4	2427MHz	10	2457MHz
5	2432MHz	11	2462MHz
6	2437MHz		

3.2.1 Test Mode Applicability and Tested Channel Detail

EUT Configure Mode	Applicable to				Description
	RE \geq 1G	RE<1G	PLC	Power	
A	√	√	√	√	EUT + 2AAAJ012F US adapter
B	-	√	√	-	EUT + 2ABL018F US adapter

Where RE \geq 1G: Radiated Emission above 1GHz & Bandedge Measurement
 RE<1G: Radiated Emission below 1GHz
 PLC: Power Line Conducted Emission
 Power: Conducted Output Power

Note: The EUT had been pre-tested on the positioned of each 3 axis. The worst case was found when positioned on **Z-plane**.

Radiated Emission Test (Above 1GHz):

- Pre-Scan has been conducted to determine the worst-case mode from all possible combinations between available modulations, data rates and antenna ports (if EUT with antenna diversity architecture).
- Following channel(s) was (were) selected for the final test as listed below.

EUT Configure Mode	Mode	Available Channel	Tested Channel	Modulation Technology	Modulation Type	Data Rate (Mbps)
A	802.11g	1 to 11	1	OFDM	BPSK	6.0

Radiated Emission Test (Below 1GHz):

- Pre-Scan has been conducted to determine the worst-case mode from all possible combinations between available modulations, data rates and antenna ports (if EUT with antenna diversity architecture).
- Following channel(s) was (were) selected for the final test as listed below.

EUT Configure Mode	Mode	Available Channel	Tested Channel	Modulation Technology	Modulation Type	Data Rate (Mbps)
A, B	802.11g	1 to 11	1	OFDM	BPSK	6.0

Power Line Conducted Emission Test:

- Pre-Scan has been conducted to determine the worst-case mode from all possible combinations between available modulations, data rates and antenna ports (if EUT with antenna diversity architecture).
- Following channel(s) was (were) selected for the final test as listed below.

EUT Configure Mode	Mode	Available Channel	Tested Channel	Modulation Technology	Modulation Type	Data Rate (Mbps)
A, B	802.11g	1 to 11	1	OFDM	BPSK	6.0

Conducted Output Power Measurement:

- This item includes all test value of each mode, but only includes spectrum plot of worst value of each mode.
- Pre-Scan has been conducted to determine the worst-case mode from all possible combinations between available modulations, data rates and antenna ports (if EUT with antenna diversity architecture).
- Following channel(s) was (were) selected for the final test as listed below.

EUT Configure Mode	Mode	Available Channel	Tested Channel	Modulation Technology	Modulation Type	Data Rate (Mbps)
A	802.11b	1 to 11	1, 6, 11	DSSS	DBPSK	1.0
A	802.11g	1 to 11	1, 6, 11	OFDM	BPSK	6.0
A	802.11n (HT20)	1 to 11	1, 6, 11	OFDM	BPSK	MCS0

Test Condition:

Applicable to	Environmental Conditions	Input Power	Tested by
RE \geq 1G	23 deg. C, 67% RH	120Vac, 60Hz	Greg Lin
RE<1G	23 deg. C, 67% RH	120Vac, 60Hz	Greg Lin
PLC	23 deg. C, 70% RH	120Vac, 60Hz	Greg Lin
Power	25 deg. C, 60% RH	120Vac, 60Hz	Jisyong Wang

3.3 Duty Cycle of Test Signal

Duty cycle of test signal is < 98%.

Duty cycle = 1.369/1.564 = 0.875, Duty factor = 10 * log (1/0.875) = 0.58

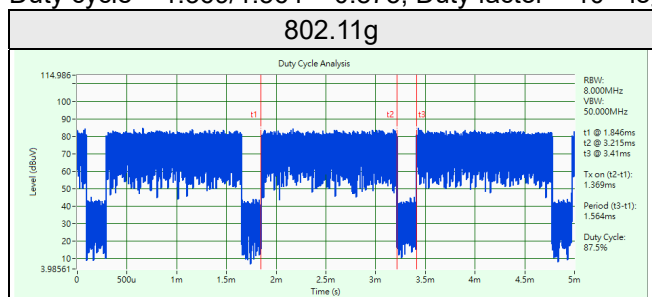

3.4 Description of Support Units

The EUT has been tested as an independent unit together with other necessary accessories or support units. The following support units or accessories were used to form a representative test configuration during the tests.

ID	Product	Brand	Model No.	Serial No.	FCC ID	Remarks
A.	Test Jig	NA	NA	NA	NA	Provided by manufacturer
B.	USB Flash	SanDisk	SDDD3-032G	NA	NA	-
C.	Load	NA	NA	NA	NA	-
D.	Notebook	Lenovo	20J4 MD A003TW	PF-11H9AK	FCC DoC Approved	-

Note: All power cords of the above support units are non-shielded (1.8m).

ID	Descriptions	Qty.	Length (m)	Shielding (Yes/No)	Cores (Qty.)	Remarks
1.	DC power cable	1	1.8	N	1	Attached on adapter
2.	LAN Cable	1	1.5	N	0	RJ45, Cat5e
3.	Type C Cable	1	1.0	Y	1	Attached on Test Jig
4.	Type C Cable	1	0.3	Y	0	Provided by manufacturer
5.	USB Cable	1	1.0	Y	0	Provided by manufacturer
6.	LAN to RS-232 Cable	1	1.0	Y	0	Provided by manufacturer
7.	RS-232 to USB Cable	1	1.0	N	0	-

3.4.1 Configuration of System under Test

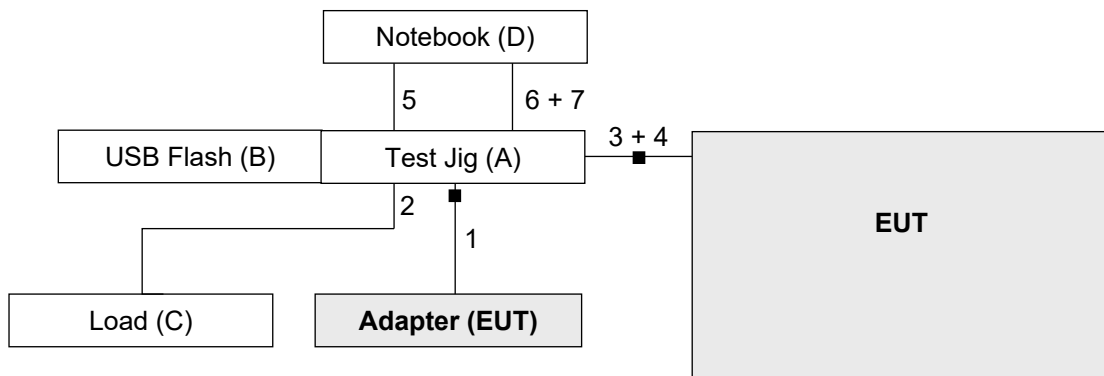

3.5 General Description of Applied Standards and References

The EUT is a RF Product. According to the specifications of the manufacturer, it must comply with the requirements of the following standards and references:

Test standard:

FCC Part 15, Subpart C (15.247)

ANSI C63.10-2013

All test items have been performed and recorded as per the above standards.

References Test Guidance:

KDB 558074 D01 15.247 Meas Guidance v05r02

All test items have been performed as a reference to the above KDB test guidance.

4 Test Types and Results

4.1 Radiated Emission and Bandedge Measurement

4.1.1 Limits of Radiated Emission and Bandedge Measurement

Radiated emissions which fall in the restricted bands must comply with the radiated emission limits specified as below table. Other emissions shall be at least 20dB below the highest level of the desired power:

Frequencies (MHz)	Field Strength (microvolts/meter)	Measurement Distance (meters)
0.009 ~ 0.490	2400/F(kHz)	300
0.490 ~ 1.705	24000/F(kHz)	30
1.705 ~ 30.0	30	30
30 ~ 88	100	3
88 ~ 216	150	3
216 ~ 960	200	3
Above 960	500	3

Note:

1. The lower limit shall apply at the transition frequencies.
2. Emission level (dBuV/m) = 20 log Emission level (uV/m).
3. For frequencies above 1000MHz, the field strength limits are based on average detector, however, the peak field strength of any emission shall not exceed the maximum permitted average limits, specified above by more than 20dB under any condition of modulation.

4.1.2 Test Instruments

Description & Manufacturer	Model No.	Serial No.	Cal. Date	Cal. Due
Test Receiver R&S	ESR3+	102782	Dec. 12, 2022	Dec. 11, 2023
Spectrum Analyzer R&S	FSW43	101866	Jan. 10, 2023	Jan. 09, 2024
Loop Antenna TESEQ	HLA 6121	45745	Jul. 27, 2022	Jul. 26, 2023
Pre-amplifier EMCI	EMC001340	980201	Sep. 23, 2022	Sep. 22, 2023
RF Coaxial Cable EMCI	5D-NM-BM	140903+140902	Jan. 15, 2022	Jan. 14, 2023
Preamplifier EMCI	EMC330N	980782	Jan. 16, 2023	Jan. 15, 2024
BILOG Antenna SCHWARZBECK	VULB9168	9168-1213	Oct. 20, 2022	Oct. 19, 2023
RF Coaxial Cable EMCI	EMCCFD400-NM-N M-500	201233	Jan. 16, 2023	Jan. 15, 2024
RF Coaxial Cable EMCI	EMCCFD400-NM-N M-3000	201235	Jan. 16, 2023	Jan. 15, 2024
RF Coaxial Cable EMCI	EMCCFD400-NM-N M-9000	201236	Jan. 16, 2023	Jan. 15, 2024
HORN Antenna RF SPIN	DRH18-E	210103A18E	Nov. 13, 2022	Nov. 12, 2023
Preamplifier EMCI	EMC118A45SE	980808	Dec. 29, 2022	Dec. 28, 2023
RF Coaxial Cable EMCI	EMC104-SM-SM-1 000	210102	Jan. 16, 2023	Jan. 15, 2024
RF Coaxial Cable EMCI	EMC104-SM-SM-3 000	201231	Jan. 16, 2023	Jan. 15, 2024
RF Coaxial Cable EMCI	EMC104-SM-SM-9 000	201243	Jan. 16, 2023	Jan. 15, 2024
Preamplifier EMCI	EMC184045SE	980788	Jan. 16, 2023	Jan. 15, 2024
HORN Antenna SCHWARZBECK	BBHA 9170	9170-1049	Nov. 13, 2022	Nov. 12, 2023
RF signal cable EMCI	EMC101G-KM-KM- 5000	201260	Jan. 16, 2023	Jan. 15, 2024
RF signal cable EMCI	EMC101G-KM-KM- 3000	201257	Jan. 16, 2023	Jan. 15, 2024
RF signal cable EMCI	EMC101G-KM-KM- 2000	201254	Jan. 16, 2023	Jan. 15, 2024
Software BV ADT	ADT_Radiated_ V7.6.15.9.5	NA	NA	NA
Antenna Tower & Turn Max-Full	MFT-151SS-0.5T	NA	NA	NA
Turn Table Max-Full	MF-7802BS	NA	NA	NA
Turn Table Controller Max-Full	MF-7802BS	MF780208674	NA	NA
Turn Table Controller Max-Full	MF-7802BS	MF780208674	NA	NA

Note: 1. The calibration interval of the above test instruments is 12 months and the calibrations are traceable to NML/ROC and NIST/USA.
2. The test was performed in WM - 966 chamber 8.

4.1.3 Test Procedures

For Radiated emission below 30MHz

- a. The EUT was placed on the top of a rotating table 0.8 meters above the ground at a 3 meter chamber room. The table was rotated 360 degrees to determine the position of the highest radiation.
- b. The EUT was set 3 meters away from the interference-receiving antenna, which was mounted on the top of a variable-height antenna tower.
- c. Parallel, perpendicular, and ground-parallel orientations of the antenna are set to make the measurement.
- d. For each suspected emission, the EUT was arranged to its worst case and the rotatable table was turned from 0 degrees to 360 degrees to find the maximum reading.
- e. The test-receiver system was set to Quasi-Peak Detect Function and Specified Bandwidth with Maximum Hold Mode.

Note:

1. The resolution bandwidth and video bandwidth of test receiver/spectrum analyzer is 9kHz at frequency below 30MHz.

For Radiated emission above 30MHz

- a. The EUT was placed on the top of a rotating table 0.8 meters (for 30MHz ~ 1GHz) / 1.5 meters (for above 1GHz) above the ground at 3 meter chamber room for test. The table was rotated 360 degrees to determine the position of the highest radiation.
- b. The EUT was set 3 meters away from the interference-receiving antenna, which was mounted on the top of a variable-height antenna tower.
- c. The height of antenna is varied from one meter to four meters above the ground to determine the maximum value of the field strength. Both horizontal and vertical polarizations of the antenna are set to make the measurement.
- d. For each suspected emission, the EUT was arranged to its worst case and then the antenna was tuned to heights from 1 meter to 4 meters and the rotatable table was turned from 0 degrees to 360 degrees to find the maximum reading.
- e. The test-receiver system was set to quasi-peak detect function and specified bandwidth with maximum hold mode when the test frequency is below 1 GHz.
- f. The test-receiver system was set to peak and average detect function and specified bandwidth with maximum hold mode when the test frequency is above 1 GHz. If the peak reading value also meets average limit, measurement with the average detector is unnecessary.

Note:

1. The resolution bandwidth and video bandwidth of test receiver/spectrum analyzer is 120kHz for Quasi-peak detection (QP) at frequency below 1GHz.
2. The resolution bandwidth of test receiver/spectrum analyzer is 1 MHz and the video bandwidth is 3 MHz for Peak detection (PK) at frequency above 1GHz.
3. The resolution bandwidth of test receiver/spectrum analyzer is 1MHz and the video bandwidth is $\geq 1/T$ (Duty cycle < 98%) or 10Hz (Duty cycle $\geq 98\%$) for Average detection (AV) at frequency above 1GHz. (RBW = 1MHz, VBW = 1kHz)
4. All modes of operation were investigated and the worst-case emissions are reported.

4.1.4 Deviation from Test Standard

No deviation.

4.1.5 Test Setup

For Radiated emission below 30MHz

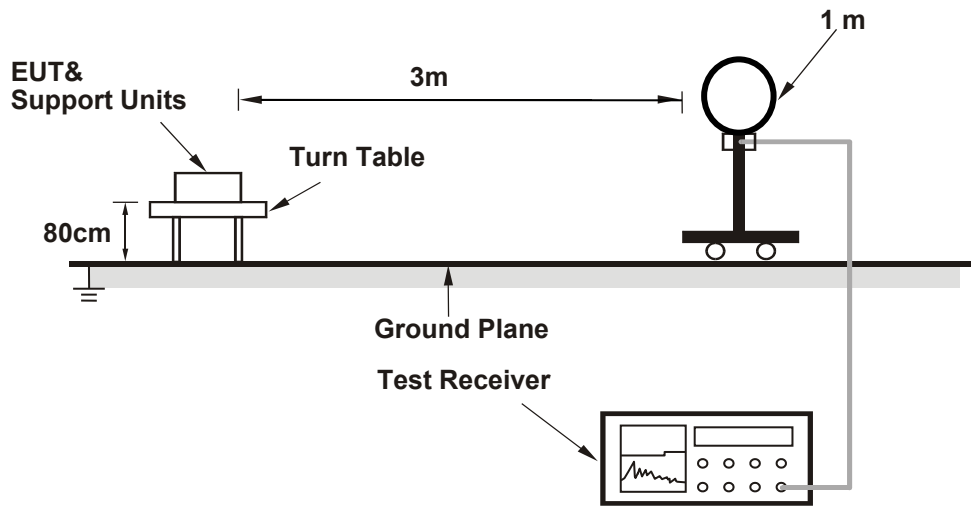

For Radiated emission 30MHz to 1GHz

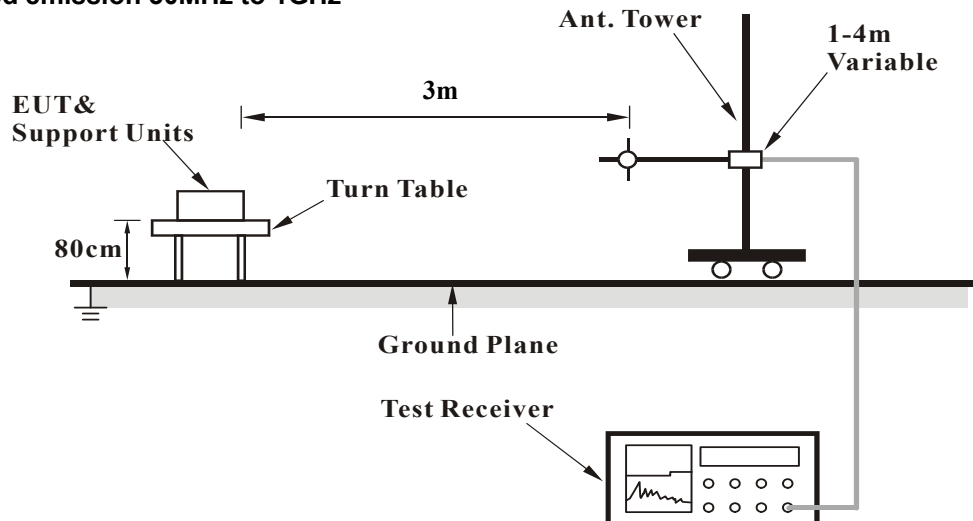

For Radiated emission above 1GHz

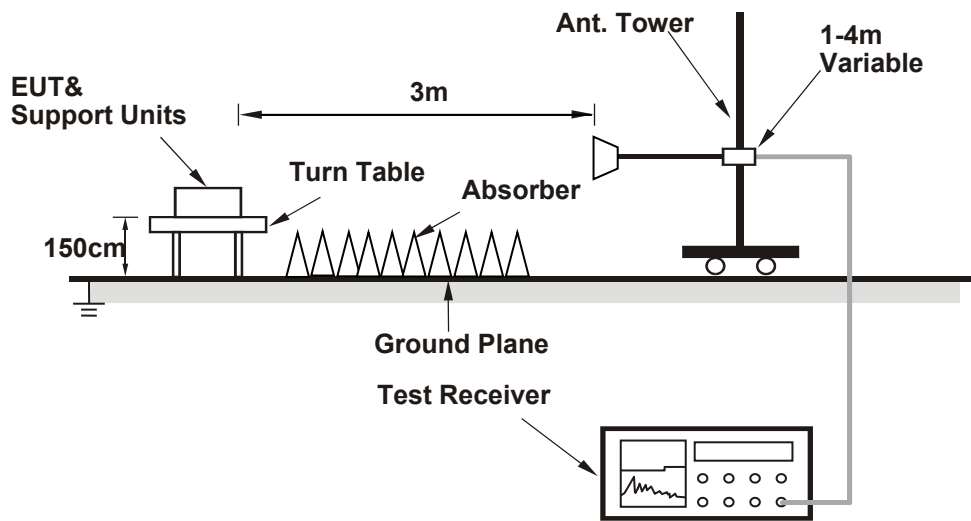

For the actual test configuration, please refer to the attached file (Test Setup Photo).

4.1.6 EUT Operating Conditions

- a. Set the EUT under transmission condition continuously at specific channel frequency.

4.1.7 Test Results

Above 1GHz Data:

RF Mode	TX 802.11g	Channel	CH 1 : 2412 MHz
Frequency Range	1GHz ~ 25GHz	Detector Function	Peak (PK) Average (AV)

Antenna Polarity & Test Distance : Horizontal at 3 m								
No	Frequency (MHz)	Emission Level (dBuV/m)	Limit (dBuV/m)	Margin (dB)	Antenna Height (m)	Table Angle (Degree)	Raw Value (dBuV)	Correction Factor (dB/m)
1	2390.00	61.6 PK	74.0	-12.4	2.56 H	80	29.3	32.3
2	2390.00	45.7 AV	54.0	-8.3	2.56 H	80	13.4	32.3
3	*2412.00	102.6 PK			2.56 H	80	70.3	32.3
4	*2412.00	92.4 AV			2.56 H	80	60.1	32.3
5	4824.00	47.8 PK	74.0	-26.2	1.74 H	93	44.2	3.6
6	4824.00	37.0 AV	54.0	-17.0	1.74 H	93	33.4	3.6
Antenna Polarity & Test Distance : Vertical at 3 m								
No	Frequency (MHz)	Emission Level (dBuV/m)	Limit (dBuV/m)	Margin (dB)	Antenna Height (m)	Table Angle (Degree)	Raw Value (dBuV)	Correction Factor (dB/m)
1	2390.00	72.7 PK	74.0	-1.3	2.46 V	113	40.4	32.3
2	2390.00	52.4 AV	54.0	-1.6	2.46 V	113	20.1	32.3
3	*2412.00	108.4 PK			2.46 V	113	76.1	32.3
4	*2412.00	97.9 AV			2.46 V	113	65.6	32.3
5	4824.00	48.2 PK	74.0	-25.8	1.63 V	117	44.6	3.6
6	4824.00	37.4 AV	54.0	-16.6	1.63 V	117	33.8	3.6

Remarks:

1. Emission Level(dBuV/m) = Raw Value(dBuV) + Correction Factor(dB/m).
2. Correction Factor(dB/m) = Antenna Factor(dB/m) + Cable Factor(dB) – Pre-Amplifier Factor(dB).
3. Margin value = Emission Level – Limit value.
4. The other emission levels were very low against the limit.
5. " * " : Fundamental frequency.

Below 1GHz worst-case data:

RF Mode	TX 802.11g	Channel	CH 1 : 2412 MHz
Frequency Range	30MHz ~ 1GHz	Detector Function	Quasi-Peak (QP)
Test Mode	A		

Antenna Polarity & Test Distance : Horizontal at 3 m								
No	Frequency (MHz)	Emission Level (dBuV/m)	Limit (dBuV/m)	Margin (dB)	Antenna Height (m)	Table Angle (Degree)	Raw Value (dBuV)	Correction Factor (dB/m)
1	44.55	27.8 QP	40.0	-12.2	1.00 H	23	41.1	-13.3
2	189.08	23.3 QP	43.5	-20.2	1.25 H	153	39.2	-15.9
3	296.75	24.8 QP	46.0	-21.2	1.50 H	267	37.5	-12.7
4	445.16	23.8 QP	46.0	-22.2	1.00 H	224	32.7	-8.9
5	588.72	25.8 QP	46.0	-20.2	1.25 H	348	31.7	-5.9
6	886.51	29.6 QP	46.0	-16.4	1.00 H	327	30.9	-1.3

Remarks:

1. Emission Level(dBuV/m) = Raw Value(dBuV) + Correction Factor(dB/m).
2. Correction Factor(dB/m) = Antenna Factor(dB/m) + Cable Factor(dB) – Pre-Amplifier Factor(dB).
3. Margin value = Emission Level – Limit value.
4. The other emission levels were very low against the limit of frequency range 30MHz~1000MHz.
5. The emission levels were very low against the limit of frequency range 9kHz~30MHz: the amplitude of spurious emissions attenuated more than 20 dB below the permissible value to be report.

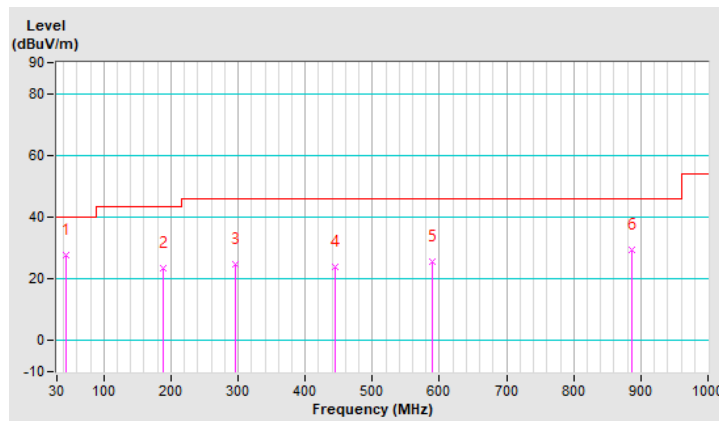

RF Mode	TX 802.11g	Channel	CH 1 : 2412 MHz
Frequency Range	30MHz ~ 1GHz	Detector Function	Quasi-Peak (QP)
Test Mode	A		

Antenna Polarity & Test Distance : Vertical at 3 m								
No	Frequency (MHz)	Emission Level (dBuV/m)	Limit (dBuV/m)	Margin (dB)	Antenna Height (m)	Table Angle (Degree)	Raw Value (dBuV)	Correction Factor (dB/m)
1	33.88	31.4 QP	40.0	-8.6	1.00 V	280	45.6	-14.2
2	108.57	29.7 QP	43.5	-13.8	1.00 V	230	46.0	-16.3
3	296.75	26.4 QP	46.0	-19.6	1.25 V	277	39.1	-12.7
4	445.16	28.7 QP	46.0	-17.3	1.00 V	294	37.6	-8.9
5	524.70	30.3 QP	46.0	-15.7	1.00 V	2	37.7	-7.4
6	683.78	31.1 QP	46.0	-14.9	1.50 V	333	35.4	-4.3

Remarks:

1. Emission Level(dBuV/m) = Raw Value(dBuV) + Correction Factor(dB/m).
2. Correction Factor(dB/m) = Antenna Factor(dB/m) + Cable Factor(dB) – Pre-Amplifier Factor(dB).
3. Margin value = Emission Level – Limit value.
4. The other emission levels were very low against the limit of frequency range 30MHz~1000MHz.
5. The emission levels were very low against the limit of frequency range 9kHz~30MHz: the amplitude of spurious emissions attenuated more than 20 dB below the permissible value to be report.

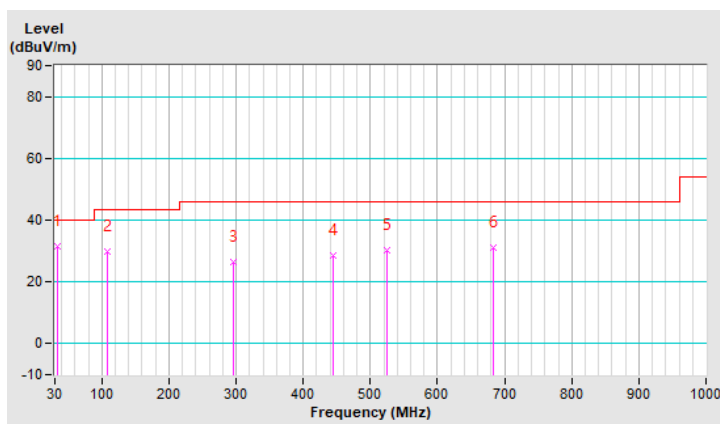

RF Mode	TX 802.11g	Channel	CH 1 : 2412 MHz
Frequency Range	30MHz ~ 1GHz	Detector Function	Quasi-Peak (QP)
Test Mode	B		

Antenna Polarity & Test Distance : Horizontal at 3 m								
No	Frequency (MHz)	Emission Level (dBuV/m)	Limit (dBuV/m)	Margin (dB)	Antenna Height (m)	Table Angle (Degree)	Raw Value (dBuV)	Correction Factor (dB/m)
1	40.67	32.7 QP	40.0	-7.3	1.25 H	258	46.3	-13.6
2	164.83	28.6 QP	43.5	-14.9	1.00 H	274	41.9	-13.3
3	296.75	23.4 QP	46.0	-22.6	1.50 H	274	36.1	-12.7
4	384.05	26.4 QP	46.0	-19.6	1.00 H	227	37.0	-10.6
5	674.08	27.5 QP	46.0	-18.5	1.00 H	216	32.1	-4.6
6	891.36	29.3 QP	46.0	-16.7	1.25 H	289	30.6	-1.3

Remarks:

1. Emission Level(dBuV/m) = Raw Value(dBuV) + Correction Factor(dB/m).
2. Correction Factor(dB/m) = Antenna Factor(dB/m) + Cable Factor(dB) – Pre-Amplifier Factor(dB).
3. Margin value = Emission Level – Limit value.
4. The other emission levels were very low against the limit of frequency range 30MHz~1000MHz.
5. The emission levels were very low against the limit of frequency range 9kHz~30MHz: the amplitude of spurious emissions attenuated more than 20 dB below the permissible value to be report.

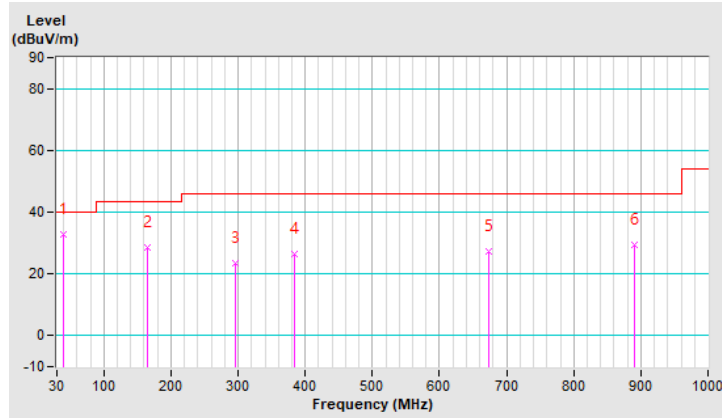

RF Mode	TX 802.11g	Channel	CH 1 : 2412 MHz
Frequency Range	30MHz ~ 1GHz	Detector Function	Quasi-Peak (QP)
Test Mode	B		

Antenna Polarity & Test Distance : Vertical at 3 m								
No	Frequency (MHz)	Emission Level (dBuV/m)	Limit (dBuV/m)	Margin (dB)	Antenna Height (m)	Table Angle (Degree)	Raw Value (dBuV)	Correction Factor (dB/m)
1	30.00	33.6 QP	40.0	-6.4	1.50 V	18	48.0	-14.4
2	103.72	29.1 QP	43.5	-14.4	1.25 V	234	46.0	-16.9
3	296.75	26.1 QP	46.0	-19.9	1.00 V	280	38.8	-12.7
4	527.61	30.3 QP	46.0	-15.7	1.50 V	2	37.6	-7.3
5	686.69	31.3 QP	46.0	-14.7	1.00 V	2	35.6	-4.3
6	894.27	29.6 QP	46.0	-16.4	1.50 V	2	31.0	-1.4

Remarks:

1. Emission Level(dBuV/m) = Raw Value(dBuV) + Correction Factor(dB/m).
2. Correction Factor(dB/m) = Antenna Factor(dB/m) + Cable Factor(dB) – Pre-Amplifier Factor(dB).
3. Margin value = Emission Level – Limit value.
4. The other emission levels were very low against the limit of frequency range 30MHz~1000MHz.
5. The emission levels were very low against the limit of frequency range 9kHz~30MHz: the amplitude of spurious emissions attenuated more than 20 dB below the permissible value to be report.

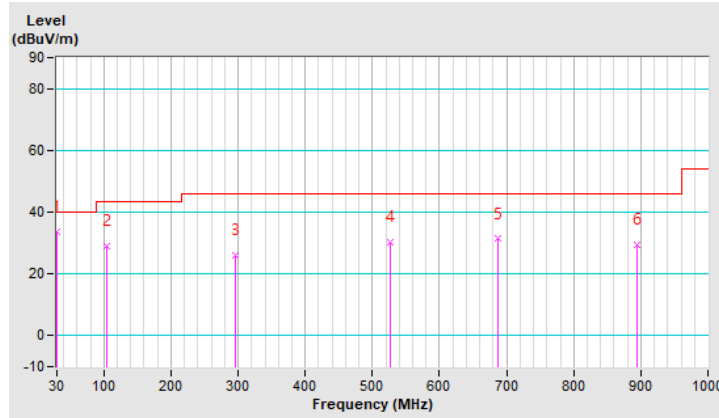

4.2 Conducted Emission Measurement

4.2.1 Limits of Conducted Emission Measurement

Frequency (MHz)	Conducted Limit (dBuV)	
	Quasi-peak	Average
0.15 - 0.5	66 - 56	56 - 46
0.50 - 5.0	56	46
5.0 - 30.0	60	50

Note: 1. The lower limit shall apply at the transition frequencies.
 2. The limit decreases in line with the logarithm of the frequency in the range of 0.15 to 0.50MHz.

4.2.2 Test Instruments

Description & Manufacturer	Model No.	Serial No.	Cal. Date	Cal. Due
Test Receiver ROHDE & SCHWARZ	ESCI	100613	Dec. 05, 2022	Dec. 04, 2023
RF signal cable Woken	5D-FB	Cable-cond1-01	Jan. 07, 2023	Jan. 06, 2024
LISN ROHDE & SCHWARZ (EUT)	ENV216	101826	Mar. 14, 2022	Mar. 13, 2023
LISN ROHDE & SCHWARZ (Peripheral)	ESH3-Z5	100311	Sep. 12, 2022	Sep. 11, 2023
Software ADT	BV ADT_Cond_ V7.3.7.4	NA	NA	NA

Note: 1. The calibration interval of the above test instruments is 12 months and the calibrations are traceable to NML/ROC and NIST/USA.
 2. The test was performed in HY - Conduction 1.
 3. The VCCI Site Registration No. is C-12040.

4.2.3 Test Procedures

- The EUT was placed 0.4 meters from the conducting wall of the shielded room with EUT being connected to the power mains through a line impedance stabilization network (LISN). Other support units were connected to the power mains through another LISN. The two LISNs provide 50 ohm/ 50uH of coupling impedance for the measuring instrument.
- Both lines of the power mains connected to the EUT were checked for maximum conducted interference.
- The frequency range from 150kHz to 30MHz was searched. Emission levels under (Limit - 20dB) was not recorded.

Note: The resolution bandwidth and video bandwidth of test receiver is 9kHz for quasi-peak detection (QP) and average detection (AV) at frequency 0.15MHz-30MHz.

4.2.4 Deviation from Test Standard

No deviation.

4.2.5 Test Setup

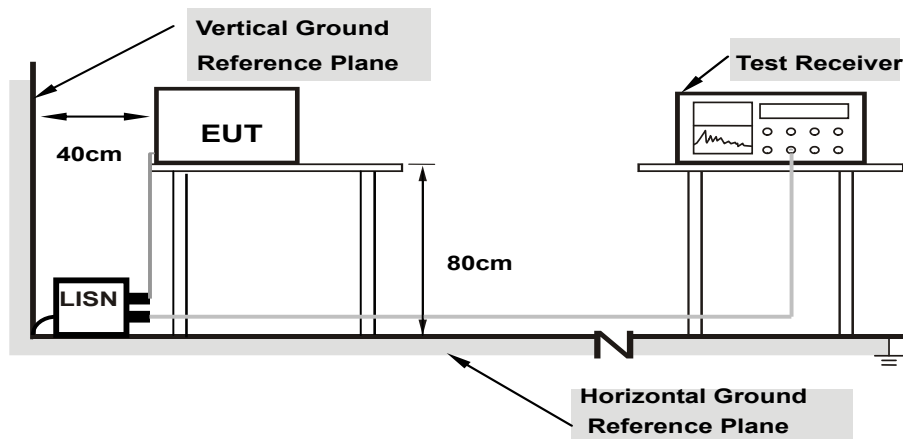

Note: 1.Support units were connected to second LISN.

For the actual test configuration, please refer to the attached file (Test Setup Photo).

4.2.6 EUT Operating Conditions

Same as 4.1.6.

4.2.7 Test Results

802.11g

Phase	Line (L)	Detector Function	Quasi-Peak (QP) / Average (AV)
Test Mode	A		

No	Freq. [MHz]	Corr. Factor (dB)	Reading Value		Emission Level		Limit		Margin	
			[dB (uV)]		[dB (uV)]		[dB (uV)]		(dB)	
			Q.P.	AV.	Q.P.	AV.	Q.P.	AV.	Q.P.	AV.
1	0.15000	9.68	32.07	20.43	41.75	30.11	66.00	56.00	-24.25	-25.89
2	0.18200	9.71	32.89	19.53	42.60	29.24	64.39	54.39	-21.79	-25.15
3	0.36600	9.79	25.96	15.91	35.75	25.70	58.59	48.59	-22.84	-22.89
4	0.65400	9.84	22.59	15.75	32.43	25.59	56.00	46.00	-23.57	-20.41
5	5.83800	10.00	17.22	9.45	27.22	19.45	60.00	50.00	-32.78	-30.55
6	9.79800	10.04	25.95	17.64	35.99	27.68	60.00	50.00	-24.01	-22.32

Remarks:

1. Q.P. and AV. are abbreviations of quasi-peak and average individually.
2. The emission levels of other frequencies were very low against the limit.
3. Margin value = Emission level - Limit value
4. Correction factor = Insertion loss + Cable loss
5. Emission Level = Correction Factor + Reading Value.

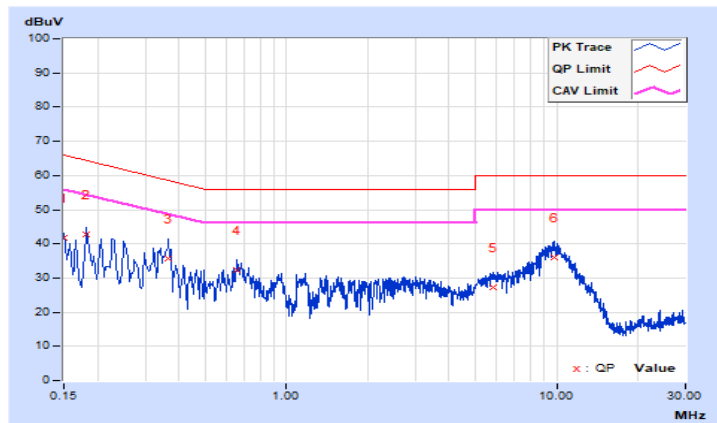

Phase	Neutral (N)	Detector Function	Quasi-Peak (QP) / Average (AV)
Test Mode	A		

No	Freq. [MHz]	Corr. Factor (dB)	Reading Value [dB (uV)]		Emission Level [dB (uV)]		Limit [dB (uV)]		Margin (dB)	
			Q.P.	AV.	Q.P.	AV.	Q.P.	AV.	Q.P.	AV.
			1	0.17800	9.70	34.96	18.70	44.66	28.40	64.58
2	0.19400	9.72	32.61	18.47	42.33	28.19	63.86	53.86	-21.53	-25.67
3	0.26992	9.74	25.29	13.48	35.03	23.22	61.12	51.12	-26.09	-27.90
4	0.38600	9.79	22.56	9.35	32.35	19.14	58.15	48.15	-25.80	-29.01
5	0.67800	9.82	22.23	17.04	32.05	26.86	56.00	46.00	-23.95	-19.14
6	9.57000	10.07	21.21	12.34	31.28	22.41	60.00	50.00	-28.72	-27.59

Remarks:

1. Q.P. and AV. are abbreviations of quasi-peak and average individually.
2. The emission levels of other frequencies were very low against the limit.
3. Margin value = Emission level - Limit value
4. Correction factor = Insertion loss + Cable loss
5. Emission Level = Correction Factor + Reading Value.

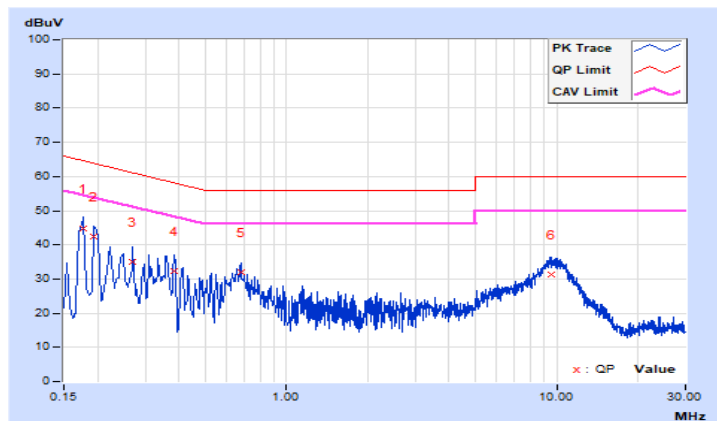

Phase	Line (L)	Detector Function	Quasi-Peak (QP) / Average (AV)
Test Mode	B		

No	Freq. [MHz]	Corr. Factor (dB)	Reading Value [dB (uV)]		Emission Level [dB (uV)]		Limit [dB (uV)]		Margin (dB)	
			Q.P.	AV.	Q.P.	AV.	Q.P.	AV.	Q.P.	AV.
			1	0.15000	9.68	31.79	17.18	41.47	26.86	66.00
2	0.16200	9.69	33.49	18.14	43.18	27.83	65.36	55.36	-22.18	-27.53
3	0.19000	9.71	28.84	14.67	38.55	24.38	64.04	54.04	-25.49	-29.66
4	0.39400	9.81	25.77	22.24	35.58	32.05	57.98	47.98	-22.40	-15.93
5	0.66987	9.84	21.33	15.34	31.17	25.18	56.00	46.00	-24.83	-20.82
6	9.09400	10.03	15.99	12.16	26.02	22.19	60.00	50.00	-33.98	-27.81

Remarks:

1. Q.P. and AV. are abbreviations of quasi-peak and average individually.
2. The emission levels of other frequencies were very low against the limit.
3. Margin value = Emission level - Limit value
4. Correction factor = Insertion loss + Cable loss
5. Emission Level = Correction Factor + Reading Value.

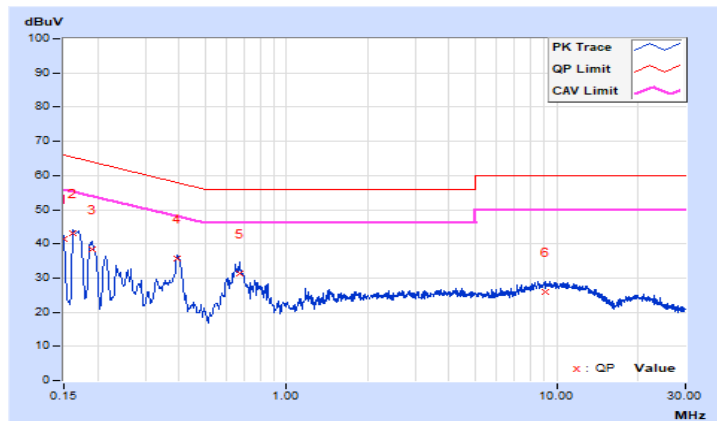

Phase	Neutral (N)	Detector Function	Quasi-Peak (QP) / Average (AV)
Test Mode	B		

No	Freq. [MHz]	Corr. Factor (dB)	Reading Value [dB (uV)]		Emission Level [dB (uV)]		Limit [dB (uV)]		Margin (dB)	
			Q.P.	AV.	Q.P.	AV.	Q.P.	AV.	Q.P.	AV.
			1	0.15687	9.69	35.82	20.16	45.51	29.85	65.63
2	0.17800	9.70	32.43	17.70	42.13	27.40	64.58	54.58	-22.45	-27.18
3	0.20577	9.72	27.63	14.19	37.35	23.91	63.37	53.37	-26.02	-29.46
4	0.39800	9.79	27.61	26.73	37.40	36.52	57.90	47.90	-20.50	-11.38
5	0.67800	9.82	21.82	16.42	31.64	26.24	56.00	46.00	-24.36	-19.76
6	7.57800	10.04	17.03	14.06	27.07	24.10	60.00	50.00	-32.93	-25.90

Remarks:

1. Q.P. and AV. are abbreviations of quasi-peak and average individually.
2. The emission levels of other frequencies were very low against the limit.
3. Margin value = Emission level - Limit value
4. Correction factor = Insertion loss + Cable loss
5. Emission Level = Correction Factor + Reading Value.

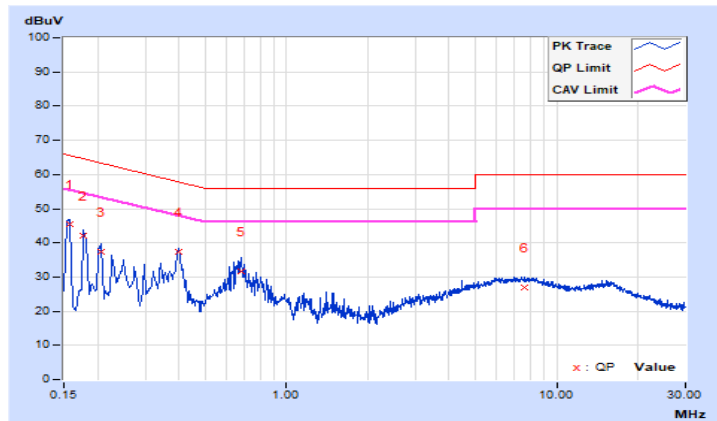

4.3 Conducted Output Power Measurement

4.3.1 Limits of Conducted Output Power Measurement

For systems using digital modulation in the 2400–2483.5 MHz bands: 1 Watt (30dBm)

4.3.2 Test Setup

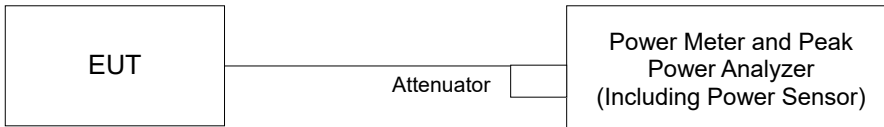

4.3.3 Test Instruments

Description & Manufacturer	Model No.	Serial No.	Cal. Date	Cal. Due
Wideband Power Sensor KEYSIGHT	N1923A	MY58020002	Jan. 18, 2023	Jan. 17, 2024
Peak Power Analyzer KEYSIGHT	8990B	MY51000485	Jan. 19, 2023	Jan. 18, 2024
Spectrum Analyzer R&S	FSV40	100979	Mar. 25, 2022	Mar. 24, 2023

Note: 1. The calibration interval of the above test instruments is 12 months and the calibrations are traceable to NML/ROC and NIST/USA.

4.3.4 Test Procedures

For Peak Power

A peak power sensor was used on the output port of the EUT. A power meter was used to read the response of the peak power sensor. Record the power level.

For Average Power

Average power sensor was used to perform output power measurement, trigger and gating function of wide band power meter is enabled to measure max output power of TX on burst. Duty factor is not added to measured value.

4.3.5 Deviation from Test Standard

No deviation.

4.3.6 EUT Operating Conditions

Same as item 4.3.6.

4.3.7 Test Results

For Peak Power

802.11b

Channel	Frequency (MHz)	Peak Power (mW)	Peak Power (dBm)	Limit (dBm)	Pass / Fail
1	2412	71.121	18.52	30.00	Pass
6	2437	73.451	18.66	30.00	Pass
11	2462	70.146	18.46	30.00	Pass

802.11g

Channel	Frequency (MHz)	Peak Power (mW)	Peak Power (dBm)	Limit (dBm)	Pass / Fail
1	2412	140.281	21.47	30.00	Pass
6	2437	168.655	22.27	30.00	Pass
11	2462	85.901	19.34	30.00	Pass

802.11n (HT20)

Channel	Frequency (MHz)	Peak Power (mW)	Peak Power (dBm)	Limit (dBm)	Pass / Fail
1	2412	136.773	21.36	30.00	Pass
6	2437	165.196	22.18	30.00	Pass
11	2462	74.645	18.73	30.00	Pass

For Average Power

802.11b

Channel	Frequency (MHz)	Average Power (mW)	Average Power (dBm)	Limit (dBm)	Pass / Fail
1	2412	39.537	15.97	30.00	Pass
6	2437	39.902	16.01	30.00	Pass
11	2462	38.459	15.85	30.00	Pass

802.11g

Channel	Frequency (MHz)	Average Power (mW)	Average Power (dBm)	Limit (dBm)	Pass / Fail
1	2412	31.696	15.01	30.00	Pass
6	2437	41.976	16.23	30.00	Pass
11	2462	11.83	10.73	30.00	Pass

802.11n (HT20)

Channel	Frequency (MHz)	Average Power (mW)	Average Power (dBm)	Limit (dBm)	Pass / Fail
1	2412	26.485	14.23	30.00	Pass
6	2437	37.325	15.72	30.00	Pass
11	2462	9.162	9.62	30.00	Pass

Annex A - Band Edge Measurement

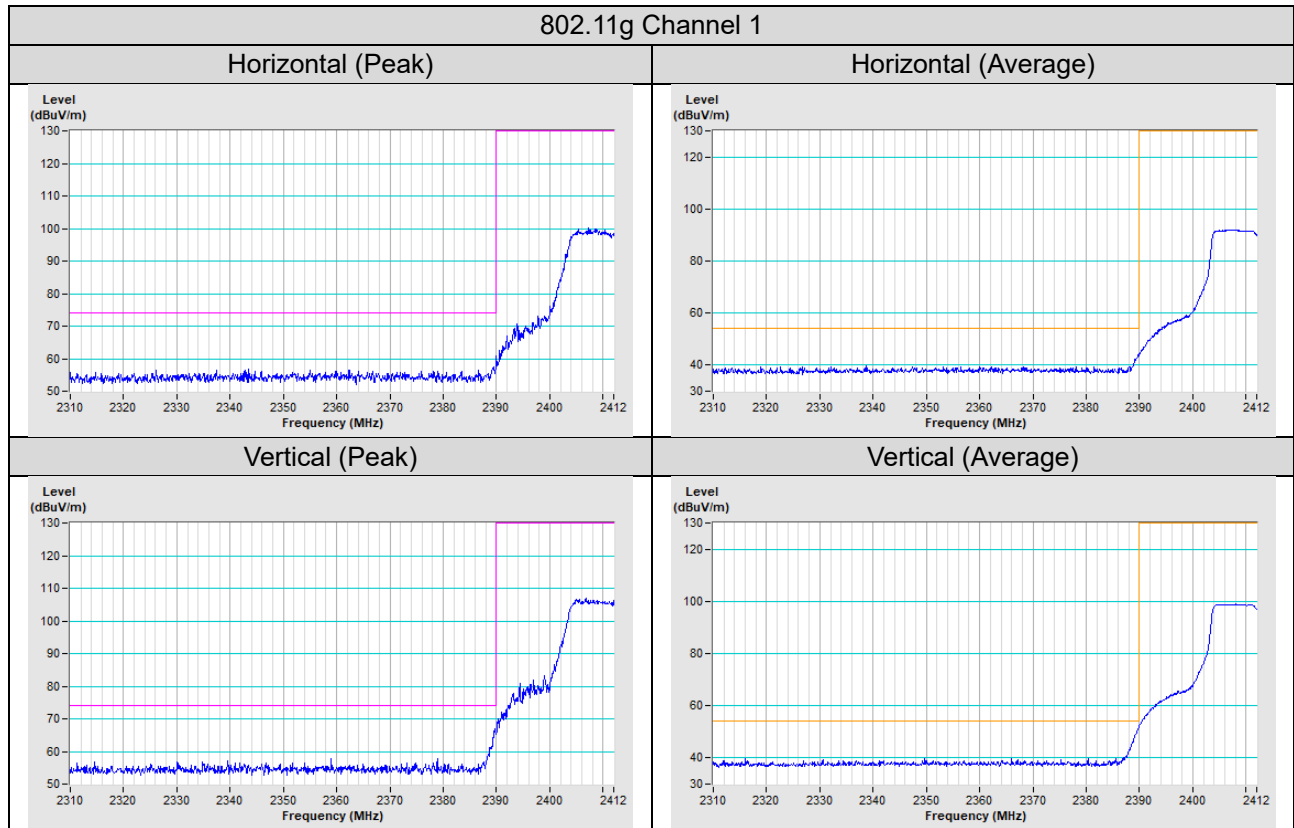

5 Pictures of Test Arrangements

Please refer to the attached file (Test Setup Photo).

Appendix – Information of the Testing Laboratories

We, Bureau Veritas Consumer Products Services (H.K.) Ltd., Taoyuan Branch, were founded in 1988 to provide our best service in EMC, Radio, Telecom and Safety consultation. Our laboratories are FCC recognized accredited test firms and accredited and approved according to ISO/IEC 17025.

If you have any comments, please feel free to contact us at the following:

Lin Kou EMC/RF Lab

Tel: 886-2-26052180

Fax: 886-2-26051924

Hsin Chu EMC/RF/Telecom Lab

Tel: 886-3-6668565

Fax: 886-3-6668323

Hwa Ya EMC/RF/Safety Lab

Tel: 886-3-3183232

Fax: 886-3-3270892

Email: service.adt@tw.bureauveritas.com

Web Site: www.bureauveritas-adt.com

The address and road map of all our labs can be found in our web site also.

--- END ---