

FCC Test Report

for

POS Terminal

Trade Name : Verifone
Model Number : UX410
FCC ID : B32UX410
IC : 787C-UX410
Report Number : RF-V040-1605-021
Date of Receipt : May 16, 2016
Date of Report : June 14, 2016

Prepared for

Verifone Inc.

1400 West Stanford Ranch Road, Suite 200, Rocklin, CA, 95765, UNITED STATES

Prepared by



Central Research Technology Co.

EMC Test Laboratory

11, Lane 41, Fushuen St., Jungshan Chiu, Taipei, Taiwan, 104, R.O.C.



NVLAP LAB CODE 200575-0

This report shall not be reproduced, except in full, without the written approval of Central Research Technology Co.. It may be duplicated completely in its entirety for legal use with the permission of the applicant. It must not be used by the client to claim product certification, approval, or endorsement by NVLAP, NIST, or any agency of the Federal Government. The test result in the report applies only to the sample tested.

Verification

Equipment Under Test : POS Terminal
Model No. : UX410
FCC ID : B32UX410
IC : 787C-UX410
Applicant : Verifone Inc.
Address : 1400 West Stanford Ranch Road, Suite 200, Rocklin, CA,
95765, UNITED STATES
Applicable Standards : **FCC Part 15, Subpart C**
RSS 210 ISSUE 8 December 2010+A1 February 2015
RSS-Gen ISSUE 4
Date of Testing : May 20 ~ June 3, 2016
Deviation : N/A
Condition of Test Sample : Mass Production

We, **Central Research Technology Co.**, hereby certify that one sample of the designated product was tested in our facility during the period mentioned above. The test records, data evaluation and Equipment Under Test (EUT) configurations shown in the present report are true and accurate representation of the measurements of the sample's RF characteristics under the conditions herein specified.

The test results show that the EUT as described in the present report is in compliance with the requirements set forth in the standards mentioned above and apply to the tested sample identified in the present report only. The test report shall not be reproduced, except in its entirety, without the written approval of Central Research Technology Co.

PREPARED BY : Cathy Chen , **DATE** : June 14, 2016
(Cathy Chen/ Technical Manager)
APPROVED BY : T. Y. Shih , **DATE** : June 14, 2016
(Tsun-Yu Shih/General Manager)

Contents

1.	General Description	5
1.1	GENERAL DESCRIPTION OF EUT	5
1.2	TEST MODE	6
1.3	APPLIED STANDARDS	7
1.4	THE SUPPORT UNITS	11
1.5	LAYOUT OF SETUP	12
1.6	TEST CAPABILITY	13
1.7	MEASUREMENT UNCERTAINTY	15
2.	Conducted Emission Measurement	16
2.1	LIMITS FOR EMISSION MEASUREMENT	16
2.2	TEST INSTRUMENTS	17
2.3	TEST PROCEDURES	19
2.4	TEST CONFIGURATIONS	20
2.5	TEST DATA.....	21
3.	Field Strength of fundamental Measurement.....	25
3.1	APPLIED STANDARD	25
3.2	TEST INSTRUMENTS	26
3.3	MEASUREMENT PROCEDURE	27
3.4	TEST CONFIGURATION	28
3.5	TEST RESULTS	29
4.	Radiated Emission	31
4.1	APPLIED STANDARD	31
4.2	TEST INSTRUMENTS	32
4.3	MEASUREMENT PROCEDURE.....	34
4.4	TEST CONFIGURATION	35
4.5	TEST RESULTS	36
5.	Frequency Tolarence	38
5.1	APPLIED STANDARD	38
5.2	TEST INSTRUMENTS	39
5.3	MEASUREMENT PROCEDURE.....	40
5.4	TEST CONFIGURATION	40
5.5	TEST RESULTS	41
6.	20dB Bandwidth	45

6.1	APPLIED STANDARD	45
6.2	TEST INSTRUMENTS	45
6.3	MEASUREMENT PROCEDURE	46
6.4	TEST CONFIGURATION	46
6.5	TEST RESULTS	47
7.	Occupied Bandwidth	48
7.1	APPLIED STANDARD	48
7.2	TEST INSTRUMENTS	49
7.3	MEASUREMENT PROCEDURE	50
7.4	TEST CONFIGURATION	50
7.5	TEST DATA	51
8.	Antenna Requirement	52
8.1	APPLIED STANDARD	52
8.2	ANTENNA TYPE	52
8.3	APPLICABLE RESULT	52

Attachment 1 – Photographs of the Test Configurations

Attachment 2 – External Photographs of EUT

Attachment 3 – Internal Photographs of EUT

1. General Description

1.1 General Description of EUT

Equipment Under Test : POS Terminal

Model No. : UX410

Power in : 12Vdc-24Vdc supplied by the power supply or adaptor

Power Specification : 1. Trade Name: Verifone
 Model No.: A140-5120330G
 Input : 100-240V~, 50/60Hz, 2A
 Output : 12Vdc, 3.3A

2. Trade Name: TRACO
 Model No.: TSP 090-124N-A
 Input : 115-240V~, 50/60Hz, 2.1/1.0A
 Output : 24Vdc, 3.75A

Test Voltage : 120Vac/60Hz to the power adaptor

Frequency Range : 13.56MHz

Channel Numbers : 1

Function Modulation : ASK

Function Description :

The EUT is used to transmit and receive signal both. Please refer to the user’s manual for the details.

1	Product SW/HW version	DVT1/30470103
2	Radio SW/HW version	DVT1/30470103
3	Test SW Version	N/A
4	RF power setting in TEST SW	N/A

1.2 Test Mode

Pre-scan Mode

Test Mode	Test Voltage
Mode 1	120Vac/60Hz to Power Adaptor: A140-5120330G
Mode 2	120Vac/60Hz to Power supply: TSP 090-124N-A

According to the preliminary test, It was found that the Mode 1 is the worst. It was taken as the representative condition for test and its data are recorded in the present document.

1.3 Applied standards

(1) Field strength of Fundametal

According to FCC 15.225(a) and RSS-210 A2.6(a), the field strength of any emissions within the band 13.553 - 13.567 MHz shall not exceed 15,848 microvolts/meter at 30 meters.

(2) Band Edge

According to FCC 15.225(b) and RSS-210 A2.6(b), Within the bands 13.410-13.553 MHz and 13.567-13.710 MHz, the field strength of any emissions shall not exceed 334 microvolts/meter at 30 meters. According to FCC 15.225(c) and RSS-210 A2.6(c) , Within the bands 13.110-13.410 MHz and 13.710-14.010 MHz the field strength of any emissions shall not exceed 106 microvolts/meter at 30 meters.

(3) Radiation emission

According to 15.225(d), the field strength of any emissions appearing outside of the 13.110-14.010 MHz band shall not exceed the general radiated emission limits in § 15.209.

According to RSS-210 A2.6(d), 30 microvolts/m (29.5 dB μ V/m) at 30 m, outside the band 13.110-14.010 MHz.

(4) Frequency tolerance

According to 15.225(e) and RSS-210 A2.6, the frequency tolerance of the carrier signal shall be maintained within +/- 0.01% of the operating frequency over a temperature variation of -20 degrees to +50 degrees C at normal supply voltage, and for a variation in the primary supply voltage from 85% to 115% of the rated supply voltage at a temperature of 20 degrees C. For battery operated equipment, the equipment tests shall be performed using a new battery.

(5) Radiated emission limits, general requirements.

According to FCC 15.209 and RSS-Gen 8.9, except as provided elsewhere in this Subpart, the emissions from an intentional radiator shall not exceed the field strength levels specified in the following table:

Frequency (MHz)	Field Strength (uV/m)	Measurement Distance (m)
0.009 - 0.490	2400/F(kHz)	300
0.490 - 1.705	24000/F(kHz)	30
1.705 - 30.0	30	30
30 - 88	100 **	3
88 - 216	150 **	3
216 - 960	200 **	3
Above 960	500	3

** Except as provided in paragraph (g), fundamental emissions from intentional radiators operating under this Section shall not be located in the frequency bands 54-72 MHz, 76-88 MHz, 174-216 MHz or 470-806 MHz. However, operation within these frequency bands is permitted under other sections of this Part, e.g., Sections 15.231 and 15.241.

(6) 20dB Bandwidth

According to FCC 15.215(c) requires the device must be designed to ensure that the 20 dB bandwidth of the emission, or whatever bandwidth may otherwise be specified in the specific rule section under which the equipment operates.

(7) Occupied Bandwidth

According to RSS-Gen 6.6, when the occupied bandwidth limit is not stated in the applicable RSS or reference measurement method, the transmitted signal bandwidth shall be reported as the 99% emission bandwidth, as calculated or measured.

(8) Conduction Emission Requirement

For intentional device, according to FCC 15.207(a) and RSS-Gen 8.8, line conduction emission limit is as below table.

Frequency of Emission (MHz)	Conducted Limit (dBuV)	
	Quasi-peak	Average
0.15 – 0.5	66 to 56*	56 to 46*
0.5 - 5	56	46
5 - 30	60	50

* Decreases with the logarithm of the frequency.

(9) Restricted Band

Frequency (MHz)	Frequency (MHz)	Frequency (MHz)	Frequency (GHz)
0.090 - 0.110	16.42 - 16.423	399.9 - 410	4.5 - 5.15
¹ 0.495 - 0.505	16.69475 - 16.69525	608 - 614	5.35 - 5.46
² 1735 - 2.1905	16.80425 - 16.80475	960 - 1240	7.25 - 7.75
4.125 - 4.128	25.5 - 25.67	1300 - 1427	8.025 - 8.5
4.17725 - 4.17775	37.5 - 38.25	1435 - 1626.5	9.0 - 9.2
4.20725 - 4.20775	73 - 74.6	1645.5 - 1646.5	9.3 - 9.5
6.215 - 6.218	74.8 - 75.2	1660 - 1710	10.6 - 12.7
6.26775 - 6.26825	108 - 121.94	1718.8 - 1722.2	13.25 - 13.4
6.31175 - 6.31225	123 - 138	2200 - 2300	14.47 - 14.5
8.291 - 8.294	149.9 - 150.05	2310 - 2390	15.35 - 16.2
8.362 - 8.366	156.52475 - 156.52525	2483.5 - 2500	17.7 - 21.4
8.37625 - 8.38675	156.7 - 156.9	2690 - 2900	22.01 - 23.12
8.41425 - 8.41475	162.0125 - 167.17	3260 - 3267	23.6 - 24.0
12.29 - 12.293	167.72 - 173.2	3332 - 3339	31.2 - 31.8
12.51975 - 12.52025	240 - 285	3345.8 - 3358	36.43 - 36.5
12.57675 - 12.57725	322 - 335.4	3600 - 4400	(2)
13.36 - 13.41			

¹ Until February 1, 1999, this restricted band shall be 0.490-0.510 MHz.

² Above 38.6

(10) Antenna Requirement

According to FCC 15.203, an intentional radiator shall be designed to ensure that no antenna other than that furnished by the responsible party shall be used with the device. The use of a permanently attached antenna or of an antenna that uses a unique coupling to the intentional radiator shall be considered sufficient to comply with the provisions of this Section. The manufacturer may design the unit so that a broken antenna can be replaced by the user, but the use of a standard antenna jack or electrical connector is prohibited. This requirement does not apply to carrier current devices or to devices operated under the provisions of Sections 15.211, 15.213, 15.217, 15.219, or 15.221. Further, this requirement does not apply to intentional radiators that must be professionally installed, such as perimeter protection systems and some field disturbance sensors, or to other intentional radiators which, in accordance with Section 15.31(d), must be measured at the installation site. However, the installer shall be responsible for ensuring that the proper antenna is employed so that the limits in this Part are not exceeded.

1.4 The Support Units

No.	Unit	Model No.	FCC ID	Trade Name	Power Cord	Supported by lab.
1.	SAM Card	N/A	N/A	Verifone	N/A	
2.	USB Flash Disk	N/A	N/A	N/A	N/A	

1.5 Layout of Setup

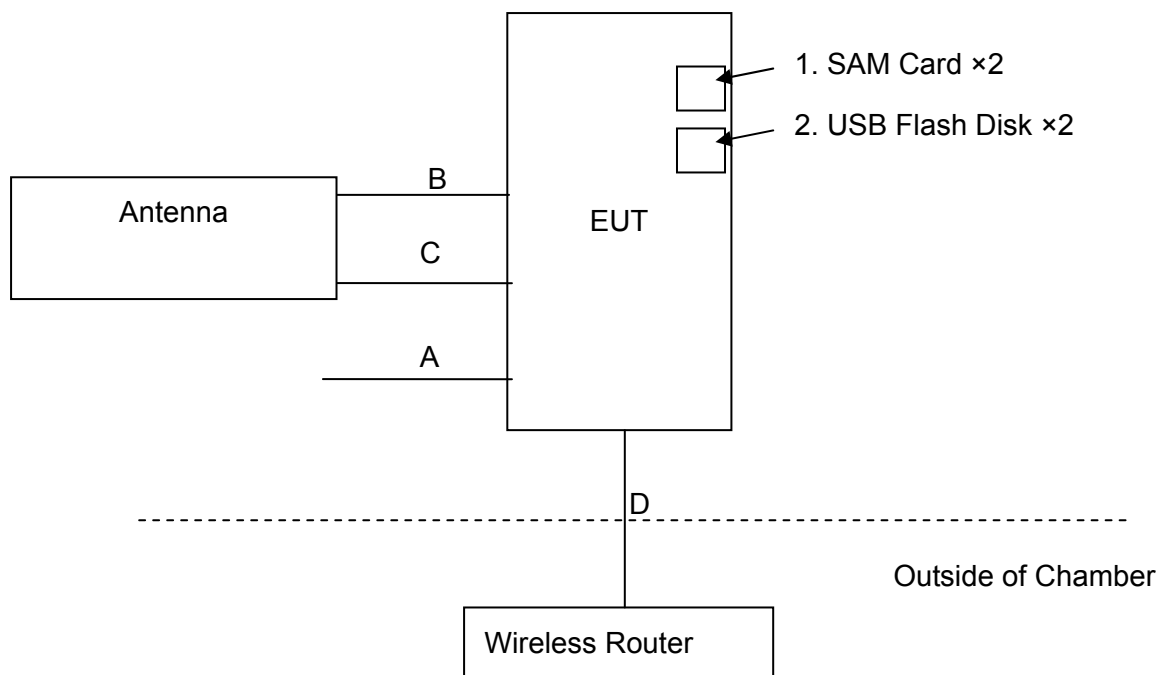

Connecting Cables :

No.	Cable	Length	Shielded	Core	Shielded Backshell	Supported by lab.	Note
A	RS232 Cable (26264-02 Rev B)	2.0m	✓				Floating
B	RJ45 Cable (CBL159-314-01-A)	0.8m					
C	SMA Cable (CBL159-302-03-A)	0.8m	✓				
D	LAN Cable (CBL159-312-01-A)	2.0m	✓				

Justification:

For both conducted and radiated emission below 1GHz, the system was configured for typical fashion as a customer could use it normally.

For radiated emission, measurement of radiated emission from digital circuit is performed with normal transmitting.

1.6 Test Capability

Test Facility

The test facility used for evaluating the conformance of the EUT with each standard in the present report meets what required in CISPR16-1-4, CISPR16-2-3 and ANSI C63.10: 2013.

Test Room	Type of Test Room	Descriptions
TR1	10m semi-anechoic chamber (23m × 14m × 9m)	Complying with the NSA requirements in documents CISPR 22 and ANSI C63.10:2013. For the radiated emission measurement.
TR1	3m fully-anechoic chamber (23m × 14m × 9m)	
TR11	3m semi-anechoic chamber (9m × 6m × 6m)	Complying with the NSA requirements in documents CISPR 22 for the radiated emission measurement.
TR13	Test Site	For the RF conducted emission measurement.
TR5	Shielding Room (8m×5m×4m)	For the conducted emission measurement.
TR4	Shielding Room (5m×3m×3m)	

Test Laboratory Competence Information

Central Research Technology Co. has been accredited / filed / authorized by the agencies listed in the following table.

Certificate	Nation	Agency	Code	Mark
Accreditation Certificate	USA	NVLAP	200575-0	ISO/IEC 17025
	USA	FCC	TW1053	ISO/IEC 17025
	R.O.C. (Taiwan)	TAF	0905	ISO/IEC 17025
	R.O.C. (Taiwan)	BSMI	SL2-IN-E-0033, SL2-IS-E-0033, SL2-R1/R2-E-0033, SL2-A1-E-0033, SL2-L1-E-0033	ISO/IEC 17025
Site Filing Document	Canada	IC	4699A-1,-3	Test facility list & NSA Data
	Japan	VCCI	R-1527,C-1609,T-1441,G-10, C-4400, G-614, T-1334	Test facility list & NSA Data
Authorization Certificate	Germany	TUV	UA 50235497	ISO/IEC 17025
	Norway	Nemko	ELA 212	ISO/IEC 17025

The copy of each certificate can be downloaded from our web site: www.crc-lab.com

1.7 Measurement Uncertainty

The assessed measurement uncertainty with a suitable coverage factor K to ensure 95% confidence level for the normal distribution are shown as below, the values are less than U_{cispr} in table 1 of CISPR 16-4-2.

Test Item	Measurement Uncertainty	
Radiated Emission: (30MHz~200MHz)	Horizontal 4.00dB ; Vertical 4.67dB	
Radiated Emission: (200MHz~1GHz)	Horizontal 4.22dB ; Vertical 5.52dB	
Radiated Emission: (1GHz~6GHz)	Horizontal 4.62dB ; Vertical 4.64dB	
Radiated Emission: (6GHz~18GHz)	Horizontal 4.70dB ; Vertical 4.68dB	
Line Conducted Emission	ESH2-Z5	3.08dB
	ENV 4200	3.11dB

2. Conducted Emission Measurement

Result: Pass

2.1 Limits for Emission Measurement

For intentional device, according to FCC 15.207(a) and RSS-Gen 8.8, line conduction emission limit is as below table.

Frequency of Emission (MHz)	Conducted Limit (dBuV)	
	Quasi-peak	Average
0.15 – 0.5	66 to 56*	56 to 46*
0.5 - 5	56	46
5 - 30	60	50

* Decreases with the logarithm of the frequency.

Note:

For a device with a permanent antenna operating at or below 30 MHz, the FCC will accept measurements done with a suitable dummy load, in lieu of the permanent antenna under the following conditions: (1) perform the AC line conducted tests with the permanent antenna to determine compliance with the Section FCC 15.207 limits outside the transmitter's fundamental emission band; (2) retest with a dummy load in lieu of the permanent antenna to determine compliance with the Section FCC 15.207 limits within the transmitter's fundamental emission band.

2.2 Test Instruments

Test Site and Equipment	Manufacturer	Model No./ Serial No.	Last Calibration Date	Calibration Due Date
Test Receiver	R&S	ESCS30/ 836858/021	Jan. 16, 2016	Jan. 16, 2017
LISN	R&S	ESH2-Z5/ 880669/039	March 25, 2016	March 25, 2017
2 nd LISN	R&S	ENV4200/ 833209/010	April 20, 2016	April 20, 2017
ISN	FCC	<input type="checkbox"/> FCC-TLISN-T2-02/ 20269	August 11, 2015	August 11, 2016
	TESEQ	<input type="checkbox"/> ISN T400A/ 28575	July 30, 2015	July 30, 2016
		<input type="checkbox"/> ISN T800/ 36191	July 30, 2015	July 30, 2016
50Ω terminator	SHHNER	65 BNC-50-0-1/133 NE/005	May 9, 2016	May 9, 2017
RF Switch	R&S	RSU28/ 338965/002	Jan. 29, 2016	July 29, 2016
RF Cable	N/A	N/A/ C0052 ~ 56	Jan. 29, 2016	July 29, 2016
Test Software	Audix	e3/ Ver. 5.2004-2-19k	NCR	NCR
TR5 shielded room	ETS LINDGREN	TR5/ 15353-F	NCR	NCR

Note:

1. The calibrations are traceable to NML/ROC.
2. NCR : No Calibration Required.

Instrument Setting

IF BW	Measurement Time	Detector	Trace	Comment
9kHz	1 second	Quasi-Peak / Average	Maxhold	

Climatic Condition

Ambient Temperature : 25°C; Relative Humidity : 63%

2.3 Test Procedures

- a. The EUT was set up per the test configuration figured in the next section of this chapter to simulate the typical usage per the user's manual.
- b. If the EUT is tabletop equipment, it was placed on a non-conducted table with a height of 0.8 meters above the reference ground plane and 0.4 meters from the conducting wall of the shielded room. Also if the EUT is floor-standing equipment, it was placed on a non-conducted support with a height of 12 millimeters above the reference ground plane.
- c. Connect the EUT's power source to the appropriate power mains through the LISN.
- d. All the other peripherals are connected to the 2nd LISN, if any.
- e. The LISN was placed 0.8 meters from the EUT and at least 0.8 meters from other units and other metal planes.
- f. Measure the conducted emissions on each power line (Neutral Line and Line 1 – Hot side) of the EUT's power source by using the test receiver connected to the coupling RF output port of LISN.
- g. Rapidly scan the signal from 150kHz to 30MHz by using the receiver through the Maximum-Peak detector to determine those frequencies associated with higher emission levels for each measured line.
- h. Then measure the maximum level of conducted disturbance for each frequency found from step g. by using the receiver through the Quasi-Peak and Average detectors per CISPR 16-1.
- i. Record the level for each frequency and compare with the required limit.

2.4 Test Configurations

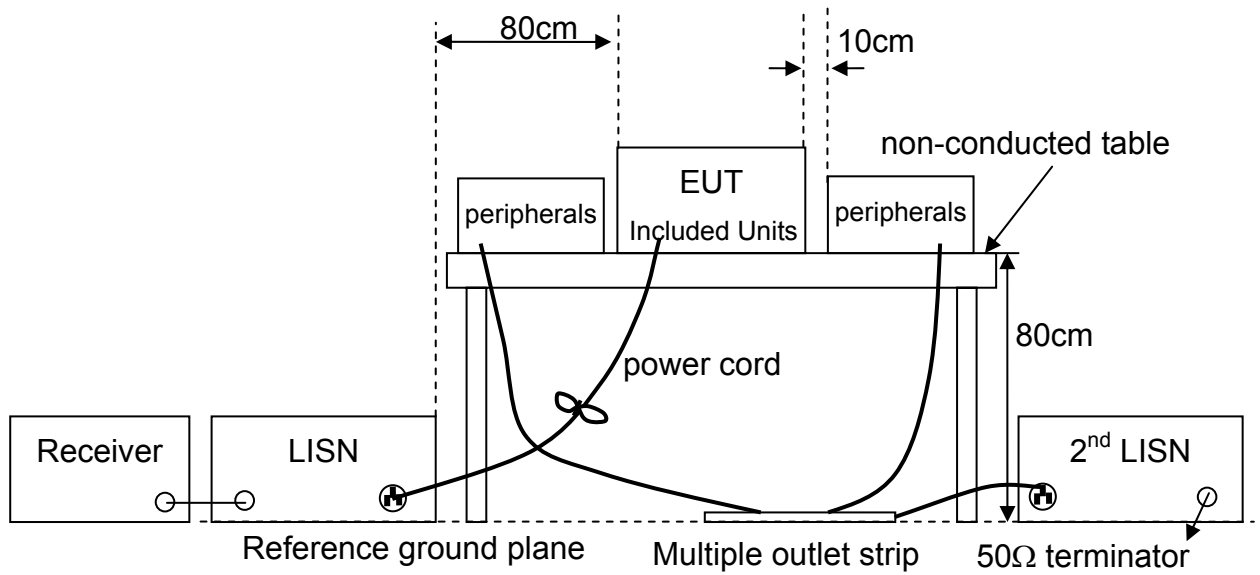

2.5 Test Data

Test Mode : Mode 1, Continuous Transmitting, with antenna
 Tester : Der-Jan Ken Frequency Range : 150kHz~30MHz
 Phase : Line

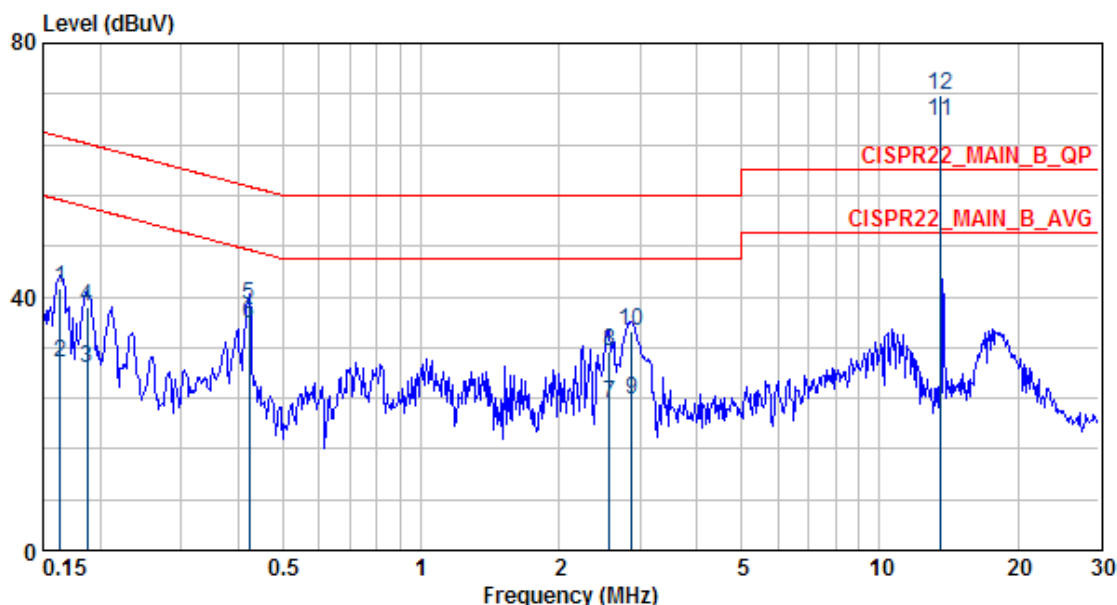

	Freq	Level	Factor	Read Level	Limit Line	Over Limit	Pol/Phase	Remark
	MHz	dBuV	dB	dBuV	dBuV	dB		
1	0.163	41.26	0.24	41.02	65.30	-24.04	LINE	QP
2	0.163	29.59	0.24	29.35	55.30	-25.71	LINE	AVERAGE
3	0.187	28.71	0.23	28.48	54.15	-25.44	LINE	AVERAGE
4	0.187	38.41	0.23	38.18	64.15	-25.74	LINE	QP
5	0.421	38.77	0.25	38.52	57.42	-18.65	LINE	QP
6	0.421	35.82	0.25	35.57	47.42	-11.60	LINE	AVERAGE
7	2.581	23.26	0.58	22.68	46.00	-22.74	LINE	AVERAGE
8	2.581	31.21	0.58	30.63	56.00	-24.79	LINE	QP
9	2.884	23.62	0.61	23.01	46.00	-22.38	LINE	AVERAGE
10	2.884	34.53	0.61	33.92	56.00	-21.47	LINE	QP
11	13.560	67.63	1.03	66.60	50.00	17.63	LINE	AVERAGE
12 X	13.560	71.83	1.03	70.80	60.00	11.83	LINE	QP

Note:

1. Emission Level = reading value + correction factor.
2. Correction factor = cable loss + insertion loss of LISN.
3. Q.P. is abbreviation of quasi-peak.

Test Mode : Mode 1, Continuous Transmitting, with dummy load
 Tester : Der-Jan Ken Frequency Range : 150kHz~30MHz
 Phase : Line

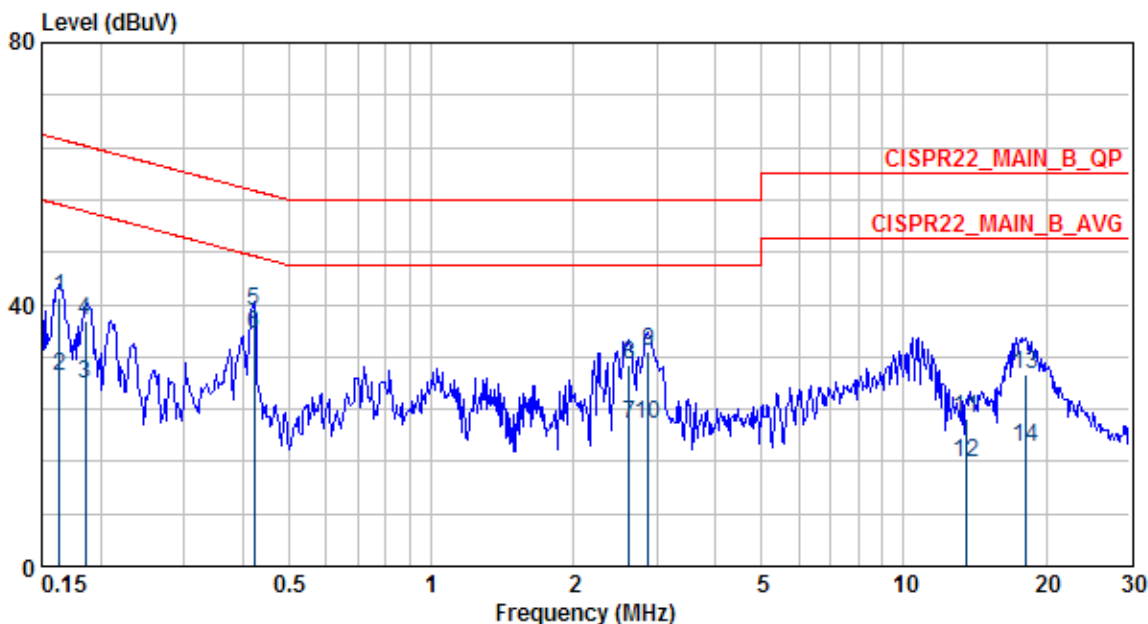

	Freq	Level	Factor	Read Level	Limit Line	Over Limit	Pol/Phase	Remark
	MHz	dBuV	dB	dBuV	dBuV	dB		
1	0.163	41.16	0.24	40.92	65.30	-24.14	LINE	QP
2	0.163	29.05	0.24	28.81	55.30	-26.25	LINE	AVERAGE
3	0.185	27.87	0.23	27.64	54.24	-26.37	LINE	AVERAGE
4	0.185	37.45	0.23	37.22	64.24	-26.79	LINE	QP
5	0.421	38.95	0.25	38.70	57.42	-18.47	LINE	QP
6	0.421	35.59	0.25	35.34	47.42	-11.83	LINE	AVERAGE
7	2.622	21.83	0.59	21.24	46.00	-24.17	LINE	AVERAGE
8	2.622	30.91	0.59	30.32	56.00	-25.09	LINE	QP
9	2.884	32.77	0.61	32.16	56.00	-23.23	LINE	QP
10	2.884	21.63	0.61	21.02	46.00	-24.37	LINE	AVERAGE
11	13.560	22.51	1.03	21.48	60.00	-37.49	LINE	QP
12	13.560	15.76	1.03	14.73	50.00	-34.24	LINE	AVERAGE
13	18.135	29.17	1.17	28.00	60.00	-30.83	LINE	QP
14	18.135	18.31	1.17	17.14	50.00	-31.69	LINE	AVERAGE

Note:

1. Emission Level = reading value + correction factor.
2. Correction factor = cable loss + insertion loss of LISN.
3. Q.P. is abbreviation of quasi-peak.

Test Mode : Mode 1, Continuous Transmitting, with antenna
 Tester : Der-Jan Ken Frequency Range : 150kHz~30MHz
 Phase : Neutral

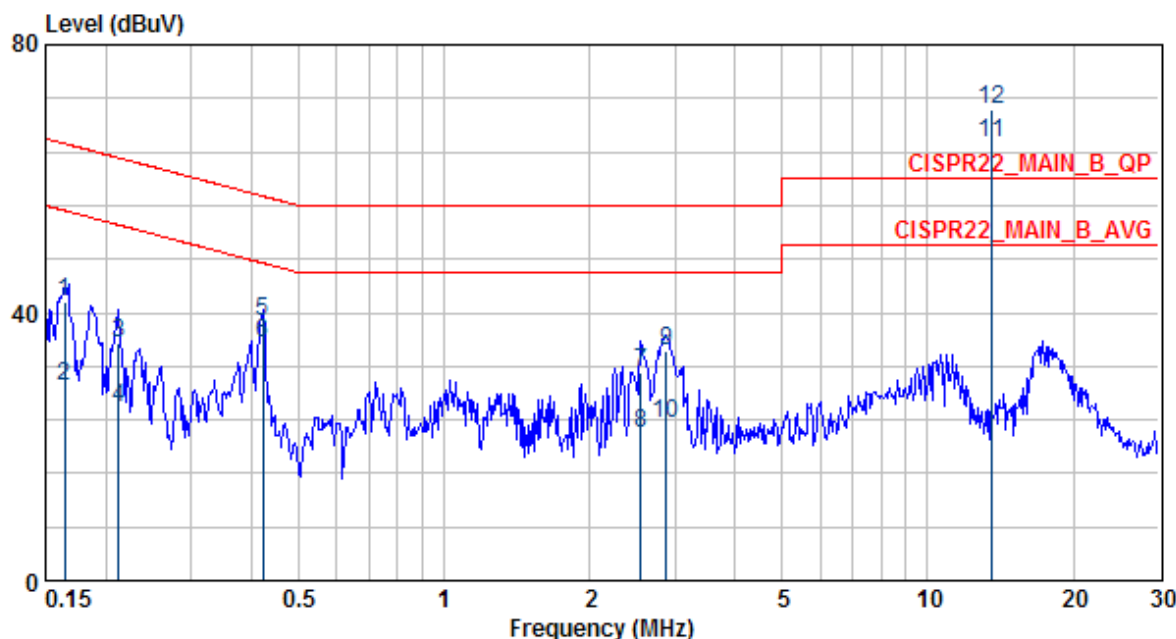

	Freq	Level	Factor	Read Level	Limit Line	Over Limit	Ant Pos	Pol/Phase	Remark
	MHz	dBuV	dB	dBuV	dBuV	dB	cm		
1	0.165	41.52	0.24	41.28	65.23	-23.70	---	NEUTRAL	QP
2	0.165	29.11	0.24	28.87	55.23	-26.11	---	NEUTRAL	AVERAGE
3	0.213	35.36	0.25	35.11	63.10	-27.73	---	NEUTRAL	QP
4	0.213	25.74	0.25	25.49	53.10	-27.35	---	NEUTRAL	AVERAGE
5	0.421	38.66	0.29	38.37	57.42	-18.76	---	NEUTRAL	QP
6	0.421	35.57	0.29	35.28	47.42	-11.85	---	NEUTRAL	AVERAGE
7	2.554	30.98	0.59	30.39	56.00	-25.02	---	NEUTRAL	QP
8	2.554	21.92	0.59	21.33	46.00	-24.08	---	NEUTRAL	AVERAGE
9	2.884	34.39	0.62	33.77	56.00	-21.61	---	NEUTRAL	QP
10	2.884	23.53	0.62	22.91	46.00	-22.47	---	NEUTRAL	AVERAGE
11 X	13.560	65.33	1.06	64.27	50.00	15.33	---	NEUTRAL	AVERAGE
12 X	13.560	70.22	1.06	69.16	60.00	10.22	---	NEUTRAL	QP

Note:

1. Emission Level = reading value + correction factor.
2. Correction factor = cable loss + insertion loss of LISN.
3. Q.P. is abbreviation of quasi-peak.

Test Mode : Mode 1, Continuous Transmitting, with dummy load
 Tester : Der-Jan Ken Frequency Range : 150kHz~30MHz
 Phase : Neutral

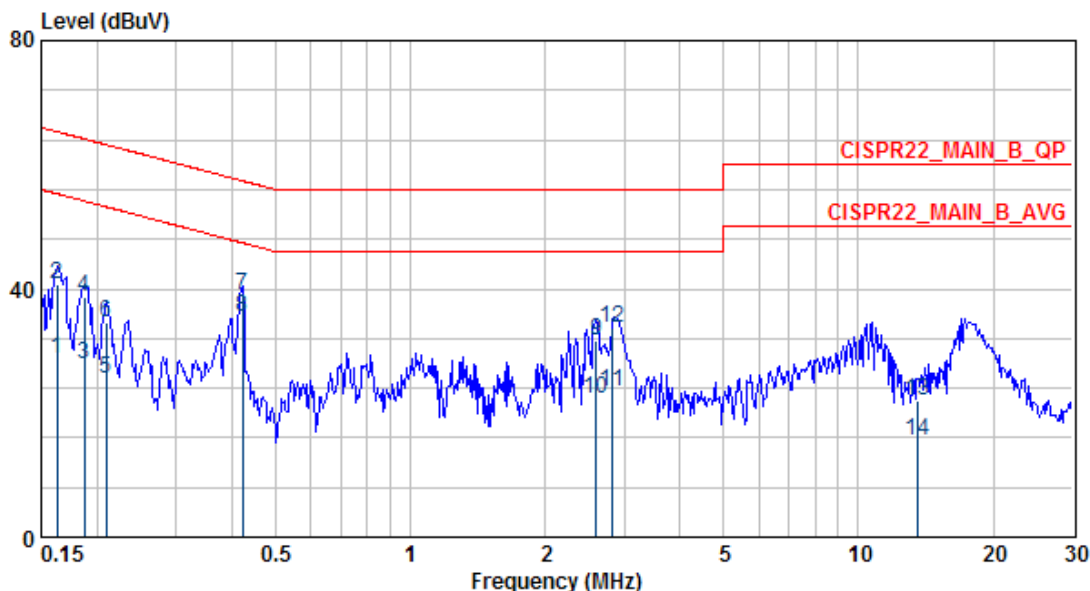

	Freq	Level	Factor	Read Level	Limit Line	Over Limit	Pol/Phase	Remark
	MHz	dBuV	dB	dBuV	dBuV	dB		
1	0.162	28.57	0.24	28.33	55.34	-26.77	NEUTRAL	AVERAGE
2	0.162	40.68	0.24	40.44	65.34	-24.66	NEUTRAL	QP
3	0.187	27.83	0.25	27.58	54.15	-26.32	NEUTRAL	AVERAGE
4	0.187	38.59	0.25	38.34	64.15	-25.56	NEUTRAL	QP
5	0.209	25.61	0.25	25.36	53.23	-27.62	NEUTRAL	AVERAGE
6	0.209	34.71	0.25	34.46	63.23	-28.52	NEUTRAL	QP
7	0.421	38.87	0.29	38.58	57.42	-18.55	NEUTRAL	QP
8	0.421	35.42	0.29	35.13	47.42	-12.00	NEUTRAL	AVERAGE
9	2.600	31.69	0.59	31.10	56.00	-24.31	NEUTRAL	QP
10	2.600	22.20	0.59	21.61	46.00	-23.80	NEUTRAL	AVERAGE
11	2.834	23.57	0.61	22.96	46.00	-22.43	NEUTRAL	AVERAGE
12	2.834	33.56	0.61	32.95	56.00	-22.44	NEUTRAL	QP
13	13.560	22.08	1.06	21.02	60.00	-37.92	NEUTRAL	QP
14	13.560	15.51	1.06	14.45	50.00	-34.49	NEUTRAL	AVERAGE

Note:

1. Emission Level = reading value + correction factor.
2. Correction factor = cable loss + insertion loss of LISN.
3. Q.P. is abbreviation of quasi-peak.

3. Field Strength of fundamental Measurement

Test Result : PASS

3.1 Applied Standard

According to FCC 15.225(a) and RSS-210 A2.6(a), the field strength of any emissions within the band 13.553 – 13.567 MHz shall not exceed 15,848 microvolts/meter at 30 meters.

According to FCC 15.225(b) and RSS-210 A2.6(b), within the bands 13.410-13.553 MHz and 13.567-13.710 MHz, the field strength of any emissions shall not exceed 334 microvolts/meter at 30 meters.

According to FCC 15.225(c) and RSS-210 A2.6(c), within the bands 13.110-13.410 MHz and 13.710-14.010 MHz the field strength of any emissions shall not exceed 106 microvolts/meter at 30 meters.

3.2 Test Instruments

Test Site and Equipment	Manufacturer	Model No./ Serial No.	Last Calibration Date	Calibration Due Date
EMI Test Receiver	R&S	ESCI/ 100019	June 18, 2015	June 18, 2016
Loop Antenna	EMCO	6502/ 20558	Sept. 1, 2015	Sept. 1, 2017
RF Cable	N/A	N/A/ C0080	Feb. 21, 2016	Aug. 21, 2016
Test Software	Audix	e3/ V4.2003-7-14k	NCR	NCR
TR11 Semi – anechoic Chamber	ETS. LINDGREN	TR11/ 906-A	May 1, 2016	May 1, 2017

Note:

1. The calibrations are traceable to NML/ROC.
2. NCR : No Calibration Required.
3. The calibration date of the semi-anechoic chamber listed above is the date of NSA measurement.

Instrument Setting

RBW	VBW	Detector	Trace	Comment
9kHz	N/A	Quasi-Peak	Maxhold	

Climatic Condition

Ambient Temperature : 25°C ; Relative Humidity : 60%

3.3 Measurement Procedure

- a. The EUT was set up per the test configuration figured in the next section of this chapter to simulate the typical usage per the user's manual.
- b. If the EUT is tabletop equipment, it should be placed on a wooden table with a height of 0.8 meters above the reference ground plane in the semi-anechoic chamber. If the EUT is floor-standing equipment, it should be placed on a non-conducted support with a height of 12 millimeters above the reference ground plane in the semi-anechoic chamber.
- c. The EUT is set at 3m away from the receiving antenna.
- d. Rapidly sweep the signal in the test frequency range by using the receiver through the Quasi-Peak detector.
- e. Rotate the EUT from 0° to 360° and position the receiving loop antenna at 1~4 meters above the reference ground plane to determine the fundamental frequency and and bandedge and record them.
- f. Then measure each frequency found from step e. by using the receiver with rotating the EUT and positioning the receiving antenna height to determine the maximum level.
- g. Finely tune the antenna and turntable around the recorded position of each frequency found from step e.
- h. Record and compare the maximum level with the required limit.
- i. Change the receiving antenna to another polarization to measure field strength of fundamental by following step d. to g. again.

3.4 Test Configuration

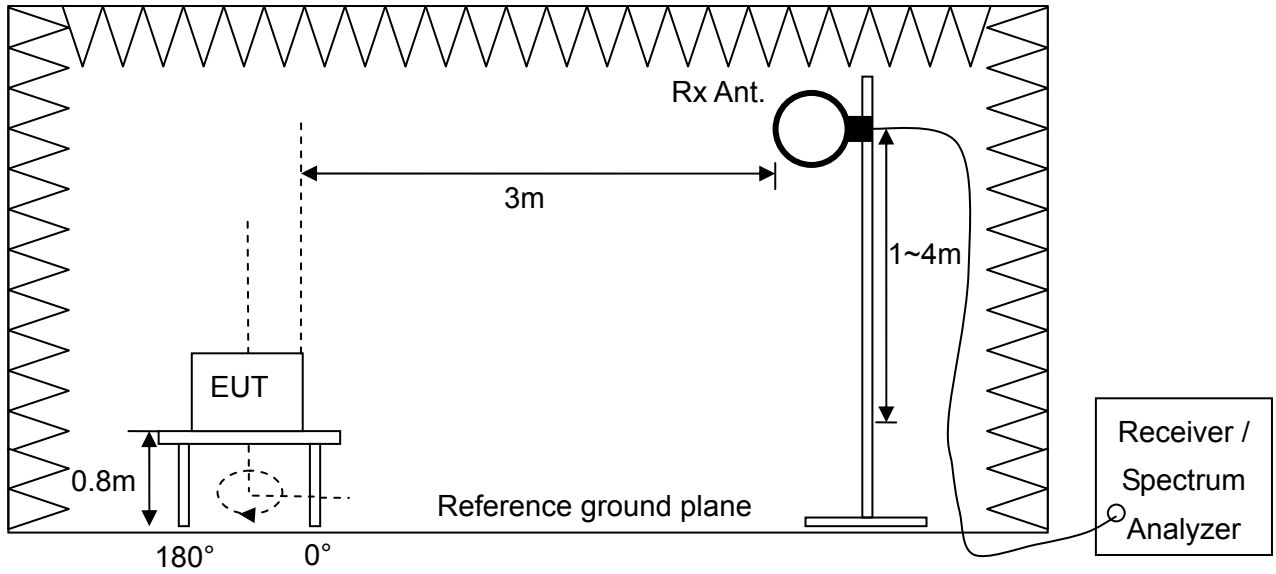

3.5 Test Results

Field strength of fundamental

Test Mode : Mode 1, Continuous Transmitting

Tester : Martin

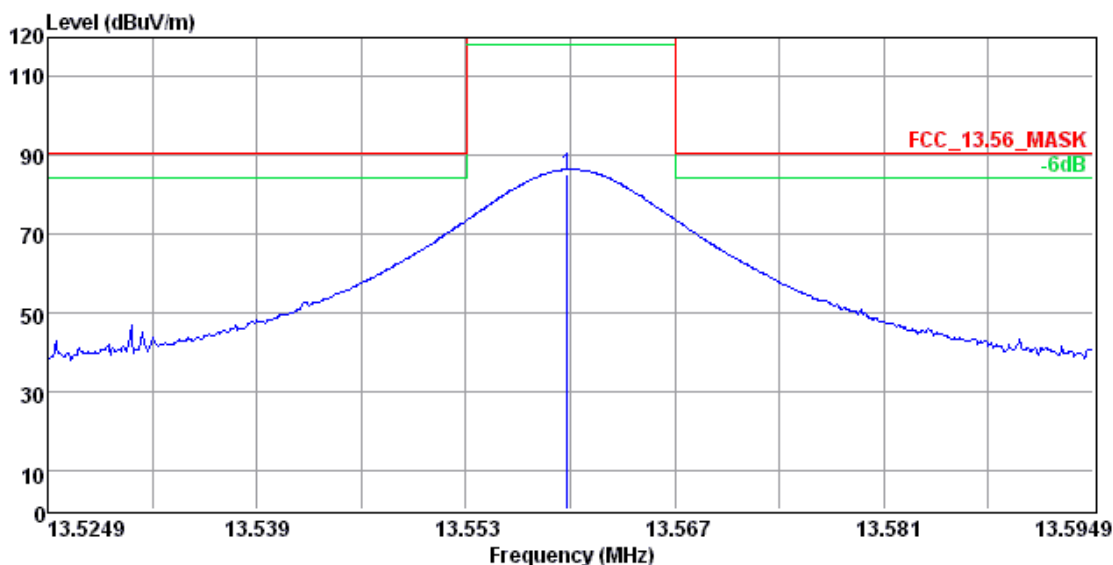

	Read	Limit	Over	A/Pos	T/Pos				
Freq	Level	Level	Factor	Line	Limit	Remark			
MHz	dBuV/m	dBuV	dB/m	dBuV/m	dB	cm deg			
1	13.56	85.23	73.92	11.31	124.00	-38.77	100	188	QP

Note :

1. Correction Factor (dB/m) = Cable Loss + Antenna Factor
2. Emission Level (dBuV/m) = Reading Data + Correction Factor
3. The limit is 15848 (uV/m)=84dBuV/m @ 30 m , for main frequency < 30MHz, the formula transfers the limit at 30 m to 3m is $L_{30}(dBuV/m) + 40 = 124$ dBuV/m
4. Margin (dB) = Limit – Emission Level

Band Edge

Test Mode : Mode 1, Continuous Transmitting

Tester : Martin

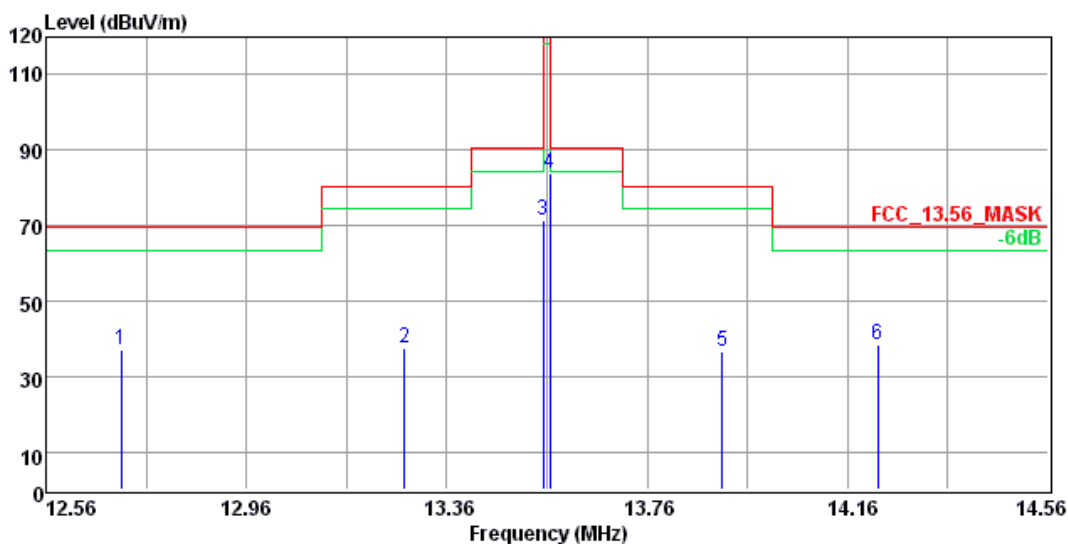

	Freq	Level	Read Level	Factor	Limit Line	Over Limit	A/Pos	T/Pos	Remark
	MHz	dBuV/m	dBuV	dB/m	dBuV/m	dB	cm	deg	
1	12.71	36.88	25.49	11.39	69.54	-32.66	100	0	QP
2	13.28	37.47	26.13	11.34	80.51	-43.04	100	0	QP
3	13.55	71.34	60.03	11.31	90.47	-19.13	100	0	QP
4	13.57	83.67	72.36	11.31	124.00	-40.33	100	0	QP
5	13.91	36.55	25.28	11.27	80.51	-43.96	100	0	QP
6	14.22	38.28	27.03	11.25	69.54	-31.26	100	0	QP

Note :

- Factor (dB/m) = Cable Loss + Antenna Factor
- Level (dBuV/m) = Read Level + Factor
- Over Limit (dB) = Level – Limit Line
- For main frequency < 30MHz, the formula transfers the limit at 30 m to 3m is $L_{30}(\text{dBuV/m}) + 40$

4. Radiated Emission

Test Result : PASS

4.1 Applied Standard

According to FCC 15.225(d), The field strength of any emissions appearing outside of the 13.110-14.010 MHz band shall not exceed the general radiated emission limits in § 15.209. According to RSS-210 A2.6(d), 30 microvolts/m (29.5 dBµV/m) at 30 m, outside the band 13.110-14.010 MHz.

Frequency (MHz)	Field Strength (uV/m)	Measurement Distance (m)
0.009 - 0.490	2400/F(kHz)	300
0.490 - 1.705	24000/F(kHz)	30
1.705 - 30.0	30	30
30 - 88	100 **	3
88 - 216	150 **	3
216 - 960	200 **	3
Above 960	500	3

** Except as provided in paragraph (g), fundamental emissions from intentional radiators operating under this Section shall not be located in the frequency bands 54-72 MHz, 76-88 MHz, 174-216 MHz or 470-806 MHz. However, operation within these frequency bands is permitted under other sections of this Part, e.g., Sections 15.231 and 15.241.

4.2 Test Instruments

Test Site and Equipment	Manufacturer	Model No./ Serial No.	Last Calibration Date	Calibration Due Date
EMI Test Receiver	R&S	ESCI/ 100019	June 18, 2015	June 18, 2016
Spectrum Analyzer	Agilent	E4407B/ MY45106795	June 3, 2015	June 3, 2016
Loop Antenna	EMCO	6502/ 20558	Sept. 1, 2015	Sept. 1, 2017
Bi-Log Antenna	SCHWARZBEC K & Mini-Circuits	VULB 9168 & UNAT-4+/ VULB 9168-612 & 003	July 31, 2015	July 31, 2016
Pre-Amplifier	Mini-circuit	ZKL-1R5+/ 004	Feb. 21, 2016	Aug. 21, 2016
RF Cable	N/A	N/A/ C0080	Feb. 21, 2016	Aug. 21, 2016
Test Software	Audix	e3/ V4.2003-7-14k	NCR	NCR
TR11 Semi - anechoic Chamber	ETS. LINDGREN	TR11/ 906-A	May 1, 2016	May 1, 2016

Note:

1. The calibrations are traceable to NML/ROC.
2. NCR:No Calibration Required.
3. The calibration date of the semi-anechoic chamber listed above is the date of NSA measurement.

Instrument Setting

RBW	VBW	Detector	Trace	Comment
9kHz	N/A	Quasi-Peak	Maxhold	Below 30MHz
120kHz	N/A	Quasi-Peak	Maxhold	Below 1GHz

Climatic Condition

Ambient Temperature : 25°C ; Relative Humidity : 60%

4.3 Measurement Procedure

- a. The EUT was set up per the test configuration figured in the next section of this chapter to simulate the typical usage per the user's manual.
- b. A software provided by client enabled the EUT to transmit and receive data at specified channel frequencies individually.
- c. If the EUT is tabletop equipment, it was placed on a non-conducted table with a height of 0.8 meters above the reference ground plane in the semi-anechoic chamber. If the EUT is floor-standing equipment, it was placed on a non-conducted support with a height of 12 millimeters above the reference ground plane in the semi-anechoic chamber.
- d. The EUT is set at 3m away from the interference receiving antenna.
- e. Rapidly sweep the signal in the test frequency range by using the spectrum through the Maximum-peak detector.
- f. Rotate the EUT from 0° to 360° and position the receiving antenna at heights from 1 to 4 meters above the reference ground plane continuously to determine at least six frequencies associated with higher emission levels and record them.
- g. For measurement of frequency above 1000MHz, the beamwidth of receiving horn antenna should keep covering EUT when the receiving horn antenna height varied.
- h. Then measure each frequency found from step e. by using the spectrum with rotating the EUT and positioning the receiving antenna height to determine the maximum level.
- i. Finely tune the antenna and turntable around the recorded position of each frequency found from step g.
- j. For measurement of frequency below 1000MHz, set the receiver detector to be Quasi-Peak per CISPR 16-1 to find out the maximum level occurred.
- k. For measurement of frequency above 1000MHz, set the spectrum detector to be Peak or Average to find out the maximum level occurred, if any.
- l. Record frequency, azimuth angle of the turntable, height, and polarization of the receiving antenna and compare the maximum level with the required limit.
- m. Change the receiving antenna to another polarization to measure radiated emission by following step e. to l. again.
- n. If the peak emission level measured from step e. is 4dB lower than the limit specified, then the emission values presented will be the peak value only. Otherwise, accurate **Q.P. value will be measured and presented.**

4.4 Test Configuration

Radiated Emission Measurement below 30MHz

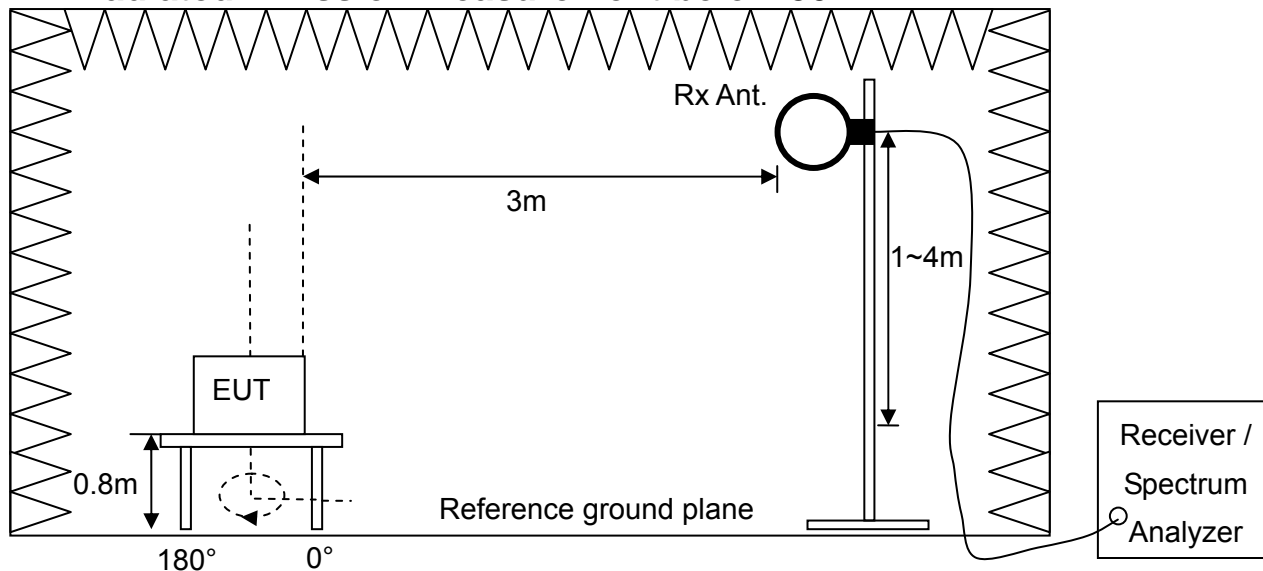

Radiated Emission Measurement above 30MHz

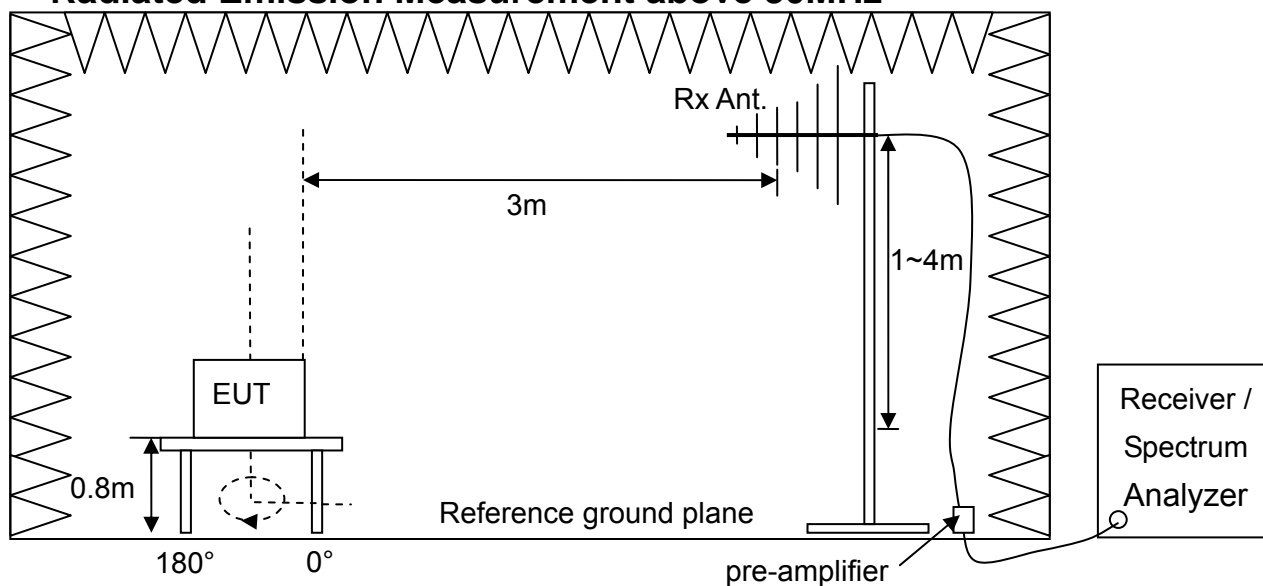

4.5 Test Results

Test Mode : Mode 1, Continuous Transmitting
Tester : Martin **Frequency Range** : 9kHz~1GHz
Polarization : Horizontal

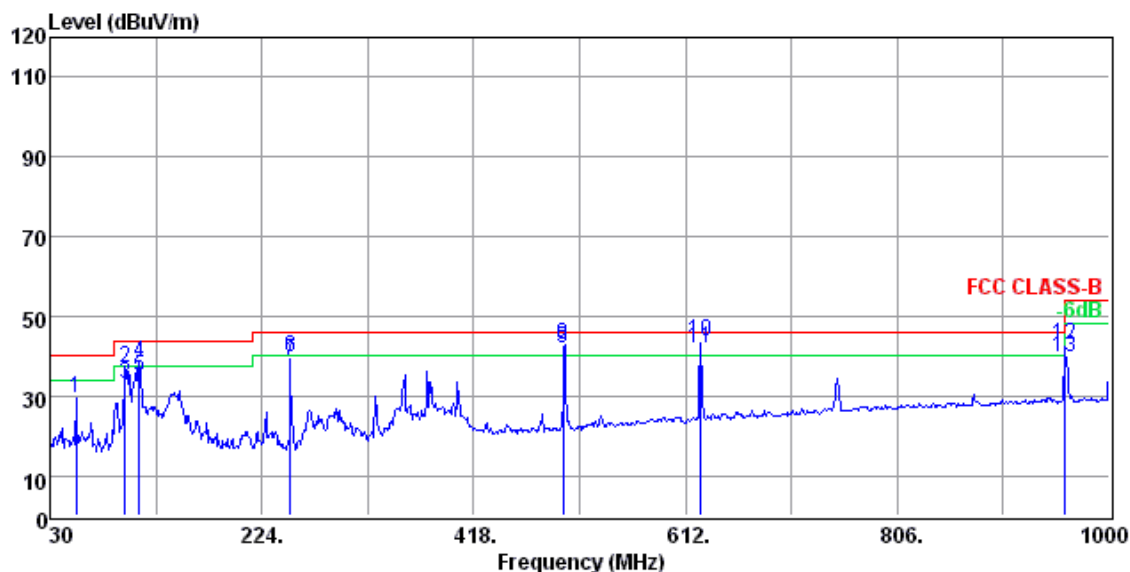

	Freq	Level	Read Level	Factor	Limit Line	Over Limit	A/Pos	T/Pos	Pol/Phase	Remark
	MHz	dBuV/m	dBuV	dB/m	dBuV/m	dB	cm	deg		
1	54.30	29.48	51.17	-21.69	40.00	-10.52	---	---	HORIZONTAL	Peak
2	98.49	36.94	62.98	-26.04	43.50	-6.56	292	34	HORIZONTAL	Peak
3	98.49	32.95	58.99	-26.04	43.50	-10.55	292	34	HORIZONTAL	QP
4 !	111.61	38.18	62.04	-23.86	43.50	-5.32	292	34	HORIZONTAL	Peak
5	111.61	34.91	58.77	-23.86	43.50	-8.59	292	34	HORIZONTAL	QP
6	250.02	39.73	61.41	-21.68	46.00	-6.27	136	170	HORIZONTAL	Peak
7	250.02	38.73	60.41	-21.68	46.00	-7.27	136	170	HORIZONTAL	QP
8 !	500.04	42.92	58.25	-15.33	46.00	-3.08	113	293	HORIZONTAL	Peak
9 !	500.04	41.75	57.08	-15.33	46.00	-4.25	113	293	HORIZONTAL	QP
10 !	625.04	43.67	56.51	-12.84	46.00	-2.33	137	316	HORIZONTAL	Peak
11 !	625.04	41.86	54.70	-12.84	46.00	-4.14	137	316	HORIZONTAL	QP
12 !	959.99	42.78	51.32	-8.54	46.00	-3.22	100	234	HORIZONTAL	Peak
13	959.99	39.82	48.36	-8.54	46.00	-6.18	100	234	HORIZONTAL	QP

Note :

1. Correction Factor (dB/m) = Cable Loss + Antenna Factor – Gain of Preamplifier
2. Emission Level (dBuV/m) = Reading Data + Correction Factor

No signal can be detected from 9kHz to 30MHz, so the graphs are omitted below 30MHz.

Test Mode : Mode 1, Continuous Transmitting
 Tester : Martin Frequency Range : 9kHz~1GHz
 Polarization : Vertical

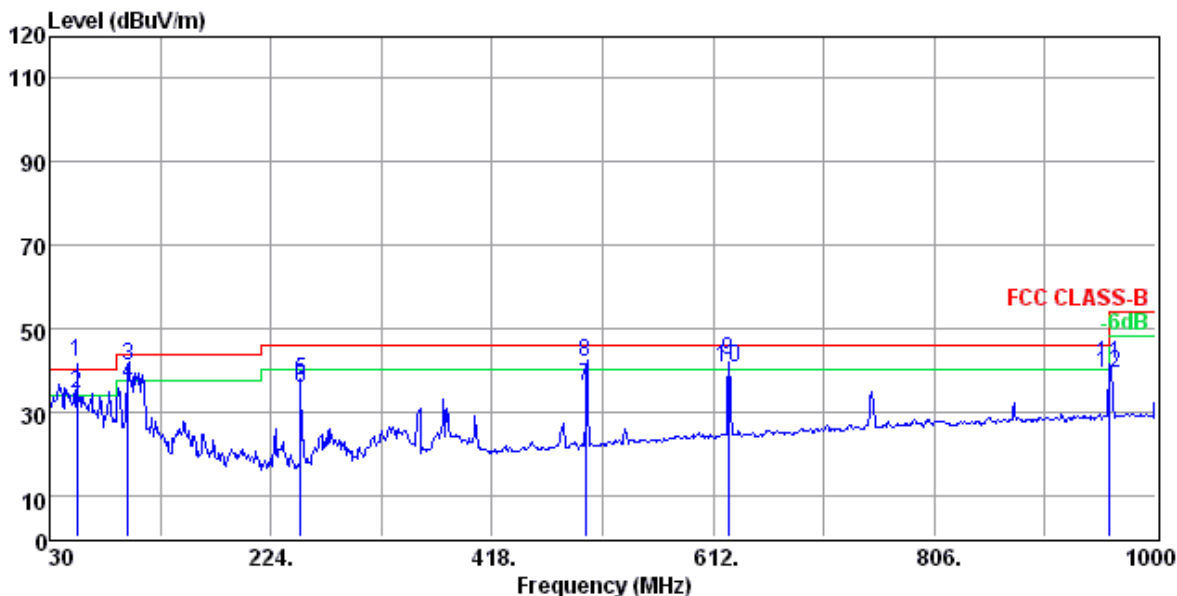

	Freq	Level	Read Level	Factor	Limit Line	Over Limit	A/Pos	T/Pos	PoI/Phase	Remark
	MHz	dBuV/m	dBuV	dB/m	dBuV/m	dB	cm	deg		
1 *	54.24	41.76	63.45	-21.69	40.00	1.76	100	198	VERTICAL	Peak
2 !	54.24	34.50	56.19	-21.69	40.00	-5.50	100	198	VERTICAL	QP
3 !	98.48	40.84	66.88	-26.04	43.50	-2.66	100	4	VERTICAL	Peak
4	98.48	36.36	62.40	-26.04	43.50	-7.14	100	4	VERTICAL	QP
5	250.03	37.34	59.02	-21.68	46.00	-8.66	101	150	VERTICAL	Peak
6	250.03	35.56	57.24	-21.68	46.00	-10.44	101	150	VERTICAL	QP
7	500.04	36.19	51.52	-15.33	46.00	-9.81	118	248	VERTICAL	Peak
8 !	500.04	41.90	57.23	-15.33	46.00	-4.10	118	248	VERTICAL	QP
9 !	625.05	42.51	55.35	-12.84	46.00	-3.49	100	213	VERTICAL	Peak
10 !	625.05	40.55	53.39	-12.84	46.00	-5.45	100	213	VERTICAL	QP
11 !	959.97	41.57	50.11	-8.54	46.00	-4.43	103	182	VERTICAL	Peak
12	959.97	39.22	47.76	-8.54	46.00	-6.78	103	182	VERTICAL	QP

Note :

1. Correction Factor (dB/m) = Cable Loss + Antenna Factor – Gain of Pre-amplifier
2. Emission Level (dBuV/m) = Reading Data + Correction Factor

No signal can be detected from 9kHz to 30MHz, so the graphs are omitted below 30MHz.

5. Frequency Tolerance

Test Result : PASS

5.1 Applied Standard

According to FCC 15.225(e) and RSS-210 A2.6, the frequency tolerance of the carrier signal shall be maintained within +/- 0.01% of the operating frequency over a temperature variation of -20 degrees to +50 degrees C at normal supply voltage, and for a variation in the primary supply voltage from 85% to 115% of the rated supply voltage at a temperature of 20 degrees C. For battery operated equipment, the equipment tests shall be performed using a new battery.

5.2 Test Instruments

Test Site and Equipment	Manufacturer	Model No./ Serial No.	Last Calibration Date	Calibration Due Date
Spectrum Analyzer	Agilent	E4405B/ MY45106706	April 27, 2016	April 27, 2017
Temperature Chamber	Terchy	MHG-800LF/ 920224	Aug. 13, 2015	Aug. 13, 2016
Adjustable DC Power Supply	instek	PSP-405/ C120177	NCR	NCR
Voltage Meter	FLUKE	187/ 91050091	July 4, 2014	July 4, 2016
Test Site	N.A.	TR13	NCR	NCR

Note:

1. The calibrations are traceable to NML/ROC.
2. NCR:No Calibration Required.

Instrument Setting

RBW	VBW	Detector	Trace	Comment
300Hz	1kHz	Peak	Maxhold	

Climatic Condition

Ambient Temperature : 24°C; Relative Humidity : 65%

5.3 Measurement Procedure

- a. The EUT was set up per the test configuration figured in the next section of this chapter to simulate the typical usage described in the user’s manual supported by the manufacturer in test site TR13.
- b. Measure the frequency tolerance by using the spectrum analyzer and following the test conditions described in FCC 15.225(e) to perform the normal and extreme conditions test.
- c. Record the value and compare with the required limit.

5.4 Test Configuration

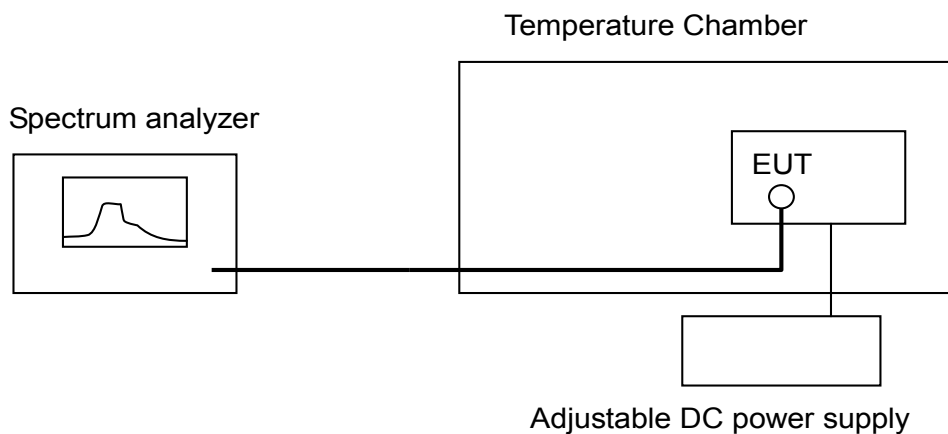

5.5 Test Results

Test Mode : Mode 1, Continuous Transmitting

Tester : Bill

Temperature (°C)	DC Voltage (Volt)	Meas. Frequency (MHz)	Deviation (kHz)	Limit (kHz)	Margin (kHz)
20°C	12	13.55991	N/A	N/A	N/A
	10.2	13.55991	0	1.356	1.356
	13.8	13.55991	0	1.356	1.356
-20°C	12	13.56002	0.11	1.356	1.246
50°C	12	13.55983	0.08	1.356	1.276

Note:

1. Deviation(kHz) = | Meas. Frequency – Meas. Frequency @20°C/12Vdc |
2. Margin (kHz)= Limit – Deviation
3. At the temperature control to highest and Lowest measurement, device turn on after temperature stability and measure at startup and at 2 mins, 5 mins, and 10 mins. Finally, record the worst on the report.
4. The test results of 24Vdc is pass. The test data doesn't be recorded.

20°C, 12Vdc

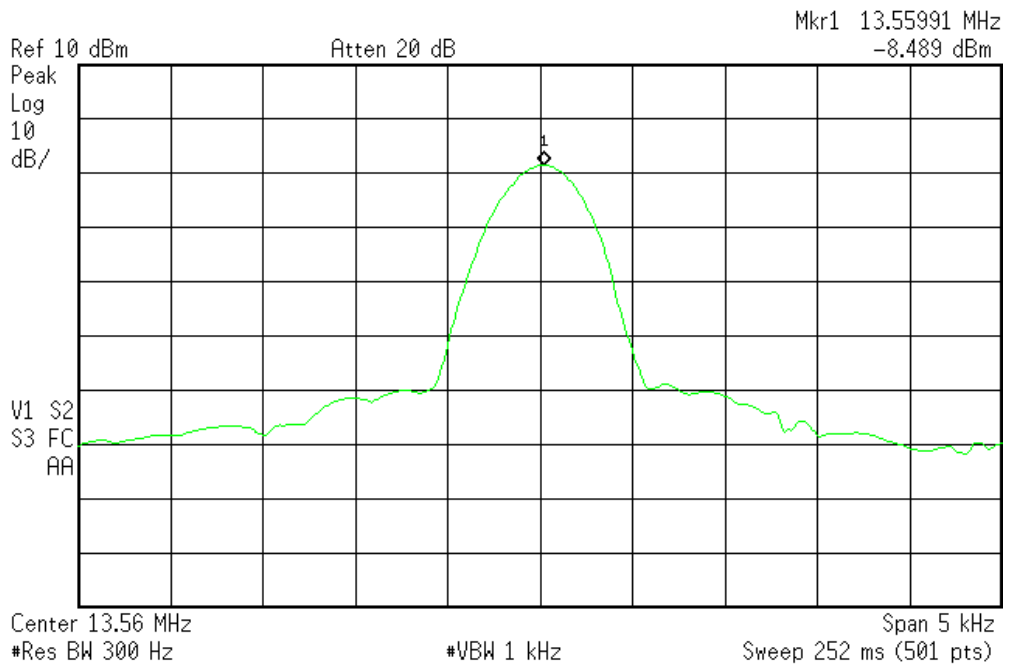

20°C, 10.2Vdc

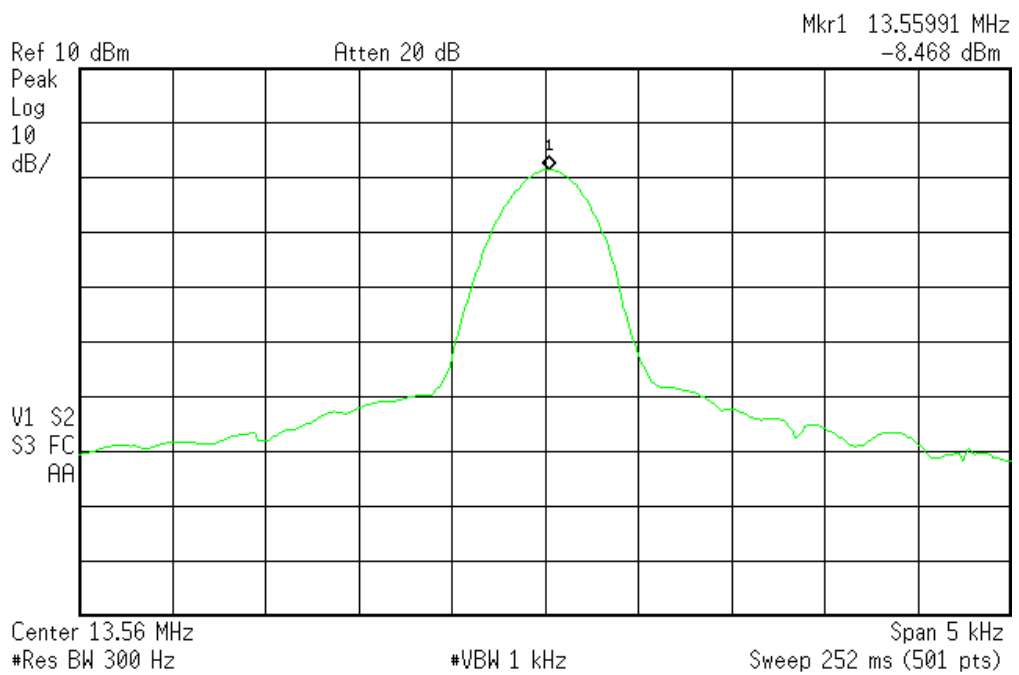

20°C, 13.8Vdc

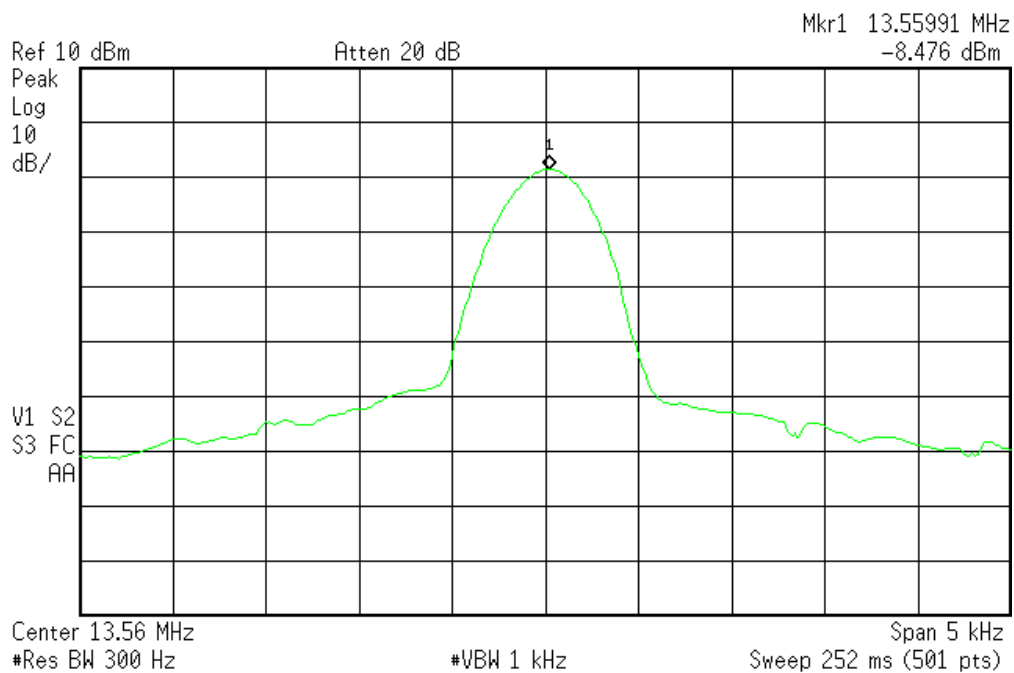

-20°C, 12Vdc

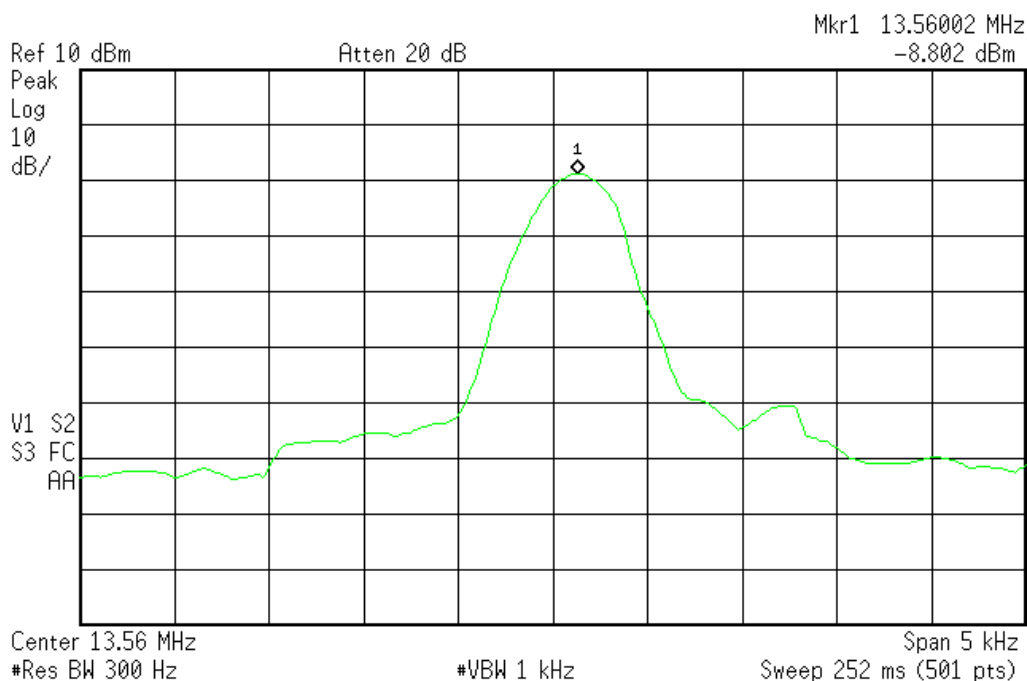

50°C, 12Vdc

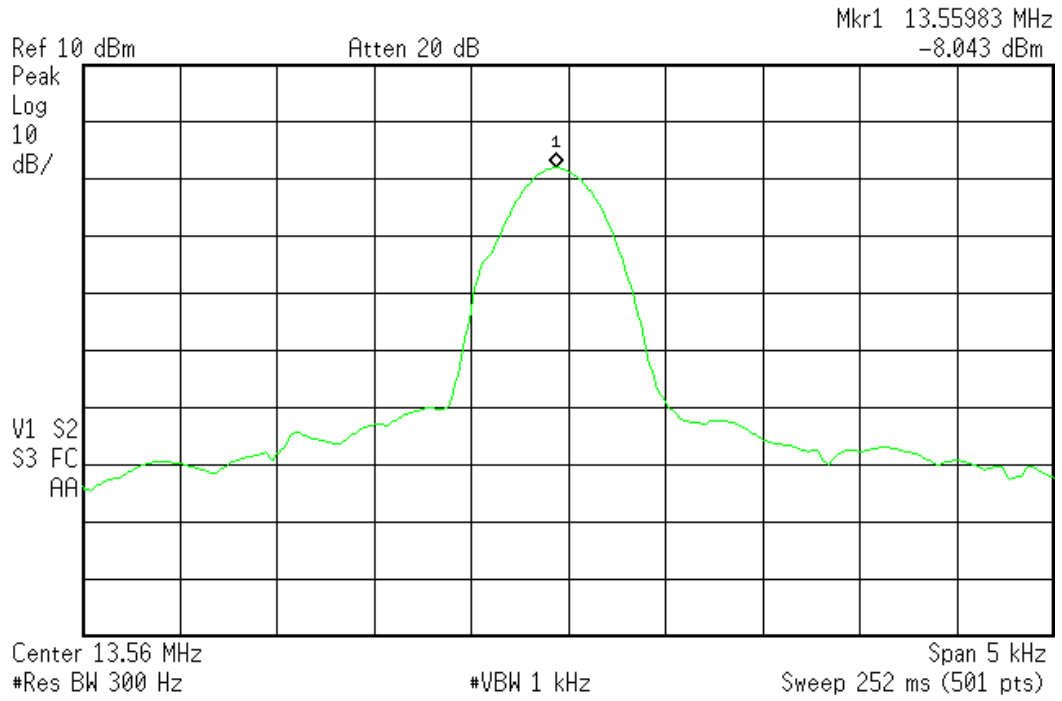

6. 20dB Bandwidth

Test Result : PASS

6.1 Applied Standard

According to FCC 15.215(c) requires the device must be designed to ensure that the 20 dB bandwidth of the emission, or whatever bandwidth may otherwise be specified in the specific rule section under which the equipment operates.

According to FCC 15.225, Operation should within the band 13.110 – 14.010 MHz.

6.2 Test Instruments

Test Site and Equipment	Manufacturer	Model No./ Serial No.	Last Calibration Date	Calibration Due Date
Spectrum Analyzer	Agilent	E4405B/ MY45106706	April 27, 2016	April 27, 2017
Test Site	N.A.	TR13	NCR	NCR

Note:

- 1.The calibrations are traceable to NML/ROC.
- 2.NCR : No Calibration Required.

Instrument Setting

RBW	VBW	Detector	Trace	Comment
300Hz	1kHz	Peak	Maxhold	

Climatic Condition

Ambient Temperature : 24°C; Relative Humidity : 65%

6.3 Measurement Procedure

- a. The EUT was set up per the test configuration figured in the next section of this chapter to simulate the typical usage described in the user’s manual supported by the manufacturer in test site TR13.
- b. Measure the 20dB bandwidth by using the spectrum analyzer and following the test conditions described in FCC 15.215.
- c. Record the frequency and compare with the required limit.

6.4 Test Configuration



6.5 Test Results

Test Mode : Mode 1, Continuous Transmitting

Tester : Bill

Operating Frequency (MHz)	Measured Value (MHz)	Limit (MHz)
13.56	13.5595~13.56028	13.110~14.01

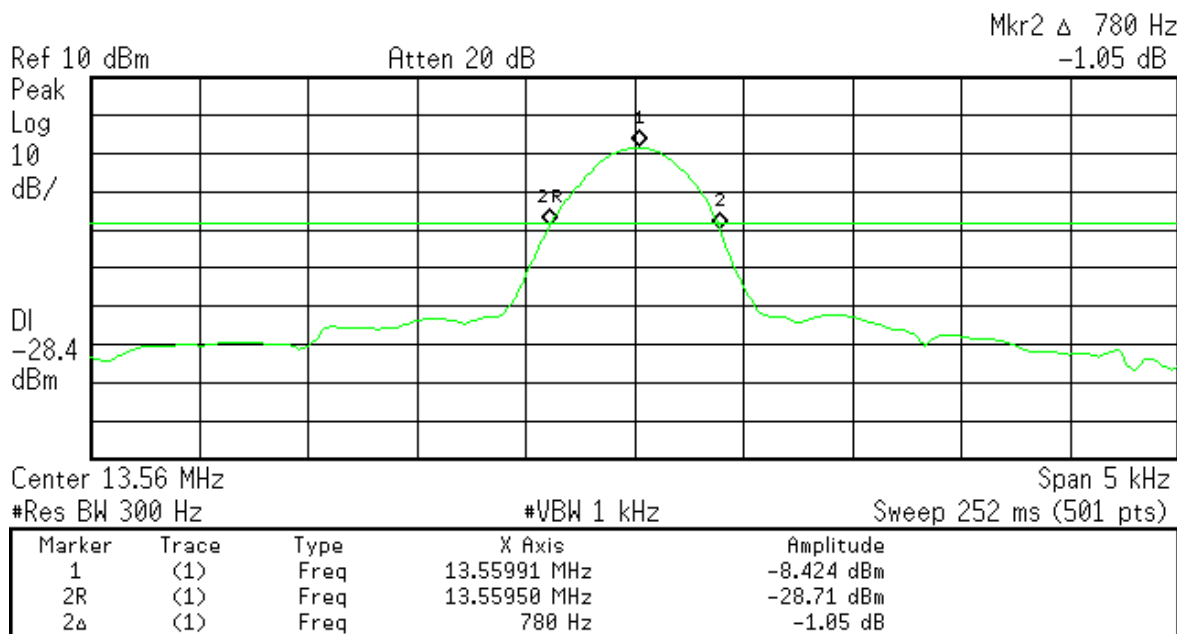

7. Occupied Bandwidth

Result: Pass

7.1 Applied Standard

According to RSS-Gen 6.6, when an occupied bandwidth value is not specified in the applicable RSS, the transmitted signal bandwidth to be reported is to be its 99% emission bandwidth, as calculated or measured.

7.2 Test Instruments

Test Site and Equipment	Manufacturer	Model No./ Serial No.	Last Calibration Date	Calibration Due Date
Spectrum Analyzer	Agilent	E4405B/ MY45106706	April 27, 2016	April 27, 2017
Test Site	N.A.	TR13	NCR	NCR

Note:

1. The calibrations are traceable to NML/ROC.
2. NCR:No Calibration Required.

Instrument Setting

RBW	VBW	Detector	Trace	Comment
10Hz	30Hz	Sample	Maxhold	

Climatic Condition

Ambient Temperature : 24°C; Relative Humidity : 65%

7.3 Measurement Procedure

- a. The EUT was set up per the test configuration figured in the next section of this chapter and to simulate the typical usage described in the user’s manual supported by the manufacturer in chamber TR13.
- b. Measure the 99% bandidth by using the spectrum analyzer and following the test conditions described in RSS-Gen.
- c. Record the frequency and compare with the required limit.

7.4 Test Configuration



7.5 Test Data

Test Mode : Mode 1, Continuous Transmitting
Tester :Martin

Operating Frequency (MHz)	Measured Value (Hz)	Limit (kHz)
13.56	198.46	—

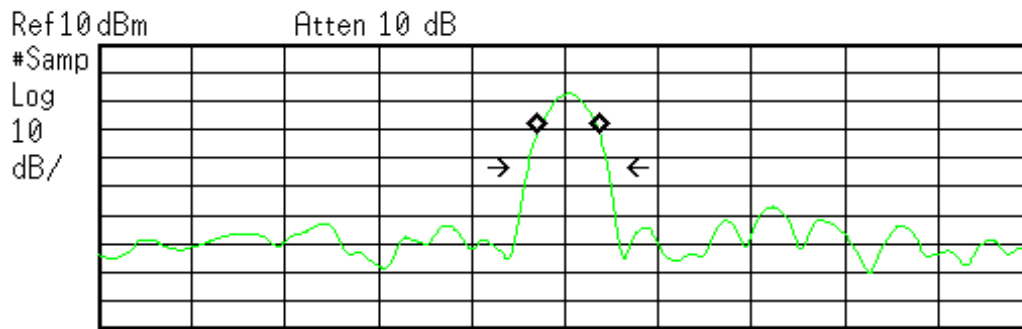

Center 13.56 MHz Span 3 kHz
 #Res BW 10 Hz #VBW 30 Hz Sweep 220 ms (501 pts)

Occupied Bandwidth	Occ BW % Pwr	99.00 %
198.4637 Hz	x dB	-26.00 dB
Transmit Freq Error		10.071 Hz
x dB Bandwidth		261.555 Hz*

8. Antenna Requirement

8.1 Applied Standard

According to FCC 15.203, an intentional radiator shall be designed to ensure that no antenna other than that furnished by the responsible party shall be used with the device. The use of a permanently attached antenna or of an antenna that uses a unique coupling to the intentional radiator shall be considered sufficient to comply with the provisions of this Section. The manufacturer may design the unit so that a broken antenna can be replaced by the user, but the use of a standard antenna jack or electrical connector is prohibited. This requirement does not apply to carrier current devices or to devices operated under the provisions of Sections 15.211, 15.213, 15.217, 15.219, or 15.221. Further, this requirement does not apply to intentional radiators that must be professionally installed, such as perimeter protection systems and some field disturbance sensors, or to other intentional radiators which, in accordance with Section 15.31(d), must be measured at the installation site. However, the installer shall be responsible for ensuring that the proper antenna is employed so that the limits in this Part are not exceeded.

8.2 Antenna Type

The EUT use a permanently attached antenna

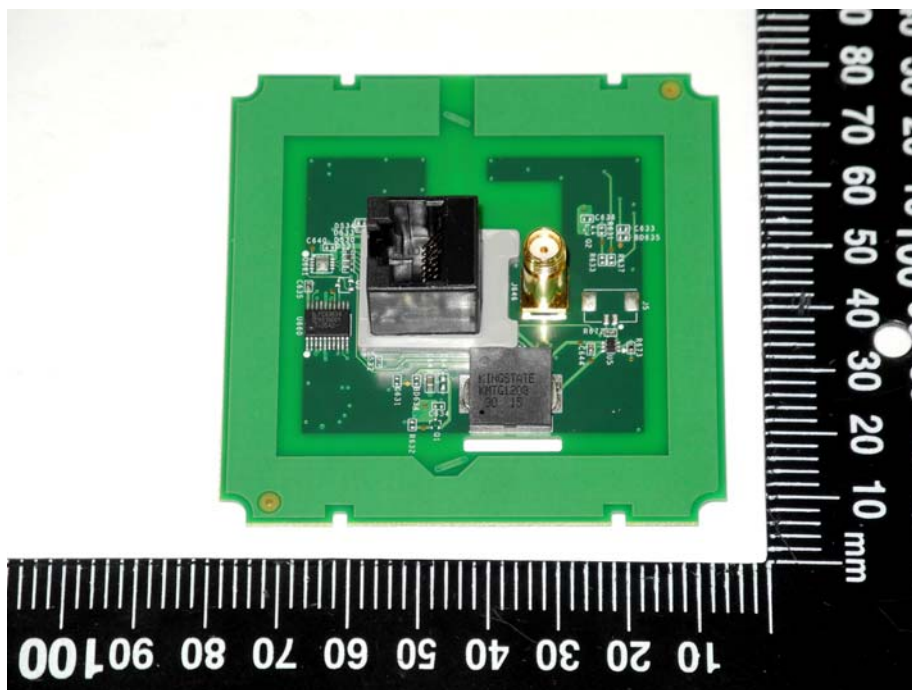

8.3 Applicable Result

Comply the requirement.