

# **FCC Test Report**

for

## **POS terminal**

**Trade Name : Verifone**  
**Model Number : UX300**  
**Antenna Model No. : UX400**  
**FCC ID : B32UX300400**  
**Report Number : RF-V040-1501-259**  
**Date of Receipt : February 26, 2015**  
**Date of Report : March 4, 2015**

Prepared for

### **Verifone Inc.**

1400 West Stanford Ranch Road, Suite 200, Rocklin, CA, 95765, UNITED STATES

Prepared by



**Central Research Technology Co.**

**EMC Test Laboratory**

11, Lane 41, Fushuen St., Jungshan Chiu, Taipei, Taiwan, 104, R.O.C.



NVLAP LAB CODE 200575-0

**This report shall not be reproduced, except in full, without the written approval of Central Research Technology Co.. It may be duplicated completely in its entirety for legal use with the permission of the applicant. It should not be used to claim product endorsement by NVLAP, NIST or any U.S. government agency. The test result in the report applies only to the sample tested.**

# Verification

**Equipment Under Test** : POS terminal  
**Model No.** : UX300  
**Antenna Model No.** : UX400  
**FCC ID** : B32UX300400  
**Applicant** : Verifone Inc.  
**Address** : 1400 West Stanford Ranch Road, Suite 200, Rocklin, CA,  
95765, UNITED STATES  
**Applicable Standards** : **FCC Part 15, Subpart C**  
**Date of Testing** : February 26, 2015 ~ March 2, 2015  
**Deviation** : N/A  
**Condition of Test Sample** : Mass Production

We, **Central Research Technology Co.**, hereby certify that one sample of the designated product was tested in our facility during the period mentioned above. The test records, data evaluation and Equipment Under Test (EUT) configurations shown in the present report are true and accurate representation of the measurements of the sample's RF characteristics under the conditions herein specified.

The test results show that the EUT as described in the present report is in compliance with the requirements set forth in the standards mentioned above and apply to the tested sample identified in the present report only. The test report shall not be reproduced, except in its entirety, without the written approval of Central Research Technology Co.

**PREPARED BY** : Cathy Chen , **DATE** : Mar. 4, 2015  
(Cathy Chen/Technical Manager)

**APPROVED BY** : Tsun-Yu Shih , **DATE** : Mar. 4, 2015  
(Tsun-Yu Shih/General Manager)

## Contents

<b>1.</b>	<b>General Description .....</b>	<b>5</b>
1.1	GENERAL DESCRIPTION OF EUT .....	5
1.2	TEST METHODOLOGY .....	6
1.3	TEST MODE .....	6
1.4	APPLIED STANDARDS .....	7
1.5	THE SUPPORT UNITS .....	10
1.6	LAYOUT OF SETUP .....	11
1.7	TEST CAPABILITY .....	12
1.8	MEASUREMENT UNCERTAINTY .....	14
<b>2.</b>	<b>Conducted Emission Measurement .....</b>	<b>15</b>
2.1	LIMITS FOR EMISSION MEASUREMENT .....	15
2.2	TEST INSTRUMENTS .....	16
2.3	TEST PROCEDURES .....	17
2.4	TEST CONFIGURATIONS .....	18
2.5	TEST DATA .....	19
<b>3.</b>	<b>Field Strength of fundamental Measurement.....</b>	<b>23</b>
3.1	APPLIED STANDARD .....	23
3.2	TEST INSTRUMENTS .....	24
3.3	MEASUREMENT PROCEDURE .....	25
3.4	TEST CONFIGURATION .....	26
3.5	TEST RESULTS .....	27
<b>4.</b>	<b>Radiated Emission .....</b>	<b>31</b>
4.1	APPLIED STANDARD .....	31
4.2	TEST INSTRUMENTS .....	32
4.3	MEASUREMENT PROCEDURE .....	33
4.4	TEST CONFIGURATION .....	34
4.5	TEST RESULTS .....	35
<b>5.</b>	<b>Frequency Tolarence .....</b>	<b>37</b>
5.1	APPLIED STANDARD .....	37
5.2	TEST INSTRUMENTS .....	38
5.3	MEASUREMENT PROCEDURE .....	39
5.4	TEST CONFIGURATION .....	39
5.5	TEST RESULTS .....	40
<b>6.</b>	<b>20dB Bandwidth .....</b>	<b>44</b>

<b>6.1</b>	<b>APPLIED STANDARD .....</b>	<b>44</b>
<b>6.2</b>	<b>TEST INSTRUMENTS .....</b>	<b>44</b>
<b>6.3</b>	<b>MEASUREMENT PROCEDURE .....</b>	<b>45</b>
<b>6.4</b>	<b>TEST CONFIGURATION .....</b>	<b>45</b>
<b>6.5</b>	<b>TEST RESULTS .....</b>	<b>46</b>
<b>7.</b>	<b>Antenna Requirement .....</b>	<b>47</b>
<b>7.1</b>	<b>APPLIED STANDARD .....</b>	<b>47</b>
<b>7.2</b>	<b>ANTENNA TYPE .....</b>	<b>47</b>
<b>7.3</b>	<b>APPLICABLE RESULT .....</b>	<b>47</b>

**Attachment 1 – Photographs of the Test Configurations**

**Attachment 2 – External Photographs of EUT**

**Attachment 3 – Internal Photographs of EUT**

## 1. General Description

### 1.1 General Description of EUT

Equipment Under Test	:	POS terminal
Model No.	:	UX300
Antenna Model No:	:	UX400
Power in	:	9Vdc~43Vdc supplied by the power supply or adaptor
Test Voltage	:	120Vac/60Hz to the power adaptor/ DC power source
Frequency Range	:	13.56MHz
Channel Numbers	:	1
Function Modulation	:	ASK
Function Description	:	

The EUT is used to transmit and receive signal both. Please refer to the user's manual for the details.

Since the EUT shall be installed horizontally or vertically on the table, it was pre-tested on the two axis. Therefore only the test data of the worse case- vertical was used for Radiated test.

## **1.2 Test Methodology**

For this E.U.T., the radiated emissions and conducted emission measurement performed according to the procedures illustrated in ANSI C63.4:2009 and other required are illustrated in separate sections of this test report for detail.

## **1.3 Test Mode**

Normal Mode.

## 1.4 Applied standards

(1) Field strength of Fundametal

According to 15.225(a), the field strength of any emissions within the band 13.553 - 13.567 MHz shall not exceed 15,848 microvolts/meter at 30 meters.

(2) Band Edge

According to 15.225(b), Within the bands 13.410-13.553 MHz and 13.567-13.710 MHz, the field strength of any emissions shall not exceed 334 microvolts/meter at 30 meters. According to 15.225(c), Within the bands 13.110-13.410 MHz and 13.710-14.010 MHz the field strength of any emissions shall not exceed 106 microvolts/meter at 30 meters.

(3) Radiation emission

According to 15.225(d), the field strength of any emissions appearing outside of the 13.110-14.010 MHz band shall not exceed the general radiated emission limits in § 15.209.

(4) Frequency tolerance

The frequency tolerance of the carrier signal shall be maintained within +/- 0.01% of the operating frequency over a temperature variation of -20 degrees to +50 degrees C at normal supply voltage, and for a variation in the primary supply voltage from 85% to 115% of the rated supply voltage at a temperature of 20 degrees C. For battery operated equipment, the equipment tests shall be performed using a new battery.

(5) Radiated emission limits, general requirements.

According to 15.209, except as provided elsewhere in this Subpart, the emissions from an intentional radiator shall not exceed the field strength levels specified in the following table:

<b>Frequency (MHz)</b>	<b>Field Strength (uV/m)</b>	<b>Measurement Distance (m)</b>
0.009 - 0.490	2400/F(kHz)	300
0.490 - 1.705	24000/F(kHz)	30
1.705 - 30.0	30	30
30 - 88	100 **	3
88 - 216	150 **	3
216 - 960	200 **	3
Above 960	500	3

\*\* Except as provided in paragraph (g), fundamental emissions from intentional radiators operating under this Section shall not be located in the frequency bands 54-72 MHz, 76-88 MHz, 174-216 MHz or 470-806 MHz. However, operation within these frequency bands is permitted under other sections of this Part, e.g., Sections 15.231 and 15.241.

(6) 20dB Bandwidth

According to 15.215(c) requires the device must be designed to ensure that the 20 dB bandwidth of the emission, or whatever bandwidth may otherwise be specified in the specific rule section under which the equipment operates.

(7) Conduction Emission Requirement

For intentional device, according to §15.207(a) line conduction emission limit is as below table.

Frequency of Emission (MHz)	Conducted Limit (dBuV)	
	Quasi-peak	Average
0.15 – 0.5	66 to 56*	56 to 46*
0.5 - 5	56	46
5 - 30	60	50

\* Decreases with the logarithm of the frequency.

(8) Restricted Band

Frequency (MHz)	Frequency (MHz)	Frequency (MHz)	Frequency (GHz)
0.090 - 0.110	16.42 - 16.423	399.9 - 410	4.5 - 5.15
<sup>1</sup> 0.495 - 0.505	16.69475 - 16.69525	608 - 614	5.35 - 5.46
<sup>2</sup> 1735 - 2.1905	16.80425 - 16.80475	960 - 1240	7.25 - 7.75
4.125 - 4.128	25.5 - 25.67	1300 - 1427	8.025 - 8.5
4.17725 - 4.17775	37.5 - 38.25	1435 - 1626.5	9.0 - 9.2
4.20725 - 4.20775	73 - 74.6	1645.5 - 1646.5	9.3 - 9.5
6.215 - 6.218	74.8 - 75.2	1660 - 1710	10.6 - 12.7
6.26775 - 6.26825	108 - 121.94	1718.8 - 1722.2	13.25 - 13.4
6.31175 - 6.31225	123 - 138	2200 - 2300	14.47 - 14.5
8.291 - 8.294	149.9 - 150.05	2310 - 2390	15.35 - 16.2
8.362 - 8.366	156.52475 - 156.52525	2483.5 - 2500	17.7 - 21.4
8.37625 - 8.38675	156.7 - 156.9	2690 - 2900	22.01 - 23.12
8.41425 - 8.41475	162.0125 - 167.17	3260 - 3267	23.6 - 24.0
12.29 - 12.293	167.72 - 173.2	3332 - 3339	31.2 - 31.8
12.51975 - 12.52025	240 - 285	3345.8 - 3358	36.43 - 36.5
12.57675 - 12.57725	322 - 335.4	3600 - 4400	(2)
13.36 - 13.41			

<sup>1</sup> Until February 1, 1999, this restricted band shall be 0.490-0.510 MHz.

<sup>2</sup> Above 38.6



**(9) Antenna Requirement**

An intentional radiator shall be designed to ensure that no antenna other than that furnished by the responsible party shall be used with the device. The use of a permanently attached antenna or of an antenna that uses a unique coupling to the intentional radiator shall be considered sufficient to comply with the provisions of this Section. The manufacturer may design the unit so that a broken antenna can be replaced by the user, but the use of a standard antenna jack or electrical connector is prohibited. This requirement does not apply to carrier current devices or to devices operated under the provisions of Sections 15.211, 15.213, 15.217, 15.219, or 15.221. Further, this requirement does not apply to intentional radiators that must be professionally installed, such as perimeter protection systems and some field disturbance sensors, or to other intentional radiators which, in accordance with Section 15.31(d), must be measured at the installation site. However, the installer shall be responsible for ensuring that the proper antenna is employed so that the limits in this Part are not exceeded.

## **1.5 The Support Units**

Continuous mode

**1.6 Layout of Setup**

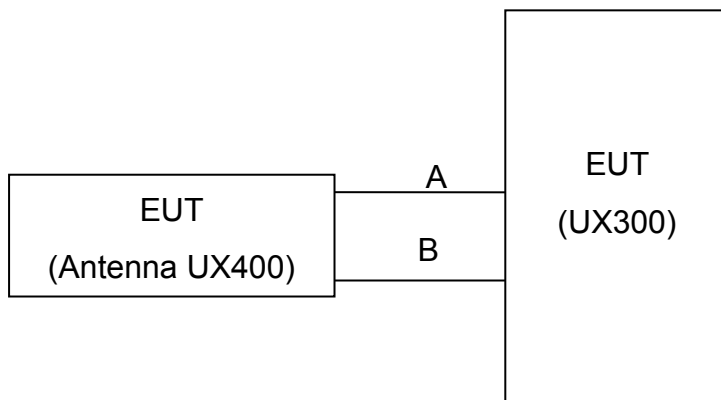

**Connecting Cables :**

No.	Cable	Length	Shielded	Core	Shielded Backshell	Supported by lab.
A	RJ45 Cable (CBL159-301-01-A)	0.6m	✓			
B	SMA Cable (CBL159-302-02-A)	0.5m	✓			

**Justification:**

For both conducted and radiated emission below 1GHz, the system was configured for typical fashion as a customer could use it normally.

For radiated emission, measurement of radiated emission from digital circuit is performed with normal transmitting.

## 1.7 Test Capability

### Test Facility

The test facility used for evaluating the conformance of the EUT with each standard in the present report meets what required in CISPR16-1-4, CISPR16-2-3 and ANSI C63.4:2009.

Test Room	Type of Test Room	Descriptions
TR1	10m semi-anechoic chamber (23m×14m×9m)	Complying with the NSA requirements set in documents CISPR 22 and ANSI C63.4:2009. For the radiated emission measurement.
TR11	3m semi-anechoic chamber (9m × 6m × 6m)	
TR13	Test site	For the RF conducted emission measurement.
TR5	Shielding Room (8m×5m×4m)	For the conducted emission measurement.

**Test Laboratory Competence Information**

Central Research Technology Co. has been accredited / filed / authorized by the agencies listed in the following table.

<b>Certificate</b>	<b>Nation</b>	<b>Agency</b>	<b>Code</b>	<b>Mark</b>
Accreditation Certificate	USA	NVLAP	200575-0	ISO/IEC 17025
	R.O.C. (Taiwan)	TAF	0905	ISO/IEC 17025
	R.O.C. (Taiwan)	BSMI	SL2-IN-E-0033, SL2-IS-E-0033, SL2-R1/R2-E-0033, SL2-A1-E-0033 SL2-L1-E-0033	ISO/IEC 17025
Site Filing Document	USA	FCC	474046,TW1053	Test facility list & NSA Data
	Canada	IC	4699A-1,-3	Test facility list & NSA Data
	Japan	VCCI	R-1527,C-1609,C-4400,T-1441, T-1334, G-10, G-614	Test facility list & NSA Data
Authorization Certificate	Germany	TUV	UA50235497	ISO/IEC 17025
	Norway	Nemko	ELA 212	ISO/IEC 17025

The copy of each certificate can be downloaded from our web site: [www.crc-lab.com](http://www.crc-lab.com)

**1.8 Measurement Uncertainty**

The assessed measurement uncertainty with a suitable coverage factor K to ensure 95% confidence level for the normal distribution are shown as below, the values are less than  $U_{Cispr}$  in table 1 of CISPR 16-4-2.

Test Item	Measurement Uncertainty	
Radiated Emission: (30MHz~200MHz)	Horizontal: 3.9dB ; Vertical: 4.2dB	
Radiated Emission: (200MHz~1GHz)	Horizontal: 4.5dB ; Vertical: 5.7dB	
Conducted Emission	ESH2-Z5	3.3dB
	ENV 4200	3.1dB

**2. Conducted Emission Measurement**

**Result: Pass**

**2.1 Limits for Emission Measurement**

For intentional device, according to §15.207(a) line conduction emission limit is as below table.

Frequency of Emission (MHz)	Conducted Limit (dBuV)	
	Quasi-peak	Average
0.15 – 0.5	66 to 56*	56 to 46*
0.5 - 5	56	46
5 - 30	60	50

\* Decreases with the logarithm of the frequency.

Note:

For a device with a permanent antenna operating at or below 30 MHz, the FCC will accept measurements done with a suitable dummy load, in lieu of the permanent antenna under the following conditions: (1) perform the AC line conducted tests with the permanent antenna to determine compliance with the Section 15.207 limits outside the transmitter's fundamental emission band; (2) retest with a dummy load in lieu of the permanent antenna to determine compliance with the Section 15.207 limits within the transmitter's fundamental emission band.

**2.2 Test Instruments**

<b>Test Site and Equipment</b>	<b>Manufacturer</b>	<b>Model No./ Serial No.</b>	<b>Last Calibration Date</b>	<b>Calibration Due Date</b>
Test Receiver	R&S	ESCS 30/ 836858/021	Jan. 16, 2015	Jan. 16, 2016
LISN	R&S	ESH2-Z5/ 880669/039	March 15, 2014	March 15, 2015
2 <sup>nd</sup> LISN	R&S	ENV4200/ 833209/010	April 2, 2014	April 2, 2015
50Ω terminator	R&S	N/A/ 001	Aug. 19, 2014	Aug. 19, 2015
RF Switch	R&S	RSU28/ 338965/002	Feb. 6, 2015	Aug. 6, 2015
RF Cable	N/A	N/A/ C0052 ~ 56	Feb. 6, 2015	Aug. 6, 2015
Dummy Load	N/A	50Ω 1/4W Resistance	NCR	NCR
Test Software	Audix	e3/ Ver. 5.2004-2-19k	NCR	NCR
TR5 shielded room	ETS LINDGREN	TR5/ 15353-F	NCR	NCR

Note:

1. The calibrations are traceable to NML/ROC.
2. NCR : No Calibration Required.

**Instrument Setting**

<b>IF BW</b>	<b>Measurement Time</b>	<b>Detector</b>	<b>Trace</b>	<b>Comment</b>
9kHz	1 second	Quasi-Peak / Average	Maxhold	

**Climatic Condition**

Ambient Temperature : 24°C;      Relative Humidity : 65%



## 2.3 Test Procedures

- a. The EUT was set up per the test configuration figured in the next section of this chapter to simulate the typical usage per the user's manual.
- b. If the EUT is tabletop equipment, it was placed on a non-conducted table with a height of 0.8 meters above the reference ground plane and 0.4 meters from the conducting wall of the shielded room. Also if the EUT is floor-standing equipment, it was placed on a non-conducted support with a height of 12 millimeters above the reference ground plane.
- c. Connect the EUT's power source to the appropriate power mains through the LISN.
- d. All the other peripherals are connected to the 2<sup>nd</sup> LISN, if any.
- e. The LISN was placed 0.8 meters from the EUT and at least 0.8 meters from other units and other metal planes.
- f. Measure the conducted emissions on each power line (Neutral Line and Line 1 – Hot side) of the EUT's power source by using the test receiver connected to the coupling RF output port of LISN.
- g. Rapidly scan the signal from 150kHz to 30MHz by using the receiver through the Maximum-Peak detector to determine those frequencies associated with higher emission levels for each measured line.
- h. Then measure the maximum level of conducted disturbance for each frequency found from step g. by using the receiver through the Quasi-Peak and Average detectors per CISPR 16-1.
- i. Record the level for each frequency and compare with the required limit.

### 2.4 Test Configurations

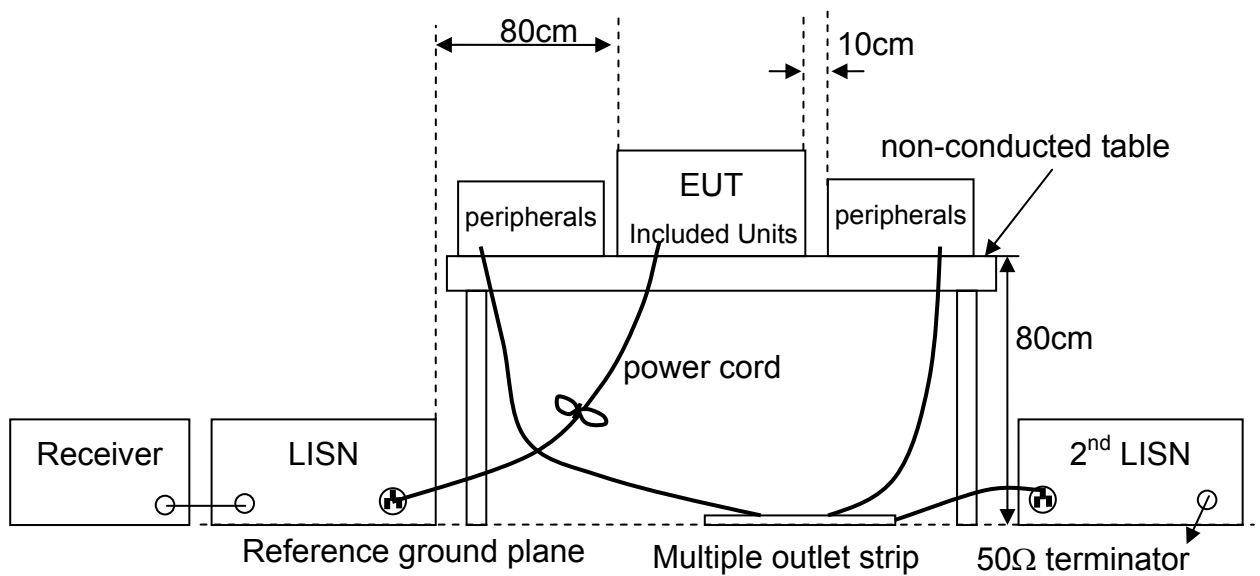

2.5 Test Data

Test Mode : Continuous Transmitting, with antenna  
 Tester : Wilson Frequency Range : 150kHz~30MHz  
 Phase : Line

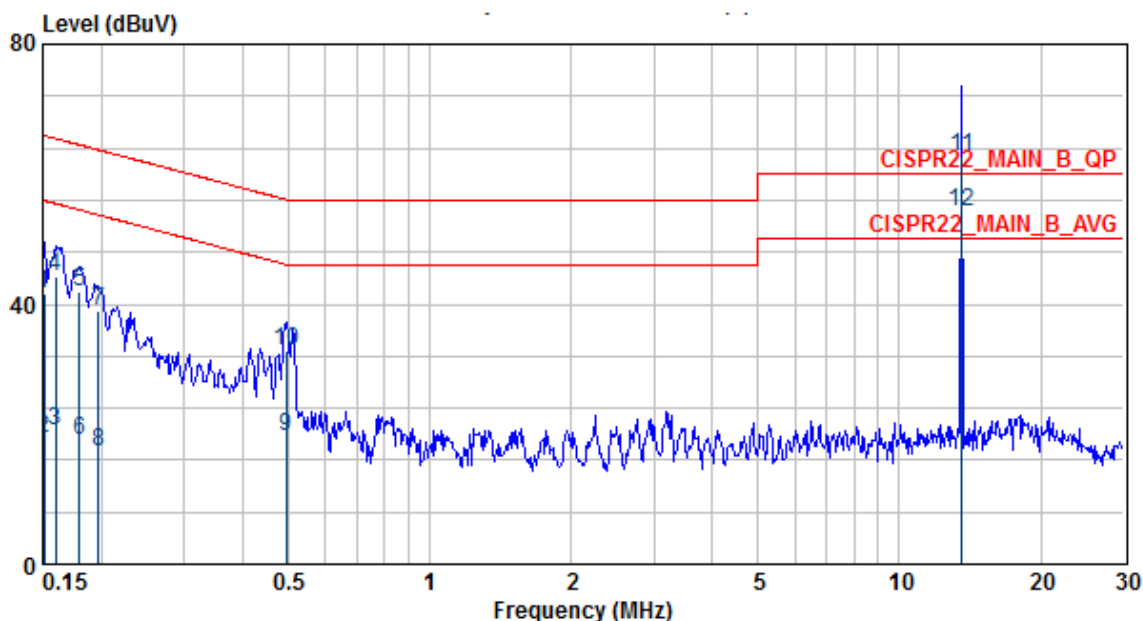

	Freq	Level	Factor	Read Level	Limit Line	Over Limit	Pol/Phase	Remark
	MHz	dBuV	dB	dBuV	dBuV	dB		
1	0.151	41.68	0.31	41.37	65.96	-24.28	LINE	QP
2	0.151	19.35	0.31	19.04	55.96	-36.61	LINE	AVERAGE
3	0.160	20.53	0.31	20.22	55.47	-34.94	LINE	AVERAGE
4	0.160	44.22	0.31	43.91	65.47	-21.25	LINE	QP
5	0.180	41.93	0.31	41.62	64.50	-22.57	LINE	QP
6	0.180	19.07	0.31	18.76	54.50	-35.43	LINE	AVERAGE
7	0.198	38.84	0.31	38.53	63.71	-24.87	LINE	QP
8	0.198	17.18	0.31	16.87	53.71	-36.53	LINE	AVERAGE
9	0.494	19.64	0.33	19.31	46.10	-26.45	LINE	AVERAGE
10	0.494	32.85	0.33	32.52	56.10	-23.24	LINE	QP
11 X	13.560	62.67	0.97	61.70	60.00	2.67	LINE	QP
12 e	13.560	54.27	0.97	53.30	50.00	4.27	LINE	AVERAGE

Note:

1. Emission Level = reading value + correction factor.
2. Correction factor = cable loss + insertion loss of LISN.
3. Q.P. is abbreviation of quasi-peak.
4. 13.56MHz is main frequency, the signal can be omitted.

Test Mode : Continuous Transmitting, with dummy load  
 Tester : Wilson Frequency Range : 150kHz~30MHz  
 Phase : Line

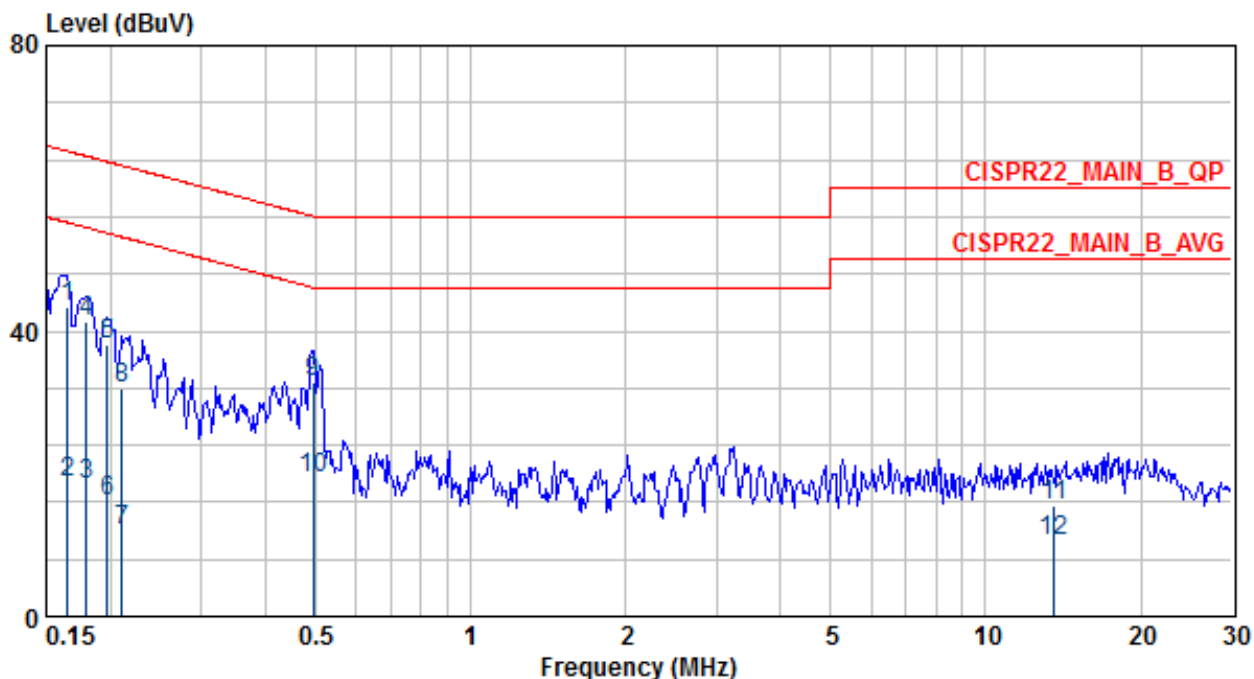

	Freq	Level	Factor	Read Level	Limit Line	Over Limit	Pol/Phase	Remark
	MHz	dBuV	dB	dBuV	dBuV	dB		
1	0.165	43.26	0.31	42.95	65.21	-21.95	LINE	QP
2	0.165	18.88	0.31	18.57	55.21	-36.33	LINE	AVERAGE
3	0.180	18.57	0.31	18.26	54.50	-35.93	LINE	AVERAGE
4	0.180	41.43	0.31	41.12	64.50	-23.07	LINE	QP
5	0.198	38.15	0.31	37.84	63.71	-25.56	LINE	QP
6	0.198	16.00	0.31	15.69	53.71	-37.71	LINE	AVERAGE
7	0.211	12.06	0.31	11.75	53.18	-41.12	LINE	AVERAGE
8	0.211	31.91	0.31	31.60	63.18	-31.27	LINE	QP
9	0.494	32.76	0.33	32.43	56.10	-23.33	LINE	QP
10	0.494	19.42	0.33	19.09	46.10	-26.67	LINE	AVERAGE
11	13.560	15.49	0.97	14.52	60.00	-44.51	LINE	QP
12	13.560	10.47	0.97	9.50	50.00	-39.53	LINE	AVERAGE

Note:

1. Emission Level = reading value + correction factor.
2. Correction factor = cable loss + insertion loss of LISN.
3. Q.P. is abbreviation of quasi-peak.
4. 13.56MHz is main frequency, the signal can be omitted.

Test Mode : Continuous Transmitting, with antenna  
 Tester : Wilson Frequency Range : 150kHz~30MHz  
 Phase : Neutral

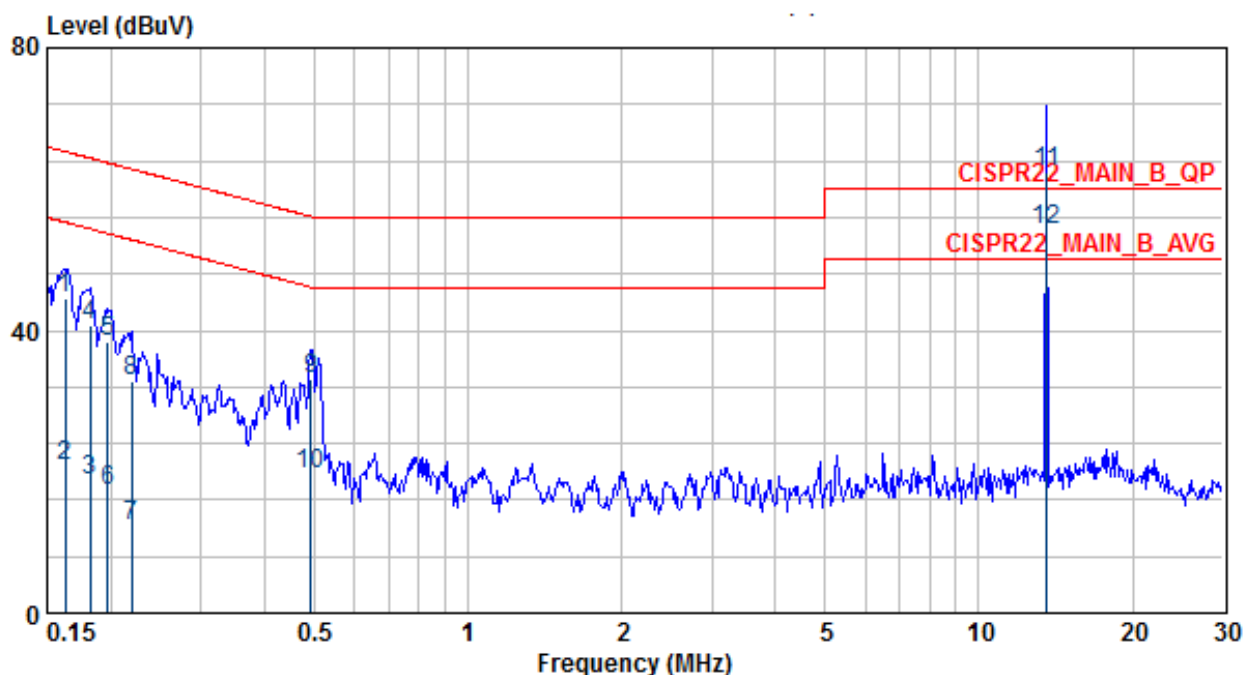

	Freq	Level	Factor	Read Level	Limit Line	Over Limit	Pol/Phase	Remark
	MHz	dBuV	dB	dBuV	dBuV	dB		
1	0.162	44.57	0.34	44.23	65.34	-20.77	NEUTRAL	QP
2	0.162	20.84	0.34	20.50	55.34	-34.50	NEUTRAL	AVERAGE
3	0.182	18.72	0.34	18.38	54.37	-35.65	NEUTRAL	AVERAGE
4	0.182	40.75	0.34	40.41	64.37	-23.62	NEUTRAL	QP
5	0.198	38.36	0.34	38.02	63.71	-25.35	NEUTRAL	QP
6	0.198	17.37	0.34	17.03	53.71	-36.34	NEUTRAL	AVERAGE
7	0.220	12.17	0.34	11.83	52.83	-40.66	NEUTRAL	AVERAGE
8	0.220	32.93	0.34	32.59	62.83	-29.90	NEUTRAL	QP
9	0.491	33.19	0.35	32.84	56.14	-22.95	NEUTRAL	QP
10	0.491	19.68	0.35	19.33	46.14	-26.46	NEUTRAL	AVERAGE
11 X	13.560	62.47	0.97	61.50	60.00	2.47	NEUTRAL	QP
12 X	13.560	54.27	0.97	53.30	50.00	4.27	NEUTRAL	AVERAGE

Note:

1. Emission Level = reading value + correction factor.
2. Correction factor = cable loss + insertion loss of LISN.
3. Q.P. is abbreviation of quasi-peak.

Test Mode : Continuous Transmitting, with dummy load  
 Tester : Wilson Frequency Range : 150kHz~30MHz  
 Phase : Neutral

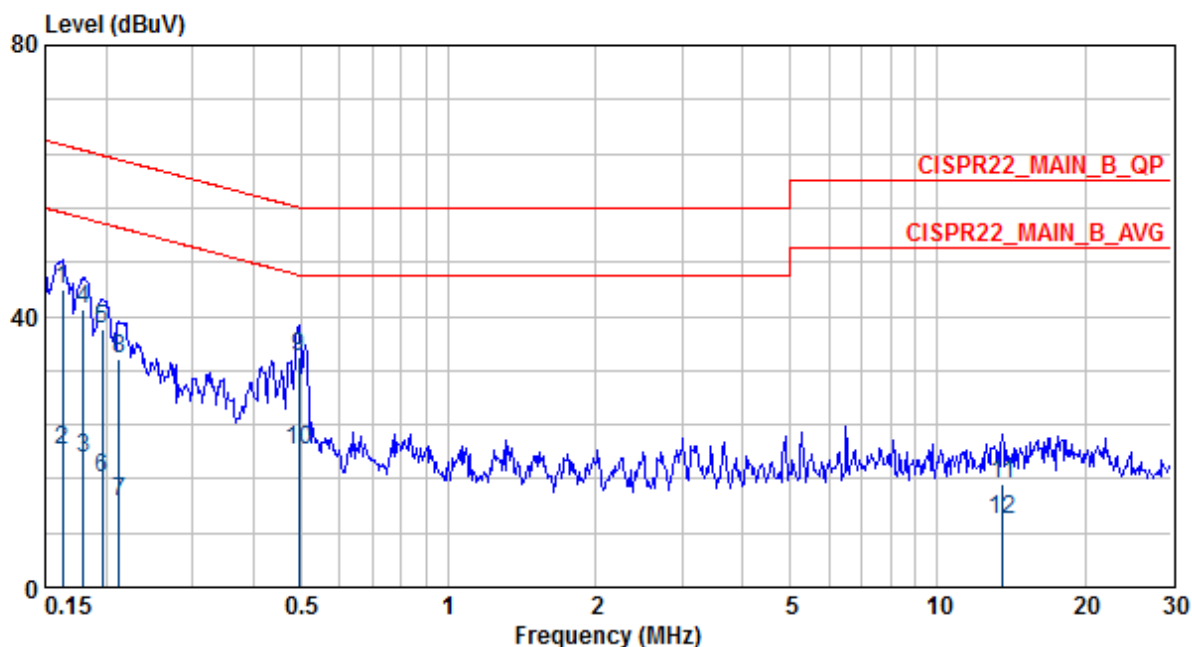

	Freq	Level	Factor	Read Level	Limit Line	Over Limit	Pol/Phase	Remark
	MHz	dBuV	dB	dBuV	dBuV	dB		
1	0.162	43.89	0.34	43.55	65.34	-21.45	NEUTRAL	QP
2	0.162	20.27	0.34	19.93	55.34	-35.07	NEUTRAL	AVERAGE
3	0.180	18.92	0.34	18.58	54.50	-35.58	NEUTRAL	AVERAGE
4	0.180	41.16	0.34	40.82	64.50	-23.34	NEUTRAL	QP
5	0.197	37.98	0.34	37.64	63.76	-25.78	NEUTRAL	QP
6	0.197	15.99	0.34	15.65	53.76	-37.77	NEUTRAL	AVERAGE
7	0.213	12.70	0.34	12.36	53.10	-40.39	NEUTRAL	AVERAGE
8	0.213	33.65	0.34	33.31	63.10	-29.44	NEUTRAL	QP
9	0.494	33.85	0.35	33.50	56.10	-22.24	NEUTRAL	QP
10	0.494	20.08	0.35	19.73	46.10	-26.01	NEUTRAL	AVERAGE
11	13.560	15.37	0.97	14.40	60.00	-44.63	NEUTRAL	QP
12	13.560	9.87	0.97	8.90	50.00	-40.13	NEUTRAL	AVERAGE

Note:

1. Emission Level = reading value + correction factor.
2. Correction factor = cable loss + insertion loss of LISN.
3. Q.P. is abbreviation of quasi-peak.

### **3. Field Strength of fundamental Measurement**

**Test Result : PASS**

#### **3.1 Applied Standard**

According to 15.225(a), the field strength of any emissions within the band 13.553 – 13.567 MHz shall not exceed 15,848 microvolts/meter at 30 meters.

According to 15.225(b), within the bands 13.410-13.553 MHz and 13.567-13.710 MHz, the field strength of any emissions shall not exceed 334 microvolts/meter at 30 meters.

According to 15.225(c), within the bands 13.110-13.410 MHz and 13.710-14.010 MHz the field strength of any emissions shall not exceed 106 microvolts/meter at 30 meters.

**3.2 Test Instruments**

<b>Test Site and Equipment</b>	<b>Manufacturer</b>	<b>Model No./ Serial No.</b>	<b>Last Calibration Date</b>	<b>Calibration Due Date</b>
EMI Test Receiver	R&S	ESCI/ 100019	June 12, 2014	June 12, 2015
Loop Antenna	EMCO	6502/ 20558	Aug. 29, 2013	Aug. 29, 2015
RF Cable	N/A	N/A/ C0080	Feb. 10, 2015	Aug. 10, 2015
Test Software	Audix	e3/ ARD-SPR-000282	NCR	NCR
TR11 Semi – anechoic Chamber	ETS. LINDGREN	TR11/ 906-A	May 2, 2014	May 2, 2015

Note:

1. The calibrations are traceable to NML/ROC.
2. NCR : No Calibration Required.
3. The calibration date of the semi-anechoic chamber listed above is the date of NSA measurement.

**Instrument Setting**

<b>RBW</b>	<b>VBW</b>	<b>Detector</b>	<b>Trace</b>	<b>Comment</b>
9kHz	N/A	Quasi-Peak	Maxhold	

**Climatic Condition**

Ambient Temperature : 22°C ; Relative Humidity : 63%



### **3.3 Measurement Procedure**

- a. The EUT was set up per the test configuration figured in the next section of this chapter to simulate the typical usage per the user's manual.
- b. If the EUT is tabletop equipment, it should be placed on a wooden table with a height of 0.8 meters above the reference ground plane in the semi-anechoic chamber. If the EUT is floor-standing equipment, it should be placed on a non-conducted support with a height of 12 millimeters above the reference ground plane in the semi-anechoic chamber.
- c. The EUT is set at 3m away from the receiving antenna.
- d. Rapidly sweep the signal in the test frequency range by using the receiver through the Quasi-Peak detector.
- e. Rotate the EUT from 0° to 360° and position the receiving loop antenna at 1~4 meters above the reference ground plane to determine the fundamental frequency and and bandedge and record them.
- f. Then measure each frequency found from step e. by using the receiver with rotating the EUT and positioning the receiving antenna height to determine the maximum level.
- g. Finely tune the antenna and turntable around the recorded position of each frequency found from step e.
- h. Record and compare the maximum level with the required limit.
- i. Change the receiving antenna to another polarization to measure field strength of fundamental by following step d. to g. again.

### 3.4 Test Configuration

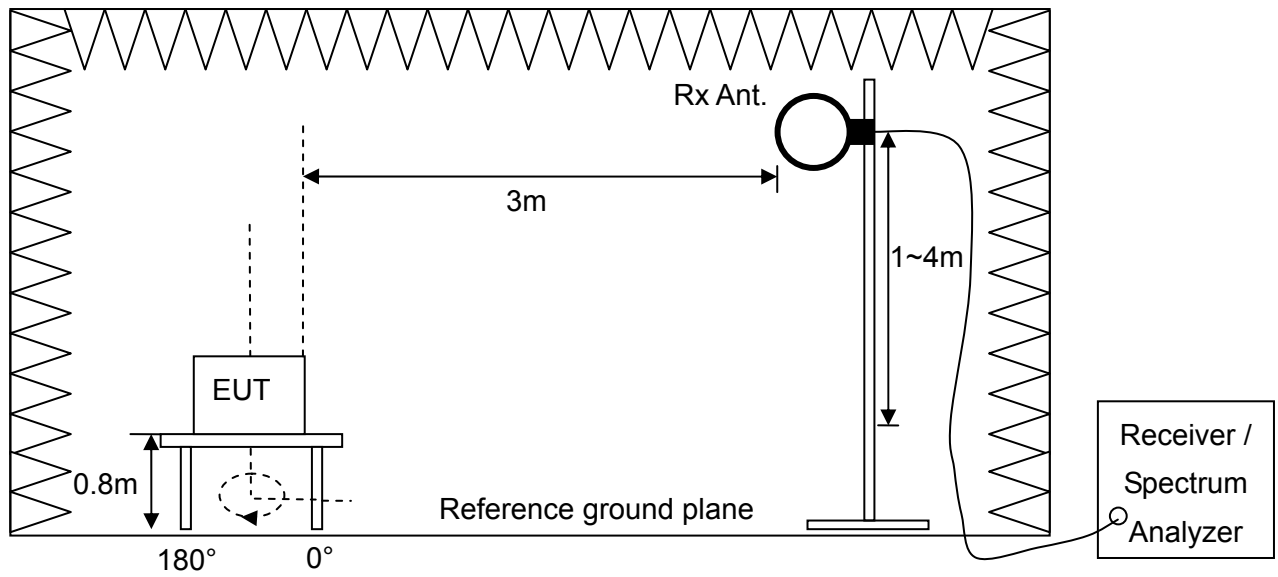

### 3.5 Test Results

#### Field strength of fundamental

Test Mode : Continuous Transmitting  
 Tester : Liu  
 Polarization : Horizontal

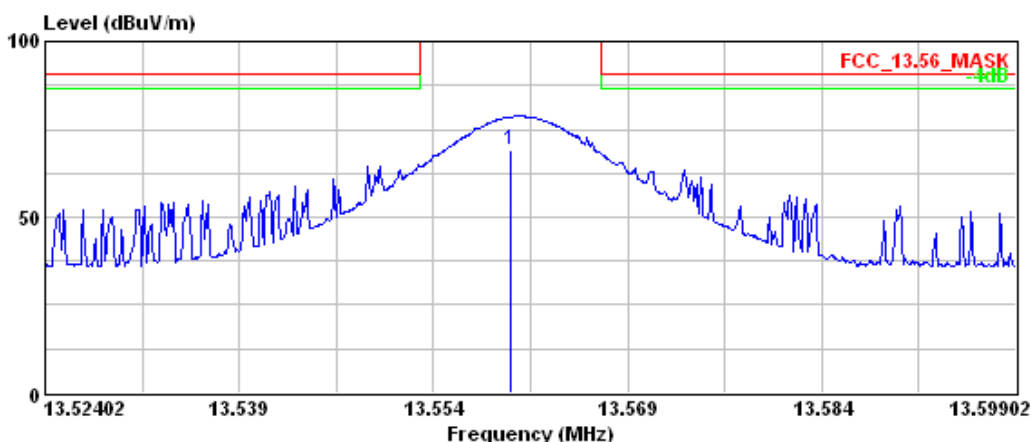

	Read	Limit	Over	Ant	Table				
Freq	Level	Level	Factor	Line	Limit	Pos	Pos	Pol/Phase	Remark
MHz	dBuV/m	dBuV	dB/m	dBuV/m	dB	cm	deg		
1 @ 13.560	69.00	54.61	14.39	124.00	-55.00	100	190	HORIZONTAL	QP

Note :

1. Correction Factor (dB/m) = Cable Loss + Antenna Factor
2. Emission Level (dBuV/m) = Reading Data + Correction Factor
3. The limit is 15848 (uV/m)=84dBuV/m @ 30 m , for main frequency < 30MHz, the formula transfers the limit at 30 m to 3m is  $L_{30}(dBuV/m) + 40 = 124 dBuV/m$
4. Margin (dB) = Limit – Emission Level

Test Mode : Continuous Transmitting  
 Tester : Liu  
 Polarization : Vertical

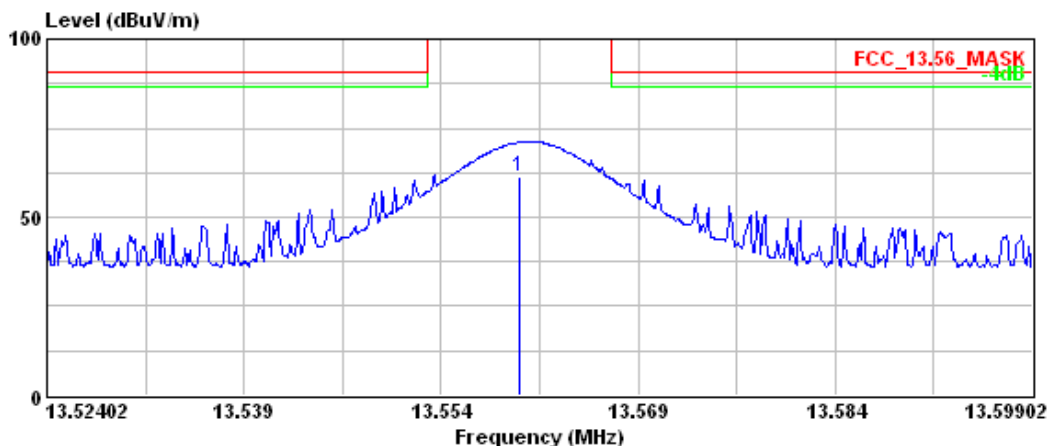

1	Freq	Level	Read	Factor	Limit	Over	Ant	Table	Remark
	MHz	dBuV/m	dBuV	dB/m	dBuV/m	dB	cm	deg	
1	13.560	61.40	47.01	14.39	124.00	-62.60	100	190	VERTICAL QP

Note :

1. Correction Factor (dB/m) = Cable Loss + Antenna Factor
2. Emission Level (dBuV/m) = Reading Data + Correction Factor
3. The limit is 15848 (uV/m)=84dBuV/m @ 30 m , for main frequency < 30MHz, the formula transfers the limit at 30 m to 3m is  $L_{30}(dBuV/m) + 40 = 124 dBuV/m$
4. Margin (dB) = Limit – Emission Level

### Band Edge

Test Mode : Continuous Transmitting

Tester : Liu

Polarization : Horizontal

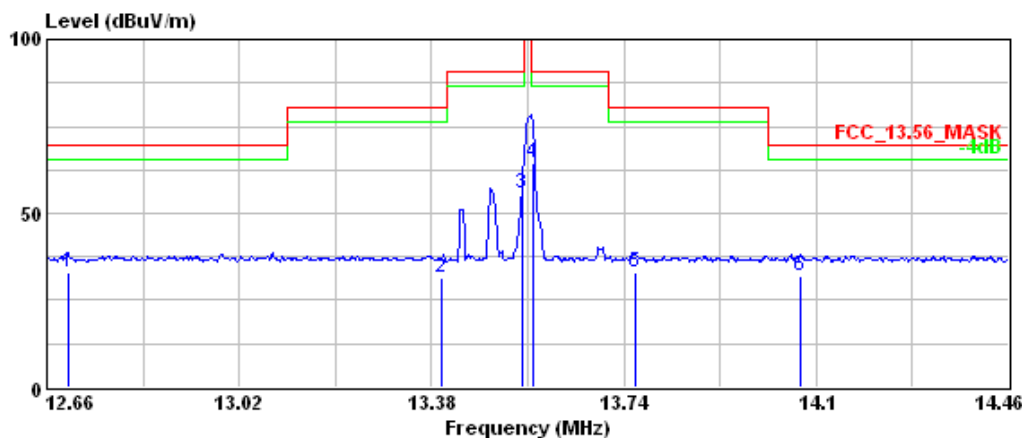

	Read	Limit	Over	Ant	Table			Remark
Freq	Level	Level	Factor	Line	Limit	Pos	Pos	Pol/Phase
MHz	dBuV/m	dBuV	dB/m	dBuV/m	dB	cm	deg	
1	12.700	32.80	18.33	14.47	69.54	-36.74	100	146 HORIZONTAL QP
2	13.400	31.65	17.24	14.41	80.51	-48.86	100	59 HORIZONTAL QP
3	13.550	55.91	41.52	14.39	90.47	-34.56	100	190 HORIZONTAL QP
4	13.570	64.68	50.29	14.39	90.47	-25.79	100	191 HORIZONTAL QP
5	13.760	32.85	18.48	14.37	80.51	-47.66	100	247 HORIZONTAL QP
6	14.070	31.91	17.58	14.33	69.54	-37.63	100	256 HORIZONTAL QP

Note :

- Factor (dB/m) = Cable Loss + Antenna Factor
- Level (dBuV/m) = Read Level + Factor
- Over Limit (dB) = Level – Limit Line
- For main frequency < 30MHz, the formula transfers the limit at 30 m to 3m is  $L_{30}(\text{dBuV/m}) + 40$

Test Mode : Continuous Transmitting

Tester : Liu

Polarization : Vertical

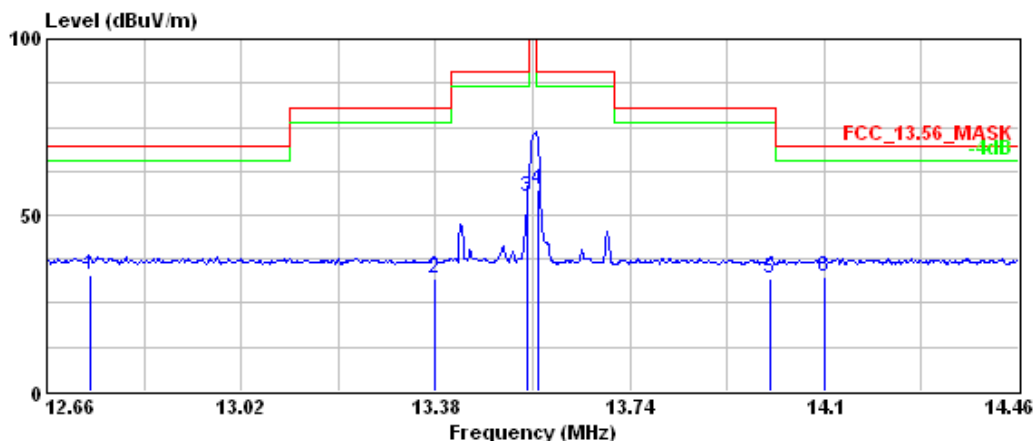

	Freq	Level	Read Level	Factor	Limit Line	Over Limit	Ant Pos	Table Pos	Pol/Phase	Remark
	MHz	dBuV/m	dBuV	dB/m	dBuV/m	dB	cm	deg		
1	12.740	32.90	18.43	14.47	69.54	-36.64	101	170	VERTICAL	QP
2	13.380	31.87	17.46	14.41	80.51	-48.64	102	308	VERTICAL	QP
3	13.550	55.28	40.89	14.39	90.47	-35.19	101	190	VERTICAL	QP
4	13.570	57.25	42.86	14.39	90.47	-33.22	101	190	VERTICAL	QP
5	14.000	32.02	17.68	14.34	80.51	-48.49	101	294	VERTICAL	QP
6	14.100	32.55	18.22	14.33	69.54	-36.99	102	189	VERTICAL	QP

Note :

1. Factor (dB/m) = Cable Loss + Antenna Factor
2. Level (dBuV/m) = Read Level + Factor
3. Over Limit (dB) = Level – Limit Line
4. For main frequency < 30MHz, the formula transfers the limit at 30 m to 3m is  $L_{30}(\text{dBuV/m}) + 40$

**4. Radiated Emission**

**Test Result : PASS**

**4.1 Applied Standard**

According to 15.225(d), The field strength of any emissions appearing outside of the 13.110-14.010 MHz band shall not exceed the general radiated emission limits in § 15.209.

<b>Frequency (MHz)</b>	<b>Field Strength (uV/m)</b>	<b>Measurement Distance (m)</b>
0.009 - 0.490	2400/F(kHz)	300
0.490 - 1.705	24000/F(kHz)	30
1.705 - 30.0	30	30
30 - 88	100 **	3
88 - 216	150 **	3
216 - 960	200 **	3
Above 960	500	3

\*\* Except as provided in paragraph (g), fundamental emissions from intentional radiators operating under this Section shall not be located in the frequency bands 54-72 MHz, 76-88 MHz, 174-216 MHz or 470-806 MHz. However, operation within these frequency bands is permitted under other sections of this Part, e.g., Sections 15.231 and 15.241.

**4.2 Test Instruments**

<b>Test Site and Equipment</b>	<b>Manufacturer</b>	<b>Model No./ Serial No.</b>	<b>Last Calibration Date</b>	<b>Calibration Due Date</b>
EMI Test Receiver	R&S	ESCI/ 100019	June 12, 2014	June 12, 2015
Spectrum Analyzer	Agilent	E4407B/ MY45106795	May 29, 2014	May 29, 2015
Loop Antenna	EMCO	6502/ 20558	Aug. 29, 2013	Aug. 29, 2015
Bi-Log Antenna	EMCO	3142C/ 52088	May 14, 2014	May 14, 2015
Pre-Amplifier	Mini-circuit	ZKL-2/ 004	Feb. 10, 2015	Aug. 10, 2015
RF Cable	N/A	N/A/ C0080	Feb. 10, 2015	Aug. 10, 2015
TR11 Semi - anechoic Chamber	ETS. LINDGREN	TR11/ 906-A	May 2, 2014	May 2, 2015

Note:

1. The calibrations are traceable to NML/ROC.
2. NCR:No Calibration Required.
3. The calibration date of the semi-anechoic chamber listed above is the date of NSA measurement.

**Instrument Setting**

<b>RBW</b>	<b>VBW</b>	<b>Detector</b>	<b>Trace</b>	<b>Comment</b>
9kHz	N/A	Quasi-Peak	Maxhold	Below 30MHz
120kHz	N/A	Quasi-Peak	Maxhold	Below 1GHz

**Climatic Condition**

Ambient Temperature : 22°C; Relative Humidity : 63%



### **4.3 Measurement Procedure**

- a. The EUT was set up per the test configuration figured in the next section of this chapter to simulate the typical usage per the user's manual.
- b. A software provided by client enabled the EUT to transmit and receive data at specified channel frequencies individually.
- c. If the EUT is tabletop equipment, it was placed on a non-conducted table with a height of 0.8 meters above the reference ground plane in the semi-anechoic chamber. If the EUT is floor-standing equipment, it was placed on a non-conducted support with a height of 12 millimeters above the reference ground plane in the semi-anechoic chamber.
- d. The EUT is set at 3m away from the interference receiving antenna.
- e. Rapidly sweep the signal in the test frequency range by using the spectrum through the Maximum-peak detector.
- f. Rotate the EUT from 0° to 360° and position the receiving antenna at heights from 1 to 4 meters above the reference ground plane continuously to determine at least six frequencies associated with higher emission levels and record them.
- g. For measurement of frequency above 1000MHz, the beamwidth of receiving horn antenna should keep covering EUT when the receiving horn antenna height varied.
- h. Then measure each frequency found from step e. by using the spectrum with rotating the EUT and positioning the receiving antenna height to determine the maximum level.
- i. Finely tune the antenna and turntable around the recorded position of each frequency found from step g.
- j. For measurement of frequency below 1000MHz, set the receiver detector to be Quasi-Peak per CISPR 16-1 to find out the maximum level occurred.
- k. For measurement of frequency above 1000MHz, set the spectrum detector to be Peak or Average to find out the maximum level occurred, if any.
- l. Record frequency, azimuth angle of the turntable, height, and polarization of the receiving antenna and compare the maximum level with the required limit.
- m. Change the receiving antenna to another polarization to measure radiated emission by following step e. to l. again.
- n. If the peak emission level measured from step e. is 4dB lower than the limit specified, then the emission values presented will be the peak value only. Otherwise, accurate **Q.P. value will be measured and presented.**

### 4.4 Test Configuration

#### Radiated Emission Measurement below 30MHz

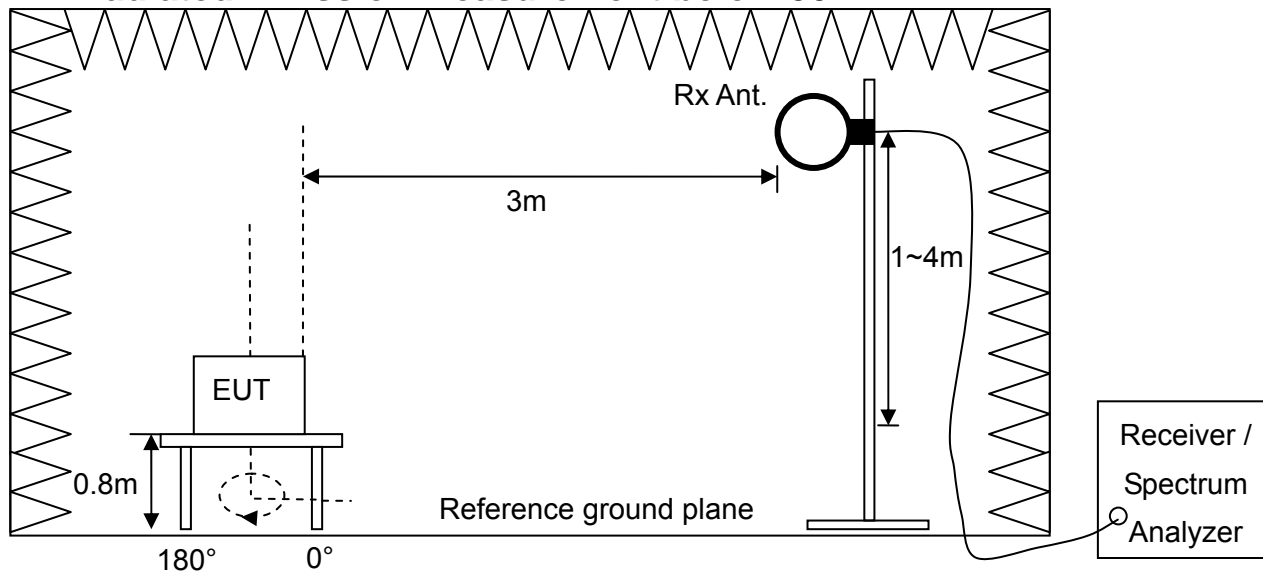

#### Radiated Emission Measurement above 30MHz

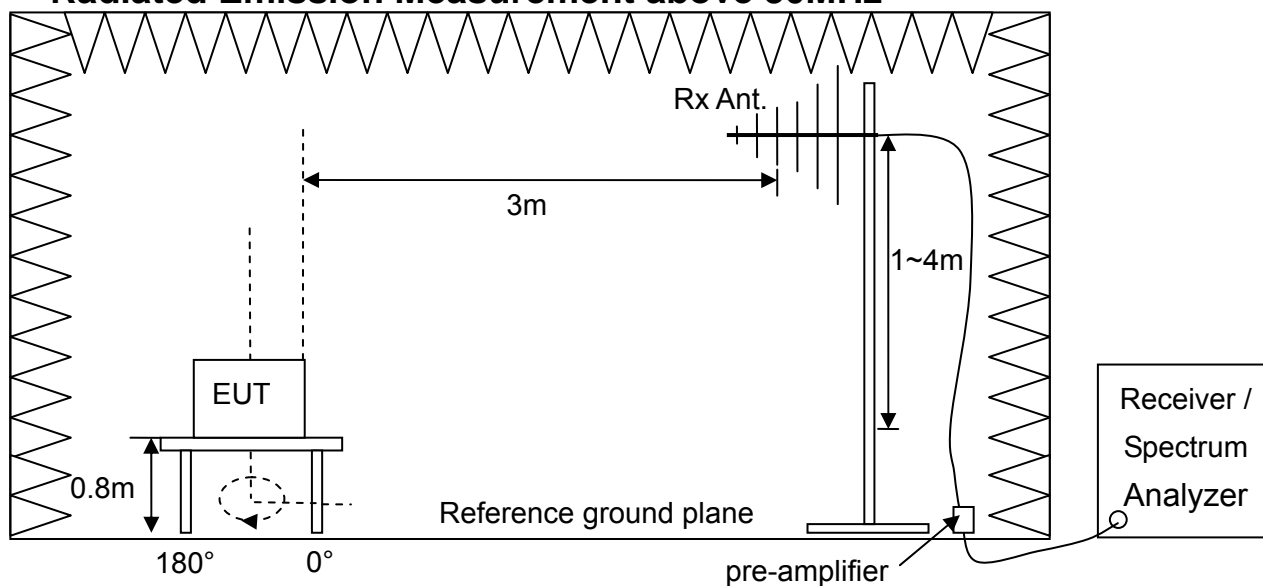

### 4.5 Test Results

**Test Mode** : Continuous Transmitting  
**Tester** : Liu **Frequency Range** : 9kHz~1GHz  
**Polarization** : Horizontal

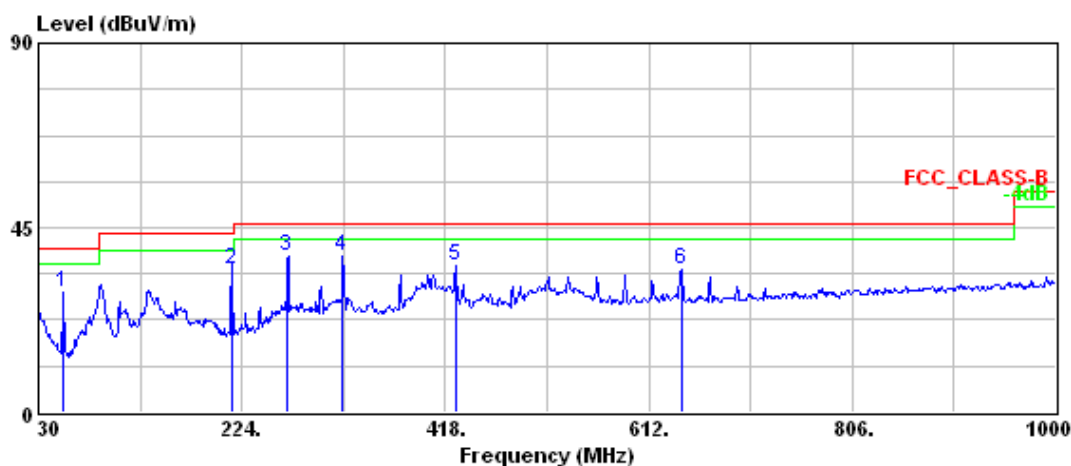

	Freq	Level	Read	Limit	Over	Ant	Table		
	MHz	dBuV/m	Level	Factor	Line	Limit	Pos	Pos	Pol/Phase
			dBuV	dB/m	dBuV/m	dB	cm	deg	Remark
1	53.490	29.27	47.59	-18.32	40.00	-10.73	---	---	HORIZONTAL Peak
2	213.870	34.86	49.99	-15.13	43.50	-8.64	139	25	HORIZONTAL QP
3	267.870	38.21	51.20	-12.99	46.00	-7.79	---	---	HORIZONTAL Peak
4	320.300	37.86	49.08	-11.22	46.00	-8.14	---	---	HORIZONTAL Peak
5	427.400	35.56	43.71	-8.15	46.00	-10.44	---	---	HORIZONTAL Peak
6	643.000	34.57	38.37	-3.80	46.00	-11.43	---	---	HORIZONTAL Peak

**Note :**

1. Correction Factor (dB/m) = Cable Loss + Antenna Factor – Gain of Pre-amplifier
2. Emission Level (dBuV/m) = Reading Data + Correction Factor

**No signal can be detected from 9kHz to 30MHz, so the graphs are omitted below 30MHz.**

Test Mode : Continuous Transmitting  
 Tester : Liu Frequency Range : 9kHz~1GHz  
 Polarization : Vertical

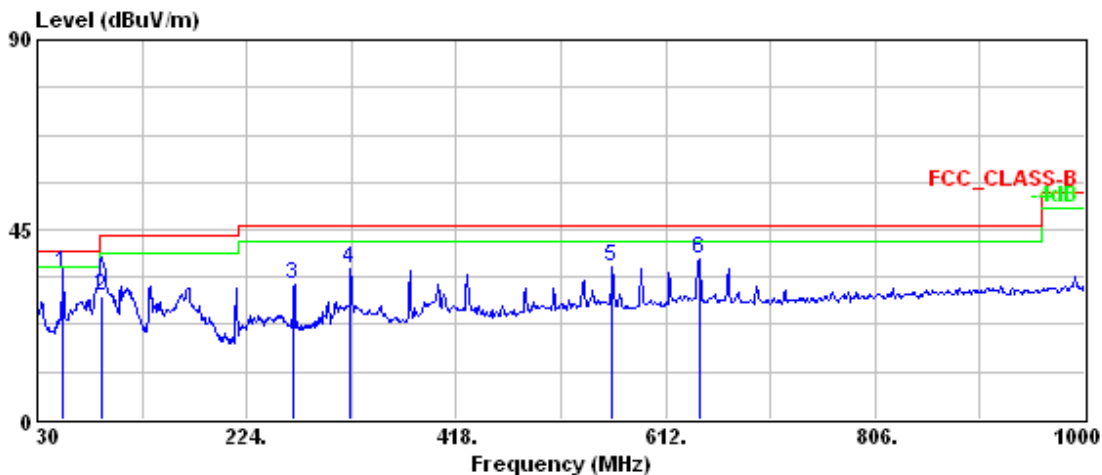

	Freq	Level	Read Level	Factor	Limit Line	Over Limit	Ant Pos	Table Pos	Pol/Phase	Remark
	MHz	dBuV/m	dBuV	dB/m	dBuV/m	dB	cm	deg		
1	53.477	34.97	53.29	-18.32	40.00	-5.03	100	3	VERTICAL	QP
2	89.400	29.21	48.25	-19.04	43.50	-14.29	100	0	VERTICAL	QP
3	267.870	32.22	45.21	-12.99	46.00	-13.78	---	---	VERTICAL	Peak
4	320.300	35.76	46.98	-11.22	46.00	-10.24	---	---	VERTICAL	Peak
5	562.500	36.12	41.41	-5.29	46.00	-9.88	---	---	VERTICAL	Peak
6	643.000	38.05	41.85	-3.80	46.00	-7.95	---	---	VERTICAL	Peak

Note :

1. Correction Factor (dB/m) = Cable Loss + Antenna Factor – Gain of Preamplifier
2. Emission Level (dBuV/m) = Reading Data + Correction Factor

No signal can be detected from 9kHz to 30MHz, so the graphs are omitted below 30MHz.

## **5. Frequency Tolerance**

**Test Result : PASS**

### **5.1 Applied Standard**

According to 15.225(e), the frequency tolerance of the carrier signal shall be maintained within +/- 0.01% of the operating frequency over a temperature variation of -20 degrees to +50 degrees C at normal supply voltage, and for a variation in the primary supply voltage from 85% to 115% of the rated supply voltage at a temperature of 20 degrees C. For battery operated equipment, the equipment tests shall be performed using a new battery.

**5.2 Test Instruments**

<b>Test Site and Equipment</b>	<b>Manufacturer</b>	<b>Model No./ Serial No.</b>	<b>Last Calibration Date</b>	<b>Calibration Due Date</b>
Spectrum Analyzer	Agilent	E4405B/ MY45106706	May 23, 2014	May 23, 2015
Temperature Chamber	Terchy	MHG-800LF/ 920224	Aug. 14, 2014	Aug. 14, 2015
Adjustable DC Power Supply	instek	PSP-405/ C120177	NCR	NCR
Voltage Meter	FLUKE	187/ 91050091	July 4, 2014	July 4, 2016
Test Site	N.A.	TR13	NCR	NCR

Note:

1. The calibrations are traceable to NML/ROC.
2. NCR:No Calibration Required.

**Instrument Setting**

<b>RBW</b>	<b>VBW</b>	<b>Detector</b>	<b>Trace</b>	<b>Comment</b>
300Hz	1kHz	Peak	Maxhold	

**Climatic Condition**

Ambient Temperature : 22°C;      Relative Humidity : 70%

### 5.3 Measurement Procedure

- a. The EUT was set up per the test configuration figured in the next section of this chapter to simulate the typical usage described in the user's manual supported by the manufacturer in test site TR13.
- b. Measure the frequency tolerance by using the spectrum analyzer and following the test conditions described in FCC 15.225(e) to perform the normal and extreme conditions test.
- c. Record the value and compare with the required limit.

### 5.4 Test Configuration

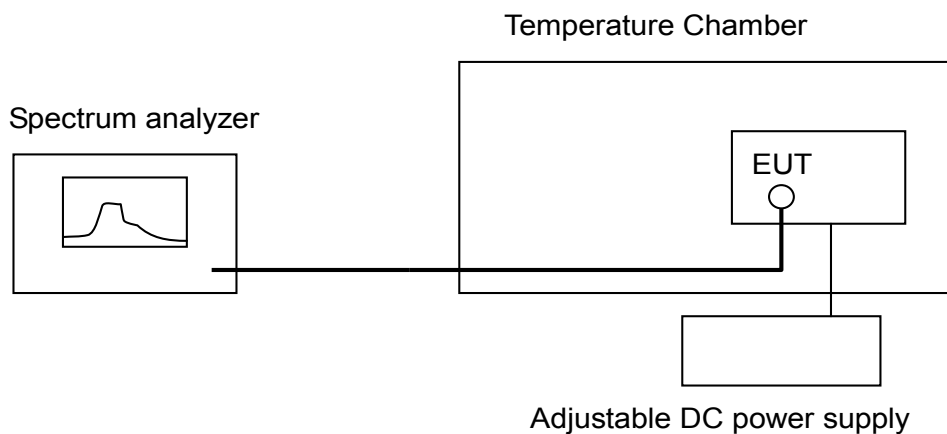

**5.5 Test Results**

**Test Mode : Continuous Transmitting**

**Tester : Gary**

Temperature (°C)	DC Voltage (Volt)	Meas. Frequency (MHz)	Deviation (kHz)	Limit (kHz)	Margin (kHz)
20°C	24.0	13.56064	N/A	N/A	N/A
	20.4	13.56064	0	1.356	1.356
	27.6	13.56064	0	1.356	1.356
-20°C	24.0	13.56071	0.07	1.356	1.286
50°C	24.0	13.56053	0.11	1.356	1.246

Note:

1. Deviation(kHz) = | Meas. Frequency – Meas. Frequency @20°C/24Vdc |
2. Margin (kHz)= Limit – Deviation
3. At the temperature control to highest and Lowest measurement, device turn on after temperature stability and measure at startup and at 2 mins, 5 mins, and 10 mins. Finally, record the worst on the report.
4. The test results of 9Vdc and 43Vdc are pass. The test data are omitted.



20°C, 24Vdc

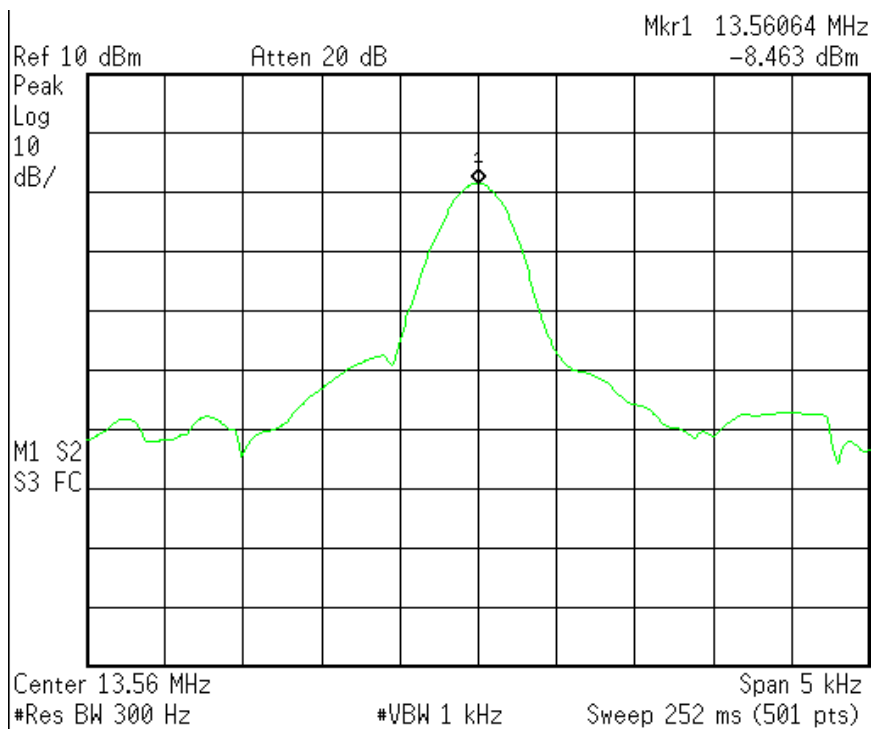

20°C, 20.4Vdc

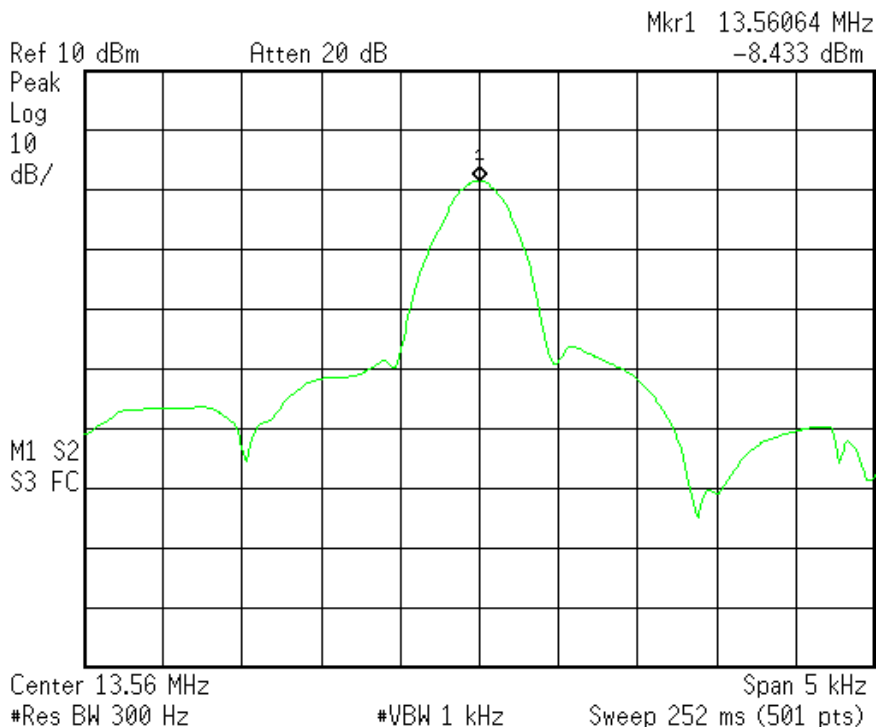

20°C, 27.6Vdc

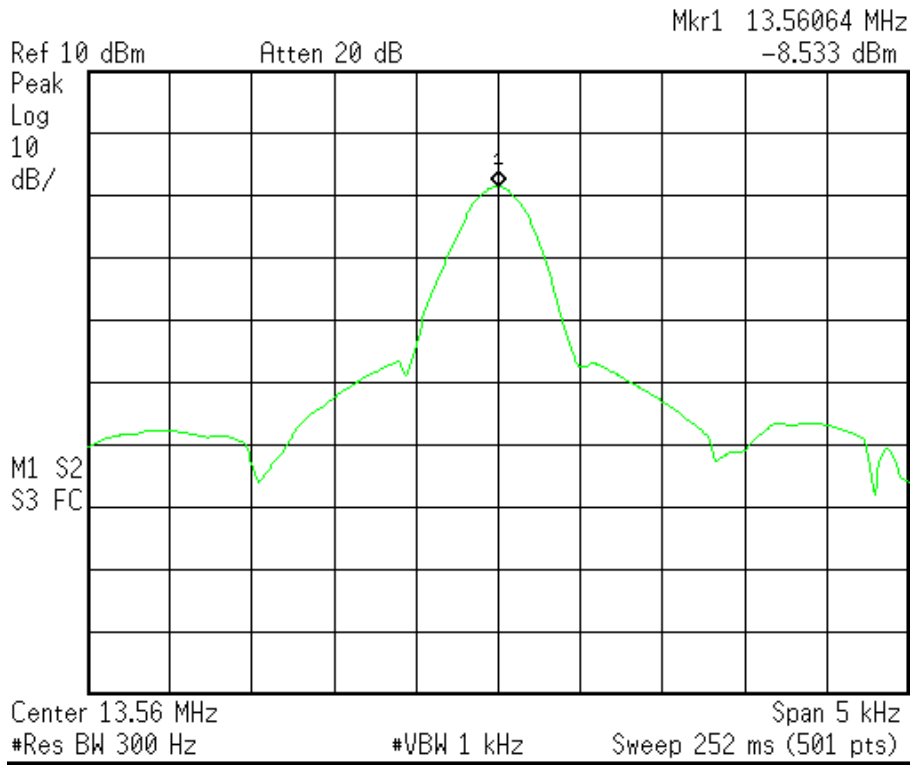

-20°C, 24Vdc

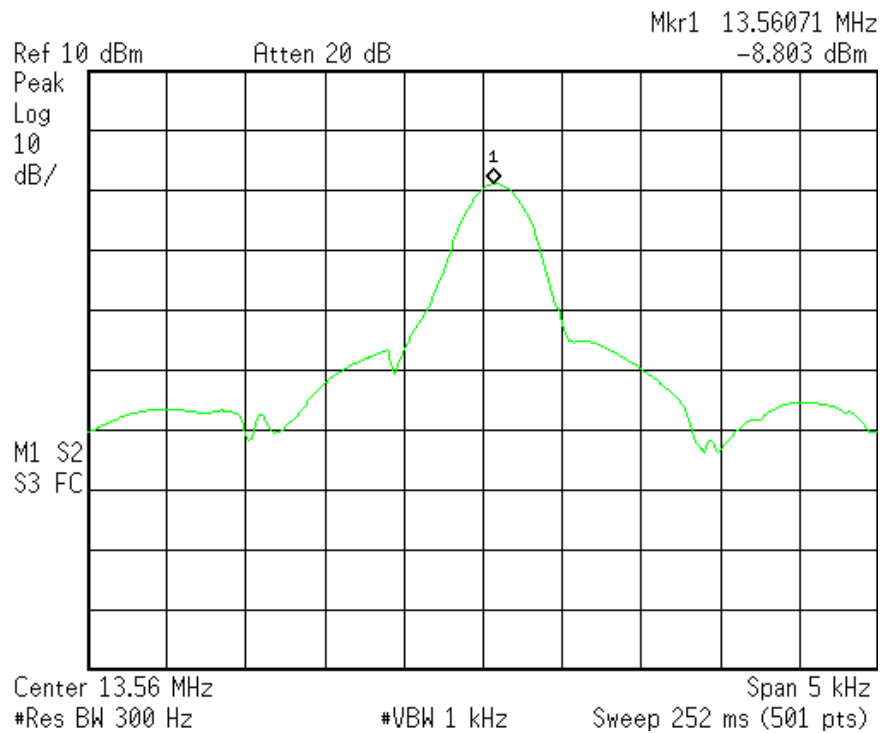

50°C, 24Vdc

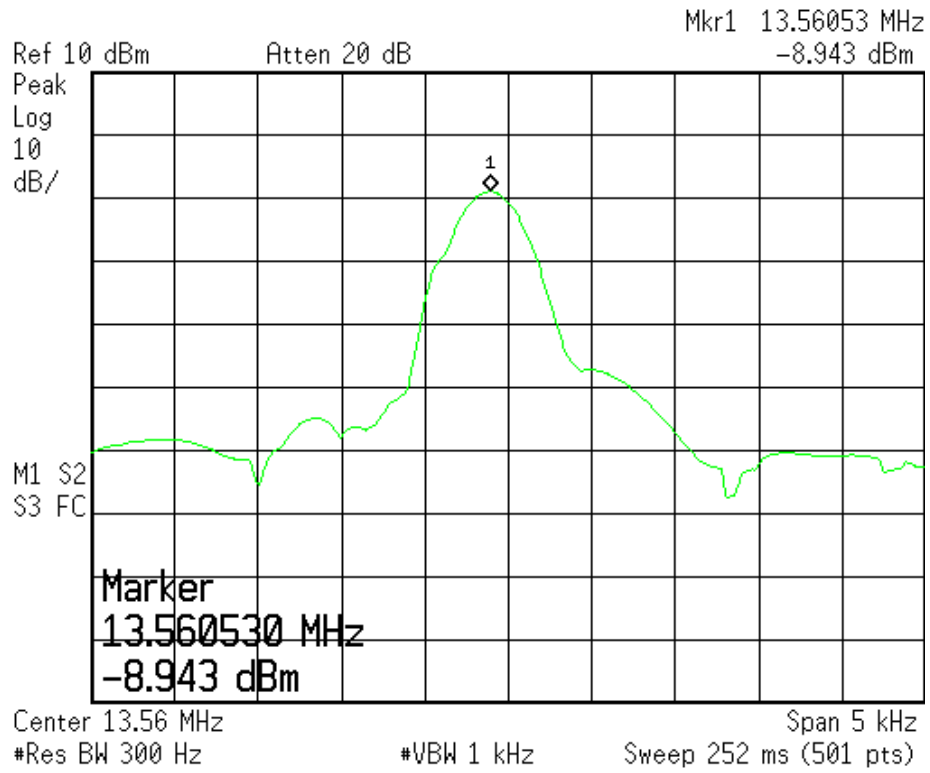

## 6. 20dB Bandwidth

Test Result : PASS

### 6.1 Applied Standard

According to 15.215(c) requires the device must be designed to ensure that the 20 dB bandwidth of the emission, or whatever bandwidth may otherwise be specified in the specific rule section under which the equipment operates.

According to 15.225, Operation should within the band 13.110 – 14.010 MHz.

### 6.2 Test Instruments

Test Site and Equipment	Manufacturer	Model No./ Serial No.	Last Calibration Date	Calibration Due Date
Spectrum Analyzer	Agilent	E4405B/ MY45106706	May 23, 2014	May 23, 2015
Test Site	N.A.	TR13	NCR	NCR

Note:

- 1.The calibrations are traceable to NML/ROC.
- 2.NCR : No Calibration Required.

### Instrument Setting

RBW	VBW	Detector	Trace	Comment
300Hz	1kHz	Peak	Maxhold	

### Climatic Condition

Ambient Temperature : 22°C;      Relative Humidity : 70%

### 6.3 Measurement Procedure

- a. The EUT was set up per the test configuration figured in the next section of this chapter to simulate the typical usage described in the user's manual supported by the manufacturer in test site TR13.
- b. Measure the 20dB bandwidth by using the spectrum analyzer and following the test conditions described in FCC 15.215.
- c. Record the frequency and compare with the required limit.

### 6.4 Test Configuration



6.5 Test Results

Test Mode : Continuous Transmitting

Tester : Bill

Operating Frequency (MHz)	Limit (MHz)
13.56	13.110~14.01

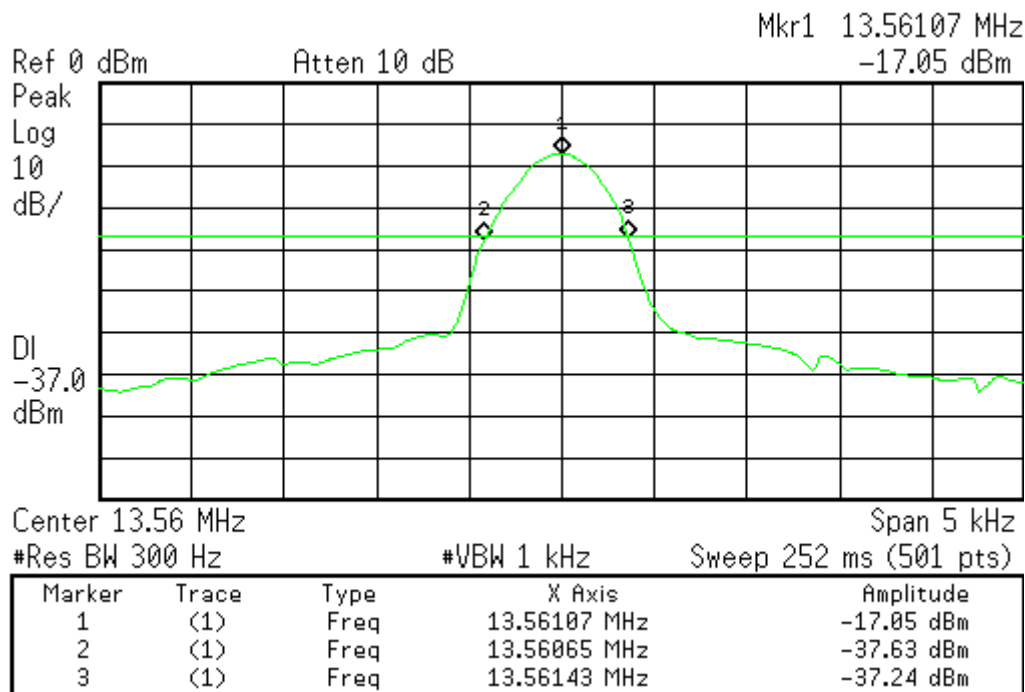

## 7. Antenna Requirement

### 7.1 Applied Standard

An intentional radiator shall be designed to ensure that no antenna other than that furnished by the responsible party shall be used with the device. The use of a permanently attached antenna or of an antenna that uses a unique coupling to the intentional radiator shall be considered sufficient to comply with the provisions of this Section. The manufacturer may design the unit so that a broken antenna can be replaced by the user, but the use of a standard antenna jack or electrical connector is prohibited. This requirement does not apply to carrier current devices or to devices operated under the provisions of Sections 15.211, 15.213, 15.217, 15.219, or 15.221. Further, this requirement does not apply to intentional radiators that must be professionally installed, such as perimeter protection systems and some field disturbance sensors, or to other intentional radiators which, in accordance with Section 15.31(d), must be measured at the installation site. However, the installer shall be responsible for ensuring that the proper antenna is employed so that the limits in this Part are not exceeded.

### 7.2 Antenna Type

The EUT use a permanently attached antenna

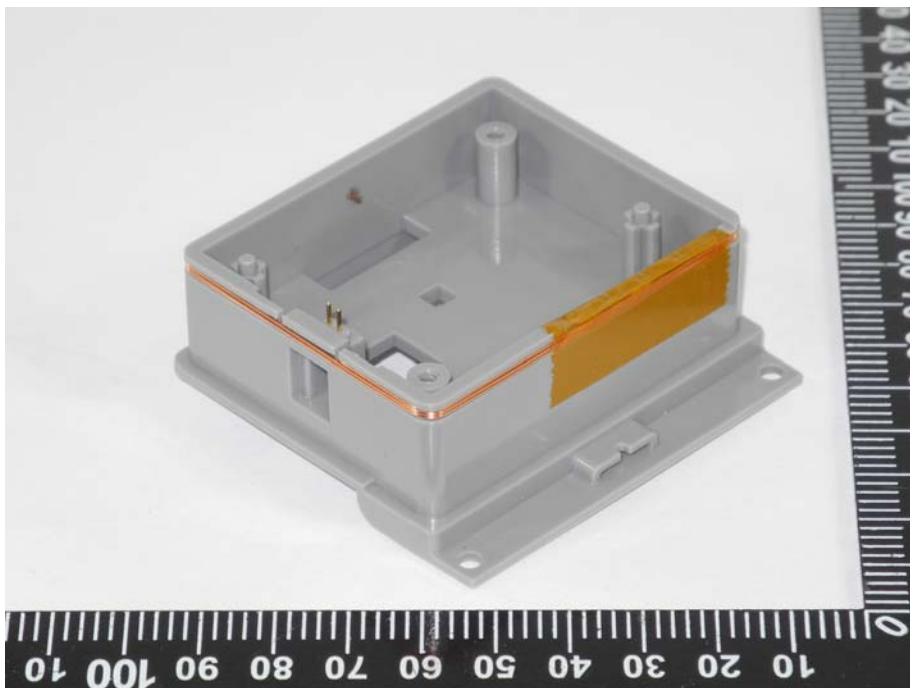

### 7.3 Applicable Result

Comply the requirement.